

Electronics Guide

A FAWCETT

75¢

HOW-TO BOOK

437

By the Publishers of
**ELECTRONICS
ILLUSTRATED**

**Electron Theory • Transistors
Experiments You Can Do
Electron Tubes • Space Electronics
Radio—TV—Hi-Fi • Computers
Automation • Electronic Music
Radio Astronomy • Electronic Doctor**



Code Transmitter Experiment

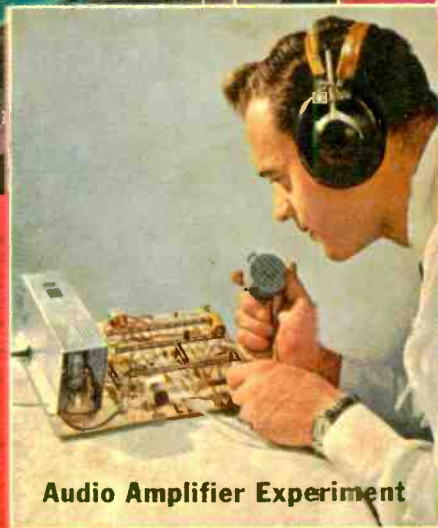

Audio Amplifier Experiment



LET RCA TRAIN YOU IN ELECTRONICS

RCA Institutes, one of the world's leading electronic technical schools, offers a Home Study Course in . . .

ELECTRONICS FOR AUTOMATION

. . . Now you have *four* comprehensive courses for your electronic training . . . from basic electronic theory to the more advanced principles of color TV and Automation.

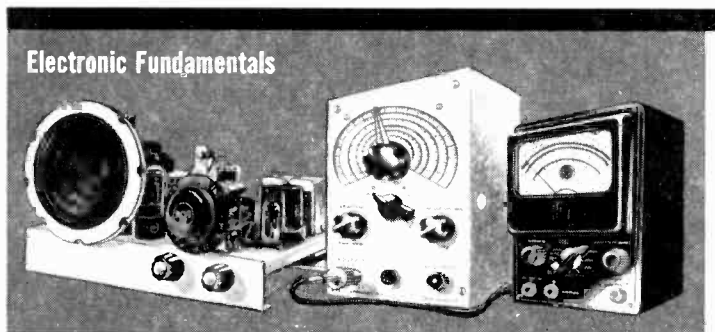

Electronic Fundamentals

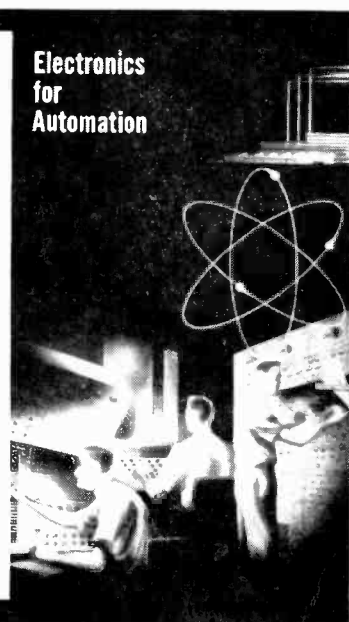

Electronics for Automation

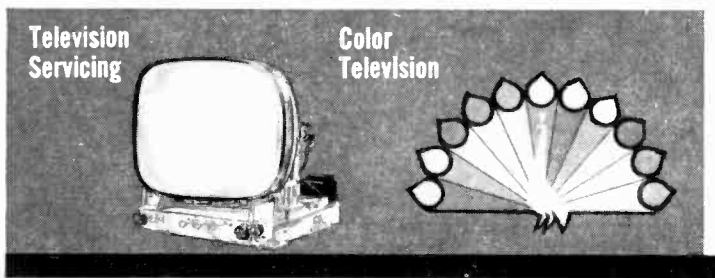

Television Servicing

Color Television

Practical work with the very first lesson. Pay-as-you-learn. You need pay for only one study group at a time.

Send for our 64 page Home Study Catalog

FREE!

RESIDENT SCHOOL offers Technical Institute and Vocational School Courses in Electronics. Day and Evening classes start 4 times each year. Resident School Catalog sent free on request.

ANOTHER WAY RCA SERVES EDUCATION THROUGH ELECTRONICS

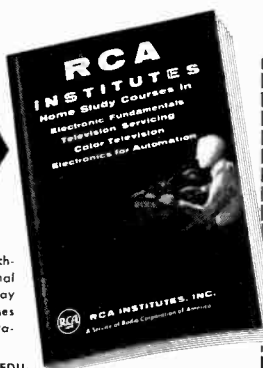

RCA INSTITUTES, Inc. Home Study School, Dept. EG-20

A Service of Radio Corporation of America

350 West Fourth Street, New York 14, N. Y.

Without obligation, send me the FREE catalog of Home Study Courses. No salesman will call.

Name Age

Address

City Zone State

Veterans: Enter discharge date

CANADIANS — Take advantage of these same RCA courses at no additional cost. No postage, no customs, no delay. Send coupon to: RCA Victor Company, Ltd., 5001 Cote de Liesse Rd., Montreal 9, Quebec
To save time, paste coupon on postcard.

HOW WOULD YOU LIKE TO BREAK INTO ENGINEERING STARTING NEXT MONTH?

Your start in Engineering could mean higher pay, more interesting work, a real chance for advancement. Here's how to do it—fast!

A career in Engineering may be closer than you think, whatever your age or education or present job.

You know about the tremendous demand for engineers and technicians. But do you know how easy it is to get the training that will qualify you for this vital work, and how quickly you can advance?

First Step Wins Job Consideration

The moment you enroll for a course in Engineering you're in a position to change your job. I. C. S. Engineering Courses, for example, start you off with Basic Mathematics and Drafting. Most employers are quick to accept men who start technical training.

Your Advancement Is Rapid

Your interest, your determination, your willingness to spend free hours improving your-

self all work in your favor. But your mastery of engineering subjects is what wins you the biggest boosts.

The I. C. S. method makes it possible for you to learn while you earn, to qualify yourself for upgrading step by step—from Draftsman to Detail Designer to Engineering Technician to full-fledged Engineer. It's a plan fitted to your needs, with personalized instruction and guidance, and, if you like, regular progress reports to your employer.

Mail Coupon for Free Books

If you are seriously interested in a fresh start in an opportunity-packed field, then mark and mail the coupon today. We'll send you *three* free books—(1) the 36-page career guide "How to Succeed," (2) Opportunity outlooks in your field of interest, (3) sample lesson (Math) demonstrating I. C. S. method.

For Real Job Security—Get an I. C. S. Diploma! I. C. S., Scranton 15, Penna. Accredited Member, National Home Study Council

INTERNATIONAL CORRESPONDENCE SCHOOLS



BOX 14586B, SCRANTON 15, PENNA.

Without cost or obligation, send me "HOW TO SUCCEED" and the opportunity booklet about the field

(Partial list of 258 courses) BEFORE which I have marked X (plus sample lesson):

ARCHITECTURE and BUILDING CONSTRUCTION

- Air Conditioning
- Architecture
- Arch. Drawing and Designing
- Building Contractor
- Building Estimator
- Carpenter Builder
- Carpentry and Millwork
- Carpenter Foreman
- Heating
- Painting Contractor
- Plumbing
- Reading Arch. Blueprints

ART

- Commercial Art
- Magazine Illus.
- Show Card and Sign Lettering
- Sketching and Painting

AUTOMOTIVE

- Automobile
- Auto Body Rebuilding and Refinishing
- Auto Engine Tuneup
- Auto Technician

AVIATION

- Aero-Engineering Technology
- Aircraft & Engine Mechanic

BUSINESS

- Accounting
- Advertising
- Business Administration
- Business Management
- Cost Accounting
- Creative Salesmanship
- Managing a Small Business
- Professional Secretary
- Public Accounting
- Purchasing Agent
- Salesmanship
- Salesmanship and Management
- Traffic Management

CHEMICAL

- Analytical Chemistry
- Chemical Engineering
- Chem. Lab. Technician
- Elements of Nuclear Energy
- General Chemistry
- Natural Gas Prod. and Trans.
- Petroleum Prod. and Engr.
- Professional Engineer (Chem.)
- Pulp and Paper Making

CIVIL ENGINEERING

- Civil Engineering
- Construction Engineering
- Highway Engineering
- Professional Engineer (Civil)
- Reading Struc. Blueprints
- Sanitary Engineering
- Structural Engineering
- Surveying and Mapping

DRAFTING

- Aircraft Drafting
- Architectural Drafting
- Drafting & Machine Design
- Electrical Drafting
- Mechanical Drafting
- Sheet Metal Drafting
- Structural Drafting

ELECTRICAL

- Electrical Engineering
- Elec. Engr. Technician
- Elec. Light and Power
- Practical Electrician
- Practical Lineman
- Professional Engineer (Elec.)

HIGH SCHOOL

- High School Diploma

- Good English
- High School Mathematics
- High School Science
- Short Story Writing

LEADERSHIP

- Industrial Foremanship
- Industrial Supervision
- Personnel-Labor Relations
- Supervision

MECHANICAL and SHOP

- Diesel Engines
- Gas-Elec. Welding
- Industrial Engineering
- Industrial Instrumentation
- Industrial Metallurgy
- Industrial Safety
- Machine Shop Practice
- Mechanical Engineering
- Professional Engineer (Mech)
- Quality Control
- Reading Shop Blueprints
- Refrigeration and Air Conditioning
- Tool Design
- Tool Making

RADIO, TELEVISION

- General Electronics Tech.

Industrial Electronics

- Industrial Electronics
- Practical Radio-TV Eng'g
- Practical Telephony
- Radio-TV Servicing

RAILROAD

- Car Inspector and Air Brake
- Diesel Electrician
- Diesel Engr. and Fireman
- Diesel Locomotive

STEAM and DIESEL POWER

- Combustion Engineering
- Power Plant Engineer
- Stationary Diesel Engr.
- Stationary Fireman

TEXTILE

- Carding and Spinning
- Cotton Manufacture
- Cotton Warping and Weaving
- Loom Fixing Technician
- Textile Designing
- Textile Finishing & Dyeing
- Throwing
- Warping and Weaving
- Worsted Manufacturing

Name _____ Age _____ Home Address _____
 City _____ Zone _____ State _____ Working Hours _____ A.M. to P.M. _____
 Occupation _____

Canadian residents send coupon to International Correspondence Schools, Canadian, Ltd., Montreal, Canada. . . . Special low monthly tuition rates to members of the U. S. Armed Forces.

ELECTRONICS GUIDE

by Donald C. Hoefler

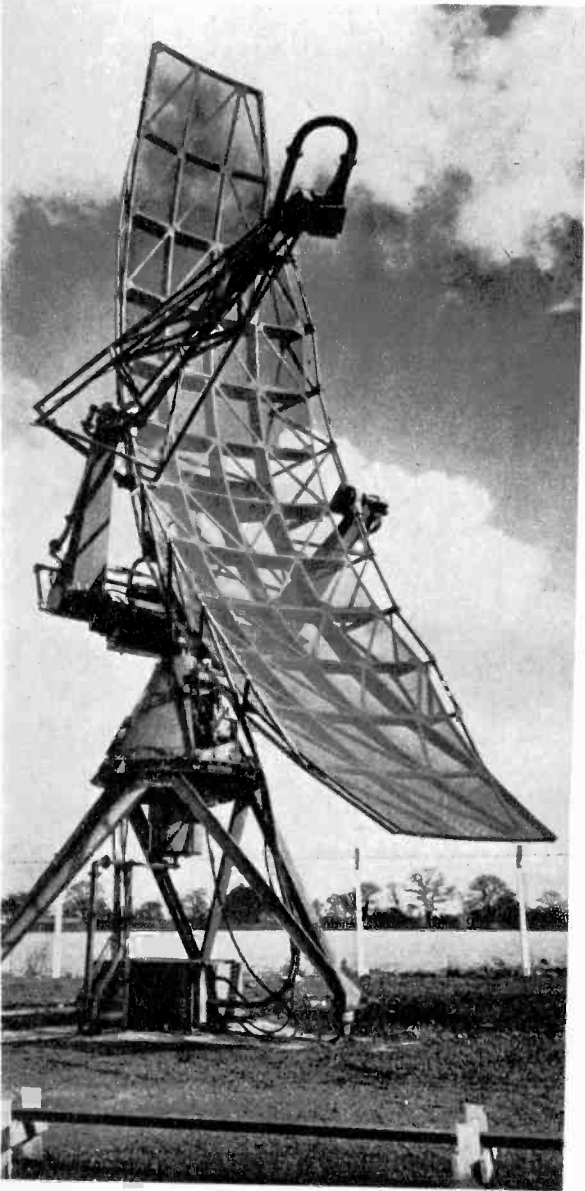

British Information Service

A FAWCETT BOOK • NUMBER 437
LARRY EISINGER • EDITOR-IN-CHIEF
GEORGE TILTON • MANAGING EDITOR
SILVIO LEMBO • ART EDITOR

W. H. Fawcett, Jr. President
Roger Fawcett General Manager
Donald P. Hanson Assistant General Manager
Gordon Fawcett Secretary-Treasurer
Roscoe Fawcett Circulation Director
Ralph Daigh Editorial Director
James B. Boynton Advertising Director
Al Allard Art Director
Ralph Mattison Associate Art Director
George H. Carl Production Director,

FRED HONIG EDITOR

Staff Artists

NICK CARLUCCI ASSOCIATE ART EDITOR
Harold E. Price • Michael Gaynor
Larry Flanagan • Stanley Moskowitz
John S. Selvaggio • Howard Katz
Mike Eastman • Bob Vatter
Frank Bermudez • George Zymarakis

Michael deLucia

Phyllis J. Bendremer Production Editor
Benita Mills Assistant Production Editor

ELECTRONICS GUIDE, Fawcett Book 437, is published by Fawcett Publications, Inc., Greenwich, Connecticut. Editorial and advertising Offices: 67 West 44th Street, New York 36, New York. General Offices: Fawcett Building, Greenwich, Connecticut. Printed in U.S.A. Copyright 1960 by Fawcett Publications, Inc.

Cover photos by Grayson Tewksbury, Fawcett Studios.
Cover art by Frank Schwartz.

In Spare Time at Home—Prepare for a Better Job—or
Your Own Business in One of the Many Branches of

ELECTRONICS



You build and keep this valuable Vacuum Tube **VOLTMETER**

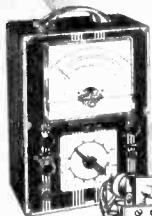

You build and keep this 5-inch **COLOR OSCILLOSCOPE**—almost a "must" for TV servicing.



HOME MOVIES . . .
... make important points crystal clear. Speeds your learning. It's almost like having an instructor at your side!

MILITARY SERVICE
If you are subject to military service, the information we have should prove very helpful. Mail coupon today.

COLOR TV
DeVry Tech's program also includes training in Color Television

RADIO - TELEVISION - RADAR

If you are seeking a better job or a business of your own, the appealing field of Television-Radio-Electronics offers **REAL PROMISE!**

In this fast-growing field, trained Electronic technicians find many good-paying, interesting jobs in manufacturing, installing, operating, servicing. Equally important is the fact that these are **GOOD JOBS**—offering the kind of a future that an untrained man often dreams about.

No previous technical experience or advanced education needed. Prepare for this profitable field in your spare time at home, or in our modern Chicago or Toronto Laboratories. Nothing else like it! Send for **FREE** details.



Build and keep this **BIG 21 INCH** DeVry Engineered TV set—easily converted to U.H.F. (DeVry offers another home training, but without the TV set.)

EARN WHILE YOU LEARN

After you get part of DeVry Tech's training with equipment at home, you may then in your spare time, begin to earn real money servicing Radio and Television sets.

Your GUIDE

to Profitable Job Opportunities

- TV-Radio Broadcast Technician
- Color Television Specialist
- Radar Operator • Laboratory Technician
- Airline Radio Man • Computer Specialist
- Quality Control Manager
- Your Own Sales & Service Shop
- ... PLUS MANY OTHERS

YOU GET THE SAME EMPLOYMENT SERVICE that has helped thousands of our graduates toward fine careers in Electronics.



Build over **300** practical projects from many shipments of Radio-Electronic parts. You build and operate TV-Radio circuits . . . wireless microphone . . . and many other major projects—all designed to provide outstanding practical experience at home.

Send for **FREE BOOKLET TODAY!**

Accredited Member of National Home Study Council
"One of North America's Foremost Electronics Training Centers"



DeVRY TECHNICAL INSTITUTE
Formerly DeForest's Training, Inc.
CHICAGO 41 ILLINOIS

ACT NOW! Get information-pocked publication FREE! Mail coupon today.

DeVRY TECHNICAL INSTITUTE
4141 Belmont Ave., Chicago 41, Ill., Dept. EG-Q
Please give me your FREE booklet, "Electronics and YOU," and tell me how I may prepare to enter one or more branches of Electronics.

Name _____ Age _____
Street _____ PLEASE PRINT Apt. _____
City _____ Zone _____ State _____
2044 Canadian residents address DeVry Tech of Canada, Ltd.
626 Roselawn Ave., Toronto 12, Ontario

CONTENTS

Chapter 1

THE WORLD OF ELECTRONICS 6

Chapter 2

THE TINY ELECTRON 22

Chapter 3

THERE WAS LIGHT 36

Chapter 4

TUBELESS TUBES 50

Chapter 5

ELECTRONS AT PLAY 62

Chapter 6

ELECTRONIC BRAINS 72

Chapter 7

ELECTRONIC WORKMEN 80

Chapter 8

LISTENING TO THE STARS 90

Chapter 9

ELECTRONIC MUSIC 98

Chapter 10

MEDICAL ELECTRONICS 110

Chapter 11

SEEING EYES 120

Chapter 12

SPACE AGE ELECTRONICS 132

Table of Experiments

1 BUILDING A CODE TRANSMITTER 16	10 CONVERTING A TV SET FOR HI-FI 68
2 BUILDING AN ELECTRONIC SWITCH 18	11 BUILDING A SIMPLE COMPUTER 76
3 GENERATING AN ELECTRIC CURRENT 28	12 BUILDING AN ELECTRONIC TIMER 82
4 BUILDING A POWER SUPPLY 32	13 BUILDING A RAIN ALARM 86
5 BUILDING A RADIO TRANSMITTER 40	14 TUNING IN ON THE STARS 94
6 BUILDING A PHOTOCCELL RELAY 44	15 BUILDING A TUNEABLE AUDIO OSCILLATOR ... 104
7 BUILDING A CRYSTAL SET 54	16 BUILDING A SIGNAL TRACER 116
8 BUILDING A TRANSISTOR RADIO 58	17 BUILDING A DIRECTION FINDER 124
9 BUILDING AN AUDIO AMPLIFIER 64	18 BUILDING A WIRELESS RELAY 134

**WE'RE MAKING IT EASIER THAN EVER TO BECOME A WELL PAID
RADIO-TELEVISION SERVICE TECHNICIAN**

**NOW - Just \$6 Starts You Training in
RADIO-TELEVISION
the SPRAYBERRY "Learn-by-Doing" Way . . .**

**25 BIG, COMPLETE KITS
of PARTS & EQUIPMENT**

To help you learn /ast the practical side of Radio-Television, we send you expertly engineered training kits to test and assemble for interesting, valuable shop bench practice!



• The new Sprayberry Training Television Receiver, built and tested in 5 sections.

• Now offered . . . this fine modern oscilloscope.

• You build this powerful two-hand superheterodyne radio receiver.

**Big New
CATALOG
AND
Sample Lesson
FREE!**

You build the new Sprayberry tester - a complete 18-range Volt-Ohm-Milli-ammeter test meter.

*** This great industry is begging for trained men . . . to step into good paying jobs or a profitable business of their own! Our new plan opens the doors of Radio-Television wide to every ambitious man who is ready to act at once!

Men by the thousands . . . trained Radio-Television Service Technicians . . . are needed at once! Perhaps you've thought about entering this interesting, top paying field, but lack of ready money held you back. Now - just \$6 enrolls you for America's finest, most up to date home study training in Radio-Television! Unbelievable? No, the explanation is simple! We believe Radio-Television *must* have the additional men it needs as quickly as possible. We are willing to do our part by making Sprayberry Training available for less money down and on easier terms than ever before. This is your big opportunity to get the training you need . . . to step into a fine job or your own Radio-Television Service Business.

Complete Facts Free - Act Now; Offer Limited

Only a limited number of students may be accepted on this liberal and unusual basis. We urge you to act at once . . . mail the coupon below and get complete details plus our big new catalog and an actual sample lesson - all free. No obligation . . . no salesman will bother you.

HOME STUDY TRAINING IN SPARE TIME

Under world-famous 27-year old Sprayberry Plan, you learn entirely at home in spare time. You keep on with your present job and income. You train as fast or as slowly as you wish. You get valuable kits of parts and equipment for priceless shop-bench practice. And everything you receive, lessons and equipment alike, is all yours to keep.

LET US PROVE HOW EASILY YOU CAN LEARN!

Radio-Television needs YOU! And Sprayberry is ready to train you on better, easier terms, than any ambitious man can afford. *Just \$6 starts you!* Mail coupon today . . . let the facts speak for themselves. You have everything to gain. Let us prove the kind of opportunity in store for you!

SPRAYBERRY Academy of Radio-Television
1512 Jarvis Avenue, Dept. 123-H, Chicago 26, Illinois

Mail This Coupon Now - No Salesman Will Call

Sprayberry Academy of Radio-Television
Dept. 123-H, 1512 W. Jarvis Ave., Chicago 26, Ill.
Please rush all information on your ALL-NEW Radio-Television Training Plan. I understand this does not obligate me and that no salesman will call upon me. Include New Catalog and Sample Lesson FREE.

NAME Age

ADDRESS

CITY ZONE STATE



Chapter 1

THE WORLD OF ELECTRONICS

An introductory survey

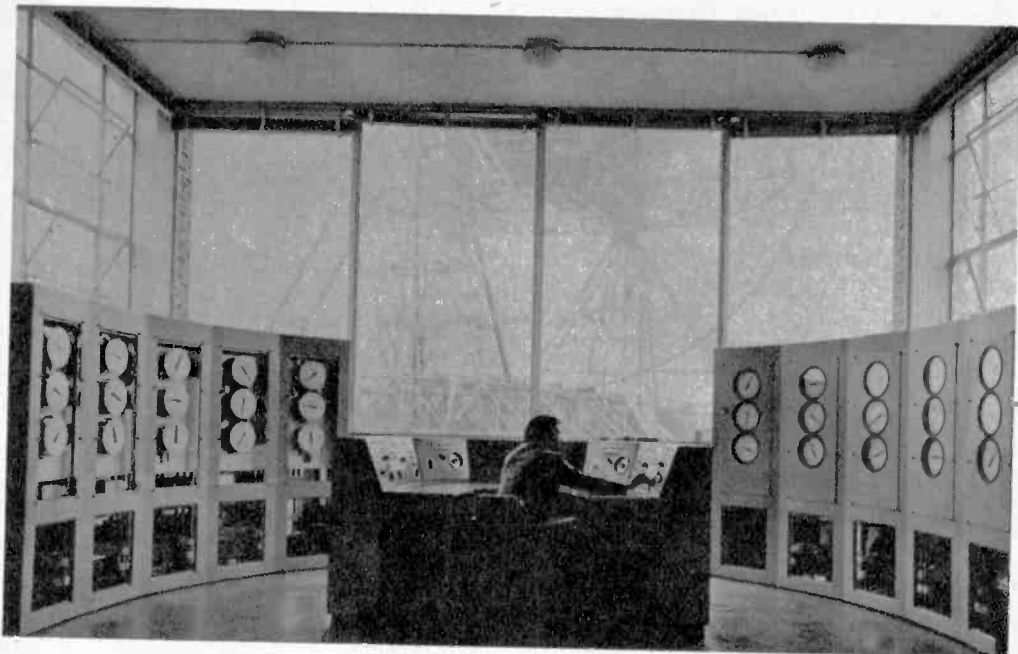

British Information Services

Above is the control desk of the radio telescope at Jodrell Bank. High-speed computers solve the equations which enable the track of a star or planet to be plotted and followed automatically. Designed to receive radio waves from space, the telescope can be used as a huge celestial radar transmitter.

MILLIONS of miracles are performed by the science of electronics every day. This fact somewhat bedazzles our vision, and we fail to realize that, broadly speaking, electronics is really nothing more than *electricity*. That's all. Just plain old electricity, which most of us have known all our lives.

Purists may cavil at that statement, and earnest young students may pooh-pooh it, but the fact remains that it is increasingly difficult to draw any clear distinction between electricity and electronics. That both of them are concerned with the flow of electrons is now agreed by all but the most antediluvian reactionaries. But time was when the two sciences did seem to have little or nothing in common.

Radio Tubes

Electronics was once concerned solely

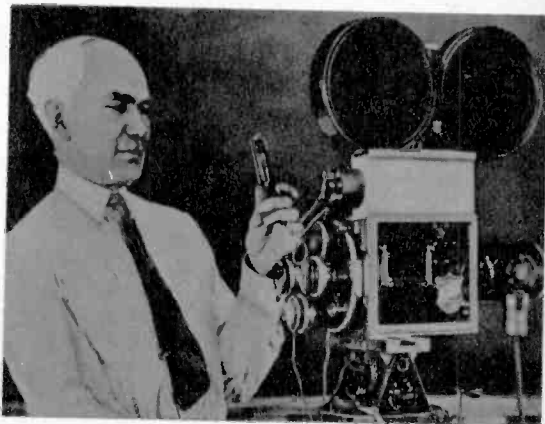

Bell Telephone Laboratories

Lee DeForest is shown holding his audion tube which became the magic key for unlocking the door of a great and new scientific-electronic age.

These men are getting practical training in **NEW Shop-Labs of**

ELECTRICITY

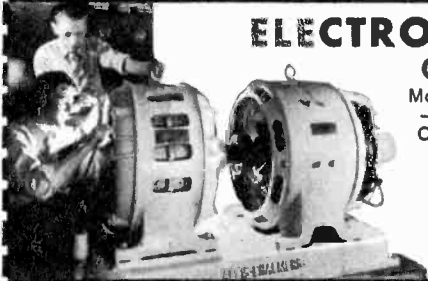

ELECTRONICS

ON REAL

Motors—Generators—
—Switchboards—
Controls—Modern
Appliances—
Automatic
Electronic
Control Units

TELEVISION



RADIO ELECTRONICS

ON REAL

TV Receivers—
Black and White
and Color
AM-FM and
Auto Radios
Transistors
Printed Circuits
Test Equipment

COYNE

in Chicago—prepare for today's **TOP OPPORTUNITY FIELD**. Train on real full-size equipment at COYNE where thousands of successful men have trained for over 60 years—largest, oldest, best equipped school of its kind. Professional and experienced instructors show you how, then do practical jobs yourself. No previous experience or advanced education needed. Employment Service to Graduates.

START NOW—PAY LATER—Liberal Finance and Payment Plans. Part-time employment help for students. **GET FREE BOOK**—"Guide to Careers" which describes all training offered in **ELECTRICITY** and **TELEVISION-RADIO ELECTRONICS**—no obligation; **NO SALESMAN WILL CALL**.

Coyne Electrical School, 1501 W. Congress Parkway
Chartered Not For Profit • Chicago 7, Dept. 20-9C

MAIL COUPON OR WRITE TO ADDRESS BELOW

COYNE ELECTRICAL SCHOOL
Dept. 20-9C—New Coyne Building
1501 W. Congress Pkwy., Chicago 7, Ill.

Send **BIG FREE** book and details of all the training you offer. However, I am especially interested in:

Electricity Television Both Fields

Name _____

Address _____

City _____ State _____



COYNE offers
LOW COST

TELEVISION

RADIO - COLOR TV

Training in
Spare Time AT HOME



The future is **YOURS** in **TELEVISION!**
A fabulous field—good pay—fascinating work—a prosperous future in a good job, or independence in your own business!

Coyne brings you **MODERN-QUALITY** Television Home Training; training designed to meet Coyne standards at truly lowest cost—you pay for training only—**no costly "put together kits."** Not an old Radio Course with Television "tacked on." Here is **MODERN TELEVISION TRAINING** including **Radio, UHF and Color TV**. No Radio background or previous experience needed. Personal guidance by Coyne Staff. **Practical Job Guides** to show you how to do actual servicing jobs—**make money early in course**. Free Life-time Employment Service to Graduates.

COYNE ELECTRICAL SCHOOL

CHARTERED AS AN EDUCATIONAL INSTITUTION
NOT FOR PROFIT

1501 W. Congress Parkway • Chicago 7, Dept. 20-H9,



B. W. COOKE, Jr., President
Coyne—the Institution behind this training... the largest, oldest, best equipped residential school of its kind. Founded 1889.

Send Coupon or write to address below for Free Book

and full details, including easy Payment Plan. **No obligation, no salesman will call.**



COYNE Television Home Training Division

Dept. 20-H9, New Coyne Building
1501 W. Congress Pkwy., Chicago 7, Ill.

Send Free Book and details on how I can get Coyne Quality Television Home Training at low cost and easy terms.

Name _____

Address _____

City _____ State _____

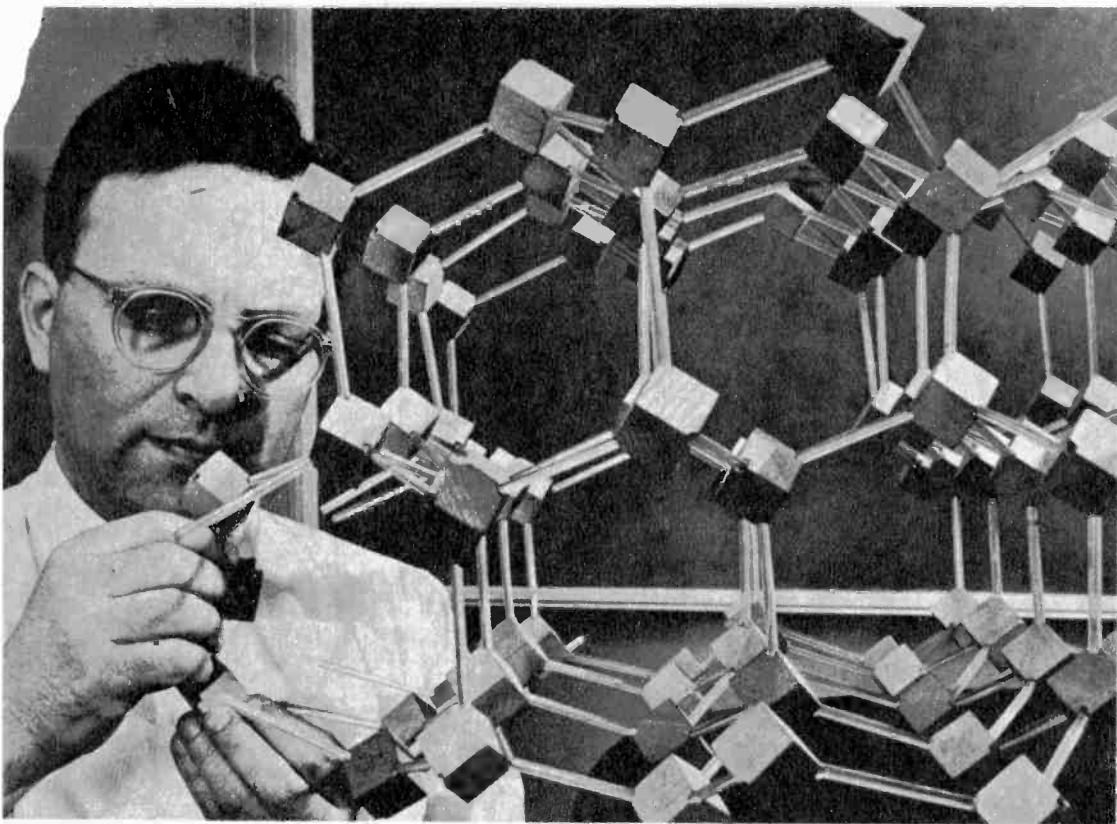

Westinghouse

Using a model of a new-type germanium crystal, a physicist demonstrates how germanium atoms attach themselves to form crystals in thin strips.

Ribbon-like germanium crystal rises from molten pool in this crystal growing furnace. Strip is same form as used in making of transistors.

Westinghouse

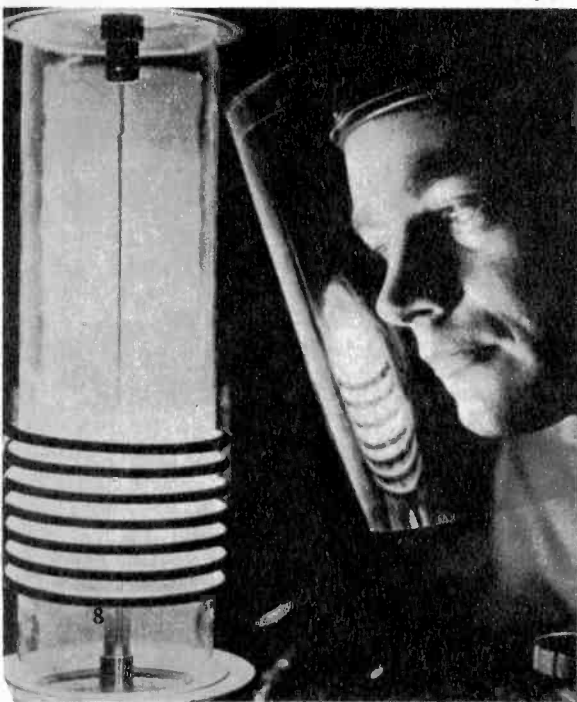

with the vacuum tube, and the vacuum tube was used only for radio broadcasting and communications. But in time the techniques of radio were applied to a variety of industrial applications, in control, measurement and computation. Thus the vacuum tube found itself doing all sorts of jobs never envisioned by its inventors.

During those growth years, the science of electronics was synonymous with the science of the vacuum tube. But a change in thinking was in order when some new types of tubes had gasses introduced inside their glass envelopes, and these tubes began doing jobs which the vacuum tube couldn't do as well, if at all. So the broader term *electron tube* came into use, and the study of electronics was widened to include the behavior of electrons in gasses.

Later, we discovered that a variety of crystalline materials had the properties of *semiconductors*, which also can do many jobs as well or better than vacuum tubes. So now we must concern ourselves not only with the movement of electrons in a vacuum, but also in gasses and solids as well. Which brings us just about full circle from where we began. For the flow of electrons through a wire conductor is also electron flow through a solid. Electron motion differs in the various mediums, but whether it be a vacuum, a gas, a conductor or a semiconductor, it's still electrons in

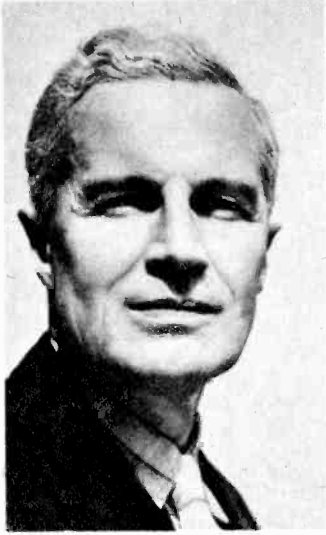

I'd like to give this to my fellow men... while I am still able to help!

I was young once, as you may be—today I am older. Not too old to enjoy the fruits of my work, but older in the sense of being wiser. And once I was poor, desperately poor. Today almost any man can stretch his income to make ends meet. Today, there are few who hunger for bread and shelter. But in my youth I knew the pinch of poverty; the emptiness of hunger; the cold stare of the creditor who would not take excuses for money. Today, all that is past. And behind my city house, my

summer home, my Cadillacs, my Winter-long vacations and my sense of independence—behind all the wealth of cash and deep inner satisfaction that I enjoy—there is one simple secret. It is this secret that I would like to impart to you. If you are satisfied with a humdrum life of service to another master, turn this page now—read no more. If you are interested in a fuller life, free from bosses, free from worries, free from fears, read further. This message may be meant for you.

By Victor B. Mason

I am printing my message in a magazine. It may come to the attention of thousands of eyes. But of all those thousands, only a few will have the vision to understand. Many may read; but of a thousand only you may have the intuition, the sensitivity, to understand that what I am writing may be intended for you—may be the tide that shapes your destiny, which, taken at the crest, carries you to levels of independence beyond the dreams of avarice.

Don't misunderstand me. There is no mysticism in this. I am not speaking of occult things; of innumerable laws of nature that will sweep you to success without effort on your part. That sort of talk is *rubbish!* And anyone who tries to tell you that you can *think* your way to riches without effort is a false friend. I am too much of a realist for that. And I hope you are.

I hope you are the kind of man—if you have read this far—who knows that anything worthwhile has to be *earned!* I hope you have learned that there is no reward without effort. If you have learned this, then you may be ready to take the next step in the development of your karma—you may be ready to learn and use the secret I have to impart.

I Have All The Money I Need

In my own life I have gone beyond the need of money. I have it. I have gone beyond the need of gain. I have two businesses that pay me an income well above any amount I have need for. And, in addition, I have the satisfaction—the deep satisfaction—of knowing that I have put more than three hundred other men in businesses of their own. Since I have no need for money, the greatest satisfaction I get from life, is sharing my secret of personal independence with others—seeing them achieve the same heights of happiness that have come into my own life.

Please don't misunderstand this statement. I am not a philanthropist. I believe that charity is something that no proud man will accept. I have never seen a man who was worth his salt who would accept

something for nothing. I have never met a highly successful man whom the world respected who did not sacrifice something to gain his position. And, unless you are willing to make at least half the effort, I'm not interested in giving you a "leg up" to the achievement of your goal. Frankly, I'm going to charge you something for the secret I give you. Not a lot—but enough to make me believe that you are a little above the fellows who merely "wish" for success and are not willing to sacrifice something to get it.

A Fascinating and Peculiar Business

I have a business that is peculiar—one of my businesses. The unusual thing about it is that it is needed in every little community throughout this country. But it is a business that will never be invaded by the "big fellows". It has to be handled on a local basis. No giant octopus can ever gobble up the whole thing. No big combine is ever going to destroy it. It is essentially a "one man" business that can be operated without outside help. It is a business that is good summer and winter. It is a business that is growing each year. And, it is a business that can be started on an investment so small that it is within the reach of anyone who has a television set. But it has nothing to do with television.

This business has another peculiarity. It can be started at home in spare time. No risk to present job. No risk to present income. And no need to let anyone else know you are "on your own". It can be run as a spare time business for extra money. Or, as it grows to the point where it is paying more than your present salary, it can be expanded into a full time business—overnight. It can give you a sense of personal independence that will free you forever from the fear of lay-off, loss of job, depressions, or economic reverses.

Are You Mechanically Inclined?

While the operation of this business is partly automatic, it won't run itself. If you are to use it as a stepping stone to independence, you must be able to work with your hands, use such tools as hammer and screw driver, and enjoy getting into a pair of blue jeans and rolling up your sleeves. But two hours a day of manual work will keep your "factory" running 24 hours turn-

ing out a product that has a steady and ready sale in every community. A half dollar spent for raw materials can bring you six dollars in cash—six times a day.

In this message I'm not going to try to tell you the entire story. There is not enough space on this page. And, I am not going to ask you to spend a penny now to learn the secret. I'll send you all the information, free. If you are interested in becoming independent, in becoming your own boss, in knowing the sweet fruits of success as I know them, send me your name. That's all. Just your name. I won't ask you for a penny. I'll send you all the information about one of the most fascinating businesses you can imagine. With these facts, you will make your own investigation. You will check up on conditions in your neighborhood. You will weigh and analyze the whole proposition. Then, and then only, if you decide to take the next step, I'll allow you to invest \$15.00. And even then, if you decide that your fifteen dollars has been badly invested I'll return it to you. Don't hesitate to send your name. I have no salesmen. I will merely write you a long letter and send you complete facts about the business I have found to be so successful. After that, you make the decisions.

Does Happiness Hang on Your Decision?

Don't put this off. It may be a coincidence that you are reading these words right now. Or, it may be a matter that is more deeply connected with your destiny than either of us can say. There is only one thing certain: If you have read this far you are interested in the kind of independence I enjoy. And if that is true, then you must take the next step. No coupon on this advertisement. If you don't think enough of your future happiness and prosperity to write your name on a postcard and mail it to me, forget the whole thing. But if you think there is a destiny that shapes men's lives, send your name now. What I send you may convince you of the truth of this proverb. And what I send you will not cost a penny, now or at any other time.

VICTOR B. MASON
1512 Jarvis Ave., Suite M-176-B
CHICAGO 26, ILLINOIS

Right. Transistors, photovoltaic cells, rectifiers and diodes employ a new-compound semiconductor material capable of very high temperatures.

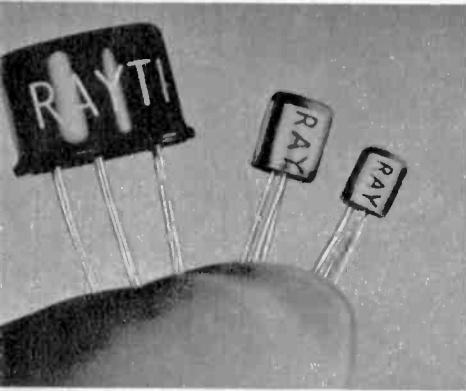

Raytheon Co.

Above. Transistors shown range from a type used in giant computers, left, to the smallest right, especially designed for hearing aid applications.

Right. Eight tubes and four resistors are sealed in one-inch capsule. Model shown is a multiple element logic module with two triple-input gates.

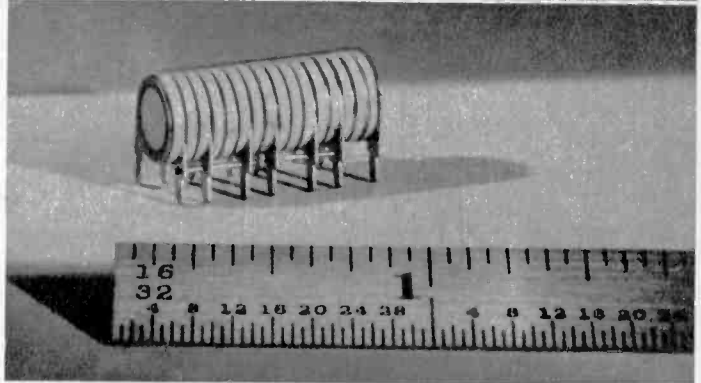
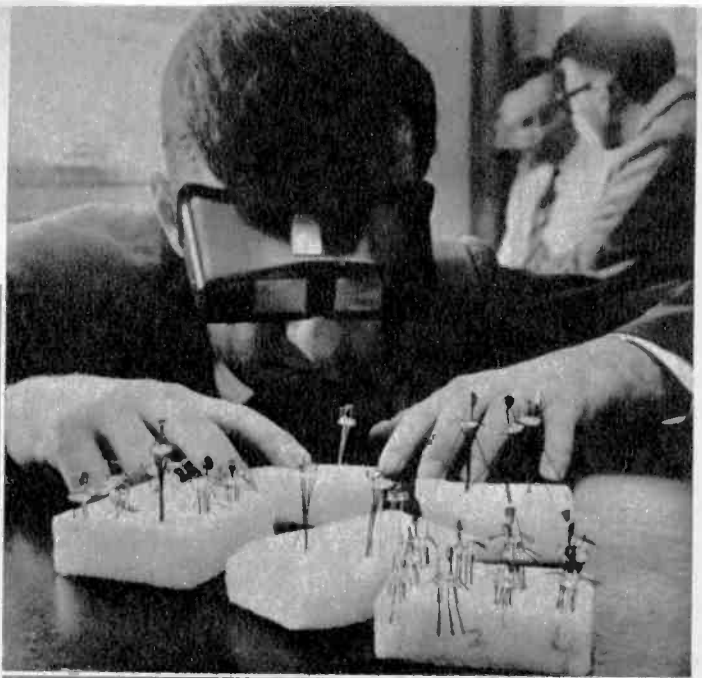

General Electric Co.

motion, and as far as we are concerned, it's all electronics.

Electronic Circuits

Every electronic device comprises one or more *circuits*, the heart of which is usually a tube or transistor. The complete circuit also has other electrical components, such as coils, condensers, resistors and connecting wire. Thus the electronic circuit can be roughly compared to a mechanical system in which the tube represents a motor and the other components act as the belts, chains, pulleys, gears and shafts.

Not long ago engineers used to go through a mental "shifting of gears," thinking of an electronic circuit in terms of an equivalent mechanical system, in order to understand its operation. For example, it was common to compare the flow of current in a wire with the movement of water through a pipe, to relate certain inductive effects to inertia and momentum, and ca-

pacitive effects to compression and elasticity.

This practice led to some bad guesses, however, and only a few unreconstructed old-timers still hold to it. Electronic advances have been so rapid, furthermore, that now it's more common to find the *mechanical* engineer using electronic concepts in solving his design problems.

The ties between electronics and mechanics are still strong, however. One of the fundamental ideas in practical electronics is the varying voltage which stands for some changing physical value. Sound becomes an electrical voltage, for example, through the medium of the microphone. Light is converted into electricity by a photocell or video camera. Even changing temperatures can result in varying voltages.

Electronic Signals

Electrical voltages of this type are called

NOW!
at a price
you can afford!

MAKE MORE MONEY in TELEVISION RADIO-ELECTRONICS

**BETTER...MORE COMPLETE...LOWER COST...
WITH NATIONAL SCHOOLS SHOP-METHOD
HOME TRAINING!**

BETTER... Training that is proved and tested in Resident School shops and laboratories, by a School that is the **OLDEST** and **LARGEST** of its kind in the world.

MORE COMPLETE... You learn **ALL PHASES** of Television-Radio-Electronics.

LOWER COST... Other schools make several courses out of the material in our **ONE MASTER COURSE . . .** and you pay more for less training than you get in our course at **ONE LOW TUITION!**



These two **FREE** books will show you how!

You get all information by mail . . . You make your own decision . . . at home! **NO SALESMAN WILL CALL**

TOP PAY... UNLIMITED OPPORTUNITIES LIFETIME SECURITY CAN BE YOURS!

You are needed in the Television, Radio, and Electronics industry! Trained technicians are in growing demand at excellent pay—in **ALL PHASES**, including Servicing, Manufacturing, Broadcasting and Communications, Automation, Radar, Government Missile Projects.

NATIONAL SCHOOLS SHOP-METHOD HOME TRAINING, with newly added lessons and equipment, trains you in your spare time at home, for these unlimited opportunities, including many technical jobs leading to supervisory positions.

YOU LEARN BY BUILDING EQUIPMENT WITH KITS AND PARTS WE SEND YOU. Your National Schools course includes thorough *Practical* training—**YOU LEARN BY DOING!** We send you complete standard equipment of professional quality for building various experimental and test units. You advance step by step, perform more than 100 experiments, and you build a complete TV set from the ground up, that is yours to keep! A big, new TV picture tube is included at no extra charge.

EARN AS YOU LEARN. We'll show you how to earn extra money right from the start. Many of our students pay for their course—and more—while studying. So can you!

LESSONS AND INSTRUCTION MATERIAL ARE UP-TO-DATE, PRACTICAL, INTERESTING. Every National Schools Shop-Method lesson is made easy to understand by numerous illustrations and diagrams. All instruction material has been developed and tested in our own Resident School Shops, Laboratories and Studios.

SEND FOR INFORMATION TODAY . . . it can mean the difference between **SUCCESS** and failure for you! Send for your **FREE BOOK** "Your Future in Television-Radio-Electronics" and **FREE Sample Lesson.** Do it **TODAY**, while you are thinking about your future. It doesn't cost you anything to investigate!

GET THE BENEFITS OF OUR OVER 50 YEARS EXPERIENCE



YOU GET . . .

- 19 Big Kits—**YOURS TO KEEP!**
- Friendly Instruction and Guidance
- Job Placement Service
- Unlimited Consultation
- Diploma—Recognized by Industry
- **EVERYTHING YOU NEED FOR SUCCESS!**

SHOP-METHOD HOME TRAINING COVERS ALL PHASES OF INDUSTRY

1. Television, including Color TV
2. Radio AM & FM
3. Electronics for Guided Missiles
4. Sound Recording and Hi-Fidelity
5. FCC License
6. Automation and Computers
7. Radar & Micro-Waves
8. Broadcasting and Communications

RESIDENT TRAINING AT LOS ANGELES

If you wish to take your training in our Resident School at Los Angeles, the world's TV capital, start **NOW** in our big, modern Shops, Labs and Radio-TV Studios. Here you work with latest Electronic equipment—professionally installed—finest, most complete facilities offered by any school. Expert, friendly instructors. Personal attention. Graduate Employment Service. Help in finding home near school—and part time job while you learn. Check box in coupon for full information.



NATIONAL SCHOOLS

Los Angeles 37, Calif.

NATIONAL TECHNICAL SCHOOLS

WORLD-WIDE TRAINING SINCE 1905

MAIL NOW TO
NATIONAL SCHOOLS, Dept R6H-20
 4000 S. FIGUEROA ST. LOS ANGELES 37, CALIF.
 Rush free TV-Radio "Opportunity" Book and sample lesson. No salesman will call.

NAME _____ AGF. _____
 ADDRESS _____
 CITY _____ ZONE _____ STATE _____

Check if interested **ONLY** in Resident School training at Los Angeles.
 VETERANS: Give date of Discharge _____



Raytheon Co.

Powerful radio relay has 20-ft. mast and 2½-ft. reflector, is used by the U. S. Marine Corps. The unit's message band is designed extremely narrow.

signals, and the device that generates them after stimulation by an outside source is known as a *transducer*.

In addition to the microphone and TV camera, other transducers include the phono pickup and tape reproducer.

It will be noted that all of these appear at the *input* of the electronic circuit. That is, they convert some other physical quantity into a signal which is then fed into the electronic circuit. Another family of devices which is equally important is the *output* transducers. These have the job of converting the electronic signals back into physical form, either the same as or different from the original. Examples in this group are TV picture tubes, loudspeakers, meters and various types of recorders.

All of the signal movement we have discussed so far is of the *closed-circuit* variety. The signal, that is, has remained at all times confined within the circuits of the electronic devices. But this doesn't have to be so, for there is a way in which these signals can escape the bounds of electronic circuitry and shoot out in every direction in space.

For this to happen, the electronic signals must be converted again, this time into electromagnetic waves. This conversion, as well as the reconversion from electromagnetic waves back into electronic signals, is the basis of radio, television and radar. The transducers in this case are transmitters, antennas and receivers. But



Bell Telephone Laboratories

Photo taken in mid-thirties shows experimental electrical wave guides. Similar systems may one day carry 200,000 telephone voices by means of radio waves of less than one-quarter inch.

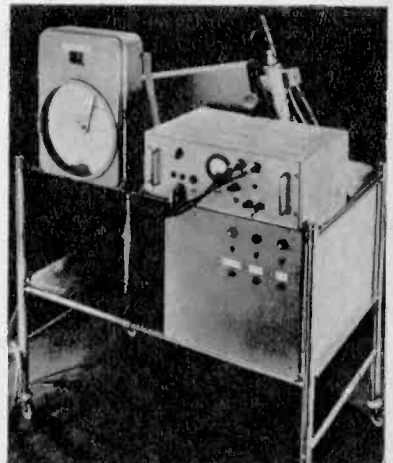

British Information Services

"Electronic lung" uses spectrographic method of monitoring the air for minute amounts of beryllium metal dust, is used in many types of industrial instal-

Learn Electronics

PREPARE FOR YOUR F. C. C. LICENSE—YOUR TICKET TO A BETTER JOB AND HIGHER PAY!



F. C. C. LICENSE—THE KEY TO BETTER JOBS

An F. C. C. *commercial* (not amateur) license is your ticket to higher pay and more interesting employment. This license is Federal Government evidence of your qualifications in electronics. Employers are eager to hire *licensed* technicians.

WHICH LICENSE FOR WHICH JOB?

The **THIRD CLASS** radiotelephone license is of value primarily in that it qualifies you to take the second class examination. The scope of authority covered by a third class license is extremely limited.

The **SECOND CLASS** radiotelephone license qualifies you to install, maintain and operate most all radiotelephone equipment except commercial broadcast station equipment.

The **FIRST CLASS** radiotelephone license qualifies you to install, maintain and operate every type of radiotelephone equipment (except amateur) including all radio and television stations in the United States, its territories and possessions. This is the highest class of radiotelephone license available.

GRANTHAM TRAINING PREPARES YOU

The Grantham Communications Electronics Course prepares you for a **FIRST CLASS** F. C. C. license, and it does this by **TEACHING** you electronics. Each point is covered simply and in detail, with emphasis on making the subject easy to understand. The organization of the subject matter is such that you progress, step-by-step, to your specific objective—a first class F. C. C. license.

CORRESPONDENCE OR RESIDENCE CLASSES

Grantham training is available by correspondence or in resident classes. Either way (residence or correspondence), we train you quickly and well—no previous training required. Even a beginner may qualify for his first class license in a relatively short time.

FOUR COMPLETE SCHOOLS: To better serve our many students throughout the entire country, Grantham School of Electronics maintains four complete Divisions—located in Hollywood, Calif., Seattle, Wash., Kansas City, Mo., and Washington, D. C. All Divisions of Grantham School of Electronics offer the same rapid courses in F. C. C. license preparation, either by home study or in resident classes.

Get your First Class Commercial F. C. C. License Quickly

GRANTHAM SCHOOL OF ELECTRONICS

HOLLYWOOD
CALIF.

1505 N. Western Ave.
Hollywood, Calif. (MA 7-7777)

SEATTLE
WASH.

408 Marion Street
Seattle, Wash. (MA 2-7227)

KANSAS CITY
MO.

3123 Gillham Road
Kansas City, Mo. (JE 1-6370)

WASHINGTON
D. C.

821 - 19th Street, N. W.
Washington, D. C. (ST 3-3614)

This booklet
FREE!



This free booklet gives details of our training and explains what an F. C. C. license can do for your future.

Upgrade Your Income with a First Class F. C. C. LICENSE

In resident classes or by home study, Grantham training is the easy way to learn more quickly and to prepare more thoroughly for F. C. C. examinations. And your first class F. C. C. license is the quick, easy way to prove to your employer that you are worth more money.

If you already have practical experience in radio-electronics, the Grantham course can add a knowledge of theory and an F. C. C. license to that practical experience. This is most important in qualifying you for higher pay and greater job security.

Our free booklet gives details of how you can prepare quickly for a better job in the rapidly expanding electronics industry. Clip the coupon below and mail it to the Grantham School nearest you.

MAIL COUPON TO SCHOOL NEAREST YOU

(Mail in envelope or paste on postal card)

To: **GRANTHAM SCHOOL OF ELECTRONICS**
1505 N. Western • 408 Marion • 3123 Gillham Rd. • 821-19th, NW
Hollywood • Seattle • Kansas City • Washington



Gentlemen:

Please send me your free booklet telling how I can get my commercial F. C. C. license quickly. I understand there is no obligation and no salesman will call.

Name _____ Age _____

Address _____

City _____ State _____

I am interested in: Home Study, Resident Classes **G-0**

Listen to the EICO Hour, WBAI-FM, N. Y., 99.5 MC—Mon., Thurs., Sat. 7-8 P.M., and Sat. 3-4 P.M.

the experts say
your BEST BUY
 is **EICO**...

EICO, 33-00 Northern Blvd., L. I. C. 1, N. Y. FEG-60
 Show me HOW TO SAVE 50% on 65 models of top-quality:

HI-FI TEST INSTRUMENTS "HAM" GEAR
 Send FREE catalog & name of neighborhood EICO dealer. Send free STEREO HI-FI Guide

NAME.....

ADDRESS.....

CITY..... ZONE..... STATE.....

ADD 5% IN THE WEST

...in
STEREO and MONO HI-FI

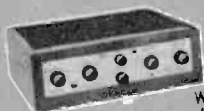

STEREO Dual Amplifier-Preamplifier HF81
 Kit \$69.95.
 Wired \$109.95.
 "Excellent" — SATURDAY REVIEW;
 HI-FI MUSIC AT HOME.



Mono Preamplifier HF65A1
 Kit \$29.95.
 Wired \$44.95.
 With Power Supply HF65:
 Kit \$33.95. Wired \$49.95.



FM Tuner HFT90
 Kit \$39.95*.
 Wired \$65.95*.
 Cover \$3.95.
 "One of the best buys" — AUDIOCRAFT.
AM Tuner HFT94
 Kit \$39.95. Wired \$85.95.
 incl. Cover & F.E.T.
FM/AM Tuner HFT92
 Kit \$59.95. Wired \$94.95.
 Includes Cover & F.E.T.



STEREO Dual Preamplifier HF85
 Kit \$39.95.
 Wired \$64.95.
 "Extreme flexibility a bargain" — HI-FI REVIEW



Mono Power Amplifiers (60, 50, 35, 30, 22, 14-Watt; use 2 for Stereo)
 from Kit \$23.50.
 Wired \$41.50.



2-Way Bookshelf Speaker System HFS1
 complete with factory-built cabinet: \$39.95.



STEREO Dual Power Amplifier HF86
 Kit \$43.95.
 Wired \$74.95.



Mono Integrated Amplifiers (50, 30, 20, 12-Watt; use 2 for Stereo)
 from Kit \$34.95.
 Wired \$57.95.



NEW! COMPLETE STEREO DUAL AMPLIFIER AF-4
 Kit \$38.95
 Wired \$64.95
 TRUE HI-FI quality to drive hi efficiency speakers to concert volume.

70W STEREO Dual Power Amplifier HF87
 Kit \$74.95 Wired \$114.95

...and in
TEST INSTRUMENTS



New Power & Bias Supply for Transistorized Eqp. #1020*
 Kit \$19.95
 Wired \$27.95
 * Patent Pending



Miniaturized Multi-Signal Tracer #145A
 Kit \$19.95.
 Wired \$28.95.



Vacuum Tube Voltmeter #221
 Kit \$25.95.
 Wired \$39.95.



Peak-to-Peak VTVM #232 & Uni-Probe (pat. pend.)
 Kit \$29.95.
 Wired \$49.95.



New TUBE & CRT FIL. Tester #612
 Kit \$3.95.
 Wired \$5.95.
 Fast-checks radio/TV tubes, pilot lamps, etc.



1000 Ohms/Volt V-O-M #536
 Kit \$12.90.
 Wired \$14.90.



5" Push-Pull Scope #425
 Kit \$44.95
 Wired \$79.95.



Tube Tester #625
 Kit \$34.95.
 Wired \$49.95.



RF Signal Generator #324
 Kit \$26.95.
 Wired \$39.95.



Series/Parallel R-C Combination Box #1140
 Kit \$13.95. Wired \$19.95
 1350 Combinations!

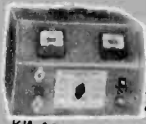

6V & 12V Battery Eliminator & Charger #1050
 Kit \$29.95. Wired \$38.95.
 Extra-filtered for transistor equlpt. #1060
 Kit \$38.95. Wired \$47.95



R-C Bridge & R-C-L Comparator #950B
 Kit \$19.95.
 Wired \$29.95.

IN STOCK! Compare, take them home — right "off the shelf" — from 2000 neighborhood dealers. Over 1 MILLION EICO instruments in use throughout the world.

© 1960 ELECTRONIC INSTRUMENT CO., INC., 33-00 N. BLVD., L. I. C. 1, N. Y.



British Information Services

Radar is used extensively as aid in navigation, air traffic control and in most types of defense warning systems. The set shown above is British.



Probably the most versatile tool in the whole electronic field is the cathode-ray oscilloscope. The model at left is available in kit form from Eico.

Television is today widely used in closed-circuit industrial application, as well as for entertainment purposes. Below is latest type color camera.

NBC Television

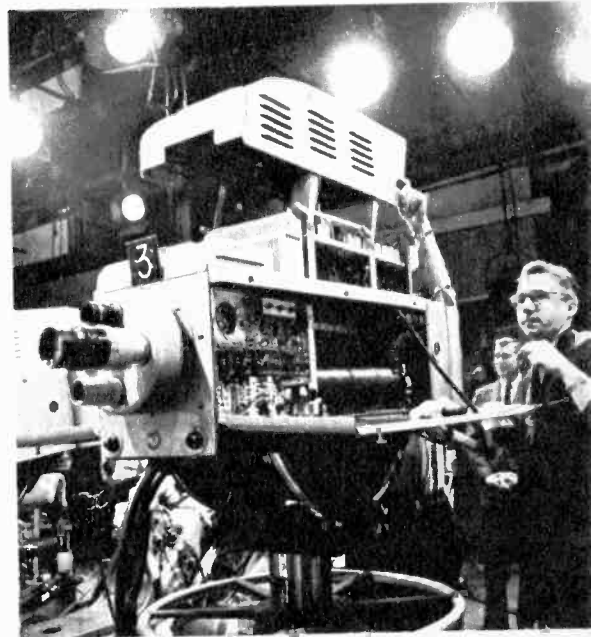

the wondrous thing is that between the transmitting and receiving antennas, even though they may be miles apart, there need be absolutely nothing but empty space. Radio transmission over long distances requires Federal licensing, but the short-range station shown in Experiment No. 1 will enable you to send code messages for several hundred feet over the air.

Electronic Communication

One important branch of electronics, then, is communications. Its purpose is to send intelligence or information of some sort from place to place: a telephone call, TV show, police call or instructions from an airport control tower to a plane. In every case the information is converted into an electronic signal by a transducer, such as a telegraph key, a microphone,
 [Continued on page 20]

EXPERIMENT 1

Building a Code Transmitter

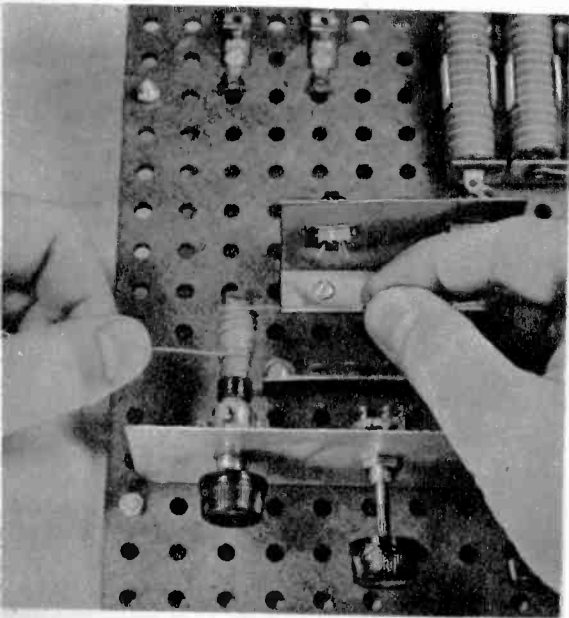
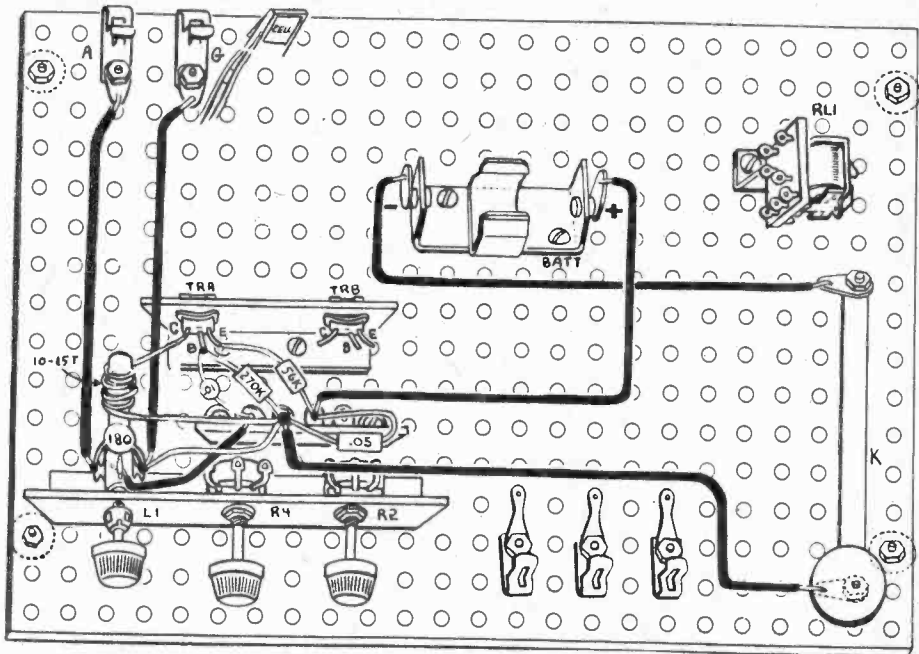

Feedback coil is formed by winding 10 or 15 turns of No. 26 wire on vari-loop antenna coil.

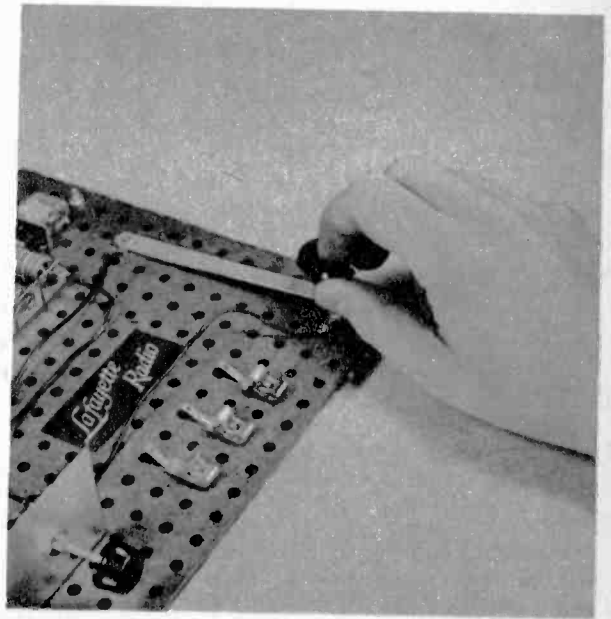

Key grip uses forefinger on knob, thumb and second finger at sides, for best wrist motion.

RADIO is one of the oldest, and still one of the most exciting, applications of the science of electronics. So let's begin our experiments by getting you on the air right away. The code transmitter shown in the accompanying illustrations is built from readily available components or, as shown here, it is one of the projects in the Lafayette Transistor Experimenters 15-in-1 Kit.

The unused parts shown in the picture diagram, such as the relay and potentiometers, are required for succeeding experiments. Two transistors, type 2N107, are needed, although only one is used for your transmitter. The battery voltage is 12 volts.

The circuit is a standard regenerative type, in which tickler coil L_2 feeds a part of the output from the transistor back to the input by inductive coupling to L_1 . This feedback coil is made by winding 10 to 15 turns of No. 26 insulated wire directly over the form of L_1 .

Radio emissions are controlled by the hand

key, which applies voltage from the battery between the emitter and collector of transistor TR_1 . The transistor is conducting, and current flows through the oscillatory circuit only when the key is depressed. At the same time there is an audio-frequency feedback circuit for tone production comprising C_2 , R_{10} , and a tap off part of L_1 . The pitch of the tone is determined by the resistor and capacitor, and may be varied by changing the value of either of these components.

A wire ten feet or less in length serves as the transmitting antenna when connected to terminal A. A ground probably won't be necessary, but a wire from terminal G to a cold water pipe will suffice if needed.

To operate the set, first tune a standard AM broadcast receiver to any quiet spot on the dial. Then hold down the key and adjust L_1 until you hear a tone on the set. Now when you key the signal according to the Morse code, you can send messages or practice the code over the air.

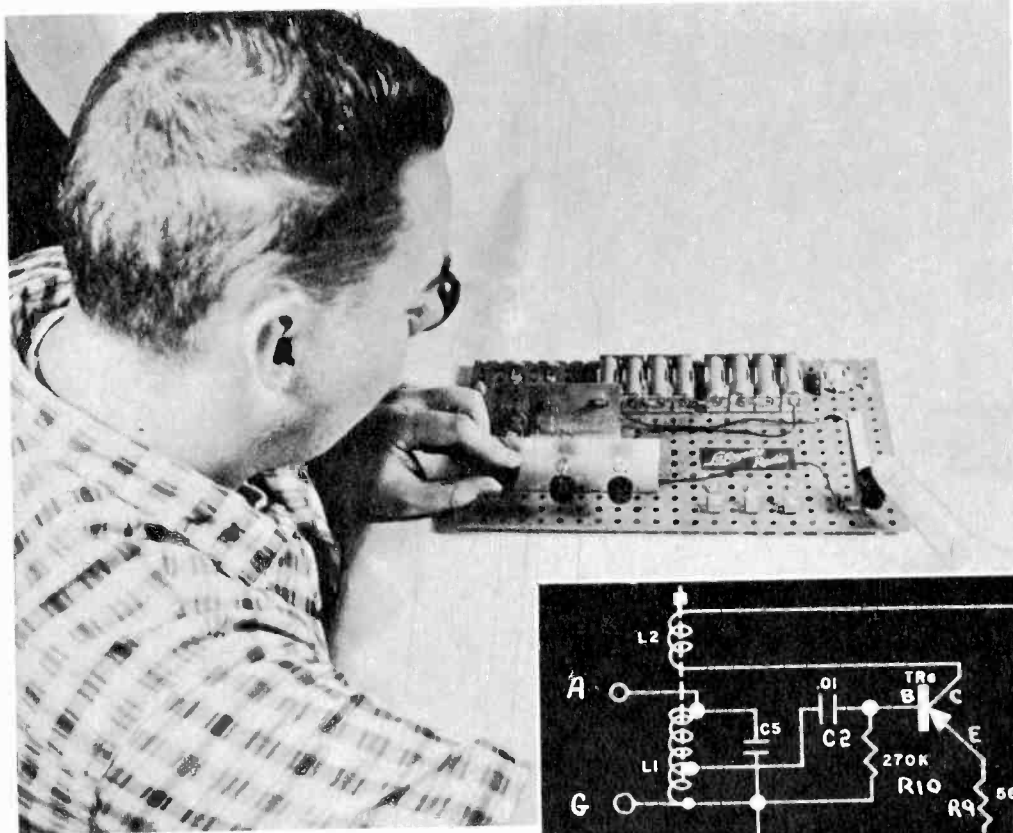

With radio tuned to quiet spot on dial, key is depressed and transmitter tuned by varying L_1 .

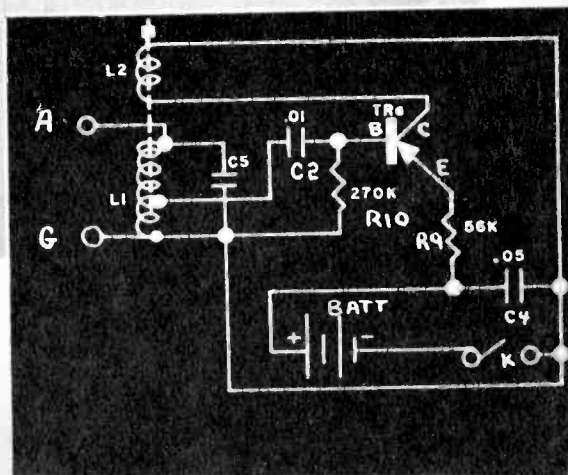

EXPERIMENT 2

Building an Electronic Switch

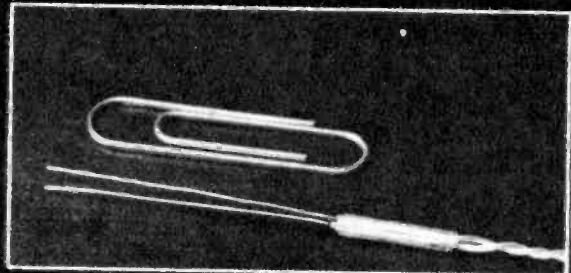
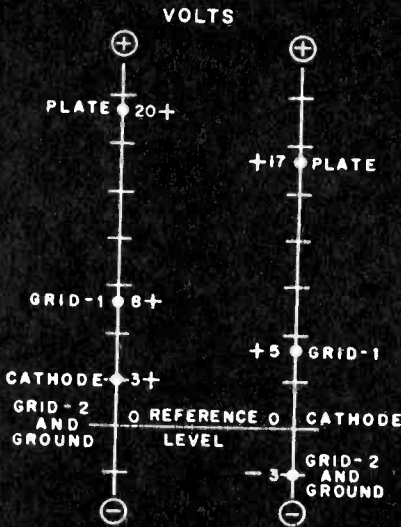
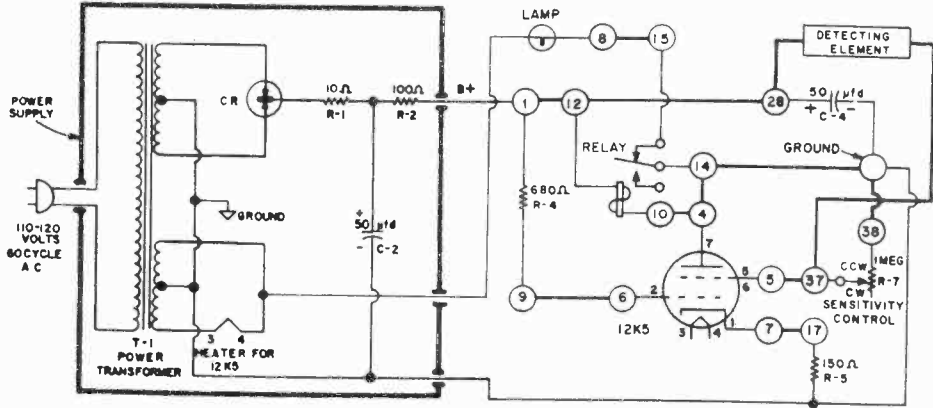

Detecting element (above) can be made by stripping the ends of a pair of wires, keeping them closely spaced.



Addition of salt makes water conduct. Current flows between detector wires, making relay close and light lamp.

THE detecting element of the electronic switch can be used to sense the presence of any material having less than seven megohms resistance. When the detecting leads are connected by such a material, the relay contacts will operate an external circuit or actuate the lamp included here.

The circuit can be built up most easily from the Allied Radio 12-in-1 Electronic Lab Kit. This is a modified "breadboard" arrangement, with all of the components mounted for easy interconnection. The basic board with all components is shown on page 32.

If you prefer, of course, you can build the set from standard components which you may have on hand.

Operation of the circuit depends upon a change in the relative voltages between the plate and screen grid. Voltage is sometimes referred to as potential difference, which means that we are always talking about a voltage existing between two points. Two ways of looking at this are shown in the diagram, where we see on the left

that all voltages are referred to ground, whereas on the right they are referred to the cathode. Both of these scales say exactly the same thing, but with only a changed point of reference. Thus on the left we see that the cathode is three volts positive with respect to grid 2 and ground. But if this be true, then grid 2 and ground are three volts negative as compared to the cathode. In electron circuits it is conventional to use the system at the right, with all voltages referred to the cathode potential.

In the photos we are using the switch to demonstrate how water becomes more conductive with the addition of ordinary table salt. With the salt water placing a partial short circuit across the probes of our detecting element, grid 2 becomes positive, more plate current flows, and the relay is energized, thus extinguishing the lamp. The sensitivity is controlled by the adjustment of R_r . If you prefer the lamp to go on instead of off, connect to the other relay contact, terminal 13.

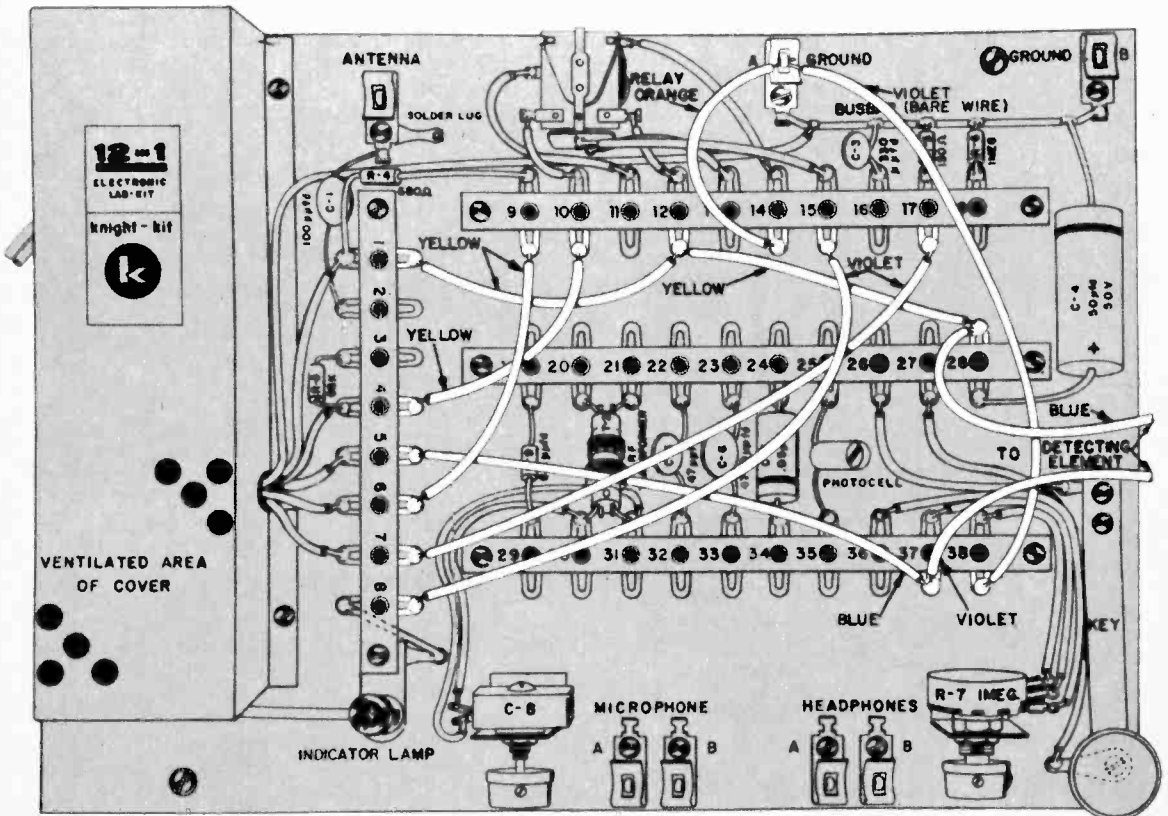

New lightweight high-power silicon rectifier comes in nine peak-inverse-voltage ratings from 50 to 500 volts, provides up to 70 amperes of direct forward current, weighs less than three ounces.



Westinghouse

Dynistor diode high-speed switch, 200 milliwatt, is multijunction germanium switch that functions in fractions of microseconds. Unit is triggered by pulse which can be under one microsecond.

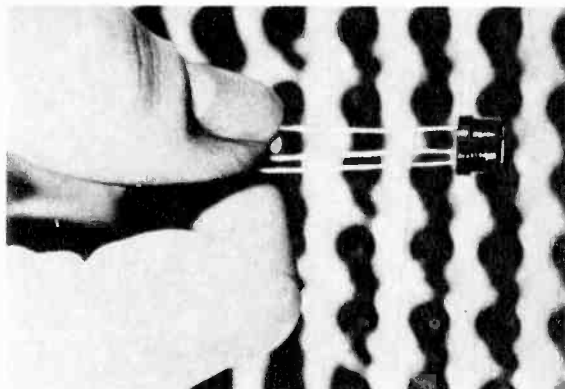

Westinghouse

[Continued from page 15]

a television camera or a teletypewriter.

The signal is then carried by wire line, radio waves, or both. Depending on the nature of the signals, electronic communication is called telegraphy, telephony, television or telemetry. The first three are quite familiar, but the fourth, the baby of the family, is still showing off its great potential.

Telemetering is also known as data transmission, which means the sending of information gathered by instruments from an unnamed point. One of the first devices to telemeter information back to a control station was the radio-sonde weather balloon. Now when we want to know how high or how fast our last guided missile went, or what the conditions are aboard an artificial satellite or inside an atomic reactor, telemetering gives us the answers.

Electronic Instrumentation

This leads us to a closely related branch of electronics. As we implied earlier, almost any physical effect such as heat, light, sound, vibration, infrared and X rays, can produce an electronic signal if a suitable transducer exists. One of the advantages of electronic systems is the ability to *amplify*, to strengthen very feeble signals. Thus the transducer needn't be very sensitive, and it must not upset the physical condition it is attempting to measure.

At the output of the electronic circuit we have a *readout* device, which gives us the desired information. In the engine ignition analyzer the indicator is usually a cathode ray tube. On a Geiger counter it is an ordinary meter. The electrocardiograph may provide a permanent

photographic record. In Experiment No. 2, a light goes on to indicate whenever you are talking.

Other electronic instruments include the photographic exposure meter and colorimeter, the electron clock and the ionization gauge used in physics laboratories. The chemist uses a pH meter to determine the acid or alkaline state of a solution, the engineer uses an electronic strain gauge, the doctor an electroencephalograph, the astronomer a radio telescope.

Electronic Controls

In any system involving the use of power, there is also a need for controlling this energy accurately and rapidly. The hydraulic brakes on a car, or the switches on an electric stove, are just two examples of low power devices which control high powered ones. It doesn't take much work to depress a brake pedal, yet this will stop a car weighing well over a ton. And little effort is required for turning on a stove, yet the voltages and temperatures controlled are powerful enough to cause death.

The idea of using a low-power device to control a high power system is the basis of the *servo* principle, and the devices themselves are called *servomechanisms*. Since they are in effect amplifiers of power, they can be at least partly electronic in nature. Electronic servomechanisms are widely used in automatic pilots, artillery fire control systems, and in many factory production and assembly processes.

Since even the best servo system is inanimate, it is still a slave to mankind and must be told what to do. It can have a "master" in constant attendance, pushing



International Business Machines

buttons, throwing switches or turning rheostat knobs. In this case the system is called an *open cycle* control.

But in many cases the instructions are prepared in advance, and recorded in some way, such as on a punched or magnetic tape. Or the system may be self-correcting, such as the automatic pilot which senses when the airplane is going off the set course and automatically makes correction. This type of operation, in which a human starts it off but then leaves the system to take care of itself, is known as *closed cycle* control and the process is called *automation*.

Electronic Switching

Many electron tubes and circuits can be adjusted so as to act as on-off devices. That is, instead of passing varying currents as an amplifier does, they will pass either a fixed amount of current or no current at all. Thus they are in effect electronic switches. They don't wear out mechanically, and when they do fail, usually plugging in a new tube or transistor will make the repair.

A huge number of electromechanical switches and relays are employed in automatic telephone dialing systems, but the handwriting on the wall says that they are doomed for replacement by electronic switching circuits. Electronic data processing equipment, better known as computers or "electronic brains," also depend for their operation upon hundreds of electronic switches.

Now that we know a few of the things this art of electronics embraces, let us study the source of this wonderment: the infinitesimally small electron itself. *



British Information Services

Above. Electronic high-speed sorting machine is used to check length and diameter of steel roller to 1/500,000th inch at rate of 5,000 per hour.

Use of high-speed computers is widespread today in scientific and business organizations. The IBM 705 data and processing machine is at left.

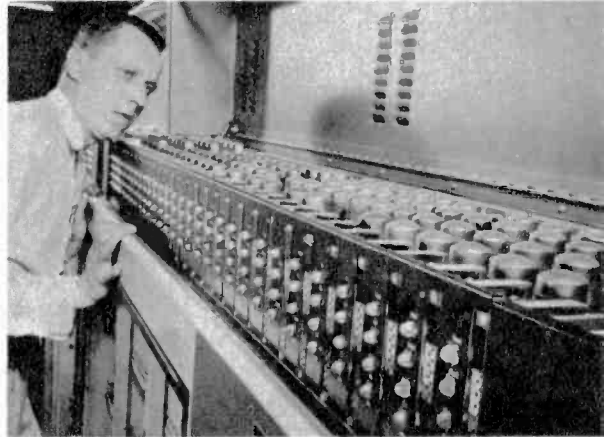

Hughes Aircraft Co.

All-electronically controlled machine tools have tape control which flows through this bank of contact relay and blinker light master panel.

Spectroscopy and X-ray diffraction equipment is used to test stress of materials; study of alloy compounds, chemical reactions and identifications.

Radio Corp. of America

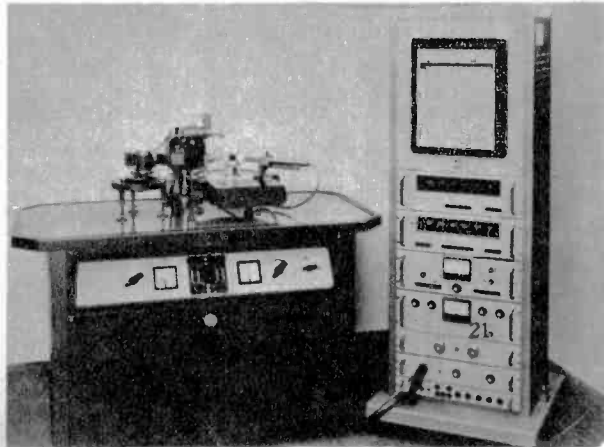

Chapter 2

THE TINY ELECTRON

The nature of matter—electron theory

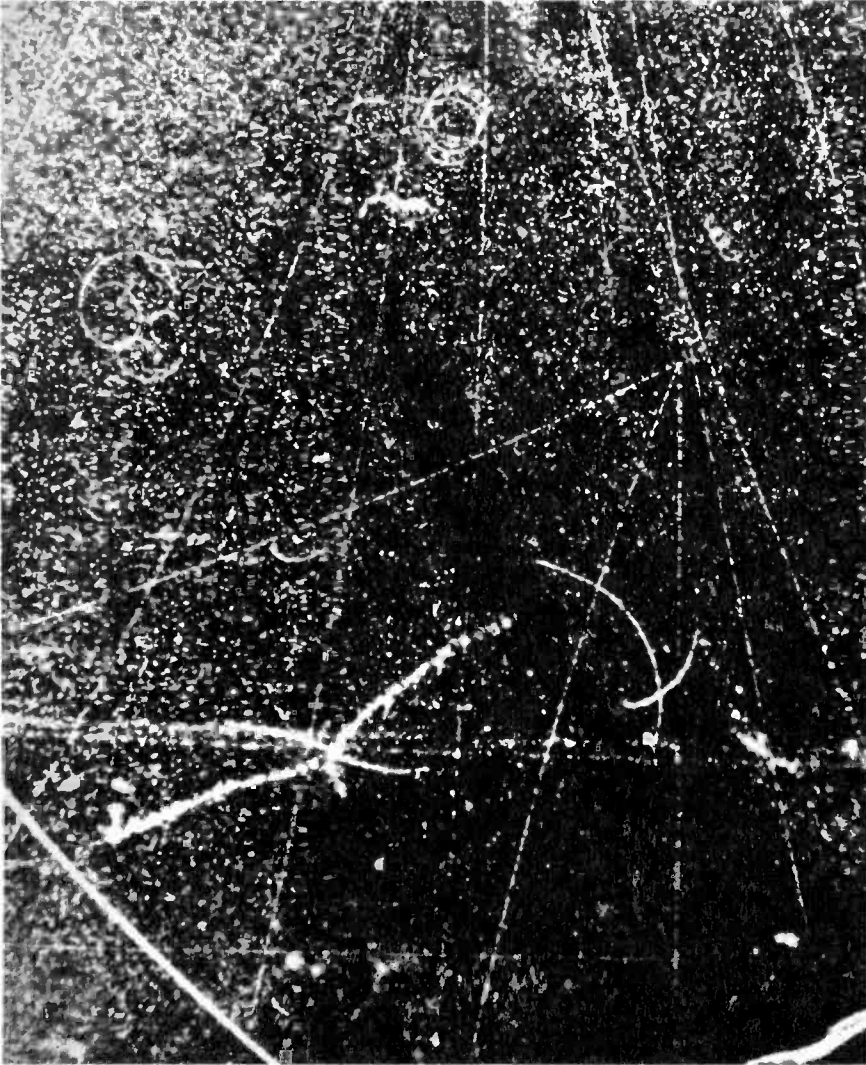

Brookhaven National Laboratory

Columbia University



Right. A physicist scans screen of a cloud chamber, watching the tracks of nuclear particles. The chamber makes paths of sub-microscopic nuclear particles visible. A cloud is created in a confined volume by the sudden expansion of air in the chamber, causing a super-saturation of that air with water vapor. When nuclear particles traverse this cloud, droplets are formed along paths of the particles, due to ionization of the air molecules. Path of droplets can be photographed with strong light source.

IT isn't surprising to learn that the science of electronics depends upon that tiniest particle of matter called the *electron*. Not only that, but much of what we experience in life is explained by the *electron theory* of matter.

The scientist calls matter "anything which occupies space, and has weight and dimensions." In a general way, then, we can say that matter is anything which can be detected by one or more of the five human senses.

Nearly all objects of matter are thought to be made up of a huge number of tiny particles called *molecules*. Each substance has its own particular molecular structure, and so there are as many types of molecules as there are substances—an almost infinite variety.

Chemical Elements

We also know, however, that all matter consists of elements, usually in combinations of two or more. One of the elements is hydrogen. Another is oxygen. Both hydrogen and oxygen are gasses, but when they combine in a certain way a liquid results: common everyday water. Another example is sodium, a soft putty-like solid, and chlorine, a gas. Both of these are poisons, yet they can combine to form a new crystalline solid, sodium chloride, bet-

ter known as common table salt, which we all eat every day.

If we take the salt or the water and start to break it down, we can subdivide it further and further until only one single molecule of it is left. But if we break down that molecule, we no longer have the salt or the water. Thus we can say that the molecule is the smallest possible part of a *compound* substance.

Going even further we find that if we break up the water molecule, it splits into *atoms*, two of hydrogen and one of oxygen. Remembering that hydrogen and oxygen are both elements, we can gather that, while the molecule is the smallest particle of a compound, the atom is the very tiniest part of an element.

Suppose we go even further and look inside one of the hydrogen atoms, the simplest atom of all. If this were possible, we would see that it looked like Fig. 1. Here we see a central nucleus, with a satellite revolving around it in orbit, just as our planets swing around the sun. The nucleus of the hydrogen atom contains a single particle called a *proton*, which is actually a unit of electricity, said to be positively charged. Similarly, the tiny planet revolving around the nucleus is called an *electron*, the basic particle of negative electricity.

At left is photograph taken with the help of a cloud chamber. When 2.2 billion electron volt protons accelerated by the Brookhaven Cosmotron strike a graphite target, protons and neutrons flying out may bombard cloud chamber containing hydrogen. The long streaks from top down are protons or mesons. Neutrons remain invisible since they have no electric charge and thus do not interact with other atoms. The three-pronged effect at right was caused by incoming neutron hitting a proton. While the invisible neutron bounces off, proton shoots straight down to bottom of photo and two pi mesons carom off, one downward, one to left. Other tracks in photo are caused by less energetic particles such as electrons.

Below, left, is Benjamin Franklin's electrostatic machine which, when wheel was turned, created static electricity by friction. At right is an old historic print of Alessandro Volta (1745-1827), the Italian physicist, inventor of the "Voltaic Pile," which is the true forerunner of today's modern electric battery.

The Franklin Institute

Culver Service

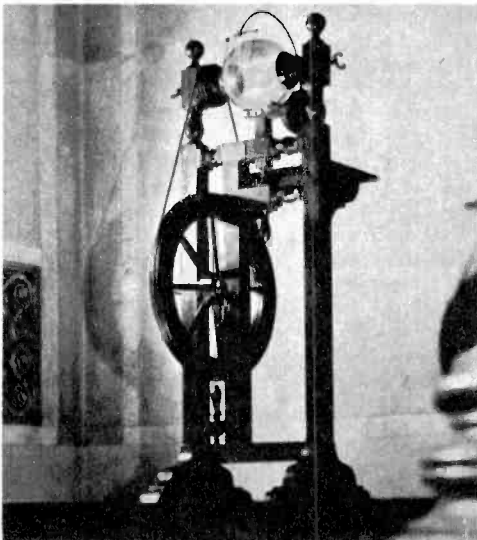

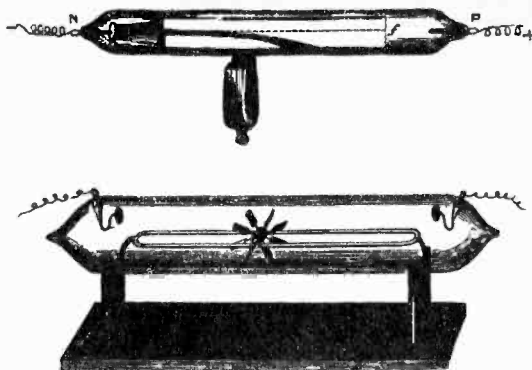

Drawing of Crookes' Tube, a cathode-ray tube, by Sir William Crookes. At top is experiment of diverting the tube's rays with help of a magnet.

Photo, left: Georg Simon Ohm (1787-1854), noted German physicist, who gave us Ohm's Law.

Neutrons, Too

Now let's look inside a more complex atom, that of carbon. As we see in Fig. 2, this atom has six protons in its nucleus. It also has six *neutrons* in the nucleus. Neutrons have no electric charge, but may be thought of as a sort of nuclear cement, holding the protons in space, as in Fig. 3. Orbiting around this nucleus we find an equal number of electrons.

This is the customary condition for an atom, with the number of its planetary electrons equal to the number of nuclear protons. Since the positive charge of each proton is exactly equal to the negative charge of each electron, the two opposite types of charges cancel out and the atom is said to be electrically neutral. If all substances were always neutral, however, there would be no science of electronics, as we shall see.

All electrons are identical, as are all protons. And while the electron is about twice the diameter of the proton, the proton is about 1,840 times heavier. To get some idea of how infinitely tiny the electron is, think of the orbit the earth makes around the sun, which happens to be around 186 million miles in diameter. Then compare that huge circle to an ordinary ping-pong ball, of about an inch or so in diameter. Now the ratio of the earth's huge orbit to the diameter of the ball is about the same as the ball is to an electron.

All atoms, no matter what material they

comprise, are made up primarily of protons, neutrons and electrons. And the differences in characteristics of substances—from gold, to silver, to the air we breathe, to a pastrami sandwich—the only differences are in the number and arrangement of the protons, neutrons and electrons which go to make them up.

Electric Charges

Very interesting, you say. But what does all this have to do with electronics? Well, we shall see. Electrons and protons are called *electric charges* because of the way they react to one another. Electrons tend to repel each other with relatively enormous forces, and protons react against other protons in the same way. But electrons have an equally strong attraction for protons, and protons feel the same way about electrons.

This fact provides us with one of the basic electronic laws: *Like charges repel and unlike charges attract.* If this were not so, atoms and molecules would be flying apart in all directions. It is only the attractive force between positive charge of the nucleus and negative charges of the planetary electrons that holds them together.

Often, however, this delicate balance between charges within the atom or molecule may be easily upset. The substance may be of the type which will readily lose a few electrons from its outermost orbit, or shell, or this same shell may constantly be seeking to add a few more.



Sir John Ambrose Fleming (1849-1945), English electrical engineer, inventor of the diode tube.

Madame Curie (1867-1934) won two Nobel Prizes, one in physics in 1903, one in chemistry, 1911.

If either of these two events actually occur, the body itself is said to be charged. As an example, consider the old parlor trick of running a comb briskly through the hair, and then using the comb to pick up bits of paper by static attraction. In this case friction has caused the comb to gain some electrons, and thereby to become negatively charged.

If the comb had lost electrons, the negative charges out in orbit would no longer have canceled the positive ones in the nucleus, and the substance would be said to be positively charged. Since the comb has added extra electrons, their force now exceeds that in each nucleus, and the substance is negatively charged. This leads us to another fundamental electronic law: *A negative charge indicates an excess of electrons, while a positive charge results from an electron deficiency.*

When a body becomes charged, the condition we are discussing is actually one of *static electricity*. And at this point we should understand that man cannot generate electricity. We can cause electrons to move from place to place, yes, but whether we use friction to cause the movement, or a dynamo, or a solar battery, we are simply controlling electrons which are already there. A battery or generator no more creates electricity than a pump creates water.

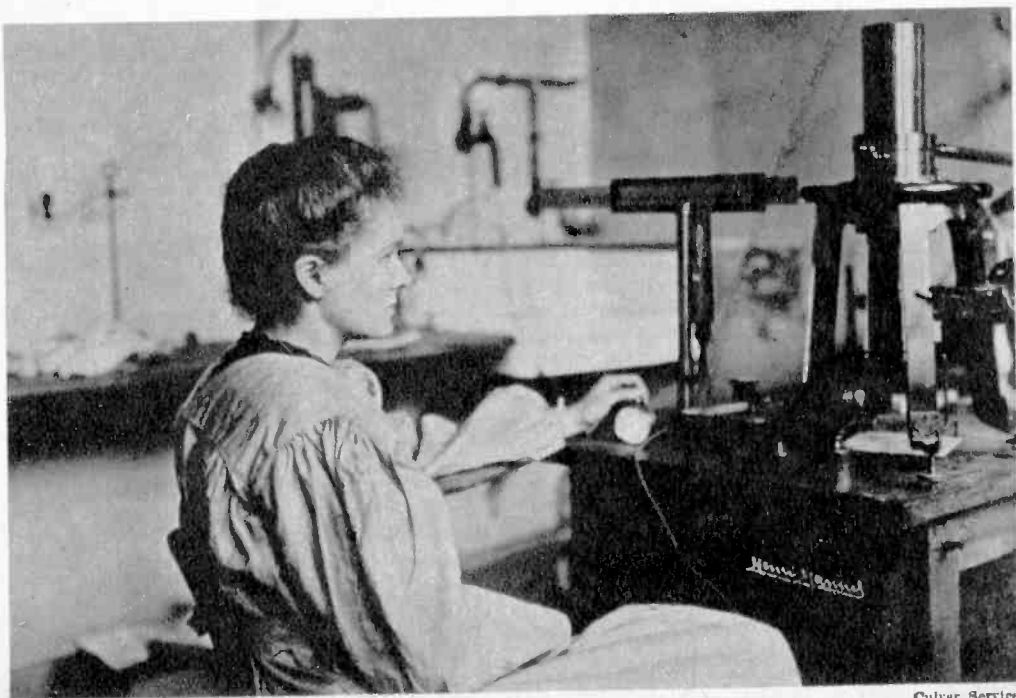

Culver Service



Culver Service



British Information Services

FIG. 1. The hydrogen atom is the simplest of the elements, having only one proton in the nucleus, surrounded by a single, negative-charge electron.

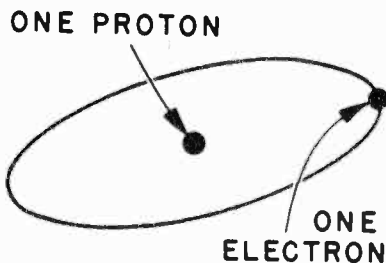

Above, left, Professor J. J. Thomson (1856-1940), famous English physicist. Nobel Prize winner in 1906. At right is a portrait of Lord Rutherford (1871-1937), who, in Cambridge, England, made the fundamental discovery of the positively charged nucleus, which discovery eventually led to the splitting of the atom.

Radioactivity

There is another type of electron movement within certain elements, wherein they are constantly and spontaneously shooting off protons and electrons. These elements are very unstable, and their behavior is called *radioactivity*. Their characteristics are constantly changing, but since they have such a large number of protons and electrons to begin with, the noticeable changes occur very slowly. Nevertheless, it is quite possible that in time a radioactive element will actually change into another element. Here in nature is a transmutation of the kind the ancient alchemists were attempting to perform by changing lead into gold.

Getting back to our hair-and-comb experiment, the charge developed between these two bodies can be easily discharged by the simple process of touching the comb to the hair without the earlier friction movement which set up the charge. But it is interesting to note that the bodies do not actually *have* to touch.

The excess electrons on the negative body may flow through another medium to the positive body and so restore the equilibrium. When this happens, the medium is said to be an electrical *conductor*, and the electron flow constitutes an electric *current*.

The conductor is usually a metallic wire. But it could be a liquid, such as an electroplating bath. Or it might be a gas, as in a neon tube. It can even be nothing at all, as in a vacuum tube, about which we'll learn more in the next chapter. And now we have new types of solids known as *semiconductors*, which go to make up tran-

sistors, and which we will discuss in Chapter 4.

Electric Current

In Experiment No. 3 you have generated an electric current by magnetic induction. Anything which will cause an electron flow in a conductor is called an *electromotive force*. In Fig. 4 a battery is the source of e.m.f. This flow does not mean that each excess electron flows all the way through the conductor to the point of electron deficiency. It is something more akin to the maneuver in croquet when you try to knock your opponent's ball out of the park.

In this case you hold your foot on your own ball so it won't move. But when you smack it with the mallet, the opposing ball which was lying next to it goes flying. You could do the same thing with a whole string of croquet balls in line if you wanted to. Then you'd strike the blow at one end, but the ball at the other end of the line is the one which would take off.

This same kind of chain reaction occurs in a conductor. An electron near one end strikes another, that in turn hits still another, and so on until the effect is felt all the way down the line. Thus no one electron moves very far, but the *effect* of the electron flow is felt at all points along the conductor.

Now if we connect the ends of a copper wire to the terminals of a battery, a fairly sizable electron current will flow. But if we connect a carbon rod to these same terminals, the current will be much less. Obviously some materials are better conductors than others. Why?

It appears that the better conductors are those whose atoms will fairly readily give

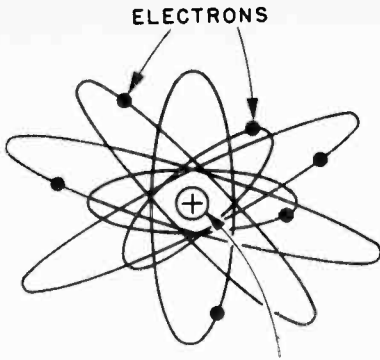

SIX PROTONS PLUS SIX-NEUTRONS.

FIG. 2. The carbon atom has six planetary electrons, each in its own orbit, surrounding a nucleus which consists of six protons plus six neutrons.

up an electron from its outer shell or orbit. The atoms of some materials, on the other hand, hold on to their electrons so tightly that it is difficult to free any electrons and cause them to move along in a given direction. Depending upon how strongly the atoms hold on to their outer electrons, they are called *resistors* or *insulators*.

The Ampere

Any current flow, even the slightest, involves tremendous numbers of electrons. The unit of electric current is the *ampere*, in which more than *six quintillion* (6,280,000,000,000,000,000) electrons flow past any given point in the circuit in just one second's time. Even so, only a small fraction of the electrons present in the conductor go to make up the current flow. In the case of a good conductor, it is estimated that the ratio is only 1 in 5,000. And in resistors and insulators, of course, the ratio is even greater.

The electromotive force which drives electrons through a conductor may be generated in a number of ways. Among them are the following:

1. By friction between two bodies, as in our comb experiment. This is called *electrostatic* induction.
2. By *chemical* action, as in the dry cell or storage battery.
3. By *electromagnetic* induction, as in the dynamo in an electric power plant.
4. By *thermoelectric* action, when the junction of two dissimilar metals is heated.
5. By *photoelectric* emission, when certain types of sensitive surfaces are struck by light.
6. By *piezoelectric* effect, in which cer-

[Continued on page 31]

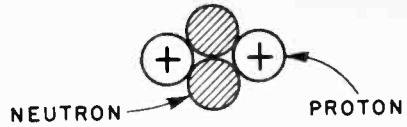
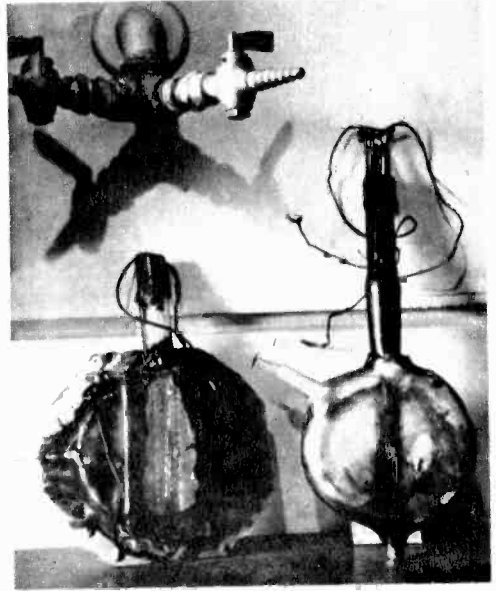

FIG. 3. Simplified drawing of the nucleus of a helium atom. Two protons are "glued" together by two neutrons. The two electrons are not shown.



University of California

The first two chambers in which E. O. Lawrence and N. E. Edlefsen tested the magnetic resonance principle, which later became the cyclotron. Chamber at left was made of odd pieces of window pane, scraps of brass and an overcoat of wax. Both were built and tested in early 1930.

FIG. 4. A simple electrical circuit, with the battery as source of electromotive force (A). The same circuit is shown as a schematic (B) at right.

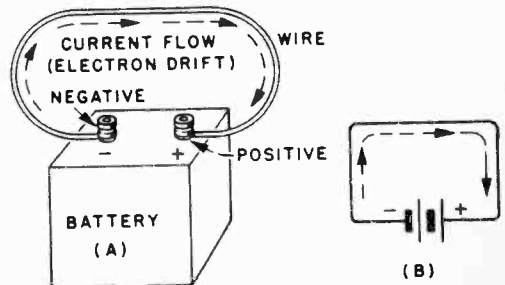

EXPERIMENT 3

Generating an Electric Current

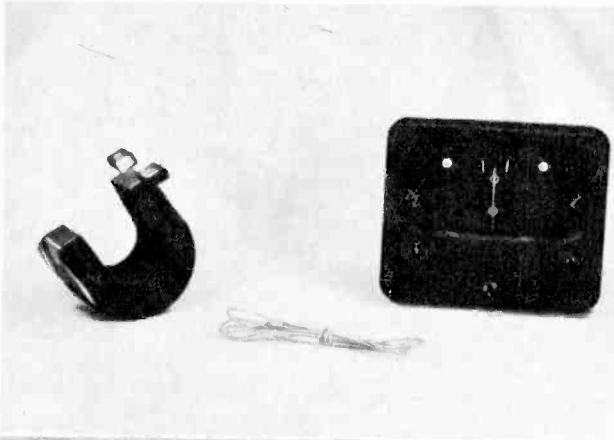

Parts required for experiment are simple. Horseshoe magnet, center-reading milliammeter and length of wire will suffice.

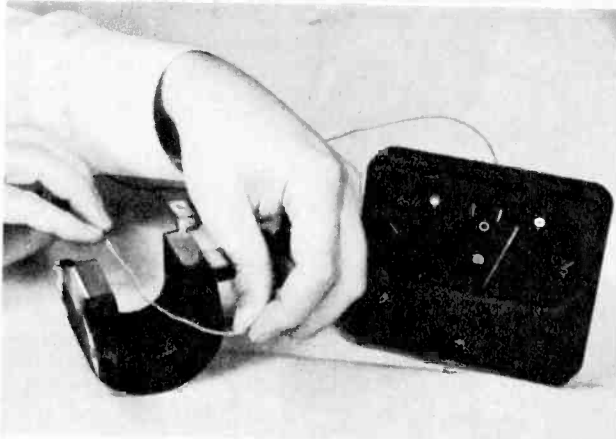

Moving wire rapidly downward (left) through magnetic field causes momentary deflection of meter, then return to zero.

Moving wire rapidly upward (below) through magnetic field causes meter pointer to deflect same amount, opposite direction.

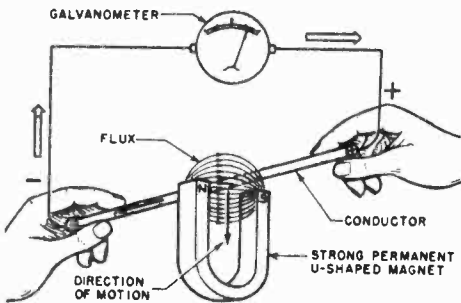

Schematic representation of experiment shows conductor cutting invisible flux.



IN this experiment we learn the principles of the electric generator, which impels an electron current through wire conductors, ultimately making up the electric power we consume in home and industry. The materials required are simple: a fairly powerful horseshoe magnet (the odd-shaped one shown here was picked up at low cost from surplus); an inexpensive milliammeter, preferably of the zero-center type; and a short length of wire.

This experiment is based on a discovery of Michael Faraday, which has since been accepted as an electrical law: whenever a conductor cuts across magnetic lines of force, a voltage is induced in that conductor. Lines of force are continually flowing out of the North pole and into the South pole of any magnet. When a wire conductor is moved down between the two pole faces, a voltage will be induced. Similarly, when the conductor is moved upward through the gap, current will flow in the opposite direction, as

shown by the reverse deflection of the meter pointer.

If you hold the wire still, even right in the middle of the magnetic flux, no current will flow. Obviously the conductor can cut no flux lines unless it is in motion (or unless the magnet is in motion). Thus as long as the magnet and the wire are both stationary, no lines will be cut and no current will flow.

The magnitude of the voltage generated will depend upon the rate at which the lines of force are cut. If we move the wire more rapidly, the voltage will increase. By the same token, two wires would cut twice as many lines as one, and so the voltage would seemingly be doubled.

But when we try doubling our wire, we find that the voltage drops to zero. The reason is that equal voltages are being induced in opposite directions, and they cancel each other out. We can double the voltage, however, by forming the wire into a square loop, twisting so the two sides move in opposite directions.

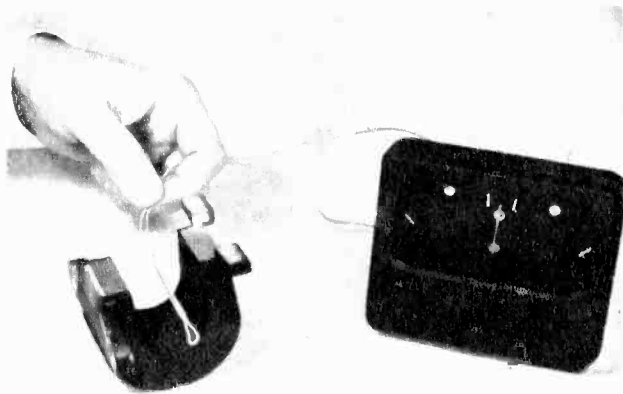

Folded pair of wires generates no current externally, as two currents flowing in opposite directions cancel each other.

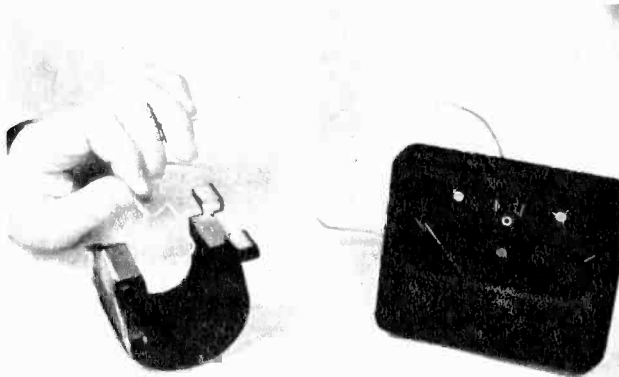

Wire in square loop form, when rotated through field generates currents which add together, as in huge commercial dynamo unit.

THE COSMOTRON-

How It Works

2. REVOLUTION IN MAGNETIC FIELD

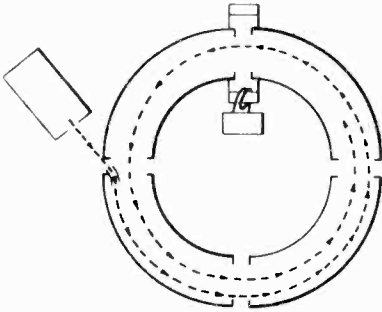

Increasing magnetic field causes protons to spiral in around Cosmotron making 350,000 turns per second.

4. PROTONS ACCELERATED TO ABOUT 175,000 MILES PER SECOND OR 90% OF THE SPEED OF LIGHT.

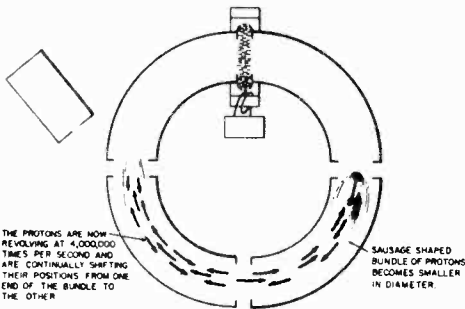

Each passage through accelerating voltage adds 800 electron volts of energy to the protons. After about 3 million turns - the equivalent of four trips around the earth - these protons have acquired the energy of 2.3 billion electron volts.

1. INJECTION OF PROTONS:-

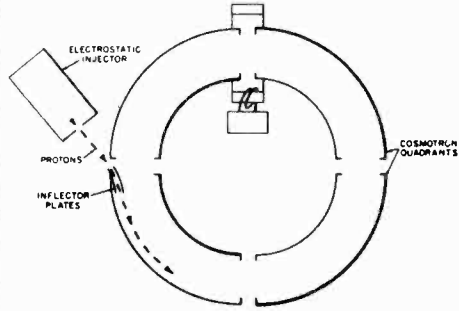

Protons from electrostatic generator "shot" into metal vacuum tank of the Cosmotron at an energy of 3.6 million electron volts.

3. ALTERNATING VOLTAGE TURNED ON TO ACCELERATE SOME PROTONS.

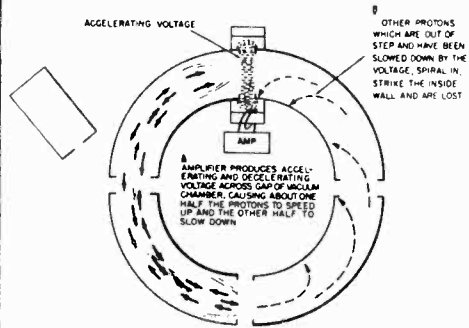

The protons that have been speeded up by accelerating voltage, stop spiraling in, group together in a sausage shaped bundle and continue to revolve at higher and higher speeds.

5. TARGET INSERTED IN PATH OF PROTONS.

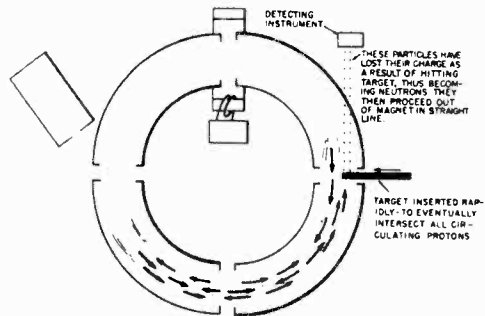

Detecting instruments, such as cloud chambers, are used by scientists to study result of collision of these neutrons and other particles with various elements.

[Continued from page 27]

tain crystalline substances generate voltages when subjected to mechanical strain. The crystal or ceramic phono cartridge is a good example of this.

The Volt

The term "voltage" was just used, because the *volt* is the unit of electromotive force, just as the ampere is the unit of cur-

rent. Now if an e.m.f. of one volt will force a current of one ampere through a conductor, that conductor is said to have a resistance of one *ohm*. Every circuit element has some resistance, since there is no such thing as a perfect conductor, but when it is specifically desired to limit the current flow to a certain value, an element is inserted in the circuit, known as a *resistor*.

There is a very close and direct relation-
[Continued on page 34]

FACTS ABOUT THE COSMOTRON

The Proton Beam

Energy of protons (attained) 2.3 Bev
Time required to accelerate 0.8 sec
Time interval between pulses 5 sec
Number of
 revolutions to full energy 3 million
Distance
 travelled by protons 130,000 miles

The Magnet

Turning radius of magnet 30 ft
Vacuum chamber,
 inside dimensions 36 in x 6 in
Weight of magnet steel 1800 tons

The Magnet Power Supply

Maximum power supplied
 to magnet 40,000 horsepower
Energy delivered to magnet
 in one pulse 11 million joules
Energy returned
 to flywheel 8 million joules

Injection System

Energy of injected protons 3.6 Mev
Number of
 injected protons 1000 billion
Required energy control 0.1 percent
Accuracy of time to
 inject protons 1/100,000 seconds

Radio Frequency Acceleration

Lowest frequency 350 kilocycles
Highest frequency
 (2.3 Bev) 4100 kilocycles
Radio frequency power
 (2.3 Bev) 180,000 volt-amps
Frequency control 0.1 percent

Brookhaven National Laboratory



Columbia University

Uranium element is placed into graphite pile of New York's Columbia University atomic reactor.

Below is photograph of the Alternating Gradient Synchrotron, Brookhaven National Laboratory. A circular 840-foot diameter tunnel will accommodate housing for the magnet assembly. The drawings on page 30 show how the cosmotron works. Table at left gives facts and figures.

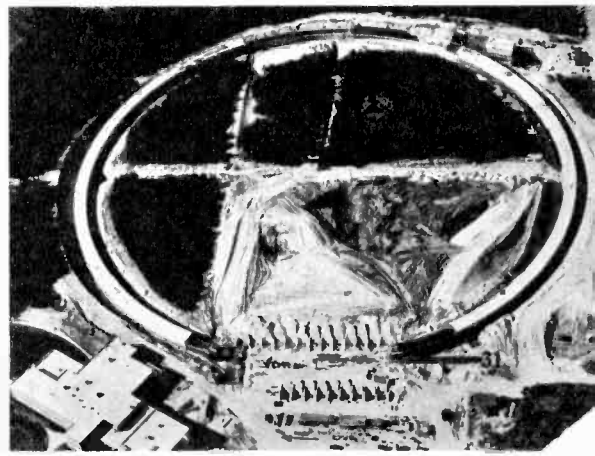

EXPERIMENT 4

Building a Power Supply

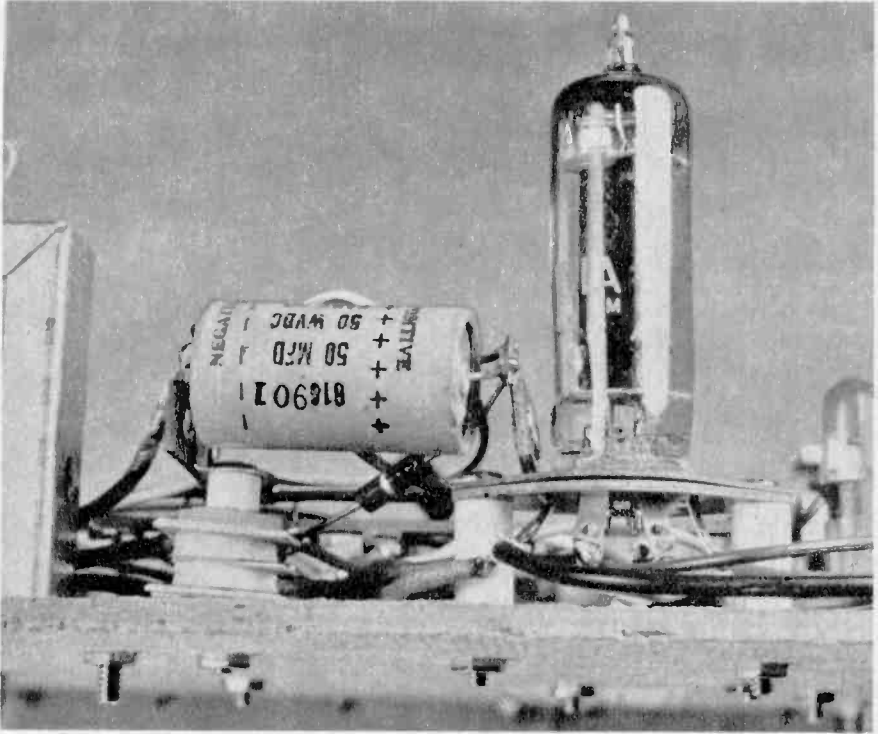

Tiny selenium rectifier above is dwarfed even by miniature tube. Rectifier is wafer stack under left end of tubular capacitor. Cover plate (below) encloses complete power supply plus electron tube.

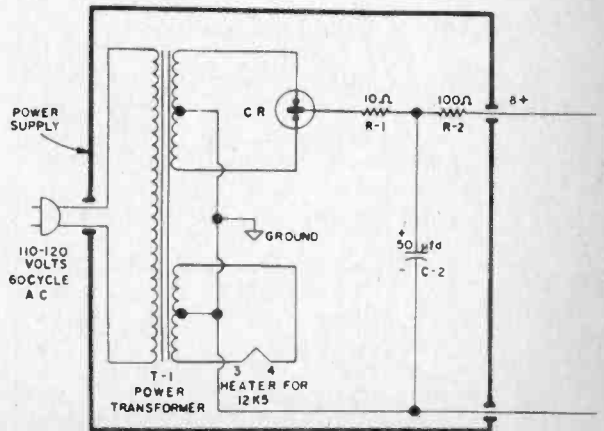
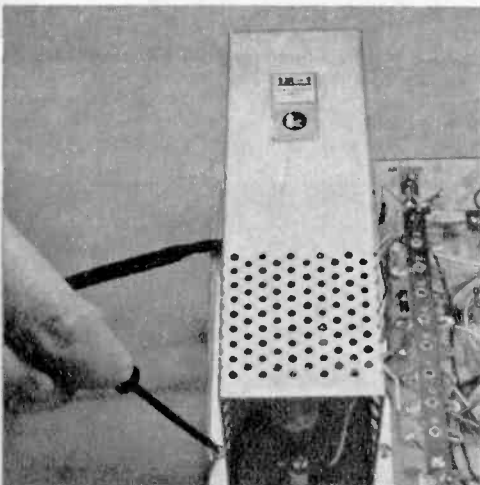

THE energy required to operate the transistor circuits used in these experiments comes from batteries. For the electron tube experiments, however, we use your house power, which is developed from water power, coal and steam, or, in the future, atomic energy. This house power, however, must be changed into the form required by the tube, and this is the function of the power supply.

The power supply performs two important jobs: first, it changes the value of the house voltage to that required by the circuit (in this case, the voltage is reduced considerably, for safe handling); second, it *rectifies* the current by changing it from alternating (AC) to direct (DC) current, the same kind as is delivered by batteries.

Referring to the simplified schematic diagram, the incoming house current at A goes through variations from 0 to + to zero to -, and back to zero. This is one complete cycle. Similar waveforms B and C at the secondary windings of

transformer T_1 are not as great as A, because they have been stepped down by the transformer.

Selenium rectifier CR is a one-way crystal device, which permits electrons to pass through it in one direction only. On the reverse halves of each cycle it acts like a very high resistance and effectively blocks off the current.

This rectifier is a two-section unit, however, each of which passes opposite alternations of the wave. That is, positive pulses can get through one section while the negative pulses can get through the other. But the two sections are so connected that the opposite alternations of the wave are in effect flopped over so that they are now all in the same direction.

The result is that the negative pulses have now become positive also, and the current now is known as pulsating DC. This pulsating current then goes through a smoothing filter, comprising R_1 , R_2 and C_2 , to come out as smooth DC.

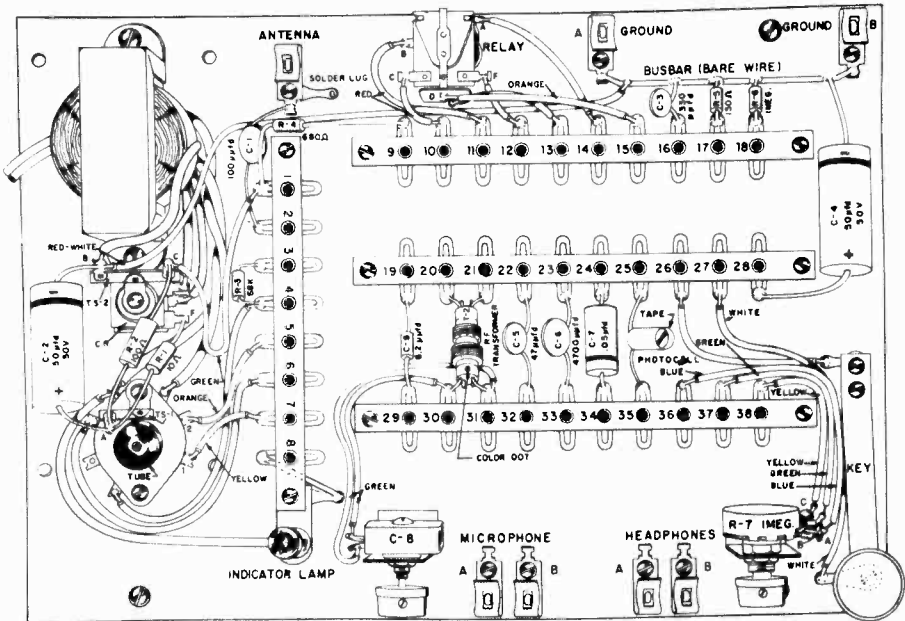
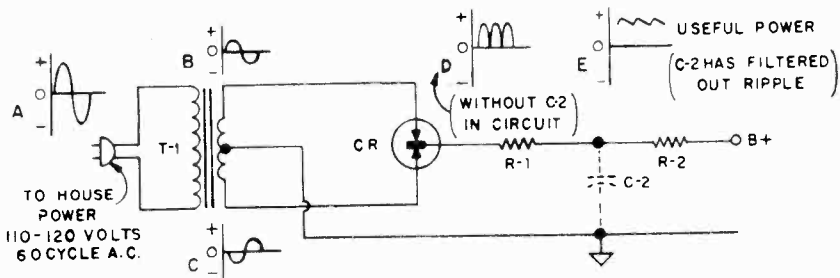

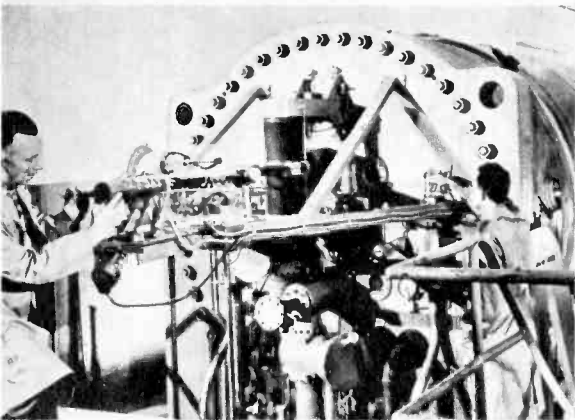

Brookhaven National Laboratory

The linear electrostatic accelerator, known as the Van de Graaff Generator, accelerates subatomic particles to a speed approaching 15,000 miles per second, bombarding targets for physical, biological, medical or chemical research. Man at left adjusts and tightens target chamber.

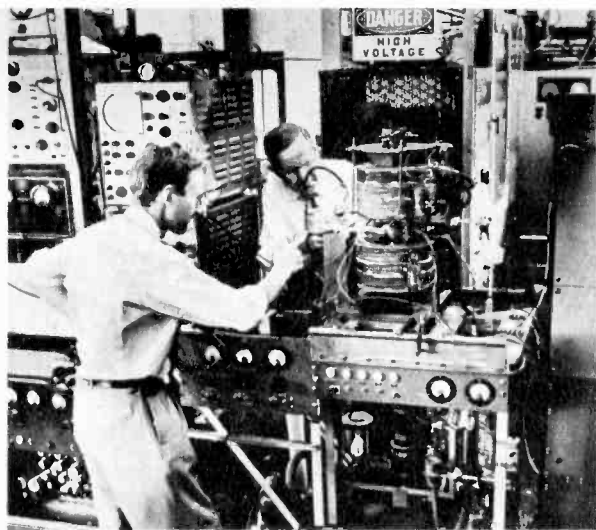

Radio Corp. of America

Complex equipment is used for study of super-high current density electron beams for microwave and millimeter-wave radar techniques. Unit extracts electrons from gas discharge of magnetically-confined mercury pool arc, accelerating and forming them into high-current electron beam.

FIG. 5. The transformer permits the stepping an AC voltage up or down, but it will not pass DC.

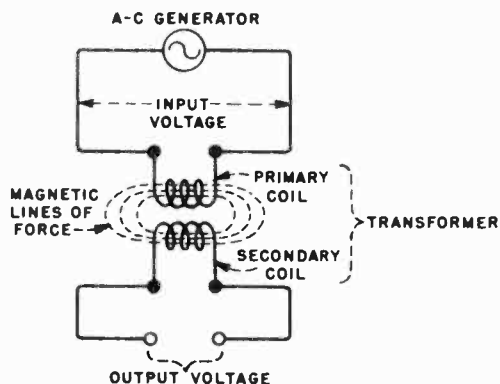

The mass spectrometer, an electronic, high-vacuum instrument. The sample in a vapor phase is admitted to the analyzer system where molecules are bombarded with a stream of electrons. This breaks the molecules to charged ions, which are accelerated to a target where current is produced.

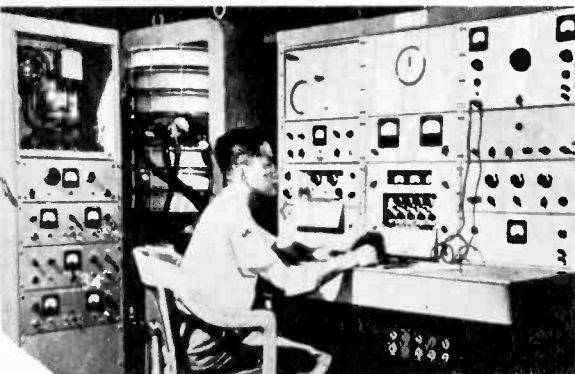

[Continued from page 31]

ship between resistance, current and e.m.f. If the voltage increases, we would expect the current to go up also. But if the resistance increases, the current will drop. These relationships were expressed in a group of three little mathematical formulas over 130 years ago by a German scientist, after whom they are named *Ohm's Law*. This is one of the most important of all electronic relationships.

Mr. Ohm adopted the letter symbol I (intensity) for the current in amperes, E for the e.m.f. in volts, and R for the resistance in ohms. In one form Ohm's Law tells us that to find the current in amperes in any circuit, we must divide the e.m.f. in volts by the resistance in ohms. Thus the formula becomes $I = E \div R$.

As an example of how this works, let's find out how much current a light bulb having a filament resistance of 12 ohms will pass when it is connected to a source of e.m.f. of 117 volts:

$$I = \frac{117}{12} = 9.75 \text{ amperes}$$

Now suppose we want to determine the resistance when the voltage and current are known. For example, what is the resistance of the windings of a 12-volt starter motor when the current through them is 2 amperes?

$$R = \frac{E}{I} = \frac{12}{2} = 6 \text{ ohms}$$

Finally, consider the case where the resistance and current are known, and the voltage must be found. Say we have a pilot

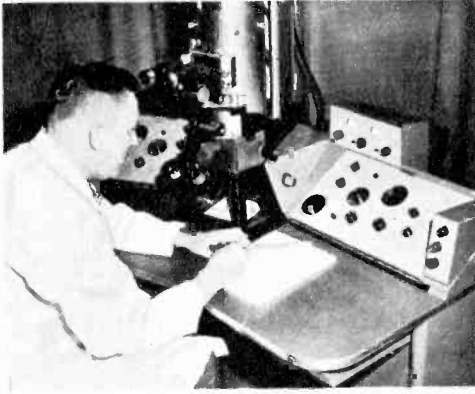

Electron diffraction chamber, shown at head level, is inserted into the electron microscope column in place of the intermediate lens, permits operator to observe the fluorescence of a specimen being bombarded by an electron beam while the picture of the diffraction pattern is taken.

lamp which has a measured resistance of 4 ohms. When lit to full brilliance it draws a current of 1.5 amp. Can we use this lamp in a 12-volt circuit?

$$E = I \times R = 1.5 \times 4 = 6 \text{ volts}$$

Since this is a 6-volt lamp, it would quickly burn out if 12 volts were impressed across it. So the answer to the question is decidedly *no*.

AC and DC

The electrons which go to make up an electric current can flow either in one direction constantly, or they may move back and forth in the circuit. A current which always flows in one direction is called *direct current*. Current which flows first in one direction and then the other, back and forth, is known as *alternating current*. It is senseless to argue that one form of current is better than another, as Thomas Edison and George Westinghouse did many years ago, for each type has its special characteristics and important uses.

Because AC enables us to utilize the *transformer* effect shown in Fig. 5, in which a voltage may be stepped up or down without loss in power, it has largely supplanted DC for power transmission. But AC inherently also has other types of opposition to current flow in addition to resistance. These new opponents are *reactances*, and they may be either *inductive* or *capacitive*. The total opposition to current flow in an AC circuit, resulting from resistance, inductive reactance, and capacitive reactance is called *impedance*.

Westinghouse Electric Corp.

Sometimes it is desirable to convert AC to DC, as you did in Experiment No. 4, using a device called a *rectifier*. And sometimes it is necessary to convert DC to AC, in which case we use an *inverter*.

Although AC is the only type in which the electrons slow down to a halt, and then do an about face and head off in the other direction, the *rate* of flow of DC need not be constant. That is, the number of electrons passing a given point in a DC circuit may vary widely from moment to moment. If it does, the current is called *pulsating DC*.

It is important to understand this distinction, because the electron tube, which we study in the next chapter, is essentially a one-way device. This means that it will pass only AC. It may therefore be used as a rectifier, just like the semiconductor diode in Experiment No. 4. But when the tube is used as an amplifier of AC signals, it also converts them to pulsating DC. But we are getting ahead of our story. First we must learn something of the inner workings of the electron tube, the very cornerstone of the art of electronics. •

The heart of the first full-scale atomic-electric generating station in the U. S. The 58-ton, multi-million dollar nuclear core, or fuel charge, is lowered here into position with its precious fuel consisting of 14 tons natural uranium and 165 pounds highly enriched uranium. It is within this core that the "hot" nuclear reaction, or fission process, will take place when the Shipport atomic power plant goes into operation.

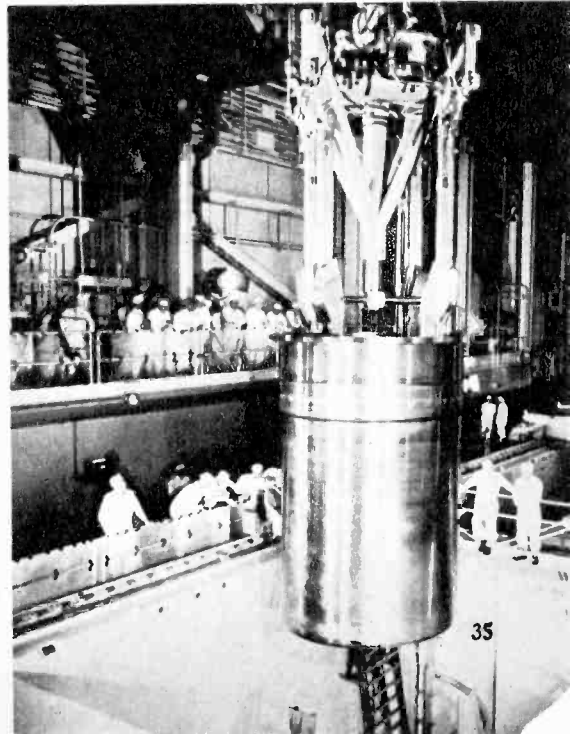

Chapter 3

THERE WAS LIGHT

The Edison Effect and the tubes it led to

THOMAS A. EDISON, the inventor of the electric light, made a very important contribution to the modern art of electronics way back in 1883. One might even say he *discovered* electronics. Only he didn't know it. And it was nearly a quarter century later before another man in another country suggested the possibility of using Edison's discovery in the then infant art of radio communication.

Edison's historic experiment is illustrated in Fig. 1. Using one of his ordinary carbon-filament light bulbs, he added a metal plate inside the same bulb, but separated from the filament. When the plate was connected to the positive terminal of the filament battery as shown, the meter pointer moved up. Apparently there was a flow of electric current right *through the empty space*, from the filament to the plate.

When the battery was disconnected from the plate, the current ceased. And when the plate was connected to the negative battery terminal, there still was no current flow. Obviously, current could flow in one

direction only in the bulb. From the heated filament to the positive plate, it traveled with the greatest of ease, but from plate to filament it was stopped cold.

The Diode Tube

Edison recorded his observations in his laboratory notebook, but made no effort to explain or use them. Neither did anyone else at the time. And there matters stood until 1905, when Prof. J. A. Fleming of London suggested a practical application. He proposed that a two-element tube or valve, based on the "Edison Effect," might be better than the galena crystal then used for the detection of radio waves. You'll learn more about crystal detectors in Chapter 4, when you actually build a crystal set (Experiment No. 7).

As for the "Fleming Valve," it is the basis of today's diode vacuum tube. Such a tube is shown in Fig. 2, where we see it is very similar to the experimental Edison bulb in Fig. 1. The two elements are still commonly called the filament and plate, or more correctly, the cathode and anode.

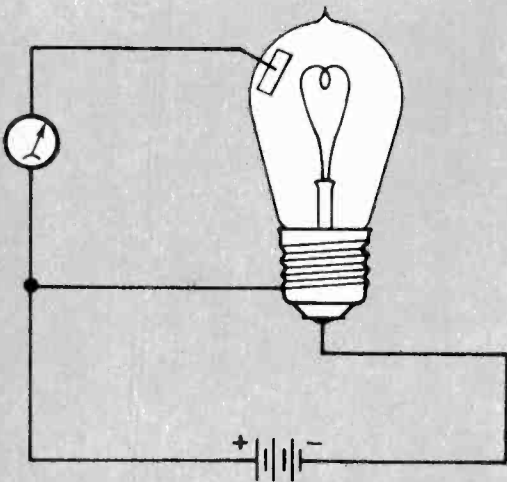

FIG. 1. A positive plate placed in an electric bulb will attract electrons from the filament.

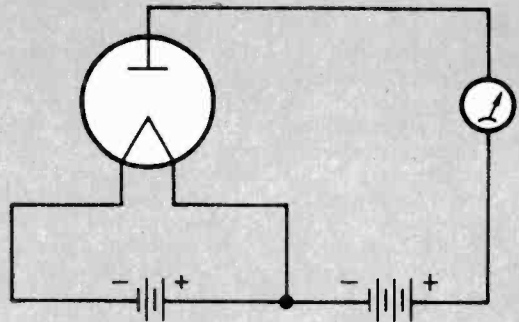
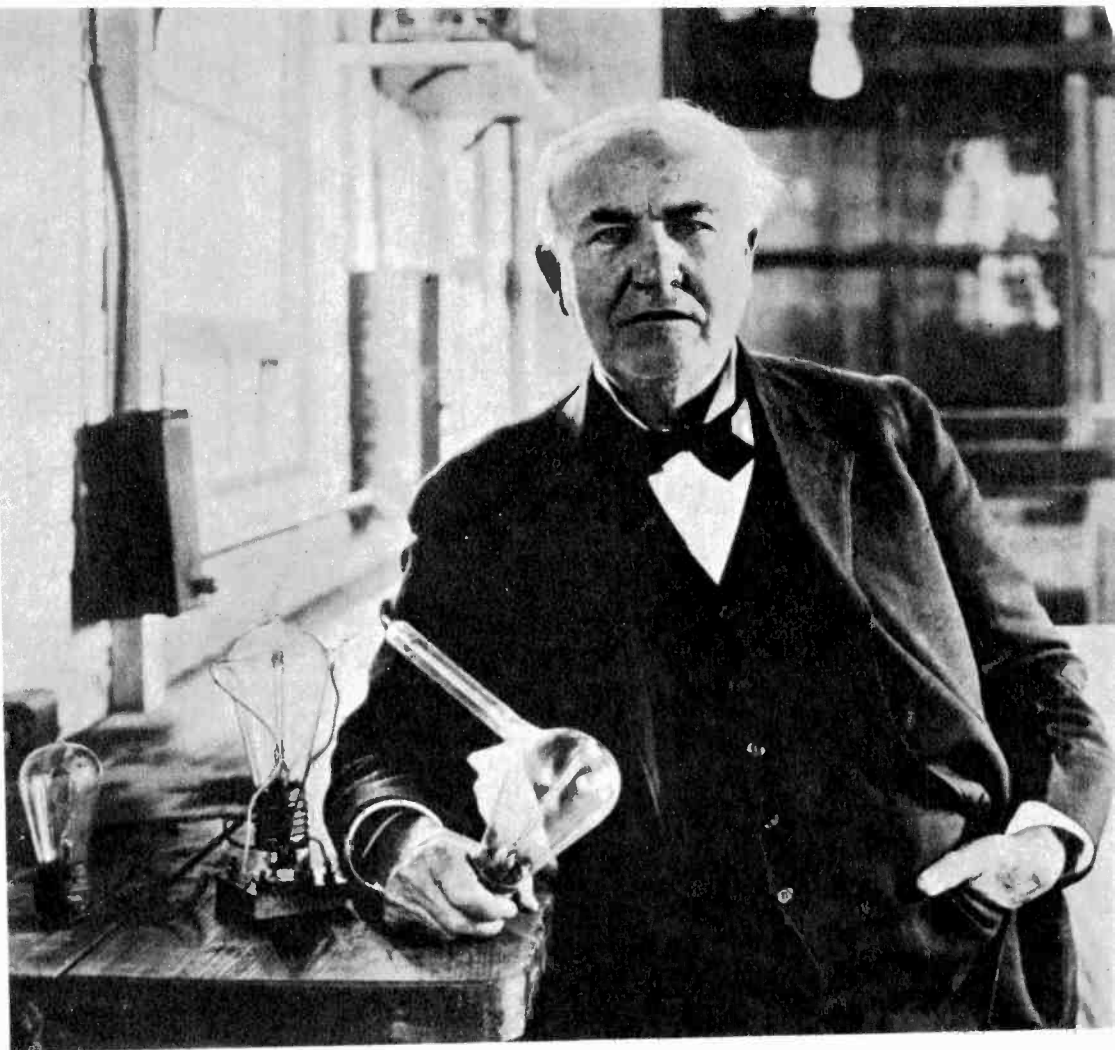

FIG. 2. Diode powered by two batteries; left one heats filament, right charges plate positively.



Edison Laboratory National Monument

Thomas A. Edison, after whom the Edison Effect is named, is shown in this photograph in his laboratory with some experimental light bulbs, rigged up to demonstrate filament-to-plate flow of electrons.

Most tubes today have more elements than just these two, but before we study them it is time for you to go "on the air," by building and operating your own radio broadcasting station. Details for doing this are described in Experiment No. 5.

The heart of your broadcast station is the transmitter, which generates radio energy and radiates it out into space. The radiation takes place through the antenna, but first the radio waves must be generated, and this is done by means of a tube. A four-element tube is used in your radio station, because it not only generates radio energy, but also superimposes sound signals on the radio waves. Let's consider those two actions separately, and begin by learning how a three-element *triode* tube can create radio energy.

Vacuum-Tube Oscillator

A tube which generates electrical vibrations is known as an *oscillator*, and one of the simplest types of these is shown in Fig. 3. When electrons flow from the cathode to the plate, they pass through the perforations in the third element, the *grid*. In the external circuit they must also pass through the feedback coil, L1.

The current through L1 develops a voltage in that coil, and by transformer action a voltage is also developed in the grid coil, L2. This voltage also appears then on the grid inside the tube, and this in turn alters the flow of electrons between cathode and plate.

The change in plate current flow will affect the voltage in L1, and also the voltage in L2, and the voltage on the grid. Thus we

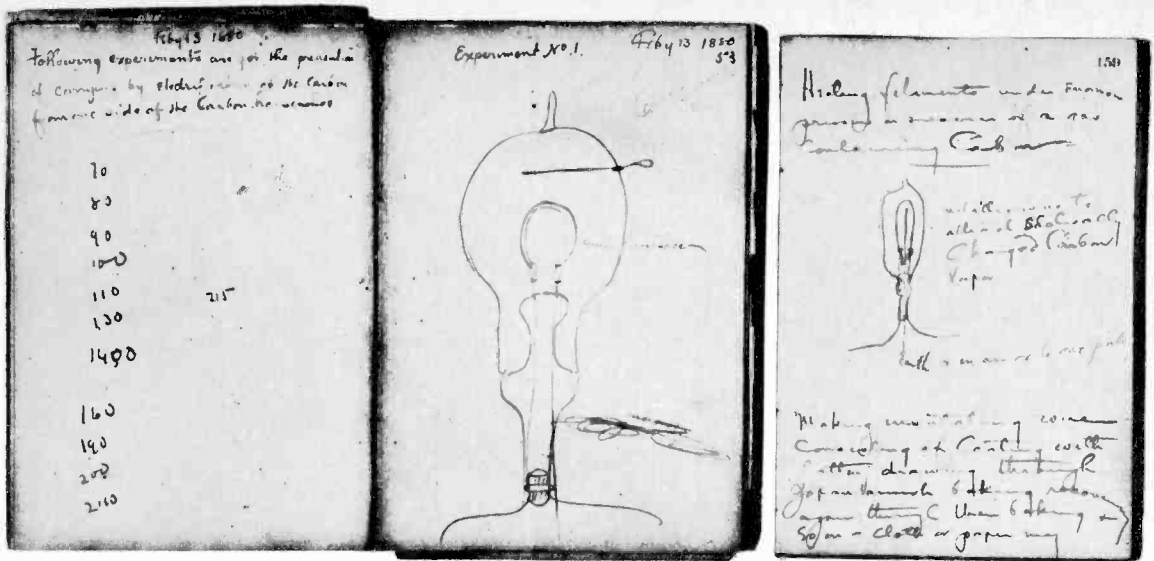

Above are some pages from Edison's notebooks dealing with the "Effect." Experiment No. 1, February 13, 1880, shows electric light bulb with metal pin inserted, similar to the drawing of Fig. 1, on page 36.

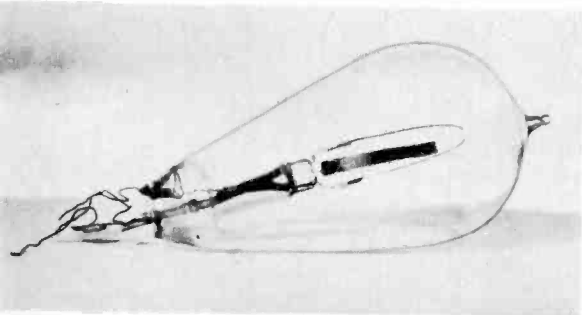

Edison Laboratory National Monument

Made by Edison, here is what was probably the first electron tube. Note metal plate inside the carbon-filament bulb separated from filament.

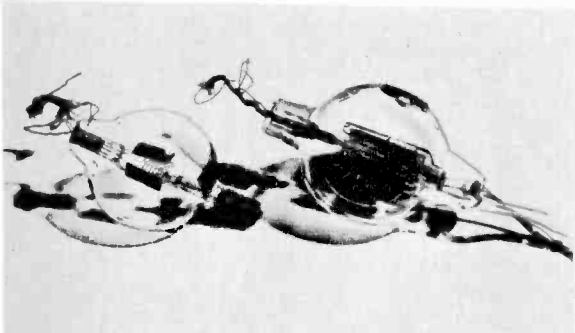

Bell Telephone Laboratories

DeForest's audion tube, developed in 1912, is shown at left. At right is the high-vacuum tube developed in 1913 for the telephone repeater.

have a sort of "perpetual motion" machine, in which energy is surging back and forth continually between plate and grid.

The purpose of capacitor C, is to help determine the number of vibrations or surges in each second, known as the *frequency*. Ordinarily the frequency of a broadcast station is fixed by law, and you tune your radio receiver to that frequency by varying a capacitor in the set. But in Experiment No. 5, you can also vary the frequency of your transmitter by the adjustment of C8.

The triode tube is useful not only as a generator of radio energy, but also as an *amplifier*. The basic construction of a triode is shown in Fig. 4. In the middle is the electron-emitting cathode, which may either be directly heated by current passing through it, or indirectly heated by a separate element as shown here.

Surrounding the cathode is the grid. This is usually a spiral winding of wire, whose turns are so spaced that the grid places almost no obstruction to the passage of electrons from cathode to plate. Outside the grid is the plate, usually a cylindrical shaped piece of metal. Electrical connection to all these elements is made through wires leading to the prongs in the base of the tube.

The Control Grid

The grid may be thought of as a trigger or gate, which can be varied electrically to control the electron flow between cathode and plate. For this reason, in tubes having more than two grids, this one is

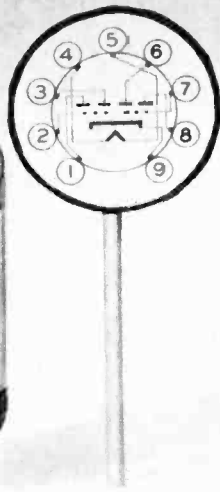

General Electric Co.
Modern "signal-splitting" twin triode receiving tube with four plates instead of two, performs the same function as two separate triode tubes.

known as the *control grid*. The unique value of this grid is the fact that any voltage change in the grid circuit will produce a much larger change in plate current than is possible with a large change in plate voltage. Thus a small change in the grid signal will cause a much larger change in the output, with the result that the tube is an amplifier of electrical energy.

The tube in your broadcast station of Experiment No. 5 is actually a four-element or *tetrode* type. But in this case it can be thought of as two triodes in the same enclosure, each sharing a common cathode and plate. Thus one triode acts as a radio generator, while the other triode acts as an audio amplifier of the microphone signals. Both the audio and the radio signals are combined in the plate circuit, and are together radiated from the antenna.

The triode is an excellent audio amplifier, but when used as a radio amplifier it often forgets that it is supposed to be an amplifier, and instead suddenly becomes an oscillator again. The result in a receiver is the loud howl or "peanut whistle" so familiar to old-time radio fans.

The villains are a trio of rascals having the lengthy name of *interelectrode capacitance*. They are shown schematically in Fig. 5. Each of the tube elements acts as the plate of a capacitor, with the "dielectric" between the plates being the vacuum within the tube. At low and medium frequencies, the reactance (opposition to current flow) of these little capacitors is so

[Continued on page 42]

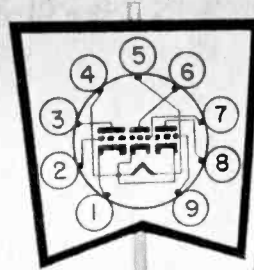

General Electric Co.
This miniature tube, 6EZ8, is a triple triode with three cathodes, can be used as RF amplifier, oscillator and mixer in a single compact unit.

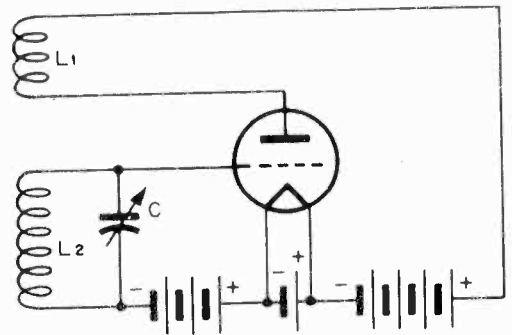

FIG. 3. The triode tube may be used as an oscillator. Above is a simple feedback type using the transformer effect between coils L_1 and L_2 .

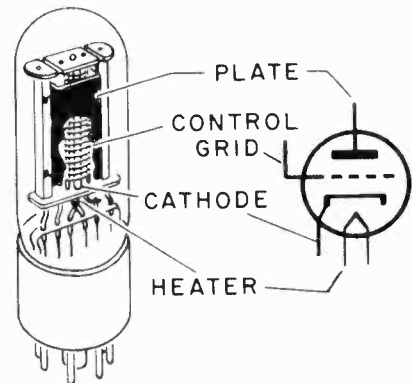
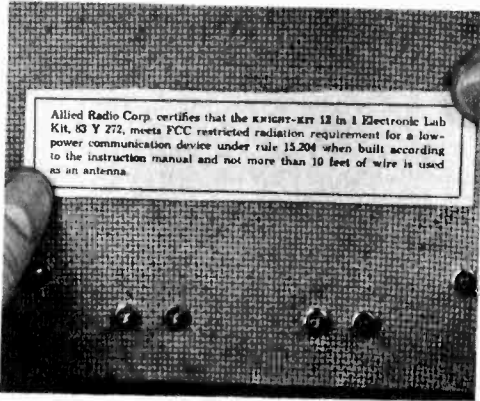

FIG. 4. Triode construction and schematic symbol.

EXPERIMENT 5

Building a Radio Transmitter



Post legal notice on transmitter; showing it meets rigid Federal Communications Commission's rules.



Now you're on the air, broadcasting your voice without wires, heard on your standard AM radio.

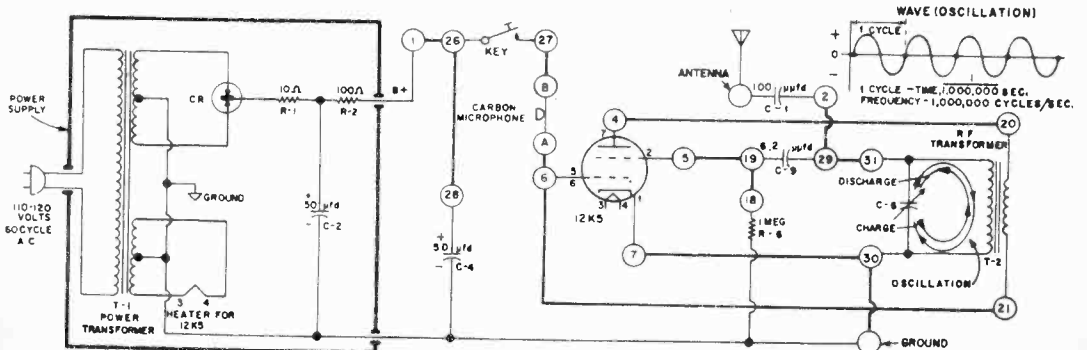
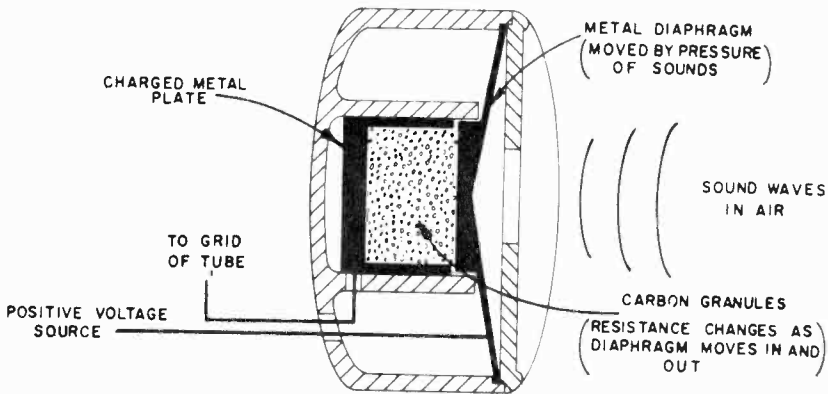

YOU have already built a radio code transmitter in Experiment No. 1. Now let's graduate to an amplitude-modulated (AM) transmitter, on which you can broadcast the sound of your own voice.

The radio-frequency part of the AM transmitter is similar to that of your code set. Although it uses a tube instead of a transistor, the principle of inductive feedback is used, through transformer T_2 . But whereas the code transmitter used varying inductance for tuning, this time capacitor C_5 is varied to set the transmitter on channel.

This capacitor will tune the transmitter anywhere between 700 and 1,300 kc, which is most of the upper end of the standard broadcast band. To tune the transmitter, first turn on a receiver and tune it to some quiet spot between 700 and 1,300. Then depress the key on the transmitter and adjust C_6 until a whistle is heard on the set. Then further adjust C_5 carefully until the pitch of

the whistle drops to inaudibility. Now you are ready to broadcast.

The vibrations in air which are set up by your vocal cords are converted to electronic signals by the microphone. This is the same type as is used on the mouthpiece of a telephone. As the drawing shows, the main parts of the mike are two charged metal plates (electrodes) which contain a loosely packed collection of carbon granules.

While the normal resistance of these granules is around 500 ohms, it can drop to as low as 50 when they are packed together more tightly as a result of air pressure on the diaphragm. Since voltage is connected across the microphone electrodes, the varying resistance will result in a varying current.

When someone talks into the microphone, this signal is applied directly to the first grid of the tube. The plate current is therefore varied not only in accordance with the r-f oscillations, but also with the sound signal on the control grid.

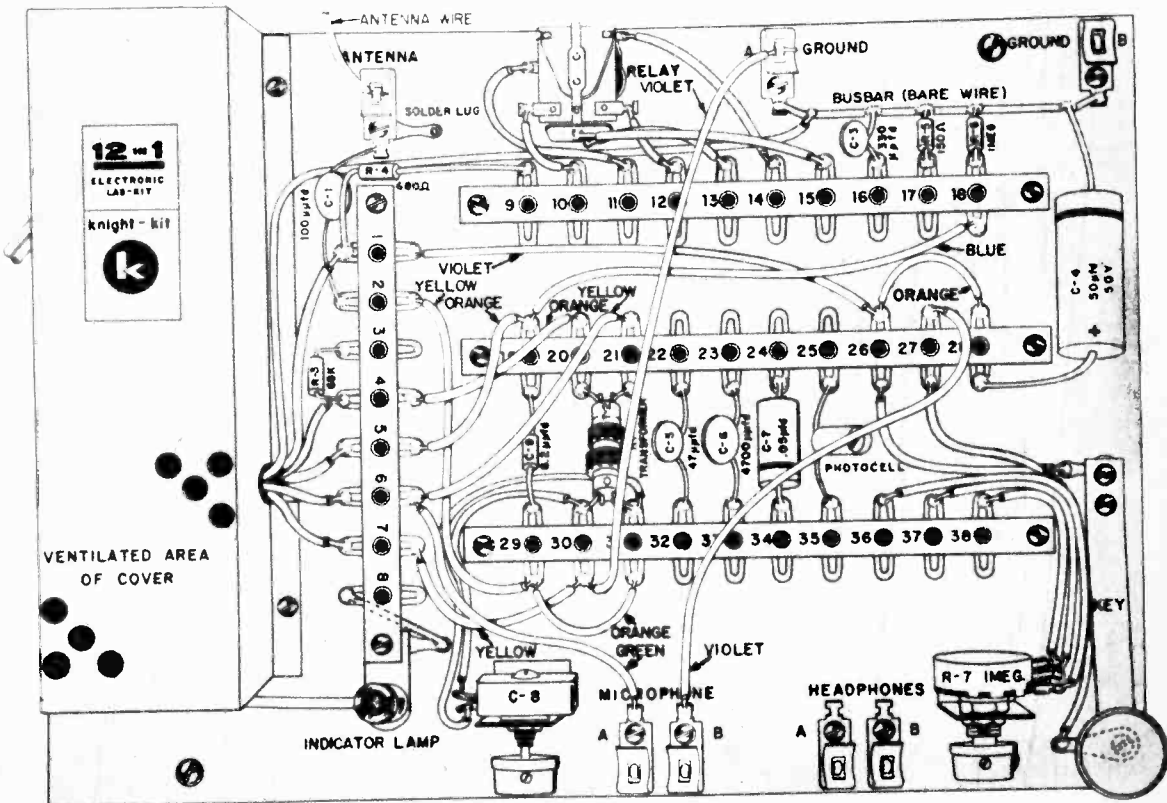



Westinghouse Electric Corp.

Light image intensifier tube produces an image of reduced size with a brightness increase of 1,000 times for 2,870-degree Kelvin temperature.



Westinghouse Electric Corp.

This five-inch cathode-ray tube can be used as flying spot scanner in video-signal generator. Nearly 1,000 lines can be resolved over tube face.

[Continued from page 39]

high that they pose no serious problem.

But at the higher frequencies these capacitors act almost like short circuits, that is, direct electrical connections. Thus the capacitance between plate and grid, C_{pg} in Fig. 5, will permit direct feedback between plate and grid, without bothering with the external feedback coil used in Fig. 3. This is very fine if we want an oscillator, and the principle is actually used in the tuned-plate tuned-grid oscillator, but it makes the triode almost useless as a high-frequency amplifier.

Space Charge

Another phenomenon in the triode is the *space charge*. When the cathode emits electrons, not all of them get all the way to the plate. Some will remain in a crowd immediately surrounding the cathode, where they will tend to repel other electrons as they try to get to the plate.

The net effect of the space charge then is to reduce the flow of electrons between cathode and plate. Just how effective it may be depends largely on the amount of positive "pull" attracting the electrons in the tube. In the tetrode we get more of this pull by adding a second grid which, like the plate, also has a positive voltage.

The arrangement of the elements in the tetrode is shown in Fig. 6. The construction is very similar to that of the triode of Fig. 4, except that an additional grid appears between the control grid and the plate. This *screen grid* acts as an "electrostatic shield" between grid and plate. A positive voltage is maintained on the screen—though often less than on the plate—but as far as radio frequencies are concerned, the screen is connected directly to ground.

This apparently contradictory statement is a concept which turns up again and again in electronic design, so we'd better take time to give it a closer look. It can be understood better by reference to the typical tetrode amplifier circuit of Fig. 7. Note that any current flowing out of the tube from the screen grid meets a "fork in the road." It can go either to the screen voltage supply, or through the screen capacitor to ground.

Direct current cannot pass a capacitor, however, so any DC must follow the right leg to the power supply. Radio frequencies, on the other hand, can follow either course. Now the by-pass capacitor has such a value that its opposition to the flow of radio-frequency current is practically nil. The RF therefore takes "the path of least resistance" and flows directly to ground.



General Electric Co.

As clean as a hospital operating room is the controlled atmosphere area in this power tube plant. Access is through a double airlock; air is filtered to keep out dust, lint and foreign matter of a size down to 1/250,000th inch diameter. Workers wear lint-free garments, hair and finger coverings.

Secondary Emission

Adding the screen grid effectively prevents and RF amplifier from slipping into oscillation accidentally, but it also introduces another interesting phenomenon which is not always desirable. If electrons arriving at the plate from the cathode strike the plate with sufficient force, other electrons loosely held in the plate material may be knocked free, out into the space between screen and plate. Electrons emitted in this manner are known as *secondary electrons*. These electrons may then come under the influence of the voltage on the screen and be attracted there instead. The screen current will therefore increase while the plate current decreases. Here is a case where the solution to one problem creates another, for while secondary emission undoubtedly exists also in diodes and triodes, in these tubes it has no undesirable effects.

There are a full half-dozen different electron actions in the tetrode, as shown in Fig. 8(A). When an electron is emitted from the cathode, any of these things may happen to it:

1. Remain suspended in the space charge surrounding the cathode.
2. Be repelled by the negative control grid.

3. Strike the screen grid and form part of the screen current.
4. Strike the plate and become part of the plate current.
5. Strike the plate and dislodge secondary electrons.

And this secondary emission of item 5 sets up a reverse current:

6. Flow from plate to screen grid and add to the screen current.

This reverse current results in a lowering of the efficiency of the tube as an amplifier, for this current in effect subtracts from the normal plate current flow and thus limits the overall voltage amplification of the tube. It may also cause the tube to be erratic in operation and make for distortion.

Suppressor Grid

The most common cure for this problem is an additional grid, known as the *suppressor*, placed between the plate and screen. The suppressor is connected directly to the cathode, often inside the tube itself. The voltage on the suppressor is therefore negative with respect to the plate.

Now the electron action within the tube is a little different, as shown in Fig. 8(B). The first five types of movement are the

[Continued on page 46]

EXPERIMENT 6

Building a Photocell Relay

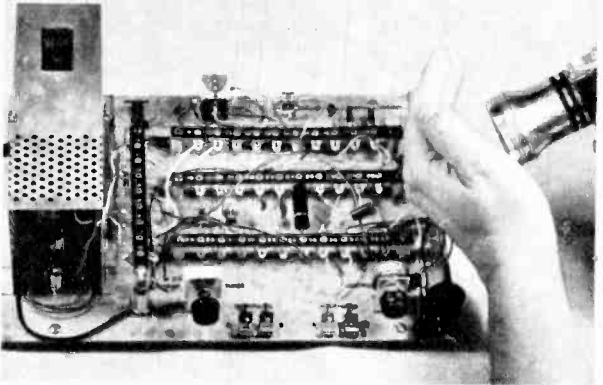
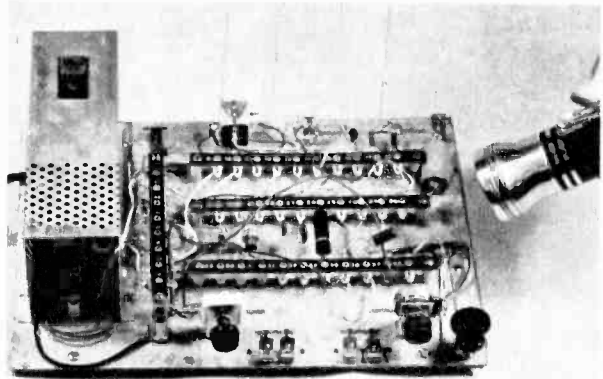
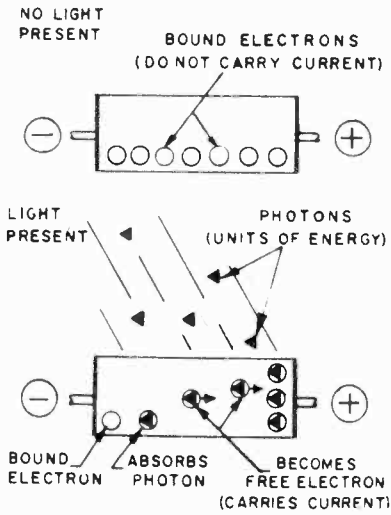

Flashlight or pilot light, take your choice. When flash is aimed at photocell (top right), its resistance drops enough to actuate relay and turn off pilot lamp. When beam from flashlight is cut off (photo right) pilot lamp goes on again.

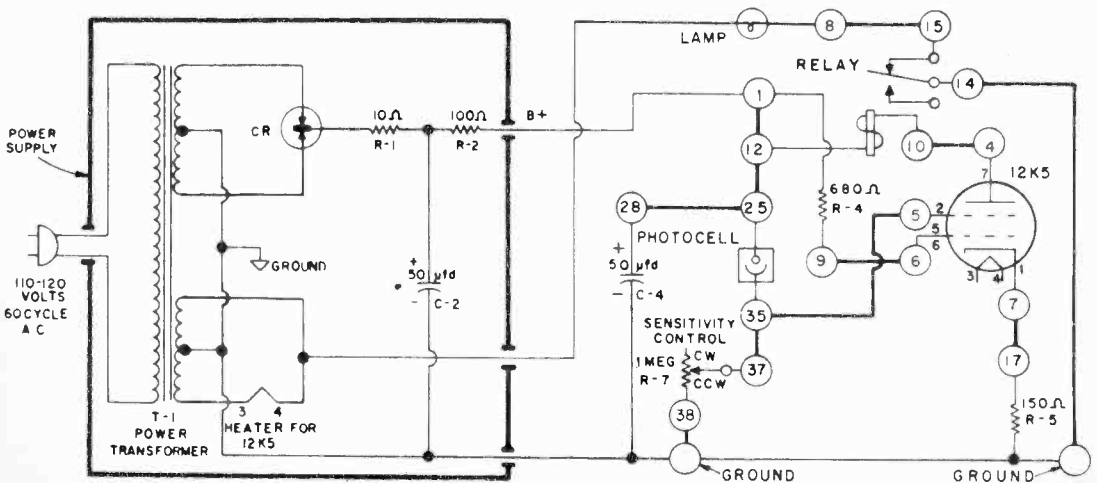

WHEREAS the microphone in the preceding experiment had its resistance varied in the presence of a sound wave, the photo-conductive cell in this circuit shows a varying resistance in the presence of light.

Referring to the drawing, when light strikes the photocell, some of the electrons within the cell absorb energy from the light. This additional "kick" is sufficient to free some of the electrons from their orbits, and if a voltage is applied these electrons will drift toward the positive terminal. The result is an electron current.

Since the current increases, the effect is the same as if the resistance decreased. In darkness at room temperature the resistance of this cell is around 100,000 megohms (millions of ohms). But in strong light this resistance falls to as low as 1/100 megohm.

When the photocell resistance is high (no light), this resistance is between grid 2 and the B+ voltage. The result is that the voltage on grid 2

is small, and actually negative with respect to the cathode. Under these circumstances little or no plate current will flow, the relay is not energized, and the indicating lamp stays lit.

But when light shines on the photocell, the resistance drops to a low value, permitting more of the B+ voltage to be applied to grid 2. This in turn causes the plate current to increase, to the point where the relay contacts flop over.

Sensitivity of the circuit is determined by the setting of R₁. The higher its clockwise setting, the higher the voltage applied to grid 2. Less light therefore will be needed to make the tube conduct and actuate the relay.

To use the relay, aim a beam of light at the cell and slowly turn R₁ clockwise until the relay pulls in and the indicator lamp goes out. Then when the light beam is stopped off, the lamp should go on again. The relay contacts may also connect to an external circuit.

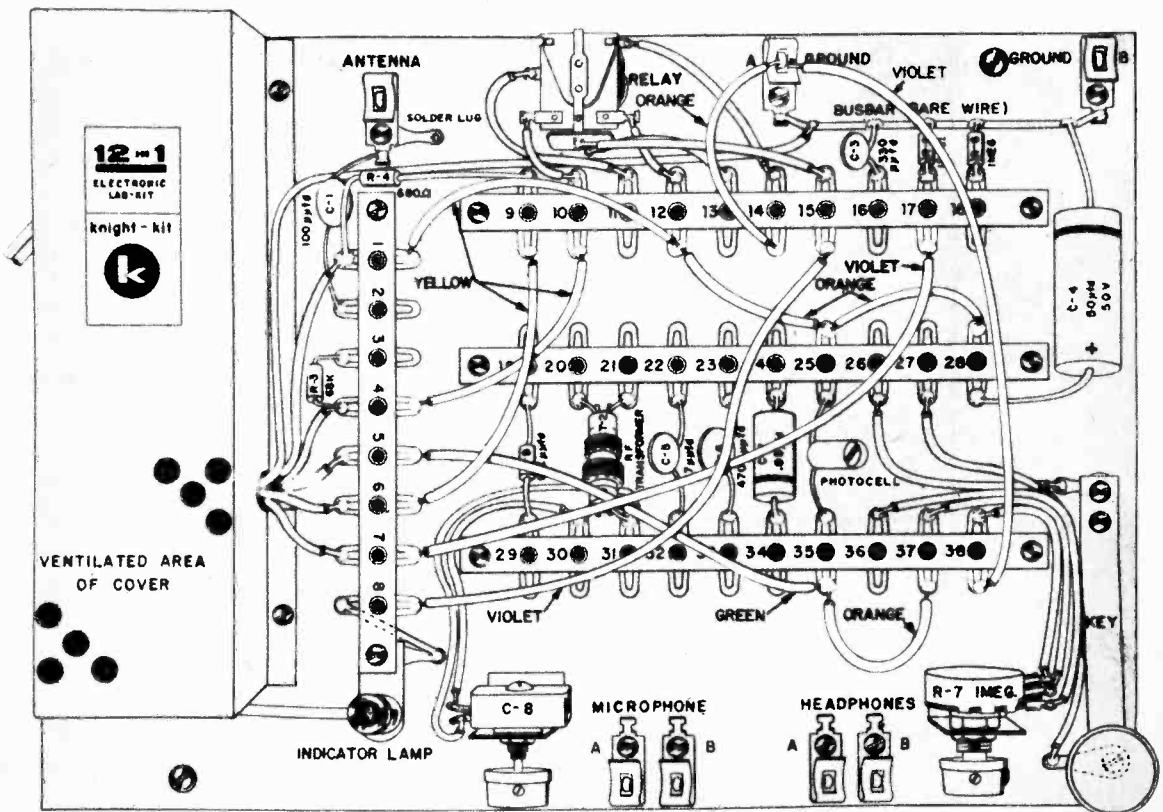

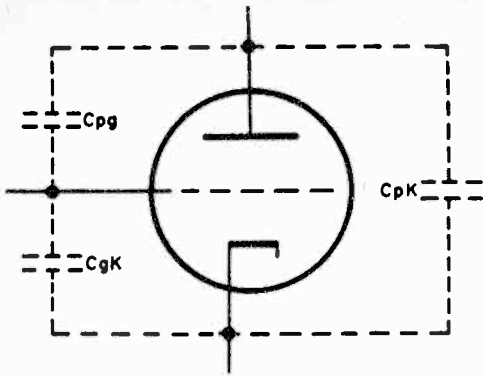

FIG. 5. A triode has capacitance between its internal elements, indicated here by broken line.

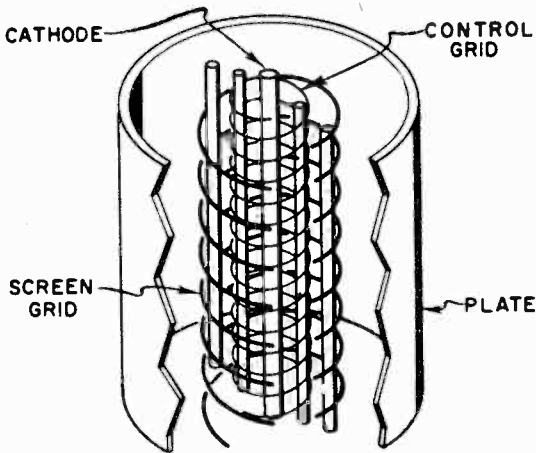

FIG. 6. Internal construction of the tetrode tube. Electrons from the cathode travel through the control grid, to the screen grid, and then to plate.

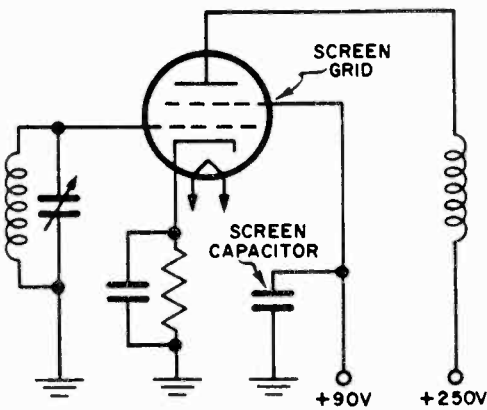

FIG. 7. Screen grid in the tetrode tube reduces interelectrode capacitance by a shielding effect.

[Continued from page 43]

same as in the tetrode, but item 6 now becomes:

6. Secondary electrons are repelled by the suppressor and return to the plate.

Another method for eliminating the undesirable effects of secondary emission is space-charge suppression, in which an electron beam provides the negative force for repelling secondary electrons back to the plate. This method is employed in the beam power tube, of which the 6L6 is the classic example. The internal structure of this tube is shown in Fig. 9.

As the drawing shows, the beam power tube has a cathode of flat cross section, surrounded by two oval-shaped grids. The two grids have exactly the same number of turns. In construction they are lined up directly opposite one another, so that as far as the electron stream is concerned, the screen grid is in the shadow of the control grid.

Two solid metallic beam-forming plates are placed at the ends of the grid structures and electrically connected to the cathode. They should not be thought of as the equivalent of a suppressor grid, however, as the principle is quite different. Nor should they be confused with the anode plate, which is circular in shape in the region where it is struck by the electron beam.

As the electrons are emitted from the flat cathode, they are naturally attracted by the positive charges of the screen and plate. But instead of scattering in all directions as in other tubes, they are confined to two wedge-shaped beams by the electrostatic effect of the end plates.

These two beams, which are emitted from opposite faces of the cathode, are composed of a series of lateral "sheets" of electrons, formed as they stream through the spaces between the in-line grid and screen wires. Because of the very high speed of the electron beam, plus the fact that the screen grid is effectively "shaded" by the control grid, nearly all the electrons fly right on by the screen. Thus the screen current is quite small, even though the screen voltage may equal or even exceed the plate voltage.

Voltage Drops

When the plate voltage drops below the screen voltage, here is where we run into trouble from secondary emission in the tetrode, and where space-charge suppression is most effective in the beam tube. To understand this, we must first consider what causes the variation in plate voltage.

The amplified plate current signal is

useful only if it is used to develop a voltage across a suitable *load* device, such as a resistor, coil or transformer. But this voltage drop across the load acts against the DC plate supply. That is, the voltage applied to the plate at any moment is the supply voltage *less* the drop across the load. And since this drop will be constantly varying as the plate current varies, so, too, will the actual voltage on the plate be changing similarly.

Although there are ways of minimizing this effect, in power tubes especially it is desirable that the plate be able to go through wide voltage swings without distortion. At the same time, the screen grid is most effective in doing its job when its voltage is as high as possible. So it is inevitable that at times the plate voltage will swing below the screen potential.

It is at these times that the screen grid in the tetrode is most active in drawing off the secondary electrons and adding them into the screen current. But in the beam power tube quite a different phenomenon occurs. Here a space charge is set up between the plate and screen, to form an electron barrier against the secondary electrons.

As the electron beam moves out of the region of the screen, it slows down when the plate voltage is less than the screen voltage. There is then a low-velocity region between screen and plate, where the electrons pile up into a high-density space charge. This region is shown by the heavy dashed lines between screen grid and plate in Fig. 9. And since electrons themselves are negative charges, this dense space charge cloud is intense enough to repel the secondary electrons back to the plate where they belong.

Both pentodes and beam tubes have greater output, sensitivity and efficiency, as compared to tetrodes. As a result, they are used extensively for audio amplification, and almost exclusively for video and radio applications.

Photoelectric Cells

The photocell relay of Experiment No. 6 is an interesting application of photoelectric principles. Photocells are special types of tubes, quite different in their behavior from the electron tubes we have been studying. There are three basic types of cells. The *photo-conductive* cell, which is the type used in Experiment No. 6, changes its resistance to the flow of current as the amount of light falling on it is varied. The *photo-voltiac* cell generates a voltage across its terminals when its face is struck by light. The *photo-emissive* cell is similar

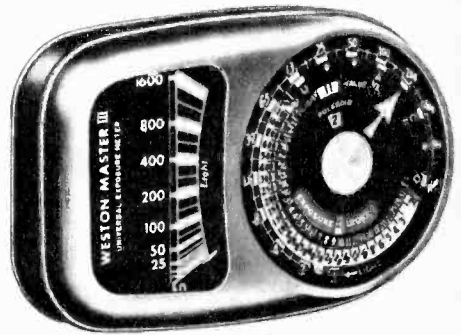
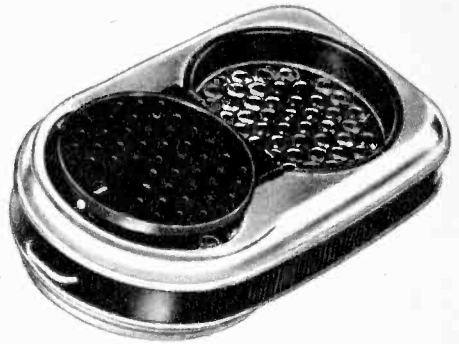

Weston Instruments

Front and rear view of photographic exposure meter shows, top, the rear hinged baffle which opens to admit extra light to photocell. Closed baffle admits light through holes in strong sunlight.

Diagram below shows function of photocell in light meter. Light striking cell acts on the indicator needle which registers on value scale.

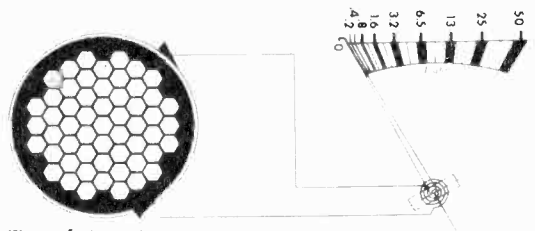

Weston Instruments

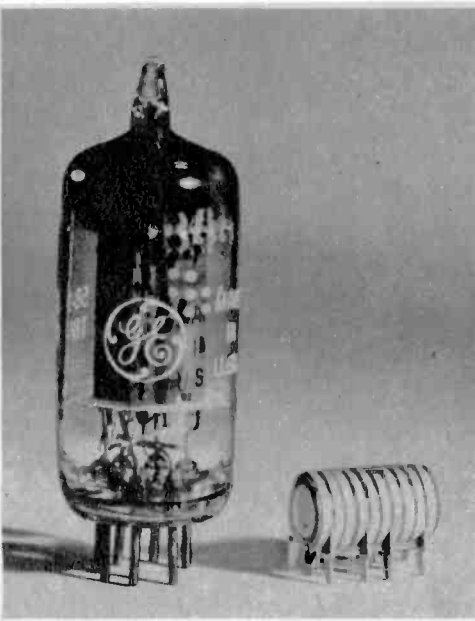

General Electric Co.

Ceramic circuits, "TIMMs," for space electronics, include vacuum tubes, resistors and capacitors. Photo shows comparison with standard tube.

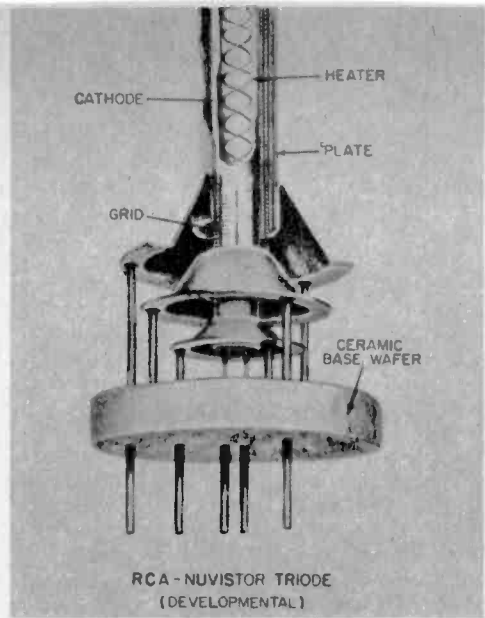

Radio Corp. of America

The Nuvistor uses ceramic wafer platform supporting an array of electrodes, is about 1/10th size of regular tube. The triode is shown above.

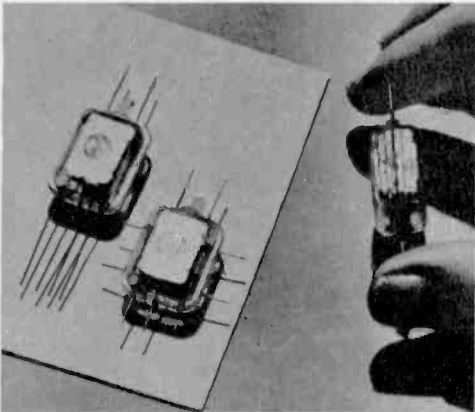

Westinghouse Electric Corp.

"Match Box" tube envelope, a new design, will probably result in improved circuits. Tube stem is eliminated and all leads are in one plane.

"Stacked-tubes-in-glass," shown here without glass envelope, feature all elements around one axis, with ceramic spacers replacing mica. Sylvania Electric Co.

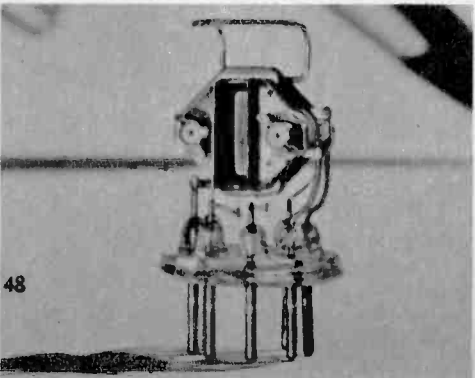

to a diode vacuum tube, except that its cathode emits electrons when it is struck by light, rather than heat as in conventional tubes.

The most common use of the photo-conductive cell is in a relay circuit as in Experiment No. 6. The relay can be used to control a warning device, or to operate an electric motor, as in a garage door opener. It is also an integral part of some types of color-matching instruments.

A very familiar application of the photo-voltic cell is as a light meter. The photographer's exposure meter is an excellent example of this. Another is in the control of automatic wrapping machinery. Guide marks on the edges of the paper coming off of huge rolls are "read" by the cell, which in turn tells the shears when to cut. The resulting wrapper is then exactly the right size, with the cut at the edge of the printing, not through the middle of it.

Although magnetic sound recording has made great inroads in the motion picture field, the original system of photographing a varying light beam is still widely used. This optical track is invariably scanned by a photo-emissive cell in the projector.

A fixed light shines on the cell through the sound track on the film as the film passes through the projector. As either the area or the density of the track varies, so

will the emission of the tube. Hence the output current of the tube will vary at an audio rate, exactly in accordance with the signal recorded on the film.

The TV Camera

Another interesting application of photo-emissive principles is in the television camera. This instrument has an optical system just like any ordinary camera, but its image surface, instead of being a piece of sensitized film, is instead a mosaic comprising many thousands of photo-emissive "globules."

Each of these globules will emit electrons, the amount of emission depending upon the brightness of the light striking them. The electrical state of each of these globules is then "read" one by one, and a video signal voltage thereby developed. When this signal is superimposed on a radio signal, it goes out on the air as the picture part of a television program.

At the receiving end we need another type of beam tube to perform the inverse procedure. That is, the picture tube in our TV set must reconvert electrical signals back into light. The correct name for this device is the *cathode-ray tube*.

This tube has three basic components. The *electron gun* produces an electron stream, accelerates it, and focuses it into a narrow beam. It usually comprises a cathode, control grid, an accelerating elec-

trode, a focusing electrode, and finally another accelerating electrode. Thus it is not too unlike the tubes we have already studied.

But the cathode ray tube also requires a *deflection system*, which permits the beam to move around, just as a searchlight beam scans the skies. Finally, the CRT has a *screen*, which lights up whenever the beam strikes it.

The brightness of the light spot on the face of the tube is controlled by the video signal received from the transmitter and applied to the control grid. When the grid is made more negative than normal, the spot dims, while a positive-going signal will increase the brightness.

At the same time, the spot sweeps back and forth across the tube so fast that it seems to cover the entire face of the tube at once. The formation of the picture is therefore the result of the combination of signals which position the spot at any instant, and give it the correct brightness at that same instant.

Cathode-ray tubes are also extensively used in electronic instruments for measurement and analysis of electric waves. The television color tube is essentially three tubes in one, with three electron guns and deflection systems, and with a single screen which will glow in any of the three primary colors, depending upon the angle from which the beam strikes. •

FIG. 8. Comparison of the electron flow in the tetrode tube (A) and pentode tube, with its added suppressor (B). See text for detailed account.

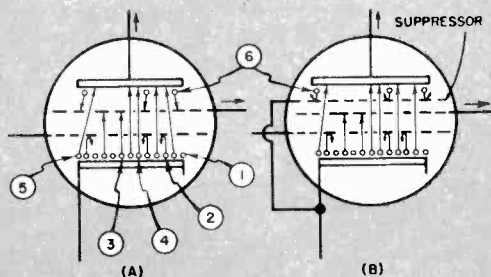
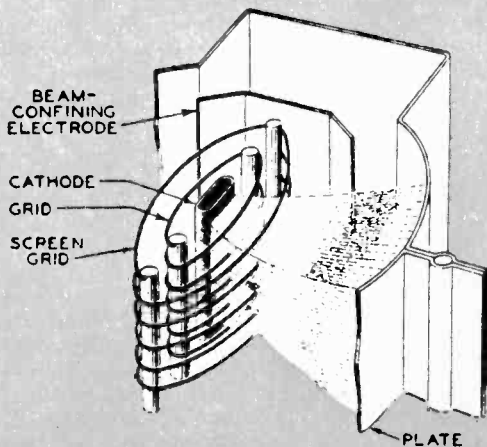

FIG. 9. In a beam power tube sheets of electrons travel to the plate from the cathode in center.



Chapter 4

TUBELESS TUBES

Transistors and other semiconductors

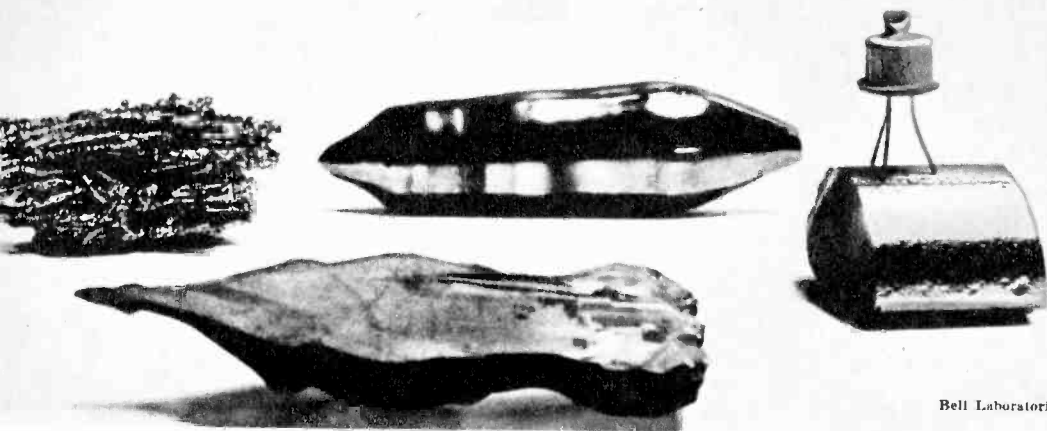

Bell Laboratories

USEFUL as electron tubes are, they are not essential to the successful operation of electronic devices. Indeed, probably the very first radio receiver in your home was a *crystal set*, with no tubes at all. If crystal sets were before your time, you can go back to this romantic era of radio history simply by performing Experiment No. 7, where you actually build a crystal radio set.

The crystal used in your radio is *galena*, an ore of lead, but as we shall see many other crystalline materials are now used in electronics. All of these substances have one thing in common: their molecules are always confined to a definite small space relative to their neighboring molecules. For purposes of visualizing what goes on inside these crystals, they are often represented as comprising a lattice-like form. Other substances, which have no regularly spaced lattice are called *amorphous*.

Semiconductors

Another thing which many of these crystalline substances have in common is the fact that electrically they are *semi-conductors*. As we learned previously, there are no perfect conductors and no perfect insulators. But until fairly recently, most of the materials involved in electronic current flow have been close to one of these two extremes. Now, out in the middle somewhere, we find semiconductors, which are neither good conductors nor good

insulators. But they have other qualities which make them remarkably useful for electronic applications.

With these applications, research into still others has proceeded, to rapidly accelerate the growth of that branch of science known as solid-state physics. For in crystalline semiconductor materials, unlike tubes in which electrons flow through a vacuum or gas, the flow of electrons takes place through a solid substance. This in itself isn't new, of course. It happens every day in metallic conductors. But the way in which it happens in semiconducting materials is quite a different story.

Two of the materials most commonly used for electronic semiconductors are *germanium* and *silicon*. These are both chemical elements, and what's more, in their pure state each of them is a very poor conductor. It is only after deliberate *doping* with an impurity that they take on their rather marvelous semiconducting properties.

You will recall from Chapter 2 that the electrons in the outermost shell of the atom are the ones which may be freed to form an electric current. In the case of germanium, there are four electrons in this outer shell. To simplify our discussion, we will ignore those in the inner shells, and simply regard the germanium atom as comprising a nucleus of four protons surrounded by four electrons.

FIG. 1. Germanium crystal structure. Pure germanium is theoretically a perfect insulator because of powerful bond between outer electrons.

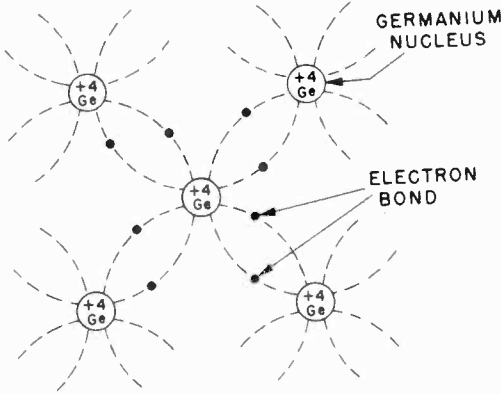

Left. Arrangement of atoms in silicon is background for refined silicon and variously shaped ingots of silicon. Transistor sits atop ingot.

The Crystal Lattice

Now, since germanium is normally a crystal, its atoms assume the lattice structure shown in simplified form in Fig. 1. Here we see that adjacent atoms share each other's outershell electrons, to tie the whole structure together in a strong cohesive bond. If this bond were absolutely perfect, there would be no free electrons available, and germanium would be a perfect insulator. As a practical matter, heat energy will occasionally dislodge a few electrons, but it takes more than this to achieve the semiconducting properties that we want.

Suppose that we dope the germanium with a controlled quantity of another element having five electrons in its outer shell. Either antimony or arsenic will fill the bill. The fifth electron has no place in the tight structure of Fig. 1, but is free to roam at will. That is, it's a *free electron*.

The structure of Fig. 1 is then modified to appear as in Fig. 2. Now each arsenic atom becomes a *donor* of one free electron. When a voltage is applied across this crystal, there will be a flow of free electrons through the circuit. Thus the external behavior of the doped germanium is the same as with any conductor. The current flow is made up of free electrons, or negative charges. The germanium is therefore known as *N-type*.

You might infer from this that there is another type of doped germanium, in

FIG. 2. When germanium is doped with a valence-5 material, an electron flow can take place as is the case in an ordinary electron conductor.

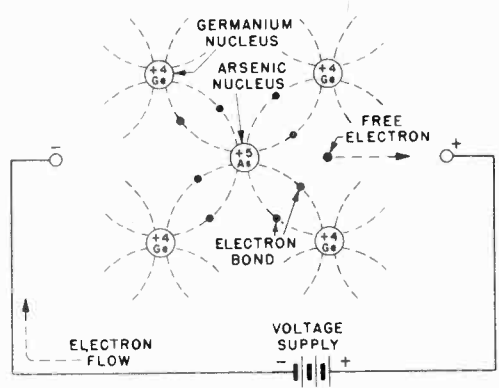
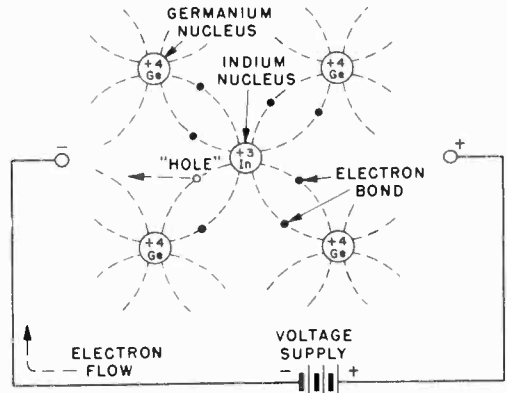

FIG. 3. When germanium is doped with a valence-3 material, the electron flow is effected by the movement of "holes" toward negative terminal.



Drs. W. Shockley, W. H. Brattain and J. Bardeen, were awarded the 1956 Nobel Prize in Physics for their invention of the transistor. They are shown with model of semiconductor crystal.

Bell Laboratories



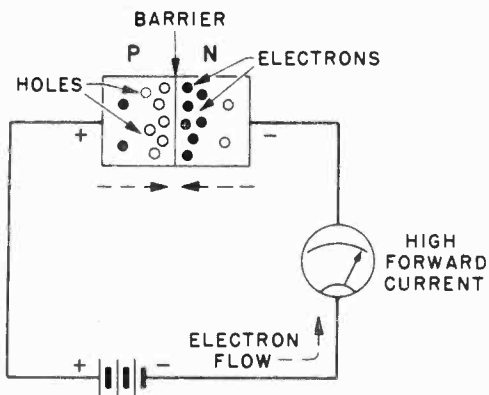

FIG. 4. When voltage of correct polarity is applied across P-N junction, current flows in external circuit from P layer around to N section.

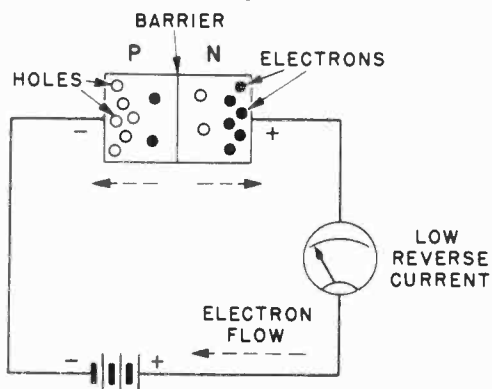

FIG. 5. When the voltage is reversed, with the negative terminal to P and the positive to N, the resulting current flow will be almost zero.

which there is a flow of positive particles, and which might be known as P-type. And astonishingly enough, you'd be very nearly right. Suppose now that we dope pure germanium with a material having only three electrons in its outer shell, one less than the germanium atoms have. Gallium or indium will serve this purpose very well.

Positive Holes

Using indium, as in Fig. 3, we see that one of the electron bonds around each indium atom has an electron missing. As compared with the ideal structure of Fig. 1, there is now a "hole." But since a deficiency of electrons indicates a positive charge, this is the condition of the germanium with the indium impurity. Going even further, however, the "hole" in the lattice acts just like a real positively charged particle when a voltage is applied across the crystal.

Referring again to Fig. 3, when the voltage is applied, stresses are formed which encourage electrons within the crystal to move in the direction of the positive terminal by jumping into the holes in the structure. But since there are simply no free electrons available, this means that more holes open up near the positive terminal. Thus, while the electrons tend to move toward the positive terminal, the holes in effect are simultaneously moving toward the negative terminal.

Now we have an excess of electrons near the positive terminal and a deficiency of electrons near the negative terminal. This is the classic condition for the flow of an electric current through the external cir-

CRYSTAL STRUCTURE MODELS

Bell Laboratories

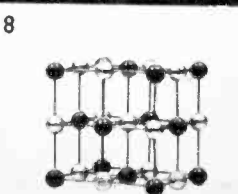
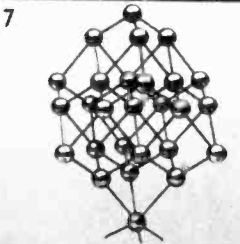
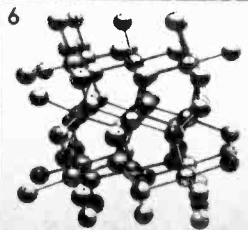
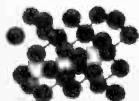
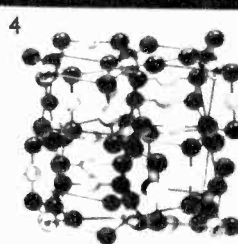
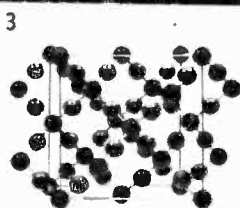
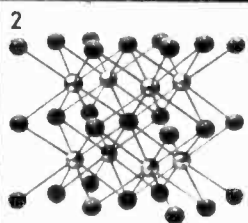
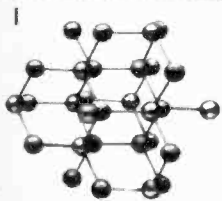

cuit, and such a flow does in fact take place.

Loosely held electrons, which had recently filled holes near the positive terminal, enter the external circuit. New holes are thus created, which in turn are filled as deficient indium atoms near the positive terminal and rob their neighbors which are closer to the negative terminal. As the holes reach that terminal, meanwhile, they are filled by electrons entering from the external circuit. The current flow may thus be thought of as the movement of holes from negative to positive within the crystal, and of electrons from negative to positive in the external circuit.

The indium atoms which are constantly stealing from their wealthier germanium neighbors are called *acceptors*. A crystal doped in this fashion is called a *P*-type, for although there is no actual movement of positive charges, the holes act just as if they were protons in motion. Current flow by means of holes in *P*-type crystals occurs at a much slower rate than that by means of electron movement in *N*-types, but it does occur nevertheless.

Two-Way Conduction

If we reverse the polarities of the batteries in Figs. 2 or 3, current flow will continue as before, but in opposite direction. Rate of flow will be essentially unchanged.

Aside from the rather unique behavior of electron flow by hole conduction through *P*-type crystals, we haven't as yet accomplished anything very useful. The usefulness of semiconductors becomes apparent only when we can also give them *rectifying* properties (see Experiment No. 4).

[Continued on page 56]

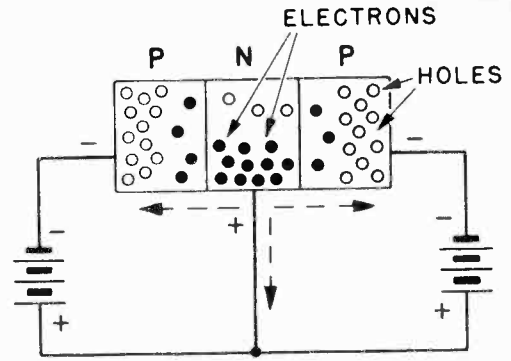

FIG. 6. With negative voltages on both the *P* sections of the *P*-*N*-*P* transistor, there will not be any current flow except for an initial surge. (See text.)

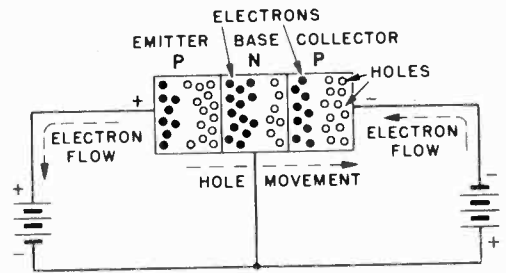
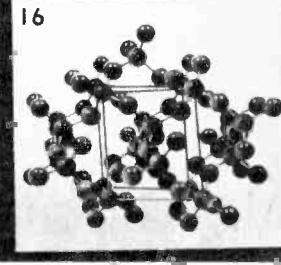
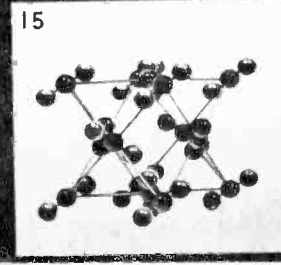
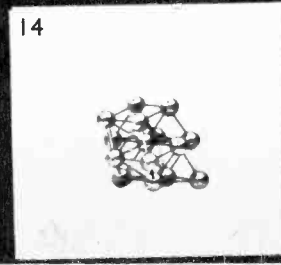
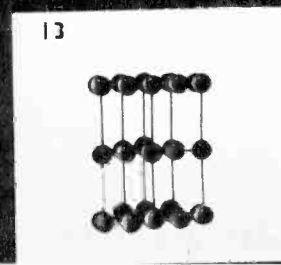
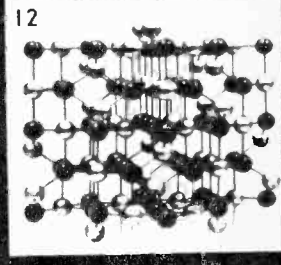
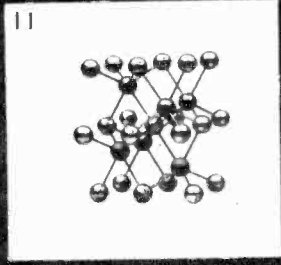
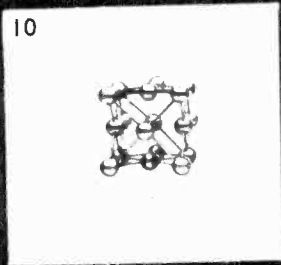
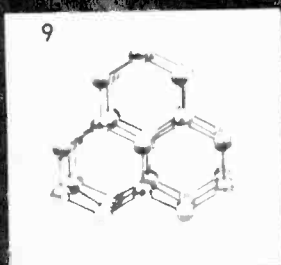

FIG. 7. When the *P*-*N*-*P* transistor is correctly biased, there is a flow of electrons in external circuit, but a flow of "holes" within crystal.

Crystal structure Models: 1. Zirconblende; 2. Caesium chloride; 3. Cristobalite; 4. Potassium dihydrogen phosphate; 5. Diamond; 6. Pyrites; 7. Arsenic; 8. Sodium chloride; 9. Wurtzite; 10. Copper; 11. Niccolite; 12. Spinel; 13. Graphite; 14. Beryllium; 15. Carbon dioxide; 16. Alpha-quartz.



EXPERIMENT 7

Building a Crystal Set

Simplicity of construction is evident from open rear view of diode receiver. Note hearing-aid type phone.

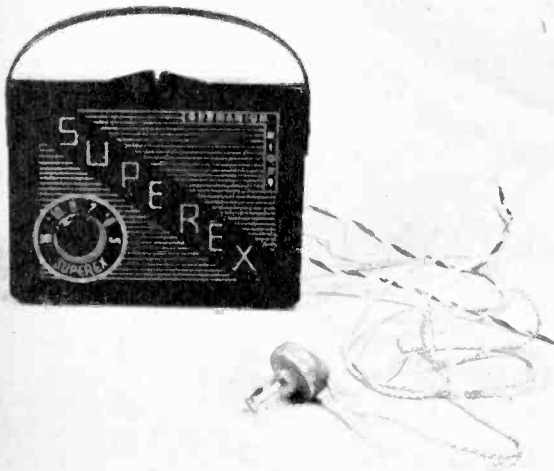
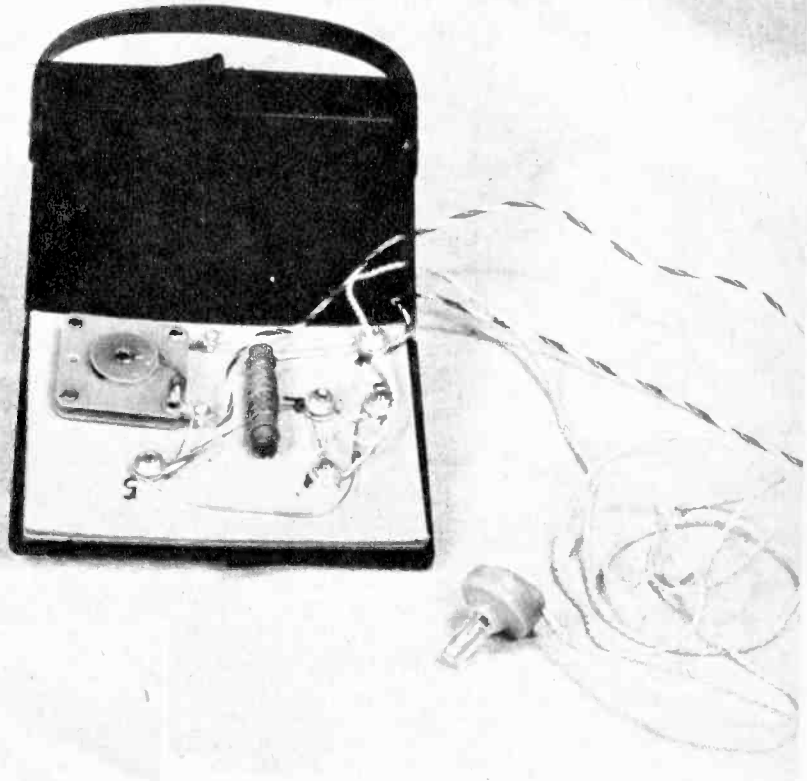

Set enclosed in case resembles miniature portable, without volume control or speaker.

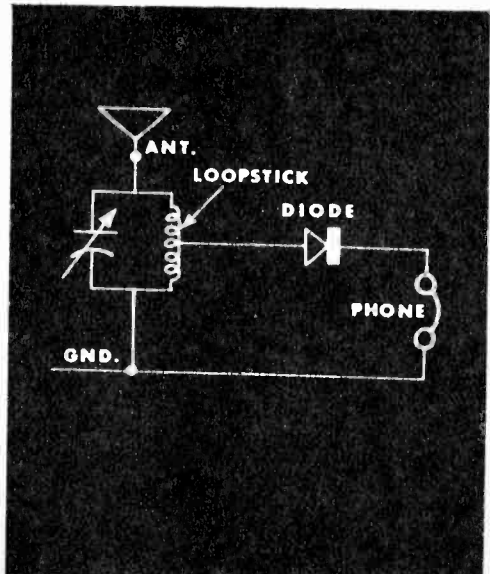

WE have now built two radio transmitters, and it seems time that we begin to experiment with receivers. The one shown here is built from a Superex kit, and uses a single semiconductor diode, which serves exactly the same purpose as the galena crystal of the early days of radio.

The Superex kit is unique in that no soldering is required. All interconnections are made using machine screws, washers and bolts, as the drawing shows. Thus the only absolutely essential tool is a small screwdriver.

The antenna wire has a small alligator clip on the end, which may be clipped on the bare metal of a bed spring, or the telephone wires will act as additional antenna when you clip onto the nickel-plated finger stop on the phone dial. A ground connection is not usually necessary unless stations are more than thirty miles away. Then clipping onto a cold water pipe will make a solid ground.

The radio signals striking the antenna are

coupled directly to the tuned circuit, where varying the capacitor will tune to the desired signal. The output of the tuned circuit is connected by means of a tap on the loopstick to the diode.

This diode is a one-way device, very much like the rectifier in Experiment No. 4. The diode acts only as a half-wave rectifier, however, and thus passes only the positive-going signal pulses. At this point the wave is still modulated radio frequencies, while we need audio to drive the headphones.

In a crystal set, the usual way of doing this was to connect a capacitor in parallel with the headphones, with the r-f by-passing around the phones through the capacitor. In this circuit we depend upon the *distributed capacitance* in both the ear-phone windings and in the diode to filter out the r-f. This type circuit is essential to any radio receiver, the more elaborate ones merely having the addition of amplifiers, r-f preceding and audio following.

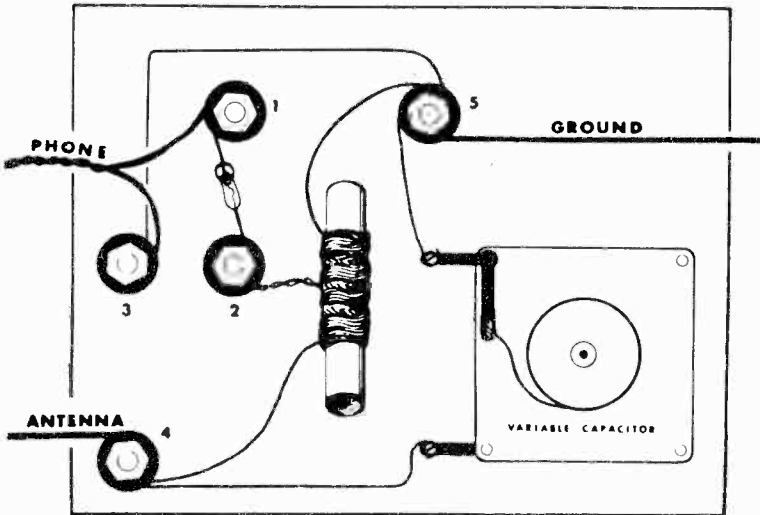

Clear drawings make this ideal beginner set.

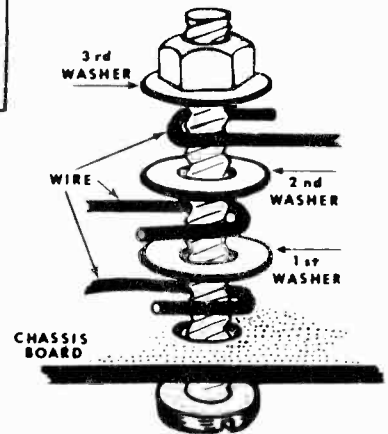
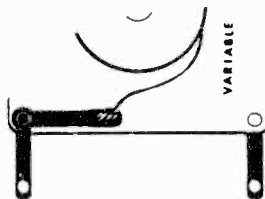
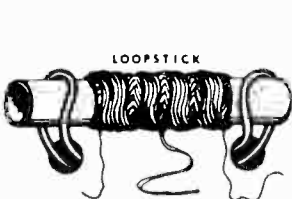



Automation in industry with all-electronically controlled machine tools, is helped by printed circuits incorporating transistors and diodes.

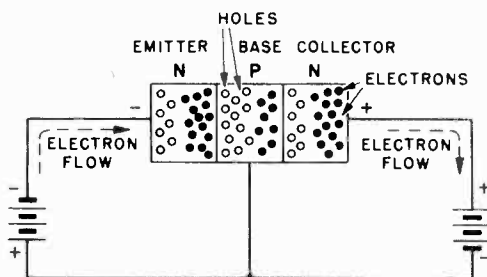

FIG. 8. In the N-P-N transistor, above, internal conduction takes place by movement of electrons rather than by holes. See text for details.

[Continued from page 53]

Suppose now that we join together pieces of P- and N-type germanium, as shown in Fig. 4. As a practical matter, such a junction is obtained in either of two ways. The *grown junction* is a single crystal which begins with only one of the two types of impurities. During the growth process, while the material is in a state of melt, impurities of the other kind are added, and the remainder of the crystal takes the opposite form.

The *fused junction* is formed by impressing small quantities of indium into the surface of an N-type germanium wafer. The application of heat fuses the indium to the surface of the germanium, producing a P-type film over the N-type base. Thus there is a P-N junction between this P layer and the N-type wafer.

As we noted in Figs. 2 and 3, the N region of the junction will have a supply of free electrons, while the P area will have a number of holes. When a voltage is applied across the junction with the polarity shown in Fig. 4, the holes are repelled by the positive potential and the electrons by the negative. Thus they both tend to move toward the junction, where they combine. This action is responsible for the high forward current indicated by the deflection of the meter pointer.

The Junction Diode

Let's examine this a little more closely, to see what is actually occurring within the junction. While normally there is a barrier which prevents the free movement of holes and electrons across the junction, this is effectively broken as long as the voltage is applied. Thus the holes move

into the N area and the electrons move toward the P area. When the electrons and holes meet, they combine and effectively cancel each other out.

But at the same time, an electron bond near the positive terminal breaks down, and for every combination of an electron and a hole at the junction, there is a free electron which enters the positive leg of the external circuit. But this in turn creates a new hole which must then move toward the junction.

In the negative leg, meanwhile, free electrons are arriving from the battery to enter the N region of the junction. These replace the electrons lost by combination with the holes at the junction. Again we have an excess of electrons at the negative terminal, and these also tend to move toward the junction to combine with new holes arriving there. The result is a fairly large current flow through the junction and in the external circuit.

Now consider what happens when we reverse the polarity of the voltage supply, as shown in Fig. 5. The holes are now attracted to the negative terminal and the electrons to the positive terminal, both away from the junction. Since there is no effort to break through the barrier and complete the circuit, almost no current flows.

Thus we have a diode, which conducts current in only one direction, behaving very much like the diode discussed in Chapter 3 and demonstrated in Experiment No. 4. And semiconductor diodes have exactly the same applications as as electron-tube diodes, namely, as detectors and rectifiers.

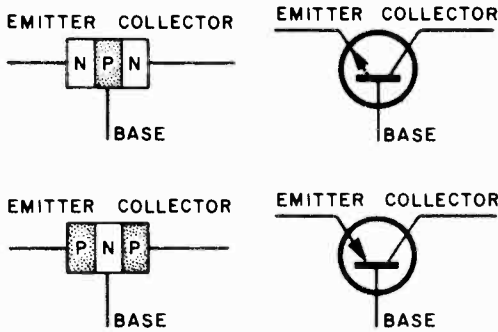

FIG. 9. The basic forms and equivalent circuit symbols of the two three-element transistors. The N-P-N is at top with the P-N-P shown below.

The Transistor

And just as the triode tube evolved from the addition of the grid to the diode, it would seem that a semiconductor triode might somehow evolve from its own diode counterpart. And this is exactly what happened in 1948, with the invention of the *transistor*. The discovery was so momentous to the electronic art that it earned for its inventors the Nobel Prize in physics.

The junction transistor is a direct outgrowth of the junction diode we have just studied. It comprises three sections of germanium, in either a P-N-P or N-P-N configuration. Transistors are used throughout in the radio circuit of Experiment No. 8. All functions normally served by tubes in the usual superheterodyne radio are here handled by transistors, plus a semiconductor diode detector.

As we see in Fig. 6, the P-N-P transistor is essentially a "sandwich," with a section of N-type germanium surrounded on both sides by P sections. In actual practice, the N layer is very much thinner than the P sections. The double junction may be made by either the grown or fused methods already described for diodes.

Two voltages are applied to the transistor, one to either leg. When the polarities are as shown in Fig. 6, both of the P layers are negative with respect to the N section, which also means that N is positive with respect to P. Under these conditions, the free electrons in the N section tend to move away from the junctions and toward the positive battery terminals. The "positive" holes similarly are attracted away from the junctions under the influence of the negative battery terminals. Since this arrangement affords no opportunity for the elec-

trons and holes to meet at the junctions, current flows only momentarily and then stops completely.

Transistor Bias

Now let's reverse the polarity of just one of the batteries, to give us the arrangement of Fig. 7. The voltage on the left P section is now known as a *forward bias*, while that on the right P section is called a *reverse bias*. The forward biased section is called the *emitter*, while the reverse biased section is known as the *collector*. The center section is called the *base*. These designations hold for all three-element transistors, whether P-N-P or N-P-N, and whether their construction is of the junction or point-contact type.

When the voltage is applied as in Fig. 7, the holes in the emitter cross the barrier into the base territory. But the N section is so thin that the holes find few electrons to join with, and so they go right on across the second junction to the collector. At this point, electrons from the collector battery enter the negative terminal of the transistor and cancel out the holes.

But for each hole that is lost by combination with an electron in the collector, an electron bond is broken in the emitter, and a free electron is permitted to flow toward the positive terminal of the emitter battery. The supply of holes is thus being constantly replenished in the emitter, and these holes in turn find their way toward the collector.

Since the base in effect is hardly more than a transparent window between the two junctions, it might seem that the transistor is behaving much like an ordinary diode, and is thus useful only for rectification or detection. But you will see that this is not so, as we observe still another phenomenon of transistor operation.

Remember that the base is not completely transparent, for there will always be a few electron-hole combinations occurring in the base. That is, not all of the holes pass through the base in their journey from the emitter. This means that the collector current will always be less than the current in the emitter.

Furthermore, no current can flow out of the collector unless electrons are also flowing into the emitter. But only a small voltage is required to develop rather large emitter currents. At the same time, rather large voltages can be applied to the collector. This means that for fairly small power inputs we can have quite large power outputs. The power gain of transistors can

[Continued on page 60]

EXPERIMENT 8

Building a Transistor Radio

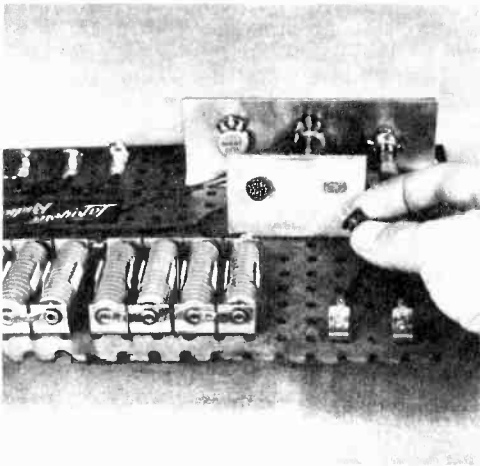
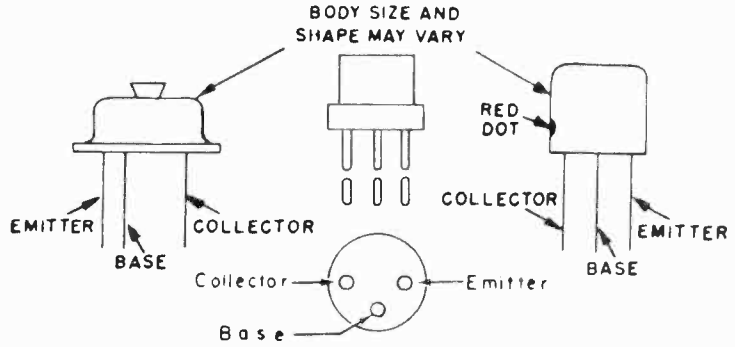

Second 2N107 transistor is plugged into its socket (above) to finish components installation. Tuning (above, right) is accomplished by varying position of slug in coil since capacitor value is fixed.

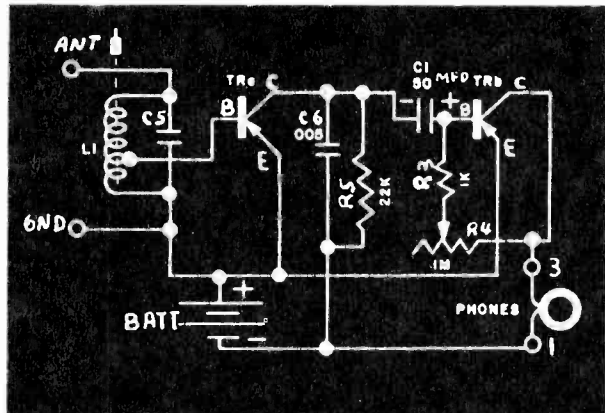

THE little transistor receiver here is a direct descendent of the diode set you built in Experiment No. 7. The first stage (TR_A) is a detector-amplifier, while the second stage (TR_B) is an audio amplifier. Note the similarity of this input circuit and method of coupling to that of the diode set. The only difference is that here we tune by varying the inductance instead of the capacitance.

The selected signal from the tuned circuit is impressed on the base of the first transistor. Since this component has three elements, rather than only two as in the diode, it has the ability to amplify as well as rectify. This particular circuit is analagous to the grid-leak type of tube detector, in which the incoming modulated signal is first rectified and then amplified.

The final process of demodulation or detection occurs through capacitor C_{11} . The capacitance of this component is such that it offers little opposition to r-f, but effectively blocks audio. Hence the radio component of the wave is shorted out

through C_{11} , while the desired audio passes on through C_1 to the base of TR_B .

The main job of TR_B is to build up the audio to a level satisfactory for headphone use, and it therefore amplifies the signal many times more. The level of the signal in the headphones is adjusted by the volume control, R_1 . The headphones convert the electrical signals from TR_B into audible sound. The way in which headphones operate will be described in Experiment No. 9.

Transistors are made in various sizes and shapes, as shown in the drawing. Most of them have three elements, and therefore three leads, which usually are not equally spaced. In these types the spacing of the leads is the key to identifying the leads. In the equally spaced types, usually a red dot is used to identify the collector. And in nearly all cases the base will be found in the center. In the unequally spaced type the emitter is closer to the base.

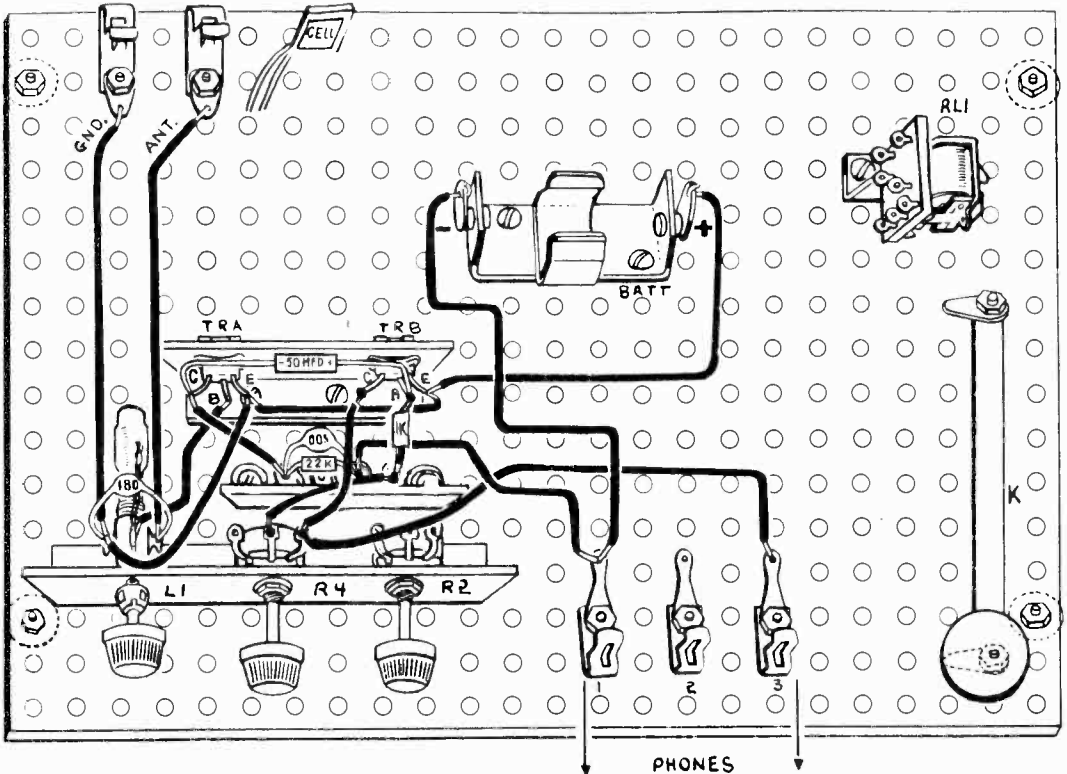

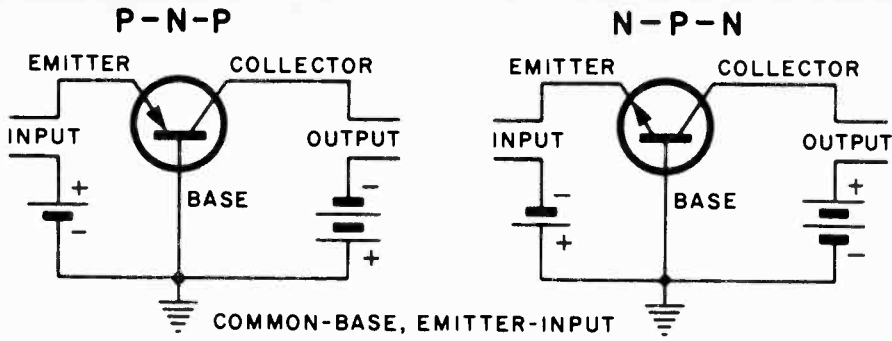

COMMON-BASE, EMITTER-INPUT

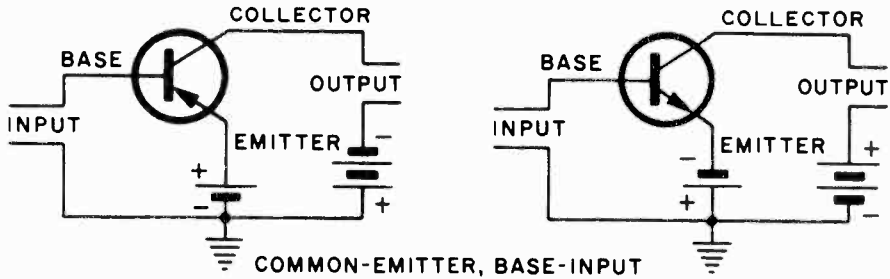

COMMON-EMITTER, BASE-INPUT

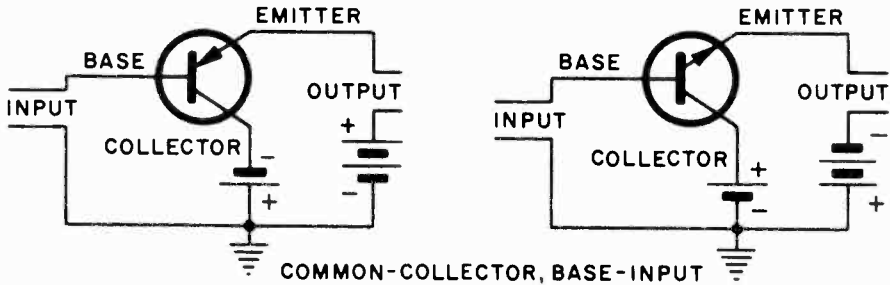

COMMON-COLLECTOR, BASE-INPUT

FIG. 11. Sharp electrodes of point-contact transistors are reminiscent of "cat's whiskers" in crystal sets. They may soon be equally obsolete.

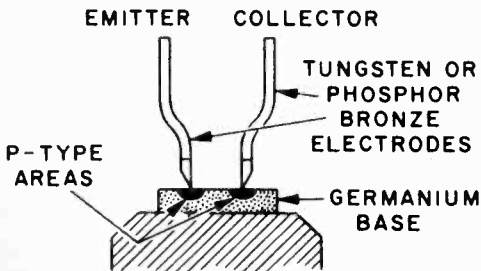

FIG. 10. Three modes of connection are possible with each of the two transistor types. Circuit connections are shown above with the P-N-P type at left and the N-P-N transistor on the right.

[Continued from page 57]

in fact approach 1,000 or more. Transistors can therefore be used as amplifiers and oscillators as well, just like tubes.

We can also make a transistor by reversing the sandwich ingredients, to come up with the N-P-N transistor shown in Fig. 8. The conduction process is similar to that for the P-N-P, except that the internal current is carried primarily by electrons rather than holes.

Under the influence of the emitter battery, electrons leave the emitter, overcome

the barrier and enter the base area. Since this *P* region is very thin, most of the electrons go right through it into the collector. At this point they are attracted by the positive potential of the collector battery and thus enter the external circuit. Electron flow therefore takes place continuously in the direction shown in Fig. 8.

The electron flow within the *N-P-N* transistor is very similar to that in the conventional triode tube. But if this be true, then we realize that the *P-N-P* concept, in which the major charge carriers are *positive* (for in effect that is exactly what the holes are), is wholly new, for the tube is yet to be built in which positive charges flow through it. For this reason, the two types of transistors have separate circuit symbol designations, as shown in Fig. 9.

Transistor Circuits

In the examples of Figs. 7 and 8, we have used a *common-base* connection for the transistor. Using circuit symbols, this is shown for both types of transistor at the top of Fig. 10. Other connections are also possible, as Fig. 10 shows. To understand these various types, it is convenient to compare them to their counterpart tube circuits. In doing so, we can consider the emitter of the transistor as roughly analogous to the cathode of a tube, the base similar to the control grid, and the collector as comparable to the plate.

The common-base connection we have been studying is thus generally similar to the grounded-grid triode circuit. While it was convenient for examining transistor physics, it is not the most commonly used circuit. It is useful, however, as a high-frequency amplifier, where ordinary circuits might tend to go into spurious oscillation.

The common-emitter circuit is comparable to the conventional grounded-cathode tube circuit. It has the greatest flexibility and efficiency of the three types, and also the highest voltage and power gain. And like the grounded-cathode, it is also the most used.

The common-collector is roughly analogous to the grounded-plate circuit, better known as the cathode follower. It is not an amplifier, for like the cathode follower, it actually has a gain of less than one. As a loss device, its greatest application is in impedance matching or isolation between two stages or devices.

The Tetrode Transistor

Transistor technology has not yet progressed to the point where we have the

counterparts of tetrodes, pentodes, and more complex types of electron tubes. There is, however, a so-called tetrode transistor. This is really a misnomer, however, for the unit still has only three active germanium elements.

The purpose of the tetrode is to improve the rather poor high-frequency response of transistors. This shortcoming has two causes. One of them is collector capacitance, which acts as a shunt for high frequencies, very much like interelectrode capacitance in a tube. Furthermore, there is the problem of transit time, the actual time it requires the charge carriers to move through the crystal and arrive at the collector. When the polarity of the collector voltage changes so rapidly that the charge carriers don't have time to move all the way across to the collector, then the current and the gain will drop considerably.

These troubles are partially overcome by the tetrode transistor. This is really no more than a conventional *N-P-N* transistor, with a second connecting lead attached to the opposite side of the base from the conventional lead. With a common-base circuit, with the usual base connection grounded, a small negative voltage is applied to the second lead. This tends to have a repelling effect on electrons near the wire, and to concentrate them in the area of the regular base connection. This effectively makes the *P* region smaller or thinner, and the base resistance lower. The result is a shorter transit time, with a consequent raising of the upper frequency limit.

The Point-Contact Transistor

All of the junction transistors were preceded by an earlier type, known as the point-contact transistor. This is illustrated in Fig. 11. While your crystal radio in Experiment No. 7 had a "cat's whisker," you will note that this transistor has two.

The transistor is formed in manufacture by passing a current through these electrodes. This results in two small areas at their tips acquiring essentially *P*-type behavior. The consequence is that we now have effectively a *P-N-P* transistor.

Because of the small barrier areas, along with low self-capacitance of the collector, the point-contact transistor has somewhat better high-frequency response than the junction type. But the junction types are constantly being improved, and because they are simpler and cheaper to manufacture, they will probably eventually supplant altogether the earlier junction types. •

Chapter 5

ELECTRONS AT PLAY

Radio — TV — Hi-Fi

Photo right. "Electrons at play" in the home are typified by today's modern hi-fi equipment. Shown here is a complete stereo component installation, including tape recorder, speakers and a television set.

By far the most popular form of electronic entertainment is the television show. Many cameras, microphones plus miles of cables are involved in the production of the average network telecast, see below.

NBC Television

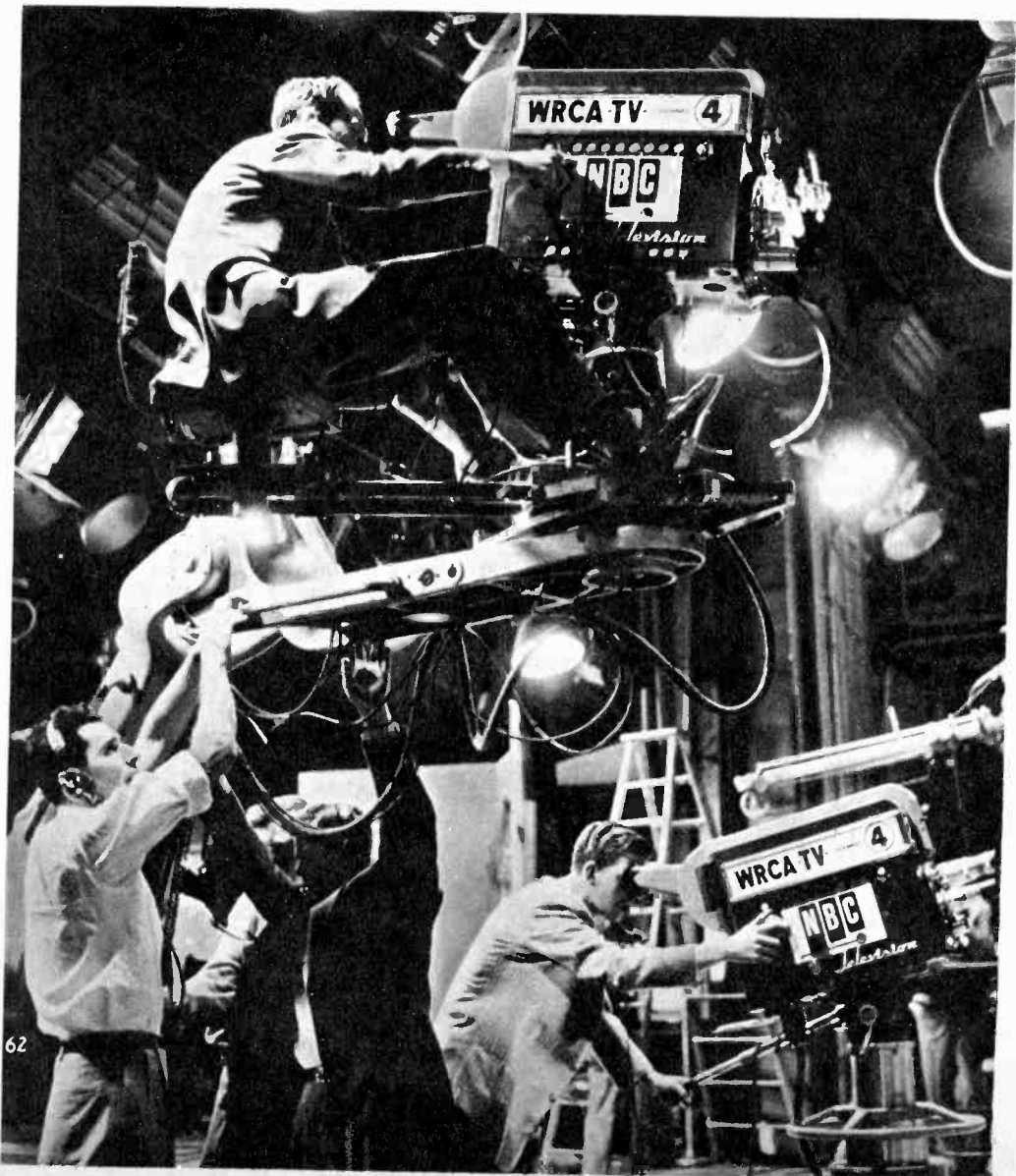

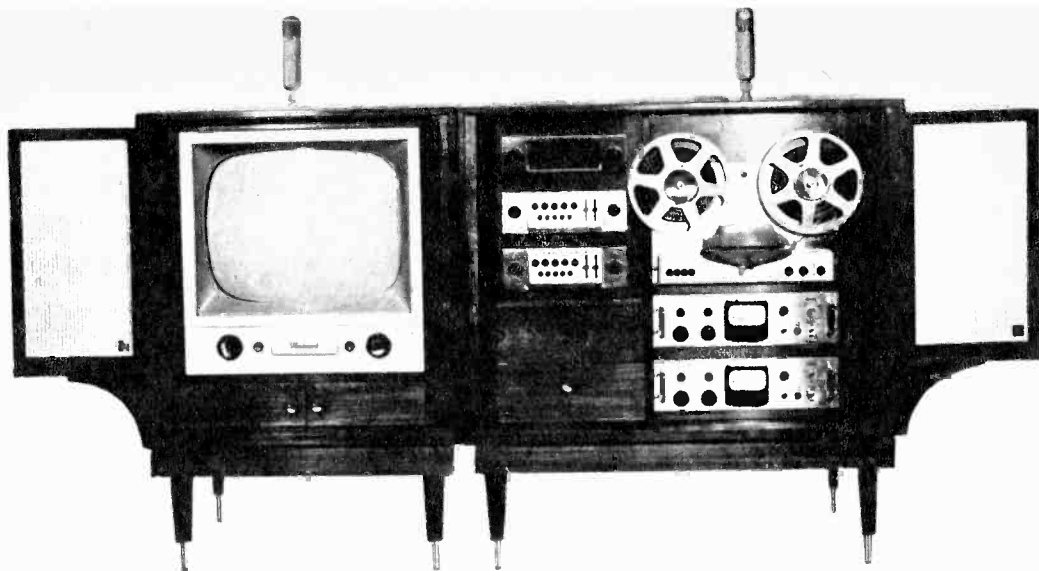

THE first widespread use of electronics was in the opening up of whole new worlds of entertainment. First came radio broadcasting, then phonograph recording, followed by soundfilm recording and, most recently, television. Except for phonograph records, which earlier were recorded and reproduced by rather crude methods, each of these arts was wholly new and unique. Instantaneous transmission of sound over great distances was wholly unknown before radio (except for the telephone, which was limited to private communications). The motion picture was strictly a pantomime art until electronics gave it a voice. And while a television presentation is somewhat like sound movies, the factors of instantaneous transmission and simultaneous reception were wholly without precedent.

Microphones

In each of these arts, at the beginning of the sound chain there must be a transducer for converting sound waves into electronic signals. This transducer is the microphone. The earliest microphones were essentially sound-sensitive variable resistors, and were derived from telephone practice. This is the type microphone used in Experiment No. 5, and again in Experiment No. 9.

Although the carbon microphone is still used in telephones, for hi-fi entertainment use there are many other preferable types. One distinguishing characteristic of all of these is that they generate their own voltages, rather than varying an externally supplied current. These newer microphones have a number of advantages, but probably the primary reason for their use is the fact that they perform with much higher fidelity.

Another characteristic of hi-fi micro-

phones is their low output. Although they generate their own voltages, these signals are rather feeble and must immediately be boosted to a usable level. And this is where the audio amplifier comes into the picture. A simple type of such amplifier is your construction project in Experiment No. 9.

The audio amplifier has one primary purpose. It must reinforce the feeble signals fed to its input without altering them in any other way. Any alteration of these signals is recognizable as distortion.

The high-level output signals from the audio amplifiers may be fed to any of a variety of devices, depending upon specific requirements. If they are required for a broadcast network, they will now be fed into high-fidelity telephone lines and sent on their way to distant stations. If they are to be stored for future use, they will go into another transducer, in the form of a disc recording cutter, a film recording head, or a tape recorder. And if they are to be broadcast immediately, they will be fed into a radio or television transmitter. But if they are to be heard directly, they will be immediately reconverted to sound by means of a loudspeaker or headphones.

Recording Systems

The cutter used to engrave a groove on an original phonograph disc is a vibrating motor, something like that in an electric shaver. But instead of driving a pair of shears, it moves a plow-shaped sapphire stylus through a soft lacquer surface on an aluminum disc. Film recorders today may be either magnetic or optical. In the older optical system, a light beam varies with the audio signals along the edge of photographically sensitized movie film, to expose the sound track. Magnetic recorders,

[Continued on page 66]

EXPERIMENT 9

Building an Audio Amplifier

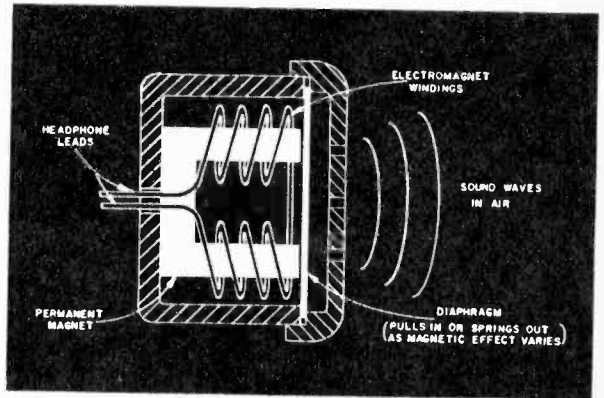
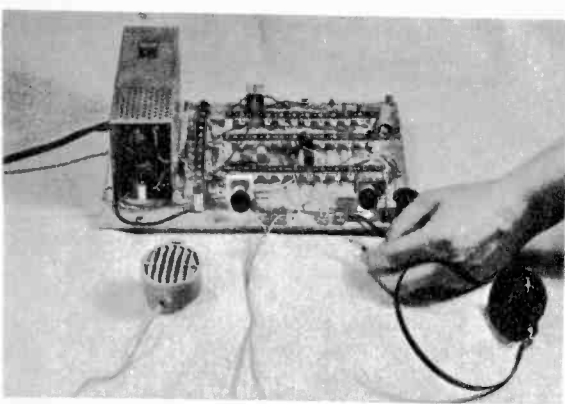
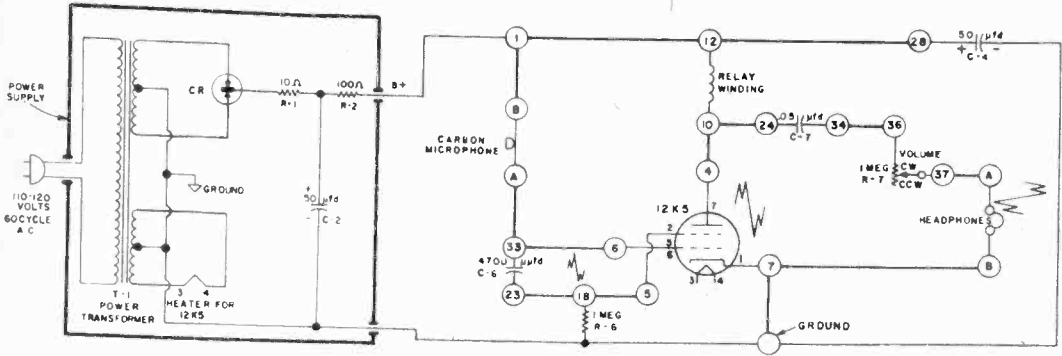

Final steps in construction comprise insertion of microphone and headphone tips in the Fahnestock clips.

One-tube amplifier isn't strong enough to power a loudspeaker, but is loud enough for phones (right).



THIS little audio amplifier will build up signals from a microphone or phono cartridge to adequate level for headphone operation. Unlike the tetrodes discussed in Chapter 3, the 12K5 tube is here connected with the first grid acting like the conventional screen accelerator, while the second grid acts as the control grid. This rather unconventional circuitry is used so that the operating voltages may be kept low, with all exposed parts at a safe potential.

The audio signals are actually applied to both grids, but only grid 1 has a positive bias as well. The B+ voltage is blocked off from grid 2 by capacitor C₁₁, while the audio readily passes right through it. The plate current stream is therefore caused to vary exactly as the voltage on the two grids varies.

The microphone develops the audio signal as was explained in Experiment No. 5. If a phono cartridge is to be used instead, it should be of the piezo type (either crystal or ceramic), with an output of at least 0.25 volt. Disconnect the

microphone, and connect one wire from the cartridge to MICROPHONE A, and the other wire to either of the GROUND clips. Do not use the B microphone clip, for this would put plate voltage across the cartridge and possibly cause serious damage.

The output from the plate circuit, the amplified signal, goes to the headphones through C₇ and R₇. Headphones and loudspeakers are known as electro-acoustic transducers, because they convert electrical signals into sound, just the opposite of what the microphone does. Most headphones operate on electromagnetic principles and, as shown in the drawing, contain a permanent magnet which is wound with electromagnetic coils. Current through the coils causes them to generate a magnetic field which will alternately add to and subtract from that of the permanent magnet. The diaphragm will therefore set up sound waves in air as it vibrates back and forth in following these magnetic variations.

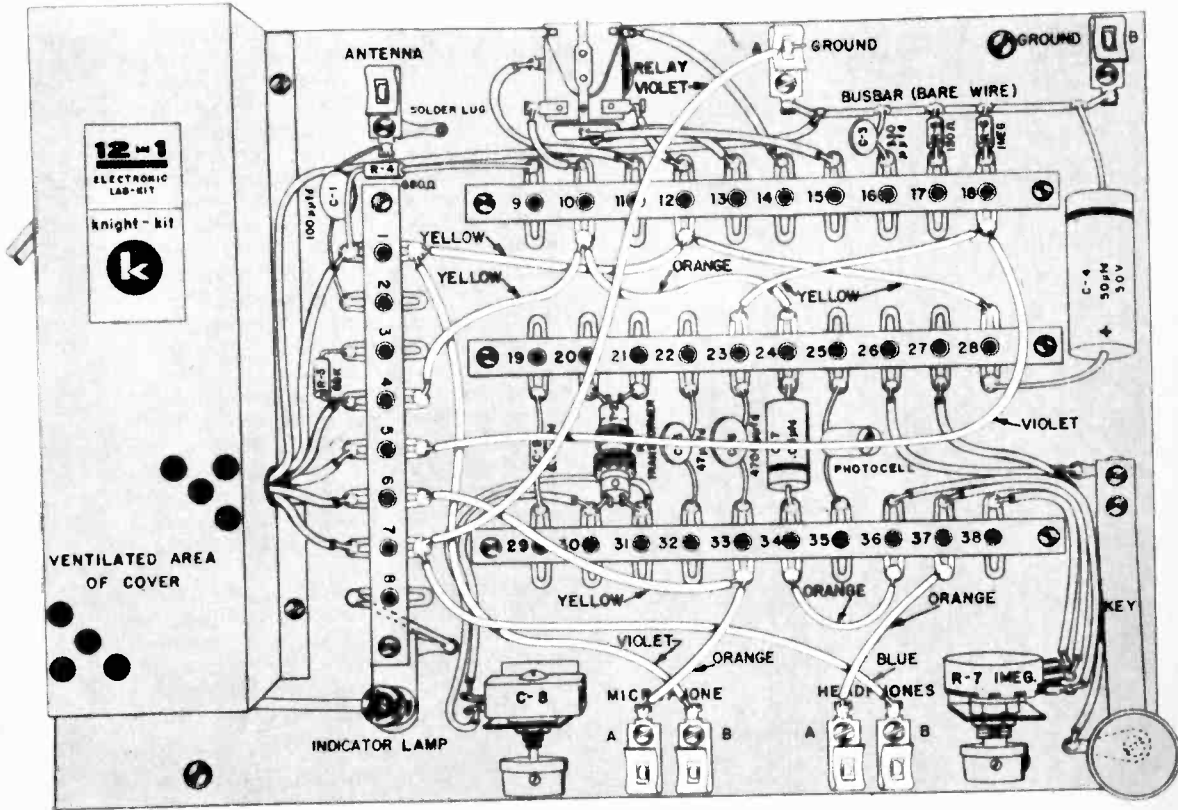

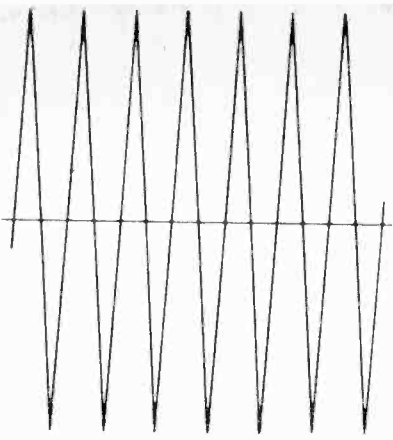

unmodulated radio-frequency carrier wave

PLUS

audio-frequency modulating signal

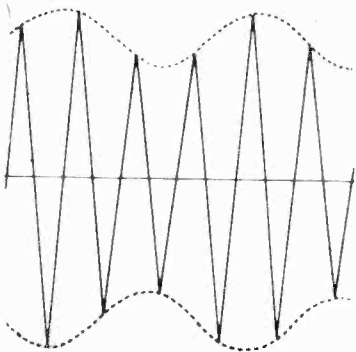
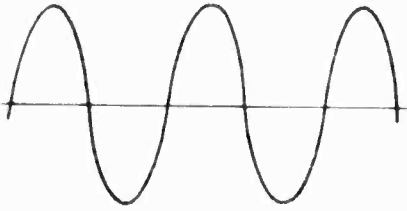

resultant AM radio wave

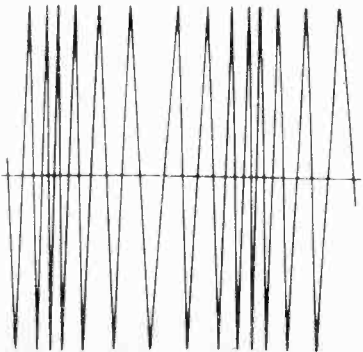

resultant FM radio wave

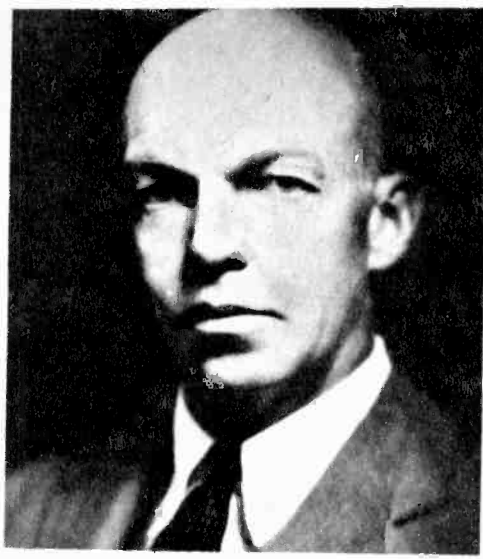

Major Edwin H. Armstrong, a prolific radio inventor, is best known for his discovery of FM.

[Continued from page 63]

which may have either tape or film as the recording medium, have electromagnetic recording heads which magnetize the metallic material on the surface of the tape or film.

Radio transmitters for the broadcasting of sound have three basic elements: a generator or radio waves, a modulator for combining sound signals with radio waves, and a radiating system, or antenna. The generator is an oscillator, as was discussed in Chapter 3, and the antenna is a tower, or a set of long wires, or some other configuration depending upon the frequency and other factors.

But the radio transmitter alone is of little use without some means of applying it to the transmission of information. The simplest way of doing this is to turn the transmitter on and off according to a pre-determined code. This is analogous to the Indian smoke signals, where a blanket over a fire is used to release puffs of smoke at stated intervals. As the electronic counterpart of this, in Experiment No. 1, your transmitter may be likened to the fire, and the key takes the place of the blanket.

This arrangement will convey information all right, and as such it is widely used even today. But for the transmission of electronic likenesses of sound waves, a more subtle variation of the radio wave is required. This procedure is called *modulation*.

Audio Modulation

Any means of varying the radio wave so that it follows exactly all of the complexities of a sound wave will be a modu-



The New York Times

New York radio station WQXR has complete stereo broadcasting facilities, is well known for its programs of recorded and live classical music.

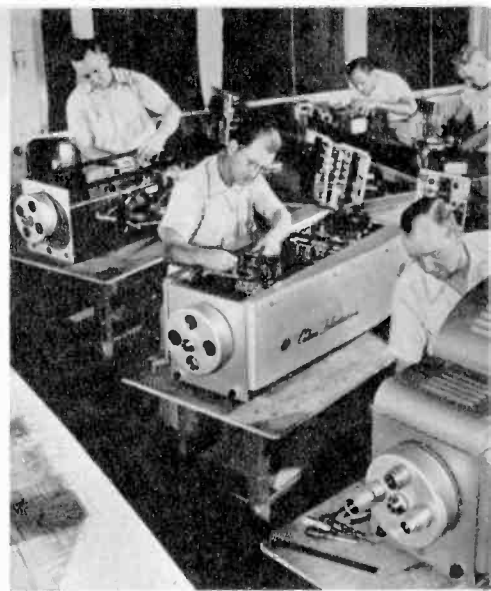

RCA Victor

Color television is the latest advance in this field, is steadily gaining in popularity. Here, cameras are being readied for final testing.



Above is an Eico AM tuner, available as a kit or in assembled form. The kit, photo right, is being assembled, following manufacturer's instructions. Kit building is becoming more and more popular, gives builder good experience in the theory and practice of various electronic circuits.



Fred Honig

radio receiver. FM radio is the newer type, and it is superior to AM in reduction of extraneous noise and in fidelity of reproduction. But FM has had to buck the long head start and solid entrenchment of AM, plus some measure of public indifference. As a consequence, it will still be some time away, if ever, that FM fully supplants AM.

Now exactly half the job is done: the sound wave has modulated a radio carrier, or it has been recorded in the form of a groove, or an optical or magnetic track. At this point we must reconvert these signals or recordings back to sound.

In the case of radio, the instrument which does the job is called a tuner. Of all the many waves striking the receiving antenna, the desired one is selected by a

[Continued on page 70]

lation. Many methods of modulation have been used, but in broadcasting today either of two characteristics of the radio wave are varied. One of these is the *amplitude*, and the other is the *frequency*.

In the system of amplitude modulation (AM), the frequency of the signal stays right at its assigned spot on the dial, while the power radiated from the antenna varies, all the way from zero to twice the unmodulated power. In frequency modulation (FM), just the converse is true. The power output of the system remains constant while the frequency is varied above and below its center assignment as dictated by the form of the modulating sound wave.

The transmitter you build in Experiment No. 5 is the AM type, and as such can be heard on any standard home AM

EXPERIMENT 10

Converting a TV Set for Hi-Fi

Rear view of TV-Audio switch before conversion. Compare with lower left drawing on next page.

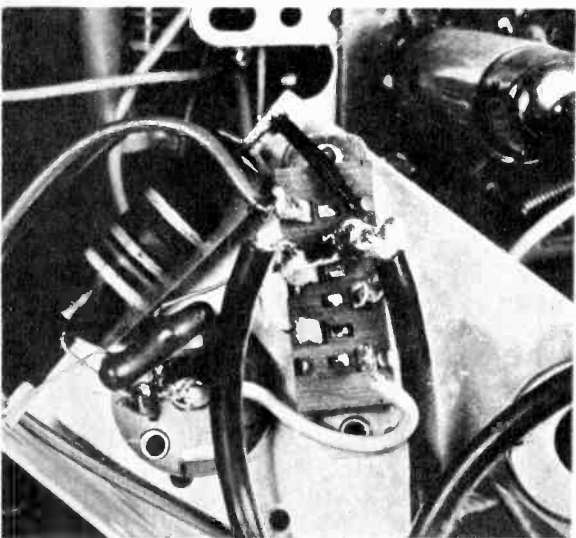

Rear view of TV-Audio switch after conversion. Compare with lower right drawing on next page.

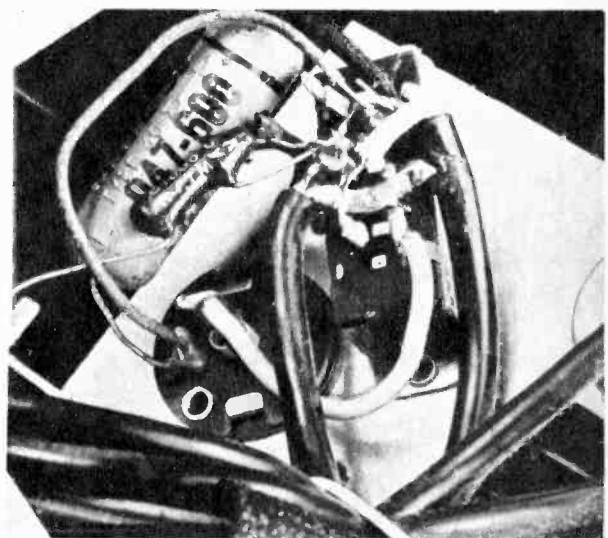

Circuit diagram (below) of typical TV sound.

Simplified conversion diagrams (below, right).

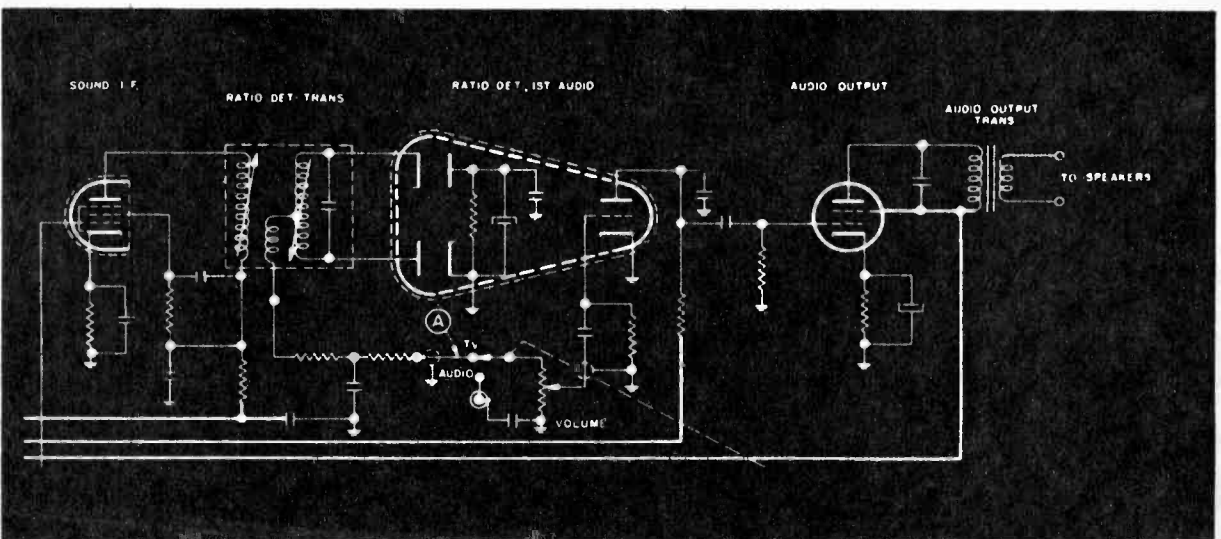

HERE is a way for you to get some practical use out of the audio jack and switch on the back of most TV sets, a circuit which in its present form is about as useful as a fifth wheel. This circuit is reminiscent of the old "television adapter" jack on pre-World War II radio sets.

You may recall that in those dear dead days, when the public thought that television was just around the corner, this jack was concocted to prevent obsolescence of the radios which just then weren't selling too well. The idea was that, when television came in, you could buy a set without an audio system, and just plug it in and use the audio in the radio set. Nobody ever did this, of course, because no such TV set was ever built.

But the gimmick, has now been dusted off and used again to ride in on the hi-fi craze. The idea now is that you can plug in a phono cartridge, tuner, or tape recorder into the jack, so that the signal will be reproduced through the "superb" audio system in the TV set. Since this audio

amplifier is in fact pretty junky, the idea is absurd.

But we can take the idea and turn it around, to come up with a system which is truly useful. The idea is that, instead of running other signal sources into the TV set, we will instead take the FM detector output from the set and feed it into an external hi-fi system. This will give you TV sound like you've never heard before.

The simple changes are shown in the accompanying drawings. The double-pole, double-throw switch shown in the typical circuit diagram now performs two functions: It selects the input to the little one-tube audio amplifier from either the TV detector or an external source; and it disables the picture tube when the external source is in use. The change involves simply flipping the selector function over to the detector output, and shorting out the picture tube switch so it is continuously operative. Finally, if hum is incurred, short out the capacitor between the jack shell and ground.

Switch labelling remains same. To hear set's sound, use TV; for hi-fi, use Audio.

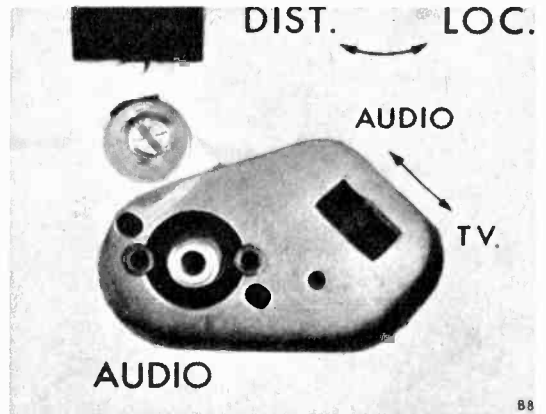

B8

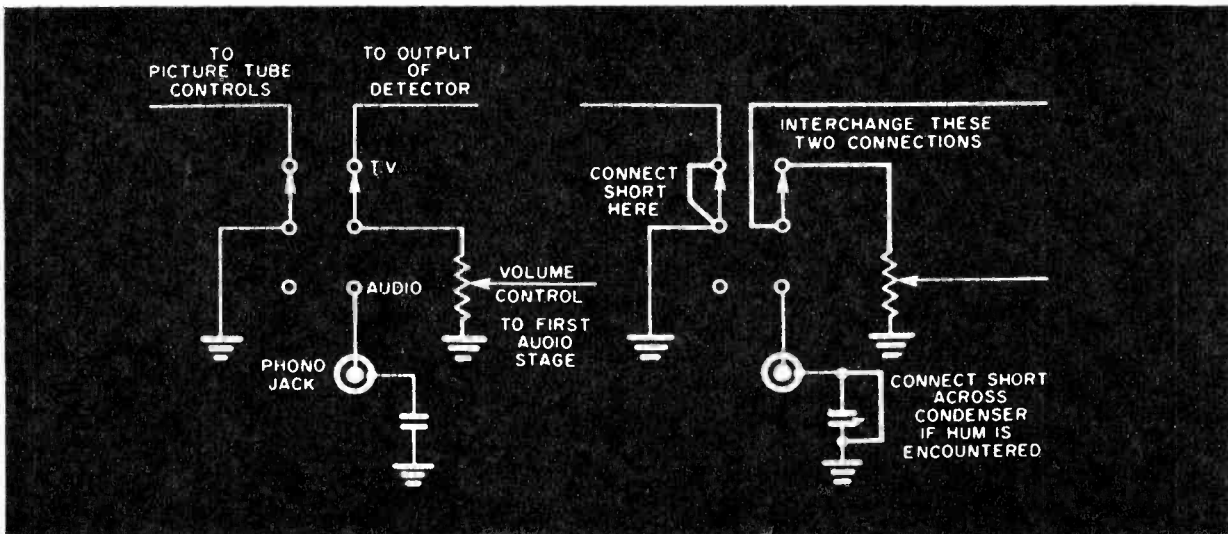



Robert Hertzberg

There were about 185,000 licensed radio hams in the United States in 1959, accounting for a large and honorable slice of the "Electron at play" field.



Radio Corp. of America

Over 46 million TV sets are found in U. S. homes, with about 5 million new sets produced annually, a growing number of which are color receivers.

TV tape recorder handles up to 96 minutes of black-and-white or color material, records and plays back through a 14-inch magnetic tape reel.

Radio Corp. of America

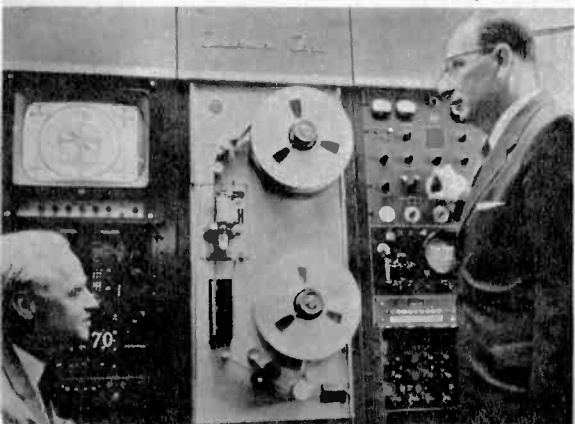

Mike Bontino

One of the countless uses electronics can be adapted for is radio control. Above is a garage door being opened from a car by this method.

[Continued from page 67]

tuned circuit. Then it is amplified electronically. Finally, the audio is separated from the radio wave by the process of detection or demodulation. Now we have an electronic signal representing the audio alone, and it should be almost exactly like that at the output of the microphone.

Reproducers

For recordings, we must go to another transducer. The disc recording transducer is usually called a pickup or cartridge. It is actually a small electric generator which develops a voltage as a result of the side-to-side movement of its stylus in the groove.

The millions of tiny magnets drawn past the head of a tape reproducer similarly develop a voltage at its output terminals. An optical film track is reproduced by moving it between a fixed light source and a photocell. The amount of light striking the cell at any instant will be determined by the area or density of the track. The voltage generated by the cell will therefore be an electronic replica of the original sound.

The audio signals must now be amplified further in an audio amplifier, to make them powerful enough to operate a loudspeaker. The speaker is the final transducer, the end of the chain. It is an electromagnetic device, which converts electronic signals back into vibrations in air, that is, into sound.

The television system operates on the same principles as radio, but it is more complex because it must transmit picture information as well as sound. The television transmitter is really two transmitters in one, sending out both audio and video signals. In the present system in the United States, the sound transmitter uses

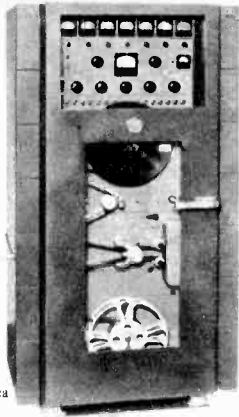

Radio Corp. of America

Magnetic 7-channel recorder, designed for the motion picture industry, runs at variable speed, records and plays back over seven separate tracks.

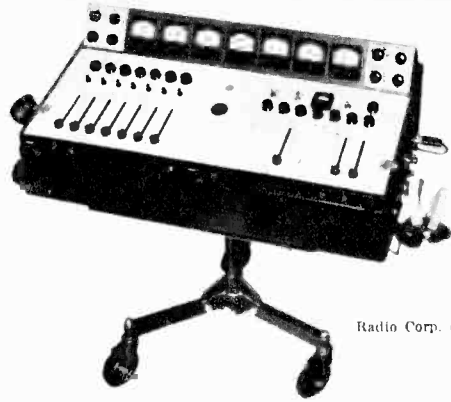

Radio Corp. of America

Transistorized multichannel mixer for motion picture sound recorder (shown at left) contains 23 amplifiers, plus one oscillator, is portable.

FM, while the picture transmitter uses AM. The sound transmitter is generally the same as any FM radio transmitter, and the video transmitter operates on conventional AM principles, but the modulating signal itself deserves somewhat more careful scrutiny.

Video Synchronizing

The transducer in this case is the video camera, which was described in Chapter 3. But the video signal must have some additional information for the receiver to synchronize with the transmitter. Perhaps this would be more clear if we likened it to a teletypewriter system.

As this chapter is being written, the original manuscript is prepared on a typewriter, one character at a time. If a teletypewriter were used, with a slave machine at some remote point, that machine would have to follow the original typewriter movements exactly. It would have put the same characters in the same places. It would have to capitalize, indent, return the carriage to the beginning, put the same space between words and lines, and at the end of this sentence put a period, just as the original typewriter.

Just as the words and thoughts in the writer's brain are translated into typewriting, and dissected so that they hit the paper one letter at a time, so is the television picture translated into electronic signals, bit by bit. But in television this happens so fast, the dissection in the camera, and the reconstruction in the picture tube on the TV set, that we never see the picture as a series of dots or lines.

If the picture tube, however, failed to keep right in step with the scanning in the camera tube, the picture would become a hopeless jumble of disconnected

elements. And this is exactly what you have seen happen when something has gone wrong in the scanning or synchronizing circuits in your TV set.

Another piece of information which the video signal must carry is the *blanking*. When the end of a line is reached in typing, the line space lever—which returns the carriage over the left side for the beginning of the next line, and also turns the cylinder—is touched so that type does not go directly over the line just finished.

During this carriage return and line spacing no keys are depressed, as they would only make meaningless marks on the paper. Similarly, the electron beam in the cathode ray tube in your receiver must refrain from making a glowing line on the face of the tube during the retrace. And it is the blanking signal from the transmitter which tells the beam to shut down during this time.

Composite Signal

All of these additional pieces of information are included as a part of the composite video signal. The audio and video transmitters are separate, as we have noted, and the two types of signals are again separated in the receiver.

Following the audio detector is the audio amplifier and loudspeaker. The only difference between this audio system and a hi-fi audio system is that the hi-fi is of much better quality. If you have a hi-fi system, therefore, it is much better to use it for your television audio. This can be done with the Experiment 10 conversion.

Although electronics has played an important role in entertainment for years, it has gone on to perform more serious and important jobs. Some of those are described in the following chapters. •

Chapter 6

ELECTRONIC BRAINS

Computer systems



THE AGE of the electronic computer is often referred to as the Second Industrial Revolution. The first one, which occurred between 1800 and 1850, replaced human brawn with mechanical power. Now some people are wondering if the human brain is about to be put out of business by an electronic intruder.

To understand whether man is really on the way to making himself obsolete, we must consider what computers do today, how they work, and what they may accomplish in the future. The major role played by computers today is in the large business office, where mountains of paper work can be processed within hours rather than weeks or months. No longer must the lonely bookkeeper sit on his high stool, green visor on his head and quill pen in hand, slaving over his journals and ledgers far into the night.

High-speed digital computer is distinguished by its small size and low power, can be used as a test model for research on other computers.

Bell Telephone Laboratories

Console of IBM 705 machine is installed here at one of the nation's leading airplane makers.

Boeing Airplane Co.



Computers Today

In the factory we already have the beginnings of automation, as we will note further in the next chapter. Machines of many types have their operations controlled by a computer. Some controlled machines can even be connected to an electric typewriter to "discuss" with an operator the progress of the work being performed. The fully automated factory is still a thing of the future, but scientists know how it can be done. As soon as someone comes along who wants to pay the price, he shall have it.

Military demands during World War II caused computers to take great strides ahead. Special types were devised to perform the ballistics calculations necessary for aiming guns, bombs and other projectiles. Extensions of these techniques are used today in the guidance systems of missiles and rockets.

Computers are also used widely in research, in such fields as astronomy, electron optics and weather forecasting. An especially valuable application of computers is as simulators, which will give results otherwise obtainable only after elaborate tests and experiments. This solves design problems in aircraft and missiles, without the building of models or prototypes. There is even a nuclear simulator reactor, which recreates inexpensively the operational characteristics of a multimillion-dollar reactor.

Many leading universities here and abroad design and build their own computers which they use in a great number of research problems. The unit shown here is located at New York University.

New York University

There are two main families of computers today, one called *digital* and the other referred to as *analog*. In the analog computer, a number is represented by the size of a physical quantity, such as a voltage. In a digital computer the number is coded as a succession of signals. In everyday life we have examples of both types of computers in nonelectronic form. The ordinary slide rule, which represents numbers in terms of lengths on a stick, is a simple analog computer. The dial telephone system, which converts a telephone number into a sequence of signal pulses, is actually a digital computer. The seven spins given to a telephone dial result in seven groups of up to ten pulses each. From this information the central-office equipment is able to select any one of over five million different telephone numbers. This very principle is employed in the computer you build in Experiment No. 11.

Computer Functions

Every computer actually comprises several operational "departments." One of these handles the arithmetic operations: addition, subtraction, multiplication and division. Not all of these are essential, however, for even the most complex mathematical operations are simply repetitions of simpler ones. Squaring or raising to higher powers, for example, is simply repeated multiplication, just as multiplication is repeated addition.

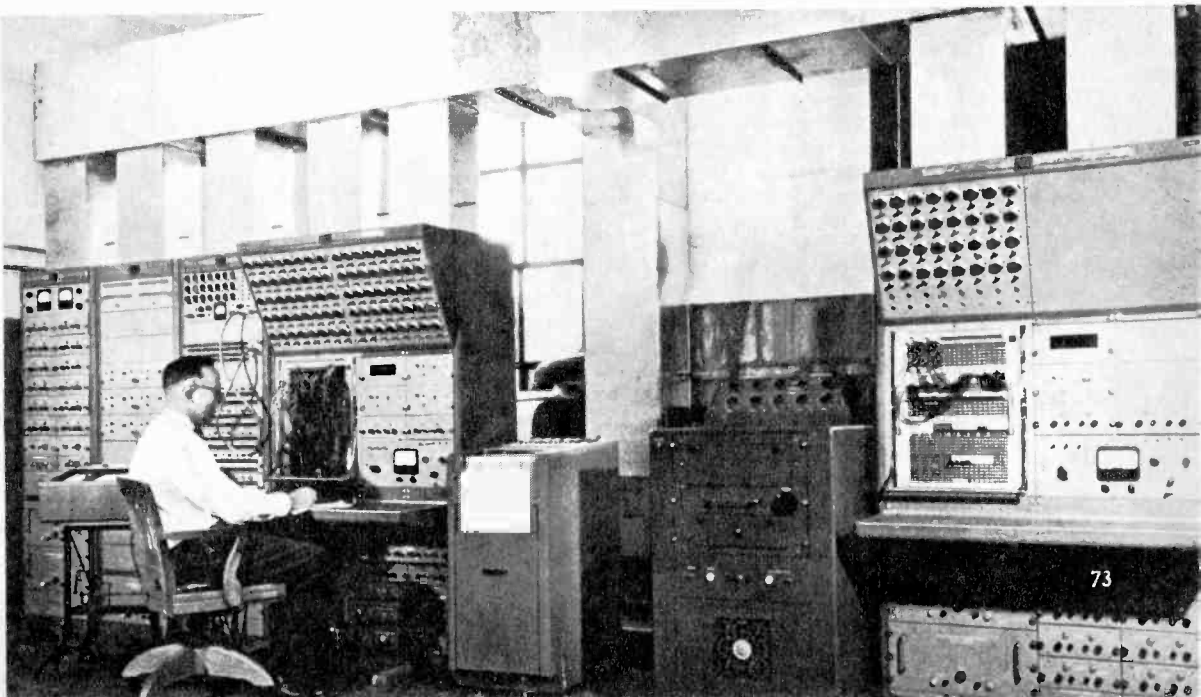

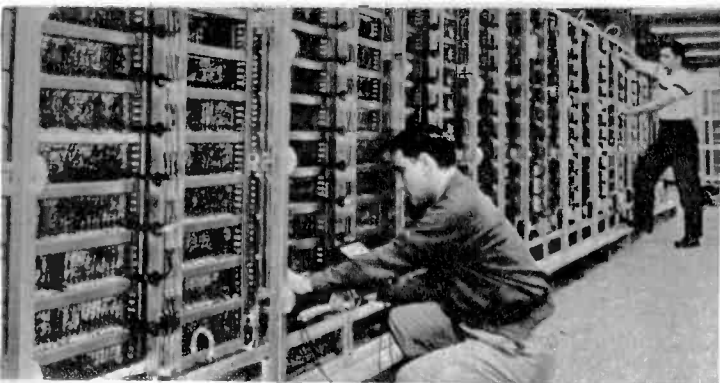

Radio Corp. of America

All-transistor data processing system, designed for business, industry and government, can also handle any paper work for smaller business firm.

Below are two examples of some of the earliest types of "computers." Not shown is what is probably the very first computer, the abacus.

International Business Machines

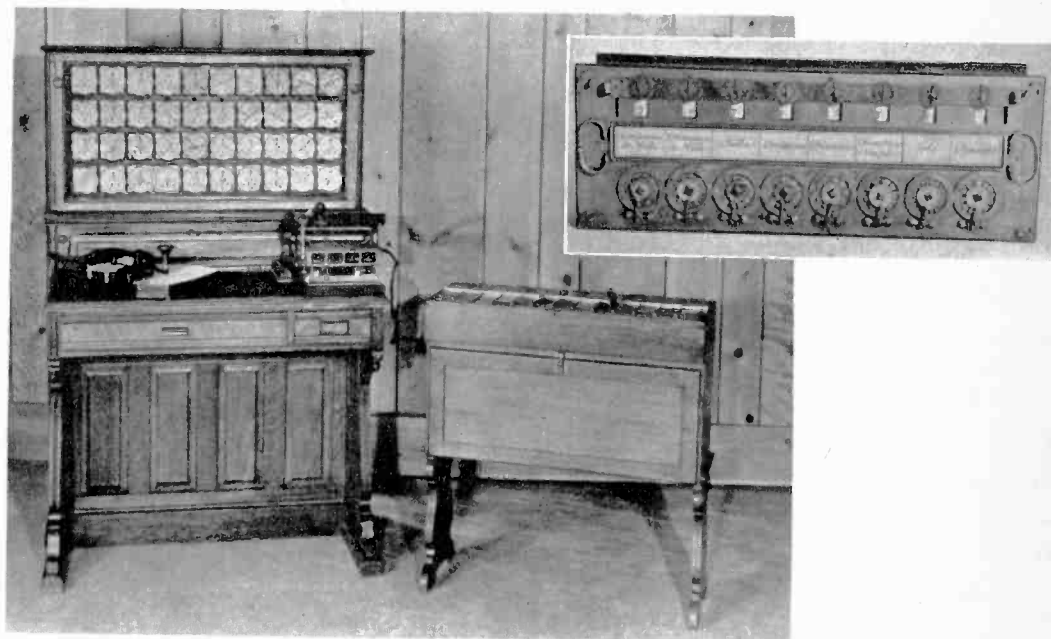

Also we have the memory or information-storage department. The memory may be either temporary or permanent, depending upon the service it must perform. Permanent storage is used for whatever information the computer needs to solve the problems it regularly encounters. This could include such facts as multiplication tables, the number of seconds in a minute, or metric equivalents of English units. Temporary stores, on the other hand, are used as parking places for sub-totals and other partial results.

There also must be some prior planning of the computer's job, so that it will carry out the computation in proper sequence. Before attempting to solve any complex mathematical problem, one first must analyze it to determine where to begin, and then what to do next. This part of the operation must still be accomplished by the human mind. The computer must be told what to do and how to do it, by a procedure known as programming. Having

complete instructions, the computer can then proceed on its own to perform the endless drudgery of involved calculations. In a rudimentary way it might be said to "think," but it is still beholden to a human master, who does much of its thinking for it.

Number Systems

In the decimal system of numbers we normally use, the basis is the number 10, and there are ten digits, ranging from 0 through 9. A certain combination of these digits would be used to represent a specific number, such as 32,894. Reading such a number is so familiar to us that we never stop to consider that these five digits indicate that the number comprises 3 tens of thousands, plus 2 thousands, plus 8 hundreds, plus 9 tens, plus 4 ones.

Electronic counting of numbers such as this might be done with signal pulses feeding into a capacitor and an electronic switch. As shown in Fig. 1, each incoming

One of the latest IBM machines has a cathode-ray screen, extreme right, which shows the operator graphically the performance of the computer.

International Business Machines

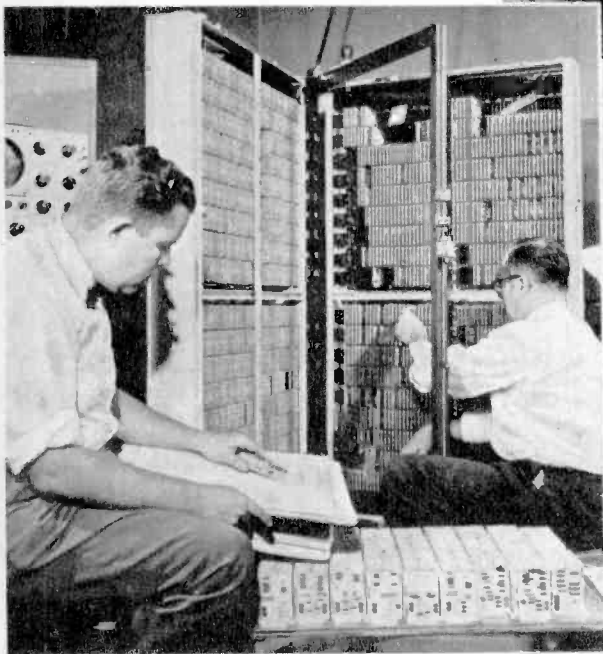

International Business Machines

Technicians, photo left, are seen inserting some of the standard component cards into the "works" of computer. Cards contain the circuit sections, are replaced or changed in case of any malfunction.

square wave pulse (A), raises the voltage across a capacitor in staircase fashion (B). On the tenth incoming pulse, the critical firing voltage of an electronic switch is reached, and one pulse appears at the output (C). At the same time, the capacitor voltage drops back to zero to start the whole cycle over again.

Now suppose that the output pulses (C) are fed into a succeeding counter which also fires only on every tenth shot. Then the output of the second counter would fire only after *one hundred* pulses had hit the preceding counter. Similarly, still another decade counter following that would indicate thousands, and another one would read tens of thousands.

But when we get up into these big numbers we are putting a lot of faith in the characteristics of a capacitor and a diode. If it occasionally takes eleven shots to fire the tube instead of ten, the count is off by ten thousand. Much more reliable would be a system having only *two* states, either

on or off. Such an arrangement would be practically foolproof, since it would be virtually impossible not to distinguish between those two conditions. The only trouble is, it requires a new system of numbers.

All numerical information fed into a digital computer must first be translated from our conventional decimal system into this new system, known as the *binary* code.

Decimal vs. Binary

The left half of the chart of Fig. 2 shows the arrangement of whole numbers in the decimal system. The chart could, of course, be extended at both top and bottom to include decimal fractions of less than one, as well as numbers greater than one million. But for purposes of simplicity, we'll confine our analysis to the limits shown.

Note that whenever a number is shifted one place to the left in the decimal system, it is in effect multiplied by ten. Thus in

[Continued on page 78]

EXPERIMENT 11

Building a Simple Computer

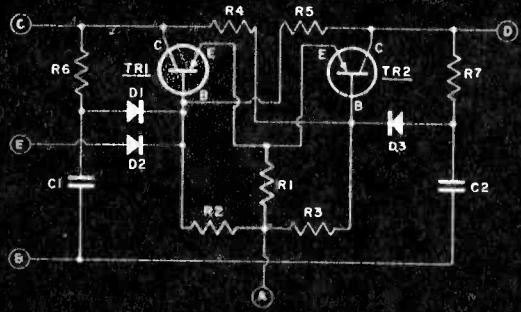
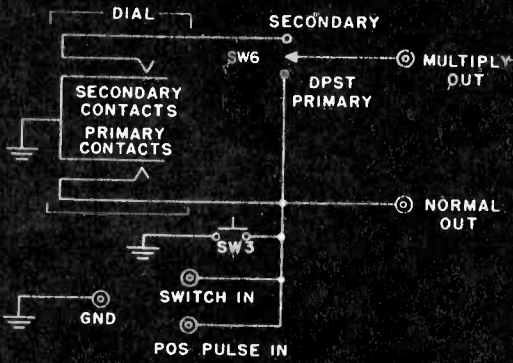

Schematic of telephone dial and input and output connections, above. Flip-flop circuit, above right, is same for all six.

Problem is fed to computer by telephone dial. To add $7 + 7$, dial number 7 twice in succession. Jack colors simplify programming.

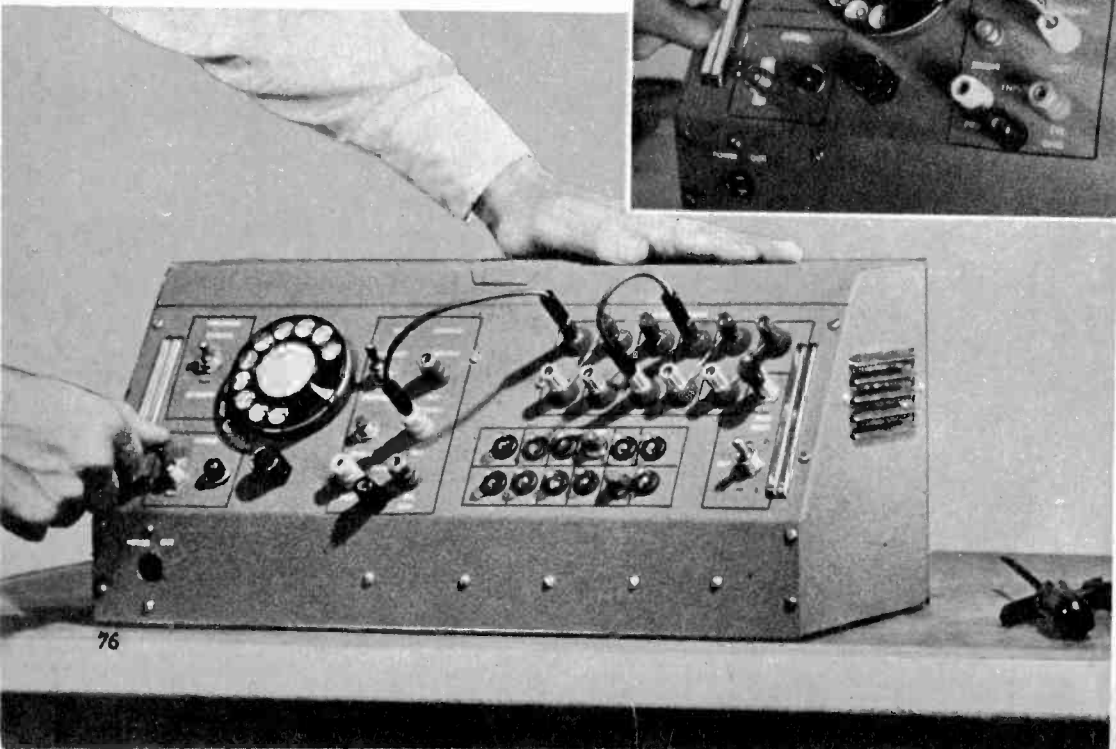
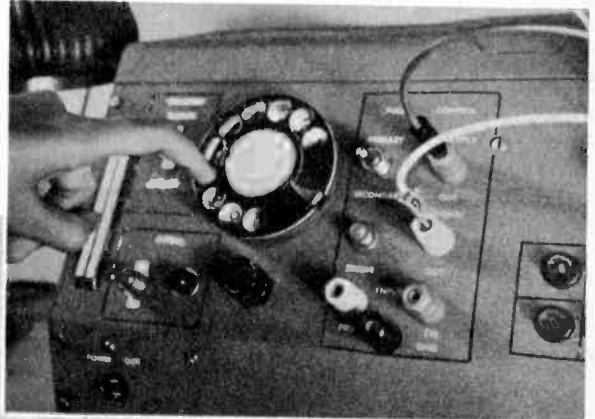

ONE thing we may as well face at the outset is the fact that the electronic computer is a highly complex device which simply doesn't lend itself to any basic little experiments. But if you would like to build your own complete computer, here is one you can have for around \$35 and a few evenings of your time.

As we have pointed out in this chapter, all mathematics, including the so-called higher type such as calculus and differential equations, ultimately boils down to many, many repeated operations of addition and subtraction. The more complex operations, from multiplication and division right on up, are simply short-cuts devised to circumvent the tedium of these many repetitions.

But if addition and subtraction were all we knew how to do, and if we could perform repeated operations quickly enough, and without ever tiring, then this would be adequate for arriving at the desired solution. And this in effect is what the digital computer does.

The heart of this computer is a counter, operating on binary principles described in this chapter. The counter comprises a number of stages of *flip-flops* connected in cascade. The flip-flop has the two states we have noted as necessary for binary counting. But instead of an on-off display, this computer uses an either-or system. That is, each flip-flop has two lights connected to its output, and either one or the other is on at all times the computer is in operation.

To perform a problem in addition, one simply dials the digits involved on the telephone dial. The contacts of the dial generate positive pulses which actuate the six flip-flop stages, permitting direct reading in binary notation of totals up to 63. This is arrived at through the sum of six columns:

$$2^0 + 2^1 + 2^2 + 2^3 + 2^4 + 2^5.$$

Higher numbers can be handled with more flip-flops. Full construction details on this project are to be found in the January, 1960 issue of *Electronics Illustrated*.

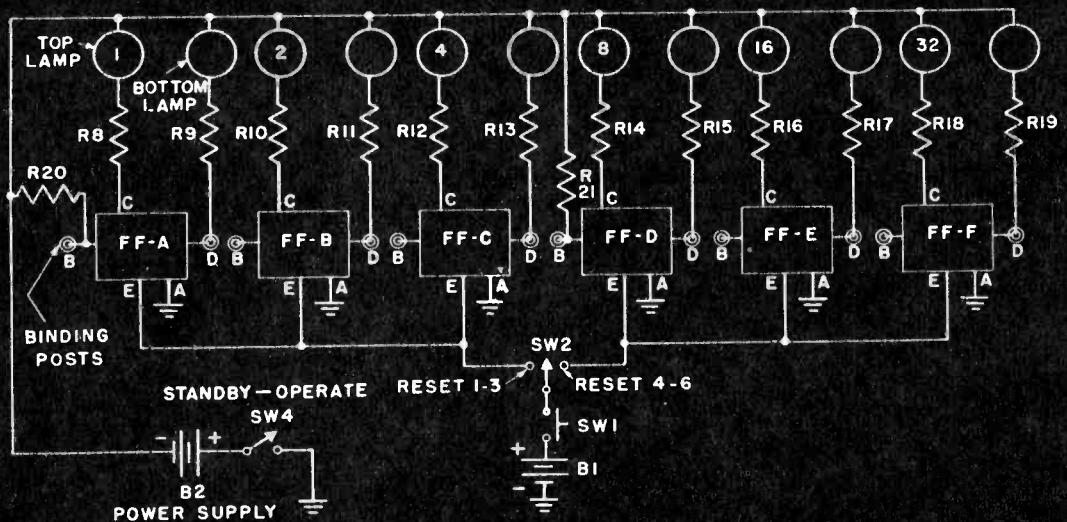

Compact cabinet with sloping panel houses computer, left. When telephone dial feeds problem, answer is in binary form.

A pair of indicator lamps is used with each flip-flop. Six identical circuits shown in block form above are detailed on preceding page.

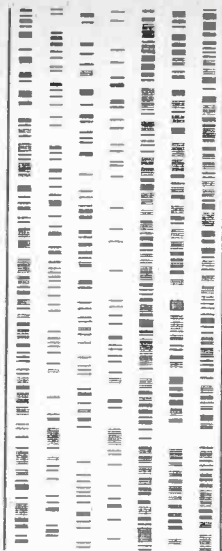
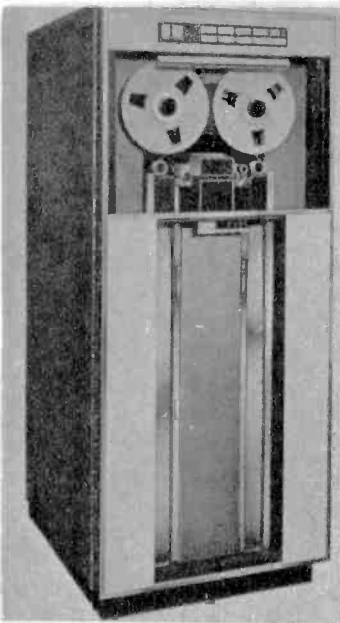

International Business Machines

Above is one of the main "memory" units of a computer: the tape machine. To its right is shown a piece of magnetic tape with imprinted signals.

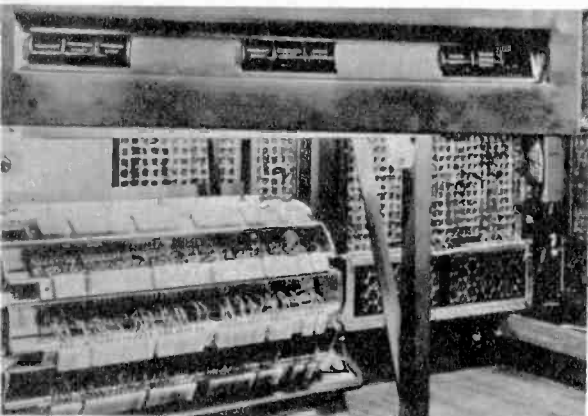

International Business Machines

Another memory unit is the IBM's 650 magnetic drum. It turns at the rate of 12,500 rpm and has magnetized spots on its surface. The drum holds up to 20,000 digits at 2,000 "addresses."

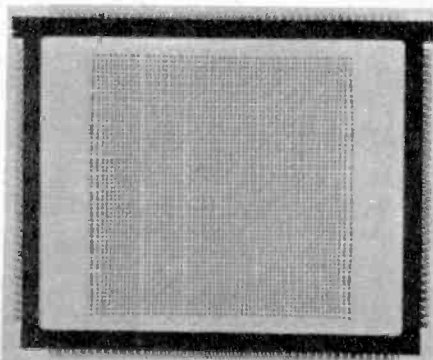

[Continued from page 75]

the number 43, the figure 4 means that there are four tens. But shifting one place to the left, in the number 430 it indicates now that there are four hundreds.

Since the base of the system is ten, we are in effect talking about ten multiplied by itself. Thus 100 is ten times ten, or ten squared (10^2). And 1,000 is ten times ten times ten, or ten to the third power (10^3). There is no reason, however, why the base of a numerical system couldn't as well be *two* instead. This in fact is the basis of the binary system. Instead of ten digits, 0 through 9, we use only two, 0 and 1.

In the decimal system, when we get above 9, we shift left to a second column starting with 10. Then we stay in two columns until 99, and then move to three columns for 100, and so forth. In the binary system, since we have only two digits, we must shift left one column as soon as we go above 1. Thus while in the decimal system the symbol 11 means a ten plus a one, or eleven, in the binary system it means a *two* plus a one, or three.

Referring again to Fig. 2, let's see if we can work out a binary number, using the same approach as we did with the decimal

International Business Machines

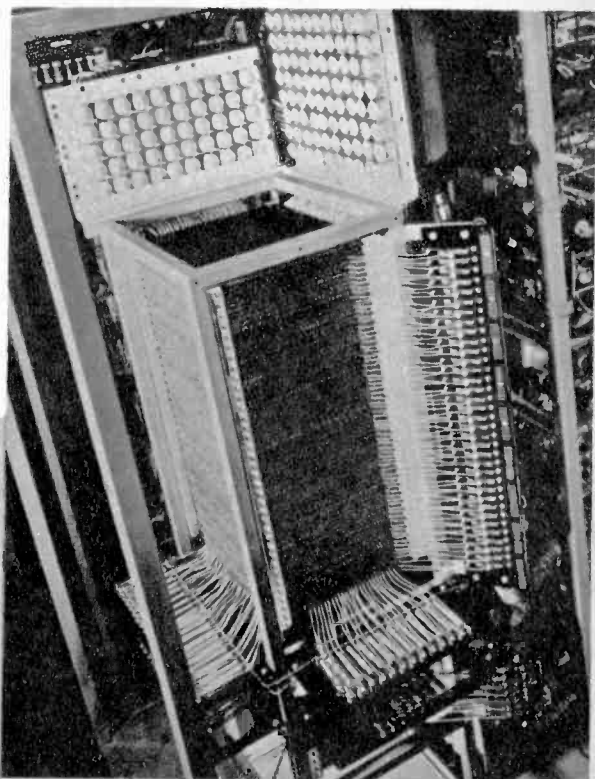

number. Since there are only two digits available, a binary number might look like this: 1011001. Thus for each of the columns shown in Fig. 2, the digits indicate the presence or absence of the number assigned to that column. You might therefore think of it as a *yes-no* system.

The first digit of the number 1011001 tells us *yes*, there is a 64 (or 2^6). There is *no* 2^5 . *Yes*, there is a 16 (2^4) and an 8 (2^3). There is neither 2^2 or 2^1 . There is, *yes*, a 2^0 or one. The final number then comprises a 64 plus a 16 plus an 8 plus a 1—converting it to decimal figures—or 89.

Binary Disadvantage

This, of course, points up the big disadvantage of binary numbers for ordinary work. It took a string of seven digits to express a number which in the decimal system is stated in two. And more places in the number means more tubes or diodes in the computer.

If numbers up to 9,999,999 are to be handled, for example, those seven columns in the decimal system stretch out to twenty-four columns in the binary code. But remember that each of those seven columns has ten different possibilities,

while in the binary system each column has only two, either 0 or 1. And general design practice today says that the job can be done easier and more accurately with twenty-four on-off (binary) switches than with seven ten-way (decade) switches.

With an understanding of binary numbers you have the essence of the way in which the majority of computers do their jobs. What these jobs may be in the future, not even the most imaginative can begin to guess. In medicine the computer will soon become an auxiliary diagnostician. All symptoms and the patient's history will be fed into the machine, and out will come the diagnosis, prognosis and suggested treatment.

In military electronics, the Army is now working on a mobile computer that will give battle commanders the facts they need to determine a course of action in a constantly changing tactical situation. As manned space travel becomes more and more nearly a reality, computers are being used every step of the way. No matter in what area of the future of mankind you look, just name it, and somewhere in the background you will find a computer, the electronic brain. •

FIG. 1. Below. In the serial counter the voltage of a capacitor rises in steps until it reaches a critical point where it drops back to zero.

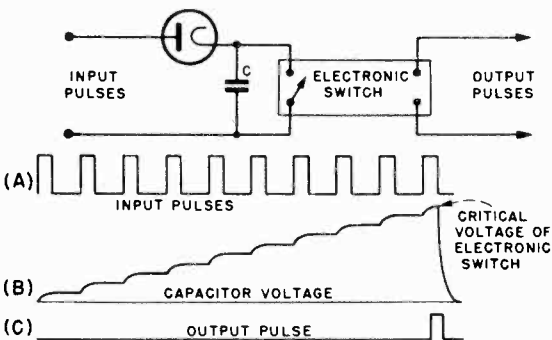

FIG. 2. Right. See text for explanation. The Nos. 8.4.2.1. at top of Binary column designate the respective values of each figure found under it. A zero under the 4, for instance, means there is no 4. A 1 under the 4 means that there is a 4.

Left. Magnetic core memory unit of the IBM 704 processing unit. Insert shows one memory grid which stores data as pattern of magnetic field.

DECIMAL

BINARY

		8 4 2 1
		▼▼▼▼
Zero	(0)	0 0 0 0
One	(1)	0 0 0 1
Two	(2)	0 0 1 0
Three	(3)	0 0 1 1
Four	(4)	0 1 0 0
Five	(5)	0 1 0 1
Six	(6)	0 1 1 0
Seven	(7)	0 1 1 1
Eight	(8)	1 0 0 0
Nine	(9)	1 0 0 1
Ten	(10)	1 0 1 0
Eleven	(11)	1 0 1 1
Twelve	(12)	1 1 0 0

Chapter 7

ELECTRONIC WORKMEN

Automation in industry

WITH the possible exception of marketing, the primary concern of modern industry today is, simply, turning out the product. This product must, of course, be something that buyers want, which means that it must be uniformly high in quality and as low as possible in price. For these conditions to exist, the production process involved must be carried out accurately and with a minimum of human effort. In other words, ideally the production should be entirely *automatic*.

Automation

Perhaps the most important factor in mass production techniques is the use of automatic machinery. As we noted in the preceding chapter, this trend began with the Industrial Revolution near the beginning of the nineteenth century. Today electronics plays a vital part in the control and monitoring of automatic machinery, and in some cases is an integral part of the process itself. Examples of the latter case include R-F heating equipment, and various

Tape control cabinets for all-electronically controlled line of machine tools. At right is master panel, next are four tape readers with punched metallic tapes. At left is the boring machine control cabinet.

Hughes Aircraft Co.

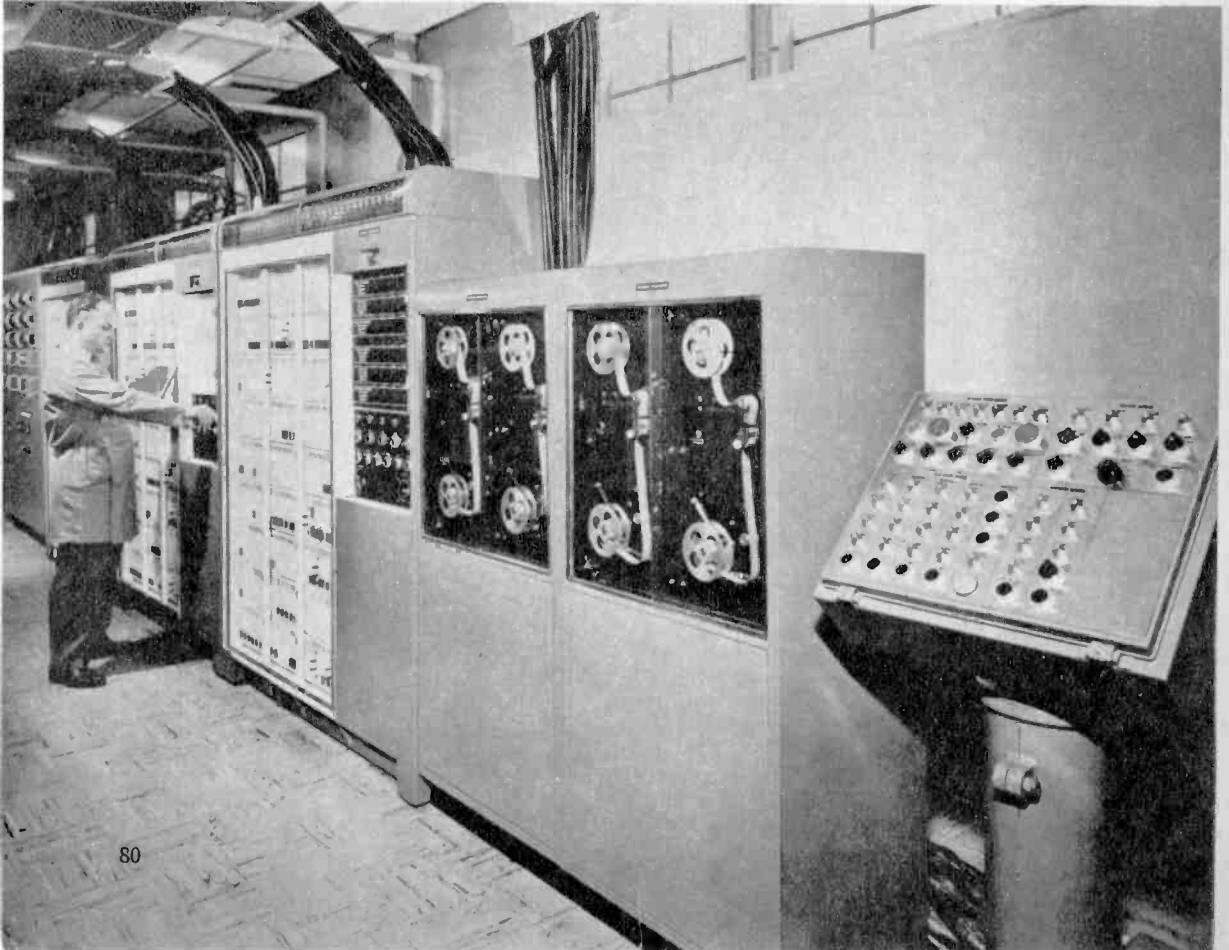

Ultrasonic 2,500-watt impact grinder cuts areas up to 3½ inches in diameter, is said to operate within tolerances of plus or minus .0003 inches.

Raytheon Electric Co.



Master totalizer of transistorized newspaper counting system records number of papers printed, can automatically stop presses when desired.

Radio Corp. of America

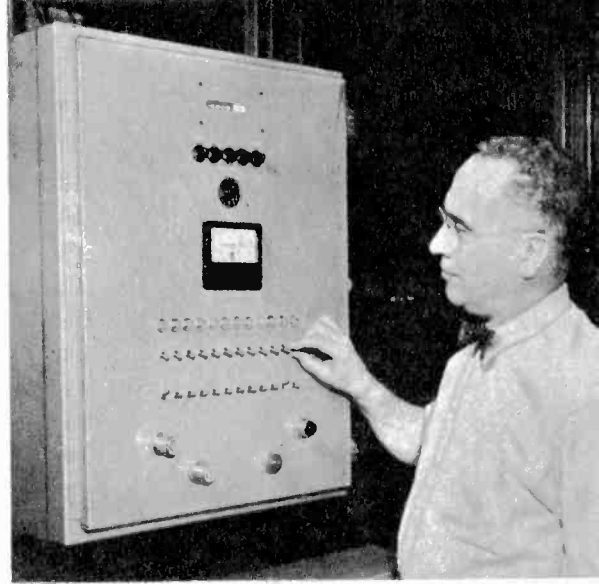

types of ultrasonic generators for heating, drilling, cutting and cleaning.

One of the most important applications in monitoring and control is in timing. Principles of electronic timers follow those of the unit you build in Experiment No. 12. They depend upon the time-constant characteristics of a resistance-capacitance combination, and a relay is normally used to control an external electrical circuit.

Electronic timers are used to fix the sequence and time of the manufacturing process, these two items together forming the process cycle. Sequence control systems generally comprise a chain of timers, the output of each being used to start or stop some operation, and also to start the timer which controls the succeeding step in the cycle.

One of the first widespread applications of electronics in industry was in welding control, particularly in the system known as resistance welding. In this method the two pieces of metal to be joined are held together under pressure, while a sufficiently heavy current is passed through them to cause them to fuse together. The amount of heat produced is dependent upon the resistance of the path, the current, and the weld time. These and other factors must be under precise automatic control for uniformly good results.

Spot welding, for example, involves a

quite definite four-part cycle, as follows:

1. *Squeeze* time, during which mechanical pressure is applied;
2. *Weld* time, during which current is passed through the joint;
3. *Hold* time, when current is off but the joint is still under pressure;
4. *Off* time, while the equipment recycles.

Each part of this cycle is controlled by an electronic timer, both as to sequence and length.

Some welding equipment has a further refinement, in that the welding current is held constant, regardless of variations in the supply voltage or the materials being welded. This, too, is accomplished electronically through voltage regulators or through the timing circuits. The most important contribution of electronics to arc welding is in maintaining a constant gap dimension, by repositioning the electrodes as they burn away.

Temperature Control

Often it is necessary to maintain accurate control of operating conditions, such as light or temperature. Regulation is generally accomplished by feedback systems, or servomechanisms, which employ some

[Continued on page 84]

EXPERIMENT 12

Building an Electronic Timer

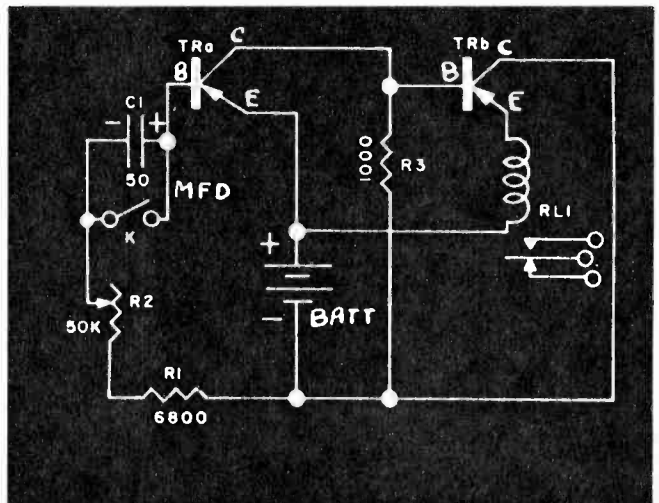
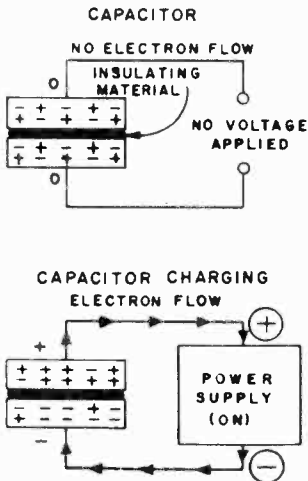
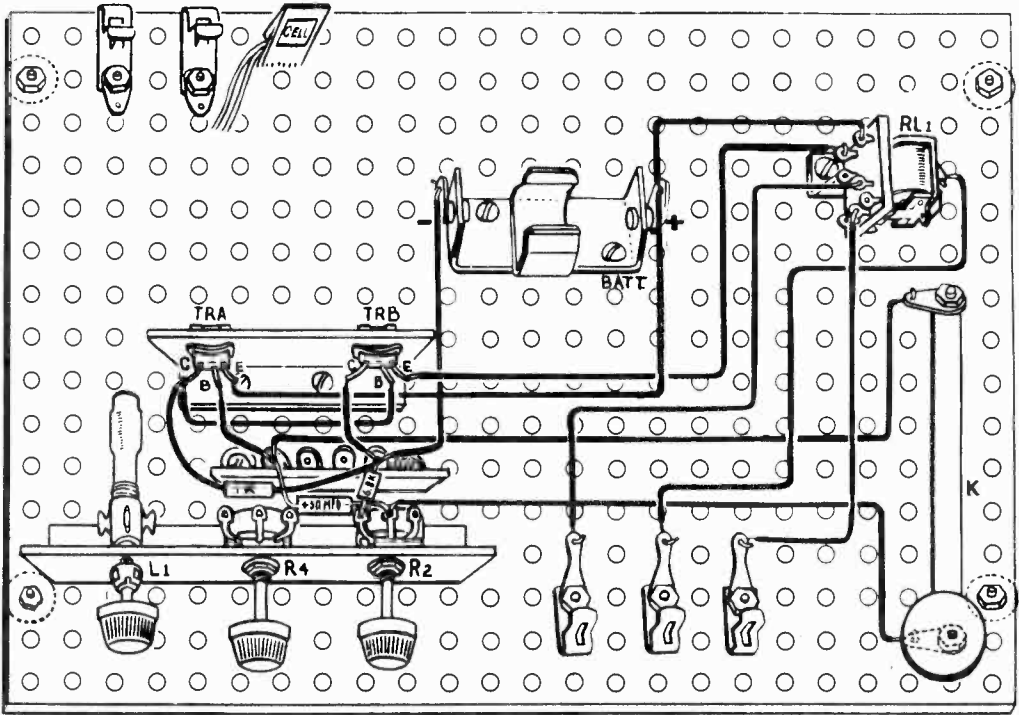

THIS simple timer, in common with many electronic circuits, operates on the principle of the *time constant* of a resistor-capacitor combination. In the drawings we see what happens when a capacitor, which comprises two conducting plates separated by an insulating material, is connected to a voltage source.

The plate connected to the positive side of the power supply loses electrons, which pass through the power supply and pile up on the negative plate. This difference in electron charge between the plates is equal to the voltage of the power supply.

When the capacitor reaches this point it is fully charged, and the electron flow ceases. A definite period of time is required for the capacitor to reach this state, and this depends upon its capacitance. If a resistor is connected in series, the time will be even greater. With a higher resistance, less current will flow and the charging time will be greater.

In a resistance-capacitance series network, the time in seconds equals the product of the resistance and the capacitance. In this timer circuit, the resistance comprises R_1 and R_2 , and the capacitance is C_1 . The maximum charging time is therefore $(56,800 \times 0.000050)$, or 2.84 seconds.

In operation, transistor TR_a is conducting through R_1 and R_2 , thereby charging C_1 from the battery. During this time TR_b has no voltage on its base and is therefore not conducting. But when C_1 becomes fully charged, TR_a will stop conducting and the battery potential will appear across its collector and emitter. Since these two elements are connected respectively to the base and emitter of TR_b , that transistor will begin conducting and thereby energize the relay, whose winding is in series with the emitter.

A pilot light and battery, or some other suitable indicator, can be connected across the relay contacts. Depressing the key will discharge C_1 and prepare the circuit for another cycle.

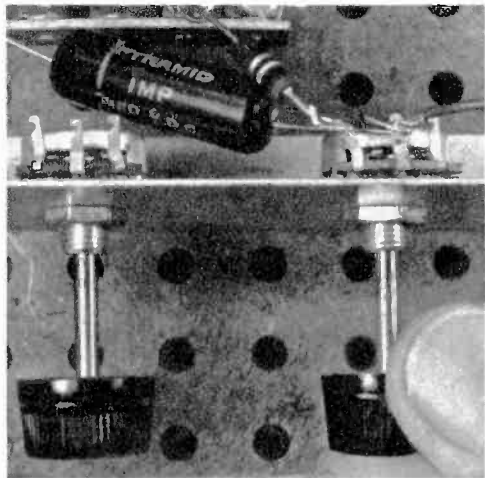

The three RC time-constant components include fixed and variable resistors plus capacitor.

Cycle is timed with stopwatch, beginning with closing of key and ending with click of relay.

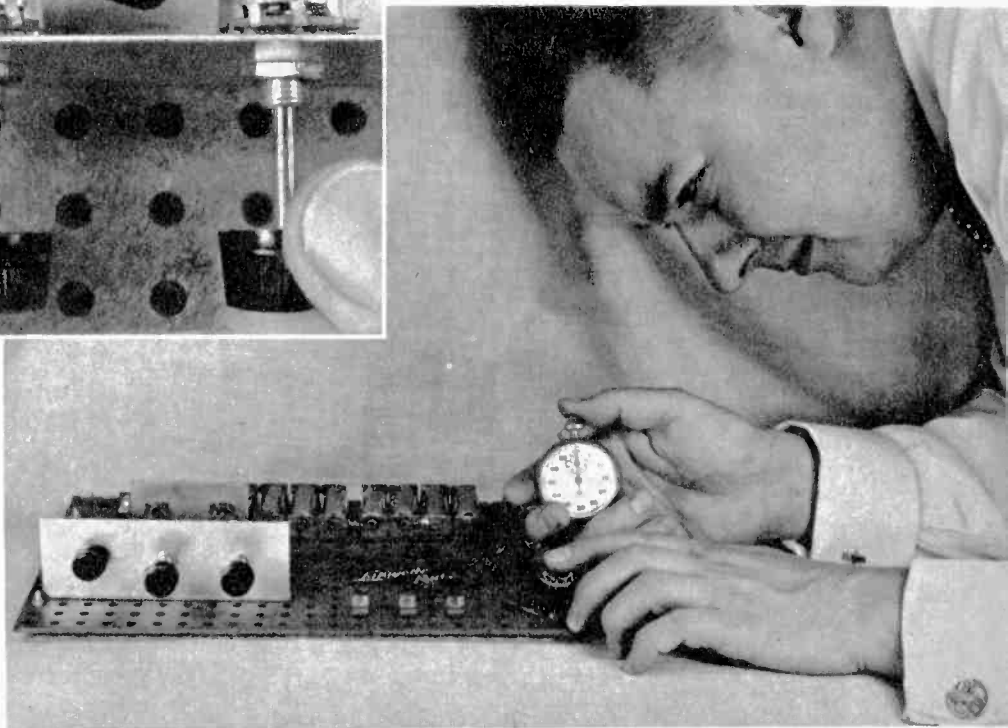

[Continued from page 81]

sort of sensitive transducer along with a high-gain amplifier, to obtain a voltage for the operation of a control circuit.

In controlling the temperature of an oven, for example, the magnitude and the polarity of the voltage will indicate the amount of divergence from normal, and also its direction, whether above or below the norm. If the oven is heated electrically, the control signal could be fed to an electronic circuit directly in series with the power supply line to the oven. With other types of heating some sort of electromechanical device would be required, such as a solenoid coupled to a gas valve.

Electronics is also frequently employed as a method of feed control. Many continuous processes require the repetitive filling of a container with powders, chemicals, ink, paint, or in the case of packaging, the product itself. The level of the container is measured by throwing a light beam across it onto a photocell at the proper level. The photocell signal goes to an amplifier, which may operate a relay to control the feeding device. When the container level is too low, light falls on the photocell and the system calls for more material. But when the proper level is restored, the material will cut off the light from the cell, the photocell output will drop, and the feed mechanism will be shut off.

Another method of feed control is used

in the reeling and unreeling of materials. Printed labels and wrappers, for example, are usually printed first on long rolls of raw stock, and then cut to size. But in the cutting process it is most important that the cutter always remain correctly in register with the printed pattern. Without some method of control, however, this can often go askew, because of slippage, shrinkage or stretching.

This problem is also overcome electronically with the help of registration marks, such as black bars, printed at appropriate intervals along the edge of the stock. A photocell system "reads" these marks, and develops a signal which either controls the feed motors on the reels, or tells the cutter itself when to slice. Next time you finish a loaf of bread, open out the waxed paper wrapper into a flat sheet. Chances are you will find registration marks just such as we have been discussing.

Test and Inspection

Electronics is a very useful tool in quality control, for testing and inspection of products. A good example is in the checking of the lacquer coating of so-called tin cans used for food containers. Since the lacquer prevents spoiling of the food by contact with metal, it is important that the coating be continuous. One way of checking this employs a principle similar to that

Drawing shows workings of electric eye movie camera. Light reaches photocell, generates electric current which activates meter to adjust lens.

Bell & Howell Co.

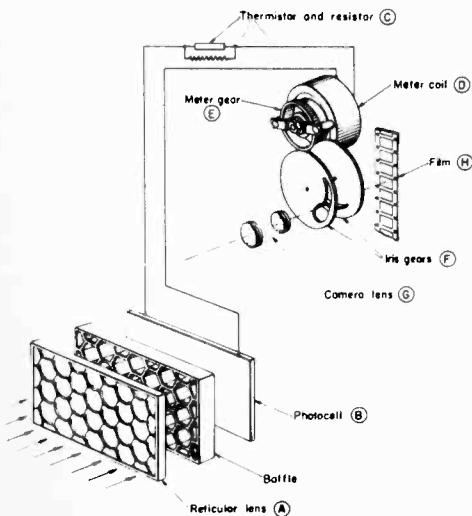
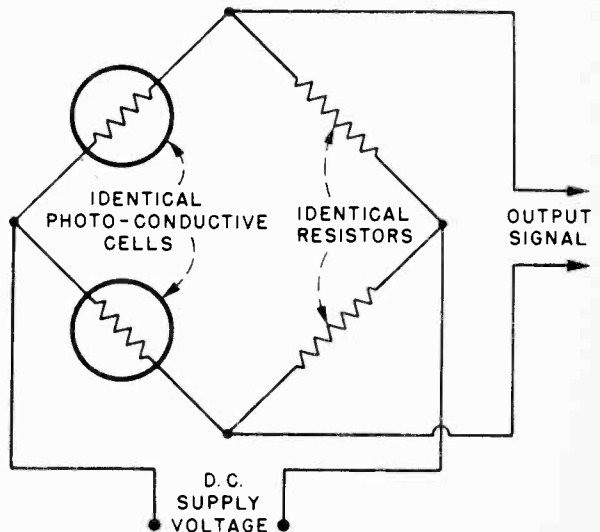
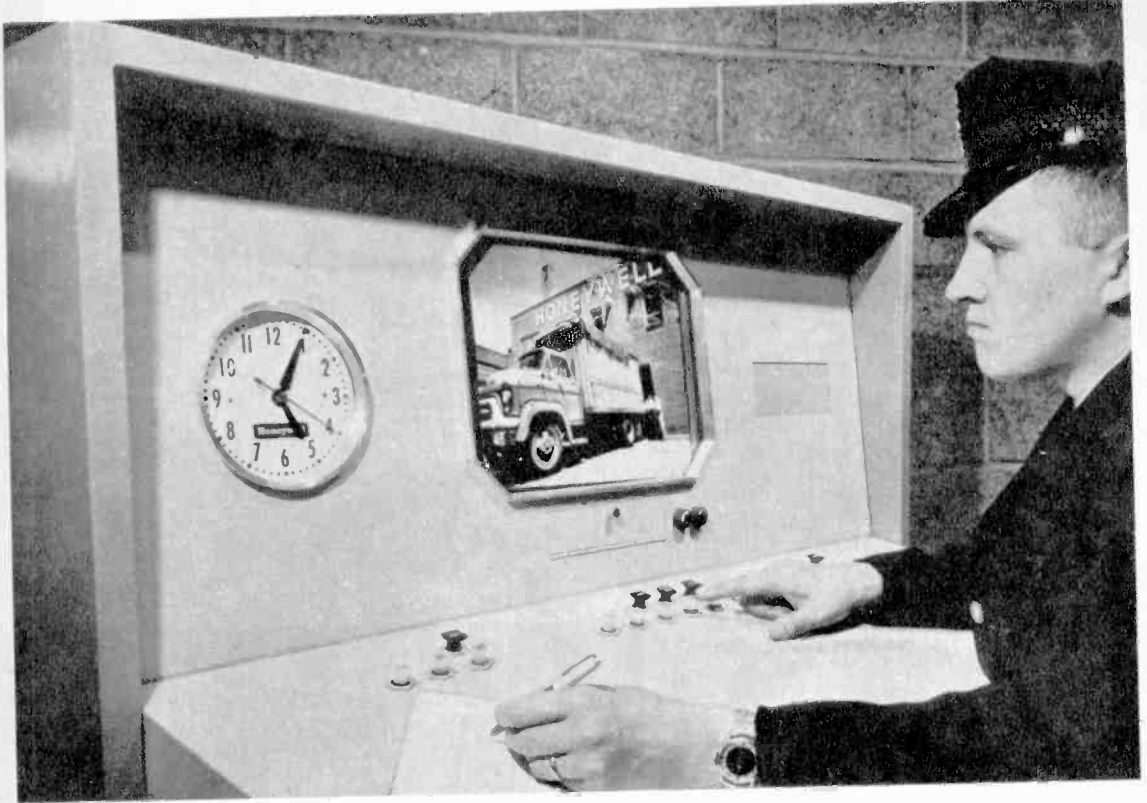

FIG. 1. Schematic of Wheatstone bridge circuit. A pair of photo-conductive cells are used in the circuit below for highly accurate color matching.



Nerve center of building protection and security system is this centralized console. Single guard supervises entire building security, checks for fires, intruders and visitors. Board has closed-circuit TV.

Minneapolis-Honeywell



in Experiment No. 13. The can is filled with salt water, an electrode dipped into the water, and a voltage applied between the electrode and the outside of the can. If the lacquer coating is not perfect, conductivity will go up and the resulting voltage will operate a control circuit to kick the can into the reject pile.

Our old friend the photocell has innumerable applications in testing and inspection. It can determine that a hole has been drilled correctly, or find imperfections on the surface of a machined part by gauging the reflected light off its surface. Another application is found in the paint industry. Varnish is prepared by mixing the proper amount of pigment stain with a clear varnish base to produce the desired varnish tone. But since the strength of the stain varies from batch to batch, it was once necessary for the proportions to be determined by a human expert matcher.

With the advent of the photocell, the process became entirely automatic. The
[Continued on page 88]

Magnetic numbers printed on checks, etc., make sorting and accounting automatic when they pass under the magnetic heads of special machines.

International Business Machines



EXPERIMENT 13

Building a Rain Alarm

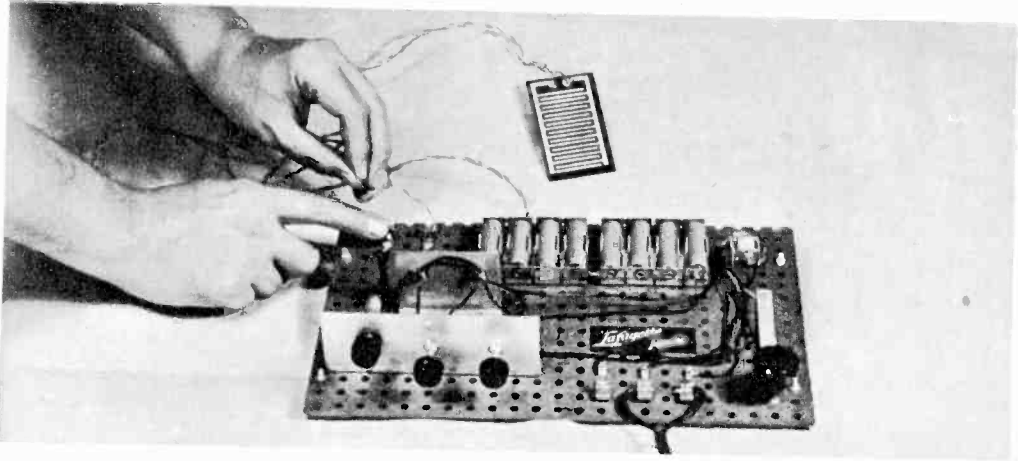

Sensing element being connected above is etched, with adjacent conductors separated.

Sensitivity can be adjusted indoors, using water from a medicine dropper, as below.

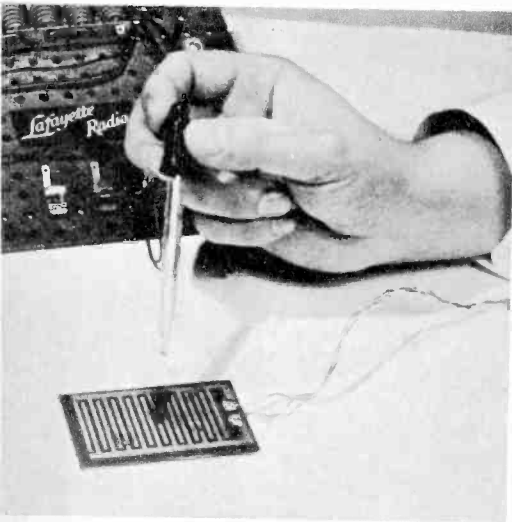

Sensing plate is mounted outside, in path of raindrops (right). Red lamp is signal.

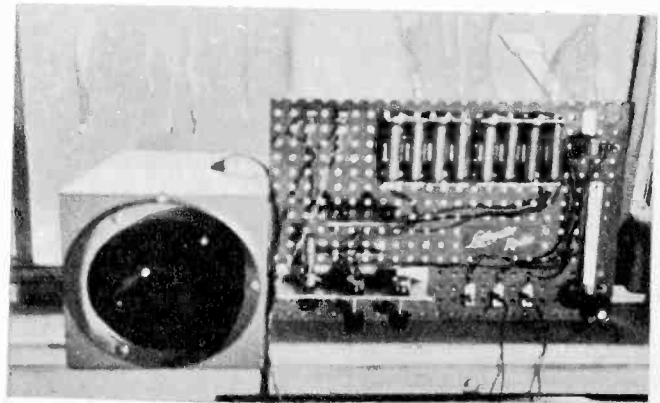
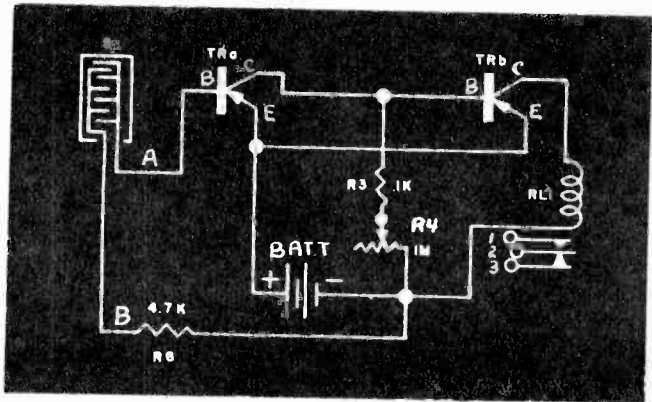

THIS rain alarm will detect anything from a light drizzle to a downpour, depending upon the sensitivity adjustment. The sensing plate included with the Lafayette kit shown here is made by the etched-circuit process, with the interlocking conductors separated by the insulating circuit board.

As long as the sensing plate is dry, its elements are not conducting, and no current can flow between points A and B on the circuit diagram. Transistor TR_A is therefore not conducting. The sensitivity control R_1 is then set so that TR_B does conduct. This will energize the relay, whose response will be noted by a clicking sound and the movement of the contacts.

When rain wets the sensing plate, it becomes partially conductive, at least to the point where some voltage appears at the base of TR_A . This transistor then starts to conduct, with the result that the potential on its collector drops.

Since the collector of TR_A is connected to the

base of TR_B , this voltage drop appears at the base of the second transistor as well. The result is a lowering of the conduction of TR_B , a decrease in its collector current, and hence the de-energizing of the relay. An indicator lamp or audible alarm connected to the relay contacts will then operate to indicate the presence of rain.

This experiment once again brings into play the idea of relative voltages discussed in Experiment No. 2. As long as TR_A is not conducting, the voltage on its base relative to its emitter will be zero.

The emitter-collector relative voltage will depend on the voltage drop across R_3 and R_4 , and this in turn will depend on the current flowing through TR_B .

When TR_A conducts, all relationships change. Its base voltage is limited by the current flow through R_1 , and the TR_B base voltage drops because of the additional current through R_3 and R_4 .

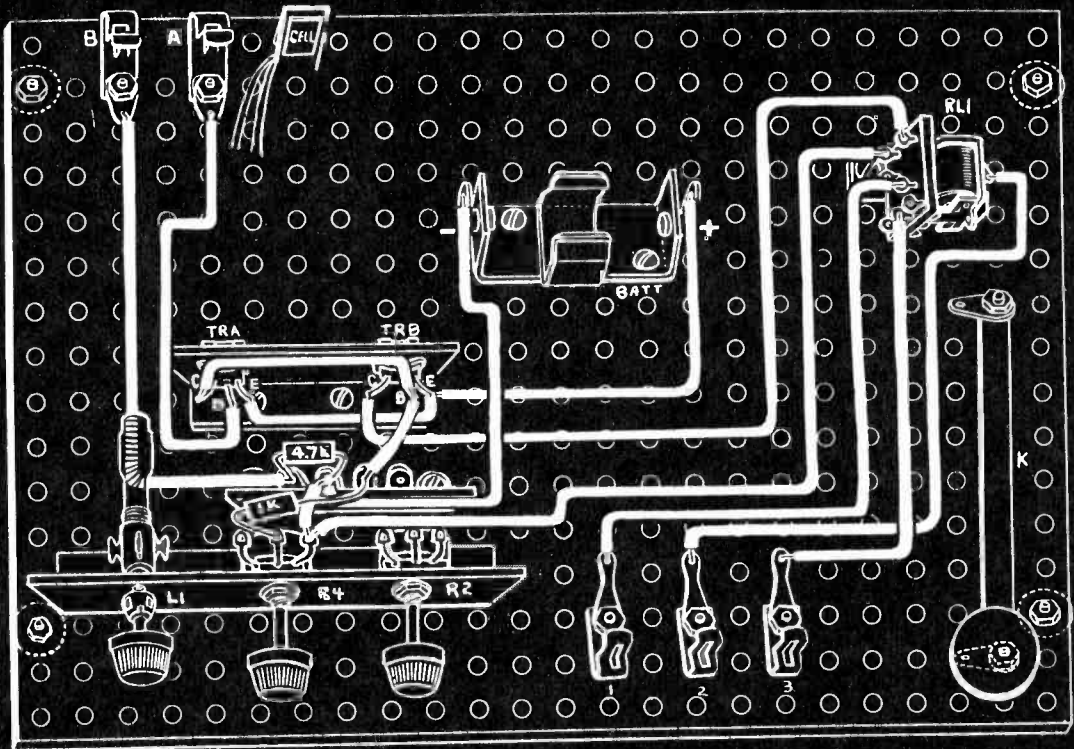

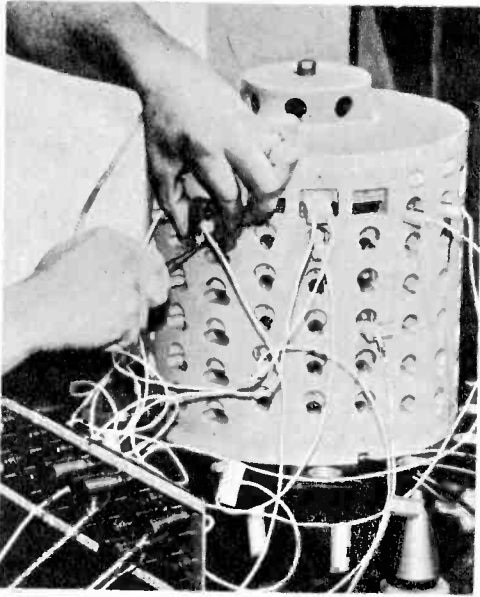

Magnetic drum, above, for automation computer stores all necessary mathematical information and operational data for control of machinery.

Riverside Cement Co.

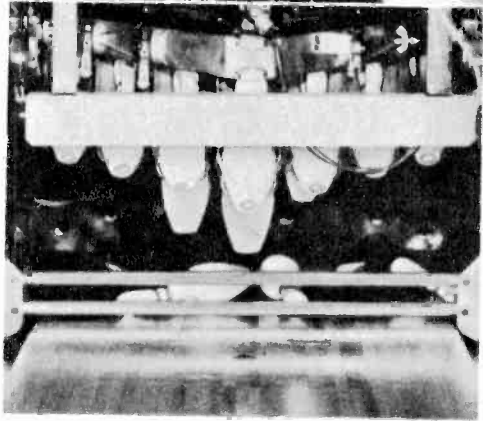
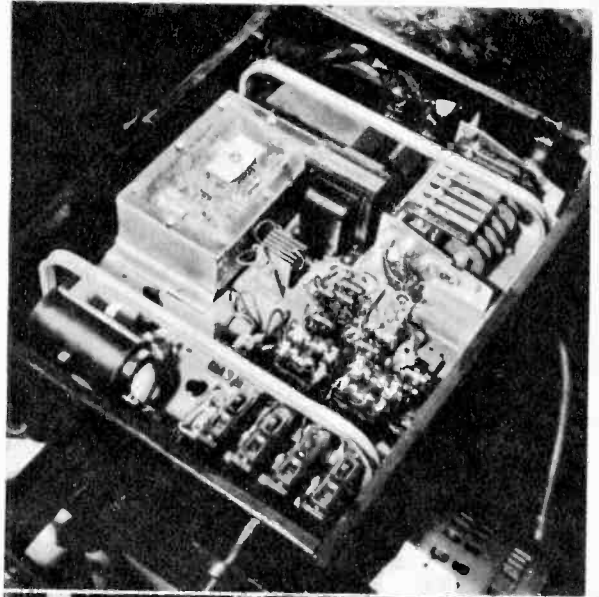

Top right and right, electronic pinspotter has "brain" which guides the machine through each game, leaves correct number of pins standing after clearing off deadwood. It reloads, returns the ball, etc., operates everything automatically.

American Machine & Foundry Co.

[Continued from page 85]

varnish comes out of the mixing vat into a transparent pipe or trough. Light is passed through it onto a photocell, whose output signal controls the valve between the stain supply and the mixing tank. Thus the color of the mixture is maintained to a fixed standard, accurately and automatically.

Three-Color Matching

An even more elaborate photoelectric color matching system is used in the printing and textile industries. This uses two photoconductive cells in a Wheatstone bridge circuit, as shown in Fig. 1. With equal illumination on the two cells the bridge is "balanced" and no current flows in the output. But when one cell receives an excess of illumination, there will be cur-

rent in the output, the polarity of which will indicate which cell is more brightly illuminated.

In color matching the bridge is used with a set of primary color filters on the light source. A standard color plate is fixed to reflect light on one of the cells, while the color to be matched is caused to reflect on the other. Then red pigment is added to the sample color until the output signal drops to zero, indicating a balance of the bridge, and also indicating that both the sample and the standard have equal amounts of red. The same process is repeated with filters and pigments of the other two primary colors. Finally, the filters are removed and a pure white light used as the source. Then black or white pigment is added to the sample to produce



Hughes Aircraft Co.

Automated line of machine tools is controlled by means of these punched tapes. Objects shown on top of tapes were produced by this process.

Automatically operated profiler for cutting aircraft parts, below, is operated by metallic punched tapes containing all the pertinent blue print data.

Republic Aviation Corp.

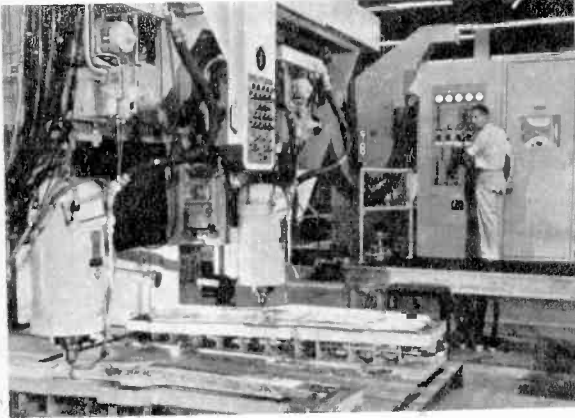

the same intensity as the standard. Thus the sample becomes an identical match to the standard, both in color and intensity. This type of photoelectric matching is much more accurate than can be done with the human eye, and it will be accurate under all types of light, both artificial light and sunlight.

An extensive use of electronics in industry is in the heating of objects by radio-frequency energy. Two methods are used, depending upon the electrical conductivity of the material to be worked. If the material is a good conductor, it is placed inside a coil carrying R-F current, and heat is generated by the eddy currents thereby induced. If the material is a poor conductor, however, it is placed between two electrodes which then act as the plates of a ca-

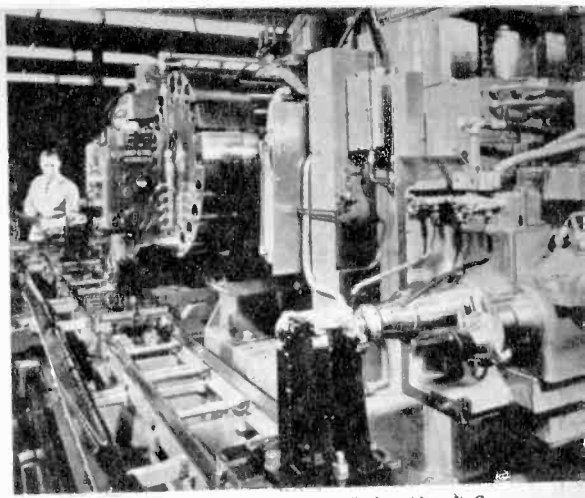

Hughes Aircraft Co.

These are the machine tools—milling, drilling, boring machines—that are electronically controlled by the tapes shown in the photo at left.

pacitor, while the material itself acts as the dielectric.

R-F Heating Applications

Electronic heating of either type is quicker, cleaner, more uniform, and can be accurately controlled as to amount and duration. Dielectric heating, which usually operates in the vicinity of 200 megacycles, is often employed in the heat treatment of wood, textiles and plastics. Induction heating operates at lower frequencies, between 250 kc and 2 mc, and is especially useful in various forms of metallurgical treatment, such as hardening, tempering, melting, soldering and brazing.

Going further down in frequency we come to the many ultrasonic devices, which usually operate in the range from 15 to 25 kc. Their job is to impart a vibration to a material for some specific purpose. One application is the ultrasonic soldering iron, whose vibration prevents the formation of difficult oxides on some materials, especially aluminum, which otherwise prevent the molten solder from alloying with the metal. The ultrasonic drill is very useful in cutting holes in hard, brittle materials, such as glass, ceramics and crystals. When the drill, which is of a relatively soft material, is given a reciprocating motion by ultrasonics, it can agitate an abrasive slurry and so work its way right through the most brittle materials. The field of ultrasonics is one in which the surface has hardly been scratched, and it holds promise of becoming one of the most important factors in industrial electronics. •

Chapter 8

LISTENING TO THE STARS

Radio astronomy

FOR a half-million years or so, earth-bound man has been trying desperately to unlock the secrets of the universe in which we live. How big is it? What is its shape? Just what is going on out there? Are there other unknown creatures who speculate about the possibility of our existence? Or do they already know all about us? And for the more philosophically inclined, just how important are we mere mortals to the overall scheme of things?

The answer to the first question, in ancient times, would have been that the universe was confined to the 5,000-odd stars visible to the naked eye on a perfectly clear night. But with the invention of the telescope, even Galileo's little pocket-sized one, 500,000 new stars were brought into view. When the 100-inch reflecting telescope went into service on Mount Wilson, the known size of our universe was multiplied by a factor of 125,000!

It continues to expand at a fantastic rate as we learn still more from the 200-inch mirror of the Hale telescope at the Mount Palomar observatory, the world's largest. Still, we seem to be reaching a point of greatly diminishing returns with these gigantic optical devices. They are fantastically expensive, and they still leave many questions unanswered. Perhaps the biggest question of all is, where do we go from here in our endless quest for knowledge of the universe surrounding us?

Most of us can recall hearing news of Palomar for the greater part of our lives. Having been twenty years in the planning, testing, and construction stages, it finally went into service in 1948. And in the same year that Palomar began unlocking still more mysteries of the universe, by strange coincidence it was joined by a wholly new and quite different instrument, the radio telescope.

Within five years, in 1953, a radio telescope had penetrated six billion light years into space, much further than man had ever been able to go with optical telescopes. Now scientists believe it will be possible to build a radio telescope large enough to measure exactly the full outer limits of the universe!

The radio telescope has several advantages over the older optical type: (1) it can tune in on stars which give off only faint light, or even no light at all, and are thus invisible to optical telescopes; (2) it can penetrate right through the clouds of "cosmic dust" and gases that fill vast areas of outer space and prevent optical telescopes from seeing what is beyond them; (3) it can be used in any kind of weather, either day or night; (4) it is much less expensive to build than an optical telescope.

The radio telescope is a radically different astronomical instrument, but it still has some similarity to the older optical type. It uses a receiving antenna, whose "mirror" is often a parabolic dish reflector, with its elevation and bearing variable just as with an optical telescope mirror. Using a sensitive and selective receiver, the radio astronomer may thereby detect and track electromagnetic signals arriving from outer space.

Radiomen have long experienced the effects of extraterrestrial phenomena on communications. So-called static noise has always been with us. Changes in the ionosphere cause the choice of a radio frequency for transmission over a given distance to vary considerably between day and night. The rapidly changing conditions occurring during the sunrise and sunset hours often require quite a bit of fancy frequency shifting.

Another phenomenon which has been noted, particularly around 30 megacycles, is reflections from *meteor trails*. The effect is a sudden burst of intensity in received signal, and is explained by the reinforcement of a reflection from the ionized trail from a meteor. When the meteor enters the earth's atmosphere at high velocity, it heats by friction and leaves behind it a trail of ionized particles. Usually only a second or less is required for the particles to recombine, but while they are in the ionized state they act as excellent reflectors of radio waves.

Meteor trails are not normally very useful for improving communications, of course, except in the rare cases of "meteor showers," when repeated reflections can

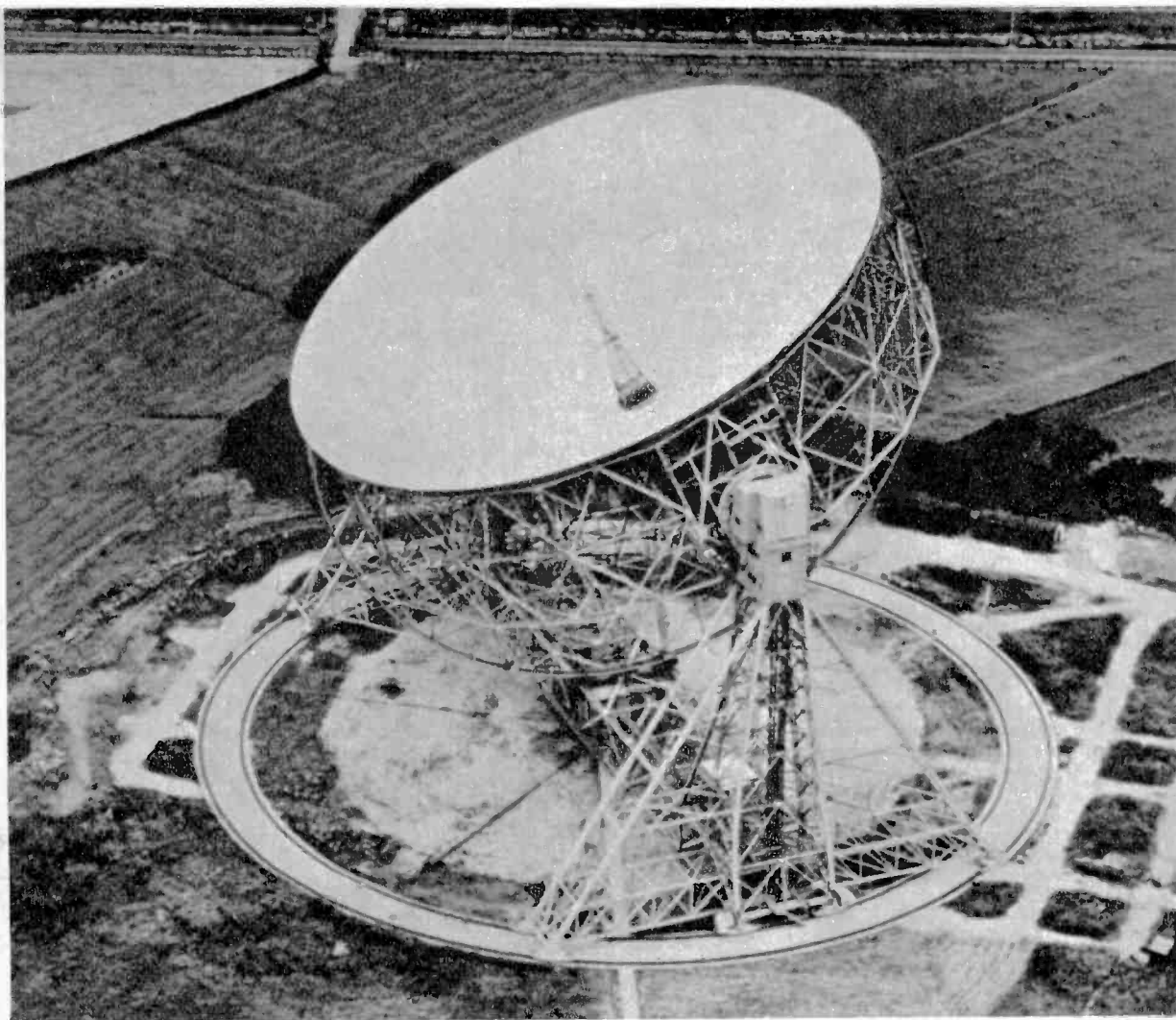

British Information Services

Jodrell Bank radio telescope is the largest steerable in the world. Built in the countryside to avoid electrical interference, it boasts a 250-ft. diameter reflecting bowl mounted on two 175-ft. high towers. Revolving on a circular railroad track, the huge bowl can be rotated and turned in any direction to collect radio echoes from planets, stars and galaxies for a distance of up to one thousand million light years away.

British and American scientists often work together at the Jodrell Bank Experimental Station, a part of the University of Manchester. Much of the space-vehicle, rocket and satellite tracking is done right here from this room.

British Information Services

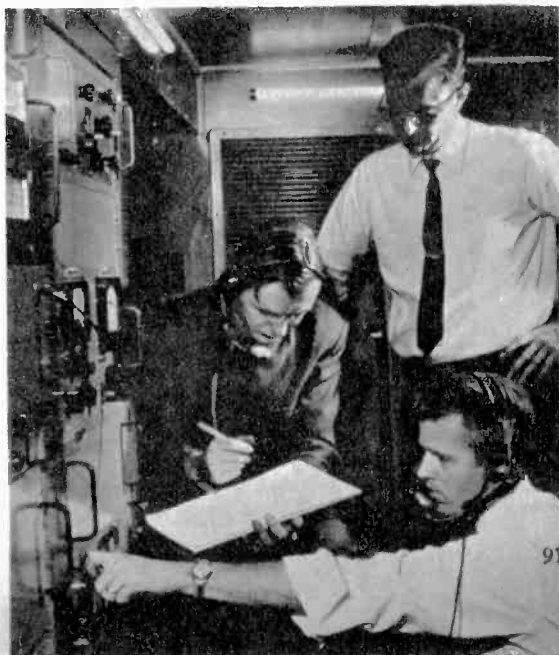

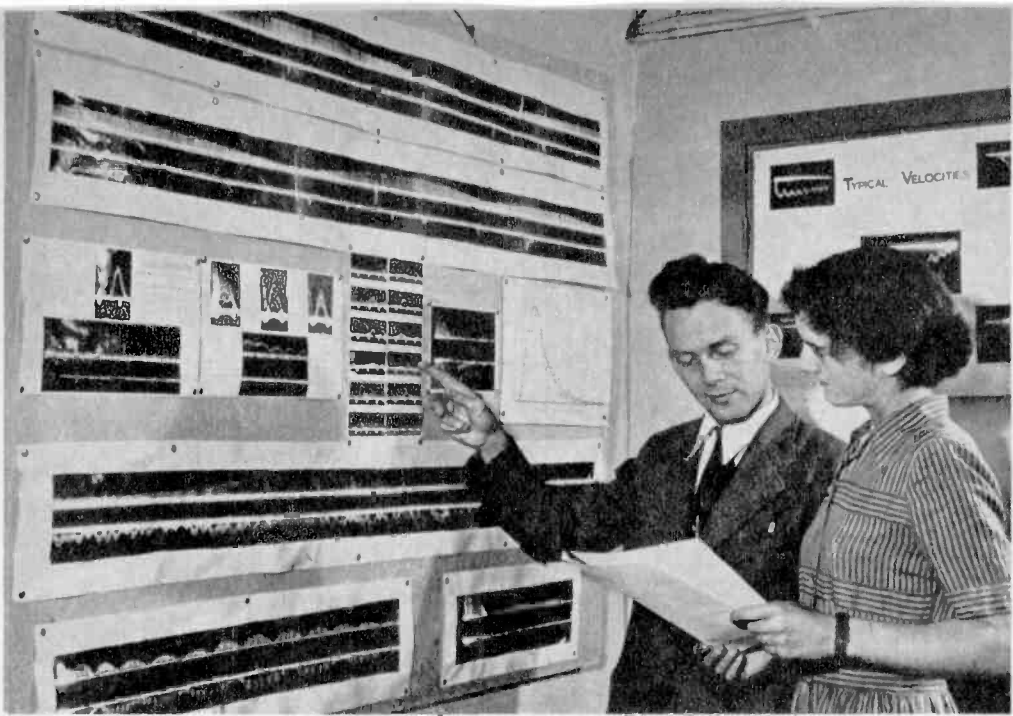

British Information Services

In the radio-telescope receiving hut of the Jodrell Bank telescope, recordings of radio "noise" received during the past 24 hours are checked and analyzed daily, incidental noise is eliminated, and results compared to those received on previous days. The star signals are approximately the same day by day.



Harvard College Observatory

In the United States, radio telescopes such as this one at Harvard University are used for space research. The unit has a 60-ft. diameter bowl.

make possible some long-distance work. Reflections are used consistently, however, in the system of *tropo scatter*, a brute-force method of communication in which very powerful signals are thrown against the troposphere, and while only a fractional part of them are reflected, they do prove useful for consistent communications. Reflections also were indispensable in the famous Signal Corps experiment, in which a radar system received its own signals which had bounced off the Moon.

That there are many such cause-and-effect relationships between electromagnetic radiations and outer space has been known for years, but it has only been comparatively recently that any effort was made to correlate or utilize these facts. In 1931, a Bell Telephone Laboratories engineer noted that radio waves were being radiated from the far reaches of the Milky Way. These were not intelligible signals, of course, but rather radiations from the stars themselves. Since they simply appeared to be random noises, nobody paid much attention to them at the time.

While at first it might seem hard to imagine a star or planet acting as its own broadcasting station, on further reflection it seems quite reasonable. For if these



Mt. Wilson and Palomar Observatories

Strong radio signal source is shown in this photograph taken through 200-inch telescope. It is NGC 1275 in the Perseus Cluster of galaxies.

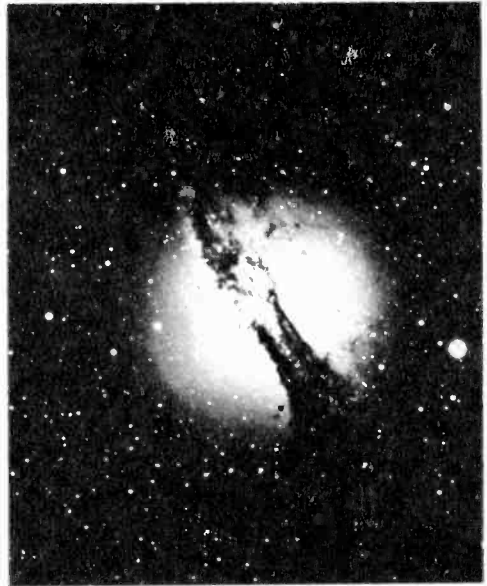

Mt. Wilson and Palomar Observatories

Catalogued as NGC 5128, this object may be two gigantic galaxies in collision and is a probable source of radio signals. 200-inch photograph.

bodies are able to radiate light waves and cosmic rays, doesn't it seem likely that they might also operate at longer wavelengths, down in the radio region? But even granting that premise, we still must find some use for the information.

Remember that the thousands of tiny twinkles we see in the sky on a clear night don't really disappear in the morning. But while the optical astronomer has to close up shop with the rising of the sun, the radio astronomer can "see" right around the clock.

Furthermore, the light we see from these heavenly bodies is of two types, reflected and transmitted. In our own solar system, for example, sunlight comes to us directly from the huge ball of fire which the sun is. Moonlight, on the other hand, is simply reflected sunlight bouncing off the cold moon. The same is true of the "starlight" of other planets.

But what of the many thousands of other twinkling lights in the heavens? How many of them are suns in their own right, and how many are simply reflectors of light from suns? And how many other bodies might there be, too cold to generate light on their own, or eclipsed in shadow, shielded from our prying eyes? These are

some of the questions which radio astronomy tries to answer.

Even the stars themselves have dark spots on or near them which have mystified astronomers. They have named these spots "dark nebulosities," but they haven't yet agreed what they are. But we do know that they generate radio signals, and in time the radio telescope will enable us more accurately to determine their character.

Radio astronomers also discovered that there are indeed dark stars: While there had been no reason to rule out such a possibility, neither had there been any reason to suspect it. When the optical telescope was our only astronomical tool, such objects were invisible to us, and that was that.

We have learned that the sun and some of the planets of our own solar system are also generators of radio energy. This has revealed a great many things about the sun in particular. Because its outer atmosphere is invisible, only the radio telescope could discover that the total diameter of the sun is approximately a quarter-million miles greater than that indicated by optical measurements.

Radio astronomy is also used to deter-
[Continued on page 96]

EXPERIMENT 14

Tuning in on the Stars

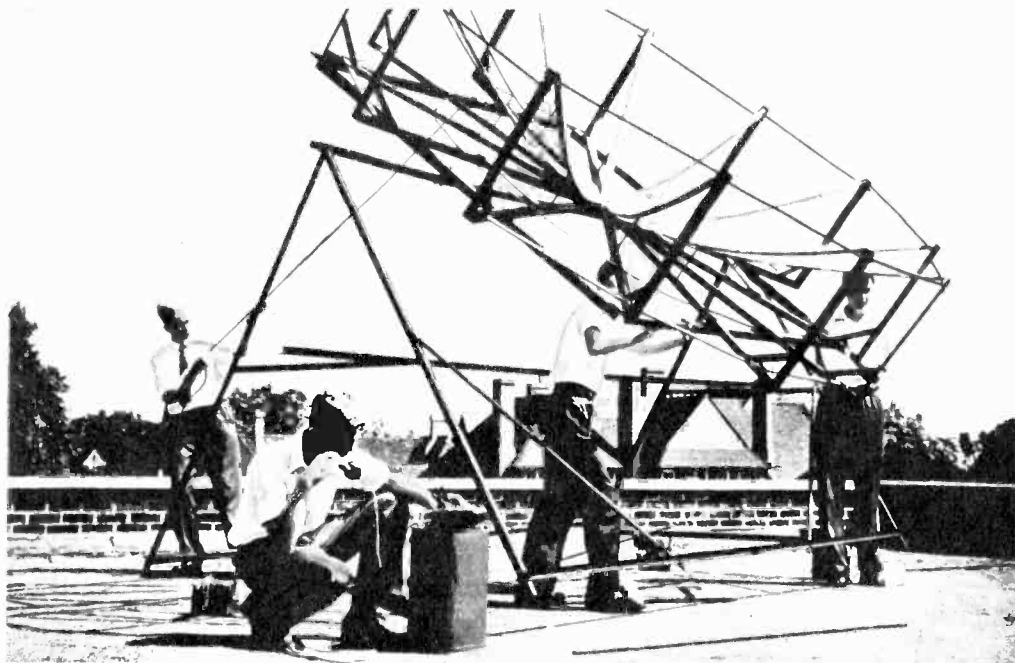

Electronics Illustrated

No basement pastime, radio astronomy requires group with like interests. Group of school boys here direct homemade radio telescope antenna by hand, while telephone contact is maintained with receiver.

Master control room is former closet, now houses radio telescope receiver converted from old TV set, plus oscilloscope for analysis of signals.

Dish reflector under construction. Metal frame supports netting covered with plastic, which reflects radio signals from space to antenna.

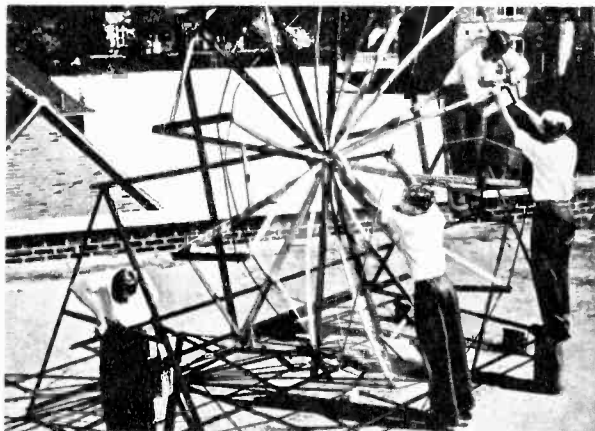
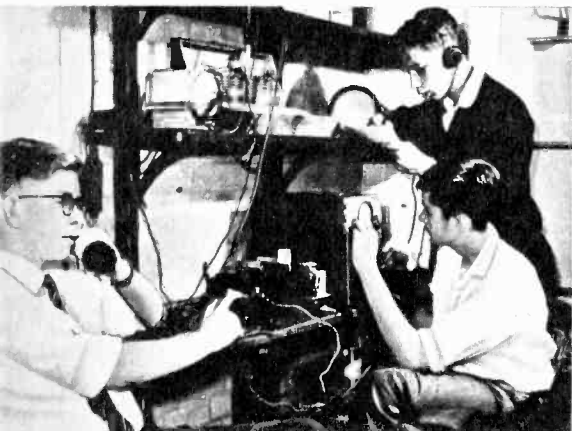

RADIO astronomy is such a complex subject, usually requiring such elaborate equipment, that it presents a real challenge to the experimenter-hobbyist.

That this challenge can be met, however, is amply proven by some of the pictures on these pages.

A group of schoolboys at Dartford Grammar School, near London, have built a radio telescope for the equivalent of about \$40. The antenna, which is manually directed, has a dish reflector 12 feet in diameter. No flash-in-the-pan, this antenna is a permanent fixture on the roof of the school.

The receiver is essentially a converted TV set. Since analysis of the signal is an important part of any serious radio-astronomical effort, the boys have an oscilloscope on the receiver output and hope soon to add a recorder. They have so far succeeded in pulling in signals from the Milky Way, our Sun and the constellation Sagittarius.

What equipment do you need for experimenting in radio astronomy? Well, first you must have an excellent receiving system. A communications receiver is best. Lacking that, you can use a discarded TV set. This will cover a band of frequencies roughly from 50 to 250 megacycles. The set should be modified for continuous tuning, however, rather than the step tuners in most receivers. Your antenna system must also be a

directional one and with as high gain as you can afford. A corner reflector is probably simplest. You can build this yourself of discarded window screening or use a commercial TV antenna of this type, similar to the one shown here.

The antenna is best aimed by eye; for with the comparatively primitive equipment you are using, if you can't see it, you certainly can't hear it. You may use an optical telescope to aid in aiming but never aim the telescope at the sun unless you cover the optics with welder's glass at both ends. Otherwise you will severely damage or even destroy your eyes.

The sun is your best bet, however, for your first radio astronomical observation. Its emissions are strongest and cover the widest range. The planet Jupiter is quite good at a number of points between 18 and 30 megacycles. Venus is a good emitter too. Strong signals are emitted from the "fuzzy" area of the constellation of Orion, and many signals, including the Crab Nebula, are to be found in the vicinity of 1,200 megacycles.

But when we speak of strong signals remember that this is only a relative term. As compared to man-made transmission, all space signals are exceedingly weak. It is difficult to distinguish them from ordinary noise. But it can be done, as proven by this group of schoolboys. Keep trying!

British Information Services

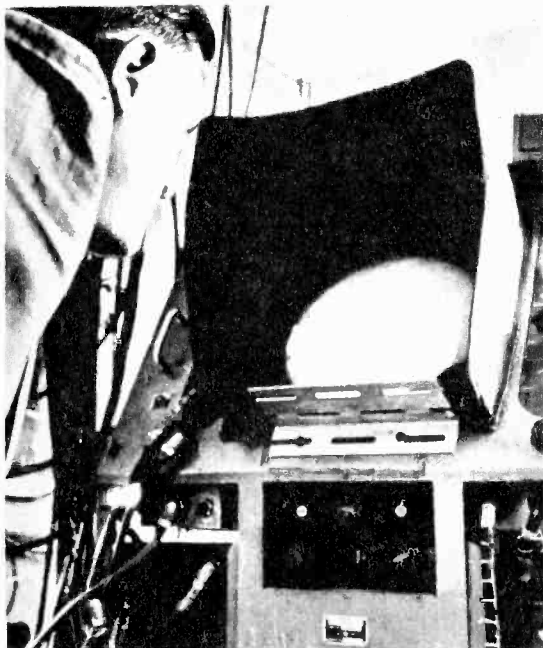

Oscilloscope is indispensable for analysis of signals. Huge screen here is at Jodrell Bank, England. Signals are from Andromeda nebula.

In the absence of adequate dish, even a corner reflector will suffice for some astral signals. Make it yourself or use commercial TV antenna.



JFD

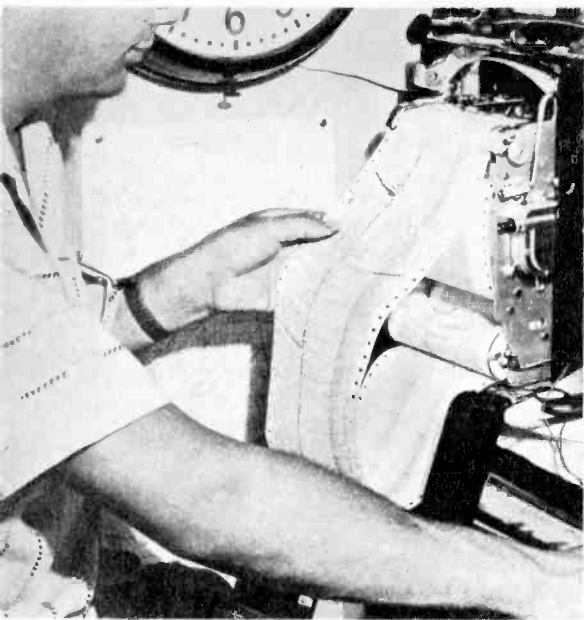

Convair, General Dynamics Corp.

Inked graph record of radio "noise" collected by radio telescope is examined. Peaks on paper mark Cygnus A, second brightest radio object in sky.

[Continued from page 93]

mine the speed and direction of radiating bodies in the far reaches of outer space. The principle employed here is the Doppler effect, also used in optical astronomy and some types of radar. The phenomenon was first discovered in connection with sound, and that is still the easiest way in which to explain it.

Every one is familiar with the apparent change in pitch of a train whistle as the engine roars by. But to the crew and passengers riding that train, the pitch of the sound remains constant. Only when there is a varying distance between the source and the observer does the frequency appear to change.

The change will appear whether the observer or the source is in motion. If you are standing at a country railroad crossing, for example, the warning bell will sound constant in pitch to you, but to those aboard the train it will change abruptly as they pass. Furthermore, unless the train stops right there, they never will hear the bell at its correct pitch, nor will you ever hear the whistle correctly.

If the distance between the source and the observer is closing rapidly, more vibrations will reach the ear in a given time than are actually being produced. If the distance is increasing, less vibrations will be heard. Thus a moving sound source seems to make an abrupt drop in pitch as it passes.

One of the most important relationships

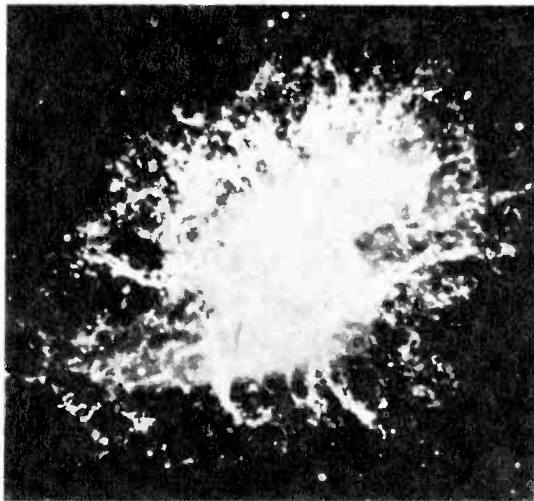

Mt. Wilson and Palomar Observatories

One of most spectacular radio sources is the Crab Nebula in Taurus. The star exploded in 1054 A.D., has been expanding since that time.

in any sort of wave motion, whether it be sound, radio or light, is between the wave length, frequency and speed. The velocity of any wave is equal to the product of the frequency and wave length.

Knowing this, let's see what happens to that moving train whistle. With a typical sound velocity of 1,140 feet per second, a train whistle sounding at 300 cycles per second would have a wave length of 3.8 feet. Now suppose that the train is moving at 45 miles an hour, or 66 feet per second.

Since the approaching waves have less distance to cover, the velocity of the sound will be less by the velocity of the train, or now 1,074 feet per second. The observed wave length then decreases to 3.58 and the pitch goes up to 318.4 cps. Similarly, as the train recedes, the wave length goes up to 4.02 feet, and the pitch drops to 283.5 cps.

Now if we know the actual frequency of the whistle sound, and were we to measure the observed frequencies, we could accurately calculate the speed of the train. This is the principle employed with light and radio waves in astronomy. Thus we can tell whether a star is approaching or leaving the earth by the way its color (light frequency) changes.

Similarly, the speed and direction of radio-emitting bodies can be determined by the Doppler shift of their signals. Hydrogen, for example, is the most abundant radio generator in space. Its frequency is

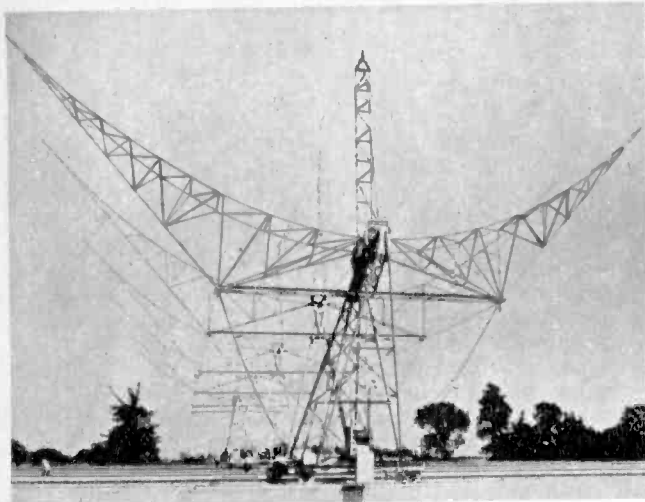

British Information Services

Radio telescopes take many strange shapes, as shown in this photo of the Mullard Radio Astronomy Observatory at Cambridge University, England.

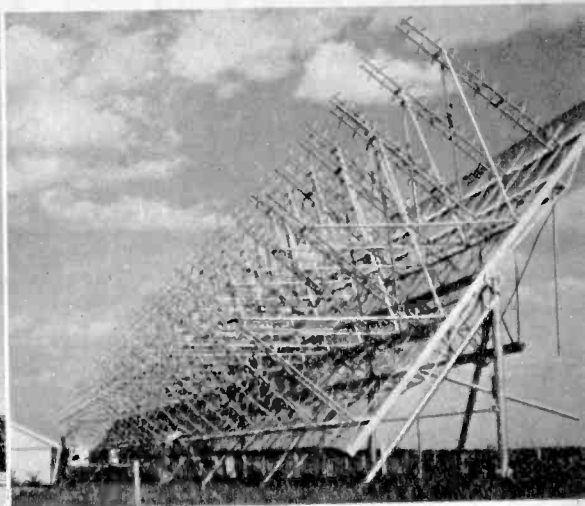

Electronics Illustrated

Ohio State University and National Science Foundation built this unusual looking radio telescope. The flat reflector features ninety-six coil antennas.

1,420 megacycles. The hydrogen signal of a body in space can therefore be compared with a laboratory standard hydrogen signal. If the space signal is higher in frequency than the lab standard, then the body is moving toward us, and if the frequency is below standard the body is moving away.

Radio astronomy has also been used to determine the precise way in which these signals from space are affected by the magnetic characteristics of the Sun's corona. When the sun passes between Taurus—a radio-generating constellation—and earth, a direct comparison can be made between the normal signal from Taurus and that deflected by the coronal magnetism of the sun.

Radio astronomy has also enabled us to determine the precise location of the solar system in the Milky Way, to determine the shape of our own galaxy, and to know that the vast areas in space between stars and nebulae consist of much more than just a vacuum.

And yet with all this we have barely scratched the surface. Even the most ardent researcher will agree that radio astronomy is still in a primitive state. But we are learning fast, and in another decade radio astronomy will have given us more new information than mankind had obtained throughout all of his previous recorded history. •

The National Bureau of Standards' telescope is part of two-dish setup which is used to record time difference of signals received by the two units.

International News Photos

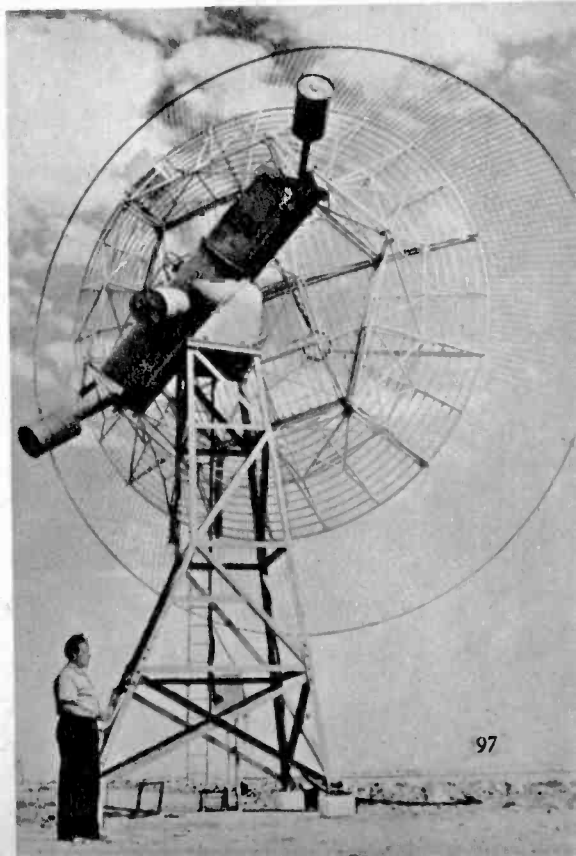

Chapter 9

ELECTRONIC MUSIC

Creating new sounds

THE present close affinity between the art of music and some of the physical sciences is a development of fairly recent origin. Although there is evidence to suggest that even the very early civilizations in Babylon, Chaldea, China, Egypt and India, as well as those of ancient Greece and Rome, were well acquainted with basic acoustic phenomena, physicists and mathematicians have been held in rather complete disdain by musicians, even up to the turn of this century. And the reputation was not undeserved.

It is true that Helmholtz and Lord Rayleigh made some notable contributions to our knowledge of acoustics during the nineteenth century, but for the most part when scientists toyed with the arts they behaved like fools. As recently as the Victorian era, for example, somebody tried to establish the theory of harmony on a purely physical basis. He argued that consonance and dissonance in chords depended solely on the degree of complexity of the vibration ratios of the tones. This fellow was on the right track, but since he

Radio Corp. of America

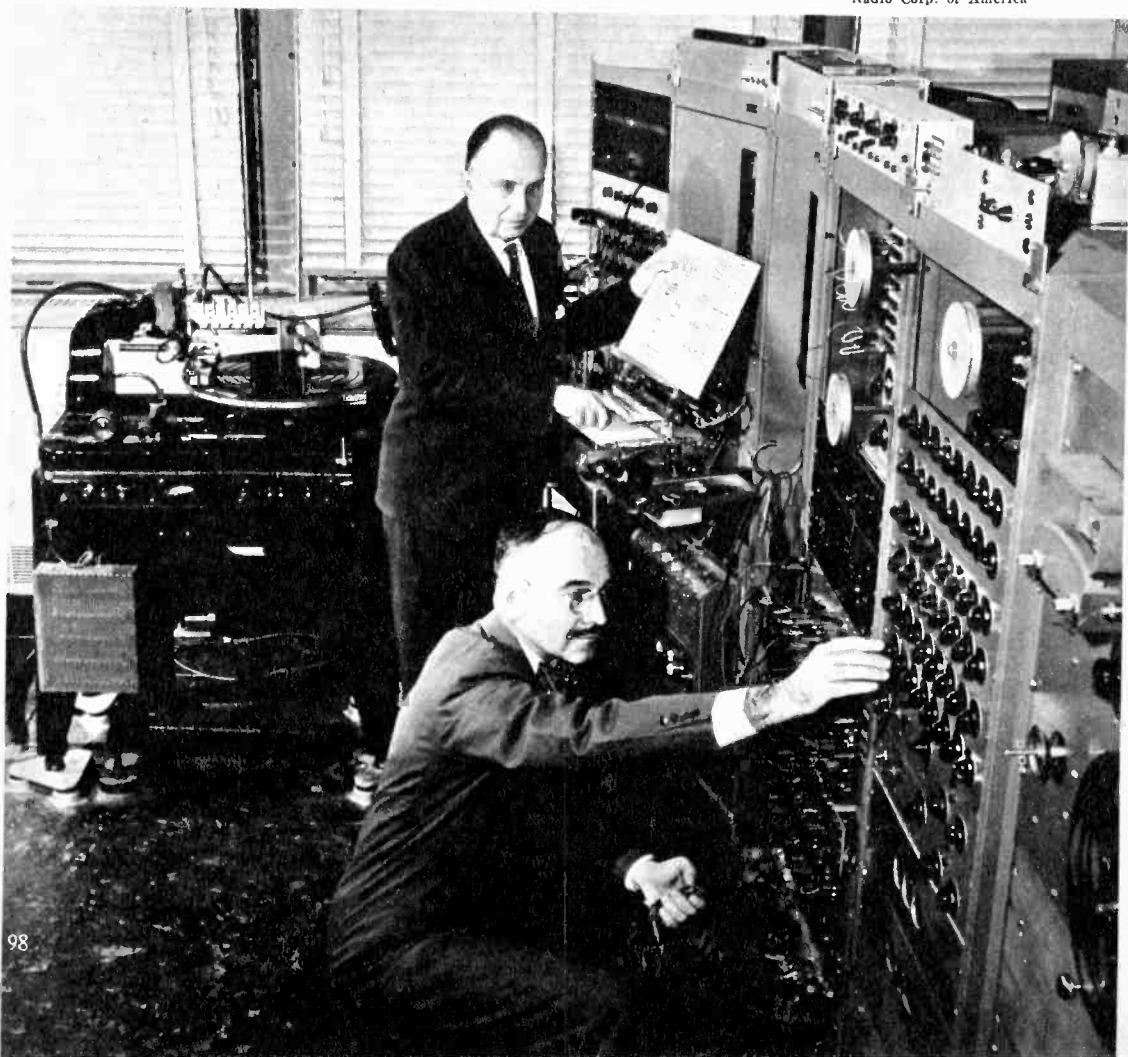

didn't take the human ear into account in his calculations, the musical results were absurd.

Scientific Ignorance

Another scientist who put his foot in his mouth as far as musicians were concerned was one Dr. Whewell, at one time the Master of Trinity College at Cambridge, England, and the author of a scholarly tome, *The History of the Inductive Sciences*. The good doctor is reported to have said that he simply couldn't understand how a violinist could produce harmonics on his instrument, without using a ruler to measure off the vibrating segments of his strings!

With attitudes such as this prevalent in the scientific community, it is no wonder that for a long time it appeared, as far as music was concerned, ne'er the twain shall meet. It was really the advent of electronics that acted as the catalyst. As music

became a staple item on radio, recordings, television and motion pictures, then, like it or not, the musicians and the scientists just had to get together to work out mutual problems.

There is one great scientist whose name is well known to nearly every popular musician. Ask any one what the name Schillinger means, and you will almost certainly be told that it is a system of harmony and arranging for dance bands. But this tells only a very small part of the story. Actually, the late Joseph Schillinger developed a wholly new theory of the relationship between the arts—all arts—and science. In his very erudite, *The Mathematical Basis of the Arts*, he said, "Originality is the product of knowledge, not guesswork. Scientific method in the arts provides an inconceivable number of ideas, technical ease, perfection, and, ultimately, a feeling of real freedom, satisfaction and accomplishment." When jazzmen can ac-

Radio Corp. of America

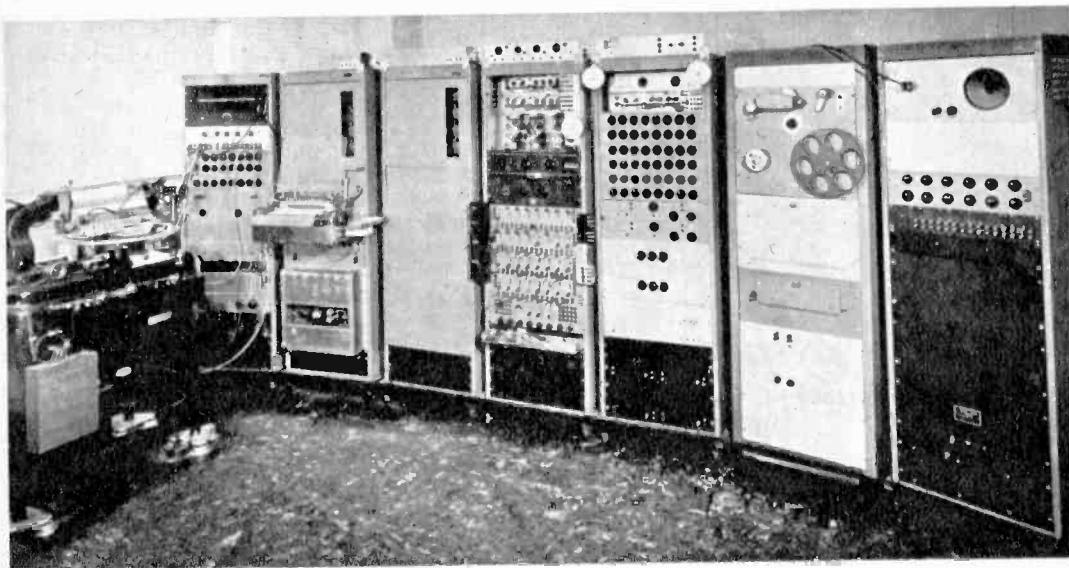

Radio Corp. of America

Electronic music synthesizer, above and at left, is capable of generating electronically any musical sound, including sounds of existing instruments or of instruments that have never existed. It has also a capacity for originating endless varieties of rhythms. Unit is operated by a synthesist (photo, left) who feeds the system information through coded paper punched at a keyboard. Output of synthesizer is recorded, a single series of tones at a time (photo, right), then mixed with other tones.

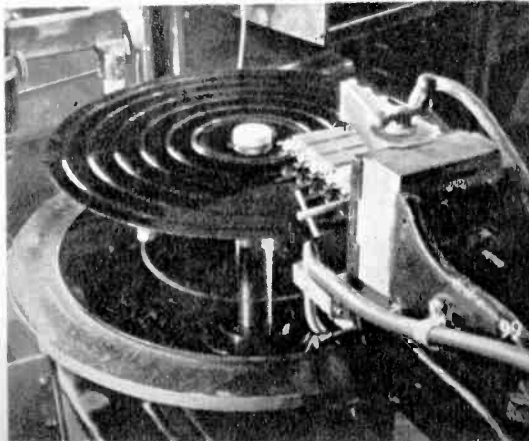

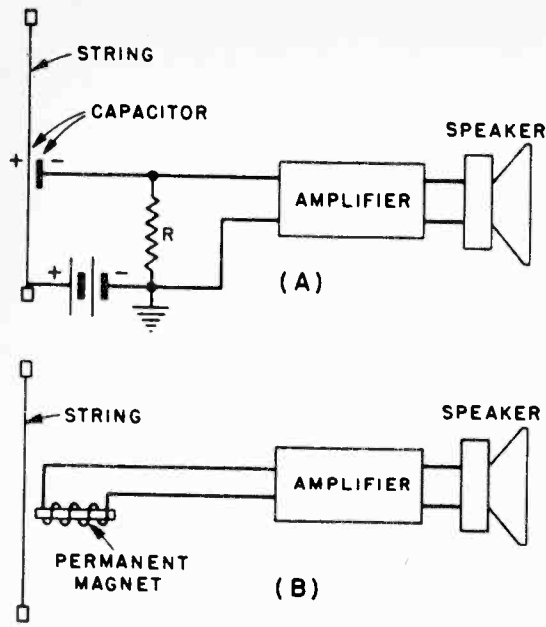

FIG. 1. Electrostatic (A) and electromagnetic (B) transducers in electric pianos. Similar tone systems are commonly used in the electric carillons, except for a difference in the type of vibrating bodies.

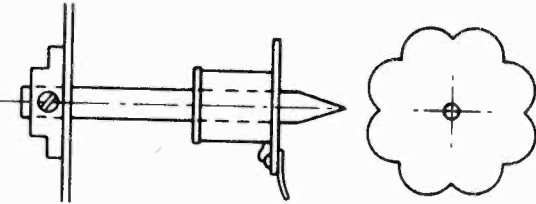

FIG. 2. Details of Hammond organ tone wheels.

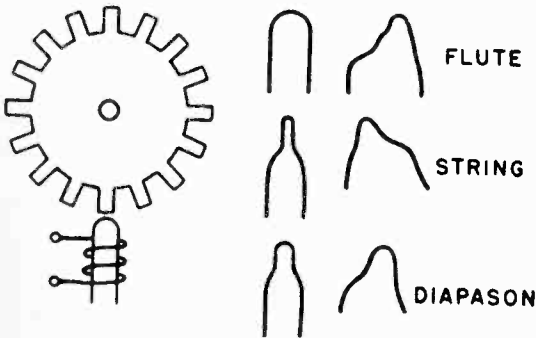

FIG. 3. Goodell and Swedien tone wheel and poles.

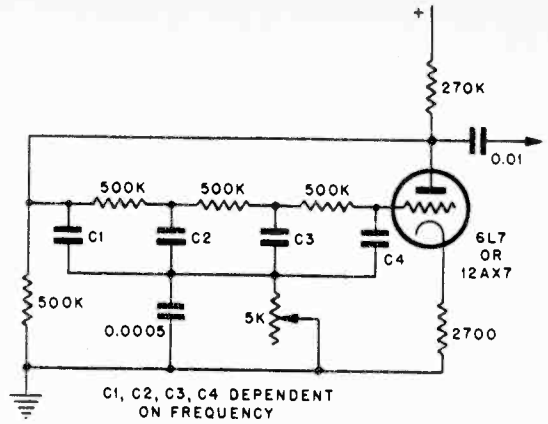

FIG. 4. Schematic of a phase shift oscillator

cept such a profound idea as that, there must be something to it.

Electronic Sound

The part played by electronics in the transmission, storage, and reproduction of musical sounds was discussed in Chapter 5. Now we are concerned with the original production of these sounds through electronics, both with and without the conventional types of musical instruments.

When used with conventional type instruments, the electronic contribution is confined primarily to audio amplification. The so-called electric guitar is a good example of this type. In its simplest form it is a conventional guitar with a contact microphone attached to its sounding board. Then the vibrations of the board are converted to electrical voltages by the microphone, amplified, and reconverted to sound by the loudspeaker. In guitars which are specifically designed for electronic amplification, a transducer is coupled directly to the bridge over which the vibrating strings are stretched. In this case the sounding board is much smaller, and usually contributes little to the actual production of the tone.

In other instruments, such as the electric piano or carillon, the vibrating element itself acts as part of the transducer. The mechanism of the electric piano is basically the same as in a conventional instrument, but the sounding board is replaced by an electrical counterpart. Conversion of the mechanical vibration of the string to electrical vibrations may be either by electrostatic or electromagnetic means.

As we see in Fig. 1(A), the string is one

plate of a capacitor. When the string is at rest, it will have a deficiency of electrons, because the battery has caused an excess of electrons to pile up on the fixed negative plate. But the actual amount of the charge (number of electrons displaced) will depend not only on the voltage, but also on the capacitance. And the capacitance is in part determined by the thickness of the dielectric, in this case the air space between the string and the fixed plate.

When the string is struck by its hammer and is set into vibration, the distance between the string and the plate will vary as long as the vibration continues. During this period the string and plate act as a variable capacitor, whose charge will vary with the vibration. This varying charge in effect acts as a varying voltage across resistor R and the input of the amplifier. The amplifier is then in effect transmitting the actual tone produced by the string.

Magnetic Pickup

In the electromagnetic system of Fig. 1(B), a permanent magnet has surrounding magnetic lines of force which extend into the area of the string. When the string vibrates, it cuts these lines of force and thereby induces a voltage in the coil. This voltage is then impressed across the amplifier input and finally reproduced by the loudspeaker.

More interesting, from a technical standpoint at least, are the various forms of tone generators, which by electronic means either imitate the sounds of existing instruments, or create entirely new sounds. In either case it should be understood that there are some types of generators which produce only the fundamental frequency, while others produce a fully shaped tone.

Bear in mind that any musical tone is not "pure," but contains not only a fundamental tone, but also a number of har-



Electronic Organ Arts, Inc.

The "Theater" two-manual organ is the most popular of 23 models produced by Artisan. They are sold in do-it-yourself kit form.

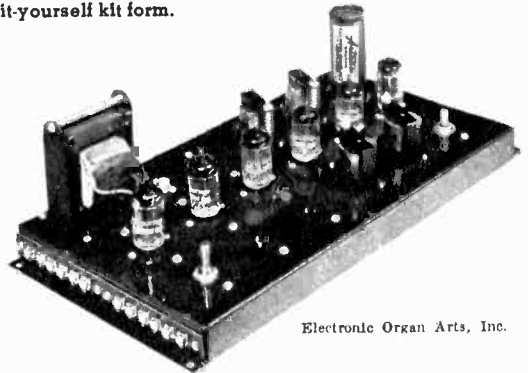

Electronic Organ Arts, Inc.

Top right. Each "stop" of the organ consists of a wave-shaping circuit with its preamp. Tone changer chassis has eight stops plus vibrato oscillator. Right. Artisan tone generator octave consists of 12 Hartley oscillators which produce all the harmonics.

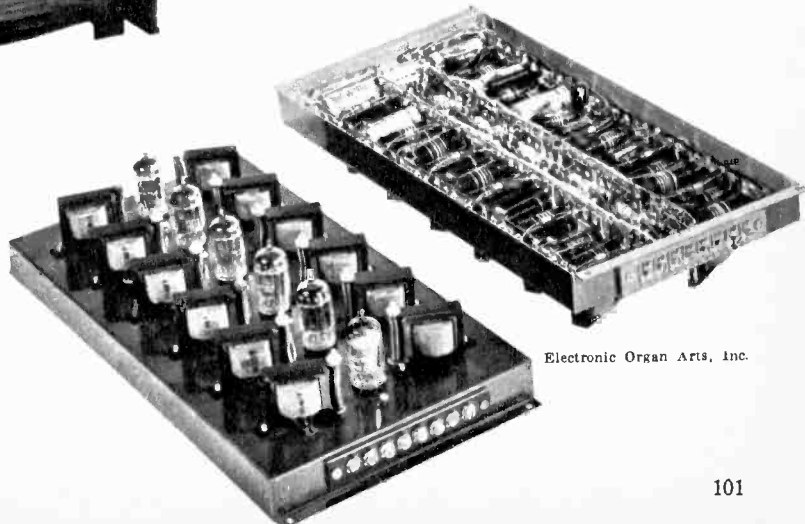

Electronic Organ Arts, Inc.



Orga-sonic by Baldwin has two manuals with a total of 93 keys, including 18 independent stops.



Above is an electric guitar made by the Gibson Co., part of a series of electronic string instruments.

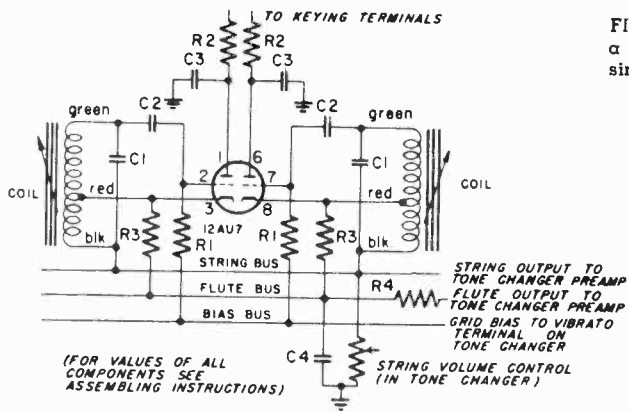

Two-note tone generator schematic is shown above.

FIG. 5. The free-running multivibrator produces a wide range of frequencies in a single circuit, simply by varying the value of one component.

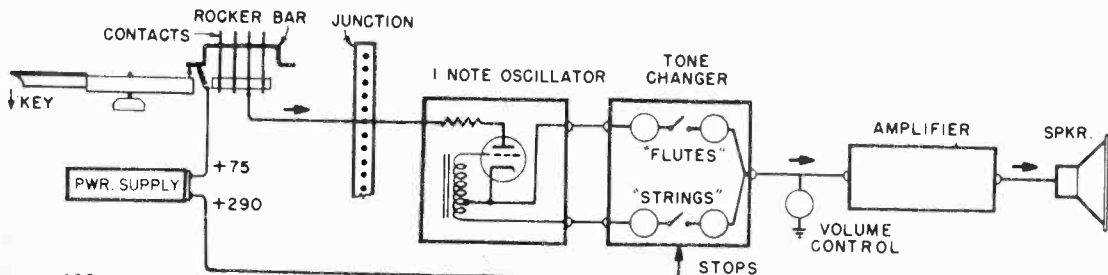
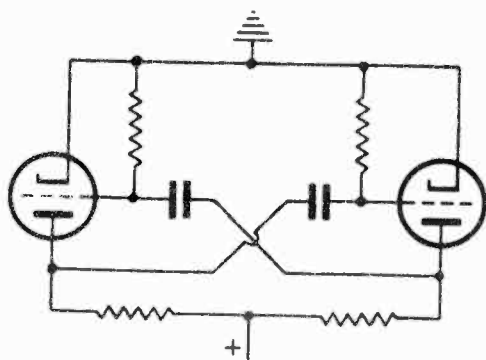

Simplified One-Note Diagram

Electronic Organ Arts, Inc.

monics or multiples of this fundamental. The number and relative loudness of these harmonics determine the difference in tonal characteristics of various instruments. In the case of electronic tone generators which deliver only the fundamental, the harmonics must somehow be added elsewhere. And in those cases where the tone is completely formed, there is no way of changing it. That is, the instrument will have one characteristic sound, and no others.

The tone generators in the Hammond organ are of the pure-tone type, and while this instrument first made its appearance around 1934, its method of tone generation is based on a system discovered in the pre-electronic era of a century before. The principle is illustrated in Fig. 2, where we see that it is not unlike the electromagnetic piano system of Fig. 1(B).

Tone Wheel

Instead of a vibrating string, however, we have a rotating tone wheel with a scalloped edge. As these scallops fly past the tip of a permanent magnet, they cut lines of force in such a way as to produce a nearly sine-wave tone. Since the tone actually has some distortion, filters are fitted to most generators to reduce the unwanted

FIG. 6. A ten-cent neon tube plus a single resistor and capacitor (A) provide excellent sawtooth generator. Waveform and principle at (B).

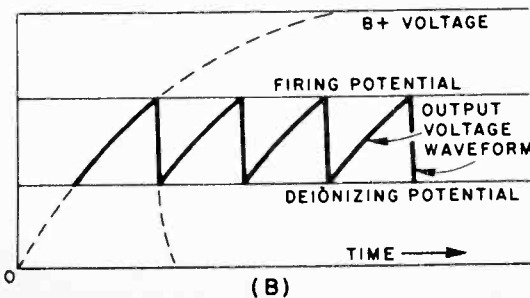
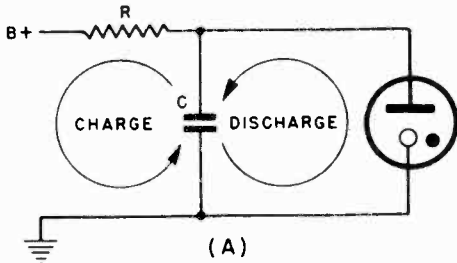

components to negligible value. Ninety-one tone wheels are used in the complete organ to provide a range of seven and a half octaves.

Another electromagnetic tone generator is shown in Fig. 3. This is similar to that in the Hammond, except that the rotating wheels are rather sharply toothed, like gears. This fact, coupled with variations in the shape of the permanent magnet tips, permits the generation of fully shaped tones, like those shown in the drawing.

The principle of the electromagnetic piano pickup of Fig. 1(B) is also applied directly in tone generation. The strings may be plucked or struck, or they may be maintained in a constant state of vibration. These variations in sounding techniques, along with the placement of pickups at a number of positions along the length of the string, will result in tones quite unlike those of the piano.

These same principles apply to the electrostatic vibrating string generator shown in Fig. 1(A). There are other members of the electrostatic tone generator family, and they all have certain advantages common to the group.

When the capacitor is constantly in vibration, for example, the tone can be easily started or stopped simply by keying in or out the polarizing voltage. Furthermore, this switching can be done by means of a filter network which will provide a variety of attacks and stops. Also, by varying the voltage, we have a simple and convenient means of changing the dynamics of the tone.

Among the disadvantages of the electrostatic generator is the fact that the capacitance will always be quite low, and the input resistor R must be quite high. This means that the amplifier input will be high in impedance, and therefore quite susceptible to hum and noise pickup.

One electrostatic tone generator uses rotating capacitors, similar in principle to the variable capacitors used in radio tuners. Only two plates are used, however, one fixed and one rotating at a high rate of speed. One of the plates has a variety of waveforms engraved on its surface to provide a number of tonal colors.

Vibrating reeds may also be used with both electromagnetic and electrostatic pickup systems. In modern organs of this type, the reeds are kept in constant vibration by a low-pressure stream of air, and the depressing of the keys simply connects the electrical pickup to the amplifier. Because the electrostatic reed organ has a

[Continued on page 107]

EXPERIMENT 15

Building a Tuneable Audio Oscillator

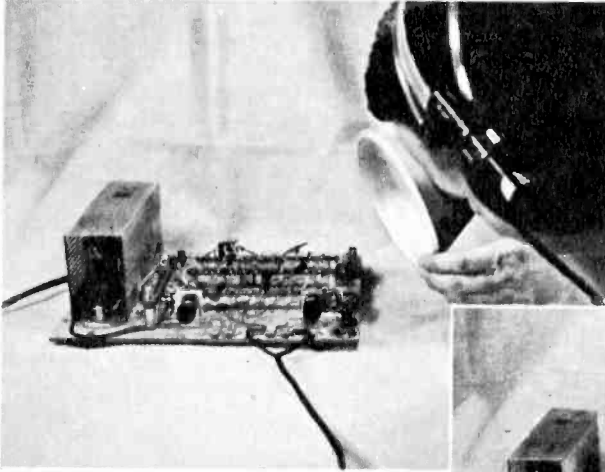

Light is aimed at end of photocell (left) to produce a tone in the middle range. Moving the lamp from this position, in and out, right and left, will vary the pitch from 1 to 5,000 cps, about the top note on the piano.

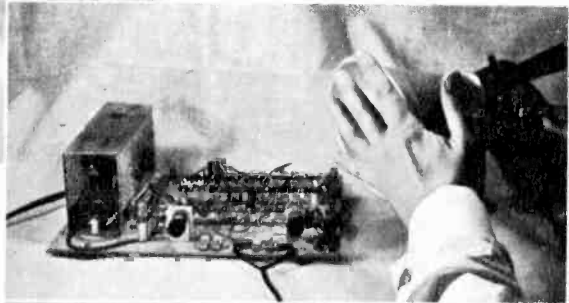

Interesting warble effects are produced by wig-wagging the fingers before the light source, thus rapidly varying the cell illumination and the tone frequency. Try this at several speeds and note differences.

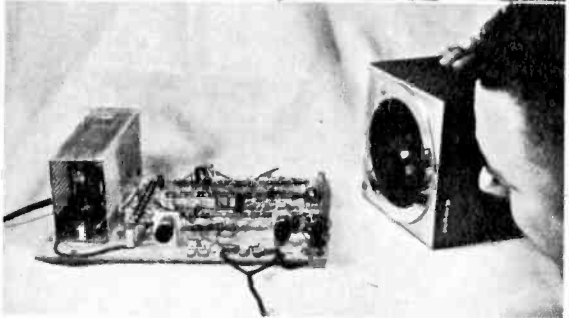

Photocells are not equally sensitive to all colors (frequencies) of visible light. Other effects can be achieved by changing colors of light source. Here the author uses a filtered light which is rich in infrared radiation.

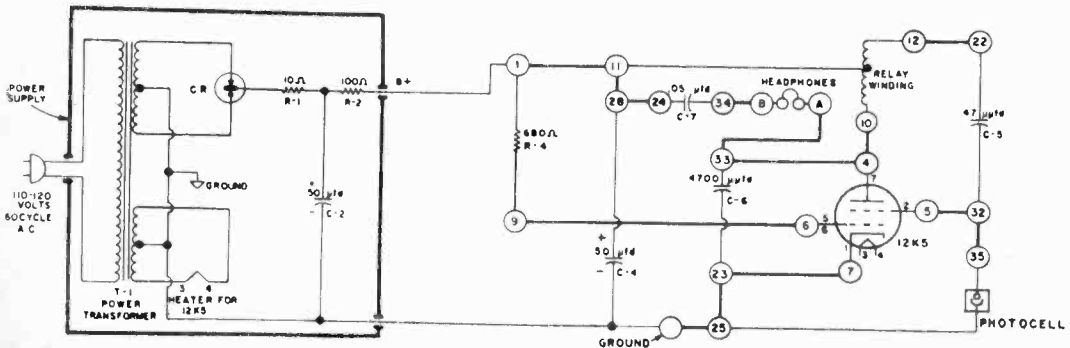

THIS experiment provides an excellent demonstration of the principles of electronic tone generation, and one type of commercial organ actually uses such a system as this. The generator circuit here is of the blocking-oscillator type. The tube generates pulses of plate current which are interrupted by the control grid going so negative periodically as to cut off the plate current. This circuit has been particularly popular for use in synchronizing sections of television sets.

The fundamental principle of the blocking oscillator is the time constant of a combination of resistance and capacitance, as discussed in Experiment No. 12. In this cast the R is the photocell, while the capacitance is C_s. But the resistance of this cell, as explained in Experiment No. 6, varies all the way from 100,000 megohms in darkness to 10,000 ohms in intense light.

Since the resistance is of such a high value, the capacitance is small. With this combination, the tone frequency will vary from 1 to 5,000

cps. The exact frequency will depend upon the resistance of the cell, which in turn depends upon the amount of light striking it.

Commercial forms of such generators use tone wheels, with the desired waveform either etched or printed on some transparent material. A constant light source is then mounted on one side of the wheel, and a photocell on the other. The amount of light striking the cell will therefore vary with the pattern on the wheel. The system is thus similar in principle to optical recording on motion picture film.

You can experiment for various tonal effects with this generator, changing the light intensity in various ways. Try turning the exciter lamp on and off, move it from side to side, closer and further away. Use various colored lamps or filtered lights to demonstrate the color sensitivity of the cell. And notice the interesting effects when you wave your spread fingers in front of the light.

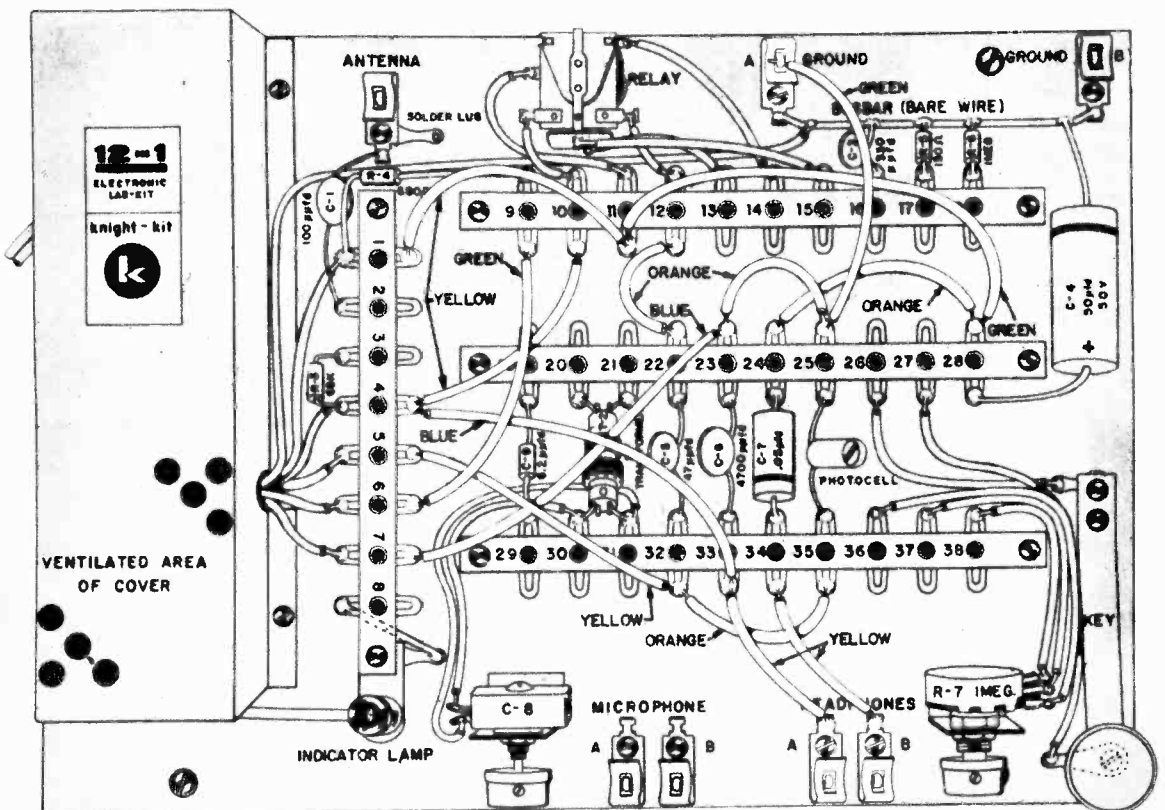

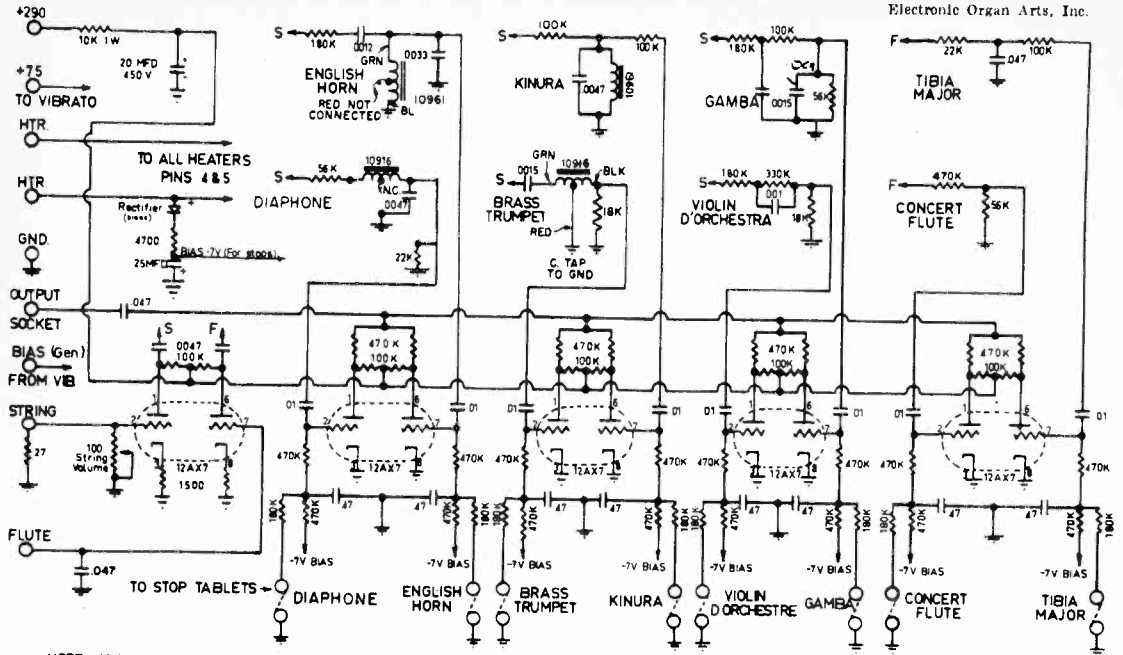

SOLO TONE CHANGER SCHEMATIC

CLASS III SINGLE AMPLIFIER SYSTEM

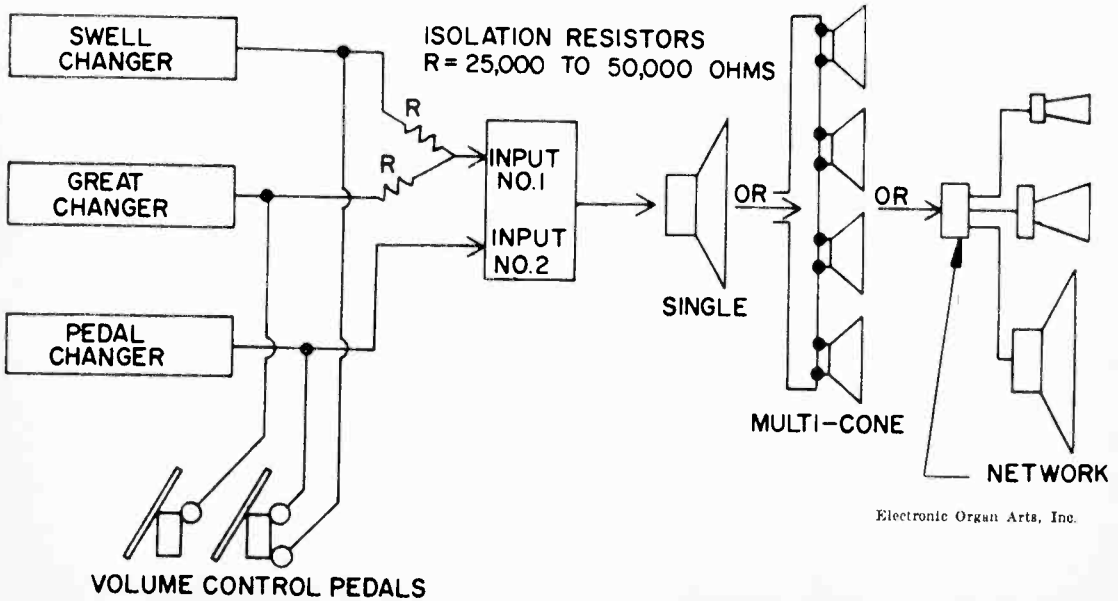

[Continued from page 103]

cleaner waveform than the electromagnetic type, and it is possible to vary the signal strength simply by changing the polarizing voltage, the electrostatic type is the only electric reed organ presently produced commercially.

Tube Generators

By far the commonest type of tone generator today, however, is the vacuum tube oscillator, such as the one you built in Experiment No. 15. This type has the advantages of versatility, small size, low cost, and compactness. Waveforms of almost any desired shape can be produced economically, and the characteristics of the attack, decay, and reverberation time can be adjusted through the use of additional control circuits.

As with the electromechanical types, the purely electronic tone generators can produce either sine-wave tones or fully-formed tones including the harmonics. Of the two, the complex-wave generator is more commonly used, mainly because all harmonics produced within the same circuit *must* be in tune with the fundamental. Even so, the sine-wave type deserves some study.

Conventional oscillator circuits, such as the Hartley and the Colpitts, are essentially sine-wave oscillators, and their principle of operation at audio frequencies is the same as for radio frequencies. In all such oscillators, some part of the output of an amplifying electron tube is fed back into its input to be re-amplified.

The electron tube itself is not an oscillator, however. Oscillations actually take place in a tuned circuit comprising suitable amounts of capacitance and inductance. The tube then in effect acts as an electrical valve, which amplifies and automatically releases to the grid circuit the amount of energy needed to sustain oscillation.

Another sine-wave oscillator, which requires no inductances, is shown in Fig. 4. This type depends for its operation on the charging and discharging of a capacitor in combination with a resistor. The frequency of the tone produced is determined by the *time constant* of the combination. This type circuit is especially useful at the very low frequencies, and thus makes an excellent vibrato generator of 6 to 9 cps. The oscillator of Experiment No. 15 is a resistance-capacitance circuit, with the photocell acting as a variable resistance.

Below is a front view with part designations of the Baldwin Console Model 5 organ

Baldwin Piano Co.

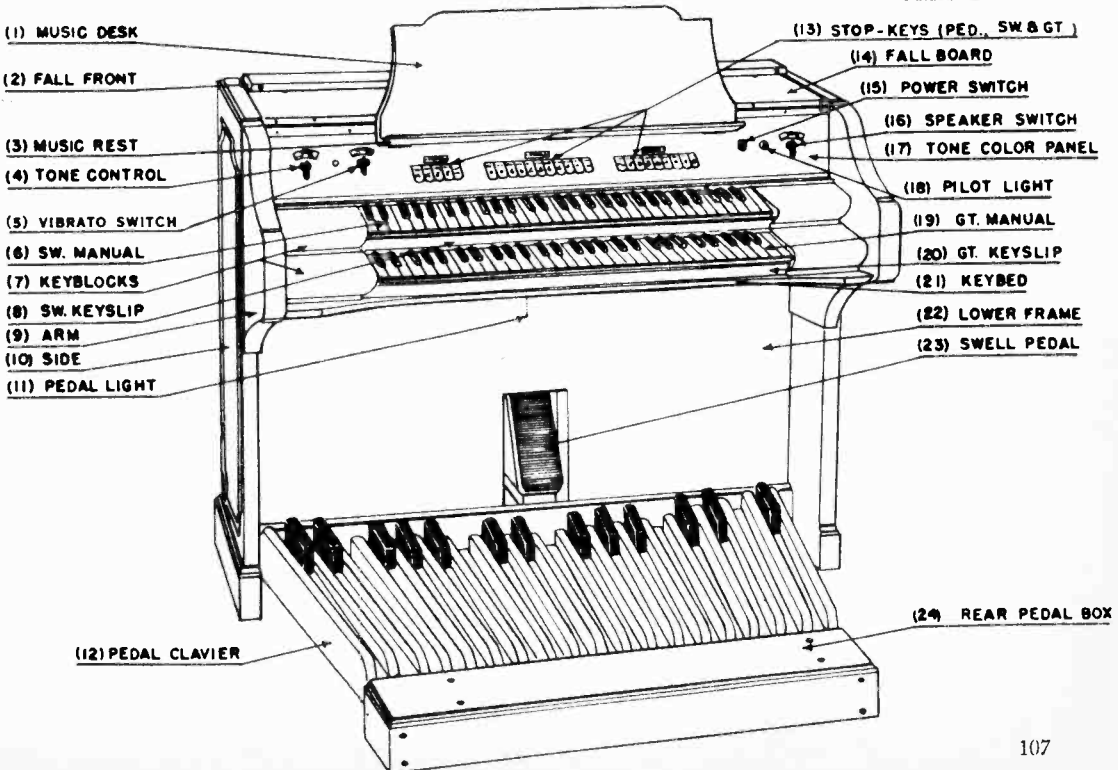

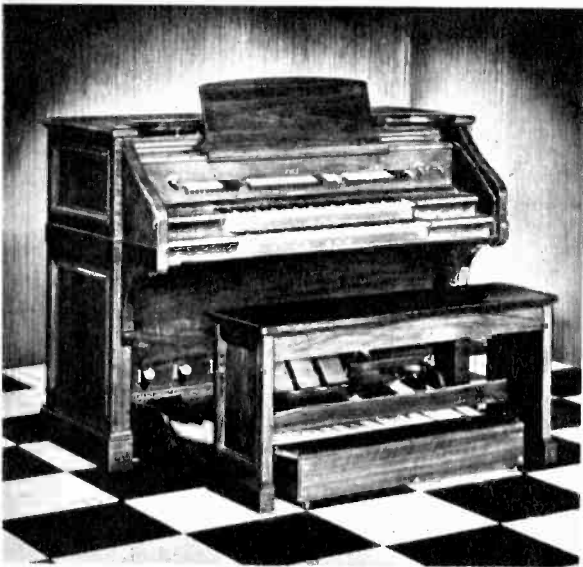

Baldwin Piano Co.

Ten couplers, 32 independent stops, separate tremolos for each manual, are some features of the Model 10A Baldwin. Console weighs 554 lbs.

Complex Waves

Because most of the sounds of conventional instruments can be imitated more readily with waveforms which are essentially saw-toothed or square, rather than sine-waves, these more complex shapes are often generated in commercial instruments. With some fairly simple modifications of conventional sine-wave circuits, these waveforms are readily produced.

Another type of oscillator, which inherently generates square waves is the multivibrator, shown in Fig. 5. Actually, the multivibrator is not an oscillator at all, but rather a form of automatic switch which rapidly moves from one condition to another. It requires two tubes (or both sections of a dual tube) to feed the output of one tube to the input of the other, and vice versa, back and forth by means of a resistance-capacitance coupling network.

The frequency of the multivibrator can be changed quite readily, simply by making either the resistance or capacitance variable. For this reason, it is widely used in inexpensive instruments, which play only one note at a time, and use a single

Frequency range of fundamentals, musical notation and keyboards of the Baldwin organ

Baldwin Piano Co.

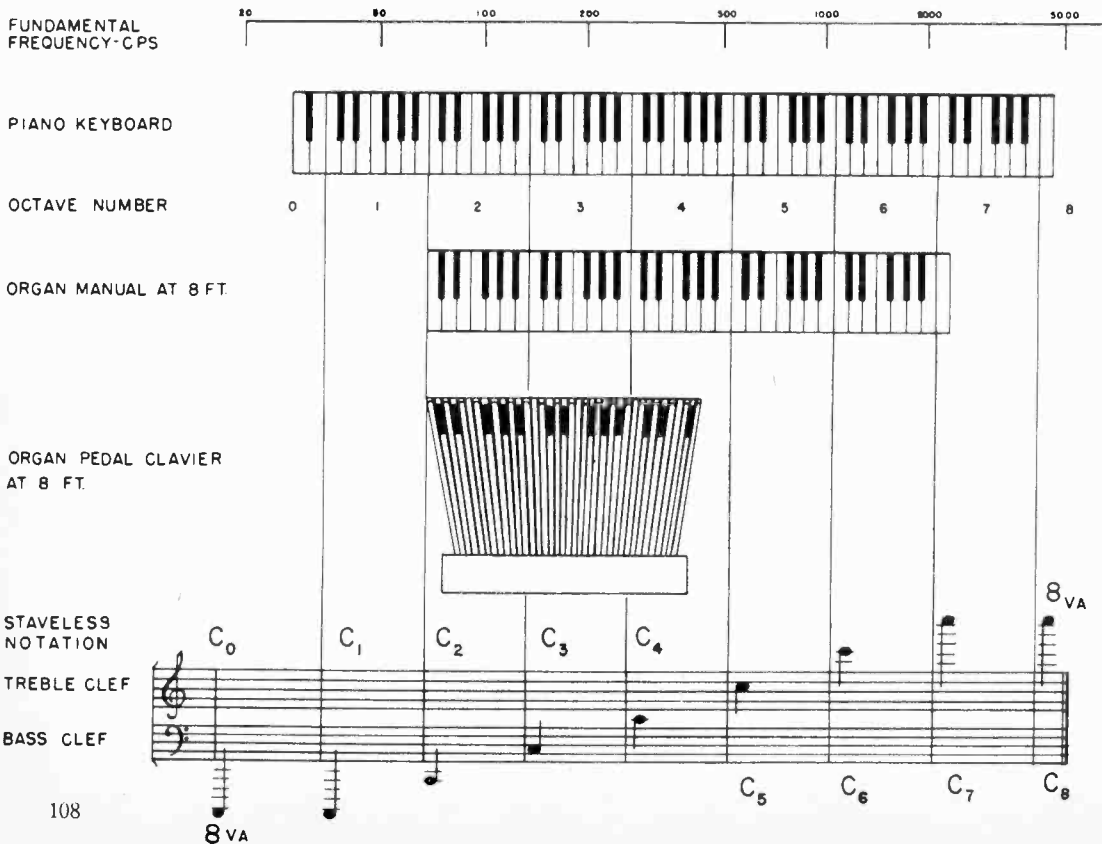

circuit to cover a wide tonal range. All multivibrators generate a waveform in which the fundamental is weak relative to the harmonics. The tone colors will therefore be rather reedy or stringy in character, especially in the lower registers.

A simple saw-tooth oscillator is shown in Fig. 6. This is one of the simplest and most inexpensive means of generating an audio signal. The heart of this little circuit is a neon tube. Unlike the vacuum tube, whose plate current starts from zero and proceeds to a fairly small peak, the gas tube passes no current at all until the voltage across its electrodes reaches the point where the gas ionizes. When this happens, the internal resistance of the tube drops from a quite high value down almost to zero, the tube begins to conduct, and a large plate current flows immediately.

Gas Tube Principles

Referring to Fig. 6 (A), as voltage is applied, the capacitor *C* begins to charge up, with an excess of electrons on its lower plate. This continues until the charge on *C* reaches the ionizing or "firing" potential

of the tube. At this point the tube becomes conductive, and the capacitor tends to discharge through the gas of the tube. When the voltage on the capacitor falls below the ionizing potential of the gas, the tube extinguishes and ceases to conduct, at which point the capacitor begins charging again to begin a new cycle.

As we see in Fig. 6 (B), the output voltage varies between the de-ionizing and firing potentials of the tube. The full supply voltage never appears across *C*, because the firing potential is much less, and the difference appears across *R*. Similarly, *C* never discharges completely, because that action stops when the de-ionizing potential is reached. The saw-tooth character of the wave results from the fact that the charging time is much longer than the discharge time, because the resistance of the charging path is much greater than that of the discharge path. The actual frequency of the signal depends on the supply voltage, and the values of *R* and *C*.

Most electronic organs do not have full sets of tone generators, one for every tone in the range of the instrument. Instead they often use frequency *dividers*. Electronics men are well acquainted with methods of increasing the basic output frequency of an oscillator by multiplication, and of decreasing it by division. The latter method is used exclusively in organs, because of the low cost and frequency stability of high-frequency oscillators whose signals are divided down. To build low-frequency generators and multiply up would not be nearly so economical in space, weight or cost.

Tone Forming

The desired tone colors in electronic music are achieved by the process of *additive synthesis* or *subtractive synthesis*. In the former system, the outputs of several sine-wave oscillators are combined in the desired ratio of fundamental and harmonics. In the subtractive system, we begin with a generated tone which is very rich in harmonics, and then delete or subtract some of them as desired. Both of these methods are used frequently in modern electronic organ practice.

Still other electronic means are used in tone formation to control the rate of attack and decay, as well as other characteristics such as vibrato, reverberation and change of expression. Electronic music has now reached the stage in its development where it can imitate the sound of any existing instrument with a high degree of accuracy, not to mention the sounds it can produce that have never been heard before. •

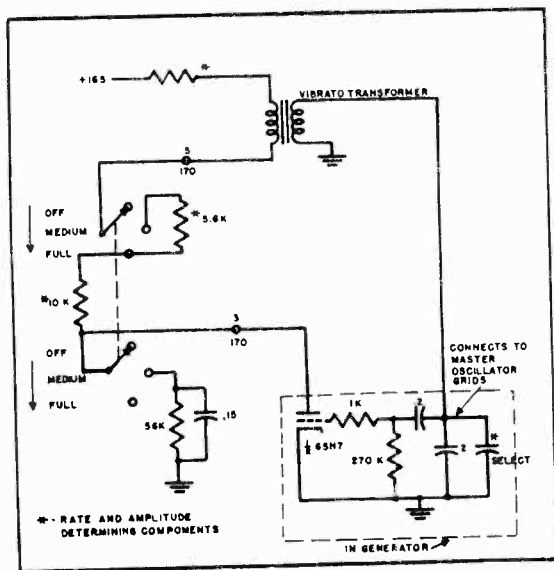

Baldwin Piano Co.

Schematic of electronic organ vibrato circuit

Chapter 10

MEDICAL ELECTRONICS

New weapons in the war on disease

SOME of the most dramatic applications of electronics have been in the field of medicine, where the ultimate objective is the saving of human lives. The science of medical electronics is a relatively new one, and there have been times when there was every indication that it would die aborning. Even now, the wedding of electronics to medicine sometimes takes on the complexion of a shotgun affair.

Electro-Medical Quackery

Medical men can hardly be blamed for a certain wariness toward electronics as a useful tool, when one considers the bizarre history of some early collaborations between physicists and physicians. In the sixteenth century, a self-styled German doctor who liked to be called Paracelsus was advocating the use of powdered lodestone, a magnetic material, in the treatment of stab wounds. In the eighteenth century, electric shock from the then new friction machines was popular for the treatment of paralysis. At the turn of the nineteenth century the "tractor" became a widespread cure-all. This was simply a pair of dissimilar metals, in effect a primitive battery, which when drawn over the skin of a patient was supposed to have miraculous curative powers.

Yet despite this sorry history of shameless quackery, medical science was the first to embrace, and to benefit from, the true art of electronics when it first appeared on the scene. The era of medical electronics really dates from the discovery of X rays by Wilhelm von Roentgen in 1895. So great was the importance of this discovery, and so readily was it recognized, that within but a few weeks of Roentgen's announcement, X rays were being used as an aid to surgical operations in Vienna.

Although Roentgen used the term X ray, with X standing for the mysterious unknown, we now are acquainted with the true nature of these rays. They actually are invisible light rays, having a very short wavelength and lying directly above the ultraviolet region. But X rays have some very important properties which are not exhibited by ordinary visible light. First are the well-known abilities of X rays to penetrate solid matter and to affect a photographic plate. Less well known is the fact that when X rays pass through matter, not only solid matter, but liquid and gaseous states as well, they produce both positively and negatively charged ions.

The X-ray Tube

The producer of these rays is the X-ray

Brookhaven National Laboratory



Workers insert a 500-pound outer half "turn" of the cosmotron coil during construction of the giant particle accelerator at the nuclear research center, Upton, N. Y. The hollow copper coil magnetizes the steel of the cosmotron and keeps particles in the chamber. The coil consists of 384 turns, making up the 70-foot diameter cosmotron. Weight of magnet alone is 2,000 tons.

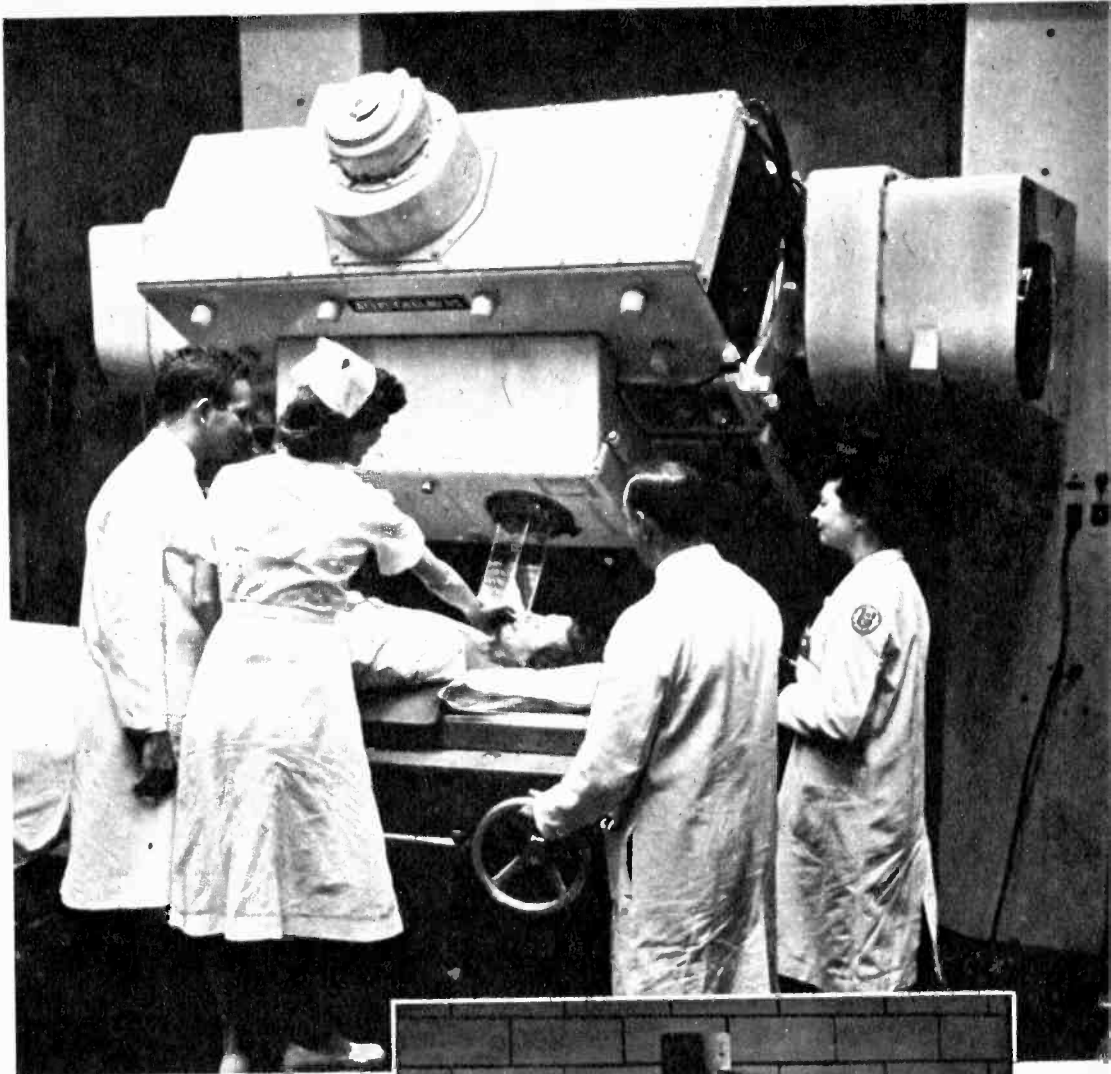

Columbia-Presbyterian Medical Center

The massive 10-ton betatron is the latest weapon in the attack on cancer. The plastic cone is positioned, above, from which the 24-million volt X rays will emerge in a highly penetrating beam to the spot to be treated.

At right is the betatron's operator who sits behind a 3½-foot concrete wall while the patient is under treatment. Operation of the betatron is viewed through a water-filled porthole which will absorb any harmful radiation.



Columbia-Presbyterian Medical Center

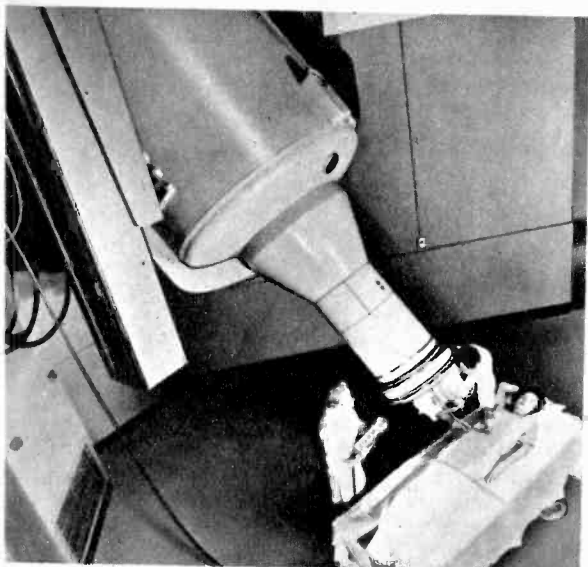

Electronics Illustrated

Another version of electronic cancer fighting is this 2-million-volt X-ray unit which is designed to treat cancer cells at pin-pointed site within body.

tube, which is basically nothing more than a high-voltage diode rectifier in which the electron stream from the cathode strikes the anode with such force that it produces X rays by bombardment. When an X-ray photograph is taken, some of the rays are absorbed by the subject. Thus the picture is really nothing more than the shadow cast by the object being photographed. Since the relative absorption and penetration of the rays varies with the various materials in the subject under study, the X-ray camera can in effect "see" beneath the surface, as in the case of a broken bone.

X rays are also widely used in the diagnosis of many diseases and anomalies such as tuberculosis, silicosis, arthritis, and various types of stones, ulcers and cancers. But its usefulness is not confined to diagnosis alone. In the year following Roentgen's discovery, a Chicago doctor used X rays to treat a tumor. Since then X rays have been used for the relief or cure of ulcers, sinusitis, bursitis, arthritis, and dozens of different skin infections.

A disadvantage of ordinary X-ray equipment for treatment is that its rays concentrate their effect on the surface of the patient's body. But for cancers within the body, for example, it is desirable that the rays penetrate more deeply, and that they be sharply controllable so that a tumor might be destroyed with minimum

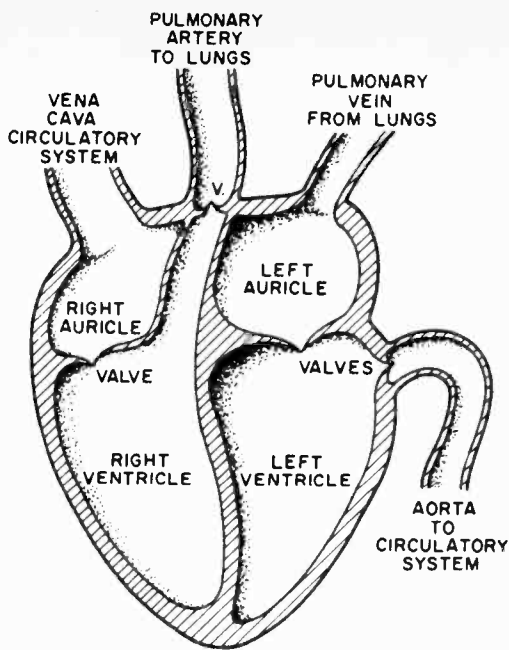

Electronics Illustrated

The diagram above indicates pictorially the main elements of the human heart. Heart disease is number one killer in U. S. (See text for details.)

injury to adjacent healthy tissues and vital organs. The solution to this problem has come out of atomic research.

Particle Accelerators

In X-ray tubes the basic process is the acceleration of electrons, and they may thus be regarded as the direct antecedents of the family of devices known as *particle accelerators*. These devices, which were originally developed by atomic physicists to produce nuclear transformations, include such well-known names as the cyclotron, cosmotron, betatron, synchrotron and bevatron.

Particle accelerators are used to speed up either electrons or positive ions to tremendous velocities, to just barely under the speed of light. At this point they either strike a suitable target and thus produce very penetrating X rays, or the electrons themselves leave the system through a window. (Also see illustrations in Chapter 2.)

There are two main types of particle accelerators. In one type the particles move along a straight path, through devices which in successive steps supply more and more energy to boost the particle velocity. This type is called a linear accelerator. In another type the particles are whirled around in a circular orbit.

The betatron is an example of the latter

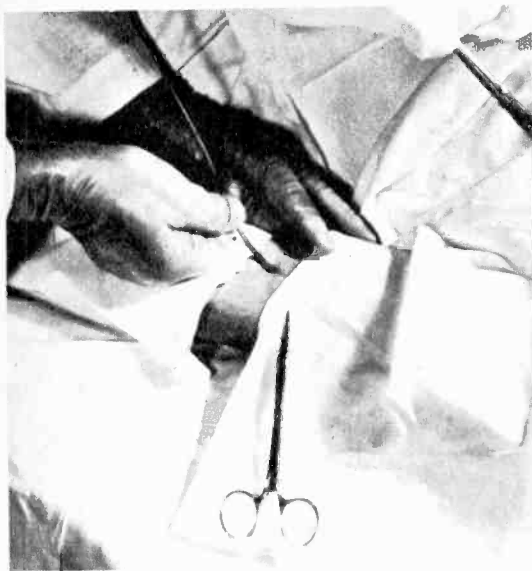

Electronics Illustrated

Sensitive Gulton microphone at end of heart catheter is so tiny it does no damage passing through arm vein and chest into patient's heart.

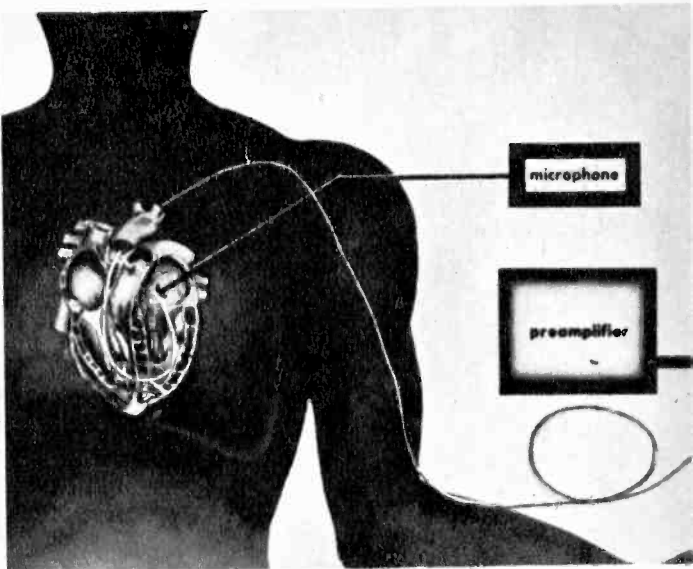

Electronics Illustrated

Drawing shows how microphone and cable, connected to preamp, is placed in heart by inserting through vein, over shoulder, into auricle.

type. The first of these was built in the United States in 1940, and in addition to their usefulness for nuclear experimentation, they also have been employed in industry, their high-energy X rays proving very effective in detecting flaws in metal castings and forgings. More recently, they have been adopted for medical use, there now being a 22-million-volt model in the Chicago Medical Center of the University of Illinois, and a 24-million-volt version at the Columbia-Presbyterian Medical Center in New York City.

The betatron works on the principle of electromagnetic induction, and might be thought of as similar to a giant transformer. In place of the secondary wiring used in a transformer, however, the betatron has a circular vacuum tube (generally known as a doughnut) placed in the magnetic field of the transformer core. Thus the electrons in the secondary circuit, instead of flowing through turns of wire, spin around inside the doughnut in response to the force exerted by the induction field from the primary.

Particle Deflection

The particles don't simply make one trip around the doughnut in traveling from cathode to target, however. Instead there are electromagnetic deflection circuits which prevent the particles from striking

the target or escaping, as they continue to pick up speed in making hundreds of thousand loops around the doughnut. When the proper velocity is reached, only then are the particles permitted to strike the target and form X rays, or to escape directly through a window.

But although it takes some time to tell it, all of this can actually happen within $1/720$ th of a second!

In the betatron at The Presbyterian Hospital, the beam is not continuous, but is made up of a series of short bursts, each lasting only about a microsecond, with a pulse repetition frequency of 180 cps. This frequency produces such a pronounced hum that special acoustical lining is needed on the inner walls of the unit to keep the noise down to a tolerable minimum.

The beam is so powerful that a 7-foot thick concrete wall is used directly in front of the machine to reduce its effects to a harmless level. The walls of the treatment room are $3\frac{1}{2}$ feet thick, to absorb any stray radiation. The operator observes the treatment of the patient from outside this wall, through a water-filled porthole. Although super-high-voltage particle accelerators such as this one have not been in any way a cure-all for cancer, they are expected to prove an important therapeutic and research tool in the fight against this dread disease.

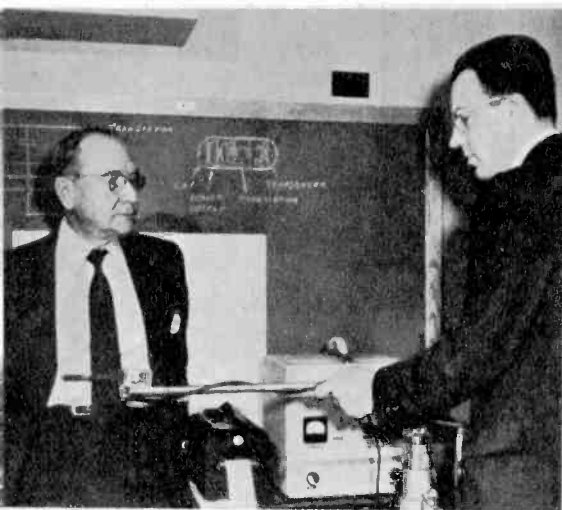

Radio Corp. of America

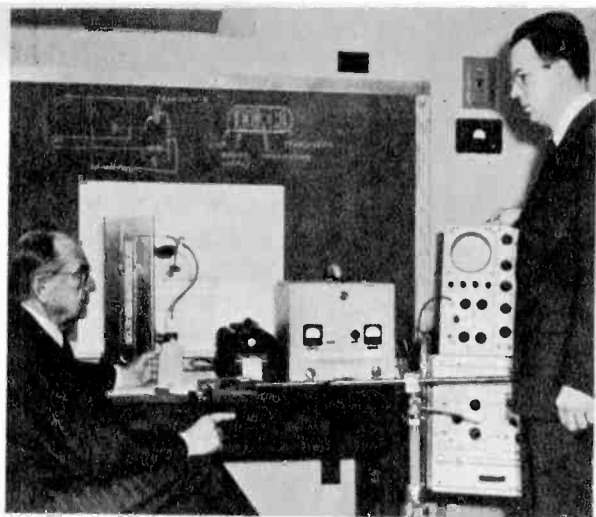

Radio Corp. of America

"Radio Pill" is demonstrated by two scientists. FM radio antenna at the end of metal rod is held against body, picks up radio waves sent out by pill. The FM waves pass through the body. At right is the oscillograph which registers changes in pressure. Bottle on the table contains the tiny radio transmitter.



Columbia-Presbyterian Medical Center

Great aid in the fight on disease is the electron microscope, which is shown above being focused.

Radio Corp. of America

HOW ELECTRONS ARE FOCUSED IN THE RCA ELECTRON MICROSCOPE

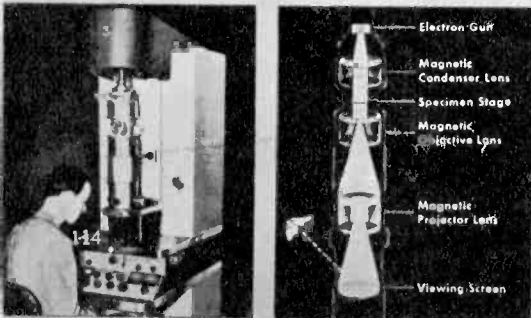

Body Signals

The signal tracer you build in Experiment No. 16 will help to diagnose troubles in electronic apparatus. Similarly, the live human body is in reality a dynamic system which generates a variety of electrical voltages, signals which provide an excellent clue to the body's own state of health. In this diagnostic branch of medical electronics, instrumentation is the major tool. This group of instruments comprises the electrocardiograph, electroencephalograph, electrogastrograph, and electromyograph. These instruments are designed for use with the heart, brain, stomach, and nerves and muscles, respectively.

All of them make use of voltages generated within the body itself, and known as bioelectric potentials. Since the body itself is conductive, the electrodes which pick up these voltages may generally be applied externally. In the case of the electrogastrograph, however, one set of electrodes is strapped to the patient's forearm, but six others are affixed to a small balloon which is swallowed, so that they may come into direct contact with the stomach lining.

In any case, the voltages, which are on the order of millivolts, or even microvolts, are amplified by conventional electronic means, and then fed to a suitable recording medium, or monitored by headphones or speaker, or displayed on some instrument such as a cathode ray oscillograph. These bioelectric potentials are invariably highly complex, and the instrumentation will often include some form of harmonic analyzer, which will separate out the various signal components. The objective here is the correlation of these various factors

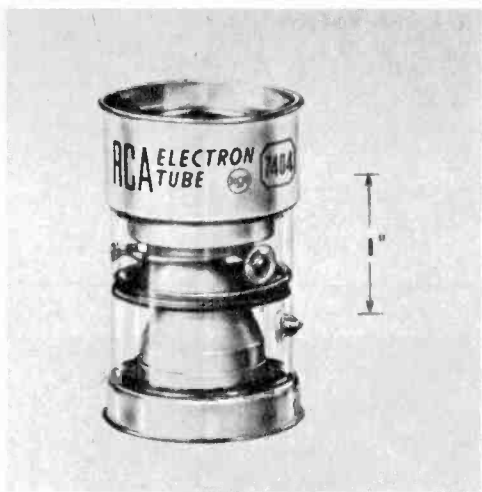

Radio Corp. of America

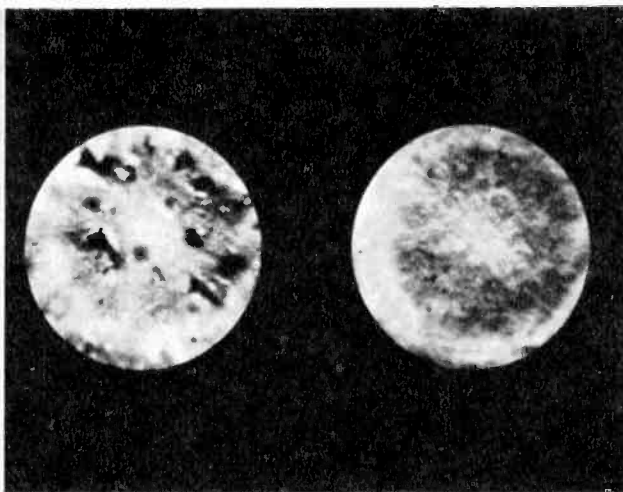

Radio Corp. of America

New electron tube is the "eye" of a microscope attachment for use in medical research. Called the "ultrascope," it converts invisible ultraviolet images of human tissue into visible pictures. At right is photomicrograph of unstained brain section, with almost no cell structure visible. To its left is same specimen viewed with the aid of the "ultrascope" tube. The irregular black spots are nerve cells.

with the action of the various parts of the body with which they are concerned.

The significance of the voltages is determined by means of standards of comparison. After much experience in the use of these instruments on healthy people, it has been learned just what form the signals should normally have. An abnormal pattern would indicate a condition of illness of some sort, which likewise may be diagnosed in the light of experience gained from previous cases.

Electronic science has also contributed much to the branch of diagnosis known as *auscultation*. This has to do with listening to sounds within the body. The practice began when doctors started placing their ears directly against the body of the patient, a procedure which for some years had about as much sanction as witchdoctoring. Auscultation in the modern sense dates from 1819, with the invention of the stethoscope, the rubber-tubed instrument so familiar to all.

Well over a century passed before we had the first electrostethoscope, an electronic instrument in which the sound is picked up and converted to electricity by a transducer, and then reconverted to sound by means of headphones. But any stethoscope has one major disadvantage. Amplified or not, it still hears the heart from outside, after the sounds have traveled through the heart walls, through the chest, between or through the ribs, and finally through the skin. In getting through these acoustic barriers, the sounds are weakened about 80 decibels. Furthermore, all the various heart sounds merge together, regardless of where they originate.

The result is something like listening to a dance band two doors down the hall, while each musician is playing a different arrangement of the same tune.

The Radio Pill

The same general condition holds true for the other internal organs. In the case of the stomach and digestive system, the problem has been solved by the *radio pill*. The patient actually swallows a miniature FM radio broadcasting station, complete with transmitter and power supply. The entire system fits into a plastic capsule $1\frac{1}{8}$ inches long and less than a half-inch in diameter, and relays information to the outside by radio, as it journeys through the gastro-intestinal tract of the patient.

For probing the sounds of the heart, the problem isn't so simple. The only way we can really tell what the heart is doing is by listening to it from the inside of each of its four chambers. This is actually done, using a sensitive microphone smaller than a grain of rice. It is enclosed with a pair of wires in a plastic tube hardly thicker than a piece of string.

There are two methods of getting the tiny mike into all of the four heart chambers shown in Fig. 1. For the right side, the plastic tube is introduced into the vein of the arm, the same one used for blood donation. The process is practically painless, and no general anesthesia is needed. As shown in Fig. 2, the cable enters from the top (*vena cava*), and can get into both right chambers, through their valves, and even into the pulmonary artery which carries blood to the lungs.

[Continued on page 119]

EXPERIMENT 16

Building a Signal Tracer

Underside of Edu-Kit signal tracer shows wiring simplicity. Coil in center used for other experiments.

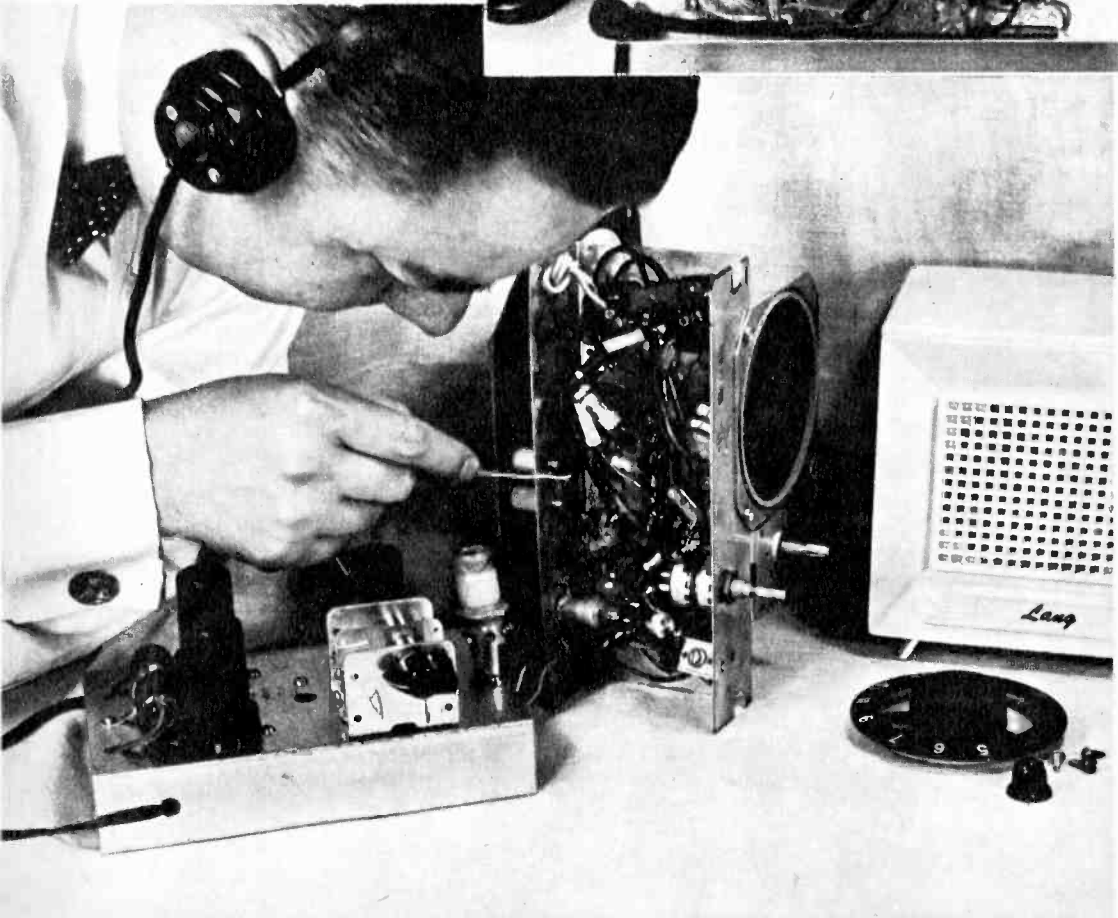
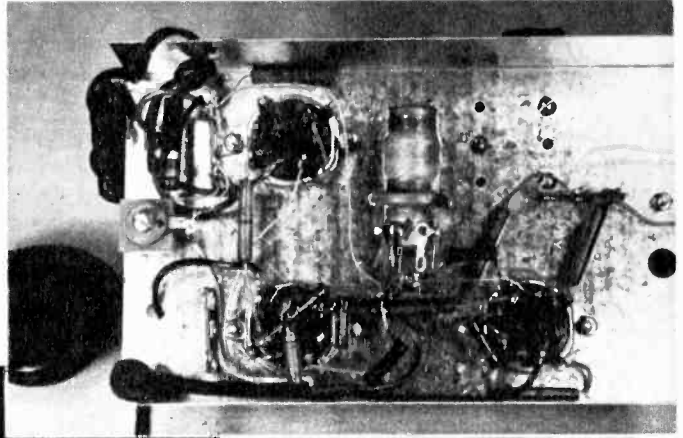

Test probe is made of foot-long piece of wire, with end skinned bare. Check grid and plate of each stage.

EXPERIMENTS in electronics involving the human body are not for non-medical laymen, but the idea of auscultation and the check of bio-electric potentials is directly analogous to the signal tracing and voltage testing apparatus you build in this experiment.

The signal tracer is just one of many devices which may be made from a Progressive Edu-Kit. And just as the doctor can localize the malfunctioning of certain parts of the body by listening to its sounds, so you can find trouble in radios and other electronic gear by using this instrument and your own ears.

The chassis of the equipment under test is connected to the signal tracer chassis through C₁, as shown in the schematic. It is important that the two chassis do not touch each other directly. The probe is simply a wire about 12 inches in length, with about a half-inch of insulation cut off the end.

Until you get to know the pin connections of the commonly used tubes, you will have to con-

sult a tube manual to determine which are the plate and grid terminals. With the radio turned on, touch the probe to the grid of the first tube. You should hear a station. When you touch the plate of the same tube, the sound should be louder. Continue on through each succeeding stage in this fashion, until the signal disappears, becomes noisy or is distorted. You have now isolated your trouble to a specific area, and all that remains is to find which component is at fault. And nine times out of ten, a visual inspection, or poking around for loose leads, or broken or intermittent connections will give you your answer.

For checking supply voltages, and for locating opens and shorts, you can use a neon probe. A commercial model is shown in the picture, but you can easily build your own, using an NE-2 or NE-51 mounted in a length of plastic tubing. When voltage is applied, both electrodes glow with 90 or more volts AC, while only one glows on DC.

IDENTIFICATION CODE	
TUBES	LINE CORD
TUBE 1: 6P5, 6J5 OR 6C5 INTERCHANGEABLE	WIRE 1: BLACK
TUBE 2: 6SD7, 6SJ7 OR 6SK7 INTERCHANGEABLE	WIRE 2: GRAY
	WIRE 3: RED
CONDENSERS	RESISTORS
C1: .01 MFD.	R1: ANY VALUE BETWEEN 1500 OHMS & 5000 OHMS (1.5K - 5K)
C2: .001 MFD.	R2: ANY VALUE BETWEEN — 1 MEGOHM & 3.3 MEGOHMS (1M - 3.3M)
ELECTROLYTIC CONDENSER	R3: ANY VALUE BETWEEN — 25,000 OHMS & 50,000 OHMS (25K - 50K)
LEAD 1: RED	R4: ANY VALUE BETWEEN — 100,000 OHMS & 200,000 OHMS (100K - 200K)
LEAD 2: RED	
LEAD 3: BLACK	

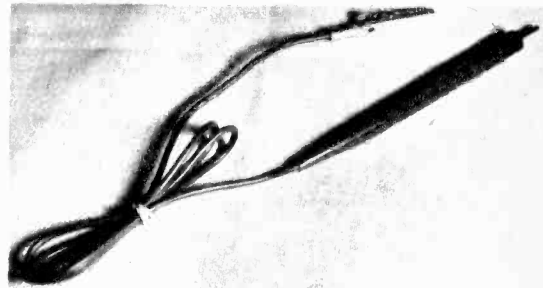

Neon tube probe checks supply voltages of 90 volts or over, also opens and shorts.

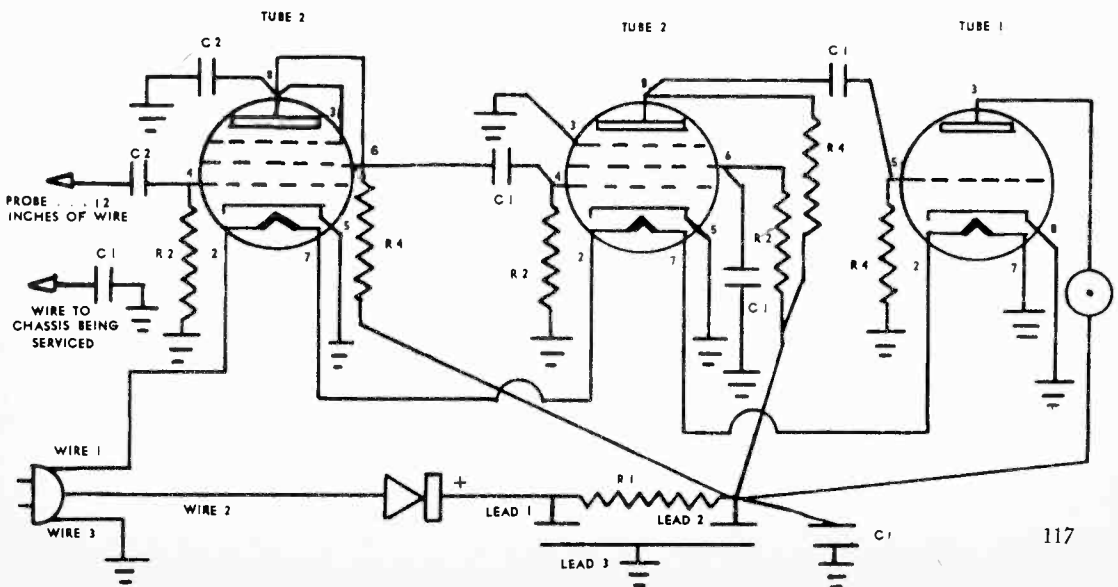



Columbia-Presbyterian Medical Center

Electrogastragraph, for stomach cancer diagnosis. Patient swallows small balloon containing six electrodes; another electrode is strapped to arm. Electrical difference in potential is then measured.



National Institutes of Health

Studies of fats in blood are aided by precise analysis possible with mass spectrometer, which sorts out the electrified particles and identifies any foreign elements in patient's blood sample.



Columbia-Presbyterian Medical Center

Electronic stethoscope, whose amplifiers pick up a newborn baby's faint heartbeats, are great help in this field. Other aids are incubators with infrared radiant heat where the infant wears temperature-sensing elements attached to sections of his body.

Experiments to find cures for cancer are conducted with the help of radioactive carbon. Below, a Geiger counter measures one sample's radioactivity.

American Cancer Society



Special electronic equipment in an open-heart surgery recovery room includes fog tent, monitoring oscilloscope, recording machine and pacemaker.

Columbia-Presbyterian Medical Center

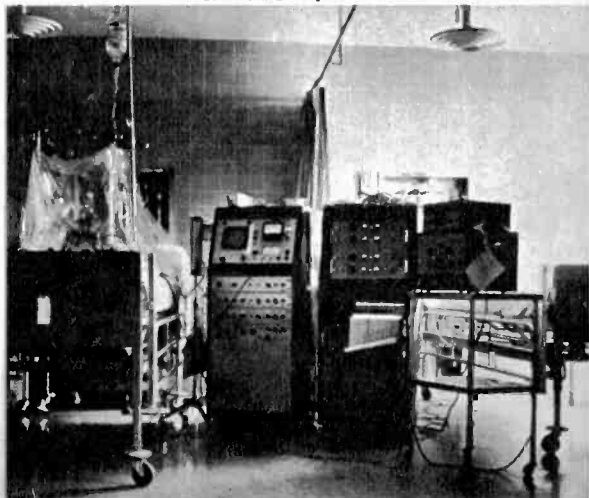



Radio Corp. of America

A medical color television camera is shown above undergoing operational tests. This color TV camera system is designed specifically for medical use, can be used closed-circuit or on-the-air.

[Continued from page 115]

To get to the left side of the heart by this method, however, would require going into the arteries, against the blood flow and against the valve action. So the method actually used is somewhat different. A long hollow needle is inserted between the ribs in the back, directly into the left auricle. The mike and cable pass inside the needle, and from there can drop down to the left ventricle and even into the aorta. Although it is only a couple of years old, this hi-fi heart checker has been directly responsible for saving literally hundreds of lives.

The Electron Microscope

Another important contributor to medical research is the electron microscope, which permits examination of viruses and minute bacterial structures which are far too small to be seen with even the most powerful optical microscopes. As shown on page 114, the electron microscope uses a beam-forming system similar to that of the television tube. The lenses of the electron microscope are the powerful magnetic fields of four coils. Whereas in the optical microscope the image is focused by changing the lens spacing, in the electron microscope this is done by varying the focal

lengths of the lenses, which remain stationary. Focal length is changed by varying the currents in the coils, thereby changing the strength of the magnetic fields.

The electrons comprising the beam are concentrated on the specimen, which absorbs some of them and scatters others. Thus the distribution of the remaining electrons in the beam is determined by the details of the specimen. After the beam passes through the specimen, it is further focused and enlarged by the objective and projector lenses.

The image is not directly observed as in an optical microscope, but is seen as a pattern produced on a fluorescent screen, similar to that used in television receivers. The beam may also be focused on a photographic plate since electrons will affect a photographic emulsion in the same way as will visible light. Thus it is possible with the electron microscope to get a direct, permanent record of the image.

There are many more examples of cooperative efforts between electronics and medicine, but it is clear from what we have seen here that the forward march of medical science has been advanced immeasurably by the contributions of electronics. •

Chapter 11

SEEING EYES

Electronic navigation



Federal Aviation Agency

Typical Instrument Flight Room at a large terminal airport. Radar sets shown are short range.

ASDE radarscope presents air traffic controller with picture of all ground traffic at Idlewild Airport. Note clear definition of the runways.

Airborne Instruments Laboratory

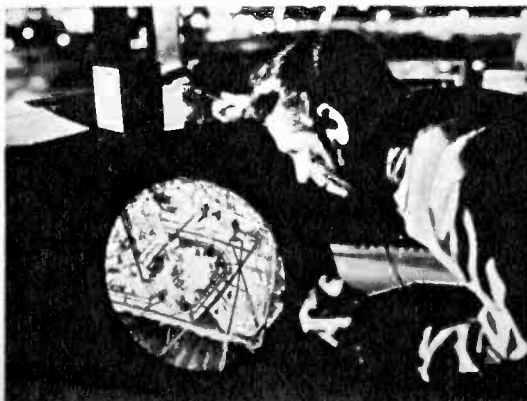

ONE of the more dramatic applications of modern electronics is in the many systems developed for the navigational guidance of surface vessels and aircraft. So many contributions have been made to the art, in fact, that we can cover only briefly a few of the more important ones in this chapter.

The age of electronic navigation began in 1912 when the old *Mauretania* was fitted with radio direction finding equipment. This equipment comprises a sensitive radio receiver, along with a highly directional antenna system. With this combination, the operator can tell the direction from which a radio signal arrives. And from this he can tell the direction in which his vessel should head to arrive at the source of the transmissions.

The drawback here is that a single signal can give the operator no more than a *bearing*. If the captain uses this information to set his course, he is not taking into effect the *drift* he will encounter because of wind and current. He may therefore take a rather roundabout way in arriving at his destination, although arrive at it he surely will.

A much better application of radio direction finding involves the use of two or more bearings on separated stations. When these several bearings are plotted on a map, they will cross, and the intersection will pinpoint the ship's position.

Radio direction finding has a number of disadvantages, however, perhaps the most important of which is the requirement of a skilled operator. The shortage of such skills, plus the desirability that the commander of the vessel have accurate navigational information at his fingertips at a moment's notice, has led to the development of many semiautomatic electronic navigational aids.

Radar

Among these is the well-known radar, which came into its own during World War II. The important fact of nature, without which radar would be impossible, is the exactness of the velocity of movement of radio waves, very nearly 186,282 miles per second.

Radar works on the principle of echoes. When you shout across a canyon or ravine and hear the sound of your own voice bouncing back at you, your mouth is acting as the transmitter, and your ears as the receiver. If you measure the time it takes for the sound to travel to the cliff or mountain side and bounce back again, then knowing that the velocity of sound is around 1,120 feet per second, you can easily figure the distance between you and the opposite wall.

Similarly, the radar set transmits a short pulse, receives its echoes, then transmits another short pulse and receives its echoes. When the waves strike an object, such as an airplane, ship, building or mountain, they will bounce back to the radar source.

While radar of this type was originally used for the location of enemy aircraft, it is now used as a navigational aid for friendly craft in the system known as Ground Controlled Approach (GCA). When a pilot must make a blind landing in bad weather, but lacks the airborne equipment to enable him to do it unaided, a skilled crew of GCA operators on the ground can "talk him down" by giving him a running commentary on the quality of his approach.

The airport equipment usually comprises two radar sets, one known as the *search* system, and the other called the *precision* unit. The search unit monitors all aircraft within about 30 miles of the airport, while the precision set gives continu-



Washington National Airport control tower is typical of similar centers found throughout United States.

Federal Aviation Agency

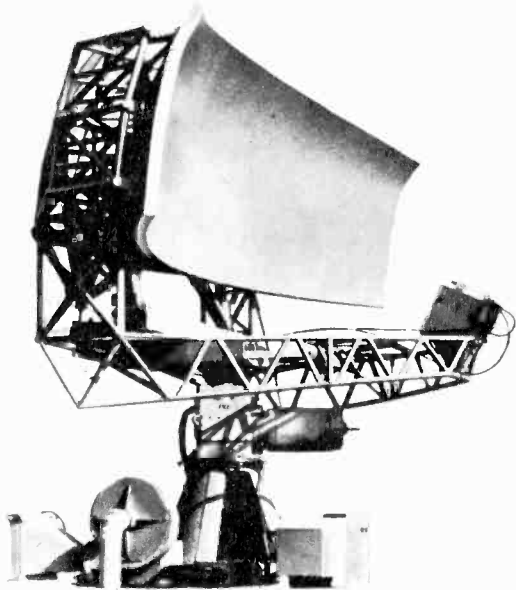

Airborne Instruments Laboratory

Automatic radar performance monitor attached to radar screen enables the operator to check on and measure accuracy and operation of the set.



Raytheon Co.

Designed for large ocean going vessels, this radar screen, shown here with viewing hood, gives operator continuous warning of any hazards.

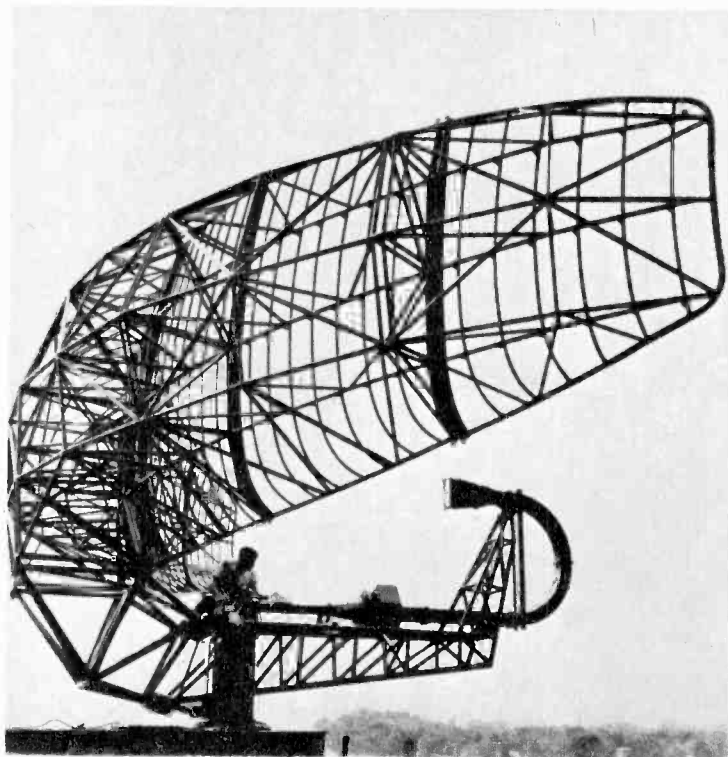

Long-range radar uses 40-foot antenna, covers more than 125,000 square miles of area. A single set is able to feed 15 monitors simultaneously, allows tracking even in bad weather or rain. A new provision allows set to pick out only moving objects.

Raytheon Co.

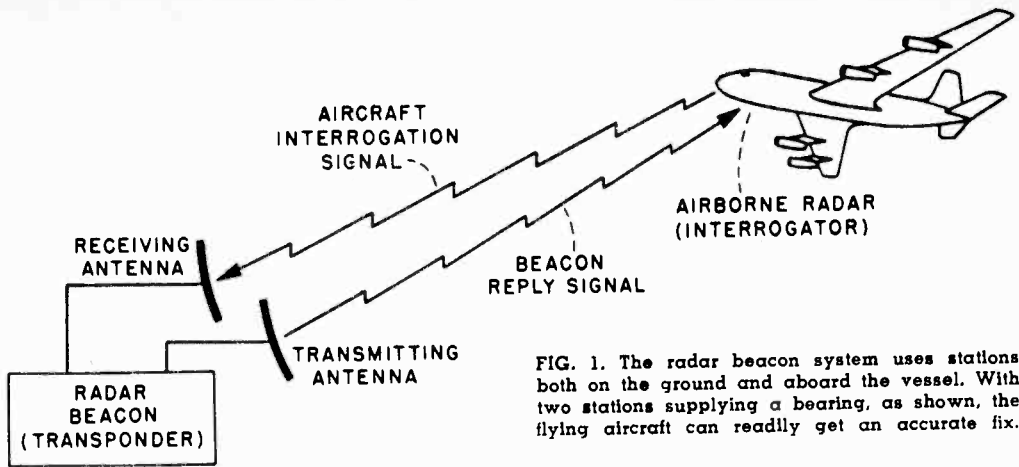

FIG. 1. The radar beacon system uses stations both on the ground and aboard the vessel. With two stations supplying a bearing, as shown, the flying aircraft can readily get an accurate fix.

ous information on the specific approaching aircraft with respect to the runway.

Radar Beacons

While radar was first used to locate an unknown target from a fixed point, it can also work in reverse. That is, it can determine the unknown location of an airborne radar station relative to a known ground position. In the radar beacon system, in fact, there are radar transmitters and receivers both aboard the aircraft and on the ground, as shown in Fig. 1.

The fixed radar station, known as a *transponder*, sends out a signal only upon *interrogation* from the mobile station. The reply will indicate both the distance and bearing of the mobile station from the radar beacon. With two or more such range readings, the captain or navigator can determine his position on a map simply with the use of a pair of compasses. He merely describes circles around the beacon stations at the proper ranges, and the point where they intersect is his position.

The radar beacon is actually an outgrowth of the *IFF* (identification, friend or foe) system in use during World War II. In this case, whenever the ground radar system discovers an aircraft, it sends out an interrogation pulse. The frequency of this pulse, its length and spacing, have been predetermined by a specific coding. A beacon transponder aboard a friendly aircraft, when it receives this pulse, will automatically send back a coded reply of identification. If the detected aircraft were of enemy origin, it would presumably be ignorant of the code, so even if it should have its own transponder, it would not be triggered into sending a correctly coded reply. Thus we have an all-electronic ver-

sion of the ancient practice of the password.

One of the most important navigational factors in aviation is altitude, and in providing this information electronics has proven indispensable. The conventional barometric altimeter has two serious disadvantages. First, it indicates altitude above sea level rather than above the immediate terrain. Second, it must be adjusted for the existing condition of the barometer at various points over which the aircraft is flying. This in turn requires that the information be received by radio from the ground, introducing still another possibility for error. As former Flight Radio Officer for a leading airline, this writer knows of several near-tragedies which resulted either from improper operation or interpretation of barometric altimeters.

The Radar Altimeter

Several forms of absolute altimeters have been developed, all employing electronic principles, but the one most commonly used is the reflection type, using the radar concept. The system uses separate transmitter and receiver, with associated antennas spaced some distance apart on the underside of the aircraft, as shown in Fig. 2. Since the speed of radio waves is constant, the time required for the altimeter signal to shoot down to earth and bounce back to the receiving antenna is directly proportional to the altitude.

The signal is frequency modulated, rather than pulsed as in most other types of radars. The receiver compares the frequency of the returning signal with that of the transmitted signal at every instant. With the time required for the signal to

[Continued on page 127]

EXPERIMENT 17

Building a Direction Finder

John J. Smith, *Mechanix Illustrated*



Complete construction kit, ready for assembly. Note muffin tin used for accurate sorting of small parts.

John J. Smith, *Mechanix Illustrated*

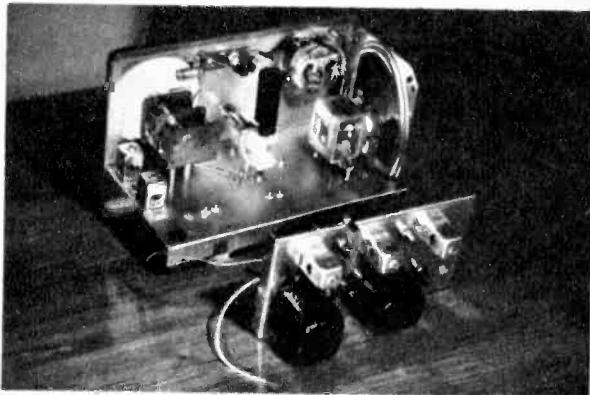

Rear view of completed radio compass without case. Meter controls are at front, speaker at side.

Chart of radio services found in 200-400 kc band.

Checking visual sightings against radio bearings will often show deviation due to unsymmetrical ship.

If in doubt about possible reciprocal bearing, hold course and take second bearing short while later.

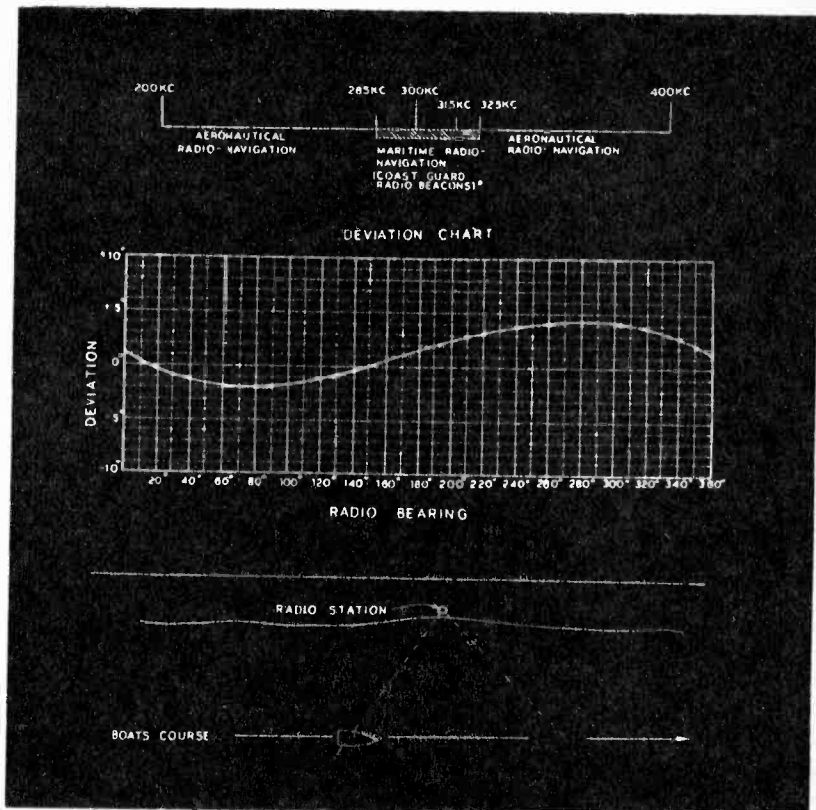

AS we approach the last in this series of experiments, you should now be ready for another major project. This one here demonstrates the principles of one of the oldest forms of electronic navigation, and is a most useful instrument as well.

The radio direction finder is still one of the most accurate means of navigation when properly operated, and the one shown here is built from a Heathkit. The circuit comprises six transistors and covers two bands of frequencies. The low band, from 200 to 400 kc, embraces all marine beacons and most aviation services. The upper band, 540 to 1620 kc, more than covers the standard AM broadcast band.

The first stage is a converter, followed by two stages of i-f. Next the signal is detected by a semiconductor diode, followed by two stages of audio, with the output stage connected in push-pull.

Operation of any radio direction finder depends upon the figure-of-eight directional char-

acteristics of a loop antenna. Between the two lobes of strong signal reception, there are two rather sharp areas of minimum signal, known as nulls. One of these will indicate the true bearing of the station and the other will be displaced by 180 degrees.

To obtain a position fix, the procedure is repeated on one or more other stations, and their bearings plotted in degrees on a chart. Accuracy in establishing a fix will be greatly increased if the angle between stations is always greater than 30 degrees. The point or small area where the two or more bearings intersect is your position.

If your vessel is within a triangle whose sides are imaginary lines between each of three stations, as will usually be the case on inland waters, your plotted fix will probably be a triangle also, within which is your position. In coastal waters, where all shore stations lie in approximately the same direction, your position will fall slightly outside such a triangle.

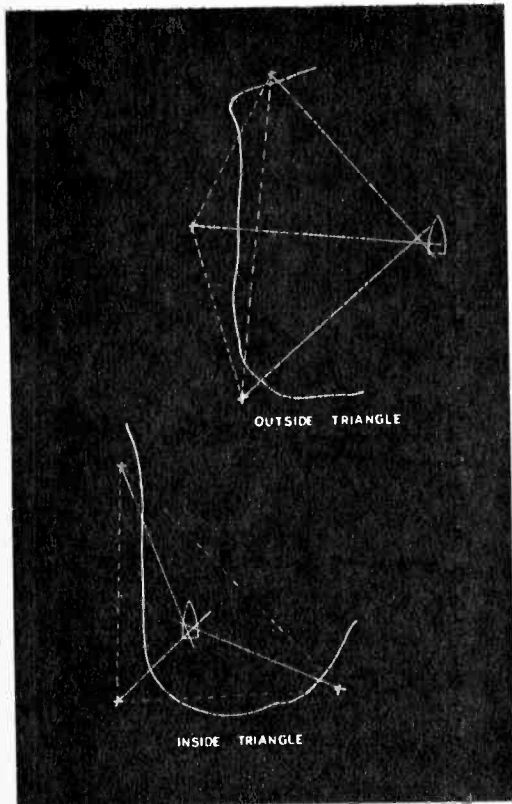

Bob McVea, Advanced Pilot, Plum Beach Power Squadron, N. Y., takes bearing aboard his cruiser.

Bearings within station triangle fix position within triangle. Outside triangle bearings are less accurate.

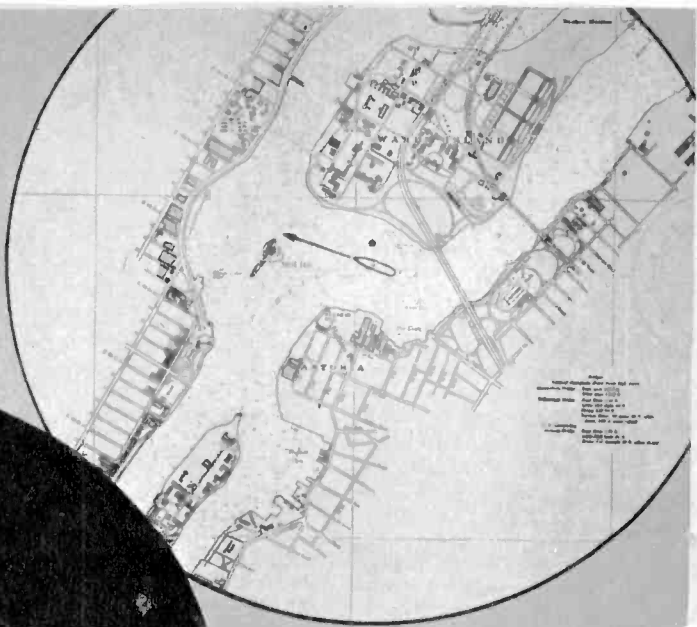
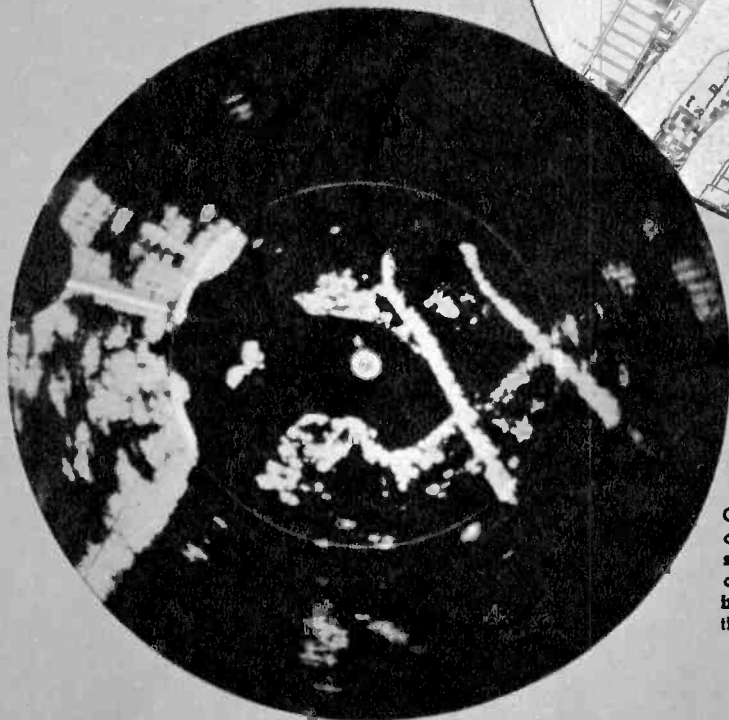

Circle at upper right shows section of an actual map; the circle at left shows the same segment as pictured on a radar screen of a ship. The dot in center is the ship's present position, in the East River, New York.

Radar on board the liner "Empress of Canada" is used to bring the ship to moorings through narrow waterways and in a thick, English fog.
British Information Services

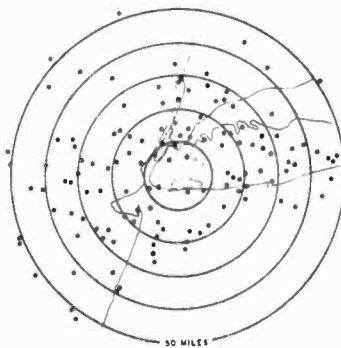
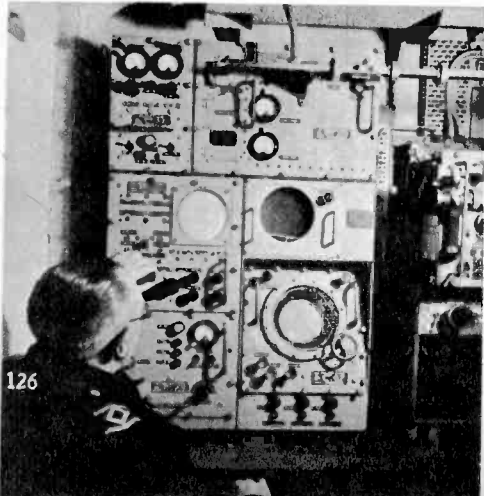

Airborne Instruments Laboratory

Radar display shows distribution of airborne aircraft in the New York terminal area at 10:30 a.m., July 14, 1956. Altitude is not indicated.

[Continued from page 123]

hit ground and bounce back, there will be a difference in frequency between the original and the reflection. With this difference known, the transmission time can be calculated, and from that information, the altitude can in turn be calculated. These computations are actually performed within the instrument, however, permitting the pilot to read his altitude directly in thousands and hundreds of feet.

Before the advent of radar, there were a number of radio aids to navigation, and these systems are still the most widely used. One of these is *ILS* (instrument landing system), which involves several special transmitters on the ground and special receivers aboard the aircraft. The complex radiation pattern of the ILS transmitters is shown in Fig. 3. These combined signals give the pilot very accurate information concerning his course, approach, attitude and distance from the runway.

Landing Beams

The transmitter which gives the course information is the *runway localizer*. This is fairly high powered, with a range of perhaps 40 to 80 miles, depending upon the airplane's altitude. Thus it not only gives the pilot his right-left orientation with respect to the runway, but if he should be arriving from the right direction, it might also serve as a homing device.

Vertical information concerning the approach is sent from the *glide path* transmitter, which gives the pilot an invisible toboggan slide in the air, right down to the runway.

Information from both these signals is conveyed to the pilot through an instrument having two meter movements at right angles to one another. The pointers on the two meters thus cross at right angles when the correct approach is being made. But if the airplane is coming in too low, the glide path pointer will sag down below the horizontal, and if he is too high, the needle will stab up above the center line. Similarly, when the airplane is on course, the localizer pointer will be perfectly vertical, but if the airplane drifts to right or left, the pointer will deflect to one side or the other as well.

In addition to the runway localizer and the glide path, there are two or sometimes three marker beacon transmitters, which send up sharply vertical fan-shaped beams, which tell the pilot how far he is from the runway. The first of these is called the *outer marker*, and is located around 4.5 to 5 miles from the runway. Following this on the approach path is the *inner marker*, about 0.7 to 1 mile from the runway. Finally, there is sometimes a *boundary marker*, which is about 250 feet from the near end of the runway. As the airplane passes over each of these marker beacons, he can hear a tone in his headset, and he may also have a visual indication in the form of a colored light flashing on in his instrument panel. Although the ILS system can bring an airplane in completely "blind," the pilot almost always makes visual contact with the ground at least a few moments before the touchdown on the landing strip.

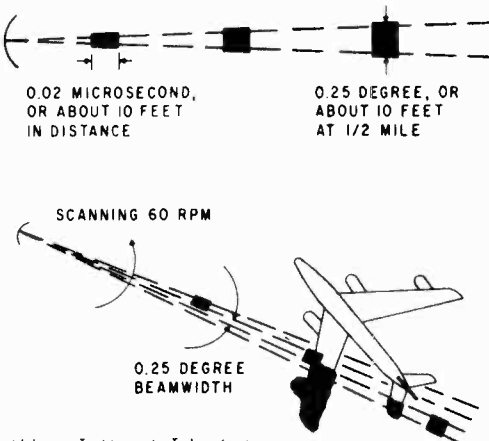

Airborne Instruments Laboratory

At half-mile distance ASDE radar pulse examines target in increments of 10x10 feet. Beam scans across the aircraft and outlines it on radar screen.

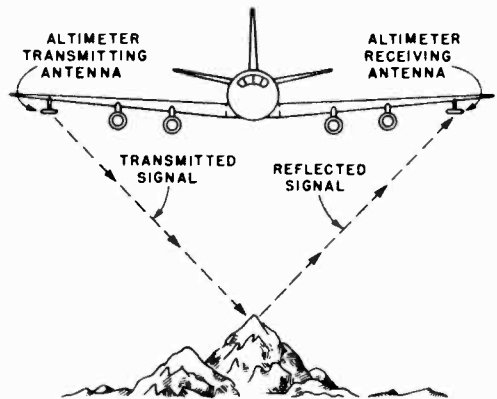
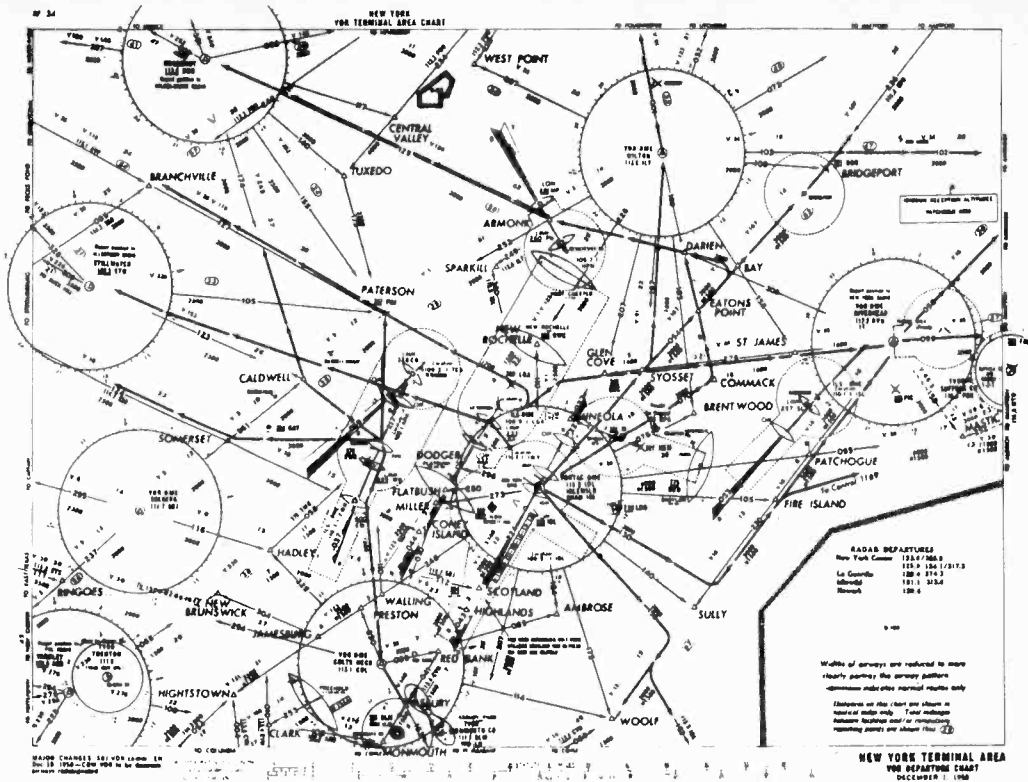

FIG. 2. The radar altimeter is designed to tell the actual height above ground the aircraft is flying over, rather than the sea-level height.



The map above shows the New York Terminal Area VOR Departure routes in 1958.



Recording Fathometer for small pleasure boats can tell operator at a glance the depth of water plus the contour of the bottom.

Raytheon Co.

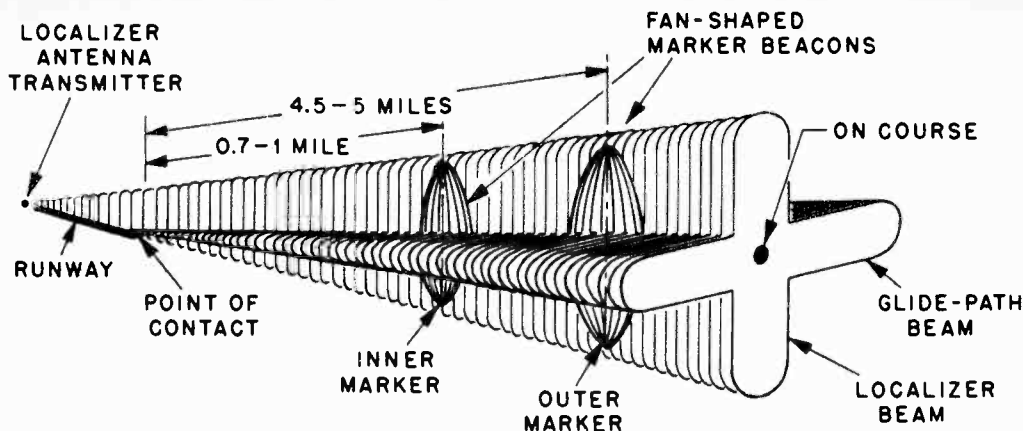

FIG. 3. The ILS arrangement gives an airplane pilot complete information concerning the correctness of his approach for a landing, even in bad fog. See text for full explanation of this system.

Radio Ranges

One of the older forms of radio aids to navigation is the range station, which gives the pilot information on the course to fly on the way to his destination. Although now obsolescent, the radio range is still widely used all over the world, with over 400 such stations in the United States alone.

The radio range comprises essentially two pairs of antenna towers, each pair having a radiation pattern which, in its simplest form, is a figure-of-eight. Each pattern is at right angles to the other, as shown in Fig. 4(A). Into one pair of towers is fed the code signal *N* (dash-dot), while into the other pair is fed the signal *A* (dot-dash). The timing of these two signals is exactly interlocking, as shown in Fig. 5.

An aircraft within the service area of the station will generally receive both the *A* and the *N* signals. In most areas one of the signals will be stronger than the other, but there will be four areas in which the two signals will be of equal intensity and therefore sound like one continuous tone. These solid-tone beams are about 3 degrees wide, and provide four courses for aircraft. These beams crisscross throughout the United States, so that by flying the correct beams of a number of stations, a pilot can fly his airplane to almost any desired airport in the country.

It isn't often, however, that the four beams are wanted at exactly right angles. Other than perpendicular directions are achieved by attenuating the power fed to one of the antenna systems, or by delaying the signal in time, or both. The result of this is shown in Fig. 4(B).

Useful as ranges have been, they do have some serious drawbacks. One of these is

erratic fading at night, caused by irregular reflections from the ionosphere. Another is the multiple courses due to reflections of the waves from mountains. Still another is course bending, resulting from changes in the radiation characteristics as the wave passes from one type of terrain to another. And while these are called range stations, they don't actually provide range (distance) information at all, but only bearing or direction. Finally, the necessity of listening to the on-course tone of the range can be very fatiguing, especially when there are heavy static conditions.

Omnirange

It was in answer to these serious problems that the Civil Aeronautics Authority began planning a new system, dubbed *VOR* (visual omnidirectional range). In this system the ground station transmits two separate signals, one perfectly circular around the station, and the other cardioid or heart-shaped. The cardioid pattern, furthermore, is constantly moving around the station, thirty times a second, something like the sway pole artist at the circus who swings his body around the pole.

The *VOR* receiver is equipped to receive both the stationary circular pattern and the rotating cardioid one. The receiver compares the arrival time (phase) of the two signals and translates this information to compass heading of the aircraft with respect to the station. Thus the pilot has a visual, rather than aural, readout. The biggest advantage of this system is that it permits an infinite number of courses, rather than the four possible with the ordinary range.

The omnirange system still doesn't pro-

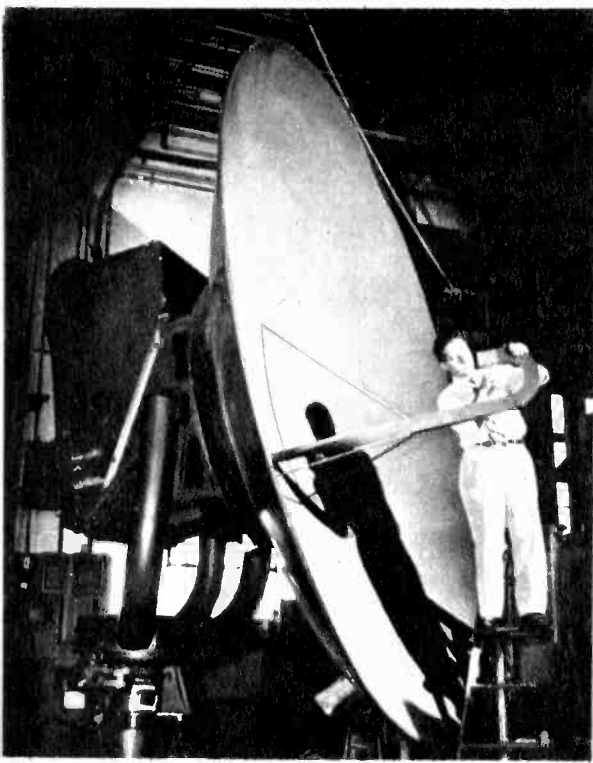

vide range information, however, and here is where *DME* (distance measuring equipment) comes in to form the complete *VOR-DME* system. Essentially a refinement of the radar beacon shown in Fig. 1, *DME* also is a two-way system with interrogator and transponder, and whose airborne receiver continuously measures the time interval between its own interrogation pulses and the reply pulses from the ground. As many as one hundred aircraft can obtain information from a *DME* transponder simultaneously, each one learning its own distance from the station and its ground speed.

Long Range Navigation

Still another electronic aid to navigation, widely used both by aircraft and surface ships, is *LORAN* (long range navigation).

Storm tracker radar antenna, photo left, tracks tornadoes and hurricanes up to 250 miles away, is designed to fit into a planned nation-wide network.

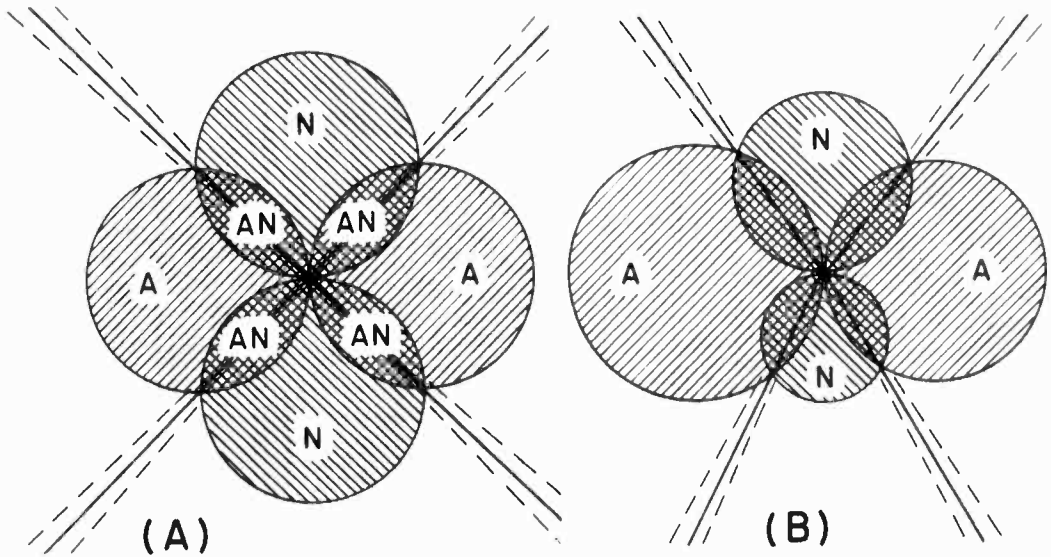

FIG. 4. The basic radio range has four course legs at right angles (A). By varying the antenna powers (B), the angle of each leg may be changed to any degree desired. See text for full details.

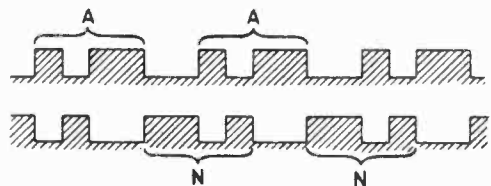

FIG. 5. The "N" and "A" transmissions of the radio range interlock so that they can produce an uninterrupted signal in the on-course area.

Each LORAN station consists actually of two stations, a "master" and a "slave." (See drawing below.) To get a position fix with the system requires tuning to two such pairs of stations.

The master and slave stations transmit identical pulses, except that the slave pulse follows that of the master by a brief interval. Although the time difference is fixed at the points of transmission, it will vary at the receiver position, depending upon where the receiver is located with respect to the two transmitters.

The LORAN receiver measures the time difference between the pulses, and this information will place the ship on a line which has a hyperbola shape, as shown in Fig. 6 on this page. Special charts are available showing the hyperbolas for various time differences.

Knowing he is somewhere on a line, however, is hardly sufficient information for the navigator. But if he tunes in a second pair of LORAN stations and gets a second hyperbola, then he knows that he is right at the intersection of these two lines. Or at least he knows his position within three miles, which is a good deal better than celestial navigation. And it works day or night, in fair weather or foul.

The newest system of aerial navigation is TACAN (tactical air navigation), which while similar to VOR-DME, gives not only range and bearing information, but also tells the position of the interrogating ship. Although hardly more than a dream in 1945, VOR-DME may well be on its way to the scrap heap to be replaced by TACAN, such is the breakneck pace of the electronic art today. •

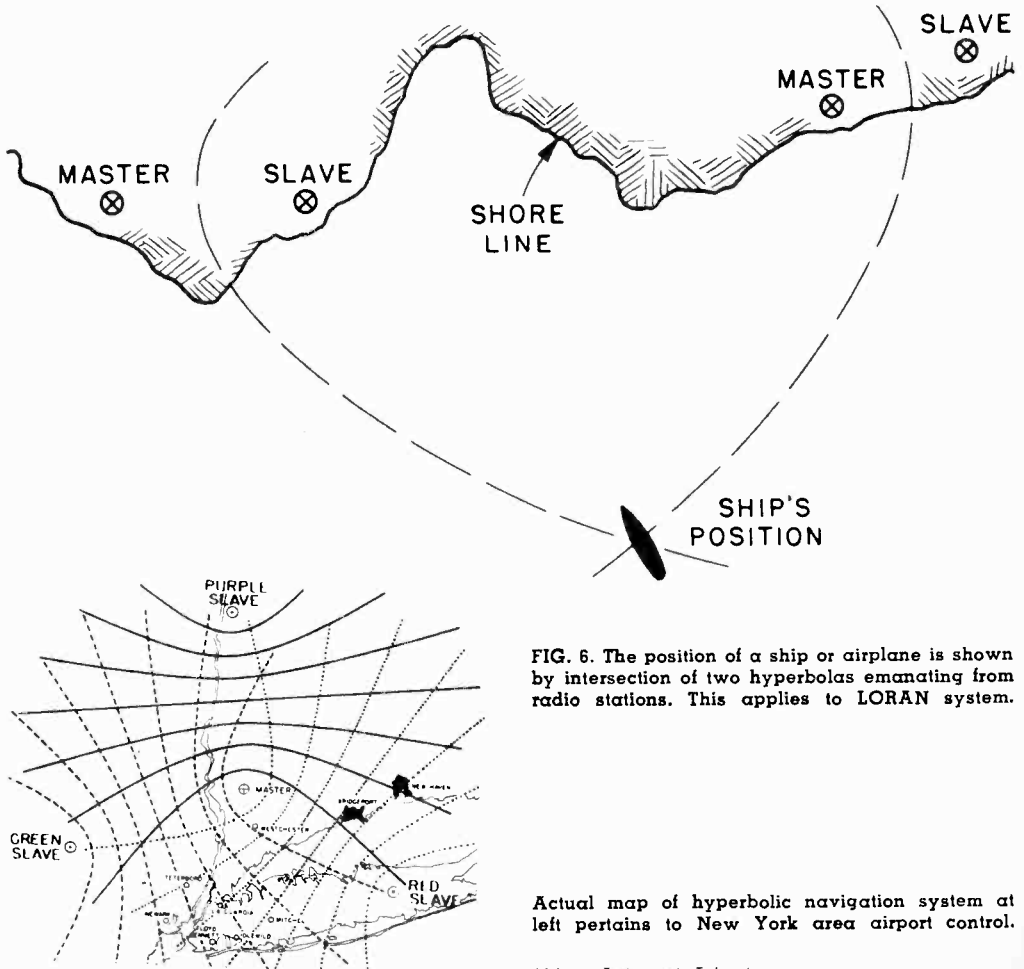

FIG. 6. The position of a ship or airplane is shown by intersection of two hyperbolas emanating from radio stations. This applies to LORAN system.

Actual map of hyperbolic navigation system at left pertains to New York area airport control.

Airborne Instruments Laboratory

Chapter 12

SPACE AGE ELECTRONICS

For satellites and space vehicles

THAT this world of ours is now in the throes of the Space Age is hardly news to anyone. We see constant reminders of it screaming from newspaper headlines day after day. But the immense importance of electronics to the space effort continues to amaze even veteran observers.

It is seldom realized that of the billions of dollars being spent in the United States alone for missile development, very nearly *one-half* goes into electronics, for guidance systems, instrumentation and telemetering. Right now, the dollar volume of the missile electronics business is surpassing both industrial and consumer sales for the first time. This means that missile electronics is bigger than all of radio, TV, hi-fi, computers, industrial and medical electronics,

communications, bigger than all of the other applications of electronics we have studied in this book combined.

Missile Electronics

Computers, electronic navigation systems and radio communications are all important adjuncts to missile applications, and these have been discussed in earlier chapters. We will therefore confine ourselves here to the two rather unique applications of electronics in missiles, namely, guidance and instrumentation.

Missiles are described by various family designations, such as by the job they do, their propulsion system, their guidance system, their speed or their range. For

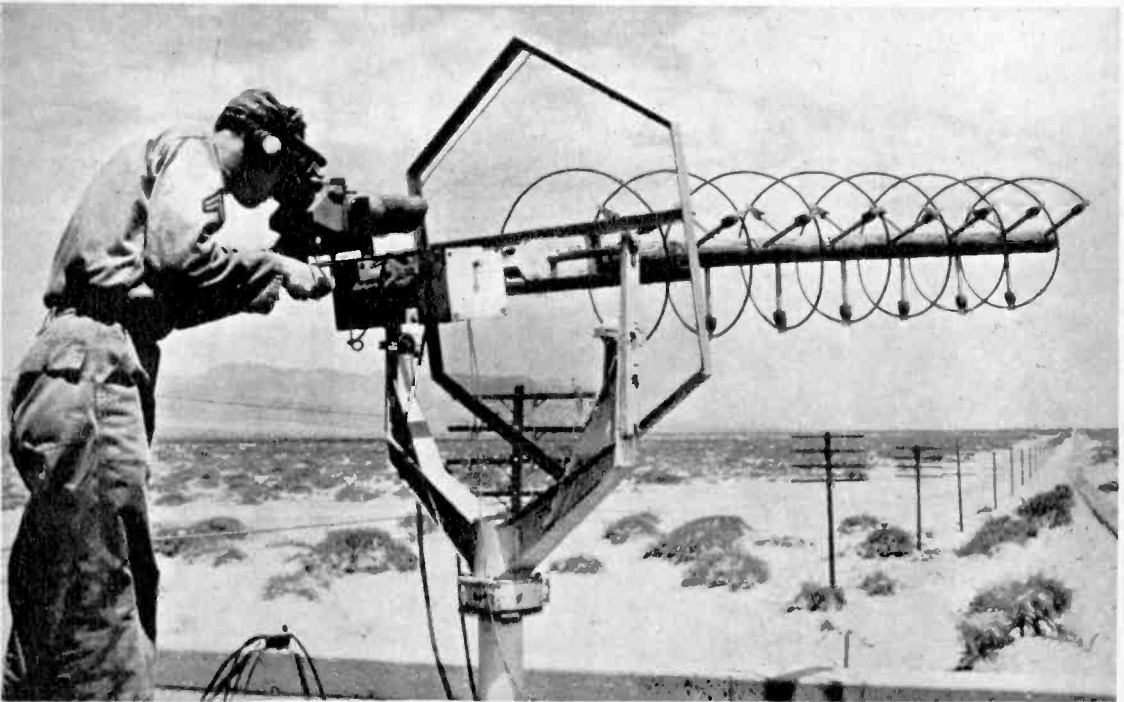

U.S. Army Ordnance

Telemetering antenna is used to track missiles, especially research-type rockets such as the Viking. These antennas are located at several tracking stations, often take on weird shapes.

our purposes, we will consider the two broad applications of missiles today: either military or research.

All missiles comprise four main assemblies: an airframe, a propulsion system, a guidance system and a nose cone. It is in the nose cone, where the *payload* is carried, that military and research missiles differ most. The military nose cone is a warhead, comprising some type of explosive charge and a means of setting it off, while the research missile payload is a satellite and/or an instrument package.

In some types of warheads the percussion charge is set off electronically by a *proximity fuse*. This is a device which is sensitive to some characteristic of the target which is not found in empty air. This might be the light or heat of an engine exhaust. Or it might be the ability to reflect radio waves, using the radar principle. A number of other arrangements are possible, but they all have the same objective: to discharge the warhead when it is in a position to do the most damage.

Whether a missile is to strike a target or go into orbit, it must have some sort of guidance system to get it to its destination.

All of the navigating tools known to mariners for centuries may be used, such as compasses, barometers, sextants, and distance measuring devices. In each case the devices are mechanically connected to the control surfaces of the missile.

An electronic navigation system, similar to LORAN, is called *baseline*. Here radio receivers in the missile use signals of two or more ground transmitters to determine position and alter course when necessary.

Command Guidance

The type of radio control used in model airplanes is in effect *command guidance*. The ship carries a radio receiver which gets steering signals either from the ground or from an airborne transmitter. These signals actuate motors coupled to the control surfaces, to make the missile go up or down, to right or left.

A modified form of command guidance uses two radars. One of these tracks the moving target and the other tracks the missile. Thus the speed, position and
(Continued on page 136)

Official USAF Photo

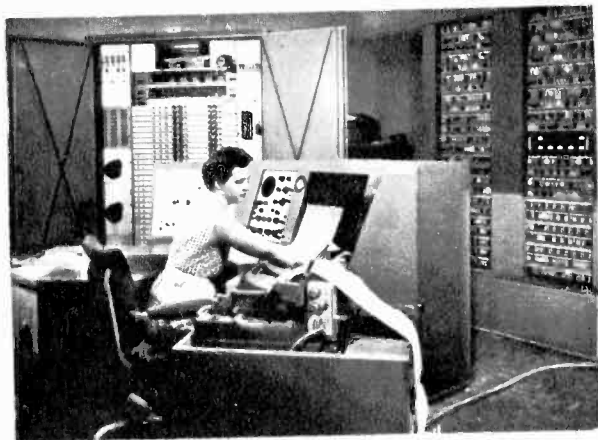

Electronic computer assists in computing data received during flight of a guided missile, in conjunction with tracking instruments, does the work of 50,000 girls with desk calculators.

Army Hawk missile in flight is controlled by the radar system, bottom left. Radars automatically track target, ignore unwanted reflections, enable missile to lock onto and destroy target.

Raytheon Co.



EXPERIMENT 18 *Building a Wireless Relay*

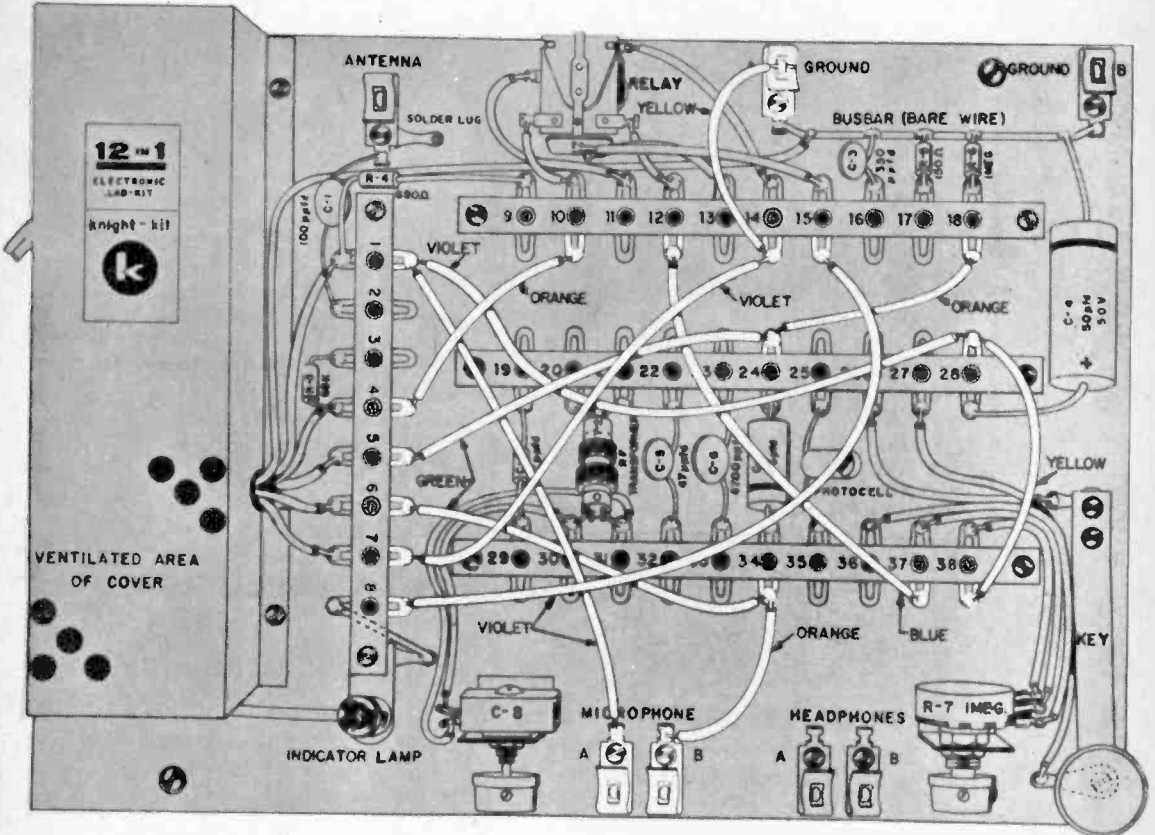

Relay and transmitter are interconnected by tying relay contacts across key contacts, soldering firmly.

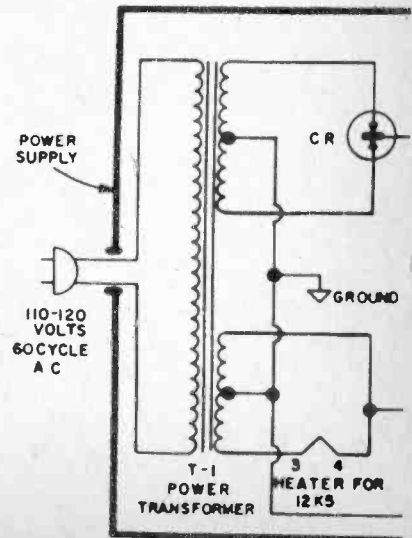
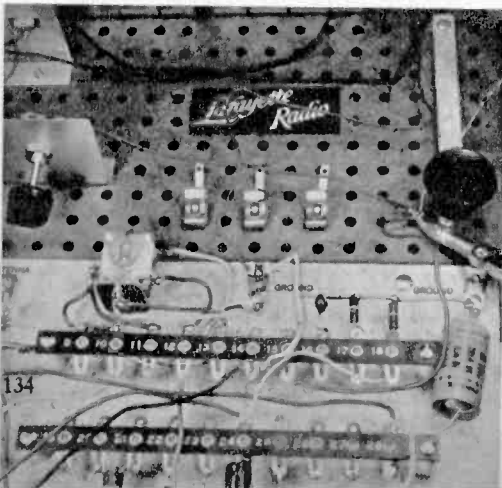

THE voice-operated relay shown here is used in conjunction with the code transmitter you built in Experiment No. 1. Simply connect the relay contacts on the voice relay across the key of the transmitter.

Guided missiles do not normally respond to spoken commands, but they could, and this experiment gives some idea of one way of accomplishing this. When you speak, you actuate the relay which in turn keys the transmitter. Thus it is not your voice which is broadcast, but a tone signal which is keyed on or off at you speak.

In this circuit the tube is conducting when you are not speaking, but will cut off when grid 2 is biased to -2 volts or more. When you talk into the microphone, an electrical signal is developed which varies at the same rate as the sound waves. On the positive half of the signal, the A side of C_7 becomes more positive, causing the B side of C_7 to acquire more electrons and thereby become charged. In the case of a

1,000-cps vocal tone, the charging is completed in about a quarter-cycle.

On the negative half-cycle, the A side of C_7 is less positive. Electrons leave the B side and go through R_6 to ground. Because of the high time constant, however, C_7 is only partially discharged, and there remains a net negative voltage on the B plate.

Successive cycles of the audio signal thus cause the charge to build up further in this zig-zag fashion, and it soon reaches -2 or -3 volts. At this point, since grid 2 is connected to the B side of C_7 , it becomes sufficiently negative to cut off the tube, or at least enough to reduce plate current to the point where the relay is de-energized and the contacts open. Sensitivity is controlled by R_7 . Turning it clockwise increases the resistance and reduces the plate current through the relay winding. The circuit is then more sensitive, as a smaller reduction in current will open the relay.

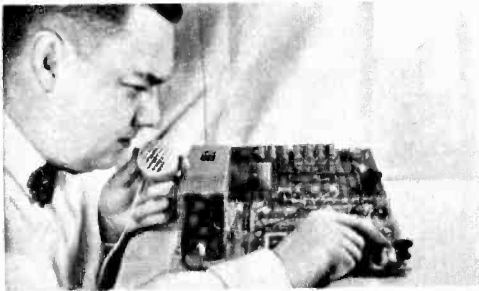

Sensitivity adjustment is made, speaking into microphone at normal voice level.

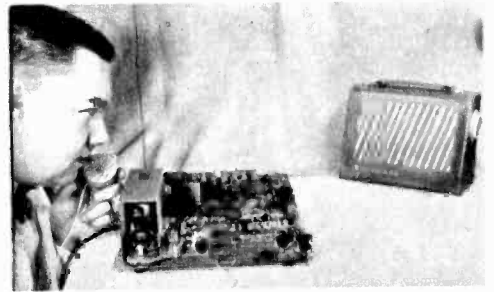

With receiver tuned to transmitter frequency, tone is heard, not voice, when commands made.

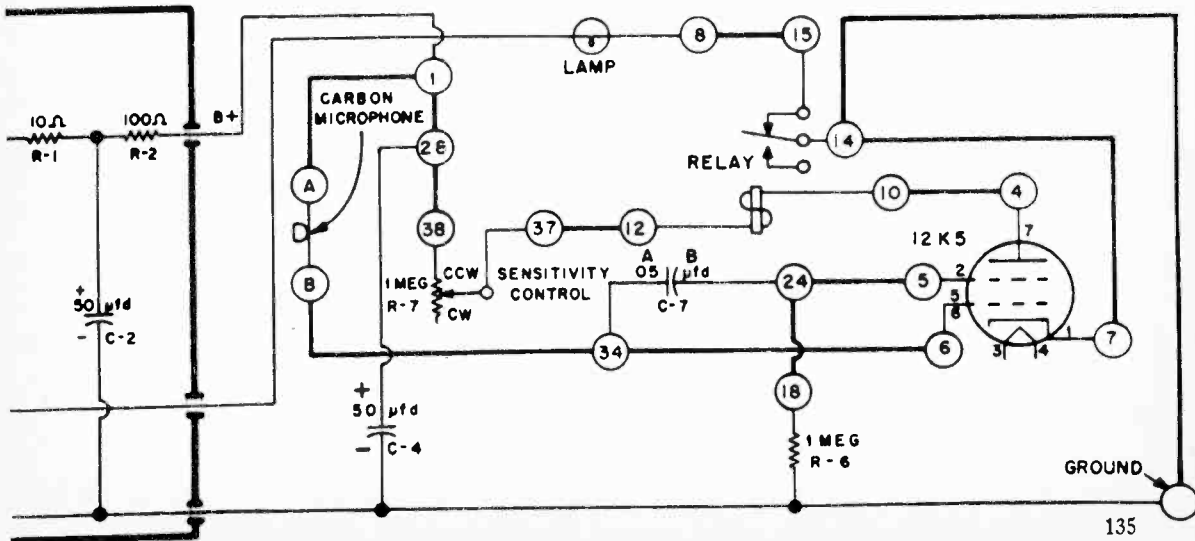



Raytheon Co.

Rapid fire sequence shows Sparrow III, Navy air-to-air missile, being launched from F3H-2 Demon interceptor. Plane carries four missiles which are fired at target automatically when within range.

[Continued from page 133]

heading of both the target and missile are known. These pieces of information are fed into a computer, which almost instantaneously calculates what the missile must do to establish itself on a collision course with the target. This information then goes to the missile by the radio command system, and the missile responds by setting out on its path of destruction.

The *beam rider* uses the principle of the glide path in the instrument landing system. But instead of following a beam transmitted from the ground, the missile

rides right down the middle of a radar beam reflected from the target. This system has the disadvantage that the path of the missile is long and curving, and the missile itself must be highly maneuverable.

These problems are solved, however, by the two-radar beam-rider system, which is similar to the modified command system. A computer is used to set up the collision course, the only difference being in the method of conveying information to the missile. Instead of tracking and correction as in the radar command system, a radio

Here's all you need to build a HEATHKIT®...

...these tools and **NO EXPERIENCE**

We say "NO ELECTRONIC EXPERIENCE NEEDED" . . . and we mean it.

Recognized by leading consumer research organizations as the best in the field of kit construction manuals, the Heathkit step at a time instructions leave absolutely nothing to question. Giant size pictorial diagrams and everyday, non-technical language make every Heathkit easy for anyone to build. No electronic or soldering experience is required; the Heathkit manuals teach you the right way to do a professional job the first time.

No matter what your field of interest, building a Heathkit will be one of your most exciting, rewarding experiences.

And you'll save 50% or more on the world's finest electronic equipment. Send today for your *free* Heathkit catalog—or see your nearest authorized Heathkit dealer.

EVERYTHING FOR STEREO



AMPLIFIERS



TUNERS

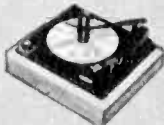

CHANGERS



TAPE DECKS

Mail the coupon Today!



HEATH COMPANY

 a subsidiary of Daystrom, Inc.
Benton Harbor 7, Michigan

Please send the latest Free Heathkit Catalog.

NAME _____

ADDRESS _____

CITY _____ ZONE _____ STATE _____

Subminiature accelerometer amplifier is just one of ten in the experimental X-15's inertial unit. Pictured here, left, is the 100 kc stagger-tuned amplifier. Top right, all-attitude stabilizer for inertial system tells pilot angles of flight. It contains power supply, amplifiers, gyros.

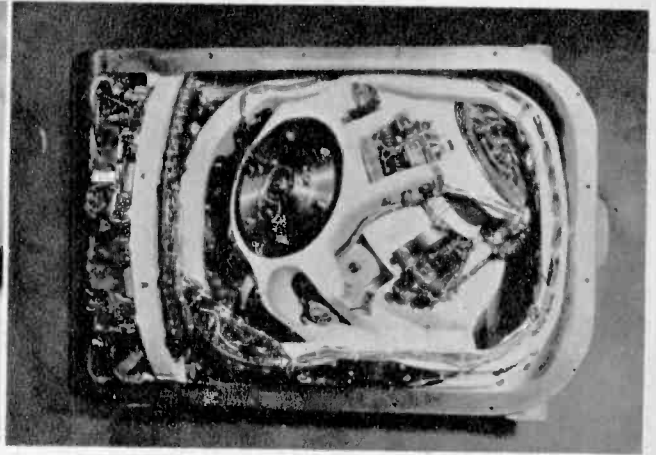
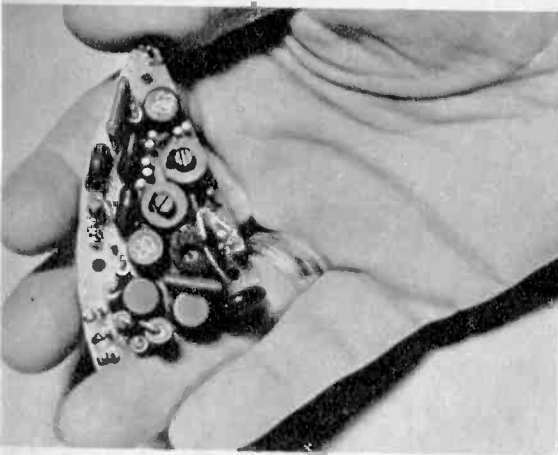

Sperry Gyroscope Co.

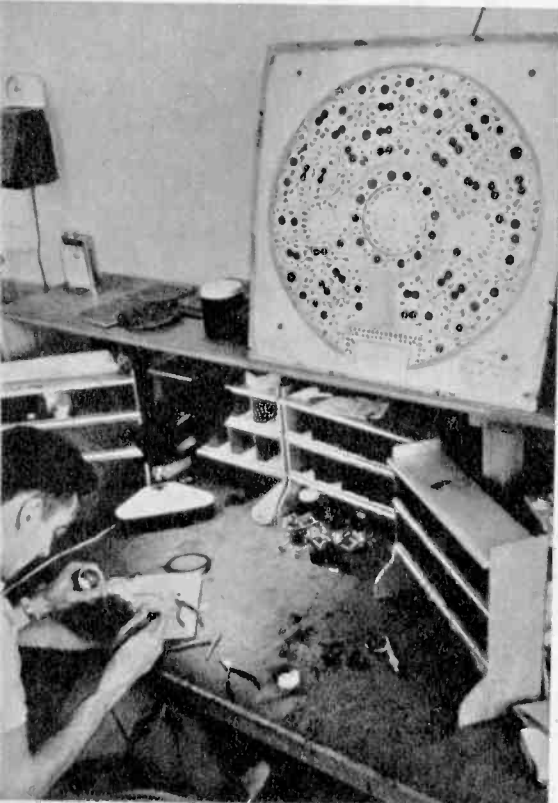

Lloyd Mallan

Wiring of electronic package for U.S. satellite vehicles is shown on large template which is reduced photographically and etched on actual instrument base. Work is done with a magnifier.

beam is sent out for the missile to follow, directed so that in following it the missile will intercept the target.

Homing Guidance

The system in which the missile detects the target and then steers itself to it is the most accurate of all, and is now used almost exclusively in surface-to-air and air-to-air missiles. This system, known as *homing*, has an effective range of ten miles or less, and it is therefore used in conjunction with some other form of guidance, such as beam riding, or the missile is carried to within that range by a mother aircraft.

Homing guidance operates on the same general principles as the proximity fuse. In *active homing* the missile transmits its own radar beam in the general direction of the target, and then acts as a beam rider in homing in on the reflected wave. This has the advantage of making the missile completely self-contained and independent, but has the important disadvantage that the warhead payload will be cut by the additional weight of the radar transmitter.

The missile might also contain only a radar receiver, which homes in on the reflected beam from the target, with the target being "illuminated" by radar transmissions from the mother aircraft or from the ground. This makes the missile dependent on a friendly radar transmitter in the vicinity, and the system is therefore known as *semi-active homing*.

A missile could regain its independence and still not have to carry the excess bag-

BECOME A RADIO TECHNICIAN For Only \$22.95

BUILD 16 RADIO

CIRCUITS AT HOME PRACTICAL only
All Guaranteed to Work! HOME RADIO COURSE \$22.95

Progressive Radio "Edu-Kit"®

NOW INCLUDES

- ★ 12 RECEIVERS
- ★ TRANSMITTER
- ★ SIGNAL TRACER
- ★ SIGNAL INJECTOR
- ★ CODE OSCILLATOR
- ★ No Knowledge of Radio Necessary
- ★ No Additional Parts or Tools Needed

Unconditional Money-Back Guarantee

It is understood and agreed that should the Progressive Radio "Edu-Kit" be returned to Progressive "Edu-Kits" Inc. for any reason whatever, the purchase price will be refunded in full, without quibble or question, and without delay.

The high recognition which Progressive "Edu-Kits" Inc. has earned through its many years of service to the public is due to its unconditional insistence upon the maintenance of perfect engineering, the highest instructional standards, and 100% adherence to its Unconditional Money-Back Guarantee. As a result, we do not have a single dissatisfied customer throughout the entire world.

YOU DON'T HAVE TO SPEND HUNDREDS OF DOLLARS FOR A RADIO COURSE

The "Edu-Kit" offers you an outstanding PRACTICAL HOME RADIO COURSE at a rock-bottom price. Our Kit is designed to train Radio & Electronics Technicians, making use of the most modern methods of home training. You will learn radio theory, construction practice and servicing. THIS IS A COMPLETE RADIO COURSE IN EVERY DETAIL.

You will learn how to build radios, using regular schematics; how to wire and solder in a professional manner; how to service radios. You will work with the standard type of punched metal chassis as well as the latest development of Printed Circuit chassis. You will learn the basic principles of radio. You will construct, step by step, with your own hands, a complete Dynamic Radio & Electronics Tester and the accompanying instructional material.

You will receive training for the Novice, Technician and General Classes of F.C.C. Radio Amateur License. You will build 16 Receiver, Transmitter, Code Oscillator, Signal Tracer and Signal Injector circuits, and learn how to operate them. You will receive an excellent background for Television, Hi-Fi and Electronics.

Absolutely no previous knowledge of radio or science is required. The "Edu-Kit" is the product of many years of teaching and engineering experience. The "Edu-Kit" will give you with a basic education in Electronics and Radio, worth many times the complete price of \$22.95. The Signal Tracer alone is worth more than the price of the entire Kit.

THE KIT FOR EVERYONE

You do not need the slightest background in radio or science. Whether you are interested in Radio & Electronics because you want an interesting hobby, a well paying business or a job with a future, you will find the "Edu-Kit" a worth-while investment. Many thousands of individuals of all

ages and backgrounds have successfully used the "Edu-Kit" in more than 70 countries of the world. The "Edu-Kit" has been carefully designed, step by step, so that you cannot make a mistake. The "Edu-Kit" allows you to teach yourself at your own rate. No instructor is necessary.

PROGRESSIVE TEACHING METHOD

The Progressive Radio "Edu-Kit" is the foremost educational radio kit in the world, and is universally accepted as the standard in the field of electronics training. The "Edu-Kit" uses the modern educational principle of "Learn by Doing." Therefore you construct, learn schematics, study theory, practice trouble-shooting—all in a closely integrated program designed to provide an easily-learned, thorough and interesting background in radio.

You begin by examining the various radio parts of the "Edu-Kit." You then learn the function, theory and wiring of these parts. Then you build a simple radio. With this first set you will enjoy listening to regular broadcast stations, learn theory, practice testing and trouble-shooting. Then you build a more advanced radio. Learn more advanced theory and techniques. Gradually, in a progressive manner, and at your own rate, you will find yourself constructing more advanced multi-tube radio circuits, and doing work like a professional Radio Technician.

Included in the "Edu-Kit" course are sixteen Receiver, Transmitter, Code Oscillator, Signal Tracer, and Signal Injector circuits. These are not unprofessional "breadboard" experiments, but genuine radio circuits, constructed by means of professional wiring and soldering on metal chassis, plus the new method of radio construction known as "Printed Circuitry." These circuits operate on your regular AC or DC house current.

THE "EDU-KIT" IS COMPLETE

You will receive all parts and instructions necessary to build 16 different radio and electronics circuits, each guaranteed to operate. Our Kits contain tubes, tube sockets, variable electrolytic, mica, ceramic and paper dielectric condensers, resistors, tie strips, coils, hardware, tubing, punched metal chassis, instruction Manuals, hook-up wire, solder, etc.

In addition, you receive Printed Circuit materials, including Printed Circuit chassis, special tube sockets, hardware and instructions. You also receive a useful set of tools, a professional electric soldering iron, and a self-powered Dynamic Radio & Electronics Tester. The "Edu-Kit" also includes Code Instructions and the Progressive Code Oscillator, in addition to F.C.C.-type Questions and Answers for Radio Amateur License training. You will also receive lessons for servicing with the Progressive Signal Tracer and the Progressive Signal Injector, a High Fidelity Guide and a Quiz Book. You receive Membership in Radio-TV Club, Free Consultation Service, Certificate of Merit and Discount Privileges. You receive all parts, tools, instructions, etc. Everything is yours to keep.

PRINTED CIRCUITRY

At no increase in price, the "Edu-Kit" now includes Printed Circuitry. You build a Printed Circuit Signal Injector, a unique servicing instrument that can detect many Radio and TV troubles. This revolutionary new technique of radio construction is now becoming popular in commercial radio and TV sets.

A Printed Circuit is a special insulated chassis on which has been deposited a conducting material which takes the place of wiring. The various parts are merely plugged in and soldered to terminals.

Printed Circuitry is the basis of modern Automation Electronics. A knowledge of this subject is a necessity today for anyone interested in Electronics.



Reg. U.S. Pat. Off.

FREE EXTRAS

• SET OF TOOLS

- SOLDERING IRON
- ELECTRONICS TESTER
- PLIERS-CUTTERS
- ALIGNMENT TOOL
- WRENCH SET
- VALUABLE DISCOUNT CARD
- CERTIFICATE OF MERIT
- TESTER INSTRUCTION MANUAL
- HIGH FIDELITY GUIDE & QUIZZES
- TELEVISION BOOK & RADIO
- TROUBLE-SHOOTING BOOK
- MEMBERSHIP IN RADIO-TV CLUB
- CONSULTATION SERVICE & F.C.C. AMATEUR LICENSE TRAINING
- PRINTED CIRCUITRY

SERVICING LESSONS

You will learn trouble-shooting and servicing in a progressive manner. You will practice repairs on the sets that you construct. You will learn symptoms and causes of trouble in home, portable and car radios. You will learn how to use the professional Signal Tracer, the unique Signal Injector, and the dynamic Radio & Electronics Tester. While you are learning in this practical way, you will be able to do many a repair job for your friends and neighbors, and charge fees which will far exceed the price of the "Edu-Kit." Free Consultation Service will help you with any technical problems you may have.

J. Statalis, of 25 Poplar Pl., Waterbury, Conn., writes: "I have repaired several sets for my friends, and made money. The "Edu-Kit" paid for itself. I was ready to spend \$240 for a Course, but I found your ad and sent for your Kit."

FROM OUR MAIL BAG

Ben Valerio, P. O. Box 21, Magna, Utah: "The Edu-Kits are wonderful. Here I am sending you the questions and also the answers for them. I have been in Radio for the last seven years, but like to work with Radio Kits, and like to build Radio Testing Equipment. I enjoyed every minute I worked with the different kits; the Signal Tracer works fine. Also like to let you know that I feel proud of becoming a member of your Radio-TV Club."

Robert L. Shuff, 1534 Monroe Ave., Huntington, W. Va.: "Thought I would drop you a few lines to say that I received my Edu-Kit, and was really amazed that such a bargain can be had at such a low price. I have already started repairing radios and phonographs. My friends were really surprised to see me get into the swing of it so quickly. The Trouble-shooting Tester that comes with the Kit is really swell, and finds the trouble, if there is any to be found."

ORDER DIRECT FROM AD—RECEIVE FREE BONUS RESISTOR AND CONDENSER KITS WORTH \$7

- Send "Edu-Kit" Postpaid. I enclose full payment of \$22.95.
- Send "Edu-Kit" C.O.D. I will pay \$22.95 plus postage.
- Rush me FREE descriptive literature concerning "Edu-Kit."

Name

Address

PROGRESSIVE "EDU-KITS" INC.

Progressive Building, Dept. 504KK, 1184-86 Broadway, Hewlett, N. Y.

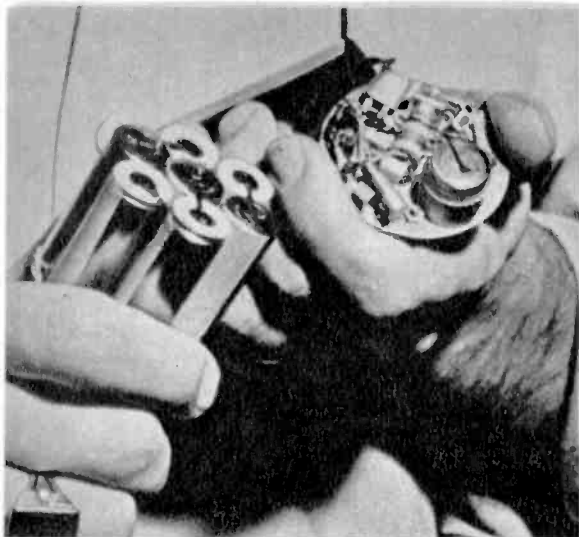

Naval Research Laboratory

Above is shown the size of some of the "bigger" equipment in the "moons" of the Vanguard research rocket; weight is measured in ounces.

Part of satellite instrument package may be this cylindrical Geiger counter for measuring such solar radiations as ultraviolet rays and X rays.

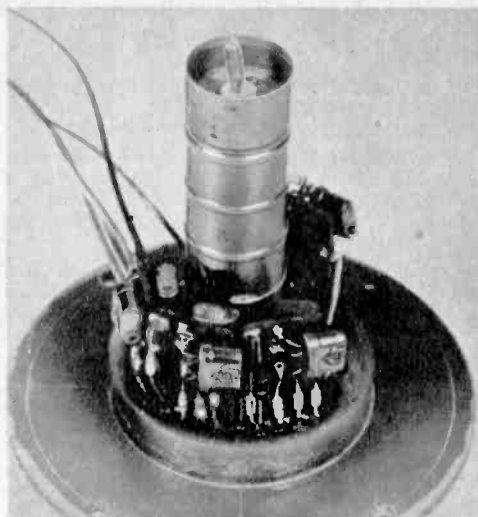

Dr. Fred Ringer, Univ. of Maryland

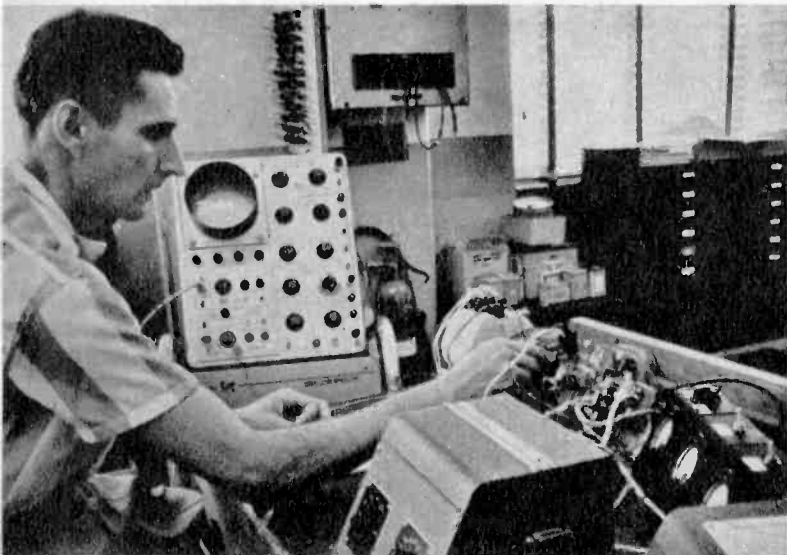

Naval Research Laboratory

Photo left. Exactng tests are performed before any of the instruments are mounted into a satellite nose cone. Here, engineer checks a meteor-impact counter with the help of laboratory scope.

Right. Diagram shows how instrument-bearing rockets report briefly on solar rays during their flight above atmosphere.

gage of a radar transmitter, if it could home in on some sort of wave emanating from the target itself. This is known as *passive homing*. These waves could be radio transmissions, if the target would be so cooperative; or they could be light waves, as long as the sun is shining.

Infra-Red Detection

But the best method yet is to home in on the heat radiations from the engines of the

target. The sensitive detection system aboard the missile operates on *infra-red* principles. The Navy has been particularly active in developing this technique, which has all of the advantages of active and semi-active homing, and none of the disadvantages. Its *Sidewinder*, for example, can detect an enemy target at distances up to seven miles, and home right into the exhaust nozzle of the target's engine.

A research missile may be of the probe type, carrying an instrument package de-

signed to relay back by radio information the conditions it encounters during a relatively short journey. Examples of this type are the *Aerobee* and the *Loki*. Or the missile may carry a satellite to be spun into orbit, and which itself carries instrumentation. Examples of the latter type include the *Vanguard* and *Viking*.

There is no really typical instrument package in either type. Presently missile and satellite payloads are limited to perhaps a half-dozen instruments at most, each of them fairly complex. Some of the following instruments described will be found in every satellite.

Temperature measurement is accomplished through the *thermistor*, a resistor whose resistance varies with temperature. When a voltage is impressed across it, the varying current provides a ready-made signal for modulating the telemetering transmitter.

Meteoroid Detection

Several devices are used for detecting the presence and effect of meteoroids, the solid particles travelling through space. One of these is simply a microphone whose diaphragm is mounted flush with the skin of the satellite. Any collisions will be clearly heard on the received signal.

Micrometeoroids, no larger than dust specks, may well erode the shell of the satellite, much like sandblasting. An erosion gauge on the surface will have its electrical resistance increased as parts of it are worn away, and this too will be duly

Naval Research Laboratory

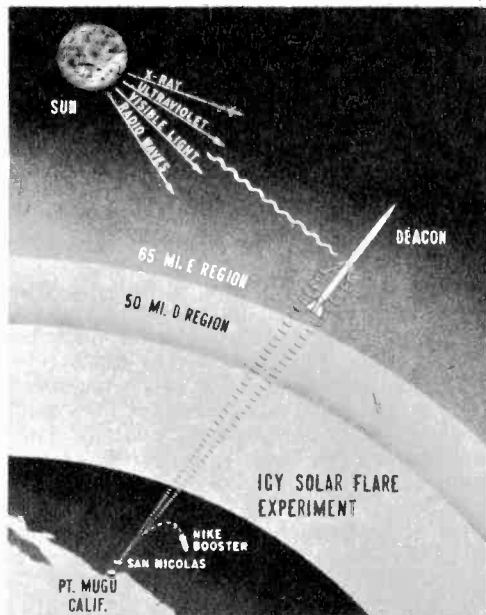

FREE ALLIED'S MONEY-SAVING 1960 ELECTRONIC SUPPLY CATALOG

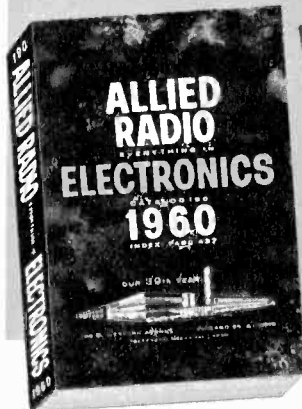

value-packed
SEND FOR IT!

SAVE
ON EVERYTHING
IN ELECTRONICS

EASIEST TERMS
only \$2 down on
orders up to \$50

see the best values

Send for the most widely used buying guide to everything in Electronics for Experimenters, Builders, Amateurs, Servicemen, Engineers and Hi-Fi enthusiasts. Save on:

- KNIGHT-KITS®—Best in Build-Your-Own
- Everything in STEREO HI-Fi
- Hi-Fi Music Systems and Components
- Tape Recorders & Phono Equipment
- Public Address & Paging Systems
- TV Tubes, Antennas, Accessories
- Amateur Station Equipment
- Latest Test & Lab Instruments
- Parts, Tubes, Transistors
- Everything in Tools & Technical Books

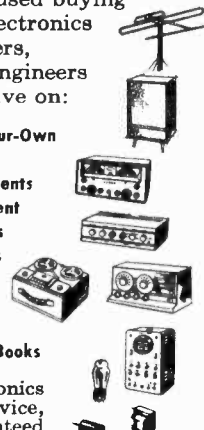

SAVE on everything in Electronics at ALLIED—get fastest service, expert personal help, guaranteed satisfaction. Send today for your FREE 1960 ALLIED Catalog.

Everything in Electronics
from One Reliable Source

our 39th year



- ALLIED RADIO CORP., Dept. 95-0
- 100 N. Western Ave., Chicago 80, Ill.
- Rush FREE 1960 ALLIED Catalog.

Name _____

Address _____

City _____ Zone _____ State _____



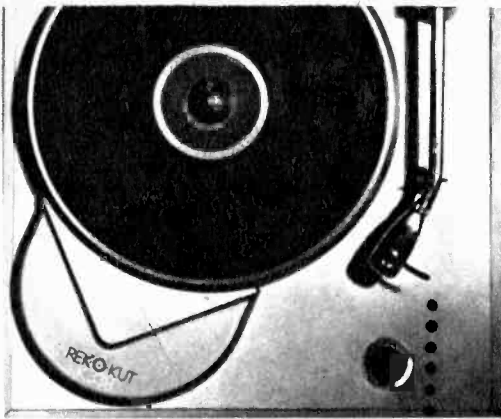

WHY PAY MORE?

Assemble your own stereo phono system and SAVE! Pictured above is the REK-O-KUT K33-H turntable kit (33 1/3 rpm) with hysteresis motor, matching REK-O-KUT S-120 12" arm, and unfinished base kit. Total assembly time is less than one hour. Only \$92.85. With your purchase of the above, you will receive the Shure M7D magnetic stereo cartridge FREE.

All units in factory sealed cartons. Full mfg'r's warranty. Shipments f.o.b., N.Y.C. Ask for audio discount catalog A-11.

KEY ELECTRONICS COMPANY
120 LIBERTY ST., N. Y. 6, N. Y.

free



**SHURE
M7D**

REG. NET VALUE
\$24.00

FOR THE
WOULD-BE
HAM
AND THE
NOVICE...



If you're interested in ham radio, this is the book for you.

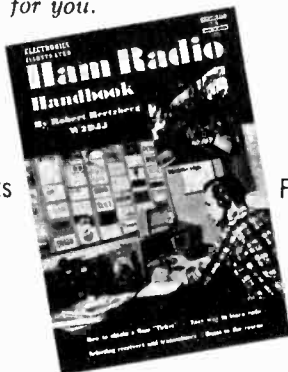

75 cents

FB 415

on sale at local newsstands

to order direct: Send 75 cents to FAWCETT BOOKS, Dept. 437, Greenwich, Conn. Add 10 cents per copy for mailing. No Canadian orders.

Complex transmitter and experiment instruments designed for the Far Side rocket must withstand extreme temperatures and velocity conditions.

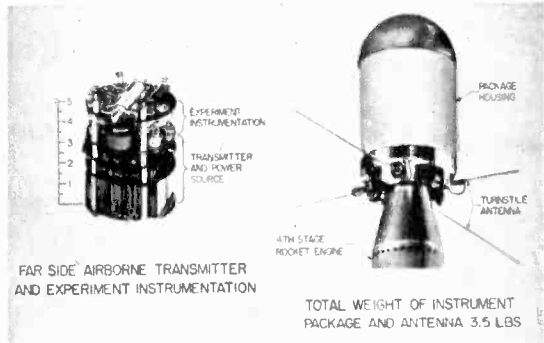
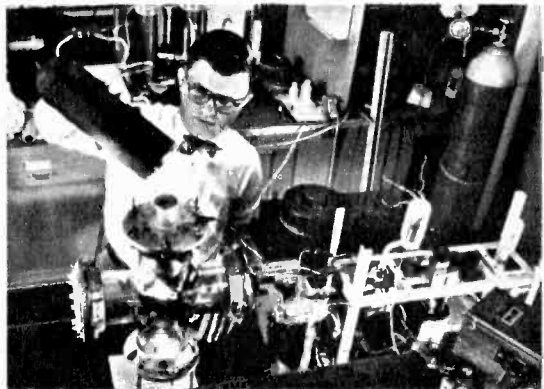

Photo right. Minute slice of silicon crystal is used as sensing device for satellite telemetry system. Performs functions of objects on table.



Radio Corp. of America

Experimental solar battery cell is studied here under simulated high altitude conditions. Glass vacuum chamber holds cell during radiation experiments with protons, X rays, alpha particles.

reported back to earth tracking control.

If any punctures are made by collision with meteoroids, pressurized compartments will leak air to outer space and the pressure will fall to zero. A bellows-type pressure gauge will immediately respond to this change and develop an electrical signal which is transmitted to earth.

It is believed that much of the radiation from outer space never reaches the earth, but instead is absorbed by the atmosphere. Just what rays may be involved, and in what quantities, are questions which the satellites are helping to answer.

Ion chambers mounted in the skin of the satellite detect ultraviolet radiation. These are small transparent capsules containing gas under low pressure. When ultraviolet

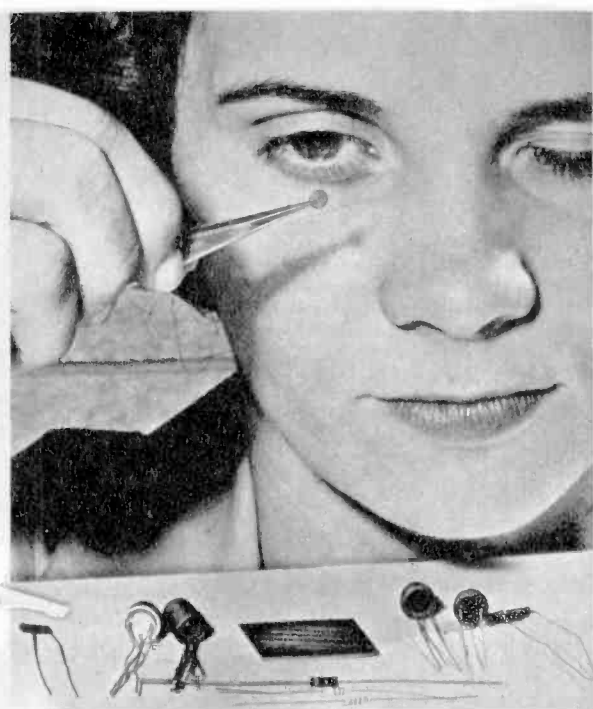

Westinghouse Co

Below is experimental solar generator which is intended to harvest solar energy for some future space ship powered by this form of electricity.

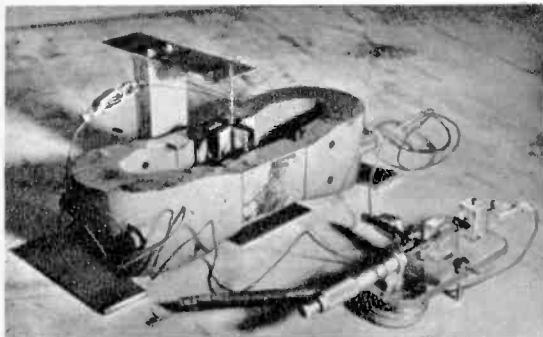

Wright Air Development Center, USAF

rays strike the gas, its ionizes and becomes conductive, with the resulting current providing signal information. The Geiger-Mueller tube, which is similar in principle, can be used for the detection of cosmic rays. And infra-red detectors can be used to record radiation at that end of the spectrum.

Some satellites even have memory units, actually miniature tape recorders. These will broadcast the recorded information on command, then erase and record more. Since weight and space are at such a premium aboard satellites, it is not possible to have separate tape recorders for each instrument. And even with multi-track recording it isn't possible to record upwards of six tracks simultaneously on quarter-



FREE

Fill in coupon for a **FREE** One Year Subscription to **OLSON RADIO'S** Fantastic Bargain Packed Catalog — Unheard of **LOW, LOW, WHOLESAL**E PRICES on Brand Name Speakers, Changers, Tubes, Tools, Hi-Fi's, Stereo Amps, Tuners and other Bargains.

NAME _____
 ADDRESS _____
 CITY _____ ZONE _____ STATE _____

If you have a friend interested in electronics send his name and address for a **FREE** subscription also.

OLSON RADIO CORPORATION

260-G Forge St. Akron 8, Ohio

No Risk Trial Guarantees you can

FIX ANY TV FAST!

.. or pay not one cent!

NO EXPERIENCE OR HIGHER MATH NECESSARY

Let 10 days' use of this book prove you can install and repair any TV set like an expert. You'll be amazed how easy it is to spot most troubles by eye and ear alone—how the clear, step-by-step instructions and illustrations reduce even the most complicated problems to simple a-b-c's. Quickly and easily, with this manual to guide you, you can turn your up-to-the-minute knowledge into plenty of spare-time cash or be your own boss in a profitable business.

In this new edition you get: The latest circuits—Troubleshooting techniques—Transistorized TV sets—Remote control tuning—Troubleshooting printed wiring—Module type construction—Packaged circuits—Newest servicing hints—Latest information on color TV and test equipment . . . every new advancement plus the basic know-how you need to put any set back in perfect working order. Mr. C. W. Morris of Charleston, W. Va., says: "I have paid as much as \$200.00 for courses that haven't given me the clear understanding this book has."



All New! 3rd Revised Edition

TRANSISTORIZED TV
 COLOR SETS
 PRINTED CIRCUITS
 DEFLECTION METHODS
 DC RESTORATION
 ANTENNAS
 POWER SUPPLIES
 SYNCHRONIZATION
 POOR PICTURES,
 SOUND QUALITY,
 ALIGNMENTS, UHF

TRIAL COUPON—MAIL TODAY

PRENTICE-HALL, INC., Dept. 5217-B1
 Englewood Cliffs, New Jersey

Please send me **TELEVISION SERVICING** for which I enclose \$2.75 as first payment. Then after I have used the book for 10 days, if I am not satisfied I may return it and get immediate REFUND of my first payment. Or I will keep the book and send you two more payments of \$2 a month for 2 months until full price of \$6.75 is paid.

Name _____
 Address _____
 City _____ Zone _____ State _____

SAVE! Send \$6.75 now and we'll pay postage. Refund and same return privilege guaranteed.

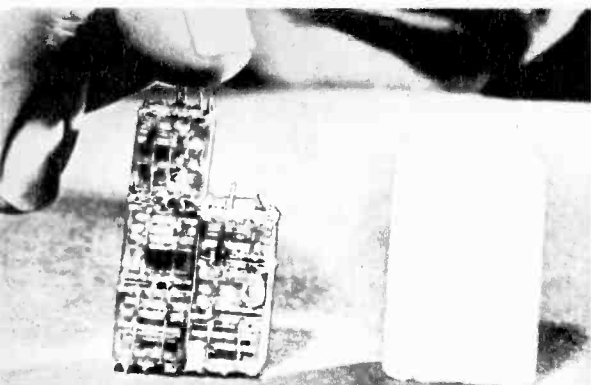

Left. The "works" of a military radio no larger than a sugar lump, designed for missile equipment. Micro-modules take the place of transistors and other components, measure one-third inch.

Radio Corp. of America

Weather-eye satellite launched with Vanguard missile contained the instruments shown below. A 5½-inch wide tape recorder recorded and then transmitted data to ground after each trip around earth. Total weight of sphere was only 21½ lbs.

Wide World Photos

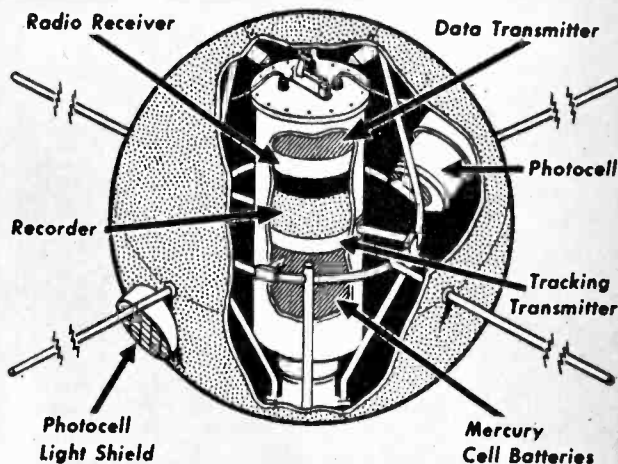
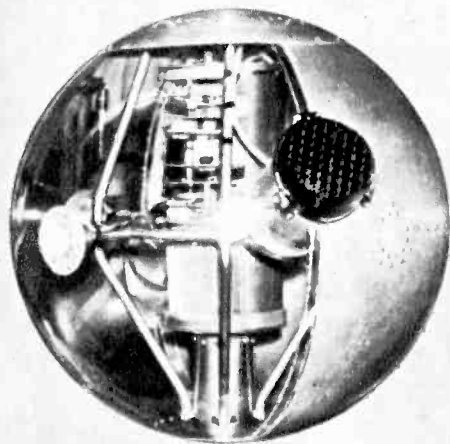

inch tape. The signals are therefore recorded sequentially, each instrument for a short time. Switching occurs quite rapidly, so that the reading of no instrument is lost for more than a short period of time.

Satellite Tracking

The main reason for the memory system is the fact that the satellite tracking network, extensive as it is, does not blanket the entire world. Some readings, such as ultraviolet and meteoroid signals are too important for any of the information to be lost. But if the satellite should be out of range of any of the authorized listening stations, it would be lost, except possibly to some alert monitor in another part of the world who had no right to the information.

The readings of the various transducers and gauges are therefore recorded by the miniature tape system, and transmitted down at high speed on command from the ground. The command consists of a special coded signal, also sent by radio. This means that the satellite must have two additional pieces of equipment, over and above the instrumentation and telemetering transmitter. These are the tape recorder and the command receiver.

The command system also prolongs the

life of the transmitters, and as long as they continue in operation they provide the best method of tracking the satellite's course. The system of radio tracking known as *Minitrack* is a development of the U. S. Naval Research Laboratory. The system comprises a chain of receiving stations located in a line running throughout North and South America. Thus, while the western hemisphere is quite adequately covered, during the time the satellite is over the eastern hemisphere, it is not under observation of the *Minitrack* system.

But when the satellite passes over the *Minitrack* line, two or more ground stations will at all times be able to receive its signal. Each station then measures the angle of elevation of the satellite above the horizon and, of course, the exact time of the sighting. Knowing then the distance and the altitude of the horizon, as well as the measured angle, it is a simple problem in trigonometry to determine the altitude and bearing of the satellite. With two such observations made simultaneously from two different *Minitrack* stations, the exact position of the satellite can be pinpointed. Since most satellites have been in orbits which cause them to cross the *Minitrack* line perhaps a dozen times a day, their exact course and future positions can be predicted with considerable accuracy. •

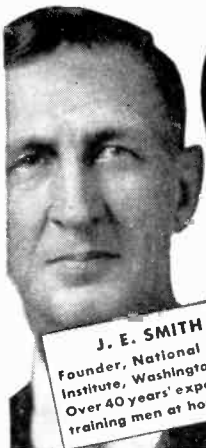

J. E. SMITH
 Founder, National Radio
 Institute, Washington D.C.
 Over 40 years' experience
 training men at home.

Mail Postage-Free Card for
SAMPLE LESSON FREE
Shows you how easy, practical it is to
Train at Home for RADIO
TELEVISION ELECTRONICS

Oldest and Largest Home Study Radio-Television Training School. N.R.I. has Trained Thousands for Good Pay Jobs

Since 1914 . . . for more than 40 years—N.R.I. has been training ambitious men at home in spare time for Radio-TV. Let us send you a sample lesson to help prove you can keep your job and TRAIN AT HOME in your spare time for better pay and a brighter future. We will also send N.R.I.'s 64-page catalog to show you that Radio-Television is today's field of OPPORTUNITY for properly trained men.



Television Making Good Jobs, Prosperity

The technical man is looked up to. He should be. He does important work, is respected for what he knows gets good pay for it. There are splendid opportunities for the man well trained in Radio-Television Servicing or Broadcasting, Government, Aviation, Police, Ship, Micro-Wave Relay, Two-Way Communications for buses, taxis, trucks are growing Radio-TV fields, making more good jobs.

N.R.I. is the Tested Way to Better Pay

N.R.I. Training is practical, thorough. You get the benefit of N.R.I.'s 40 years' experience. Many successful N.R.I. men start without any knowledge of Radio, many without high school education. Find out what Radio-Television training can mean to you. Make the first move today toward becoming one of that select group—a Radio-TV Technician. Send postage-free card for Actual Lesson and 64-page Catalog, both FREE. NATIONAL RADIO INSTITUTE, Dept. OBE6, Washington 16, D. C.

WHAT N.R.I. GRADUATES DO AND SAY



Has Own Radio-TV Business

"We have an appliance store with Radio-TV servicing. During Army service, NRI training helped me get top rated jobs"—W. M. WEIDNER, Fairfax, S. D.



Chief Engineer with KCCU

"I am Chief Engineer with station and also have my own spare time servicing business."—R. BARNETT, Bismarck, N. D.



Paid for instruments from Earnings

"I am doing very well in spare time. Sometimes have three TV jobs waiting, also fix car radios"—G. P. SEAMAN, N. Y., N. Y.

See Other Side

Without Extra Charge
NRI Sends Equipment for Practical Experience



Training is based on LEARNING-BY-DOING. N.R.I. training includes kits of parts which you use to build equipment and get practical experience on circuits common to both Radio and Television.

Shown at left is low-power Broadcasting Transmitter you build as part of N.R.I. Communications Course. FREE Catalog shows other equipment you get, things you learn.

FIRST CLASS
 Permit No. 20-R
 (Sec. 349, P.L. & R.)
 Washington, D.C.

BUSINESS REPLY CARD

No Postage Stamp Necessary If Mailed In The United States

POSTAGE WILL BE PAID BY

NATIONAL RADIO INSTITUTE

Washington 16, D. C.

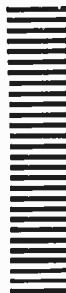

Learn Radio Television Electronics

by Practicing at Home

N.R.I. SENDS KITS with which you practice building circuits, common to Radio and Television. You LEARN-BY-DOING. As part of N.R.I. Servicing Course, you build Vacuum Tube Voltmeter and AC-DC Receiver shown here.

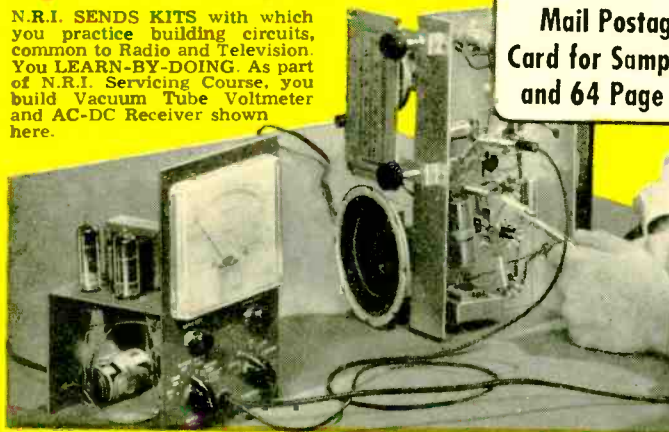

2 BOOKS FREE

Mail Postage-Free
Card for Sample Lesson
and 64 Page Catalog



Fast Growing Field Offers You Good Pay, Success, Bright Future



J. E. SMITH,
Founder, N.R.I.

Bigger than ever and still growing. That's why Radio-Television has special appeal to ambitious men not satisfied with their future prospects. More than 4,000 Radio and TV Stations use trained technicians. 150 million home and auto Radios and 40 million TV sets must be kept in service. Color TV promises added opportunities. There are good jobs, bright futures in Radio-TV Servicing or Communications. Training PLUS Opportunity is the ideal combination for success. Plan now to get into Radio-TV. The technical man is looked up to, does important work, gets good pay. Keep your job while training. With N.R.I. you learn at home in spare time. N.R.I. is the OLDEST and LARGEST home study Radio-TV school. Its methods have proved successful for more than 40 years.

Many Good Jobs in Radio-TV Servicing and Communications for Trained Men



 **See Other Side**

CUT OUT AND MAIL THIS CARD NOW

Sample Lesson & 64-Page Catalog

Both FREE

NO STAMP NEEDED—WE PAY POSTAGE

NATIONAL RADIO INSTITUTE
Dept. OBE6, Washington 16, D. C.

Mail me Sample Lesson and 64-page Catalog. (No salesman will call. Please write plainly.)

NAME _____ AGE _____

ADDRESS _____

CITY _____ ZONE _____ STATE _____

ACCREDITED MEMBER, NATIONAL HOME STUDY COUNCIL



Start Soon to Make \$10—\$15 a Week Extra in Your Spare Time

Soon after enrolling, many N.R.I. students start to earn \$10, \$15 a week in spare time fixing sets for friends and neighbors. Some make enough to start their own full time Radio-TV shops. Easy-to-understand lessons teach you basic principles. You LEARN-BY-DOING on N.R.I. equipment which "brings to life" things you study.

Find out what N.R.I. offers. Study fast or slow—as you like. Diploma when you graduate. Mail postage-free postcard now. **ACTUAL LESSON FREE.** Also 64-page catalog that shows opportunities, equipment you get. Cost of N.R.I. courses low. Easy terms. **NATIONAL RADIO INSTITUTE, Dept. OBE6, Washington 16, D. C.**