



Bell Laboratories Record

Volume Seven

MARCH, 1929

Number Seven

Leadership In Industrial Research

By FRANK B. JEWETT

Excerpts from an address before the symposium on organization of scientific research in industry, held as a part of the New York meeting of the American Association for the Advancement of Science, December 29, 1928

TWENTY-FIVE years of doing, finding and encouraging others to do scientific research in industry, and of organizing the machinery for the smooth and effective conduct of such research, have left me with a feeling that so far as this branch of human activity is concerned the problems in essence are not materially different from those met elsewhere. Years ago, in a less mature period of life, I may have thought that the effective industrial research man was a being somewhat different from his fellow workers in adjacent fields. I may have thought that some peculiar slant of mind, some slightly different outlook on life, or some special appraisal of relative values branded him with a distinguishing hallmark that designated him unescapably for special treatment and special relationship in the industrial environment.

If such ideas were ever mine, I

have long since outgrown them. My present view is that except in those details which are the direct consequence of a particular function, the problem of finding and encouraging competent men in industrial research is in no substantial measure different from the finding and encouragement of competent men in any walk of life. If this conclusion is correct, the subject I have been asked to discuss narrows itself down to a consideration of the things which distinguish achievement in industrial research from achievement elsewhere.

In any discussion of this sort we must have clearly in mind at the outset that which we wish to consider, namely, the finding and encouragement of *competent* men, that is, men competent in a creative sense or competent in those characteristics of administrative ability which make them fit leaders of industrial research groups or organizations. It is to these

men, relatively few in number, to whom we must look for those substantial results which in the last analysis will be the justification for industrial research as we have come to understand it. Without them the term "industrial research" is merely the designation of a shallow thing of little present and no prospective worth.

In both pure science and industrial research the men who succeed will be, for the most part, those men in whom the element of curiosity about nature and her ways is a controlling urge. With similar desires and similar training the forces which tend to place the individual in the pure science field or that of applied science will be those secondary influences concerned with the allurements of the academic surroundings, the desire to have one's work concretely useful, or some of the thousand factors of propinquity, heritage, environment or chance.

Per contra, I take it for granted that a man is essentially miscast and essentially a transient if he finds himself in a field of endeavor where the primary requisite for success is alien to the thing he most desires. Even if this desire is unrecognized by him at the start, it will sooner or later develop and either wean him away from his environment or leave him a dissatisfied and essentially unproductive member of a fraternity with which he is out of tune.

Put concretely, what I have in mind is that a man driven, let us say, by a zest for personal wealth and the things which personal wealth will buy, is essentially miscast if he embarks in a field which does not lead pretty directly to individual personal wealth. The occasional case, of a man capable of turning the opportunities of an otherwise unpromising occupation to

the advantage of an aspiration which would normally find its easiest accomplishment elsewhere, is no refutation, I think, of this thesis. Wealth resulting directly or indirectly from one's work, on the other hand, may be and frequently is quite different from the desire to accumulate a fortune.

Or, take the case of the man whose greatest satisfaction is tied up with his desire to exercise power over his kind. He is in unhappy surroundings, momentarily at least, if perchance he finds himself engaged in an occupation the apex of whose success is power over the force of nature.

Except in a minor way, there is no large available reservoir in which we can fish for men of proven competency in industrial research. Here and there we may, if we are so minded, pick out a man who has won his spurs in the field of pure science and transfer him to our industrial research, or we may on occasion avail ourselves of an opportunity to transfer a man of maturity from one part of the industrial research world to another. Neither of these processes is, however, of any considerable value in strengthening industrial research. The first is a questionable procedure, particularly if indulged in freely, since the price paid for a temporary advantage is the almost certain degradation of the ultimate supply of trained men and new fundamental knowledge. The second is a mere shuffling of the cards in the deck and in some cases is ethically objectionable.

To those of us who are concerned with the building up and perpetuation of industrial research groups to function effectively year in and year out, the problem of finding competent men boils down in the last analysis to our ability to find competent *young*

men and, having found them, to bring them into the organization, provide them with the facilities and encouragements for growth, and ultimately to make leaders of them. For the most part our search leads always in the same direction, namely, to the parts of those institutions where men are given advanced training in science.

Out of the youthful timber which we find here we must make our selection. Occasionally the choice is easy—more often hard. To know and appraise a man well one must live and work with him for a long period. For the most part we who are in search of men do not have this opportunity. We must rely on such casual tests as our experience leads us to think worth applying. We should in the main be able to eliminate those who have inadvertently chosen an uncongenial occupation and who even though temporarily inducted into the industrial research field will not continue there for long. We should likewise be able in many cases to eliminate those who, while properly cast in the field of scientific research, would nevertheless find the environment of the industrial research laboratory distasteful as compared with the atmosphere of the college or university. Occasionally but not always we may be able to eliminate the precocious but superficially brilliant youth. It is from the remainder, after these eliminations, that we must make our choice. That choice should be entrusted to men of experience and understanding.

In my twenty-five years of association with industrial research I have had occasion personally to select many men. Looking back over an experience of successes and failures, it seems to me that in the majority of the successes final judgment was based about

one-third on my personal appraisal and about two-thirds on the considered judgment of a baker's dozen or so of men in the academic world who had had a relatively long and intimate opportunity to observe the subject of choice. Per contra, in the majority of cases which were not successes I am inclined to think that too little attention was paid to the experienced judgment of those in the best position to know, or too much dependence was placed on the expressed opinion of those whose judgment I should have distrusted for any one of a number of reasons.

Summed up, therefore, I should say that in attempting to select young men who in later life will be successful in industrial research, a primary requisite is to come to know the wise men in our college, university and technical school faculties whose judgment applied to the young men they have instructed makes them a more efficient sieve than any casual outsider can hope to be. True, they may not be able to tell you that "X" or "Y" is suitable for your particular situation—that is a matter which you alone are in the best position to judge. They should, however, be able to give you substantial advice, not only as to character but as to the reasonable chance that the youthful evidences of ability are the early fruits of a substantial continuing harvest and not merely an exotic flowering or the reflections of a casual environment.

In the matter of encouragement there is, I think, but little to be said. In a general way we of industry can give encouragement which induces young men to choose aright in the selection of their college and university training. More specifically, when competent men come to us we can see

to it that their surroundings, the conditions of their association with their fellows, and the tools with which they work, are congenial and adequate. Above all, we must see to it that a just recognition of their achievements is accorded them. While adequate monetary reward in the form of salary or otherwise is a necessary and very important part of the problem of encouragement, it is in many cases, beyond a certain point, less important to peace of mind and continued productivity than are the conditions of environment and of a sympathetic human understanding of things accomplished, obstacles overcome or problems to struggle with.

Neither with respect to the matter of choice nor with the problem of encouragement are there in the field of industrial research, more than elsewhere, any hard and fast rules which can be applied with machine-like precision. We are human beings dealing with other and, to a large extent, with younger human beings. The constants and variables of our particular equations may differ but they are still the same equations with which other groups in other fields are struggling to solve like problems. Our success or failure in the selection and encouragement of men in the industrial research field is to a large extent a test of individual skill and judgment.



The Secret of Riches

“Buying good stocks for long-term appreciation is not speculation, but a very large part of all stock buying is rash, ill-informed and due solely to temporary delusions of grandeur which disappear with the next falling market.

“It is the instinctive if not consciously reasoned out appreciation of such facts as these on the part of the great bulk of our people which accounts for the enormous and rapidly increasing sums placed in trust, the continued growth of savings banks, the augmenting popularity of annuities and the seventy or eighty billions of dollars of life insurance now in force. The young man with a wife and two children to support knows that if he buys the right common stock he will be rich some day. But he may die before he has bought enough for the purpose or before he has discovered whether his selections were wise, and then his loved ones will be in want. Unless the American dollar disappears as completely as the old German mark, he knows that the insurance-company obligation will positively do what it purports to do.”

—Albert W. Atwood, in “Saturday Evening Post.”



Curious Patents In Mechanical Switching

By P. C. SMITH
Patent Department

THE epoch-making invention of the telephone embodied only a two-station system. As its importance became evident, inventors began to look about for means of interconnecting a large number of telephone stations through a switching center. At that time adequate switching means were unknown except those which had been developed for the allied art of telegraphy, and these were not adapted for local use but for connecting widely scattered centers of population. Only manual methods of interconnecting lines were available but inventors at once began investigations to develop mechanical

In 1879, about three years after Alexander Graham Bell's invention, an application for patent was filed which covered the first attempt at the automatic switching of telephone lines. This patent, Number 222,458, and granted December 9, 1879 to Connolly, Connolly, and McTighe, disclosed a very crude and inefficient device. Although not successful, it was the beginning of a long line of research and invention.

Since then, inventor after inventor has attacked the problem until approximately 2500 patents have been issued by the United States Patent Office relating to machine-switching telephone systems and apparatus, and at the present time such patents are being issued at the rate of approximately one every three days. In addi-

tion hundreds of patents have been issued to inventors in foreign countries, notably in Germany, France and Great Britain. Many of the inventions are crude in concept, are entirely uncommercial in their adaptability to the telephone industry, and might be termed mere paper inventions. This, however, is true of all branches of the arts and sciences since many invent who have little skill in mechanics or little knowledge of the art or science into which they have delved. However, many inventions in the art of machine-switching telephony, which in themselves are impracticable and seemingly in the nature of patent monstrosities, possess the nucleus of basic principles of machine switching. Indeed the percentage of machine-switching telephone patents which might be termed curiosities is much smaller than the percentage of such patents in other arts.

One of the most unique of the early suggestions is found in the patent to Callender, Number 511,874, granted January 2, 1894. Probably every child has arranged runways and watched marbles roll to various receptacles. This childhood game has been ingeniously utilized by the inventor for establishing telephone connections. How this was accomplished is shown fragmentarily by Figure 1, from which most of the electrical circuits have been omitted for clarity and in which only two of the possible ten subscribers' lines have been shown.

Assuming that subscriber No. 1 desires to establish a connection with subscriber No. 2, he will transmit two impulses to the central office, causing the rotary magnet RM to step the switch track 1 into connection with the inclined runway R2 and also causing the energization of the switching magnet SW1. A path is now prepared for establishing the desired connection and at this point the releasing magnet Rel is energized to release two steel balls B and B' from the storage track 2. These roll down track 2, out upon switch track 1, which is now joined to runway R2, and thence down runway R2 to the gate G2 which has been depressed through the energization of switching magnet SW1. Upon reaching gate G2, the balls roll down and come to rest upon the contacts of cross-connecting plate P2. This plate has two pairs of contact members which, bridged by the balls, establish a talking circuit between the lines of the two subscribers.

When the conversation is terminated, the calling subscriber rings off, which operates magnet A1. This action allows the balls to drop from plate P2 onto the return runway 3 which conveys them to the elevator belt 4. This raises them again to the storage track 2 to be in readiness for establishing another connection. Had subscriber No. 2 called subscriber No. 1, only one impulse would have been transmitted which would have rotated switch track 1 into line with runway R1, and magnet SW2 would have been operated instead of magnet SW1, depressing gates in all runways but R2. Thus when the balls were released, they would have rolled down runway R1, been deflected by gate G4 and come to rest upon plate P1, thereby bridging contact members to connect substation No. 2 with substation No. 1.

An interesting feature of this invention is a storage track associated with each runway R1, R2, etc., onto

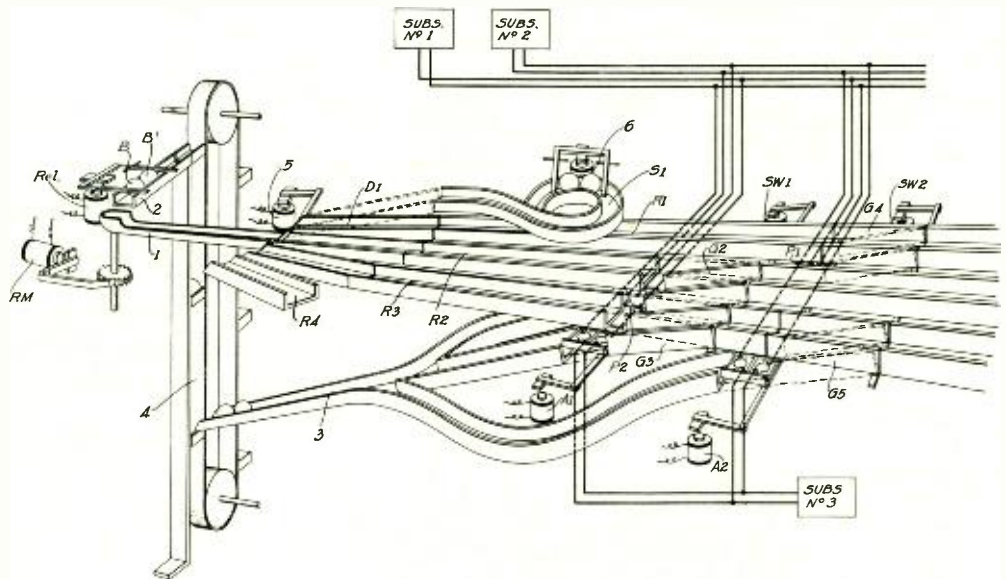

Fig. 1—An invention of Callender uses metal balls rolling down inclined troughs to make the connections between lines

ich balls may be deflected. In the diagram only storage track S₁, associated with runway R₁, has been shown. If, for example, subscriber No. 1 has been called and another call is initiated for completion to his line, the deflecting gate D₁ will be operated by magnet 5, and the balls released from storage track 2 for establishing the second call will be deflected to the track S₁, where they will be held as long as subscriber No. 1 is busy. As soon as his line becomes idle, magnet 6 becomes energized and the balls are released from the track S₁ and roll out upon runway R₁ to complete the new connection in the manner previously described.

Another inventor has employed some of the principles of a railway system. This was Moise Freudenberg, who was granted patent Number 556,007 on March 10, 1896. The general features of his invention are illustrated diagrammatically in Figure 2. For each subscriber's line of a hundred-line system, the inventor provided an insulated track upon which was a metallic car or wagon. Just under the tracks, C₁, C₂, etc., and at right angles to them, was a number of metallic beams, B₁, B₂, etc., each connected respectively with the movable contact members D₁, D₂, etc., of a two-coordinate plate switch. Corresponding sta-

tionary terminals of each plate switch were multiplied together and connected individually to the several subscribers lines. Each plate switch, such as P₁, was provided with a car-

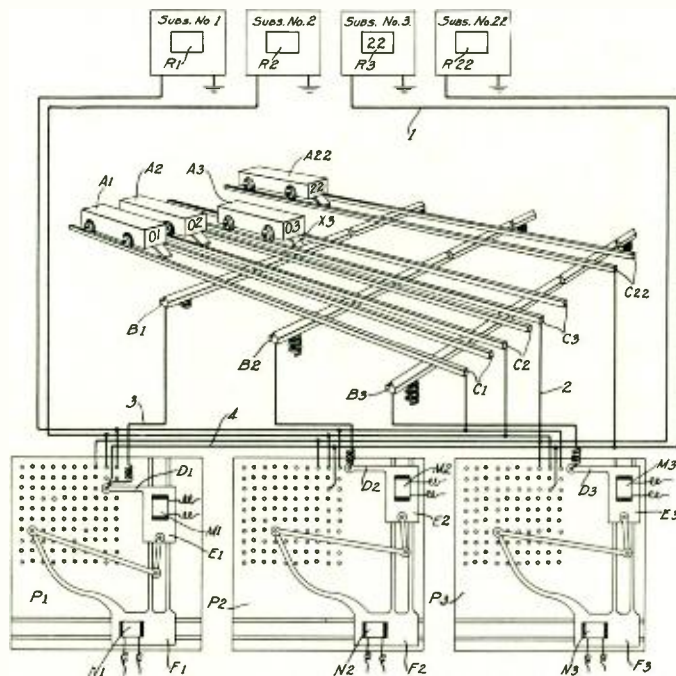

Fig. 2—A central office built in accordance with the patents of Moise Freudenberg would have resembled a large terminal freight yard. The cars supposed to make the connections between subscribers, however, would have been in size like those of toy electric trains

riage F₁, moving on a stationary track on the plate and carrying a second track upon which a second carriage E₁ could move at right angles to the first carriage. The contact member D₁ was supported by the carriage E₁. By suitable linkage and the magnets M₁, N₁, the two carriages were arranged to progress D₁ over the entire contact field of plate P₁, and the extent of the coordinate movement was recorded by a visible registering device at the calling subscriber's station.

If, for example, the subscriber No. 3 desired to establish a connection with the substation of subscriber No. 22, he started his wagon A3, by electrical means, out upon its track C3 to hunt for a beam B. A projection X3 on the under side of the wagon hit the first idle beam, made electrical con-

R3 each position assumed. When the calling subscriber saw the desired line number, 22, appear on his register, he released a button which arrested further movement of the plate switch. He was then connected with the desired subscriber's line, No. 22, over a talking circuit extending from

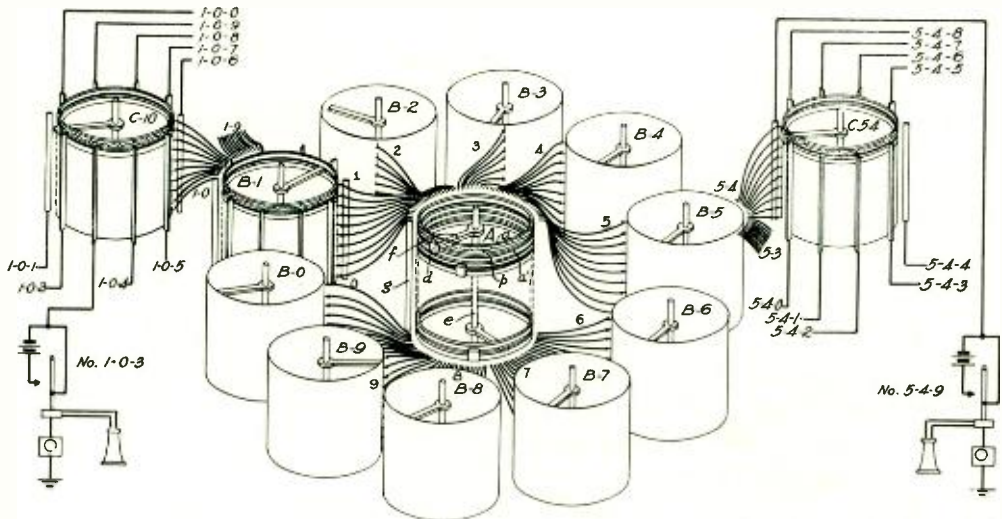

Fig. 3—A patent granted to J. W. McDonough discloses features more nearly allied to the trend taken by later development

nection with it, and swung it down out of reach of any other subscriber's wagon. The plate switch to which this beam was connected was now at the service of the calling subscriber. If any other subscriber desired a connection his wagon would pass over the depressed beam of the plate switch which was in use and avoid interference with the existing connection.

Immediately the connection to P1 had been established, by the projection X3 of the car A3 making contact with and depressing B1, the plate switch was set in motion by operation of magnets M1 and N1. The contact member D1 was swept over the contact field, and as it moved registered on the calling subscriber's register

ground, through his substation-set, wires 1 and 2, track C3, wagon A3, projection X3, beam B1, wire 3, contact member D1, terminal Number 22 of the plate switch P1, wire 4, through the subscriber's substation-set Number 22 to ground.

The telephone system devised by J. W. McDonough and for which he was granted patent 538,975 dated May 7, 1895 is also quite unique as the inventor has proposed phonographic announcing means at each switching stage to inform the calling subscriber of the progress of his call. This system, illustrated diagrammatically in Figure 3, consisted of a central switch A having a number of pairs of rings, a, a1, arranged one

ve the other, one ring of each pair bearing a phonograph record p. Sliding upon the outer surfaces of each pair of rings was a contact carriage holding a magnet, certain levers, and catches, and a phonographic transmitter. Supported at the axis of the rings was a shaft e rotated continuously by an electric motor and adapted through radial arms f to push the carriages around their respective pairs of rings. Arranged around the outer periphery of the switch were one hundred vertical bars or gates g divided into ten groups of ten each, with which the carriages made contact in their movement. In general, the construction of the other groups of switches B and C was similar except that each terminating switch C had but ten gates.

The ten groups of gates of the central switch A were connected by wires to the ten pairs of rings on the ten switches of the B group, and the ten groups of gates of each switch B were connected by wires to the ten pairs of rings on ten terminating switches C₀, C₁, etc. The ten gates of each switch C were in turn connected to a group of subscribers' lines. Thus a single switch A, ten switches B and one hundred switches C gave access to the

lines of one thousand subscribers.

In making a call a subscriber, No. 1-0-3 for example, would take his receiver from the hook and listen to the signals 1-0-1, 1-0-2, etc., until he heard his own number 1-0-3 when he would depress a button to stop a carriage of switch C₁₀, thereby connecting his line to switch B₁. As the carriages of switch B₁ rotated, signals were sent out 1-0, 1-1, 1-2, etc. Upon hearing his own division number 1-0 the subscriber would again depress his button stopping switch B₁, thereby connecting his line to the central switch A. The subscriber now heard the numbers of the gates past which the carriages of switch A were passing and upon hearing the first digit 5 of the desired subscriber's number (for example, 5-4-9) he again depressed his button, giving him access to switch B₅ of the fifth group. In a similar way, he heard the numbers 5-4 and 5-4-9 transmitted by the successive operation of the group switch B₅ and terminating switch C₅₄.

These early inventions although highly impracticable possessed some features which appear in all modern automatic switching systems; and the early inventors must be given credit for the contributions which they made.



A New Telephone Door for the Retail Shop

By L. J. BOWNE

Systems Development Department

SHOPPING by telephone is widely accepted as a modern convenience. Small business establishments such as grocers and butchers have employed the telephone for soliciting and accepting orders ever since it came into commercial use, obtaining by this means a considerable increase in business at the small expense of telephone service. Such service is fast, as the customers usually are well acquainted with the proprietor or clerk, who knows practically the whole stock in trade.

Large department stores have realized that the telephone could be profitably employed for shopping in their line also if the personal contact, which is automatic in the case of a small establishment, could be obtained, and if the switching required to handle telephone orders were of a simple character. By selecting a permanent group of specially trained clerks to handle all telephone orders, the personal element can be secured, and by employing the No. 2 order turret the switching operations are reduced to a minimum.

Ordinarily the PBX in large organizations is a clearing house for incoming calls, but telephone shoppers as a rule do not know which department they want to talk to, and the attention of several departments may be necessary for a single order. This requires special attention on the part of the switchboard attendant in making connection to the proper de-

partment and later in transferring the call to other departments. The load from telephone shopping may be considerably greater than that from other business, and the handling of all calls at a single switchboard often necessitates more attendants and a larger PBX than would be required if different types of calls were separated. Other objections to connecting the customer directly to the various departments are the delay caused by clerks' not answering the telephone promptly, and the impracticability of maintaining systematic supervision over the telephone sales service.

A study of the problem indicated that if the telephone shopping service could be separated from the regular service, economies in handling both would be effected. These economies have been realized by using two groups of trunks from the central office, each having a separate listing in the telephone directory; one group, used for the ordinary business of the establishment, is terminated in the regular PBX; and the other, used for telephone shopping, in No. 2 order turrets.

At the order turret, incoming traffic differs from that at an ordinary PBX because no switching is involved and the patron's first contact then is with an order clerk. On an incoming call a signal lamp with a white cap lights in the section of the turret between two order clerks. A duplicate lamp lights on the opposite side

of the turret between two other order clerks and, if more than one turret is employed, similar lamps light at the other turrets. The order clerk answers the call at any one of the positions by plugging one of two single-ended cords into a jack associated with the lighted lamp. This extinguishes all the white lamps to indicate that the call has been answered, and lights red busy lamps at each position to indicate that the line is not available for outgoing service.

Operating the talking key associated with the cord connects the order clerk's telephone to the line. Ordinarily the clerk completes the call by taking a record of the order or by furnishing the desired information to the patron. Occasionally, however, when more specific information is wanted than is available at the turret, the clerk either arranges to call the

patron later or, requesting him to wait, obtains the desired information for him from another department. To do this she restores the talking key, which holds the line by a bridge in the cord circuit, and then operates the key on the other cord at her position, which connects her to the PBX operator. By this method the clerk may talk to any desired station in the establishment. If desired an arrangement may be provided by which the order clerk can connect the patron also to the PBX station, establishing a conference connection by the proper operation of the two keys at her position. This eliminates the necessity of transferring the patron at the PBX and reduces the possibility of a misunderstanding, as the order clerk remains in on the conversation until it is completed.

The lines between the order turret



Fig. 1—A view of the Number Two order turret in the John Wanamaker store, New York, during a period of light load

and the central office may also be used for outgoing service so that the clerk may solicit orders or call back patrons on deferred calls.

One of the largest installations of No. 2 order turrets is in the John Wanamaker store in New York City.

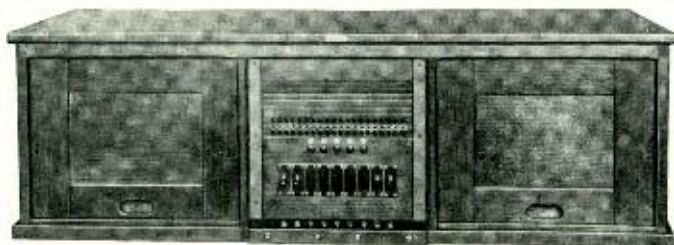

Fig. 2—Plugs and cords are not shown in this view of the order turret but their place beneath the keys is easily visible

Here a total of 105 central-office trunks are connected to eighteen turrets. Forty of the trunks are connected directly to the No. 2 order turret and have a separate listing in the directory, while the other sixty-five trunks are multiples of the regular PBX trunks. These two groups of trunks are divided between the eighteen turrets in such a manner that each order clerk or "Personal Service Representative" has access to a portion of each group. Much of the time twenty order clerks can take care of the installation, but at times of peak load the entire seventy-two positions may be occupied.

The location of the jacks, lamps, keys, and cords in the middle of the turret is very convenient, since it leaves the rest of the face of the turret and the top of the table free for use of the clerks in writing up orders

and in posting general information.

The equipment for the cord circuits and for ten trunks is located in one end of the order turret section, and the connecting blocks for forty multiple jacks and lamps and for the relay equipment, in the other end of the section. The normal operating load for one order clerk is between one and one half and two lines, which limits the number of relays required so that it is not necessary to mount any equipment outside the section except the dial and the jack into which the attendant plugs her tele-

phone. These are shipped separately from the turret and are installed on the job. When more than one turret is employed, multiples of the line lamps and jacks are connected in the various turrets as required.

Provision is made so that when two groups of trunks are provided from the central office, one terminated in the PBX and the other in the order turret, the PBX trunks may be multiplied at the order turret, and the order turret trunks, at the PBX. This gives maximum flexibility between the two systems, for handling misrouted calls and for night service.

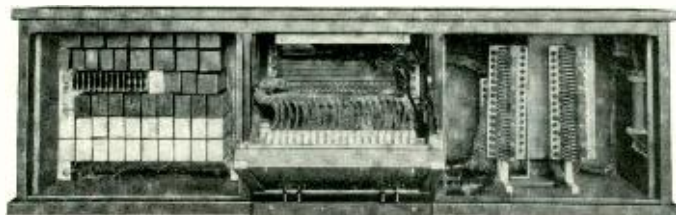

Fig. 3—With front panels removed the necessary circuit apparatus is seen in one of the side compartments and the terminal strips in the other

The same circuit arrangement is used in either case, as it is only necessary to place lamps in the lamp sockets at the positions at which the trunks are to be answered.

The No. 2 order turret is not limited to department store work since it provides means for handling large volumes of all types of inward and outward terminating traffic. Telegraph companies have been employing it for some time in receiving and delivering telegrams by telephone. Special provision is made when a subscriber has several telephones in addition to the order turret and a special PBX is not justified. Then a group of five station-line circuits, terminating in plugs, appears on one

side of the central part of the turret together with the associated keys and lamps. These station lines may be connected to any trunk for either inward or outward connections, so that the turret may give service as a small PBX, but without intercommunication between these lines. They are arranged for through dialing in case the turret is in an area served by a dial office.

This order turret is found useful also for many other types of business where it is readily possible to separate the special-service traffic from that of the regular PBX or where a number of clerks are required to handle large volumes of inward and outward calls.



Saving Lead in Toll Office Cables

By A. KENNER

Systems Development Department

IN the early days of the telephone, wiring inside central offices was similar for toll and for local circuits. As toll lines increased in length it became more and more important to keep transmission losses at a minimum. At that time there were no telephone repeaters and therefore it was desirable for transmission reasons to use conductors as large as 16 gauge with double silk and double cotton insulation. Losses could also be reduced by increasing the insulation resistance of the central office wiring; an improvement in this regard would lessen cross-talk between circuits. Moisture is a foe to insulation resistance; to keep it from the textile coverings of the individual wires, they were enclosed in a solid

lead sheath. The core was baked before the sheath was applied, and when the cable left the factory its insulation resistance was very high.

This type of cable, however, had serious disadvantages. Its weight required that the cable racks be very strongly made. To avoid kinking the cable, it must be bent to a large radius. This wasted building space by adding to the distance between frames and between the cable racks and the top of the frames. Installation was quite difficult as the stiff, heavy cables were hard to bend, strip and wax.

As lead sheathing is expensive, it was good practice to put as many wires as possible in a single sheath; this condition and others required that a large number of sizes be avail-

able in order to have a suitable one for every group of equipment. About fifty-three sizes of lead covered cables have been used for toll equipment,

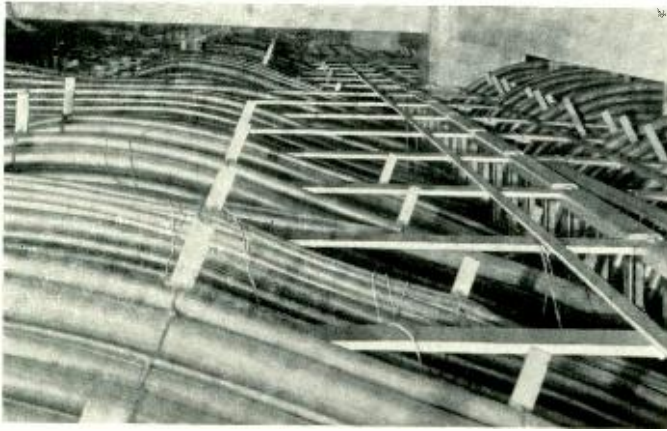

Cables passing over the tops of frames at Toledo

ranging from 10 pairs to 154 quads, part of them being 16-gauge cables and part 19-gauge cables. It can readily be seen that carrying such a large group of cables was undesirable from merchandising, engineering and installing standpoints.

In the last few years, the trend of development in equipment engineering has been toward a more compact grouping of circuit elements, so that the overall length of the main cable runs has been substantially reduced. Although lead sheath has advantages on long inside cables, it is now felt that on the short runs of the modern offices these advantages have largely disappeared. For instance, cables between the testboard and the protector frame usu-

ally do not now exceed twenty-five feet. If these are large lead-covered cables, their ends are stripped and formed out over a space four or five feet long. This meant that although lead sheath was furnished, a considerable portion of the wire was not covered by the lead when the cable was finally installed.

Cables insulated with silk and cotton and protected further by lead tape and painted cotton braid had proved satisfactory for many years in local central offices. Although the requirements in toll offices are more exacting, it seemed that under the new conditions they could be met by braid-covered cables. A trial installation was made in the new toll office at Lansing, Michigan, under the supervision of engineers from the Laboratories and the American Telephone and Telegraph Company. As a result of the trial further improvements in the

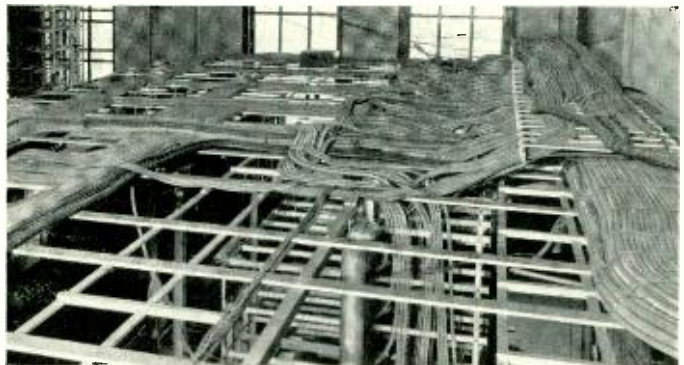

Switchboard cables at Lansing; this view shows how the smaller and more flexible cables may cross each other in several planes

insulation, the balance of the quads and the makeup of the cables have been made and special tests conducted at subsequent installations. While further improvement is being undertaken the new braid-covered cables have been made with electrical characteristics superior to those of lead-covered cables and their use in toll offices is now general.

Instead of fifty-three sizes of lead-covered cable, seven sizes of switchboard cable have been developed, which contain respectively two, four, eight, ten, twelve, sixteen and twenty quads each. It has been possible to use these cables in combination to take care of any condition. They are made up of 19-gauge wire, double-silk and double-cotton covered. Three types of quads are used, each type having a different length of twist of both pairs and quads, following the previous practice on lead-covered cables. The cables have standard pair colors which makes it easy to identify pairs and quads; the colors are arranged in consecutive pair count which is quite advantageous where the cables are used on non-quadded circuits. The cable core is wrapped with paper tape and lead tape and covered with a painted cotton braid similar to that of other switchboard cables.

Savings which follow the use of this style of cabling in future offices are not to be confined to the building space formerly occupied in cable-turning. Installation costs are less;

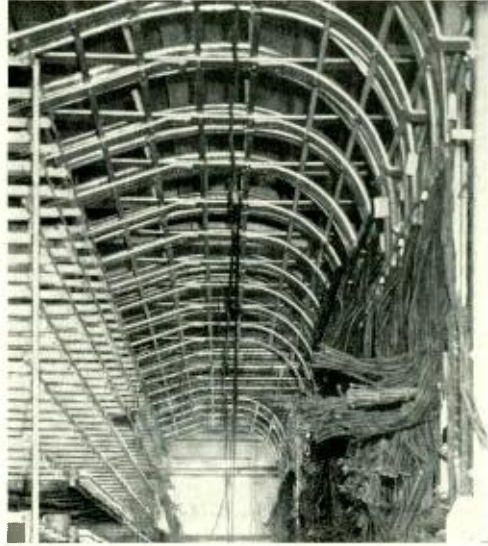

Lead-sheathed cables at Toledo between the toll board and the intermediate frame. This view, taken during installation, shows the heavy supporting structure

shorter cable runs are used; stocks of seven sizes of cable are more easily and economically maintained than of fifty-three sizes; and two million pounds of lead sheathing a year will be saved.



Direct Scanning in Television

By FRANK GRAY

Research Department

LAST July the study of certain optical conditions peculiar to television, concomitant with improvement in the sensitivity of photoelectric cells, culminated in a demonstration of the television of scenes illuminated by sunlight. In the apparatus then used the method of "direct scanning", in which an image of the object to be televised is formed by a lens on the scanning device, replaced the earlier method of "beam scanning".

The utility of any scanning method depends importantly upon the amount of light it provides to the photoelectric cell; careful scrutiny from this standpoint must precede its adoption. Beam scanning concentrates intense illumination on successive elements of an object viewed in its entirety by a photoelectric cell. In direct scanning the entire object is continuously illuminated and its successive elements are viewed by the cell. If it were possible for the two systems to be built with equal light-collecting power, it is apparent that equivalent amounts of light from any one element would reach the cells only if the wide illumination were as intense at every point as the beam at the scanned element. But the light-collecting power of any ordinary beam-scanning system is far greater than that attainable in direct scanning, for in the former several photoelectric cells with elements of large area are entirely exposed to the light. In order that two practical

systems may admit equivalent amounts of light, therefore, the broad illumination must be many times greater in intensity than the beam. The expense and clumsiness of flood-lighting with the brilliance required by the early cells, and its discomfort to televised persons, dictated beam scanning for the Laboratories' earlier television systems.

Other features of beam scanning, however, are less favorable. Particularly is it unsuitable for the television of remote objects. The scanning beam can be thrown a considerable distance, but enough of the light reflected from the object reaches the cells only if they are near the object. About three feet is the maximum working distance ordinarily practicable.

Such disadvantages turned attention toward increasing the light collection of direct scanning systems and decreasing the light requirement of photoelectric cells to a feasible meeting point. With increase in the number of scanning holes used, the difficulty of accomplishing this mounts rapidly, for the amount of light required is proportional to the number of elements into which the image is divided—to the square of the number of holes. When, as last July, fifty holes are used, the problem is by no means simple.

There are properties peculiar to the optical system of lens and scanning disc which make possible an in-

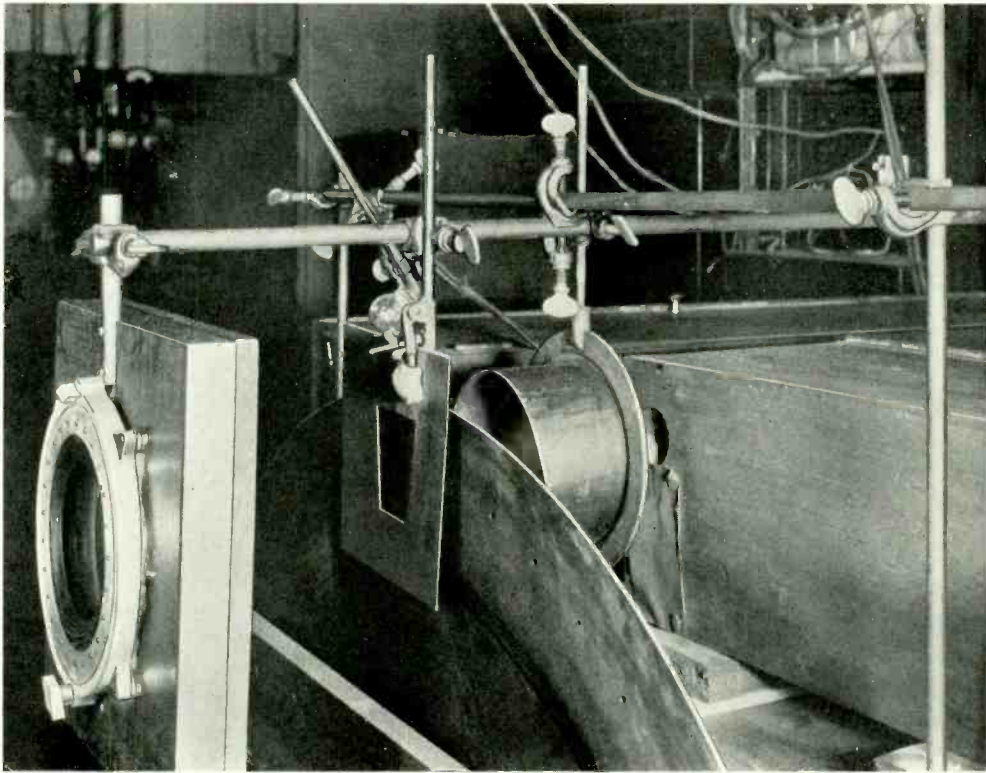

Optical system for direct scanning, used for outdoor television

crease in its light-gathering power by increasing all its physical dimensions. These properties inhere fundamentally in the division of the scanned image, by the holes in the scanning disc, into a finite number of elements for transmission.

The amount of light admitted by a scanning hole to a photoelectric cell is proportional to the area of the hole times the illumination over it. Increasing the area of the hole is obviously impossible without increasing the area of the scanning disc, and fruitless without increasing the area of the scanned image. The latter can be done by using a lens of greater focal length and placing the lens at the new focal distance from the disc. If the area of the new lens is the same as before, it spreads the same

amount of light as before over the now larger area of the image. To avoid offsetting, by the decrease in illumination over it, the effects of increasing the scanning-hole area, the new lens also must be of greater area. Thus, to improve the system's light-gathering power proportionately to an increase in the area of the scanning holes, every dimension of the scanning apparatus is augmented.

The effectiveness of the enlarged system can be further magnified by a still greater increase in the area of the lens, and a consequently ampler collection of light. For "illumination", in the formula for light-gathering, there can accordingly be substituted the ratio of the diameter of the lens to its focal length—the "aperture". In short, the light given the cell by the

system is proportional to the product of the hole-area and the lens aperture; improvements in light-collection can be had by increasing either or both.

For each factor practical considerations limit increase. Photographic lenses of aperture greater than that equivalent to an F-number* of 2 fail to provide adequate definition over the size of field ordinarily televised, and discs larger than ten feet in diameter are unhandy to house and liable to centrifugal breakage. But these limits need not ordinarily be approached. Operating in ordinary sunlight, and aided by the new photoelectric cell, a lens of F-number 2.5 and a three-foot disc suffice.

Complicating the application of the simple expression for light-gathering is the fact that the area of adequate definition of an image formed by a lens varies approximately with the reciprocal of the lens aperture. In any attempt to refine the grain of the reproduced picture by increasing the number of elements into which the image is divided, this new consideration adds optical difficulties to the already aggravated transmission problems. Using more numerous holes of the same size as before requires a larger disc and a larger image. Providing this image with the same illumination requires a lens with the same aperture and with larger dia-

* *The F-number of a lens is the ratio of its focal length to its diameter.*

meter and focal length. But if this aperture was just sufficient in definition for the previous grain, it will be inadequate for the finer. To suit the lens in this respect, a smaller aperture must be used, and thus the whole apparatus must be further increased in size to retain its light-gathering power. In this way, doubling the number of picture elements would require very nearly trebling the diameter of the disc.

A fortunate feature of psychological optics makes it unnecessary to refine the grain of a picture of a full-length figure or a group beyond what is required for a close-up picture of a face. The same number of elements will serve for both, if both are of the same size. As in ordinary vision, the observer expects less detail in a distant than in a nearby scene. The criterion of resolving power is independent of the kind of objects seen; it depends exclusively on the extent of division of the field.

Direct scanning and beam scanning appear at present, therefore, to be mutually supplementary rather than competitive systems. Constructed with regard to the principles discussed, a direct-scanning system is eminently suited to the television of relatively distant outdoor scenes broadly illuminated by good sunlight. Indoors, however, where artificial broad illumination equivalent to sunlight is uncomfortable and difficult to secure, beam scanning still remains superior.

To
Frank Baldwin Jewett

WAS PRESENTED THE
EDISON MEDAL
AT THE MIDWINTER CONVENTION OF THE
AMERICAN INSTITUTE OF ELECTRICAL
ENGINEERS



Program of the Meeting

PRESIDING: H. A. KIDDER
Vice-President of the Institute

ORIGIN OF THE EDISON MEDAL: JOHN W. LIEB
Edison Medallist and Past President of the Institute

ADDRESS: JOHN J. CARTY
Edison Medallist and Past President of the Institute

PRESENTATION: OLIN J. FERGUSON
Senior Vice-President of the Institute

RESPONSE: DR. JEWETT

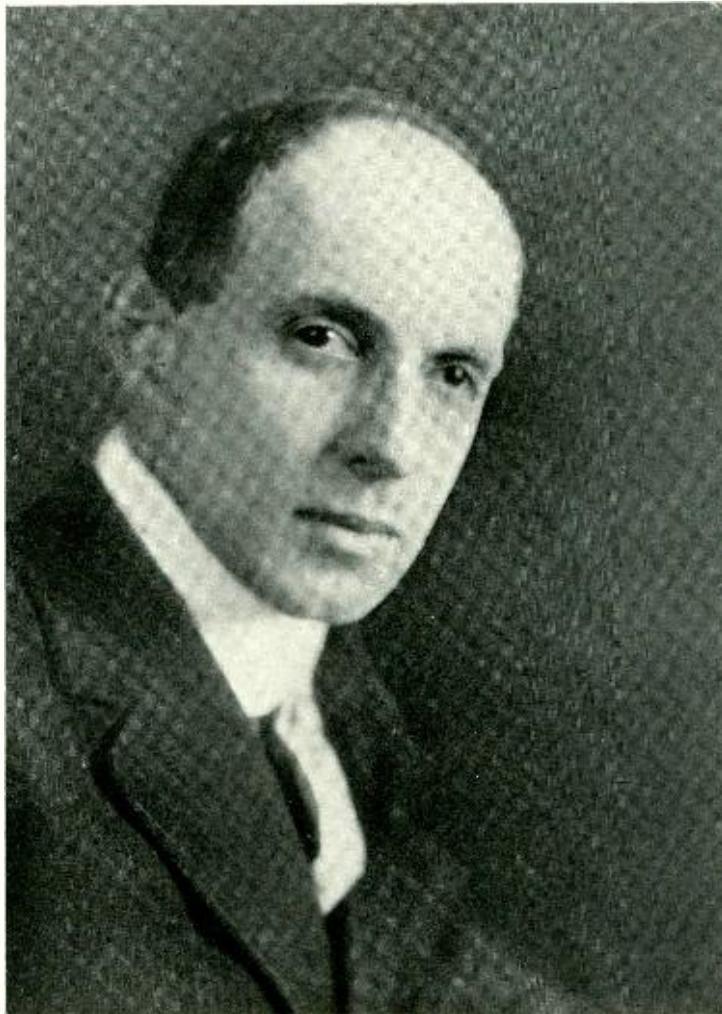

Frank Baldwin Jewett

THE history of the development of telephony is one of cooperative effort with scarcely a parallel in the domain of applied science. In no other field of modern industry has the fruitage of pure science through cooperative effort been greater. Nowhere else is the industrial research organization more potent, more firmly incorporated into the business structure or more relied upon as a weapon for attack on problems yet unsolved.

Such a development in relatively so short a space of time is of course far beyond the capacity of any man or any small group of men to achieve. It is an evolutionary thing compounded of foresight, leadership and the consistent cooperation of many men through many years.

As one who has been a part of the unfolding pageant of telephony for the past twenty-five years, I am not unmindful of the influence others have had in whatever I have accomplished. In accepting this Medal, the highest and most cherished honor which American electrical engineers have it in their power to bestow, I do so therefore with a deep feeling that in large measure I am accepting your appreciation for the work of all the numerous men who have been my intimate associates. On their behalf, as well as my own, I thank you for so signal a recognition of our endeavors.—*From Dr. Jewett's Response.*

A Medal, A Man and An Idea

THIS week's action of the American Institute of Electrical Engineers in bestowing the high scientific honor of its Edison Medal on our fellow New Yorker, Dr. Frank Baldwin Jewett, redresses in some degree a balance of the personal credit which has never been quite true. Outstanding personages sometimes come to be symbols, historians observe, for their organizations; Napoleon is remembered, his generals are forgotten. Dr. Jewett's history has been precisely the reverse. In scientific circles he and his work have long been known, admired and honored—the last chiefly by that sincerest of all honors, selection to do jobs personally profitless but which need doing in the public interest. For the New York public, however, Dr. Jewett's personality has been shadowed, doubtless entirely to his satisfaction, by the growing reputation of an institution largely his creation, Bell Telephone Laboratories.

Dr. Jewett's chief contributions to science have been an idea and the skill to make that idea work. The idea is that of co-operative research. No one scientific man can know everything or possess all kinds of skill. Hence Dr. Jewett's idea of assembling groups of experts to work on complex scientific needs. Able scientists are not often well broken to harness. Teams of them are none too easy to drive or even to lead. Yet Dr. Jewett has managed this well, perhaps better than anyone else; as the success of the telephone laboratories testifies.

The idea, admittedly, is still on trial. It is too new to be anything else. That co-operative research will banish the individual inventor from technology is unlikely, especially if that inventor happens to be a genius. A century or two from now Dr. Jewett's idea is likely to disclose itself more as an entirely new tool for civilization's work-bench than as a substitute for anything else. Meanwhile, one answer to the charge that organization necessarily stifles initiative is the record of the co-operative groups whom Dr. Jewett directs in making two recent discoveries of the very highest originality; the magnetic metal called permalloy and proof of the wave nature of electrons, the latter beyond much doubt the foremost scientific event of the last five years.

—*Editorial in New York Herald-Tribune, February 2, 1929.*

Transmission Testing of Central-Office Circuits

By H. T. DOUGLASS
Systems Development Department

IN traversing the succession of circuits linking transmitter to receiver, the voice-frequency currents involved in a telephone conversation suffer attenuation along the way. This loss of energy must be kept within close limits to insure production of an adequate volume of sound.* Accordingly the wire used in inter-office trunks and in lines running to subscribers' telephones is sufficiently large to insure transmission of these currents without excessive loss. The currents must also be protected at the central offices, in the cord circuits and in other circuits through which they pass. Loss of energy in the wiring of these central-office circuits is ordinarily a minor factor since the length of the wire is relatively small, but loss in the relays and other pieces of circuit apparatus must be considered. The impedance of apparatus connected in series with the transmission path is, therefore, kept as low, and that of apparatus bridged across the path as high, as is economically possible commensurate with the requirements for signalling, supervision and other circuit functions.

Precautions have long been taken to protect the transmission characteristic of the central-office circuits. Apparatus to be bridged across a talking circuit is tested during manufacture to insure that the inductance is

sufficiently high. Inductively wound apparatus to be connected in series with the transmission path is usually shunted by a non-inductive resistance or a condenser to provide a low-impedance path for the voice currents. In the design of any circuit the loss which will be caused by the proposed apparatus combination is measured or computed, and if found to be disproportionately high the circuit must be redesigned to bring the loss within suitable limits. Circuits are given an operating test after installation, but this test although revealing de-

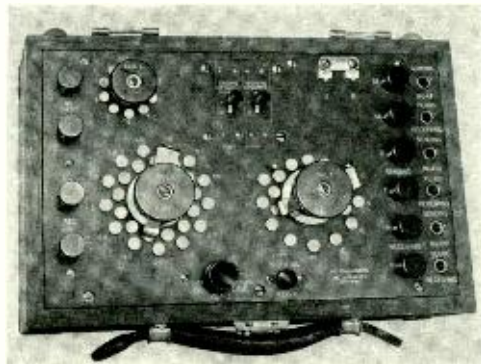

1-C measuring set, of acoustic balance type

fects in operating characteristics does not necessarily reveal those which might result in excessive attenuation of the voice currents.

Early in 1926 a new safeguard was introduced, that of making transmission acceptance tests of central-office circuits immediately after installation. These tests derive their

*For an explanation of the unit of attenuation see "TU Becomes Decibel" by R. V. L. Hartley in the RECORD for December, 1928—p. 137.

name from the fact that a new installation is not formally delivered to the Telephone Company by Western Electric until the overall transmission losses of all the circuits over which the voice currents must pass

1000-cycle oscillator, and an "adapter" unit is used to hold the circuit under test in its talking position while the measurements are being made. Two types of transmission measuring sets are in general use at present, one indicating the measurements through a balance of tones and the other by a galvanometer. In the use of each, 1000-cycle current is impressed on the central-office circuit to be tested and on a variable network whose attenuation is known at all times. The network is adjusted until the current passing through it is attenuated to a known extent and is equal to the current reaching the far end of the circuit; the transmission loss is then read on the dials of the network.

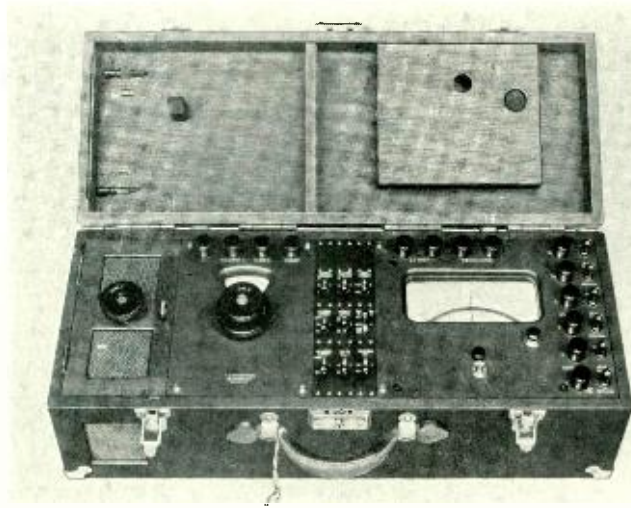

A meter-indicating set, type 3-B

come within specified limits. In preparation for the new practice, each central-office circuit having as its function the transmission of voice-frequency currents was analyzed and the permissible loss was decided upon. Transmission loss limits for the circuits, together with simplified sketches of the transmission paths and of the apparatus involved, are provided in a "Transmission Requirement Specification" sent out to Western Electric field forces. In the program undertaken, each circuit drawing will eventually furnish information by means of which the maximum allowable transmission losses for the circuit can be determined.

Field acceptance tests are made by means of a transmission measuring set. Testing current is supplied by a

set giving measurement by acoustic balance, shown schematically in Figure 1, is used on smaller installations and also at all magneto switchboards. A definite alternating potential is impressed on the input side of the circuit under test, and on the vari-

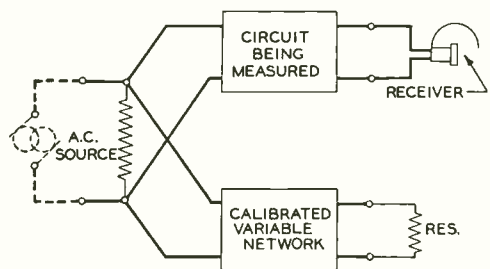

Fig. 1—Acoustic balance type of transmission measuring circuit

able network of the measuring set. For observing the state of balance, a telephone receiver is connected to a key in the measuring set whereby it may be connected alternately to the two branches. That the output load

sities, the meter-indicating type of measuring set is used on all larger installations in common-battery offices. This set is capable of measuring transmission losses of 0 to 40 decibels, with an accuracy of ± 0.1 decibel. The operations involved in its use are considered as divided into calibration and measurement.

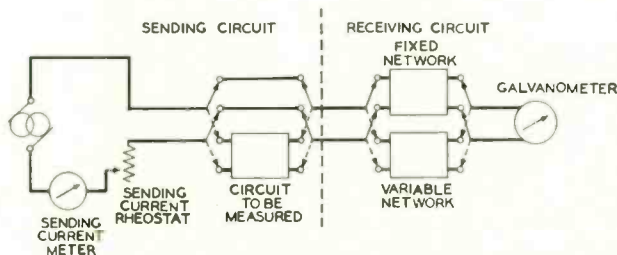
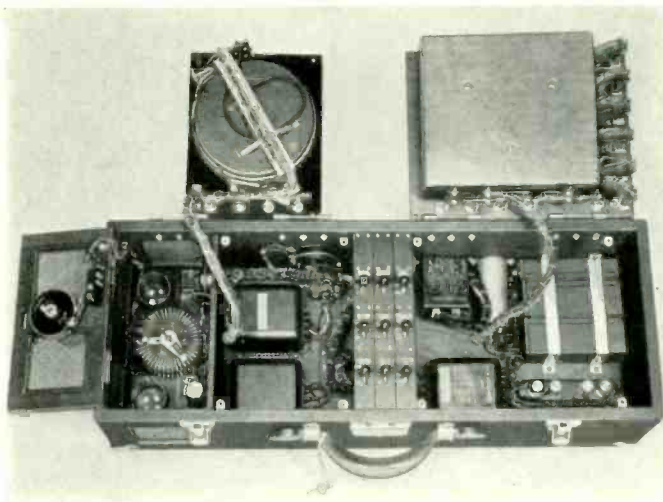

Fig. 2—Meter-indicating type of transmission measuring circuit

may be kept constant, a resistance equivalent to the receiver impedance is connected to each branch in turn, while tone from the other is observed. To make the measurement, dials of the variable network are adjusted until the volume of tone produced by the receiver is the same when coming from the circuit under test as when from the network. Then the loss in the circuit under measurement is equal to that of the variable network, and is indicated directly in decibels on the dials of the measuring set. Transmission losses from 0 to 46 decibels may be measured by sets of this type with an accuracy of ± 0.5 decibels.

To afford more accurate measurements and to eliminate the uncertainties brought by the human element involved in comparisons of sound inten-

sities, the meter-indicating type of measuring set is used on all larger installations in common-battery offices. This set is capable of measuring transmission losses of 0 to 40 decibels, with an accuracy of ± 0.1 decibel. The operations involved in its use are considered as divided into calibration and measurement. The first of these operations, as the name suggests, determines a galvanometer reading which will later serve as a criterion of balance. Alternating current is supplied to the set by a 1000-cycle oscillator, and the energy input is held constant by an adjustable rheostat. Part of the energy flows through a fixed network whose transmission loss is known, and the resultant current at the output end is given by the galvanometer. In the second group of operations the circuit to be tested, connected in series with the variable network of the set, is substituted for the fixed network. Then the variable network is adjusted until the



Interior of 3-B measuring set

galvanometer reading is the same as during calibration, and the transmission loss of the circuit under test is read directly from the graduated dial whereby the network was adjusted.

Transmission acceptance tests are made by a special team of installers between completion of the operation tests and the time the apparatus is turned over to the Telephone Company. In all cases as much as possible of the circuit wiring is included. A test of an interoffice trunk, for instance, takes in not only all the relays and other pieces of apparatus, but as much of the wiring as can be included; wires from the measuring set are connected to the circuit at the main distributing frame, and the plug of the trunk cord is inserted directly into a jack of the set. An allowance is made for the loss in the wiring between frame and measuring set.

When the loss caused by the circuit is found to be within the specified limit, the circuit is considered satisfactory for delivery to the Telephone Company. If, however, the loss is found to be excessive and a check does not disclose, for instance, incorrect or faulty wiring or defective contacts, each individual piece of appa-

ratus is measured to locate the fault. The non-inductive shunt across a relay winding may be open, there may be short-circuited turns in a piece of inductive apparatus bridged across the circuit, or low capacity may be found in a condenser in series with the line.

During the first nine months in which telephone circuits came under this new form of scrutiny, troubles which had not been picked up in the regular operating tests were found on one per cent of the circuits tested. Certain of these defects would probably have been located by a testman later. Others, not affecting the operating characteristics of circuits, might have continued. Although the losses introduced by these might be negligible for any individual circuit, their effect would be cumulative and under certain conditions of connecting circuits together, the transmission might be appreciably impaired.

The new testing program, assuring standard transmission on all circuits from the outset, is a logical complement to the operating tests and another evidence of the determination to take every step economically possible toward better telephone service.



Small Power Plants for Telephone Repeaters

By J. L. LAREW
Systems Development Department

FOR the plate and filament circuits of vacuum tubes there must be local sources of direct current at suitable voltage and free from noise-producing components. Power plants for supplying extensive vacuum-tube loads have been in existence at the larger offices for years; they use the existing 24-volt battery for filaments and a 130-volt storage battery for plate circuits. With the introduction of the type D-1 carrier system, however, provision for a suitable power supply became imperative in offices of the magneto type where no office battery is used. Likewise in small common-battery offices, where a few two-wire telephone repeaters or D-1 carrier equipments might be applied, a source of plate supply would not be available, since the battery of the local office would not have a potential as high as necessary. The current-drain requirements for filament and plate supply, however, are exceptionally small in such installations.

In the past, motor-generators charging open-type storage cells have often been installed for small loads. Acid fumes liberated by the open-type cell during its charging period were confined either to a room in which the equipment had been especially protected against corrosion, or to a battery cabinet properly ventilated to the outside atmosphere. Recent progress, however, has provided means for avoiding the use of motor-generators

and open-type storage cells. Suitable rectifying devices and enclosed-type storage cells have been designed and, due to the large demand, produced at exceptionally low prices. This made it advisable to use the Tungar type of rectifier and the enclosed glass-jar storage cell in small power plants.

Being relatively small, the cells are grouped in units which are convenient for handling. Each cell is equipped with a vent cap which prevents the liberation of electrolyte during charge. Such features have made it possible to mount the cells on a standard relay-rack framework without requiring that the iron work be protected against acid corrosion. Considerable economies in power-plant design have, therefore, been effected, as isolation of the batteries from the charging equipment is no longer required. This makes it possible to arrange a complete power-plant unit on a standard seven-foot relay rack, which may be located at the most convenient point in the office with respect to the load, and thereby insures an economical arrangement of the wiring between the power plant and the load. Additional economies in the wiring have been effected by locating the distributing fuse and lamp panels on the power bays.

There was an urgent, immediate need for such small power plants. To avoid the delay incident to the development and test of automatic-control apparatus, it was decided to

produce plants controlled by hand. One of these delivers two amperes at twenty-four volts for filament circuits and the other, 130 milliamperes at 130 volts for plate circuits. As these are designed for exceptionally small currents, the number of circuits supplied by each is relatively small, so that fuse and lamp mountings may be grouped with the power plants. This

mounting the equipment to be supplied on adjacent relay-rack bays, cabling between the two becomes a simple matter, avoiding the necessity of cable racks and longer cabling between the power plants, fuses, and load.

The 2-ampere 24-volt power plant employs a single 11-cell battery, floated by means of a Tungar rectifier, and is mounted on one bay of standard nineteen-inch relay rack. The batteries are set on shelves in the lower portion of the rack, while the rectifier with its associated control equipment, distributing fuses, and alarm annunciator equipment is located above. The load on the plant, being vacuum-tube filaments, is so nearly constant that after setting the rectifier to deliver a suitable value of current, the battery will be maintained at a state-of-charge well within its working limits without further attention. Therefore the additional expense of voltage-control equipment is not justified for this plant.

The 130-milliampere, 130-volt plant also requires one bay of standard floor-supported relay rack. It employs two 66-cell batteries; a high-voltage Tungar rectifier is the charging source. One battery is charged while the other is being discharged by carrying the load. The transfer of the batteries

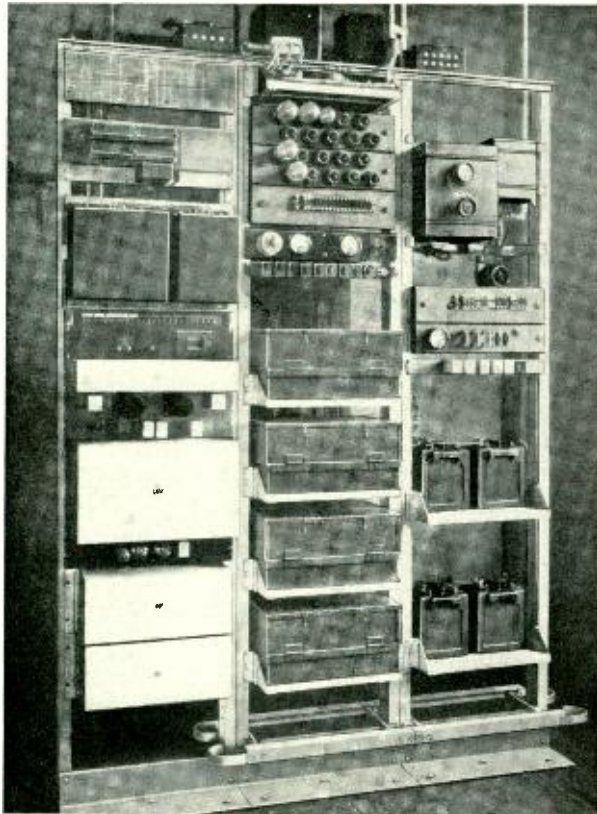

Fig. 1—A type D-1 carrier terminal (left) and its power supply; center, the 130-volt plate batteries, charged by the rectifiers on the top of the panel; right, the 24-volt filament batteries, charged by their own rectifier

is more economical than having a fuse board separate from both the power plant and the load, which is the method universally used when a large number of fuses are required. By

from charge to discharge or vice versa is made manually and, because of the manual control, these power plants cannot be left unattended for any great length of time.

The small glass-jar type of storage cell used in this plant is equipped with charge-indicator balls. Usually three such balls, free to move in the electrolyte, are provided in the pilot

and at the bottom when completely discharged. Such an arrangement obviates the necessity of frequently using the common syringe hydrometer. On the front and rear sides of the battery are inspection doors to permit examining the charge-indicator balls and electrolyte level without removing the box covers.

The immediate demand for power plants of this sort being satisfied, development work was started to devise means for controlling small plate-power plants automatically, in order to reduce the attendance and

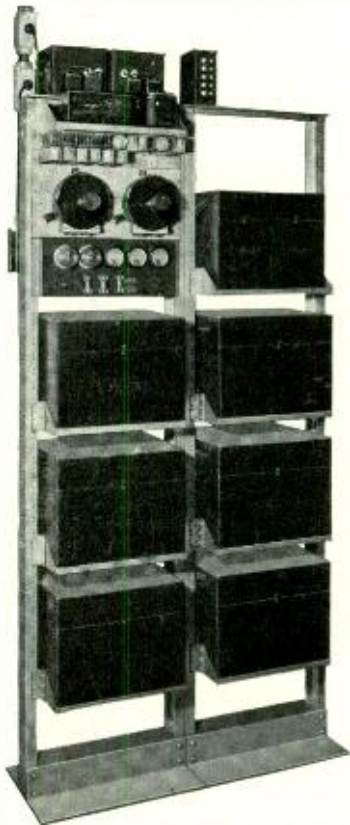

Fig. 2—Two racks are required for the larger battery of the 800-milliamperere power plant, which is also automatically operated

cell. The most common colors are green, white, and red. The balls are not attacked by the electrolyte, and the specific gravity of each is so selected that a different colored ball will rise or sink as the specific gravity of the electrolyte changes due to a charge or discharge of the cell. All three balls will be at the top of their path when the cell is fully charged

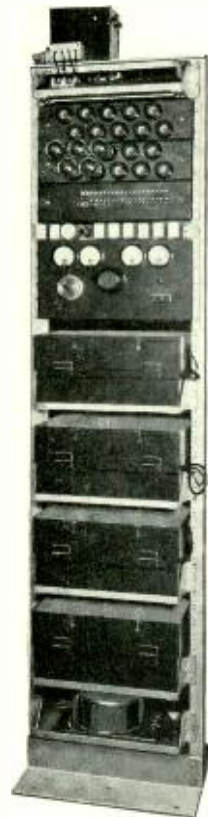

Fig. 3—The 200-milliamperere, 130-volt plant. At the top is the Tungar rectifier; next come the resistance lamps and fuses. The relays are for automatic charging and voltage control. In the four lower boxes are the storage cells

maintenance incident to manual operation. As a result the 800- and 200-milliamper 130-volt power plants, shown in Figures 2 and 3, have been completed. These are arranged to control their output voltage between the limits of 125 and 135 volts automatically. Two batteries in parallel are continuously floated across one or two Tungar rectifiers. A coil connected between the ungrounded ends of the two batteries forms the reactance element of a simple filter, of which the batteries form the resistance elements. This filter effectively prevents alternating currents from reaching the load circuits. Two bays of floor-supported relay rack are re-

quired for the 800-milliamper 130-volt power plant, while only one is required for the 200-milliamper plant, because of the difference in space required by their batteries.

As is the case in the smaller 130-volt power plant, the batteries are housed in boxes, and have the necessary charging, control and other equipment mounted on the upper portion of the power-plant unit. Since these plate power plants are arranged for automatically controlling the output voltage and properly floating the batteries, their introduction can be considered as a step towards the realization of future unattended power plants.



New Space for the Laboratories

The Laboratories has acquired approximately 40,000 square feet of additional floor space in the new twelve-story "Maltz Building" on the southwest corner of Hudson and Canal Streets, New York City, facing the plaza associated with the Holland Vehicular Tunnel. This space, the entire 10th and 11th floors of the premises, has been leased for five years beginning May 1, 1929. The 10th floor will be occupied by the Outside Plant Development Department, which now occupies the 2nd and 3rd floors of Sections J and K. The space vacated by that department will be utilized by the Systems Development Department for additional laboratory facilities. The 11th floor will be occupied by members of the group working under the direction of O. E. Buckley, and by other groups in the Research Department. Plant adaptations have already been begun, and the space will probably be completely occupied early in May.

Level-Hunting Connectors

By F. A. KORN

Systems Development Department

IN the step-by-step dial telephone system, connectors are the switching mechanisms that make the final connection to the line called. To connect a private branch exchange, with more than one line from the central office, a "hunting" connector, rather than the regular non-hunting one, is required so that a selection may be made of the first line in the group that is not in use. Hunting connectors used heretofore have, in general, been able to select from only ten lines. When more than this number are required, the lines are divided into sub-groups of not more than ten each, each sub-group reached by only part of the connectors. The disadvantages of this method are comparatively unimportant when the size of the group is not greatly in excess of ten, and the method will continue in use for certain cases. For large PBX line groups, however, an arrangement becomes desirable for hunting over all the lines in the group with a single switch. The recent development of the level-hunting connector, which can hunt over as many as one hundred lines, provides such an arrangement.

An ordinary connector has access to one hundred lines, the terminals of which are grouped in ten layers or levels, each having ten lines arranged around a section of circular arc. Such a group of one hundred pairs of terminals is known as a "bank."

Every subscriber's line has, in addition to the two employed for talking, a third wire known as the "sleeve" lead, which is used for control purposes. These leads are also wired to a bank called a "sleeve" bank mounted just above the line bank. A vertical rod, on which are arranged copper brushes or "wipers" for making connections to these terminals, is mounted in front of the banks of terminals. This rod with its associated wipers may be moved by means of suitable ratchet and pawl arrangements, first vertically to any desired level and then horizontally to any terminal in that level. The upward motion of the rod is from one level to the next above and the horizontal motion, from one terminal to the adjacent one, for each operation of the "vertical" or "rotary" magnet. The wipers thus move up and around step-by-step in a fashion typical of this system of dial operation.

In engineering step-by-step central offices, lines to private branch exchanges, commonly termed "PBX trunks", are segregated into certain hundreds groups which terminate on hunting connectors. This practice is followed because the more expensive hunting connectors are required only for the PBX trunks while regular connectors will serve for individual lines. These latter lines, however, may be assigned to trunks in the PBX hundreds groups. Trunks to private

branch exchanges are assigned numbers in a definite sequence and the number of only the first trunk appears in the directory. A PBX subscriber, for example, may require eight

of the group consecutively until an idle one is found. If all trunks of the group are busy the calling subscriber will receive the busy signal.

In a dial telephone system means must likewise be provided for completing calls to a private branch exchange by any of its associated central-office trunks even though the first trunk only is listed in the directory. Furthermore, the equipment in a dial system must recognize the trunks of a PBX group so that if the first trunk dialed tests busy, other trunks to the PBX will be tested until an idle one is found. The switching equipment must be arranged also to stop testing at the last trunk of the group and to give a line-busy indication to the calling subscriber if all trunks are busy. These requirements must be met for any type of hunting connector.

The level-hunting connector differs from the rotary hunting connector in being able to hunt over all ten levels, if necessary, instead of a single one. To accomplish this two additional pieces of equipment are required. One is a commutator and vertical wiper, evident in the accompanying photograph. The vertical wiper is fastened to the rod controlling the wipers used with the bank terminals. The commutator contains eleven segments, ten corresponding to the individual levels of the connector banks and one used as a resting place for the vertical wiper when the shaft is normal. It is attached to the lower cover plate of the switch and its terminals are wired to the terminals of one arc of the ten-point "register" switch, the other additional piece of equipment. This register switch, with two arcs each of ten terminals, over which wipers rotate, is used to direct the connector to the proper level and to

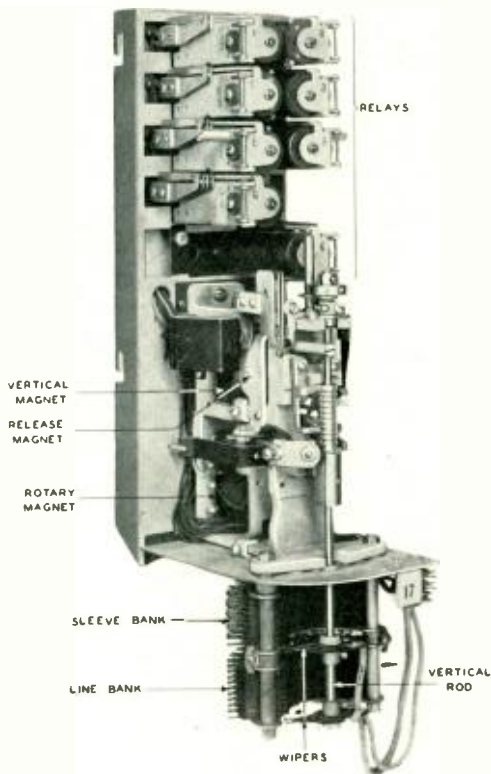

Fig. 1—On this photograph of a regular connector we indicated the essential operating elements

to a central office, numbered consecutively from 1032 to 1039. The telephone directory, however, lists only 1032.

In manual telephone practice the multiple jacks of these trunks are indicated by a distinctive painted marking so as to be recognized by the operator. When a call is received for the first trunk of such a PBX group the operator tests the jack associated with that trunk and, if it is busy, will test jacks associated with other trunks

ntrol the release of the switch during the level-hunting process. It is designed to mount horizontally below the relay equipment on the switch mounting plate.

Assume, for example, that a subscriber, with a listed number of 1231, had an assignment of forty-five trunks. This listed number would correspond to the lowest connector terminal and the assigned trunks would use the entire third, fourth, fifth, and sixth levels of the connectors of the group. The other five assigned trunks would be associated with the first five terminals of the seventh level, but the remaining terminals of this level would be retained for growth and not assigned to other subscribers. The dialing of digits "1" and "2" by a calling subscriber will cause the step-by-step equipment to select an idle trunk to a level-hunting connector which has access to the PBX group desired. In the operation of the level-hunting connector, only the tens digit of the listed directory number—the number "3" in this case—is effective. The units digit, however, is retained for uniformity of numbering and records.

When the dial restores to normal on the completion of dialing the digit "3", the register switch responds by taking three steps and stopping on the third terminal. Through electrical connections between the register switch and the commutator, a distinctive indication, consisting of a ground, is placed on the commutator segment to determine over which level the switch shall first hunt for an idle trunk. This cross-connection scheme provides means for employing different level-hunting switches to hunt over various connector bank levels in any desired and predetermined order,

thereby reducing the average hunting time and switch wear. If these cross connections are in regular order, the third terminal of one arc of the register switch being connected to the third commutator segment, the fourth terminal to the fourth commutator segment, and so on, the connector will, at the completion of the dialing of the digit "3", step first vertically

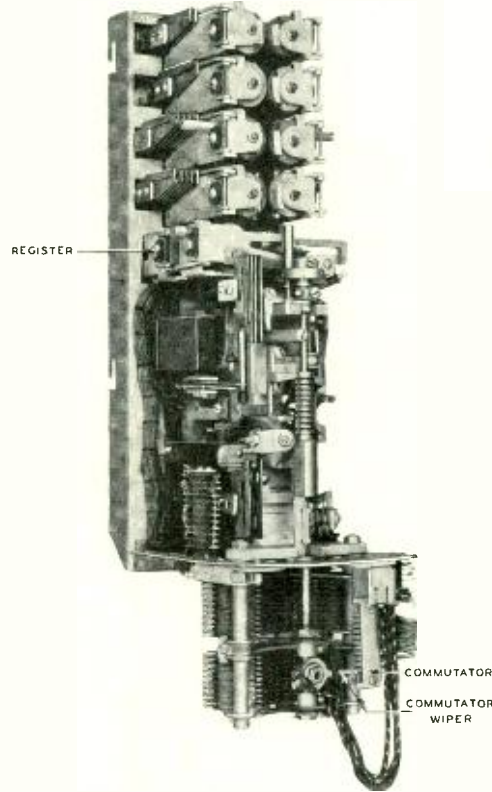

Fig. 2—A level-hunting connector differs from an ordinary connector principally by the addition of a commutator and a register switch

to the third level and then rotate horizontally to seize the first idle trunk.

When all trunks of the group are idle the switch will stop and connect to the first trunk of the group; that is, line 1231. If a second subscriber

now calls the same PBX he will not receive the busy tone but will be connected through on the second trunk, line 1232. A third calling subscriber will

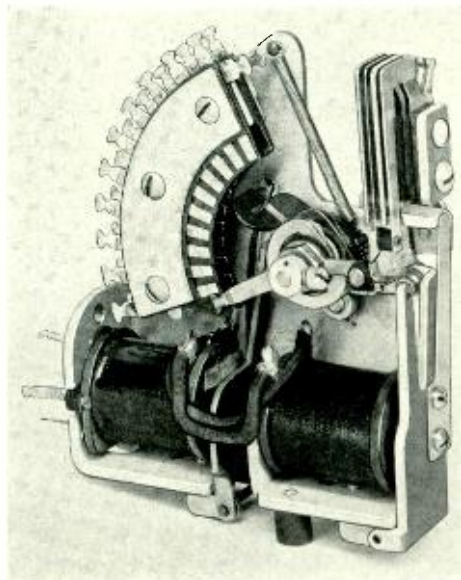

Fig. 3—The structure of the register switch, not clearly discernible in Figure 2, is evident here

be connected to the next line and so on till all trunks on the level are busy.

When this occurs and another subscriber dials 1231, the connector, af-

ter testing the trunks of the third level and finding them busy, will automatically release and at the same time the register switch will advance to the fourth terminal. This causes the distinctive marking indication to be transferred from the third to the fourth of the commutator segments so that after the shaft has dropped to the normal position the connector will automatically step to the fourth level and rotate to test the trunks there. If a trunk appearing on this level is idle it will be seized and the connection established, but should all trunks on this level also be busy the connector will again automatically release. With the restoration of the shaft to the normal position the register switch will be advanced to the fifth terminal and the distinctive indication transferred from the fourth to the fifth segment of the commutator. This action will continue until an idle trunk is found or until all trunks of the group have been tested. If all trunks of the group are busy, a distinctive tone called a "line busy tone" will be given the calling subscriber and the connector switch will not automatically release after the last trunk of the last level is tested.

Report on Employees' Benefit Plan

In a statement directed "To All Active and Retired Employees" under date of February 8, 1929, the Employees' Benefit Committee calls attention to certain changes made during the past summer in the Employees' Benefit Fund Plan for the purpose of improving the pension and other benefit provisions of the Plan. The statement, which is signed by H. D. Arnold as Chairman of the Employees' Benefit Committee and approved by President F. B. Jewett, is as follows:

"The Report on Employees' Benefit Fund as published in the BELL LABORATORIES RECORD, March, 1928, called attention to a change, effective as of January 1, 1927, in the 'Plan for Employees' Pensions, Disability Benefits and Death Benefits,' adopting a systematic method of providing funds for the payment of service pensions and, to some extent, broadening the obligations of the Laboratories with respect to such pensions.

"As a further step in improving the pension and other benefit provisions of the Plan, the Committee, with the approval of the President and the Board of Directors, has made additional changes therein effective July 1, 1928. These changes have all been embodied in a revised Plan, copies of which may be obtained from the Employee Service Department.

"The principal changes in the Plan from the provisions in effect prior to 1927 are:

(a) The obligations of the Labor-

atories with respect to payments under the Plan, as it may be in effect from time to time, have been extended so that they are no longer limited by the conditions stated in what were formerly Sections 11 and 12 of the Plan.

(b) All payments under the Plan other than for service pensions are charged directly to the operating expense account of the Laboratories and not accounted for through an 'Employees' Benefit Fund' as heretofore. (These payments represent current expenditures, covering for the most part short periods only and tending, from year to year, to bear a fairly constant relationship to the total payroll of the Laboratories.)

(c) All service pensions (that is, pensions granted under the provisions of subsections [a] and [b] of Paragraph 1 of Section 4 of the Plan) are provided for by a Pension Fund. This Pension Fund is sufficient in amount to meet all existing liability in respect of service pensions of retired employees as well as employees eligible to retire at their own request. It is held by a Trustee and is now invested in interest-bearing securities of the Laboratories, and can be used only for service pension purposes as directed by the Laboratories from time to time. The Laboratories has undertaken to maintain this Fund by periodic payments thereto in such amount that, when employees become eligible under the Plan to receive pensions at their own request, there will be available in this Pension Fund an amount

which will be sufficient to provide life pensions of the amount stated in the Plan.

(d) The 'Employees' Benefit Fund' and the related Employees' Benefit Reserve accounts are no longer maintained, assets represented thereby having been transferred as of June 30, 1928, to the Pension Fund—the trust fund established under the Plan to meet service pension requirements. The establishing of this Pension Fund eliminates the necessity of these accounts on the books of the Laboratories.

"It will be noted that these modifications relate to the safeguarding of the pension features of the Plan and to the method of providing funds to meet future requirements and of accounting for payments under the Plan. They do not in any way affect the right of the Laboratories to make changes in the Plan, provided such changes do not affect the rights of any employee to any benefit or pension to which he may have previously become entitled under the Plan. They do not in any way affect the amount of any benefit or pension payment, or the manner in which payments will be made to employees who become enti-

tled to them. In the opinion of this Committee the changes will more effectually carry out the purposes of the Plan."

In accordance with these changes, the balance in the Employees' Benefit Fund at June 30, 1928, in the amount of \$184,775.79 has been transferred to the Pension Fund.

During 1928 total payments under the Plan for Employees' Pensions, Disability Benefits and Death Benefits amounted to \$107,675 as follows:

Pensions	\$ 5,324
Accident disability and death payments	9,823
Sickness disability payments	84,868
Sickness death pay- ments	7,660
	<hr/>
Total	\$107,675

A. F. WEBER, *Secretary,*
Employees' Benefit Committee.

*The above statement of payments
audited and found correct.*

E. J. SANTRY,
General Auditor.

News Notes

DR. JEWETT, together with O. E. Buckley of the Laboratories and Lloyd Espenschied and T. G. Miller of A. T. & T., sailed for Europe on February 9.

ON FEBRUARY 7 Dr. Jewett was a guest of a group of University of Chicago Alumni at a dinner at the Metropolitan Club, where he described the developments which resulted in the present transatlantic radio telephone circuits.

DR. JEWETT will read a paper at the World Engineering Congress in Tokio, Japan, late this year.

THE RECEPTION COMMITTEE at the Edison Medal Presentation included G. F. Fowler, Chairman; H. S. Black, D. G. Blattner, W. G. Lasky, D. E. Trucksess, and J. F. Wentz.

AT THE FEBRUARY 4 MEETING of the Colloquium, R. R. RIESZ spoke on the "Theory of Operation of the Human Larynx." On February 18, W. Wilson addressed the Colloquium on "Physical Problems of Radio."

THOMAS I. STARR, Assistant News Manager of the Michigan Bell Telephone Company, was a recent visitor to the Laboratories. At that time he stated that whenever a new telephone building is constructed in his territory, among the papers placed in the corner-stone box for preservation is a copy of the booklet, "Pictures from Bell Telephone Laboratories."

APPARATUS DEVELOPMENT

F. F. LUCAS spoke on "Metallographic Studies of Steel" before the

Buffalo Chapter of the American Society for Steel Treating on January 24.

H. A. ANDERSON addressed the Educational Group of the Consolidated Gas, Electric Light and Power Company in Baltimore on February 5, on "New Developments in Engineering Materials."

W. J. FARMER visited Baker and Company in Newark for discussion of manufacturing procedure in rolling thin duralumin ribbons.

J. R. TOWNSEND attended a meeting of the Fatigue Committee of the American Society for Testing Materials in Philadelphia.

H. N. VAN DEUSEN visited New Orleans and other southern cities in an inspection survey of telephone exchange apparatus of the Bell System.

D. W. MATHISON visited Lansing, Michigan, during the week of February 11 in connection with the cleaning of step-by-step switches in dial offices.

R. M. PEASE gave a demonstration in connection with a lecture by S. P. Grace before the Cincinnati Engineering Society and the local section of the A.I.E.E. on January 17.

D. M. TERRY spoke on television before the Men's Club of the Methodist Episcopal Church of Elmhurst, Long Island, on January 15.

H. F. DOBBIN and H. BROADWELL were at Hawthorne during the week of February 4 to discuss tool-made samples of precision interrupters.

H. S. PRICE made surveys for one-kilowatt broadcasting equipments

purchased by the Outlet Company of Providence, Rhode Island, and by the Shepard Stores, Boston. He also inspected the 500-watt equipment owned by the Edison Electric Illuminating Company of Boston.

B. R. COLE supervised the installation of a crystal-control conversion unit for the one-kilowatt broadcasting equipment owned by the Acme Mills of Hopkinsville, Kentucky. He supervised the installation of a one-kilowatt broadcasting equipment and associated speech input equipment for the Memphis Commercial Appeal at Memphis, Tennessee, and made a survey for the proposed five-kilowatt installation to be owned by the Atlanta Journal, Atlanta, Georgia.

E. L. NELSON is a member of the group preparing the program for the discussion of radio achievements at the World Engineering Congress to be held in Tokio next October.

INSPECTION ENGINEERING

A. F. GILSON AND E. G. D. PATTERSON visited Hubbard and Company at Pittsburgh, Madison Foundry Company at Cleveland, and National Fireproofing Company at Aultman, Ohio, to make studies of inspection and quality-control methods as applied in the manufacture of various outside plant materials.

R. B. MILLER visited Philadelphia on January 23 to discuss an inspection plan for panel central offices based on the "Defect Tolerance and Sampling Requirements Specifications" which have recently been completed.

O. S. MARKUSON visited Kearny during the week of January 28, and R. M. Moody and H. C. Cunningham visited Hawthorne during the week of February 11, in connection with regular survey conferences.

A. N. JEFFRIES visited Electrical Research Products, Incorporated, in Philadelphia on several occasions to investigate apparatus for the production and exhibition of synchronized sound pictures.

G. D. EDWARDS, A. G. DALTON AND I. W. WHITESIDE, Philadelphia Field Engineer, visited Washington, Philadelphia, Harrisburg and Pittsburgh in connection with Field Engineering activities, during the week of January 20.

PATENT

MEMBERS OF THE PATENT DEPARTMENT who went to Washington during the period from January 11 to February 9 were: E. W. Adams, W. C. Kiesel, A. G. Kingman, G. C. Lord, R. G. Mullee, O. E. Rasmussen, J. W. Schmied, and G. H. Stevenson.

During October, November, December and January, applications for patent were granted to the following members of the Laboratories staff:

B. G. Björnson	K. S. Johnson
H. S. Black	L. H. Johnson
W. T. Booth	W. C. Jones
O. E. Buckley (3)	C. R. Keith
W. W. Carpenter (2)	B. W. Kendall (3)
E. H. Clark	F. A. Korn
R. D. Conway	J. J. Kuhn (2)
E. B. Craft	F. R. Lamberty
A. M. Curtis (4)	M. B. Long
H. F. Dodge	G. R. Lum (4)
J. B. Draper	E. R. Lundius
G. H. Duhnkrack	A. C. Magrath
B. G. Dunham	W. A. Marrison
G. W. Elmen	R. C. Mathes (5)
J. F. Farrington (3)	D. D. Miller
H. A. Frederick	C. R. Moore
E. W. Gent	E. R. Morton
J. J. Gilbert (3)	W. E. Mougey (2)
W. S. Gorton	P. B. Murphy
A. E. Hague (2)	E. L. Nelson
R. W. Harper	H. W. O'Neill (3)
J. E. Harris	A. A. Oswald (2)
H. C. Harrison	E. Peterson (3)
R. V. L. Hartley	A. Raynsford
J. F. Hearn	V. L. Ronci (2)
R. A. Heising (9)	F. M. Ryan
E. E. Hinrichsen (2)	J. P. Schafer
C. L. Hippensteel	J. W. Schmied
J. F. D. Hoge	E. E. Schumacher
H. E. Ives (3)	P. Schwerin

W. J. Shackelton
E. B. Smith
W. F. Smith, Jr.
A. B. Sperry
C. A. Sprague
F. A. Stearn
R. L. Stokely (2)
H. M. Stoller (2)
C. F. Swasey
D. M. Terry

A. L. Thuras
J. F. Toomey
E. C. Wentz
E. B. Wheeler (2)
J. H. White
R. R. Williams
S. B. Williams
I. G. Wilson
E. B. Wood
A. W. Ziegler

SYSTEMS DEVELOPMENT

L. M. ALLEN attended the cut-over of the new step-by-step equipment at Hartford, Connecticut, on January 12.

H. C. CAVERLY and O. H. KOPP discussed sender test circuits with representatives of the Hawthorne Works and the Michigan Bell Telephone Company.

A. E. BACHELET, B. A. FAIRWEATHER and K. LUTOMIRSKI visited various repeater stations on the Pittsburgh-New York cable, to make tests on the new B-22 program supply circuits.

J. R. P. GOLLER visited the Allentown, Pennsylvania, repeater station to supervise the installation of electrolytic condensers.

H. E. MARTING and E. H. SMITH visited the new step-by-step dial office in process of installation at Wilmington, Delaware.

R. H. MILLER and R. G. KOONTZ discussed the new No. 3 toll board at Detroit with engineers of the Michigan Bell Telephone Company.

L. A. O'BRIEN has returned from England, where he supervised the installation of a picture transmission system for the Daily Express Newspapers at their offices in London, Manchester and Glasgow.

L. F. PORTER conducted tests on the new No. 3 toll board which will shortly be placed on service in Chicago.

T. A. SPENCER conferred with representatives of the Western Electric

Company in Chicago on equipment to be used in testing the new No. 3 toll board.

CHARLES N. FENSTERMACHER, supervisor of a circuit analyzation group in the Systems Development Department, died on February 24. Mr. Fenstermacher had been associated with the Bell System since July 18, 1904.

RESEARCH

A. C. KELLER and I. S. RAFUSE visited the Veeder Root Manufacturing Company in regard to the manufacture of special magnetic counters used in electric recording of sound.

H. A. LARLEE attended a meeting of the Instruments Committee at Hawthorne from January 28 to February 2, discussing current engineering on transmitters and receivers.

R. M. BURNS visited Norfolk, Atlanta, Birmingham and New Orleans from January 3 to 15 for a survey of the corrosion of telephone apparatus.

L. H. CAMPBELL visited New Haven to observe shop application of automobile finishes. He later investigated cable corrosion at Elkton, Maryland, and Wilmington, Delaware.

B. L. CLARKE was in Norfolk and Baltimore from January 27 to 29, continuing studies of cable corrosion started last July.

HARVEY FLETCHER attended meetings of the American Federation of Organizations for the Hard of Hearing at Washington, over the week-end of February 2.

DR. FLETCHER, J. B. KELLEY and J. C. STEINBERG attended the Second Conference on Research for the Deaf and Hard of Hearing held under the auspices of the Division of Anthro-

pology and Psychology of the National Research Council.

E. C. WENTE made observations in connection with commercial sound films in Hollywood, California, from January 9 to 30.

E. F. KINGSBURY addressed the Ridgeview Community Men's Club of West Orange on television, on February 18.

AUTHORS OF PAPERS presented at the joint meeting of the American Physical Society and the Optical Society of America on February 23 included H. E. Ives, whose paper "Motion Pictures in Relief" was given. R. M. Bozorth gave a paper on "The Barkhausen Effect in Iron, Nickel and Permalloy." O. E. Buckley was the co-author with L. W. McKeehan, formerly of the Laboratories and now Director of Sloan Physical Laboratory of Yale University, of "Atomic Order in Ferromagnetism."

GENERAL STAFF

L. S. O'ROARK spoke on "The Photoelectric Cell and Its Uses in Communication" at Armour Institute, Chicago, on February 14, and on the following day at Northwestern University, Evanston.

J. O. PERRINE spoke on the same subject before the Milwaukee Section of the A.I.E.E. on February 18, and the Madison, Wisconsin, Section on February 19. Mr. Perrine subsequently spoke at the University of Illinois, Purdue University and the University of Michigan.

S. P. GRACE's lecture engagements included an address before the Nebraska Telephone Association at Lincoln on February 14, and one before

the Nebraska Section of the A.I.E.E. and Engineers' Club of Omaha on February 19.

BELL LABORATORIES RECORD was represented by P. B. Findley at a conference of Bell System magazine editors held at 195 Broadway from February 25 to 28. P. C. Jones and A. R. Thompson attended certain sessions of the conference. On March 1, the out-of-town members made an inspection tour of the Laboratories.

M. B. LONG addressed the Philadelphia Section of the A.I.E.E. on January 14, being assisted in a demonstration of sound pictures by R. A. Deller.

A FEATURE OF THE WINTER CONVENTION of the A. I. E. E. was a lecture and demonstration in the Auditorium on January 30. S. P. Grace explained recent developments of these Laboratories, and R. M. Pease had charge of the apparatus used.

DURING FEBRUARY, nine laboratories men visited colleges and universities in the east and the middle west to choose future engineers for the Bell System from the 1929 technical graduates. M. B. Long was at Minnesota, Iowa State, and Iowa; R. A. Deller, at New York University and Ohio State; M. L. Wilson, at Lafayette; D. A. Quarles, at Lehigh; E. L. Nelson, at the University of Chicago, Armour and Northwestern; T. E. Shea, at Worcester; T. C. Fry, at Brown; W. Wilson, at Cornell; R. J. Heffner, at California Institute of Technology, Pomona, University of California, and U. of California, Southern Branch; and E. J. Johnson, at North Carolina Agricultural and Engineering, University of North Carolina and Davidson.

Club Notes

The Spring Entertainment and Dance will be held in the Grand Ballroom of the Hotel Pennsylvania on Friday, April 26. The feature of the evening is to be a concert by our Glee Club, commencing at nine o'clock. Dancing to the mellifluous cadences of Herbert Hood's orchestra will last from ten till two.

The Glee Club has been rehearsing since last October, under the leadership of Professor V. S. Richards, to produce a "concord of sweet sounds" for this occasion. Ada Van Ripper and P. H. Betts, who have been acting as business managers of the club, have been no less diligent in aiding Professor Richards with the musical direction.



General admission tickets include a seat for the concert, and cost one dollar. Box seats are two dollars each, and should be reserved early to avoid disappointment. Reservations may be made by calling D. D. Haggerty on Extension 542.

BASKETBALL

Year after year the many branches of the Bell System in the metropolitan district strive to build up a basketball team that will beat West Street but each year the results are the same. The Laboratories' cagers are out on top: undisputed champions of the Bell System.

On Monday evening, February 11, West Street won the Bell System League championship when they defeated the team representing the Southern Division of the New York Telephone Company, Manhattan. This game completed the League season during which the Laboratories' team played nine games, winning eight games and defeating the strongest teams that the New York Telephone Company and the Western Electric Company could put on the courts.

Two exceptionally strong teams stood between the Laboratories and the championship but our players met each organization and sent them home with the short end of the score. On Monday evening, January 21, one of these games was played with the New York Telephone Company, Long Island Division. After a fast, hard and clean game we won by a score of thirty-four to nineteen. On Friday evening, February 1, our team played its annual game with the team from Western Electric, Hudson Street, with three hundred seventy rooters from West Street on hand to cheer our players. When the final whistle blew the score was twenty to thirteen in favor of West Street. This was the tenth of a series of annual engagements with Hudson Street, all of them won by our team.



The heavy work during the season fell on C. F. Gittenberger, C. Maurer, W. Steinmetz, H. D. Cahill and C. Christ, with C. Kirsch and J. E. Keogh as substitutes. With the exception of Christ, who was a substitute on last year's team, the other regular players have represented the Laboratories in outside competition for the past seven years. Carl Maurer was the outstanding star on the team and also won the Robert Stoll trophy for the most points scored by an individual in league games. Maurer finished the season with one hundred and nineteen points, a player from Western Electric Company, Installation Department team being a close second with one hundred and twelve points. Cahill, who played as guard, was considered one of the best defensive players in the league, and Gittenberger had no equal as a center. Christ and Steinmetz also share credit for points scored by the team.

In winning the League championship the Laboratories now have two legs on the league trophy, which must be won three times for permanent possession. The members of the team will receive from the League prizes valued at one hundred dollars.

CARTOONISTS' CONTEST

A monthly contest for cartoonists will be held by the Bell Laboratories Club. A prize of five dollars will be given each month for the best cartoon.

Cartoons must follow these general rules.

1. The size must be $5\frac{1}{4}$ in. by 8 in. or of such proportions that the picture can be reduced to this size.

2. There must be no lettering on the cartoon.

3. There should be no text over

the cartoon; the picture must explain itself.

4. Likeness may be realistic enough to be effective but no personal peculiarities are to be ridiculed.

5. Laugh *with* your subject, not *at* him.

6. The cartoon may be worked in "black and white," "outline," "crayon," or "wash."

7. Cartoons may be a single subject or progressive action to an end.

8. Cartoons are to be submitted to D. D. Haggerty, Room 164, before or on the fifth of each month. The subject for each month will be announced in the preceding issue of the RECORD. The contest begins in April, when the subject will be bowling, and cartoonists will have an opportunity on Friday evenings, March 8, 15, and 29, to study and sketch their subjects. The bowling league meets at Dwyers Manhattan Alleys, 1680 Broadway, from 5:45 P. M. until 8:15 P. M. on the evenings mentioned.

BOWLING

With the crashing of pins instead of guns, the battle of one hundred and sixty bowlers has been fought each Friday evening since September 28, 1928, with the front line trenches at Broadway and 53rd Street. The objective of this battle is the top of the "average" column instead of Paris.



In Company A, three month's fight has been waged for the leadership between T. C. Rice and H. C. Dieffenbach with Dieffenbach now

leading by seventeen pins or .5 of a point in the averages. In Company B the fight for leadership is just as close. F. Lohmeyer is leading with 168.85 but is being pushed hard by F. S. Entz who has a season's average of 167.92. A. G. Kobylarz has the undisputed right to first place in C Company with an average of 160.24 but in D Company the fight is a close one between W. R. Steeneck and L. B. Taylor, whose averages are 147.69 and 147 respectively.

score for the game of 994, which in itself is an exceptional score for an industrial league. On the same night this team broke the league record for total pins for three games when they finished with a total of 2,761 pins.

On December 21st, W. A. Bollinger won the fountain pen donated by A. F. Gilson, the general chairman, for the bowler who exceeded his season's average by the greatest number of pins. The competition for this prize was exceedingly close and the following is the final standing for the first five men:

W. A. Bollinger, C League, improvement—38 pins

H. I. a Frenz, D League, improvement—36.91 pins

T. J. O'Neil, A League, improvement—36.85 pins

H. A. Reybert, C League, improvement—34.69 pins

A. G. Jeffrey, B League, improvement—34.63 pins.

The fight for high score honors has been close throughout the entire season and the leadership of this group has been changing continually. At the present time P. B. Fairlamb holds high score in A with 256. R. S. Wilbur is leading B with 247. H. A. Reybert has taken first place in C with 236 and H. A. Paulssen is now leading D with 221.

Although the bowling committee is more than pleased with the general improvement of the bowlers, the fact that there has been a one hundred per cent attendance for eighteen weeks makes them feel that they have been compensated for the work of carrying on the activities of the league.

GLEE CLUB

On January 30, the members of



A cartoonist looks at bowling and bowlers

A split in the tenth frame of the last game on Friday evening, February 8th, prevented the Ringers in Group A from breaking the present league high team score of 1005. While the Ringers hold this record score they are always working with the idea of bettering it. The split in the tenth resulted in a total team

the Glee Club, accompanied by Professor Richards and Mrs. Richards enjoyed a dinner party at the Ship Shape Inn. Returning to the Laboratories after dinner, the members played various games until time for rehearsal. The vocalists then reverted to the serious business of practicing for the concert, which will precede the Spring Dance of the Club on April 26.

WOMEN'S SWIMMING

To those of us who are unable to get to Palm Beach this winter (and aren't we all!) — the swimming classes at the Carroll Club are a neat solution to the problem of getting in some swimming during the winter months. The temperature in the pool is artfully regulated to afford a semi-tropical atmosphere. If the more conservative of the swimmers still find the water a trifle chilly, a few strokes of the Australian crawl will soon remedy that. Miss Spranger's pupils are now nearly all able to do

the crawl, by the way, and most of them have learned a thing or two about plain or fancy diving. This last item appeals especially to persons who have yearned to enter the water in a more graceful way than holding one's nose, and jumping in, feet first.

Details as to time, place, and all that, will be most amiably furnished by Catherine Tully, on extension 218.

WOMEN'S BOWLING

The season's prizes for the women's group of the bowling league, now on exhibition in the show case, are adding incentive to keen competition among the women bowlers. The awards include a prize for the greatest improvement in average, donated by A. F. Gilson, General Chairman of the League. Joe Dusheck appears on the scene every Friday evening to coach the team. His suggestions and friendly criticism are greatly appreciated by the Club. The Bowling League is planning to give a dinner and theatre party at a date to be announced shortly.