

Wates <sup>Goldwin</sup> Quincy #222 -8200  
no answer 2-5088

Notice

RCA 833's  
In Modulators Only

BC-1T/BC-500T/BC-250T

ADDENDA SHEET

- B-13816 Schematic (Osc. Unit)
- E-25534 Schematic-Overall BC-1T.
- E-25569 Schematic-Overall BC-500T.
- E-25582 Schematic-Overall BC-250T.

Any 833's will  
Work In Finals

1. Change Value of R2 on Oscillator Unit from 150 ohms, 2 watt to 3900 ohms, 2 watt.
2. Add C11, 100 mmfd. cap across L3.

with new tubes

Osc - Buffer	255
RF Drive	.5
RF " Grid	188
Power amp	170

Per ECN-7482  
Date: 5/29/58  
Per ECN-7496  
Date: 6/26/58

ADDENDA SHEET

INSTALLATION INSTRUCTIONS FOR REMOTE CONTROL

IN

GATES TRANSMITTERS BC-1T, BC-500T, BC-250T

Refer to the following overall transmitter schematic diagrams:

BC-1T - E-25534  
BC-500T - E-25569  
BC-250T - E-25582

A steel plate, drilled for mounting the M-4719 plate voltage kit, M4720 plate current kit and M-4703 rheostat assembly is available for the installer's use. Tapped mounting holes for this plate have been provided in the cabinet corner supports, directly beneath the terminal boards and contactors (right side of transmitter as viewed from front). Photographs showing the remote control kits in place is included with these instructions.

M-4703 Motor Rheostat Assembly

As viewed from the rheostat end of this assembly, with the three rheostat terminals to the left, strap the center terminal (arm) to the top terminal. Since application of "increase" voltage brings about clockwise rotation of the arm (same view), resistance will decrease. With application of "decrease" voltage, the resistance will increase.

The existing plate voltage meters in the BC-1T, BC-500T and BC-250T transmitters read plate to cathode voltage, whereas, the remote control voltage sampling kit will read plate to ground voltage. Therefore, in order for the two meters to track the rheostat must be wired in series with the high voltage lead feeding the final amplifier.

Proceed as follows:

1. Disconnect from modulation reactor L-3, the high voltage lead which runs upward to the final amplifier RF choke L-9. Remove this wire from the cable until sufficient length is available, then connect to one of the motor rheostat terminals.
2. Using Packard cable or a high voltage equivalent, run a lead from the other rheostat terminal to this same modulation reactor terminal discussed in Step 1. Set the transmitter voltage control R-14, for maximum voltage (minimum resistance).
3. The control circuit hook-up between the M-4703 motor and remote control unit is explained in the Remote Control instruction book.

### Plate Voltage Extension Kit M-4719

1. Using Packard cable or a high voltage equivalent, connect the M-4719 "HV" terminal to the motor rheostat terminal furthest from the power supply. Do not connect to the rheostat terminal which goes to the modulation reactor. Connect the M-4719 kit terminal "G" to a good ground point within the transmitter.
2. Refer to the Remote Control instruction book for connection of meter sample voltage to remote control unit.

### Plate Current Extension Kit M-4720

1. The plate current kit is to be connected between the lower end of P.A. overload relay K-6 and ground.
2. A ground lead runs from a chassis ground terminal to one of the coil terminals on K-7 modulator overload relay, thence to one coil terminal of K-6 P.A. overload relay. Clip out the portion between K-6 and K-7. K-7 is to retain its direct chassis ground since we want only P.A. current to flow through the plate current kit.
3. Both K-6 and K-7 must retain their shunt resistors directly across their respective coils.
4. The "G" terminal of the two-terminal strip on kit M-4720 connects to a good ground point within the transmitter. Run a lead from the other terminal, upward to the K-6 terminal which was formerly grounded.
5. Refer to the Remote Control instruction book for connection of sampling voltage to remote control unit.

### Remote Plate Start-Stop Circuitry

The BC-1T, BC-500T and BC-250T overall schematic diagrams plainly indicate the necessary connections for filament and plate remote control. The plate start-stop circuitry consists merely of shunting the transmitter plate-start switch with a set of normally open remote control contacts. The plate-stop function is accomplished by connecting a set of normally closed remote contacts in series with the transmitter plate-stop switch.

### Remote Filament Start-Stop Circuitry

Note that a jumper is to be removed in the filament contactor circuit. Removal of this jumper disables the holding contacts on the filament contactor. A set of remote normally-open contacts shunted across the transmitter's filament-start switch will then serve as filament start

and hold, satisfying FCC requirements for a "fail-safe" circuit. If the telephone line between studio and transmitter fails, or if the remote control equipment becomes defective the remote holding contacts open. This, in turn, causes the filament contactor to drop out, removing the transmitter from the air.

In multiple transmitter installations, the filament-fail safe operation is accomplished in a slightly different manner, so that individual filament control for the various transmitters is possible. Each transmitter employs its individual slave relay associated with its respective transmitter filament contactor. The fail-safe relay in the remote control unit, in turn, holds energized all of the slave relays. The slave relay contacts are wired in series with their respective filament contactor off circuits, providing a holding circuit. Thus, separate on-off filament control is possible for each transmitter. These circuits, along with drawings are presented in detail in the Remote Control instruction book.

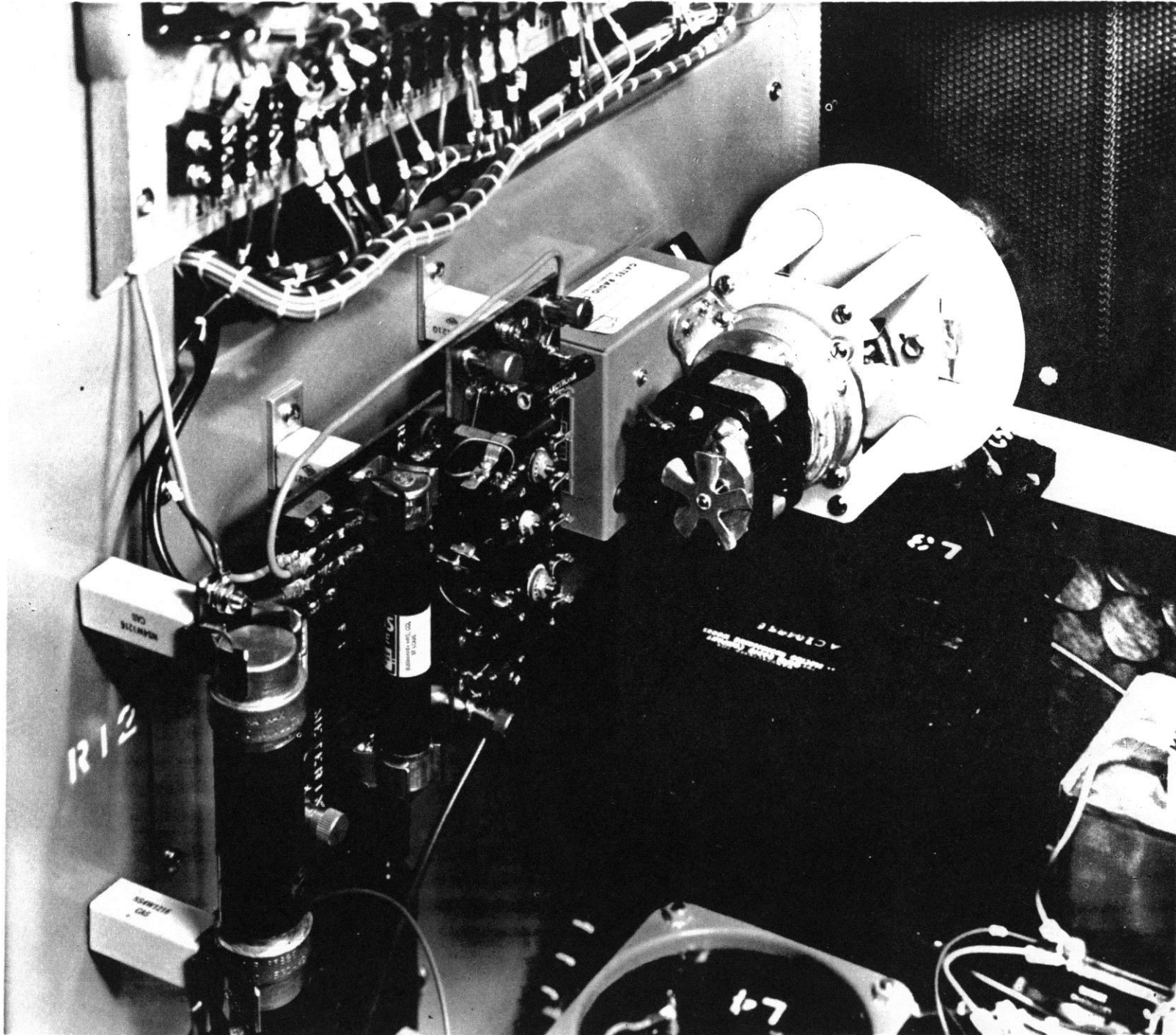

REMOTE CONTROL ACCESSORIES  
BC-IT, BC-500T, BC-250T

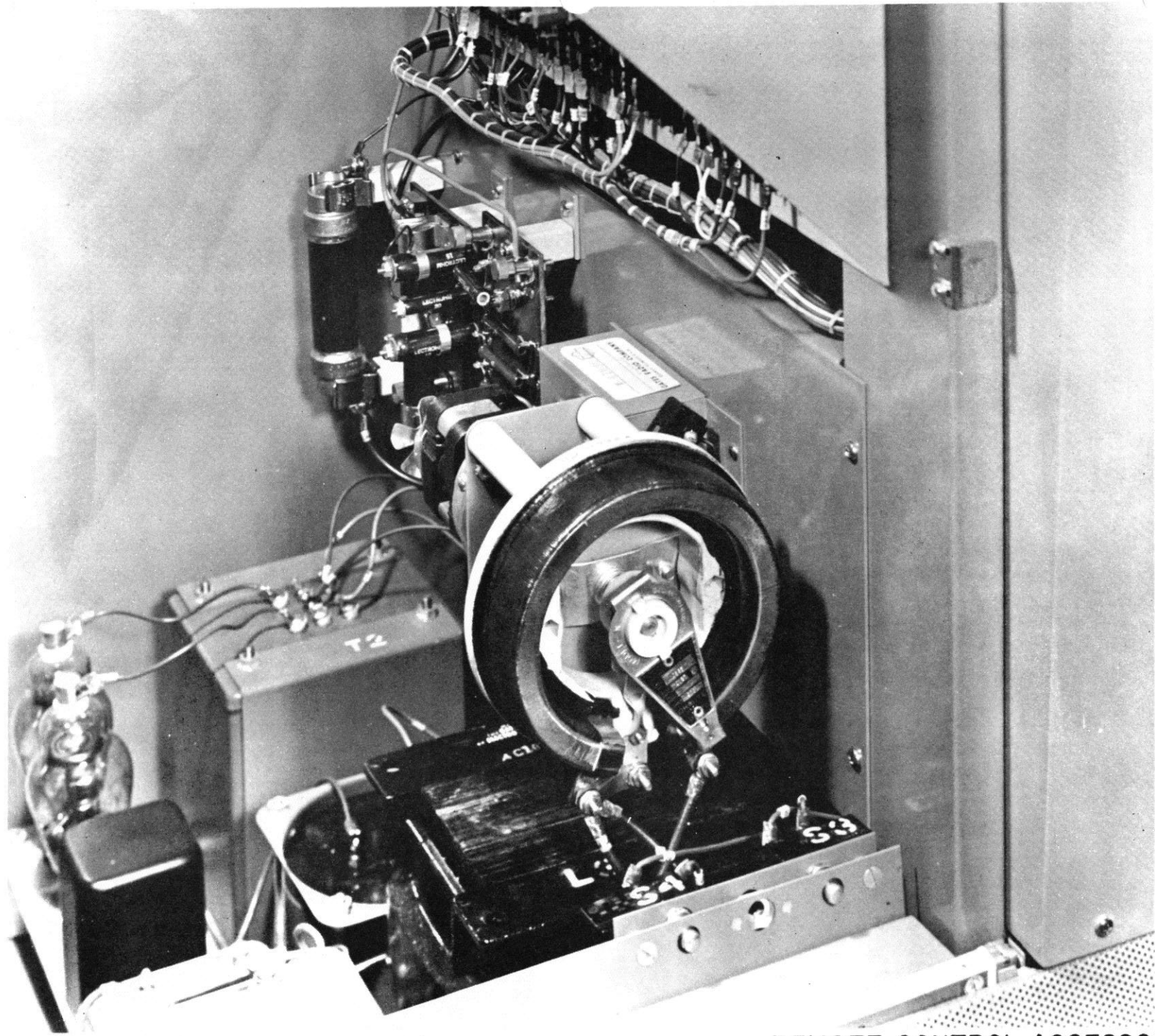

REMOTE CONTROL ACCESSORIES  
BC-1T, BC-500T, BC-250T

INSTRUCTIONS FOR INSTALLING AND OPERATING  
THE GATES' MODEL BC-1T  
1KW BROADCAST TRANSMITTER, M5393

IB-869  
11-18-57

Gates Radio Company  
Quincy, Illinois

## INDEX

	Page
Section I Electrical Description .....	1
Section II Mechanical Description .....	2
Section III Installation .....	2
Section IV Gates BC-1T Transmitter Details .....	3
Section V Initial Tune-up of Gates BC-1T .....	12
Section VI General Operating Procedure .....	17
Section VII Summary .....	20
Guarantee .....	1 -2
Photographs .....	
Electrical Parts List .....	1 - 6

### BC-1T Drawings:

- A-30603 - Typical Voltage Chart
- A-30604 - Tuning Chart
- A-30584 - Typical Curves, Vacuum Ovenless Crystals
- A-30585 - Wood Base
- A-30905 - Dummy Antenna Characteristics
- A-31066 - 30 Cy. Attenuation Network
- B-13816 - Schematic, M5422 Oscillator Unit
- B-65286 - Schematic, R.F. Driver Unit
- C-77711 - Schematic, Audio Input/Cathode Follower
- C-77736 - Overall Cabinet Dimensions
- C-77723 - Simplified Schematic, Control System
- B-65323 - High Voltage Power Supply
- B-65324 - Int. Voltage (600/650V) Power Supply
- B-65293 - Bias Supply
- C-77712 - Power Amplifier Schematic
- E-25534 - Overall Schematic



## SECTION I

### ELECTRICAL DESCRIPTION.

Gates transmitter, Type BC-1T has been designed as a completely new 1000 watt broadcast unit capable of excellent service in the standard broadcast band. Electrical specifications are as follows:

1. Power output, 1000 watts. The Gates BC-1T can be satisfactorily operated at 1100 watts output, if necessary to overcome losses in transmission lines and/or phasing equipment.
2. Frequency Range - 1600 KC to 540 KC.
3. Power Supply - 230 volt, 50/60 cy. 2 wire.
4. Power Consumption - Approximately 3560 watts with normal program modulation of 85%.
5. Frequency Stability -  $\pm 10$  cycles, obtained by use of vacuum, ovenless quartz crystal assemblies.
6. Type of Modulation - High level Class "B" modulation capability 100%.
7. Audio Input -  $\pm 12$  DB,  $\pm 2$  DB for 100% modulation, at 1000 cycles.
8. Frequency Response -  $\pm 1.5$  DB, 30 to 12,000 cycles.
9. Audio Input Impedance - 150/250/600 ohms.
10. Distortion - 3% or less, 50 to 10,000 cycles, measured at 95% modulation.
11. Noise - Minus 60 DB below 100% modulation.
12. Carrier Shift - 3%, or less, 0-100% modulation.
13. Output Impedance - To match 50/70 ohms at all frequencies 540-1600 KC. Coupling unit available for other impedances.
14. Tubes used -
  - One 12BY7A Oscillator
  - One 12BY7A First IPA
  - Two 6BG6G Second IPA (parallel operated)
  - Two 833A Power Amp. (parallel operated)
  - Two 6BG6G Input Audio
  - Two 6BG6G Cathode Follower Audio Drivers.
  - Two 833A Class "B" Modulators
  - One 5R4GY Bias Rectifier
  - Two 866A Intermediate Voltage Rectifier (600/650)
  - Two 8008 High Voltage Rectifier (2500V)
15. Crystals used - Provision made for two vacuum mounted ovenless type crystal assemblies, each switchable into oscillator circuit from front panel.
16. Printed Wiring - - The oscillator and first IPA, the Radio Frequency driver the Audio input/cathode follower stage and the feed back ladder assembly are designed around printed wiring.
17. Dummy Antenna - Self-contained 51.5 ohm dummy antenna capable of handling 100% modulated transmitter output.
18. Ventilation - Two fans in cabinet top. Renewal air filter in cabinet front.

## SECTION II

### MECHANICAL DESCRIPTION

1. Overall dimensions 78" high, 36-1/16" wide and 31-29/32" deep. Back and right hand side are of bolt-on construction.
2. Floor space required - 8 sq. ft. Front door swing is 28".
3. Weight, in operating condition - 800 pounds.

## SECTION III

### INSTALLATION.

This instruction book affords valuable information for persons who are installing and operating the Gates BC-1T transmitter. The following mentioned points should be studied so that the unpacking and setting up procedure will be well in mind when doing the actual work.

1. Check all packing lists for materials supplied.
2. Study the instruction book before attempting to set up the equipment.
3. Have the transmitter location clean so that the various parts can be safely placed out of harms way when they are unpacked.
4. It is preferable to have a mounting base, set in place, upon which the transmitter can be set. This base can be made from 2 X 4 lumber dimensioned as shown in Gates Drawing A30585. It should be painted, preferably black. This base should be lagged to the floor and measures taken to insure that the top side of the frame is perfectly level. This will give a good, solid, level base on which the transmitter can be set. This procedure also allows the external transmitter wiring to enter the cabinet from practically any point underneath and be run to the entry holes provided in the base of the cabinet.
5. Use heavy primary wire from the building switch box terminals to the transmitter fuse block. #4 or #6 copper wire should be very suitable for these two leads.
6. Be sure the power company has installed large enough service for all the equipment, transmitter, lights, water, pump, etc., which will be used at the transmitter site.
7. Do a good job of installing the equipment. Time spent in making the installation as good electrically and mechanically as possible, will pay off in the future by insuring less, off-the-air time.

## SECTION IV

### BC-1T TRANSMITTER DETAILS.

The transmitter has been readied for shipment by having all tubes removed from their respective sockets, relay contacts have been blocked and tied and other parts such as parasitic suppressors, tube caps and leads, etc., tied down securely to prevent damage during shipment. Vacuum enclosed time delay relays have been removed from their sockets. The power amplifier RF choke L9 also has been removed. The connector straps have been adequately tagged for easy, correct re-connection. These components have been adequately marked and packed in cartons that are in turn safely secured within the transmitter. All of the power and modulating equipment has been shipped intact within the cabinet, thus relieving the installation engineer of the re-installation of these components.

Coil L13 located at top rear of cabinet has special mounting brackets provided to insure safe travel, during transit. These, along with all other packing material, string, tape, etc., should be removed from the components. The front door of the transmitter has been mechanically supported to the cabinet for shipping safety. Remove this support after installation.

All relays should be inspected for free travel of armatures and contact.

The following information concerning the Gates BC-1T, pertains to its general construction and operation. It is highly desirable to study the various sections of the transmitter in order to completely understand and comprehend its operation.

The complete transmitter is built in a welded steel cabinet with most of the low power RF and audio components mounted vertically on a formed aluminum panel and shelf assembly. The high power modulators and power amplifier 833A's are located on a tube shelf at the top of this basic assembly. The power amplifier tuning and loading components are mounted on a large aluminum panel assembly at the top of the cabinet. This assembly is perforated to allow the heated air within the cabinet to pass through it and then drawn out of cabinet by the two top fans. Located in the base of the transmitter are the heavy power components such as power transformers, rectifier, filament transformers, filter components, modulation choke and transformer, and rectifier tubes.

Two removable air filters are located in the cabinet just at the bottom of the large front door. These filters can be changed while the transmitter is in operation. The frequency of filter change will be determined by the transmitter location. In dusty locations, the filters will, of course, become clogged very quickly and should be changed as necessary to insure a full clean flow of air into the cabinet.

The transmitter is completely dead front; there is a perforated metal inner shield extending downward from the power amplifier panel to the

air intake panel. The inner shield is joined to the air filter panel by means of two thumb "quick off" fasteners. Near the right hand fastener are the interlocks for the 600 volt and 2500 volt power supplies. All controls are available to the operator through a cut out in this perforated screen panel. If this panel is removed, the 600 volt and 2500 volt power supply interlocks function, removing these voltages from the transmitter.

This transmitter is crystal controlled by means of the M5422 oscillator unit which is located on the panel and shelf assembly. The crystal change-over switch S1, along with the frequency adjust variable condensers C1 and C2 are conveniently located on the front control panel. The M5422 oscillator is mechanically mounted to the side of the upright panel by means of four mounting screws. Power connections to oscillator are made by a detachable plug assembly. For maintenance and service this oscillator can be quickly removed from the transmitter.

The M5422 frequency control unit uses a 12BY7A tube connected circuit wise as a electron coupled oscillator, controlled by a vacuum mounted, ovenless type crystal assembly. Positions for two crystals is provided in the oscillator unit. The untuned plate circuit of the oscillator is capacity coupled to the grid of the first IPA, another 12BY7A physically located in the small oscillator unit. This stage operates under very conservative conditions and makes a fine isolation buffer between the oscillator and the R.F. driver.

Due to the conservative operating potentials and the extremely low crystal currents, the M5422 oscillator unit has exceptional frequency stability. The crystals are of a low temperature coefficient type which do not need a heated oven to maintain frequency well within FCC limits. Frequency trimmers C1 and C2 provide a small degree of frequency adjustment which may be required if the crystals age. The M5422 oscillator unit is easily tuned to the operating frequency. No tuning is required for the oscillator itself, just insert the crystal, or crystals and set the crystal selector switch accordingly. The first IPA stage (12BY7A, V2 in unit) must be tuned. Provision is made to supply R.F. voltage from a resistive divider at the output of the M5422 oscillator to a frequency monitor such as the Gates M2890. This monitor drive is available between terminal #27 on TBI and ground. See overall schematic E25534. For typical voltages occurring in the oscillator unit see Gates Drawing A30803. The total plate current drawn by the oscillator and first IPA tubes in the oscillator unit is in the neighborhood of 20 to 25 ma. as measured on the multimeter, when the multimeter switch is in the position marked "Plt. Cur. Osc/Buf". The positive plate potential applied to the oscillator unit is derived from the 600 volt power supply through a 20K ohm dropping resistor, R9. Printed wiring is used in this oscillator unit.

The second IPA stage uses two 6BG6G, beam power pentodes operating in parallel. These tubes have approximately 600/650 volts applied to their plates. The cathode current of the two 6BG6G tubes will run between 150 and 200 ma. depending upon loading and operating frequency.

This cathode current is indicated on the multimeter when the selector switch is set to "RF Driver Cath.". The stage is tuned from the front panel by control knob designated as "RF Driver Tuning". This stage will tune from 1600 KC to 1050 KC with no padding condenser required. See frequency determining component chart, Gates Drawing A30604. There is meter indication of the RF drive supplied to the two 6BG6G by setting the selector switch to position marked "RF Driver Grid". In normal operation the grid current indication of this stage will be on the order of .3 to .5 ma. With normal voltages applied and adequate grid drive, the 6BG6G's in this RF driver stage will supply between 100 and 150 grid mils to the power amplifier. This current will vary according to tuning and operating frequency, but should never run less than 100 ma. This P.A. grid current is also measured by the multimeter, being indicated on the meter when the selector switch is placed in the "Power Amp. Grid" position. The plate dissipation of the two 6BG6G tubes is kept within acceptable limits by the use of a cathode resistor (R2) used for developing some cathode bias. If the drive to this stage is lost, the cathode developed bias will tend to hold the plate current within reasonable bounds. Most of the circuitry of this 2nd IPA stage is made up of printed wiring, only the plate coil, L8, tuning capacitors C7 and C15 and plate choke L7 are mounted external to the printed wiring board.

The plate voltage which energizes the two 6BG6G RF Drivers is developed in a 600/650 volt power supply using two 866A tubes as rectifiers. This plate voltage flows through a secondary winding on the modulation transformer T3 before being applied to the RF Driver. During operation, this plate and screen voltage is modulated approximately 10%. This causes the drive to vary in proportion to the modulation, thus improving the linearity of the modulated amplifier. By this method, along with improved modulation transformer design, the distortion is reduced to a very low percentage.

Typical voltages appearing within this stage are shown on Gates Drawing A30603 and also on Schematic B65286.

Neutralization of the power amplifier is accomplished by the "Rice" method, the out of phase voltage being obtained from the 6BG6G tank coil, L8. There are several taps brought out adjacent to the electrical center of this coil, these taps affording rough neutralization. By means of the variable neutralizing condenser C10 and these taps, it is possible to completely neutralize the two 833A tubes in the power amplifier. The neutralizing condenser C10 can be adjusted from the front of the transmitter, by use of a screw driver working through the small aperture in the lower right side of the upper front panel. The neutralizing condenser C10 is located directly behind this front panel, its shaft being insulated by means of a slotted bakelite shaft bushing. The power amplifier makes use of two 833A tubes operating in parallel. Most of the power amplifier and output circuitry is mounted on an aluminum panel and chassis, assembly at the top of the cabinet. Ample ventilation is provided by means of two fans located in the top of the cabinet. The heated air passing through the P.A. assembly through numerous openings. This P.A. assembly is made up of PA tank coil L12, PA tank condensers C11 and C12, (always

operating in parallel) output coils L13 and L14, loading condensers C13 and C14, modulation pickup Coil L15, plate blocking condenser C9 and plate bypass condenser C8. The amplifier circuit consists of a "L" and two "T" sections, a circuit proved over the years as one which is flexible and also very effective in attenuation of undesirable harmonics. The coil and capacitor values as supplied with the transmitter, are effective in loading into a 50/70 ohm load. See Tuning Chart, Dwg. A30604.

The output circuit of the BC-1T includes a pickup coil L15, which supplies sufficient RF voltage to operate a modulation monitor, such as the Gates MO-3629. This voltage is available at a small terminal board TB2, located on the front panel, at the left, inside.

This amplifier makes use of no variable, air dielectric condensers, (except the neutralizing condenser, C10). The P.A. tank circuit is tuned by means of a rolling contact inductor L12. This method of tuning is helpful in preventing arcs or flashovers that may occur in variable air dielectric condensers, especially if the transmitter is used in locations where the dust problem is bad. The P.A. tank condensers are two Type G2 Sangamo mica's, always connected in parallel. The combined total value will range from .0005 mfd. at 1600 KC to .001 mfd. at 540 KC. The loading condensers C13 and C14 also vary according to frequency. For information concerning these variable frequency determining components, see Gates Drawing A30604 included in the instruction book.

The power amplifier plate current is read on M2, a 0-1 ampere DC meter. This current will generally run from 525 ma. to 600 ma. depending upon the efficiency and the applied plate voltage. The normal plate voltage as read on plate voltmeter M3, will be around 2500 volts. As mentioned previously, the P.A. grid current, as indicated on the multimeter will be 100 to 150 ma. depending upon frequency, tuning, etc.

Two P.A. tuning control knobs are located on the power amplifier panel, the left hand one controls the variable output coil L14 and is marked "Loading". The right hand knob allows rotation of the variable P.A. tank, coil, tuning the Power amplifier, it is marked "P.A. Tune". The power amplifier is protected from severe overload by a cathode overload relay. This relay K6 is located on the aluminum shelf adjacent to the multiple 833A filament transformer, T9. Its coil is shunted by a semi-variable resistor R21, this resistor allows the trip out point to be varied considerably above and below the normal cathode current drawn by the 833A power amplifier under normal conditions. This relay shunt resistor is adjusted to allow the relay K6 to pull in at about 700 ma. As normal cathode current will be around 525 to 600 ma. this gives considerable operational latitude before the transmitter will kick off the air. Of course, this adjustment can be made to suit the individual who operates the equipment. When P.A. overload relay K6 pulls in, its contacts close, completing an AC 230 volt circuit through the coil of master overload relay K3. K3 energizes and its contacts open, causing the holding circuit of the plate contactor K2 to open and drop out the plate relay. This de-energizes the main power transformer T1.

Audio wise, the Gates BC-1T transmitter is novel in many respects. The Audio input and Audio driver portion is made up of printed wiring. A small bakelite printed board located on the panel and shelf assembly mounts the two 6BG6G audio input tubes, the two 6BG6G cathode follower tubes, along with balance control, condensers and resistors for these two stages.

The Audio input connections are made to TBl-29 and TBl-30, with a convenient ground termination on TBl-28. Provisions have been made on Audio input transformer T6 to allow the input impedance to be either 125, 250 or 600 ohms. This will take care of most audio input requirements. A balance control, (R3), is located on the printed wiring board near the right hand lower corner. This control is in the cathode circuit of the two 6BG6G audio input tubes V1 and V2. By use of this control, low frequency audio distortion can be minimized. This is best accomplished, when test equipment is available to show the actual distortion present. If no such equipment is handy, it would be reasonable to adjust this balance control to mid-value and so operate the transmitter. The second audio stage, a pair of 6BG6G tubes, V3 and V4, are operated as cathode followers, these tubes provide a low impedance driving source for the grids of the two 833A modulators.

Plate potential for the audio input and cathode followers is provided by the 600/650 volt power supply, mentioned previously as supplying voltage to the M5422 oscillator unit and the RF driver stage. Normal voltages to be expected at various points in the audio input circuits are given in Gates Drawing A30603, typical voltages, also Schematic C77711.

The cathode current of the two audio input tubes V1 and V2 is measured by multi-meter, the selector switch being set at "Input Audio Cathode". This current will normally run from 5 to 10 ma. The cathode follower tubes V3 and V4 are biased by voltage controlled by potentiometers R2 and R1 located on the small aluminum front panel. These controls indirectly adjust the operating bias on the modulators by varying the operating constants of the cathode followers, this causes a bias voltage change on the modulators by having a voltage drop occur across the high resistance cathode resistors R11 and R12 of the cathode followers. A very smooth modulator bias change can be attained in this manner, making it possible to adjust the modulators for correct operating conditions. There is no meter plate current indication for the cathode follower tubes V3 and V4, it is believed that if proper modulator operation is had, then the 6BG6G cathode followers are operating satisfactorily.

All external connections to the audio printed wiring is made to numbered terminals, this is shown clearly on small individual drawing C77711 of this section, and in the overall Schematic E25534.

High level Class "B" modulation is used in the BC-1T, a pair of 833A tubes providing the means. The modulation transformer T3, working with these tubes is located in the base of the cabinet, on the right hand side, toward the rear. The grids of the modulators are excited

by the two 6BG6G cathode followers. The modulators operate with approximately 40 ma. static plate current per tube, this operating parameter being set up from the front panel by use of the two "bias" controls, R1 and R2. To enable the operator to individually adjust each modulator tube, a meter switching circuit has been designed. A three position switch, S1, is located on the aluminum front panel, just below the two bias controls. This switch has markings as follows; in the left position Modulator #1, (V8) is metered, in the right hand position Modulator #2 (V9) is metered and when the switch is in the center position marked "Total", both tube currents are combined and read. These currents are indicated on the Modulator front panel meter, M4. The total plate current will be from 350 to 500 ma. during times of heavy modulation.

Each modulator has its filament energized by a separate filament winding on multiple filament transformer T9. The third winding on this transformer T9 is of 10V, 20 ampere capacity and energizes the filaments of the two power amplifier tubes V6 and V7.

The modulators are protected from severe overload by relay K7. This relay K7 is also provided with a coil shunt resistor, R22 making it possible to adjust the pull-in point of the relay. For normal program modulation the modulator plate current should not exceed perhaps 400 ma. Under sine wave audio conditions this current may rise to 650 ma. at the higher audio frequencies. A satisfactory setting for the overload relay would be around 700 ma. This will take care of accidental audio peaks that might go through. This overload relay K7 has its normally open contacts connected in parallel with the normally open contacts of P.A. overload relay K6. If a modulator overload does occur, the K7 modulator overload relay pulls in causing 230 volts AC to be applied to the coil of Master Overload relay K3 which in turn energizes and pulls in to open the holding circuit of plate contactor, K2. This removes the high voltage from the modulators and the power amplifier.

Feed back from the plates of the modulators back to the audio input tube grids has been provided. A small bakelite printed wiring board is located on the panel and shelf assembly, directly above the modulation transformer, T3. By means of a resistor/capacitor divider network out of phase voltage is fed back to the audio input. The BC-1T transmitter makes use of approximately 14 DB of feed back measured at 1000 cycles and 90% modulation. This feed back helps to reduce the hum and also improves the distortion figures.

All relays for the operation of the transmitter are mounted on the panel and shelf assembly, the previously mentioned P.A. and Modulator overload relays K6 and K7 being on the top shelf adjacent to the multiple filament transformer, T9. All other relays are mounted at the bottom of the panel and shelf assembly along with necessary fuses, time delay relays, etc. The main line fuses F1 and F2 are located at the left bottom section of the inside panel assembly, directly over TB1. This fuse receptacle is the terminal location for the two 230 volt primary input wires. Thirty ampere cartridge fuses are used. Next in line is the filament contactor K1.



Filament contactor K1 is energized by depressing the filament start switch S5 located on the front column directly beneath the multimeter. This operation causes the primary input voltage to be connected directly to the primaries of all filament transformers (T4, 800 fil. trans., T5, 866A fil. trans., T8, dual 6.3 volt fil. trans. for Audio, RF Driver and Osc. unit and T9, and the 10 volt multiple fil. trans. for the Modulators and Power Amplifier.). At the same time the heater for time delay relay K5 is energized. After 30 seconds the contacts of K5 (low voltage time delay) close and this action energizes the primary of T2, the 600/650 volt power transformer. (If the interlock switch S3 is depressed). Along with this sequence of events, the primary of the bias transformer T7, is energized and as the bias rectifier, V5 heats, bias voltage is developed. This will be approximately neg. 280 volts. Listing the functions performed when S5, the filament start button has been depressed, we have -

1. All filaments energized, filament pilot light on.
2. Bias supply energized, neg. 280 volts, developed setting up bias for cathode follower and modulators.
3. 600/650 power supply energized (if low voltage door interlock S3 depressed.) This has energized the plate circuits of the crystal oscillator, first IPA and RF driver and if they are correctly tuned, there will be grid drive to the power amplifier. Also the 600/650 volts has been applied to the Input Audio and Cathode follower stage.
4. High voltage time delay relay K4 heated and its control contacts closed. (After primary of T2 is energized.)

Plate contactor K2 is located next to the filament contactor, near the lower part of the panel and shelf assembly. If the high voltage door interlock switch, S4, is closed and high voltage time delay relay K4 is heated and its contacts closed it would be possible to energize this plate contactor K2 by depressing the plate start button located just beneath the meter column. When plate contactor K2 closes, several operations occur.

1. The high voltage plate transformer T1 primary is energized, developing high voltage (2500 volts approx.) for P.A. and modulator plates.
2. The two blower fans operate.
3. Plate pilot light energizes.

This would place the transmitter on the air.

1. Bias Power Supply

It is made up of a combined filament and plate transformer T7, working in conjunction with bias rectifier V5, a 5R4GY, filter choke L6, filter condenser C6 and associated resistors and potentiometers. The bias potentiometers R1 and R2

indirectly vary the modulator bias, by controlling the cathode follower bias and thus the current flow, through the cathode follower cathode resistors R11 and R12. There is applied a negative 280 volts between these resistors and ground. An opposing voltage of approximately 210 volts is developed by current flow through R11 and R12, thus putting the difference (about 60/70 volts) on the grids of the modulators.

This supply energizes when the filament start button is depressed.

## 2. 600/650 Volt Power Supply.

This supply makes use of a pair of 866A rectifiers, the filaments of which are heated by transformer T5. The primary of T5 is energized at the time the filament start switch is operated. Approximately 30 seconds after the filaments are energized, the low voltage time delay relay K5 has heated and closed its contacts, this causing the primary of T2, the 600/650 volt power transformer to energize (if the low voltage door interlock switch S3 is closed) develop approximately 600 volts D.C. after being rectified by V3 and V4 and two 866A rectifiers. This voltage is applied to the M5422 oscillator unit through a dropping resistor R9 which reduces it to approximately 195V. The 600 volts is applied to the RF driver after passing through the auxiliary secondary winding of the modulation transformer, T3. Also this same voltage is applied to the audio input/cathode follower stages. The primary of this power transformer (T2) is fused by a small fuse F4, of 3 ampere size.

High voltage for the modulators and power amplifier approximately 2500 volts is developed by a power supply consisting of main power transformer T1, 8008 filament transformer T4, swinging choke L1 and filter capacitor C2. These components are located in the base of the transmitter along the left hand side and toward the front. This high voltage supply is interlocked with the front panel grill and interlock switch S4.

Provisions have been made to operate the Gates BC-1T transmitter by remote control. These connections are clearly shown on Gates overall Schematic E-25534. It is necessary to remove the jumper wire that normally connects between contact #1 and #3 on the filament start contactor K1, and wire normally connected between T1-10 and T1-22.

For shipping purposes, some components have either been removed or mechanically made secure within the cabinet proper. All of the removed items are boxed and the carton containing them is shipped within the cabinet. The following items have been removed -

1. All Vacuum Tubes.
2. Time Delay Relays, K4 and K5.

Contacts of the filament and start relays have been held firm by use of paper and tape. Tube caps and parasitic suppressors have been taped down to prevent damage by vibration during shipment. Certain Components have been supported by wooden braces. All of this material should be removed from the transmitter, care should be taken to see that all relays are free of foreign material that would prevent them to operate normally. The connections to the various components that have been removed are clearly tagged for easy and correct replacement. Remove extra coil bracing from L13 which is located in the top, at rear. Check all mechanical connections for tightness.

Replace all vacuum tubes, crystals and time delay relays in their correct sockets, check locations by reference to overall Schematic E-25534 and the various pictures that are supplied as a part of this instruction book.

At this time do not place the plate caps on the 866A rectifier, V3 and V4 and the 8008 rectifiers, V1 and V2.

The external connections are few and these are easily made to the BC-1T transmitter. The 230 volt, 50/60 cycle AC enters the cabinet base at the right hand side, near the rear corner. The two primary wires connect directly to the fuse block XF1. The shielded audio input pair enters the cabinet at the right hand side near the front. These connections are made to the terminals #29 and #30 on TB1. A ground is close by on terminal #28.

The modulation monitor connects to TB2 1 & 2. This terminal board is located on the back side of the tuning and loading panel, at the left front side. This connection can be made with coax cable, such as RG/62U.

The frequency monitor connects to TB1-27 and 28, the ground being terminal #28. This connection can be made of shielded single conductor wire, or low impedance line such as RG/62U.

A ground stud is provided on the cabinet frame for a transmitter ground connection. Located near the modulation transformer, T3, this connection facilitates the grounding of the transmitter to the overall station ground system. A copper strap can be brought in through the access hole in the right rear base section of the transmitter. (The AC primary wires were brought in through this opening also). This internal ground follows up the cabinet support and finally connects to the aluminum PA tuning assembly at the top of the cabinet.

The RF output termination is a ceramic feed through insulator located close to the output coil L14. Connection can be either made from the top of the cabinet through an access opening, or the low impedance line can be brought in through the base of the transmitter and connected to the output circuit.

A word of comment here, concerning the station ground system. It should be constructed as good as can be, all connections well made and soldered, or preferably brazed. It is wise to bond all electrical conduit, metal frame work of building, water piping, etc. to the over-all ground system. If these suggestions are followed, there will be less trouble over the years as the ground system ages.

## SECTION V

### INITIAL TUNE-UP OF THE GATES BC-1T

Before proceeding with the initial tune-up of this transmitter, it would be well to re-check the necessary things to be done, before any voltage is supplied. Briefly, check the following list.

1. Proper primary line voltage connected to fuse block XF1, two 30 ampere fuses should be in the clips of this fuse block.
2. Proper location of all tubes in sockets. These tube locations can be checked by reference to the stencilling in the transmitter and to information furnished in this instruction book. Also make sure the crystal or crystals are in the oscillator crystal sockets. If only one crystal is used, be sure the crystal selector switch S1 is in the correct position to operate with the one crystal.
3. Check to see that all tie-down twine and other material used in shipping the transmitter, has been removed from the various components, especially the relays.
4. Re-check all components that were installed. Be sure they are connected correctly. The parts and the connectors have been tagged to insure correct replacement.
5. Go over the complete transmitter, checking the tightness of all nuts and bolts, terminal connections, etc.
6. Give all soldered connections a brief looking over. The equipment has passed several rigid inspections during its course of manufacture, but something may have been overlooked that could cause trouble in the future.
7. Make certain the transmitter and associated equipment is well grounded.
8. It is suggested that all audio input wiring be shielded and placed in conduit or wiring troughs, away from A.C. wiring.
9. Be sure the plate leads to the 866A and 8008 rectifier tubes are not placed on the tubes, and that they are free from grounding. This will insure the fact that no high voltage will be present until needed.
10. Make sure the dummy antenna is correctly connected to the output circuit. If the change over switch is in the dummy antenna position (lower two clips on switch) the switch blade

will be depressing the microswitch, S2, closing its contacts and this in turn causing the warning lamp to flash. (This feature was added to the transmitter in an effort to eliminate any possibility of the operator leaving the transmitter connected to the dummy antenna after a long night session of maintenance. This lamp will flash as long as the transfer switch is in the lower position and as long as the filaments are energized in the transmitter.)

Lets go through the procedure to tune the Gates BC-1T to 1400 KC. The crystals should be for 1400 KC and so marked. All fuses should be in their correct mountings and 230 volts 50/60 cycle AC should be connected into the transmitter. Use extreme care during tune-up, as there are high voltages developed within the transmitter which could cause death if a person should come in accidental contact. Two door interlock switches are provided on S3, in series with the 600/650 volt power transformer, T2 primary, the other interlock switch S4 being in series with the coil of the plate start contactor of the high voltage circuit.

Place the plate caps on the 866A rectifiers. Depress the filament start switch on the transmitter front panel. This will cause filament relay K1 to pull in and in turn energize all filament transformers (T4, 8008 rectifier fil., T5, 866A rectifier fil., T8 dual 6.3 fil. for 6BG6G's, T9, dual 10 volt PA and mod. fil. and T7 the bias, fil. and plate). At the same moment, time delay relay K5 will heat and after approximately 30 seconds its control contacts will close and this will complete the primary circuit of 650 volt power supply. When this 650 volt supply energizes, there will be reduced plate potential (approximately 195 volts) going into the M5422 crystal oscillator unit, being dropped down by series resistor R9. The combined tube current drain as indicated by the multimeter when selector switch is set on "plate Cur. osc/buf" will be on the order of 20 to 25 ma. The oscillator circuit itself is untuned, the buffer (or 1st IPA stage) is tuned to frequency by means of a slug in coil L3 and capacitor, C9. This stage can be accurately tuned by setting the multimeter switch on "RF Driver Grid" position and then adjusting L3 and C9 for maximum grid current on the multimeter. See BC-1T Tuning Chart, Dwg. 30604. This will be on the order of .3 to .5 ma. Now set selector switch to "RF Driver Cath." and tune the RF driver tuning control, C7 for minimum cathode current. This current may run from 150 to 200 ma. depending upon frequency, loading, etc. Please note that on 1400 KC no RF driver tank padding condenser is used. For frequency determining parts and frequencies where they are needed throughout the transmitter please refer to Gates Dwg. 30604 entitled "Tuning Chart". With these readings already obtained, set the multimeter selector switch to "PA Grid." There should be approximately 120 to 160 grid ma. flowing depending again on frequency, tuning, loading, etc. At this point set the multimeter selector switch to "Input Audio Cath". The multimeter should indicate from 5 to 10 ma. in this position.

At this moment there is grid drive to the Power Amplifier indicating that the complete front end of the RF section is operating satisfactorily. Also, the audio portion has been energized, and the bias

supply delivering bias to the cathode followers and subsequently to the grids of the modulators, (at this point, the bias voltage could be checked). See Gates Schematic C77711, Audio Input/Cathode follower Schematic, or Dwg. E25534, the overall schematic. Terminal lug #11 will have minus 280 volts on it, as measured from this terminal (#11) to ground. This is normal voltage, it can vary somewhat from transmitter to transmitter in production. The right side of the transmitter cabinet would have to be removed for this check, be sure to replace before continuing the tune-up.

At this time in the tune up procedure it would be advisable to turn each bias control, R1 and R2 completely counter clockwise as far as they will go. This would be to the "MAX" position, which would in turn place maximum bias voltage on the two 833A modulators. This will be on the order of 80 volts or so, enough to cut the plate current off on the modulators. Now shut the transmitter down by depressing the Fil. Stop Switch, S6. This will remove all voltages from the transmitter. Again refer to the Dwg. 30604 entitled "Tuning Chart BC-1T". From the chart check the active turns listed for P.A. tank coil L12, for coil L13 and for output coil L14. Adjust each coil to have the same number of active turns as called for, this will be approximately what is required, it may vary one way or the other a few turns. For 1400 KC there will be 15.7 active turns in L12, 10 turns in L13 and 7 turns in L14. The P.A. tank padders will be two .00025 mfd. G2 condensers (C11 and C12), the input loading condenser .003 mfd. (C13) and output loading condenser .003 mfd., (C14). Again these values and turn figures can be checked from the tuning chart, Dwg. 30604. This will give us a starting point from which we can proceed to neutralize and tune up the final amplifier.

We are now ready to check neutralization and P.A. tuning. A grid dip meter, a wave meter with some sort of indicator or a flash lamp connected to a few turns of insulated wire will do as a neutralization indicator. Of course, a very good neutralization indicator is already built in the transmitter, namely, the Power Amplifier grid current meter. Two methods of neutralization will be described; first, that of using the grid current for neutralization indication.

1. Have the dummy load connected to the power amplifier, this is accomplished when the Switch, S3 is in the lower position.
2. Energize all filaments by depressing the Fil. Start Switch. After approximately 30 seconds the oscillator, 1st IPA and 2nd IPA are in operating condition and grid current will be flowing in the Power Amplifier. (The multimeter switch is set on "P.A. Grid Cur" position).
3. Set the neutralizing condenser C10, at maximum capacity. This control is conveniently located on the top front P.A. panel near the right hand lower corner.
4. Adjust the P.A. tank coil L12 tuning by means of the right hand knob on the P.A. panel (Marked "PA Tune") when resonance is reached, the grid current as indicated on the multimeter will dip noticeably.
5. Change the neutralizing condenser setting by a small amount (gradually decreasing capacity) then re-resonate the power amplifier, noting the dip in the grid current. As the correct

neutralizing point is reached, the grid current dip will become less and less pronounced until the complete neutralization is effected, this will be indicated by no deflection of the grid current meter when resonance is obtained. Under these conditions the amplifier should be neutralized for all practical purposes. There are several taps brought out on RF Driver coil L8, as a starting point to the above procedure, use the exact center tap, then if neutralization cannot be obtained, move this grid lead over one tap and repeat neutralizing procedure. A set of conditions will be found that will neutralize the power amplifier satisfactorily.

#### NEUTRALIZING WITH A FLASH-LIGHT BULB.

The same procedure will apply as previously mentioned to provide Power Amplifier grid current. A flashlamp bulb is a sensitive and inexpensive R.F. indicator. The bulb should be connected in series with a couple of turns of insulated wire, approximately the same diameter or a little smaller, than the PA tank coil L12. Place this coil and lamp RF indicator in close inductive relation with L2.

1. Set the neutralization condenser at maximum capacity.
2. Very carefully tune the power amplifier toward the resonance point. It is important to tune slowly because if the resonance point is obtained quickly there most likely will be sufficient RF in the Power Amplifier tank to burn out the flash lamp bulb.
3. Adjust the coupling between the lamp coil and L12 so that the lamp will glow brightly when resonance is reached. Now decrease the neutralizing condenser capacity a bit, the lamp brilliance will decrease, adjust the power amplifier tuning again for resonance which may cause the lamp to brighten up a bit. Continue this operation until the lamp goes out. The amplifier will be satisfactorily neutralized under this condition.
4. Remove the lamp and coil RF indicator from the transmitter. Remember, all of these neutralizing procedures are done with the high voltage removed from the power amplifier. As yet we have not connected the 8008 plate leads to the tubes.

#### DE-ENERGIZE ALL FILAMENTS.

Remove the front perforated screen. Refer to the tuning chart A30604 and check the power amplifier loading condensers C13 and C14 mounted in the top portion of the transmitter. For 1400 KC these capacitors will be a .003 mfd value, for 50 ohm output, also check the tuning chart for approximate number of turns for L13 and L14. Set up these coils in the transmitter according to this information. Place a tube connector on one 8008 rectifier tube. This procedure will allow a partial supply of voltage from the high voltage rectifier system. Place in position the front screen which again closes the two interlock switches S3 and S4.

Start the transmitter again by operating the Fil. Start Switch. After 30 seconds the osc. and buffers will be energized with high voltage and grid current will again be flowing in the Power Amplifier grid circuit. After 10 seconds press the Plate start switch and plate voltage should be applied to the power amplifier and modulators. Adjust the "Power Amplifier Tune" control for minimum plate current as shown on the P.A. plate meter M2. By manipulation of the "P.A. Tuning" Control and the "P.A. Loading" control, adjust the tuning of the amplifier until it is so loaded that the plate current will show approximately 200 ma. on M2 and P.A. Plate voltage will indicate about 900 volts on M3. With this loading condition, the transmitter will be ready for the application of operating high voltage.

Shut down the transmitter, remove the front protective screen.

Place the second 8008 rectifier into the high voltage rectifier circuit by connecting the plate lead to the plate cap.

Replace the protective screen, locking it in place and by so doing closing the door interlocks S3 and S4. Again start the transmitter by operating the Fil. Start Switch. After a 40 second delay press the Plate Start tab. The plate current will now indicate approximately 500 to 550 ma. on the P.A. plate meter, M2, with the P.A. plate volt meter M3 reading 2500 to 2550 volts. With this input the output will be approximately 1000 watts. The normal efficiency to be expected will range just around 70%. With inductive tuning maximum power output does not necessarily occur at minimum Power Amplifier cathode current. A slight de-tuning on one side of resonance will give greater output than when the amplifier is tuned to other side of resonance. Be sure to check this operating requirement. The RF end of the transmitter should be operating satisfactorily, the rated output being dissipated in the built in dummy load. The two fans mounted in the top of the cabinet are operating when the high voltage transformer, T1, primary is energized. They are drawing the heated air out of the cabinet at a rate that will keep the BC-1T transmitter comparatively cool, even when this 1000 watts or more, of output in the dummy load is being released within the cabinet.

It will be remembered that previously the modulator bias controls, R1 and R2, were turned completely counterclockwise (to the indicated "MAX" position). This applied maximum bias voltage to the modulator grids. With the transmitter operating and producing power into the load, now adjust the modulator static plate current. Set the modulator switch, S1, to position marked "Mod. #1". Now adjust the left hand bias potentiometer in clockwise rotation until the modulator plate meter, M4, indicates approximately 40 ma. This will be normal resting current of the #1 modulator tube (V8). Now, place the modulator switch in the right hand position marked Mod. #2. Adjust the right hand bias potentiometer clockwise until the modulator meter again reads 40 ma. This is the resting plate current of the modulator #2 (V9). Now place the modulator switch in the center position marked "Total", the modulator meter, M4, will then read the total static plate current of 80 ma. This modulator cathode current switch makes it possible to balance the modulators easily, while the transmitter is on the air, on program. During a slight lull in programming, the modulator cathode meter, M4, will drop back, and at this time the modulator current switch could be placed in each position quickly and any unbalance detected and corrected.



The meter readings on the transmitter should be somewhat close to those shown on Dwg. A30603 entitled "Typical Meter Readings", included in this instruction book. Remember these are typical and could vary somewhat with no detrimental effect to the operation of the transmitter.

The operator is given a slight control over the plate input by operation of resistor, RL4. The adjusting disc extends through the cabinet support directly in line with the "RF Driver Tuning" control. This control is marked "Plate". Clockwise rotation increases the plate voltage, with a total variance on the order of 200 volts. Directly below the "Plate" disc is the filament resistor control also a disc. This control allows a slight variance in the primary voltage to all filament transformers and to the bias transformer. A filament voltmeter, M1, indicates the voltage on the power amplifier tubes, this normally runs at 10 volts A.C. By use of the filament adjustment control, the voltage on the PA filaments can be kept at 10 volts when this occurs, all filament voltages in the transmitter are correct, as is the developed D.C. bias from the bias supply.

During the time that the transmitter was operating into the dummy load a flashing lamp was operating. This feature was incorporated in the transmitter to prevent the possibility of transmitting into the dummy load by mistake. This has happened. With the light flashing, the engineer will constantly be reminded that he is operating on the dummy and the possibility of going away and leaving the transmitter, so terminated, will be greatly reduced. When tests are over, place the switch S3, in the top position which will connect the transmitter to the stations antenna.

## SECTION VI

### GENERAL OPERATING PROCEDURE

The Gates BC-1T transmitter makes use of vacuum mounted ovenless crystals for the control of operating frequency.

These crystals are capable of holding the transmitter frequency within a range of  $\pm 10$  cycles over the standard broadcast band. There is no adjustment required by the user of this type of crystal assembly, no air gaps, thermostat settings, etc. The only adjustment that may have to be made is the one which allows for "Zeroing in" of the crystal frequency. If the crystal frequency is off a few cycles, it can be brought back to Zero deviation by the slight adjustment of the variable capacitors marked "Freq. 1" and "Freq. 2". These controls will allow about a  $\pm 30$  cycle change at 1600 KC and  $\pm 10$  cycles at 540 KC.

If the crystal adjustments are being made at a new station, there will be no accurate way of setting the frequency to exactly "zero". The station can go on the air with the assurance that the operating frequency will be somewhere within the range of the "Vernier" control, as mentioned above.

The external monitoring source can advise the frequency deviation and the engineer at the station can adjust one crystal to "zero". After the number one crystal has been so adjusted it would be well to adjust the stations frequency monitor to coincide with the transmitter. (The frequency monitor should have been heating a sufficient length of time to stabilize, the information supplied by the manufacturer should be followed).

Once the station frequency monitor has been calibrated and is working satisfactorily, the station engineer has a reliable source of frequency measurement and can from this point go ahead and adjust the second crystal, using the station frequency monitor as a standard.

For the station that has been on the air and has a calibrated frequency monitor in operation, the station engineer can simply make the two crystal adjustments while observing the results on the monitor.

#### Modulation Monitor Connections

The Gates BC-1T transmitter has a small pick-up coil, L15, connected between output coil, L14, and the feedthru insulator, to be used for excitation of a modulation monitor such as the Gates MO-2639. The connections are made to a small barrier strip terminal board TB2, located on the back side of Power Amplifier and Loading front panel, at the left hand side near the bottom. The modulation monitor should be connected to this terminal board by a suitable length of coax cable similar to RG/62U. Entry into the cabinet can be made by means of access holes located in the base of the transmitter.

#### Frequency Monitor Connections

The frequency monitor RF connections are made to terminals #27 and #28 on TB1, terminal #27 being the hot lead, #28 the ground side. The frequency monitor can be connected to these terminals by means of a suitable length of coax cable, such as RG/62U.

Good reliable, day in and day out, service is possible only when the equipment has proper care and maintenance. Set up a schedule of cleaning and inspection, this work, if properly done will minimize the amount of lost air time.

Keep the equipment clean and free from dust. This routine work will have to be done at intervals, depending upon the local conditions, under which the transmitter is operating. The transmitter is provided with two  $10\frac{1}{2} \times 14 \times \frac{1}{2}$  disposable air filter located in the front lower portion of the cabinet. These filters will eventually clog up due to the dust and dirt that normally is pulled into the cabinet by the fans, when this happens replace them. Replacement is easily done, even while the transmitter is operating. When the front door is open,

the tops of the air filters are exposed, they can be removed and new ones inserted while the transmitter is operating.

Periodically check all mechanical connections within the transmitter. Connections may work loose due to vibration, temperature changes, etc. It is well to check ever so often.

Relays can be a source of trouble if not properly maintained. See that armatures operating freely, making sure that no foreign matter can find its way into the moveable parts. The contact surfaces should be inspected and burnished periodically to prevent pitting and heating. If a relay contact burnishing tool is not available, use a very fine grade of sandpaper, sparingly.

Two cabinet ventilating fans are of the permanently lubricated type and do not require much attention, except to keep them free of dust accumulation. A clean fan will move more air, this in turn means a cooler running transmitter.

Printed wiring is used in four sections of the Gates BC-1T transmitter.

- A - M5422 Oscillator Unit
- B - Portion of the RF Driver Stage (M5566)
- C - Input Audio/Cathode follower section. (M5547)
- D - Feedback ladder assembly.

Printed wiring has a very definite place in modern transmitters. In production, all units are uniform as far as wiring characteristics are concerned, servicing of the equipment is made easier due to the manner in which the components are mounted and connected into the circuitry. All printed wiring boards, used in the BC-1T transmitter, have been treated with a silicone varnish on the copper side. This treatment guarantees reliability of operation under severe operation conditions. It is recommended that during the cleaning and maintenance period, these printed wiring sections of the transmitter be cleaned with a soft bristle brush. No other servicing will be required.

Provision has been made in the Gates BC-1T transmitter for easy maintenance and replacement, if necessary, of all meters. The five large 4" meters are mounted on the cabinet assembly vertically along the right hand side. A decorative vertical cover extends the full height of the cabinet, this cover being easily removed, thus exposing the complete meter complement as well as the start/stop switches.

## SECTION VII

### SUMMARY

A radio broadcast transmitter regardless of its size, cannot be fully described, and/or all of the operating problems that arise cannot be fully anticipated and information given in any instruction book. Information has been given that will cover most installations. There has been provided in this instruction book schematics of all pertinent circuits of the Gates BC-1T, photographs, an overall schematic, Gates Drawing E25534, Tuning Charts, Gates Drawing A30604, Typical Voltages, Drawing A30603, and an overall parts list that ties into the overall schematic.

In preparing this instruction book, it has been recognized that the installation engineer undoubtedly, is very familiar with general broadcast procedures and that many of the things referred to in this book are well known to him. It is suggested, however, that the installation engineer and personnel who will operate the transmitter, not only familiarize themselves with the contents of this instruction book, but more important with the transmitting equipment itself.

The Gates Radio Company in designing the BC-1T broadcast transmitter has done everything possible to provide the finest equipment available today. It is not possible to supply the operating location, the actual ground system and, in some instances, the associated equipment that will be used with this transmitter. Because of this, certain things must be left for the user of the equipment to do and certain problems solved. In every instance the use of good engineering practice and sound fundamental reasoning will develop the desired high quality results expected and made possible by this equipment.

It is repeated again, make a good installation, eliminate hasty methods in doing so, you will help to minimize future off-the-air time. Also remember, that cleanliness and "preventive maintenance" for this transmitter will pay large dividends in uninterrupted service. Take some time each week for cleaning the inside and outside of the transmitter and associated equipment, testing tubes, checking all connections and doing the other things that might be classed under the general heading of "preventive maintenance". In case a problem might arise in which the Gates Radio Company could help, do not hesitate to call. Co-operation with users of Gates equipment to help in every way to obtain maximum service and satisfaction, is the aim of Gates Radio Company.

## GUARANTEE

This equipment is fully guaranteed by the Gates Radio Company of Quincy, Illinois, to be free from all defects in materials and workmanship and will be repaired, replaced or adjusted in accordance with the manufacturer's option and terms as outlined below.

- 1 - Gates believes the purchaser has every right to expect first-class quality materials and workmanship and has created rigid inspection and test procedures plus excellent packing methods to assure good arrival at destination.
- 2 - Gates agrees to supply daily factory service, and will make emergency shipments at any time where possible.
- 3 - Gates fully guarantees, under normal and proper usage, all component parts in Gates equipment, except as noted. These parts will be replaced or repaired at the option of Gates as follows:

Transmitter Parts: main power or plate transformer, modulation transformer, modulation reactor, main tank condensers.

(replacements or repairs) - where less than 1 year old...no charge, between 1 and 2 years old 50% or new price

Moving Parts: Guaranteed for six months.

Electron Tubes: Subject to manufacturer's warranty at the time of shipment. Adjustment will be made to the customer as given to Gates Radio Company by the tube manufacturer.

All other component parts: (Except as listed above or below)  
Guaranteed for one year.

Abuse: Damage resulting from an Act of God, or by fire, wind, rain, hail, or any other condition other than normal usage is not covered by the guarantee.

- 4 - Date of invoice to original user-purchaser and date of receipt by Gates Radio Company of notification from the customer will determine the age of equipment or parts.
- 5 - In case of adjustment, as on certain transmitter parts listed above "new price" is Gates' current price at time of replacement and/or adjustment.
- 6 - This guarantee covers only Gates manufactured parts and complete Gates equipments including all parts therein, with exceptions as noted. Any purchased part not manufactured by Gates will be subject to the manufacturer's guarantee, unless such part is a unit incorporated in Gates manufactured equipment.

- 7 - Transcription pickups, regardless of make, are guaranteed for ninety days - said guarantee including every associated part of the pickup except the stylus, which because of its fragility is not guaranteed by Gates.
- 8 - Where the replacement part in question must be supplied under the guarantee before the defective part can be returned for inspection, as might sometimes be required, the customer will be billed in full and credit or adjustment will be given on receipt of the defective part in accordance with this guarantee and the terms herein. In order for credit adjustment to be received in line with this guarantee the defective or replaced part must be shipped prepaid to Gates Radio Company or to any other destination requested by Gates within two weeks of the date of the invoice covering the replacement part. Any item alleged defective shall not be returned to Gates until after written permission has been first obtained from Gates' home office at your request.
- 9 - All shipments under this guarantee will be made f.o.b. Quincy, Illinois and all materials returned will be shipped prepaid by the customer f.o.b. Quincy, Illinois
- 10 - As a material part of this guarantee the customer agrees to employ capable technical personnel to maintain all equipment under this guarantee in good, normal condition, properly serviced and cleaned and to use said equipment as and for the purpose intended by seller. This guarantee does not extend to the supply by Gates of any personnel to make any replacement, repair or adjustment.
- 11 - Gates shall not be responsible for damages to items in transportation or careless handling; or injuries to persons or damage to property arising out of the use or operation of Gates equipment or parts, but Gates will supply repair or replacement items speedily, which will be billed to the customer who, in turn, will place claim with the carrier, with assistance from Gates if necessary and when so requested.
- 12 - Delays in fulfilling any part of this guarantee because of depleted stock, floods, war, strikes, power failures, transportation delays, or failure of suppliers to deliver, or because of Acts of God or any other conditions beyond the control of Gates, does not in any way render Gates liable under this guarantee; however, every effort will be made to render prompt service.
- 13 - Gates agrees that this equipment sold is manufactured, where need be, under Royalty License Agreements with Western Electric Company and Radio Corporation of America.
- 14 - This Guarantee is not transferable from the original user-purchaser, and no right of subrogation is given herein.
- 15 - This Guarantee is effective on all standard Gates cataloged items sold after June 11, 1951.

Gates Radio Company  
Quincy, Illinois

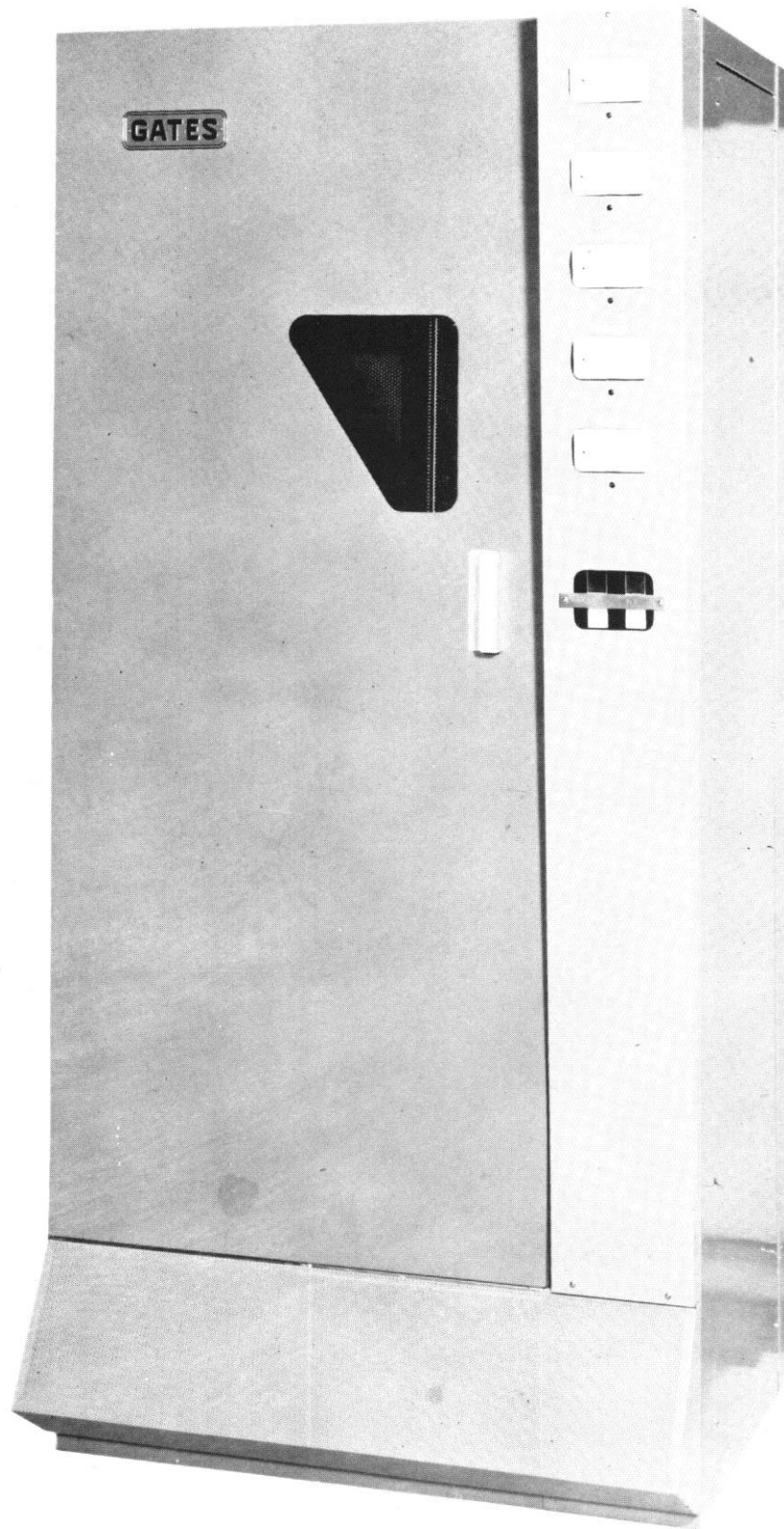

BC-1T, BC500T, BC250T  
A.M. TRANSMITTERS

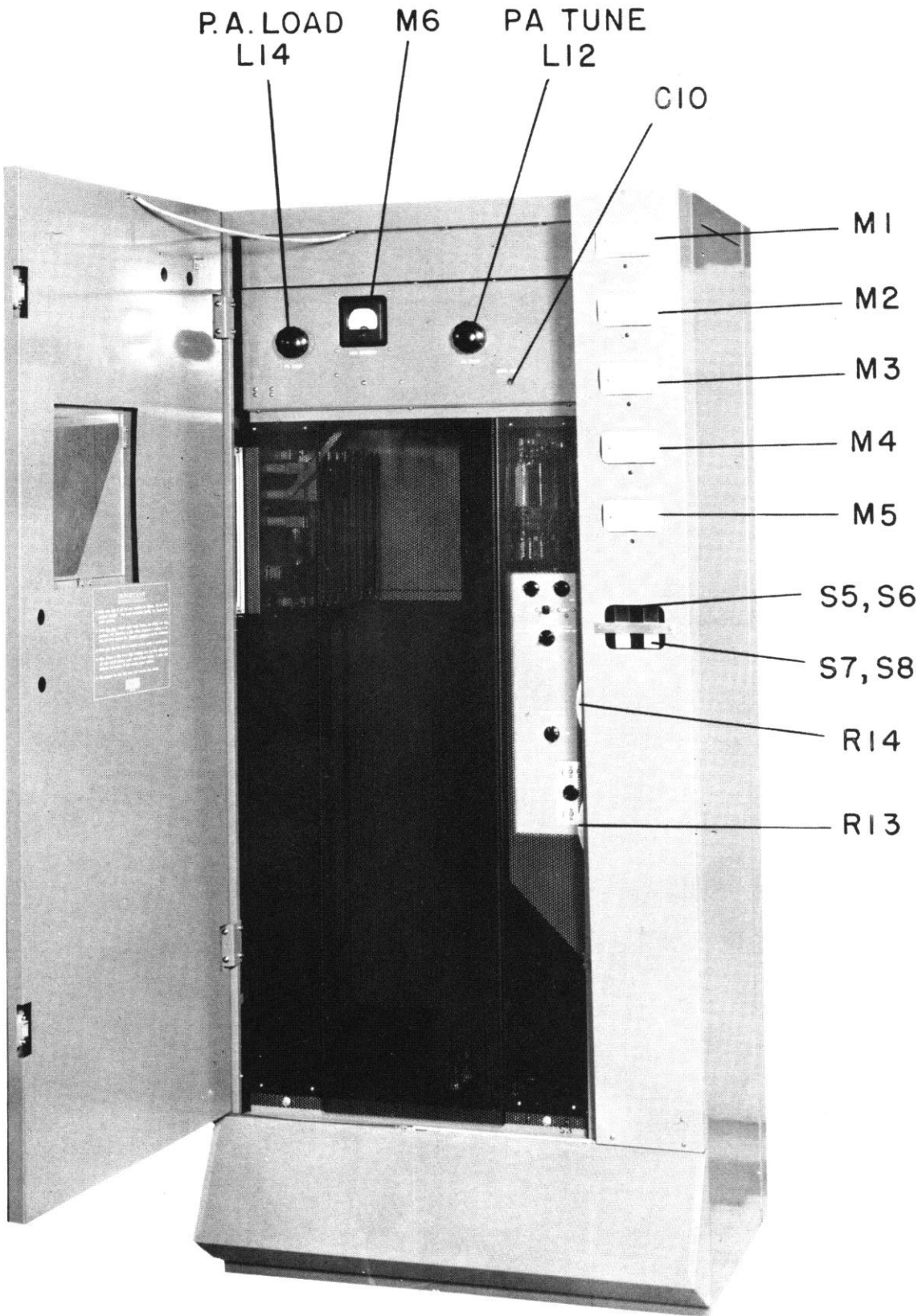

FRONT VIEW, BC-IT  
1000 W. A.M. TRANS.  
M5393



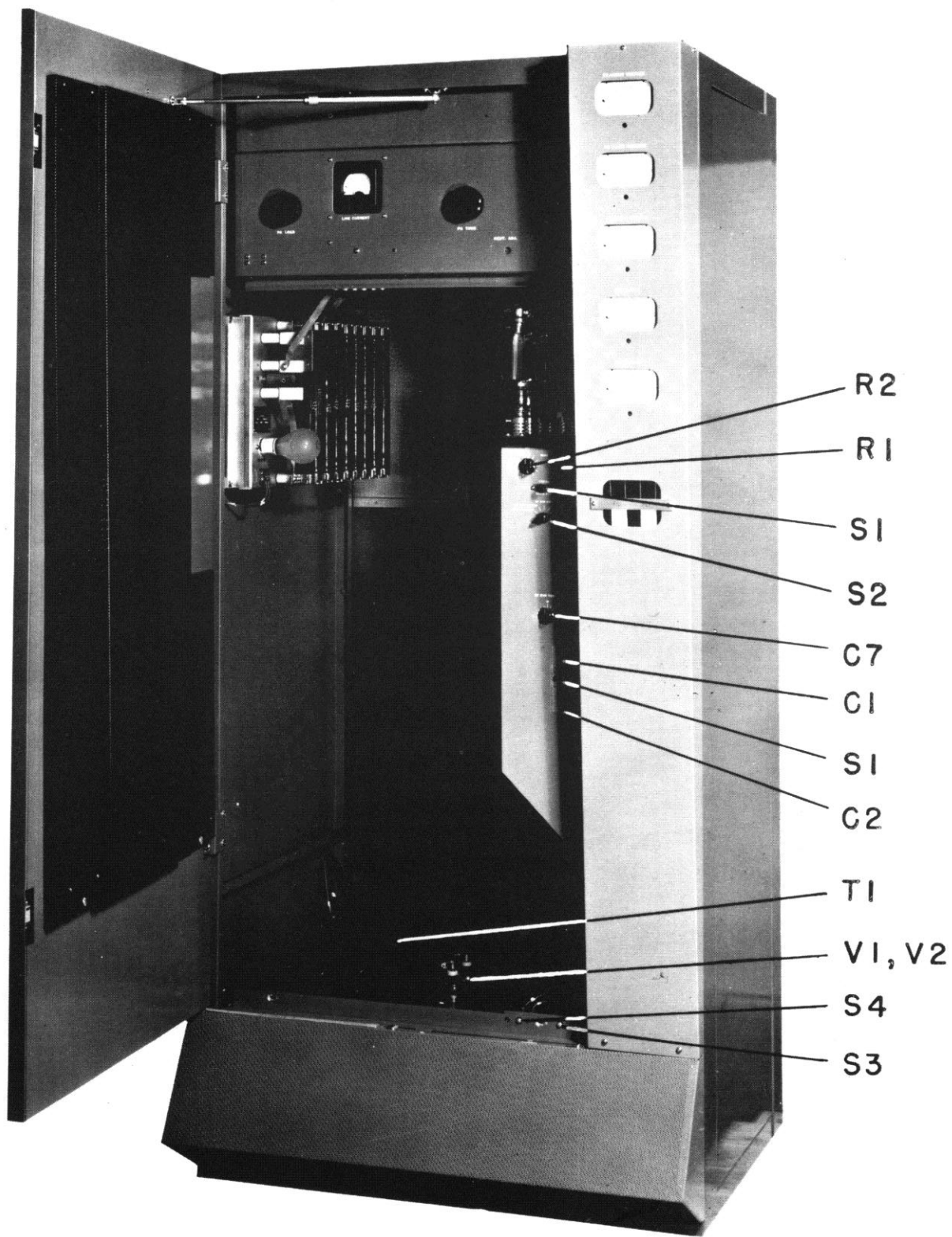

FRONT VIEW, BC-IT  
1000 W. A.M. TRANS.  
M5393

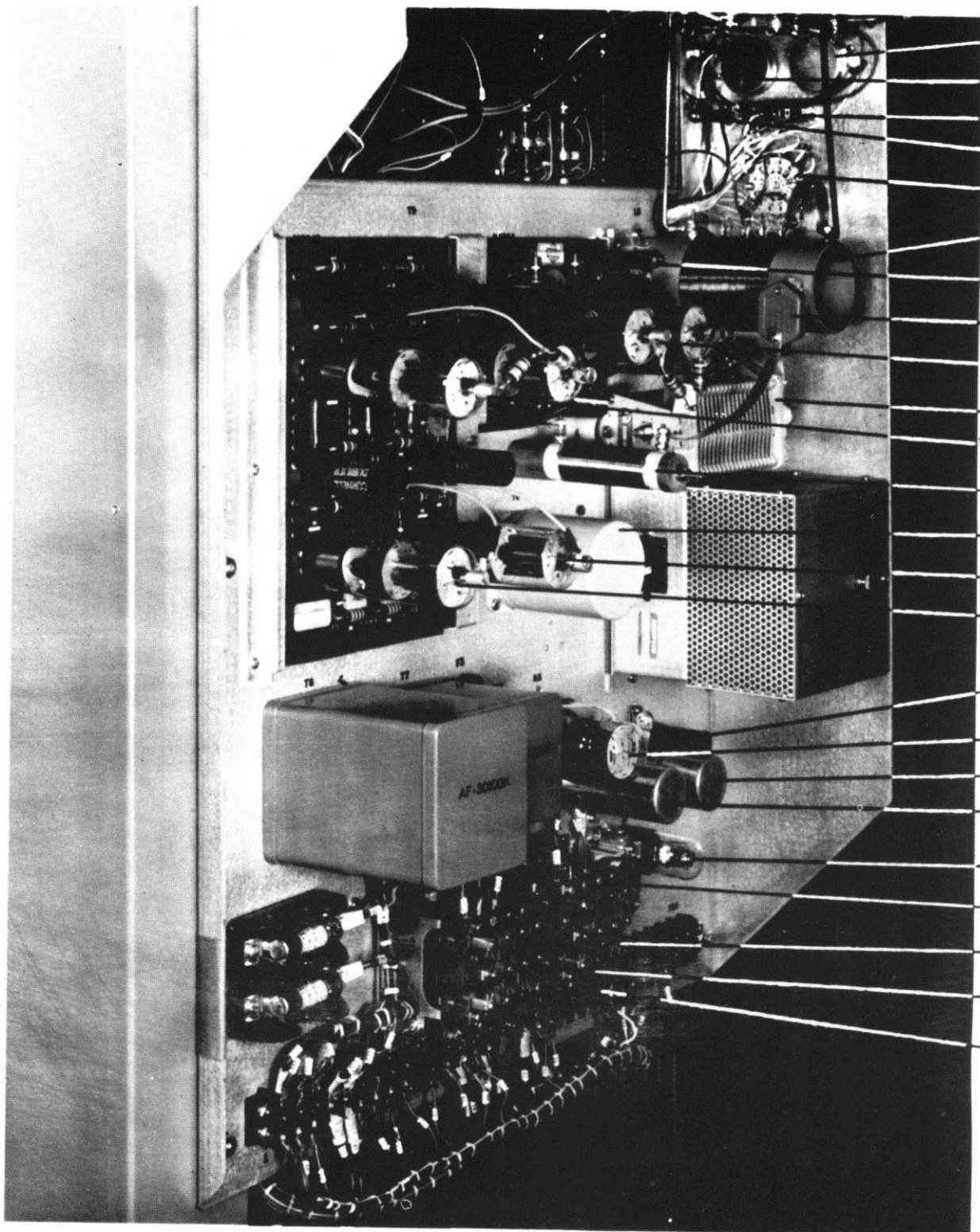

- R2
- R1
- S1
- R6
- S2
- L8
- R2
- C17
- V1,V2
- C7
- V3,V4
- L7
- T6
- V2
- V1
- C18
- V5
- C5
- C6
- K4
- K3
- K2
- K1
- TBI

INSIDE CABINET VIEW,  
BC-1T, BC500T, BC250T  
A.M. TRANSMITTERS

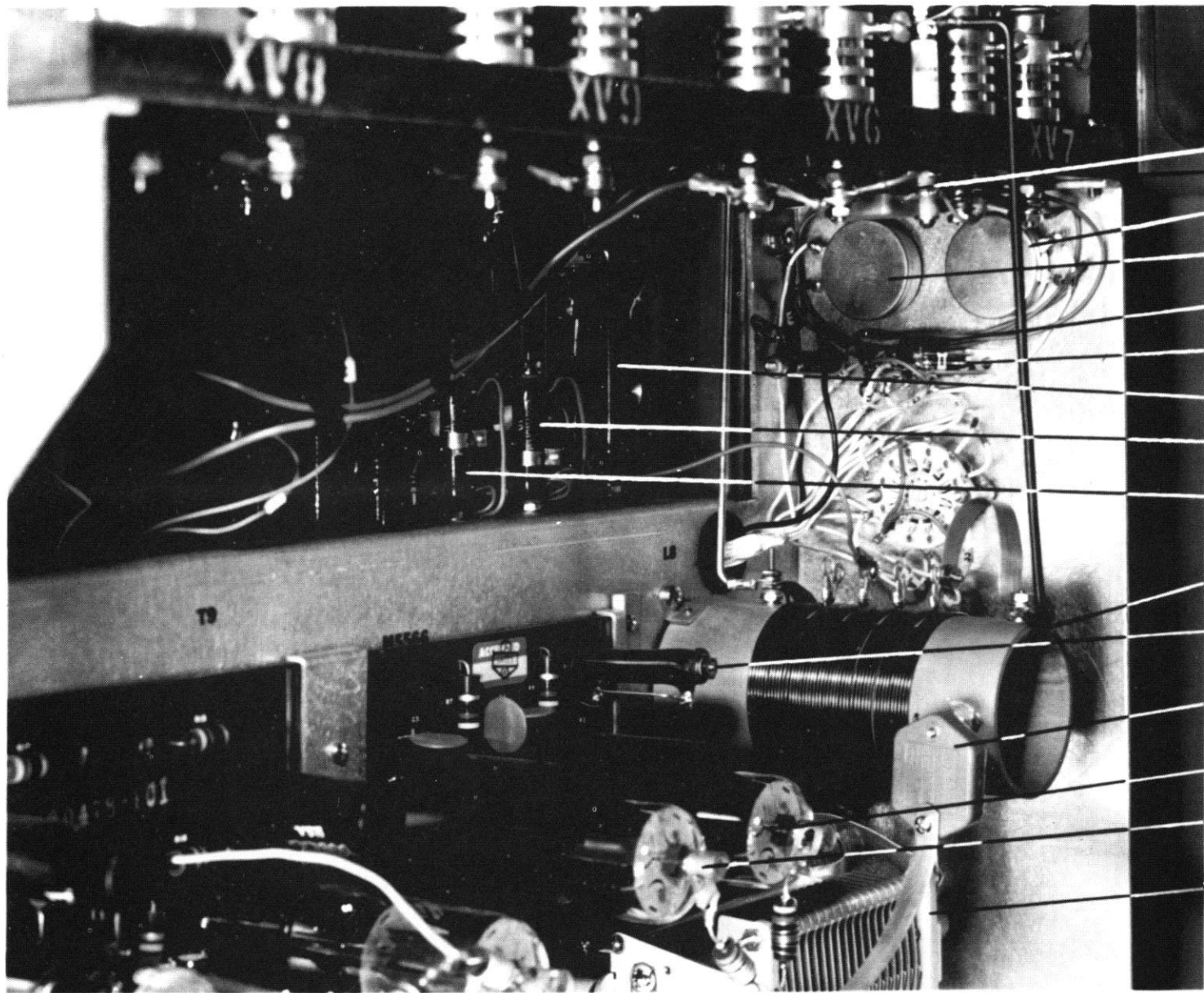

C23  
C24

R2

R1

R6

S1

R7, R8

R22

R21

L8

R2

C17

V2

V1

C7

INSIDE VIEW, BC-1T  
1000 W, A.M. TRANS.  
M5393

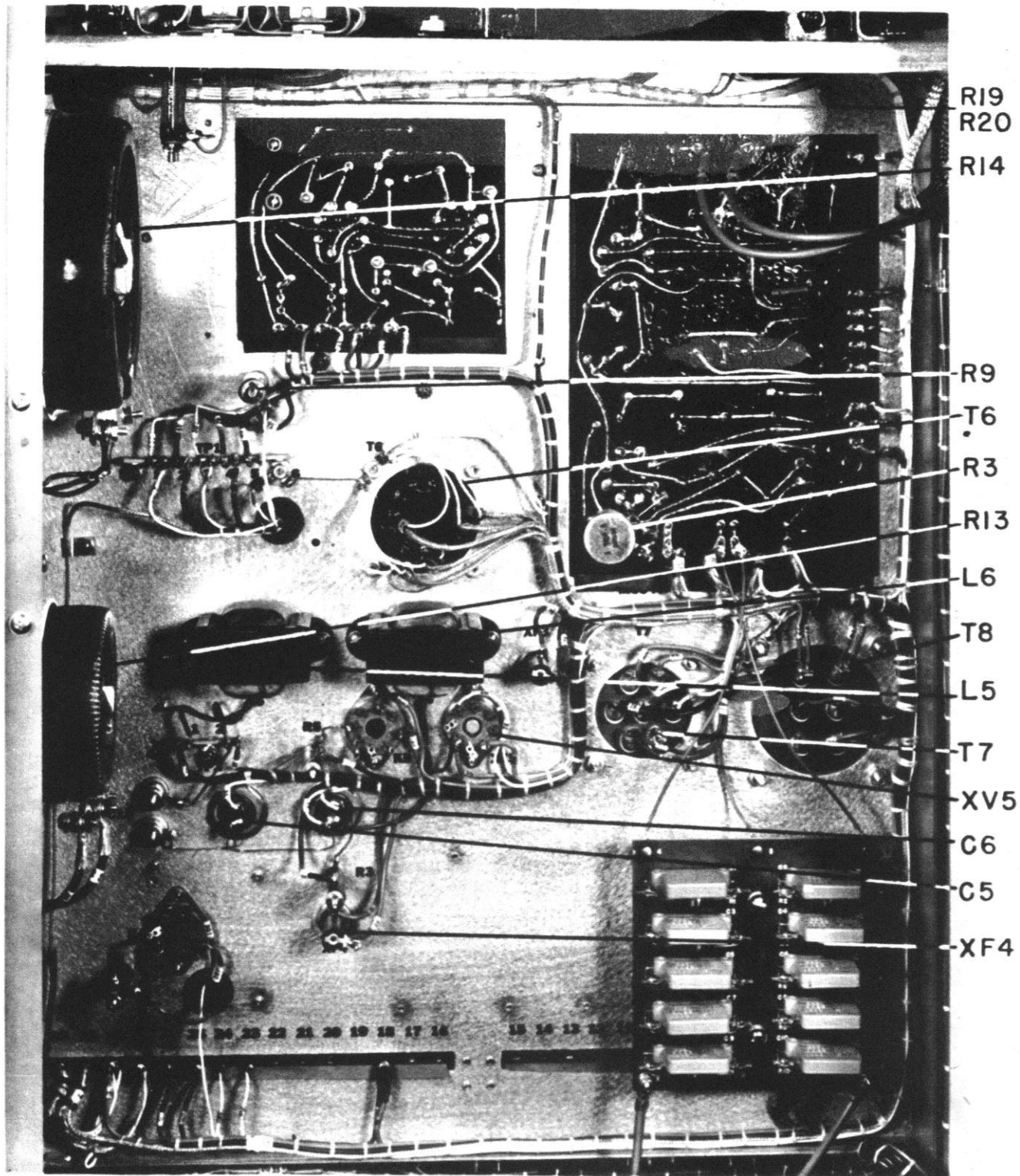

BACK VIEW, PANEL &  
SHELF ASSEMBLY,  
BC-1T, BC500T, BC250T  
A.M. TRANSMITTERS

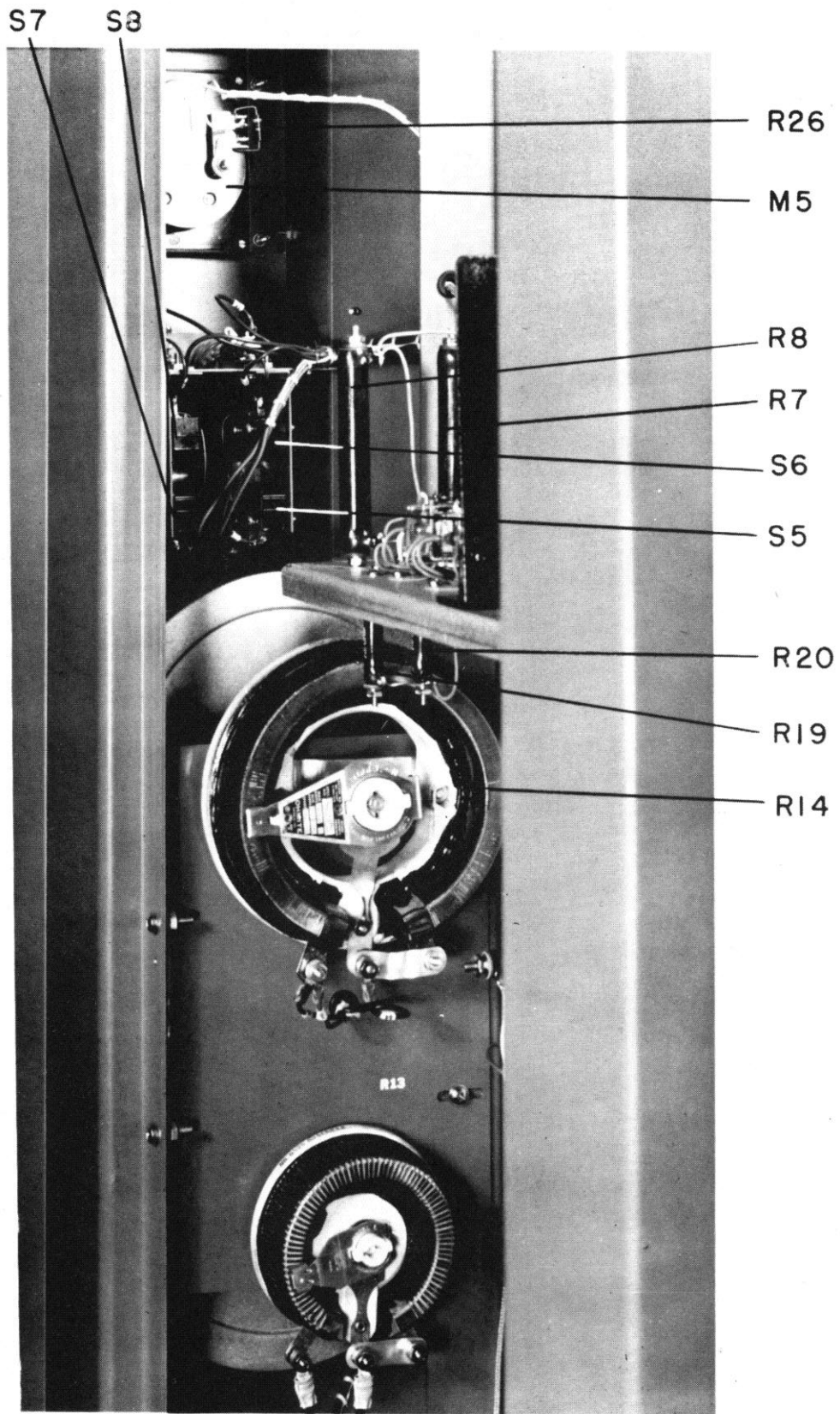

CONTROLS, FIL. & PLATE  
START/ STOP & ADJUST  
BC-1T, BC500T, BC250T  
A.M. TRANSMITTERS

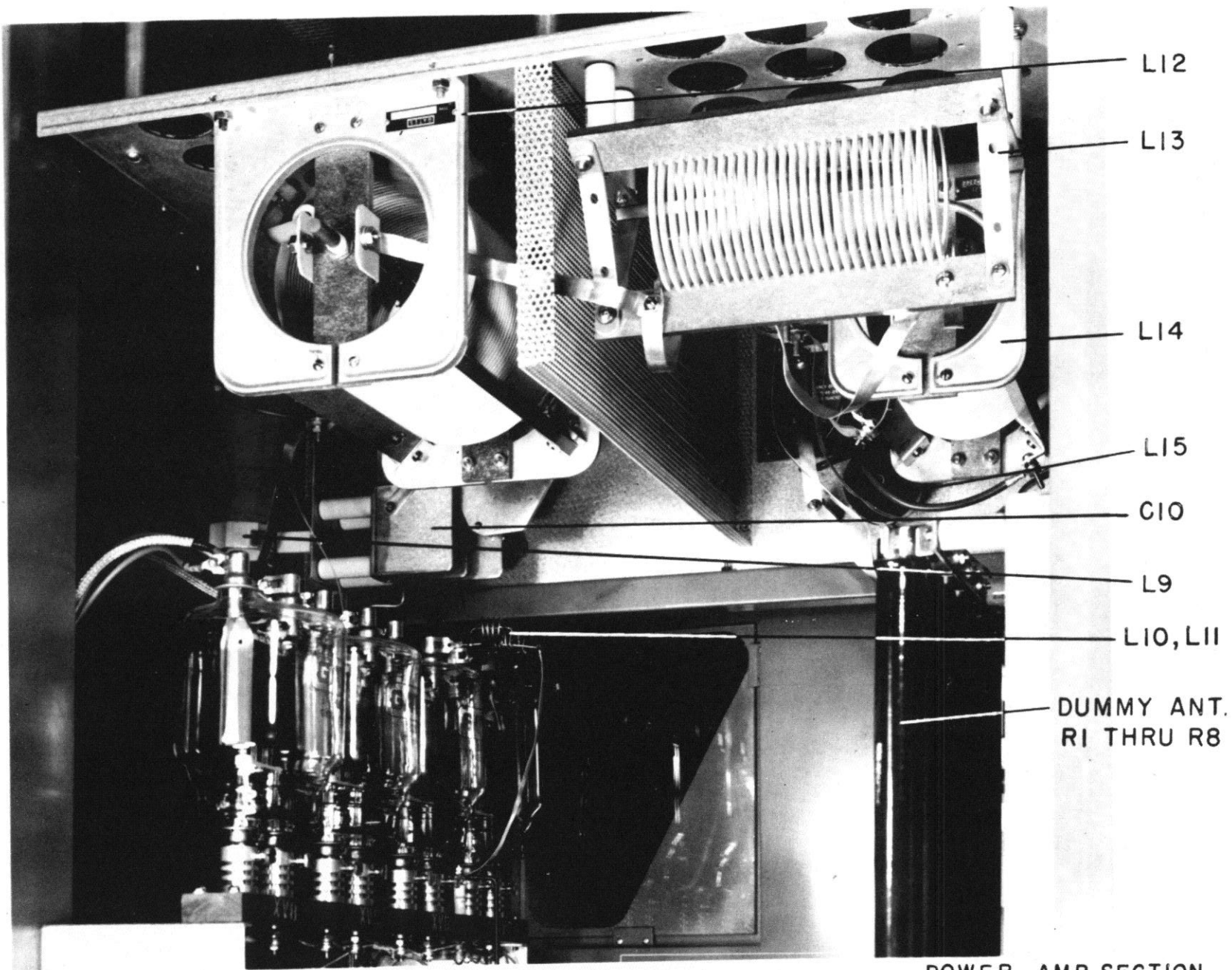

L12

L13

L14

L15

C10

L9

L10, L11

DUMMY ANT.  
R1 THRU R8

POWER AMP. SECTION  
BC-1T, 1000W, AM. TRANS.  
M5393

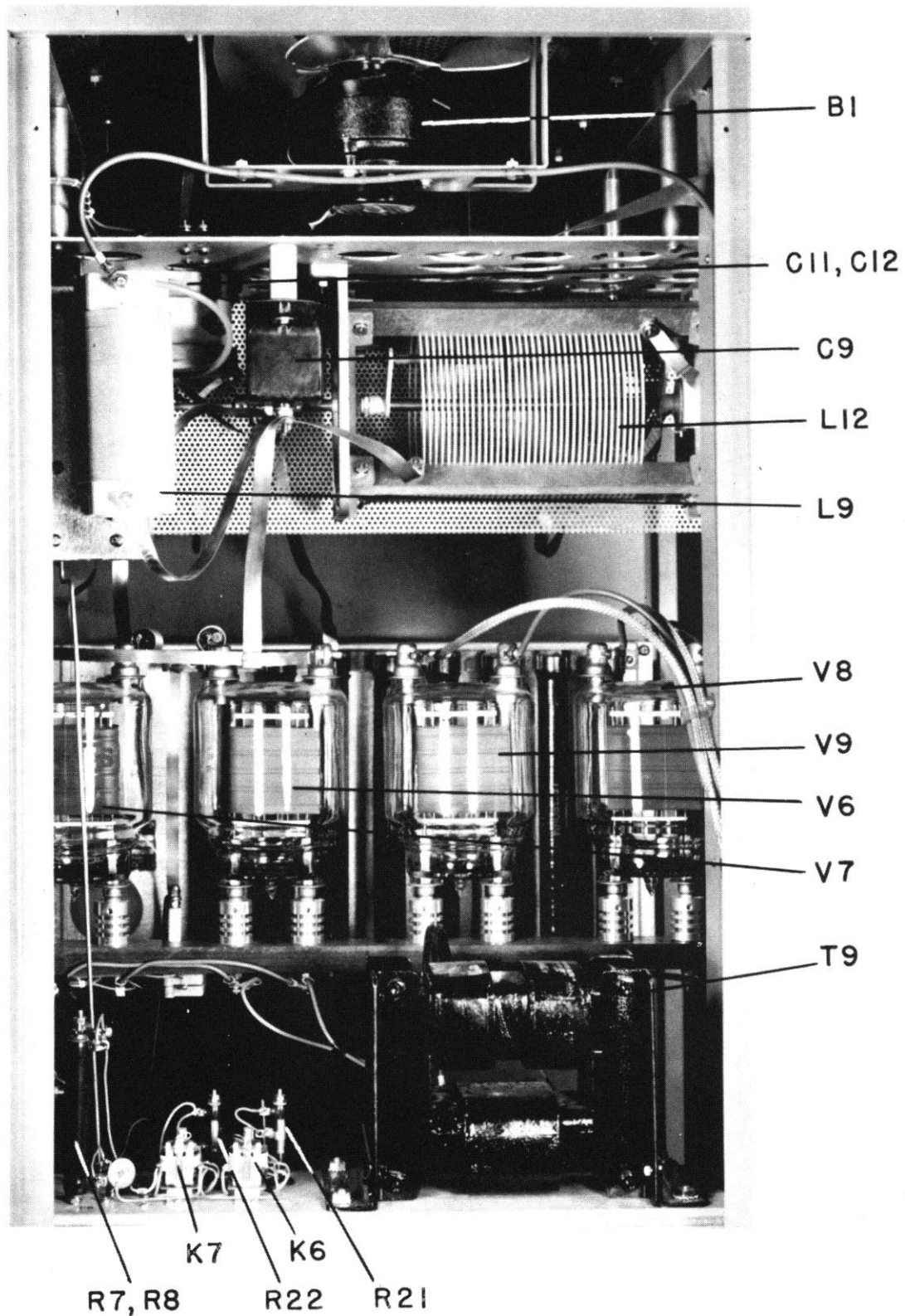

SIDE VIEW, P.A. & MOD. SECTION  
 BC-1T, 1000W. A.M. TRANS.  
 M5393

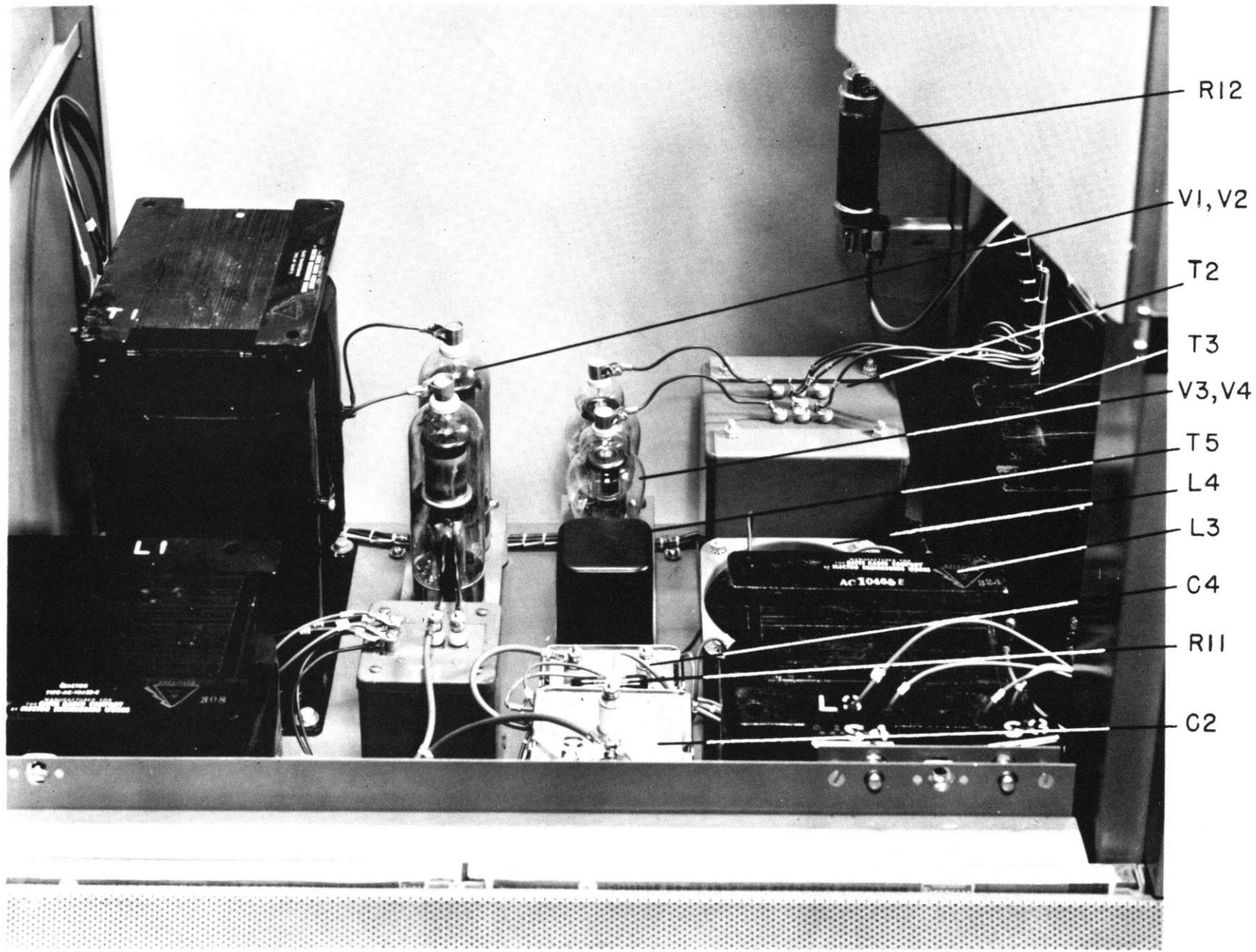

BASE COMPONENTS, FRONT VIEW,  
BC-IT, 1000W. A. M. TRANS. M5393



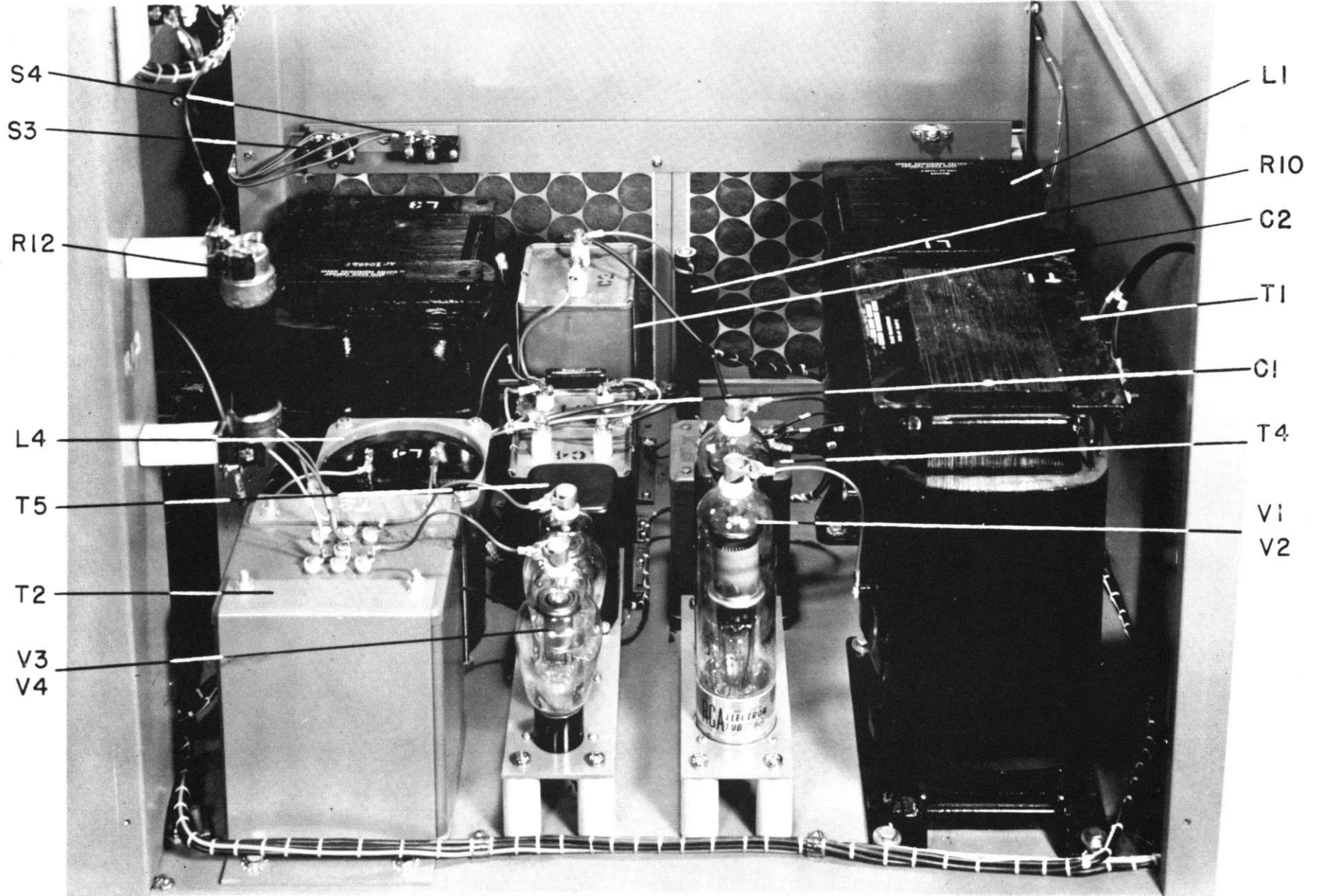

BASE COMPONENTS, REAR VIEW,  
 BC-1T, 1000W, A.M. TRANS. M5393

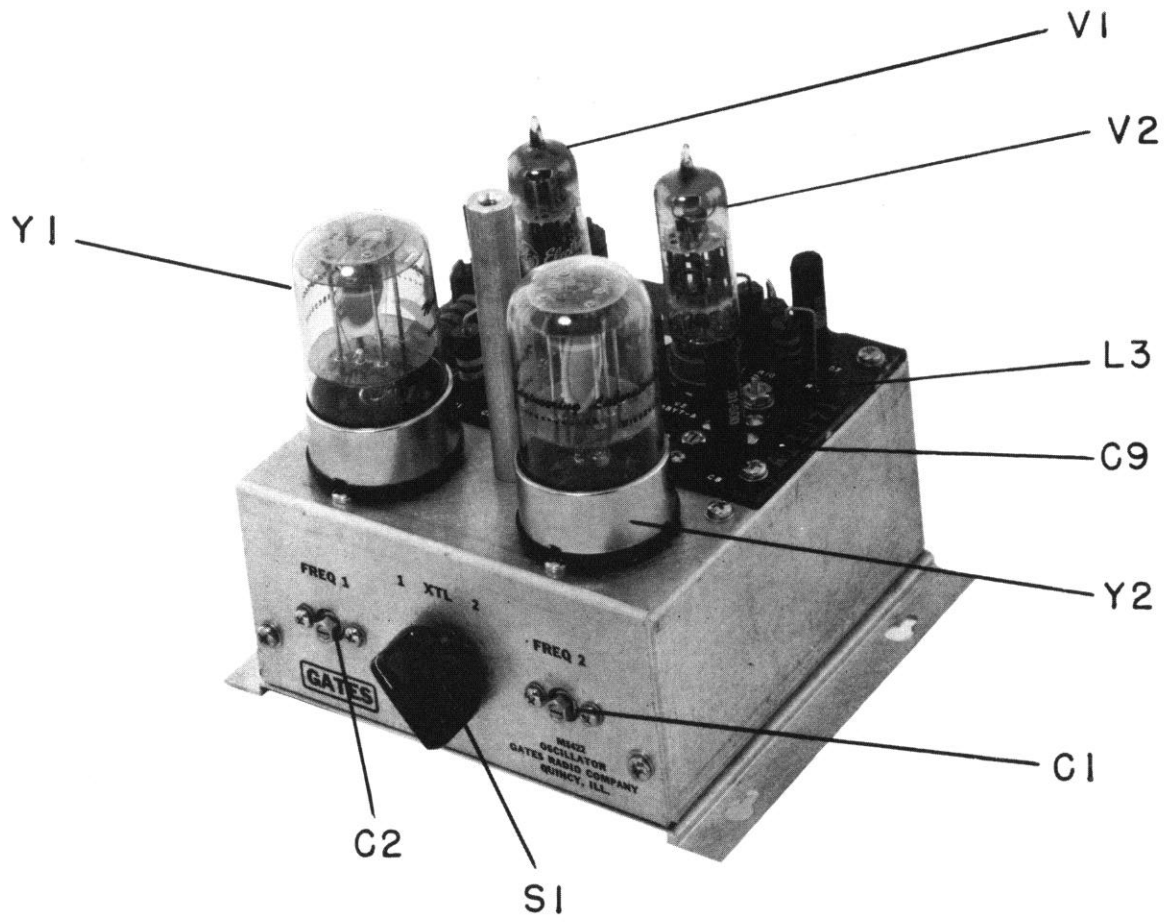

OSCILLATOR UNIT,  
M5422

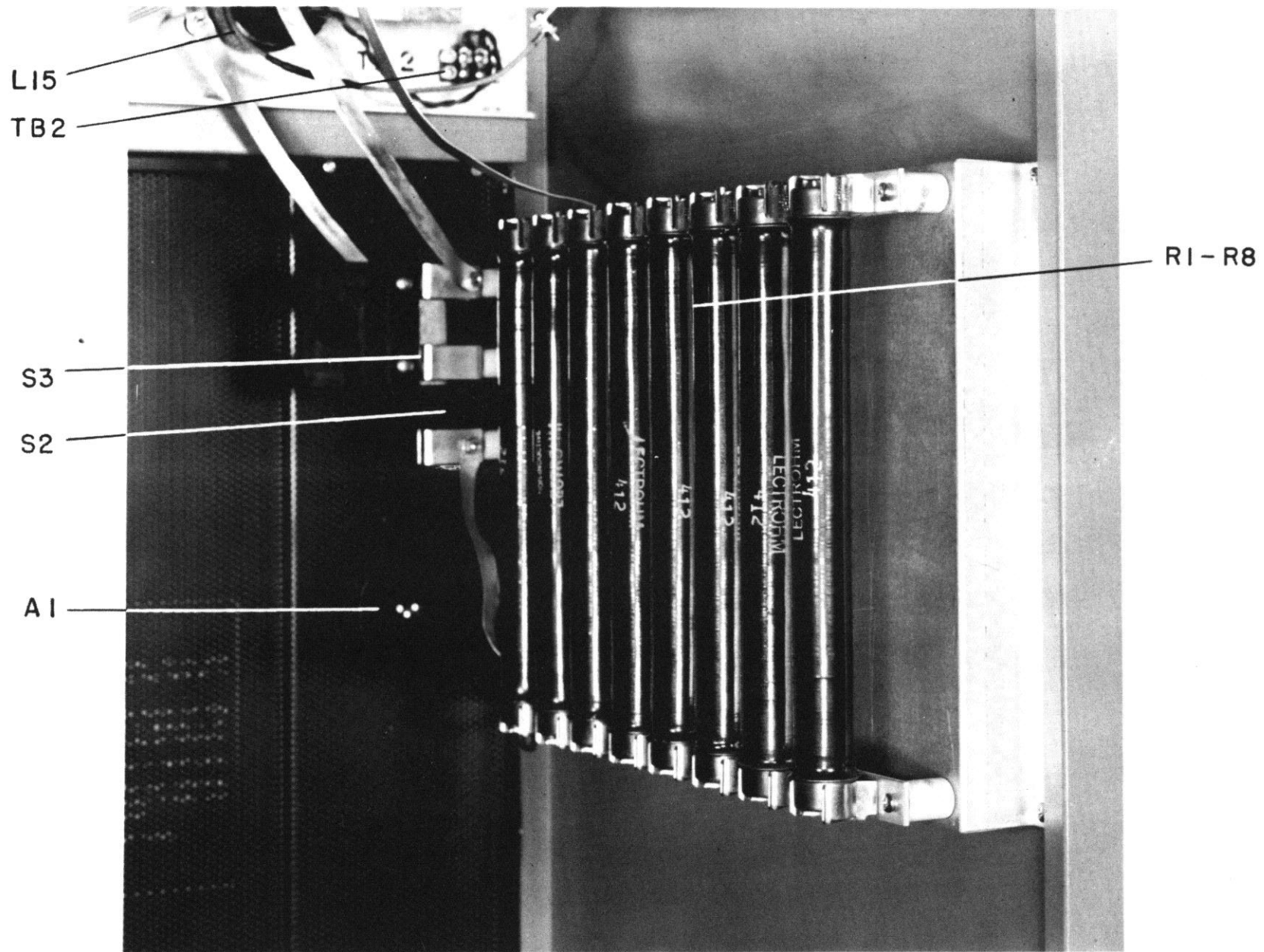

DUMMY ANT. 1KW MOD.  
IN BC-IT, 1KW AM TRANS.

BASIC TRANSMITTER CABINET ASSEMBLY

M5393 BC-1T TRANSMITTER

<u>Symbol No.</u>	<u>Drawing No.</u>	<u>Description</u>
B1, B2	2676-PM-101	Fan Assembly
C1		Cap. Filter, 10 mfd. 1000(W) V.
C2		Cap. Input Filter, 8 mfd. 3000(W) V.
C4		Cap. Coupling, 2 mfd. 3000 V.
C10	C-77697-101	Neut. Condenser Assy.
L1	AC-10458E	Swinging Choke
L2		
L3	AC-10465E	Modulation Reactor
L4		Filter Choke
R10		Res. Bleeder, 100K ohm, 100W.
R11	A-30526-101	Resistor, Bleeder
R12		Precision Meter Multiplier, 3 megohm, 3 KV
R13		Control (Fil. Rheostat) 7½ ohm, 150W.
R14		Control (Plate Rheostat) 400 ohm, 300W.
S3, S4		Interlock Switch
T1	AP-10459E	Transformer (High Voltage)
T2	AP-30097K	Transformer (600 V. Power)
T3	<del>AM-30469E</del>	Transformer (Mod)
T4	AF-10456K	Transformer (Fila.)
T5		Transformer (Fil.)
V1, V2		Tube 8008
V3, V4		Tube 866A
XV1, XV2		Socket (8008 Rectifier)
XV3, XV4		Socket (866A Rectifier)

BASIC METER AND SWITCH PANEL

A1, A2		Lamp
M1		Meter, Fil. Voltmeter 0-15V AC
M2		Meter, P. . Plate Current, 0-1A DC
M3		Meter, P. . Voltmeter 0-1 MADC, W/0-300V Scale
M4		Meter, Modulation, 0-1 Amp. D.C.
M5		Multimeter, 0-1 MADC W/0-30, 0-300 MADC Scale

<u>Symbol No.</u>	<u>Drawing No.</u>	<u>Description</u>
R26	A-10534-101	Multi Meter Series Res. Assy.
S5; S6, S7, S8	C-77705-101	Fil. & Plate Start-Stop Switch Assy.
XA1, XA2		Socket

#### BASIC PA TUNING AND LOADING ASSEMBLY

C8, C9		Cap. .001 mfd.
C11; C12		Cap. (Det by Freq.)
C13, C14		Cap. (Det. by line impedance)
L9		P.A. Plate Choke (Det. by freq.)
L10, L11	A-30910-101	Parasitic Suppressor
L12	105-VB-3735F	Coil P.A. Tank
L13	26-FB-2843F	Coil; Input Loading
L14	30-VB-2344F	Coil, Output Loading
L15	A-10391-102	Monitor Coil
M6	634-0081-000	Meter, RF Line Current, 0-8 RF Amp.
R15, R16, R15A, R15B, R16A, R16B		Res. (Part of L10, L11)
TB2, TB3		Terminal Board

#### BASIC PANEL AND SHELF ASSEMBLY (R.F. Audio, Relay and Bias)

C5, C6		Cap. 4 mfd. 600V Oil Filled
C7		Cap. Plate
C15		Cap. (Det. by Freq.)
C16; C19; C20		Cap. .01 mfd. 1000(W) V.
C21, C22, C25		Cap. .002 mfd. 1200(W) V.
C17		Cap. 1 mfd. 1000V.
C18		Cap. .01 mfd. 600(W) V.
C23, C24		Cap. .01 mfd. 600(W) V.
F1; F2		Fuse 30 Amp, 250V (non-renewable)
F3, F4		Fuse, 3 Amp.
K1, K2		Fil. Plate Start-Stop Relay 230 V.
K3		Master O.L. Relay, 230V, 50/60 Cy.
K4		Time Delay; HV Relay
K5		Time Delay, 600V Relay
K6		Overload Relay, 6V. D.C.
K7	AK-12635	Modulator Overload Relay
L5, L6	0009 000	Choke, Isolation Filter & Bias
L7	A-30518-101	2nd IPA Coil
L8	B-65284-101	Plate Coil

<u>Symbol No.</u>	<u>Drawing No.</u>	<u>Description</u>
P1		Socket
R1,R2	A-3404-6	Bias Control, 10K ohms, 4 W. Wirewound
R3		Res. 5000 ohm; 10W.
R4,R5		Res. 6000 ohm; 10W.
R6		Res. 2500 ohm; 10W.
R7,R8		Res. 5000 ohm, 50W.
R9		Res. 20,000 ohm, 25W.
R19,R20		Res. 7.5 ohm, 10W.
R21,R22		Res. Adj. 10 ohm, 10W.
R23,R24,R25		Res. 3 ohm, 1W, 5%
S1	A-10900-2	Mod. Switch
S2		Multi Meter Switch
T6	AI-3002	Transformer; Audio Input
T7	AP-30098K	Transformer; Bias
T8	AF-30100K	Transformer; Multi-Fil. 6.3V.
T9	AF-30099E	Transformer, Multi-Fil. 10V.
TB1	A-30544-101	Terminal Board Assembly
TP1	B-11729-19	Tie Point
V5		Tube, 5R4GY
V6;V7, V8,V9		Tube, 833A
XF1		Fuse Block
XF3, XF4		Fuseholder
XK4, XK5		
XV5		Socket
XV6; XV7 XV8, XV9	C-77708-101	P.A. and Mod. Socket Assy.

#### FEEDBACK LADDER ASSEMBLY

C1; C2	Cap. .002 mfd. 1200 (W) V.
C3; C4, C5; C6 C7; C8 C9; C10	Cap. .0001 mfd. 1200 (W) V.
R1; R2 R3; R4, R5; R6 R7; R8, R9, R10	Res. 82K ohm, 2W. 5%
	Res. 2.2 megohm, 2W, 5%

<u>Symbol No.</u>	<u>Drawing No.</u>	<u>Description</u>
C1, C2, C3, C4, C5, C6, C7		Cap. .01 mfd., 1000(W) V.
L1 L2, L3	A-30520-101	Choke, 2.5 mh. Parasitic Suppressor
R1 R2 R3, R4, R5 R6, R8		Res.; 12K ohm; 2W. 10% Res.; 250 ohm, 20W. Res. 3 ohm, 1W., 5% Res. 47 ohm, 2W., 10% (Used on L2 and L3)
R7, R9 R10 R11, R12		Res. 47 ohm, 2W. 10% Res. 15K ohm, 20W. Res. 20 ohm, 1W. 5%
V1, V2		Tube 6BG6G
XV1, XV2		Socket

AUDIO INPUT AND DRIVER PRINTED CIRCUIT  
ASSEMBLY

C1, C2 C3 C4, C5 C6, C7 C8 C9 L1, L2	A-30531-101	Cap. .00027 mfd. Cap. .47 mfd.; 400V. Cap., .22 mfd; 600V. Cap.; .33 mfd; 600V. Cap., .01 mfd. 1000(W) V. Cap., .0001 mfd. Parasitic Suppressor
R1, R2 R3 R4, R15, R16 R5 R6, R7 R8, R9 R10 R11, R12 R13, R14 R19, R20 R21 R22, R23  R17, R18	A-3404-8	Res., 33K ohm, 2W. 10% Control, 1000 ohm Res.; 82K ohm, 2W. 10% Res., 120K ohm; 2W. 10% Res.; 100K ohm; 2W. 10% Res.; 470K ohm, 2W. 10% Res.; 10K ohm; 2W. 10% Res.; 10K ohm; 10W. Res.; 47K ohm, 2W. 10% Res. 20 ohm, 1W. 5% Res. 8200 ohm, 2W. 10% Res. 47 ohm, 2W. 10% (Part of L1 and L2) Res. 47 ohm, 2W. 10%
V1, V2 V3, V4		Tube, 6BG6G
XV1, XV2 XV3, XV4		Socket

1KW DUMMY ANTENNA

<u>Symbol No.</u>	<u>Drawing No.</u>	<u>Description</u>
A1		Lamp, 60W. 230V. (Mounts in S1)
R1;R2;R3; R4;R5,R6, R7,R8		Res., 412 ohms, 190W. non-inductive
S1		Winker
S2		Micro Switch
S3	A-4938-101	Shorting Blade and Handle Assy.
TB1		Terminal Board
XS1		Socket

11/18/57



M5422 OSCILLATOR UNIT FOR AM TRANSMITTER

<u>Symbol No.</u>	<u>Drawing No.</u>	<u>Description</u>
C1, C2	A-30316-101	Variable Cap.; 3.9-50 mmfd.
C3		Cap. 24 mmfd.; 500 (W) V.
C4		Cap. 330 mmfd. 500 (W) V. ✓
C5, C7, C8		Cap. .01 mfd. 600V.
C6, C11		Cap. 100 mmfd.; 500 (W) V. ✓
C9		Variable Cap. 6.7-140 mmfd.
C10		Cap. 100 mmfd. 500 (W) V. ✓
J1		Receptacle
L1, L2		R.F. Choke, 2.5 mh.
L3		Variable Coil, 105-200 mh.
R1, R6	Res., 100K ohm, 2W. 10%	
R7	Res., 150 ohm, 2W. 10%	
R3, R9,	Res., 27K ohm, 2W. 10%	
R10, R11	Res. 15K ohm; 2W. 10%	
R4	Res. 10K ohm, 2W. 10%	
R5, R8	Res. 1000 ohm, 2W. 10%	
R12	Res. 47K ohm; 2W. 10%	
R13	Res. 10 ohms, 1W. 5%	
R14	Res., 3900 ohm, 2 W. 10%	
R2	Rotary Switch	
SI		
V1, V2	Tube, 12BY7A	
XV1; XV2	Noval Socket	
XY1, XY2	Crystal Socket	
Y1, Y2	Crystal	

				FIRST MADE FOR	GATES RADIO COMPANY QUINCY, ILLINOIS			A 30585	
				GR. NO.	LIST OF PARTS			SCALE $\frac{1}{8}'' = 1''$	
104	103	102	101	ITEM	REFERENCE	PT. OR G.N.	FIN.	DESCRIPTION	MATL.

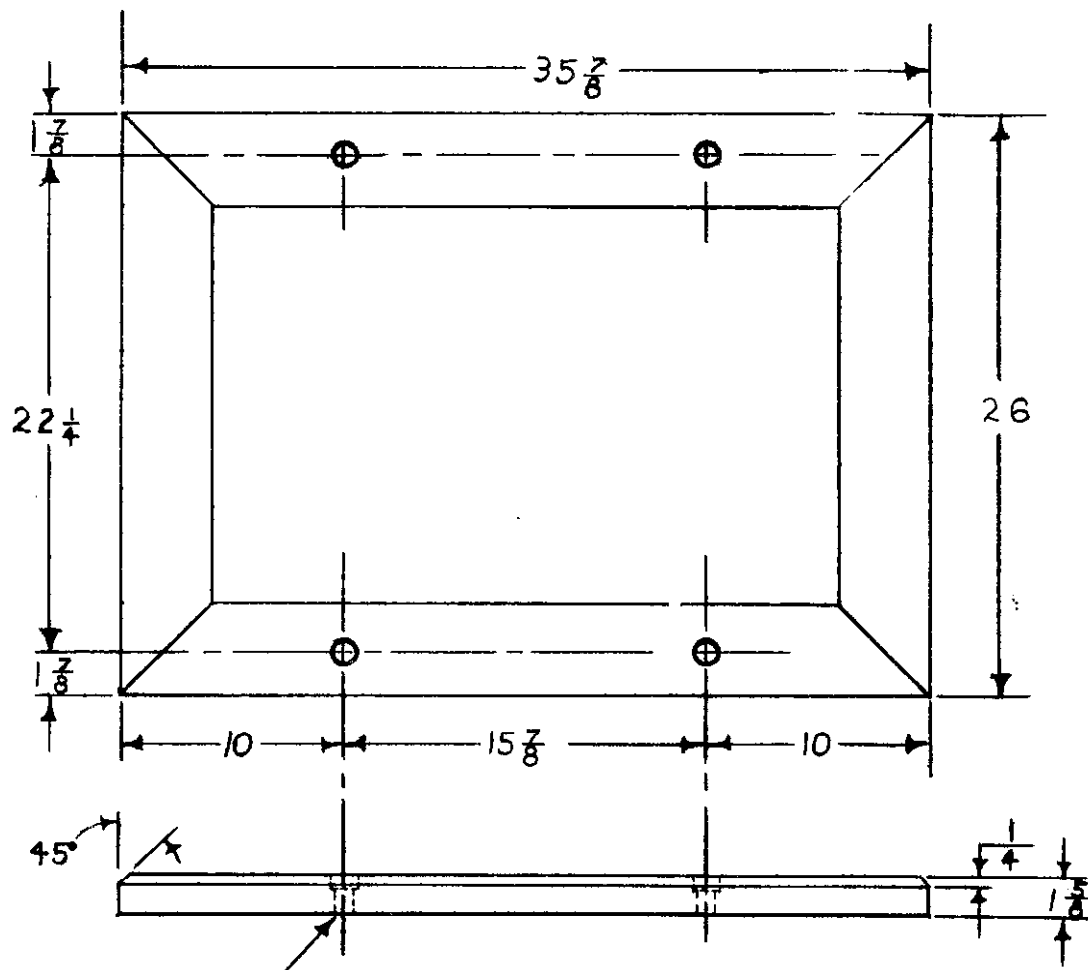

DRILL & CTR'BORE  
TO CLEAR  $\frac{1}{2}''$   
FOUNDATION BOLT

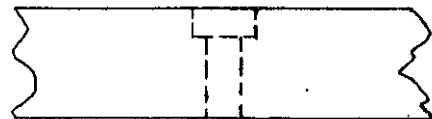

BOLT HOLE DETAIL

CH. BY <i>SW</i>	MTL. 2"X4" YEL. PINE	TITLE WOOD BASE FOR 1KW AM XMTR BC1T M5393		UNLESS OTHERWISE SPECIFIED, ALL TOLERANCES FOR GATES SPEC GOVTG.
DATE <i>7/19/57</i>	ENG. <i>B.L.</i>	FIN. <i>GA3</i>	A 30585	
DR. BY TRB	DATE <i>7-17-57</i>			

					GATES RADIO COMPANY QUINCY, ILLINOIS			A-30603	
								SCALE	

104	103	102	101	GR. FIRST MADE FOR NO.	LIST OF PARTS				
-----	-----	-----	-----	------------------------	---------------	--	--	--	--

QTY.	QTY.	QTY.	QTY.	ITEM	REFERENCE	PT. OR G.N.	FIN.	DESCRIPTION	MATL.
------	------	------	------	------	-----------	-------------	------	-------------	-------

TYPICAL VOLTAGE CHART  
GATES' BC-1T 1 KW AM TRANSMITTER

These measurements made with a Simpson #260 Volt-Ohmmeter, a 20,000 ohms per volt D.C. and 1000 ohms per volt A.C. instrument. DC Voltages to GROUND.

First Audio Input (V1, V2, 6BG6G's)

Plate Volts - 275 D.C.  
Screen Volts - 200 D.C.  
Filament Volts - 6.3 A.C.  
Cathode Volts - 49 D.C.

Bias Supply

Output of Supply, measured at terminal #11 of Audio Printed Board - Neg. 280V.

Cathode Follower (V3, V4, 6BG6G's)

Plate Volts - 650 D.C.  
Screen Volts - 230 D.C.  
Cathode Volts Neg. - 70 D.C.  
Filament Volts - 6.3 A.C.

Intermediate Plate Supply

Output of Supply, Measured at L5, Terminal #2 - 600/650V. D.C.

Modulators (V8, V9, 833A's)

Plate Volts - 2600 D.C.  
Plate Current, Static - 40 MA Each  
Bias Volts - Approx. 65/70 D.C.  
Filament Volts - 10 A.C.

High Voltage Plate Supply

Output of Supply, Measured at Hot End of Bleeder, R10, 2600V. D.C.

Crystal Oscillator (V1, 12BY7A)

Plate Volts - 100 D.C.  
Screen Volts - 50 D.C.  
Cathode Volts - .8 D.C.  
Filament Volts - 6.3 A.C.

First IPA (V2, 12BY7A, A part of Osc.)

Plate Volts - 205 D.C.  
Screen Volts - 105 D.C.  
Cathode Volts - 3.5 D.C.  
Filament Volts - 6.3 A.C.

Second IPA (V1, V2 Parallel 6BG6G's)

Plate Volts - 650 D.C.  
Screen Volts - 400 D.C.  
Cathode Volts - 45 D.C.  
Filament Volts - 6.3 A.C.

Power Amplifier (V6, V7, 833A's)

Plate Volts - 2500 D.C.  
Plate Current - 500/550 MA D.C.  
Bias Volts, 360 D.C.  
Filament Volts - 10 A.C.

CH. BY DATE	MTL. <i>FWW</i>	TITLE	TYPICAL VOLTAGE CHART	UNLESS OTHERWISE SPECIFIED, ALL TOLERANCES PER GATES SPEC GSM102.
DR. BY DATE	ENG. F.W.W.		GATES' BC-1T 1 KW AM TRANSMITTER	
				A-30603

FREQ.	540	600	650	700	750	800	850	900	950	1000	1050	1100	1150	1200	1250	1300	1350	1400	1450	1500	1550	1600
FIRST IPA COIL, L3.	Slug Adjusting Screw Turned All Out.																					
FIRST IPA TUNING COND. C9.	Tune Complete Band With Capacitor C9.																					
SECOND IPA COIL L8.	Tune Complete Band With Coil, L8.																					
SECOND IPA TUNING COND. C7.	Condenser C7 Used On All Frequencies.																					
SECOND IPA PADDING COND. C15.	Not Used				F1B .0002				F1B .0004				F1B .0006				F1B .00075					
P.A. TANK CONDENSERS C11, C12, PARALLEL	Two .00025 G2 in Parallel				Two .0003 G2 in Parallel				Two .0004 G2, in Parallel				Two .0005 G2, in Parallel									
P.A. TANK COIL, L12 TURNS	13.5	14.1	15.0	15.6	15.7	16.6	15.8	16.8	17.4	19.2	20.5	21.4	19.2	21.0	22.7	24.4	23.6	27.0	29.5	33.5	35.0	
P.A. TANK COIL, L12 IND. MHY	19.0	20.0	22.0	23.5	24.1	27.0	24.0	26.0	28.0	30.0	34.0	36.9	30.0	40.0	46.0	51.0	48.0	56.0	62.1	75.2	91.0	
COIL L13, TURNS	6.0	8.0	9.0	9.0	10.0	9.0	8.0	12.0	9.0	9.0	10.0	9.0	13.0	8.0	7.0	9.0	9.0	11.0	10.0	14.0	16.0	
COIL L13, IND. MHY	1.2	2.1	2.7	2.7	3.3	2.7	2.1	4.75	2.7	3.3	3.3	2.7	5.6	2.1	1.6	2.7	2.7	4.0	3.3	6.5	8.5	
INPUT LOADING CONDENSER C13.	.002, F3L				.003, F3L				.004, F3L				.005, F3L									
COIL L14, TURNS	8.5	9.9	8.3	8.9	7.0	4.7	5.8	7.8	12.0	7.6	8.5	9.0	16.0	11.2	11.1	9.9	9.9	11.7	11.0	13.3	14.0	
COIL L14, IND. MHY	4.1	5.4	3.85	4.4	2.75	1.25	3.4	4.5	8.2	3.3	4.1	4.5	14.5	7.1	7.0	5.6	5.6	7.6	6.9	10.0	11.2	
OUTPUT LOADING CONDENSER C14.	.002, F3L				.003, F3L				.004, F3L				.005, F3L									
TANK Q.	12.7	12.6	11.9	11.4	11.1	10.7	11.9	11.9	11.5	11.0	10.5	10.0	12.4	12.0	11.4	10.8	10.2	11.1	10.4	9.6	8.6	
OUTPUT CURRENT	4.4	4.4	4.4	4.4	4.4	4.4	4.4	4.4	4.4	4.4	4.4	4.4	4.4	4.4	4.4	4.4	4.4	4.4	4.4	4.4	4.4	
FREQ.	1600	1550	1500	1450	1400	1350	1300	1250	1200	1150	1100	1050	1000	950	900	850	800	750	700	650	600	540

NOTE - C11 & C12 Always in Parallel, All Freq. Output Impedance 51.5 ohms. Tuning Chart, BC-1T L9 PA RF Choke - C-16466-103 Output Impedance 51.5 ohms. A-30604. 1600 Kc to 1200 Kc - C-18494-102 1200 Kc to 540 Kc - C-18494-102

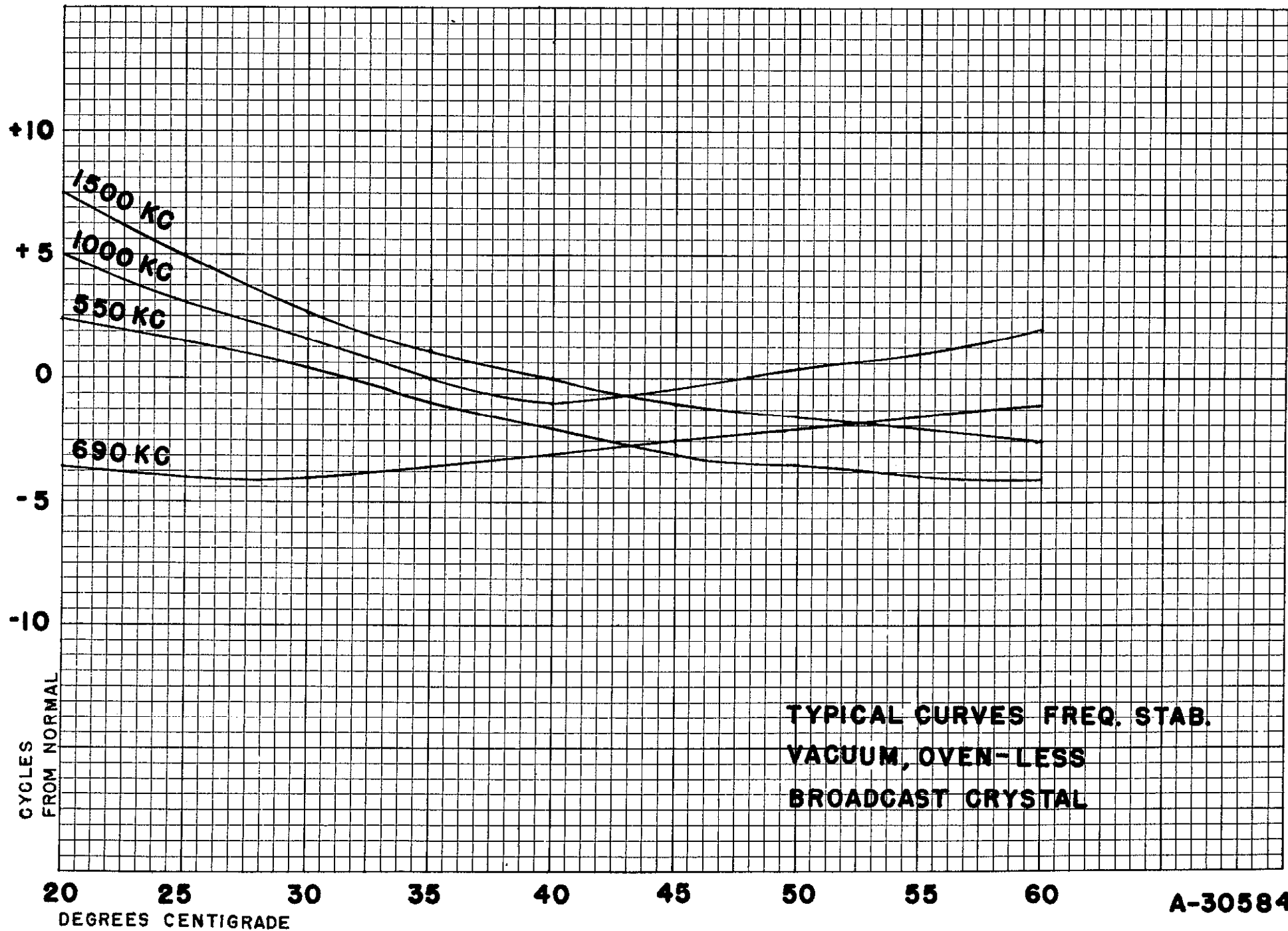

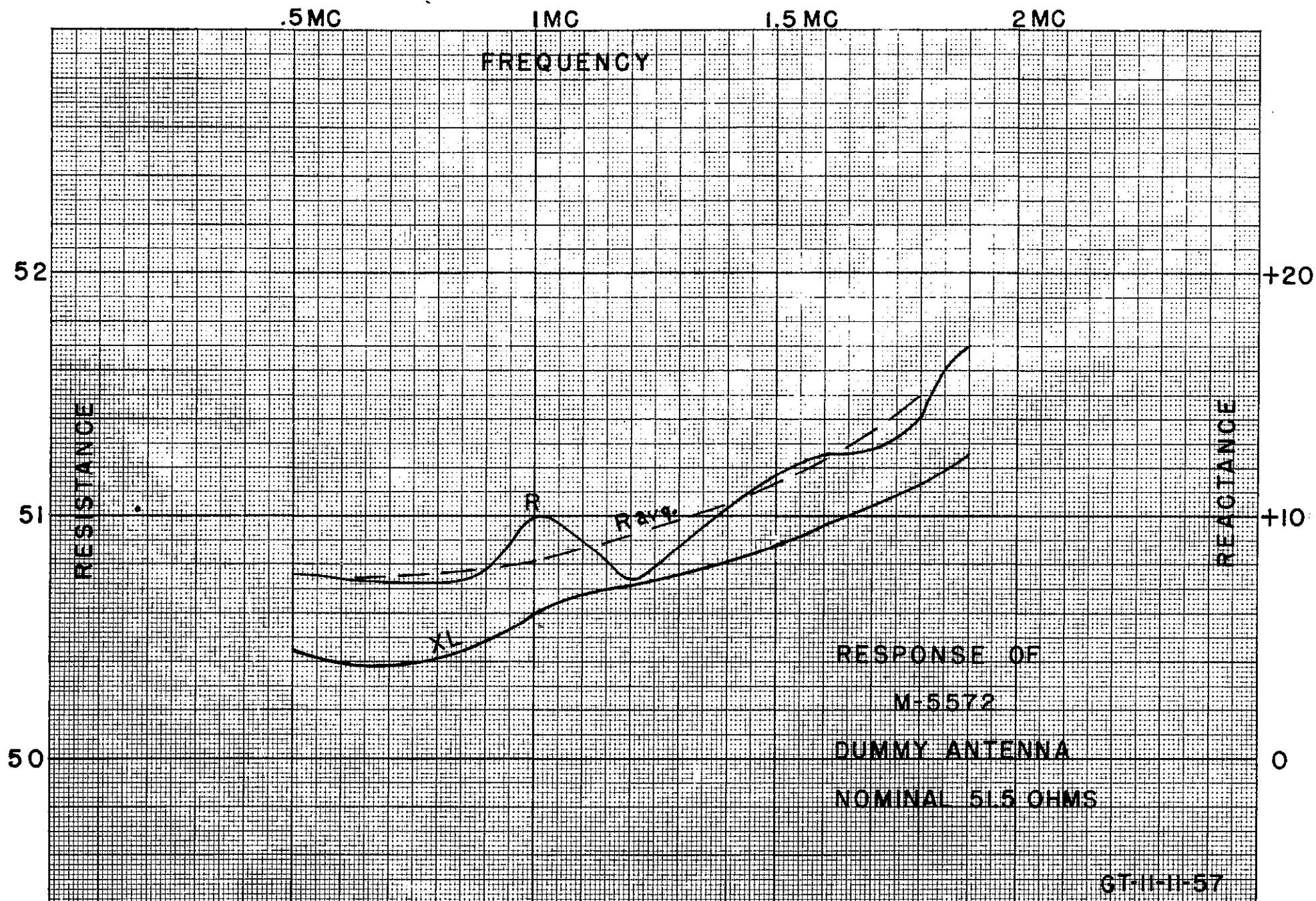

					GATES RADIO COMPANY QUINCY, ILLINOIS		A-31066		
							SCALE _____		
104	103	102	101	GR. FIRST MADE FOR NO.	LIST OF PARTS				
QTY.	QTY.	QTY.	QTY.	ITEM	REFERENCE	PT. OR G.N.	FIN.	DESCRIPTION	MATL.

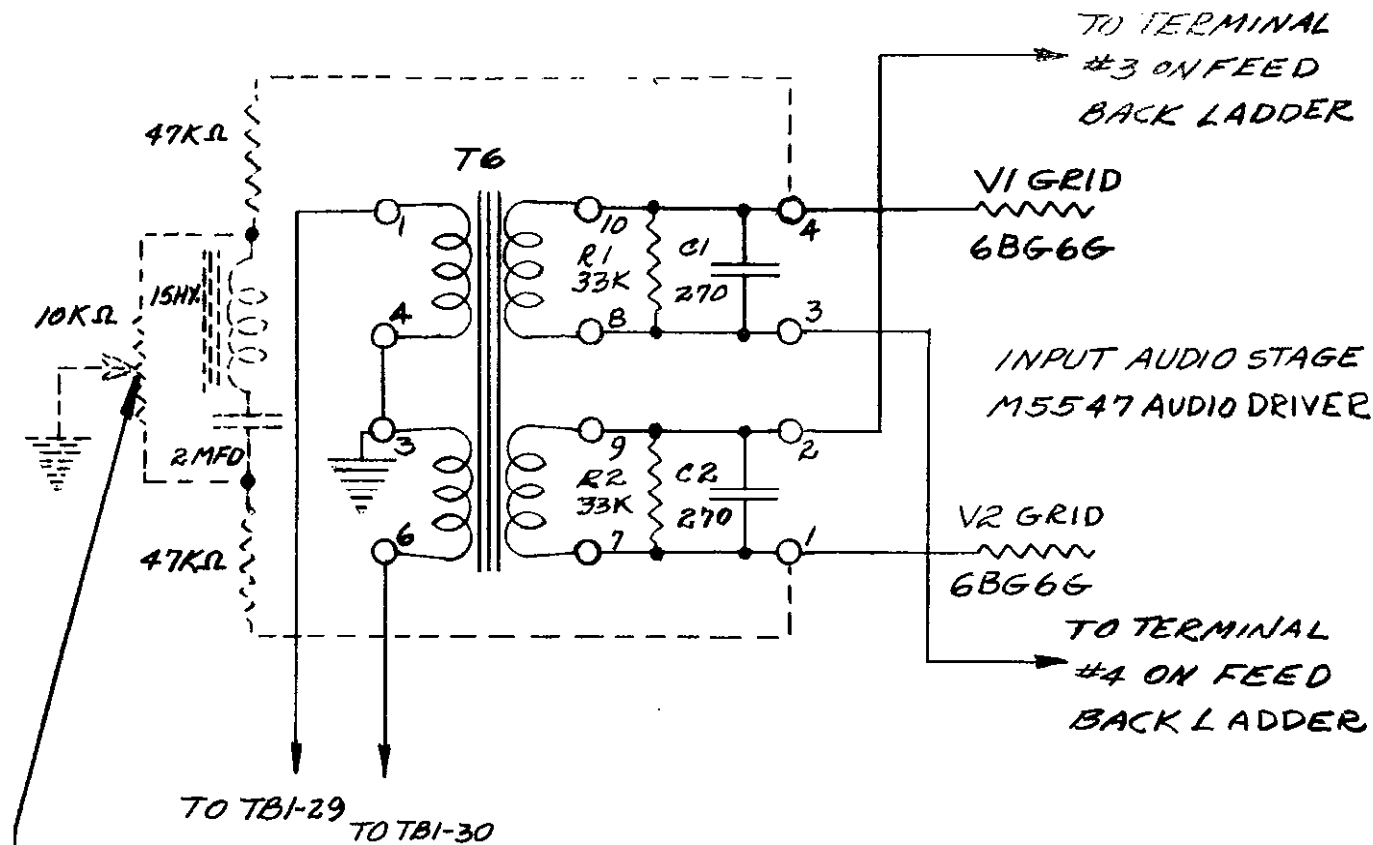

ADJUST THIS  
POTENTIOMETER  
FOR LOWEST  
NOISE READING  
(THIS POT NOT  
USED IN BCIT)

NETWORK SHOWN IN DOTTED LINES—  
THIS NETWORK MAY OR MAY NOT BE  
USED FOR 30 CYCLE AUDIO FREQUENCY  
CORRECTION. INCREASING THE VALUE  
OF THE TWO SERIES RESISTORS WILL  
DECREASE ATTENUATION.

CH. BY	MTL.	TITLE	UNLESS OTHERWISE SPECIFIED, ALL TOLERANCES PER GATES SPEC 65M102.
DATE	FWW	30 CYCLE ATTENUATION NETWORK	
DR. BY	ENG. FWW	BC 1T, BC 500T, BC 250T	A-31066
DATE	2-27-58		

DRAWING NUMBER  
B-13816

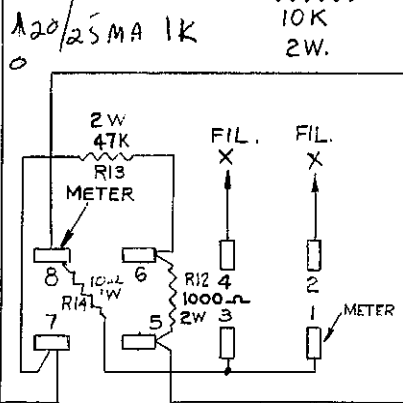
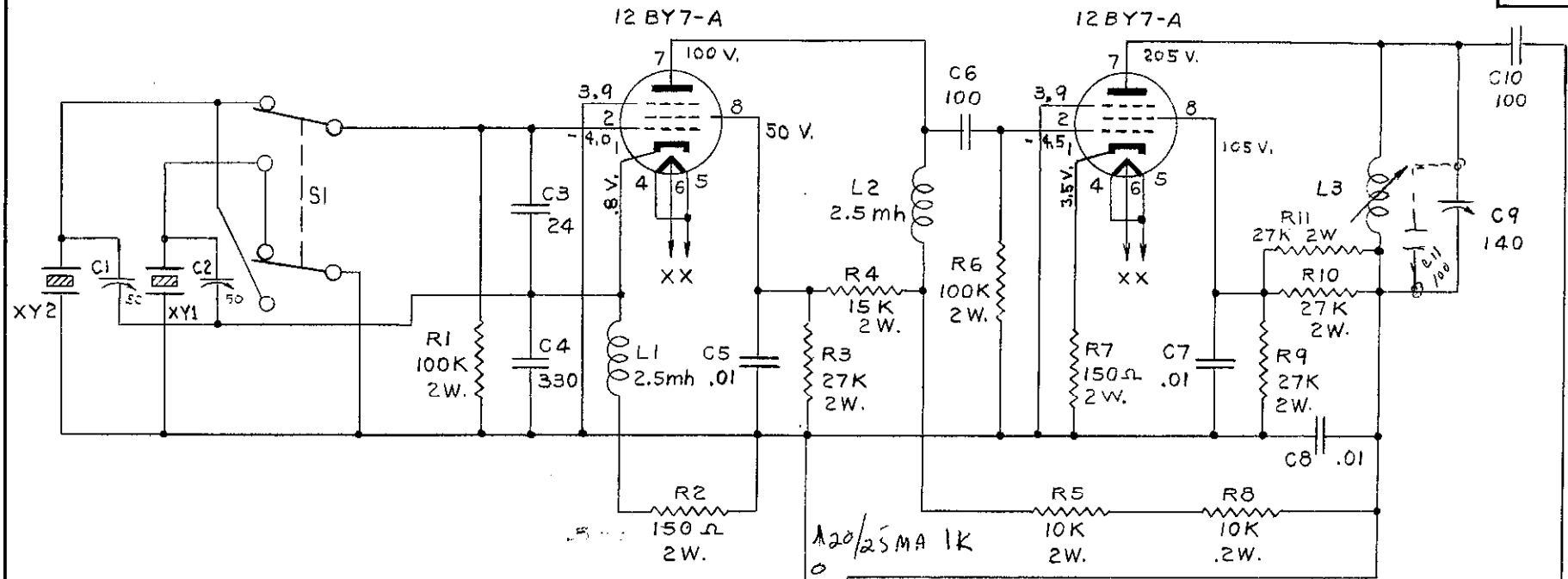

J1  
P-308-DB } SOLDER  
BACK VIEW } END OF  
JACK

REFERENCE B-14041

OSCILLATOR UNIT M5422

MTL		FIN.		UNLESS OTHERWISE SPECIFIED, ALL TOLERANCES PER GATES SPEC ASS'N.	
DR. BY D.L.	CH. BY	ENG. APP.	DATE	DRAWING NUMBER	
DATE 5-3-57	DATE W.L.	DATE		B-13816	
GATES RADIO COMPANY QUINCY, ILLINOIS					

Ke



							GATES RADIO COMPANY QUINCY, ILLINOIS			B-65286 SCALE	
106	105	104	103	102	101	CR. NO.	LIST OF PARTS				
QTY.	QTY.	QTY.	QTY.	QTY.	QTY.	ITEM	REFERENCE	PT. ON G.N.	FIN.	DESCRIPTION	MATERIAL

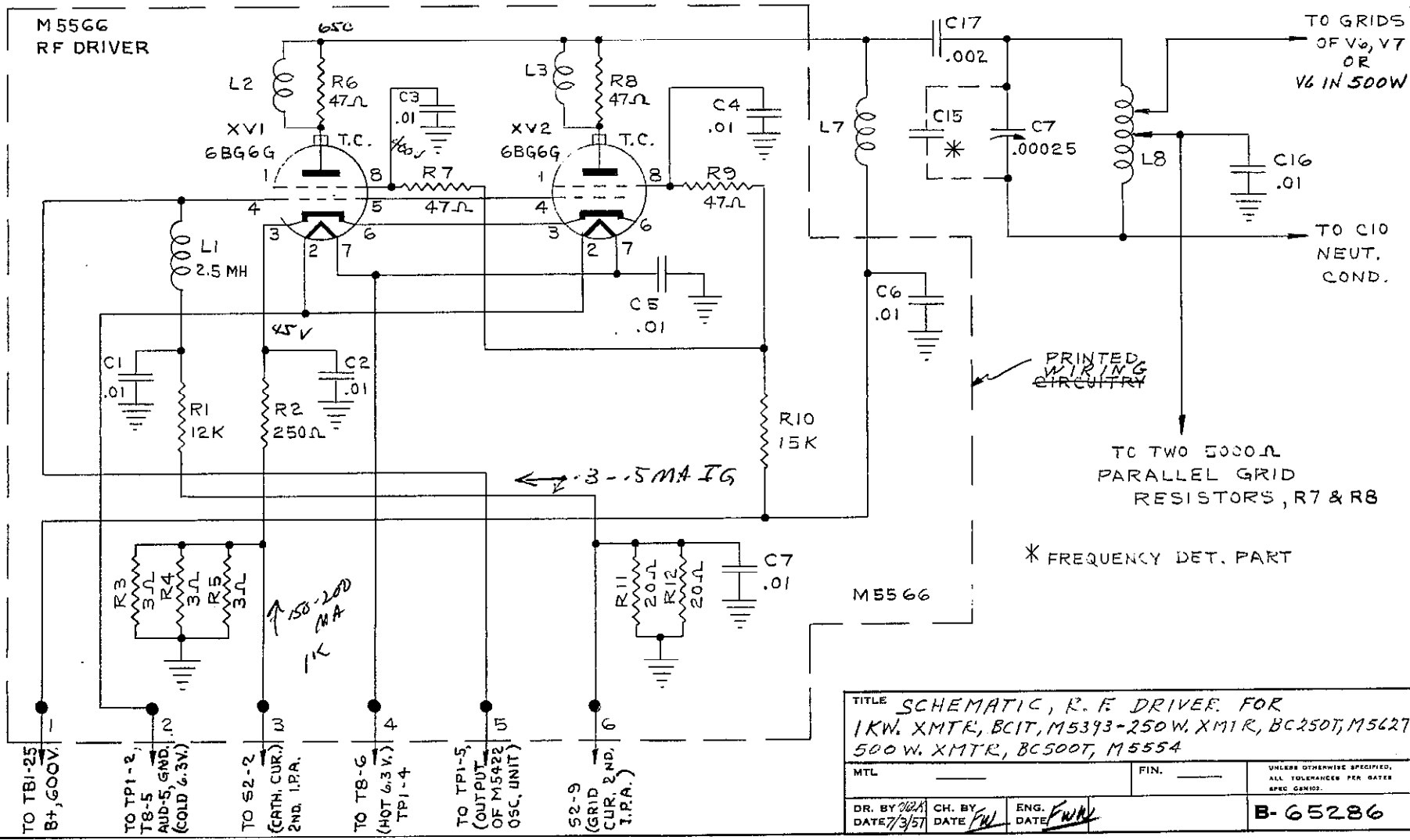

						GATES RADIO COMPANY QUINCY, ILLINOIS		C-77711 SCALE			
108	105	104	103	102	101	44	44	LIST OF PARTS			
QTY.	QTY.	QTY.	QTY.	QTY.	QTY.	ITEM	REFERENCE	PT. NO.	FIN.	DESCRIPTION	MATERIAL

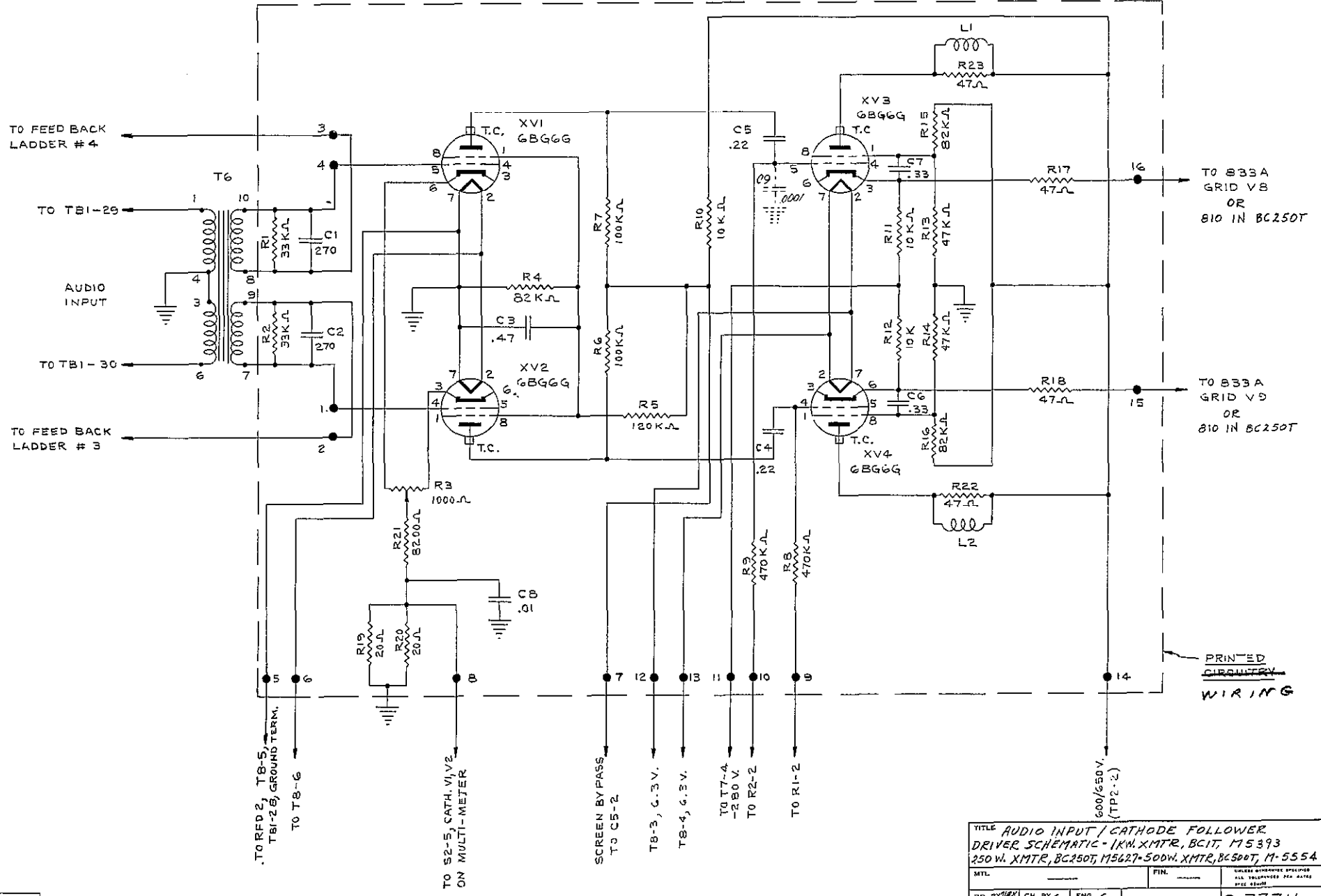

TITLE **AUDIO INPUT / CATHODE FOLLOWER DRIVER SCHEMATIC - 1KM XMTR, BCIT, M5393**  
**250 W. XMTR, BC250T, M5627-500W. XMTR, BC500T, M-555A**

MTL	FIN.	DESIGNED BY	ALL DIMENSIONS PER DRAWING SPEC. SHEET
DR. BY <i>WJW</i>	CH. BY <i>WJW</i>	ENG. DATE <i>1/27/57</i>	C-77711

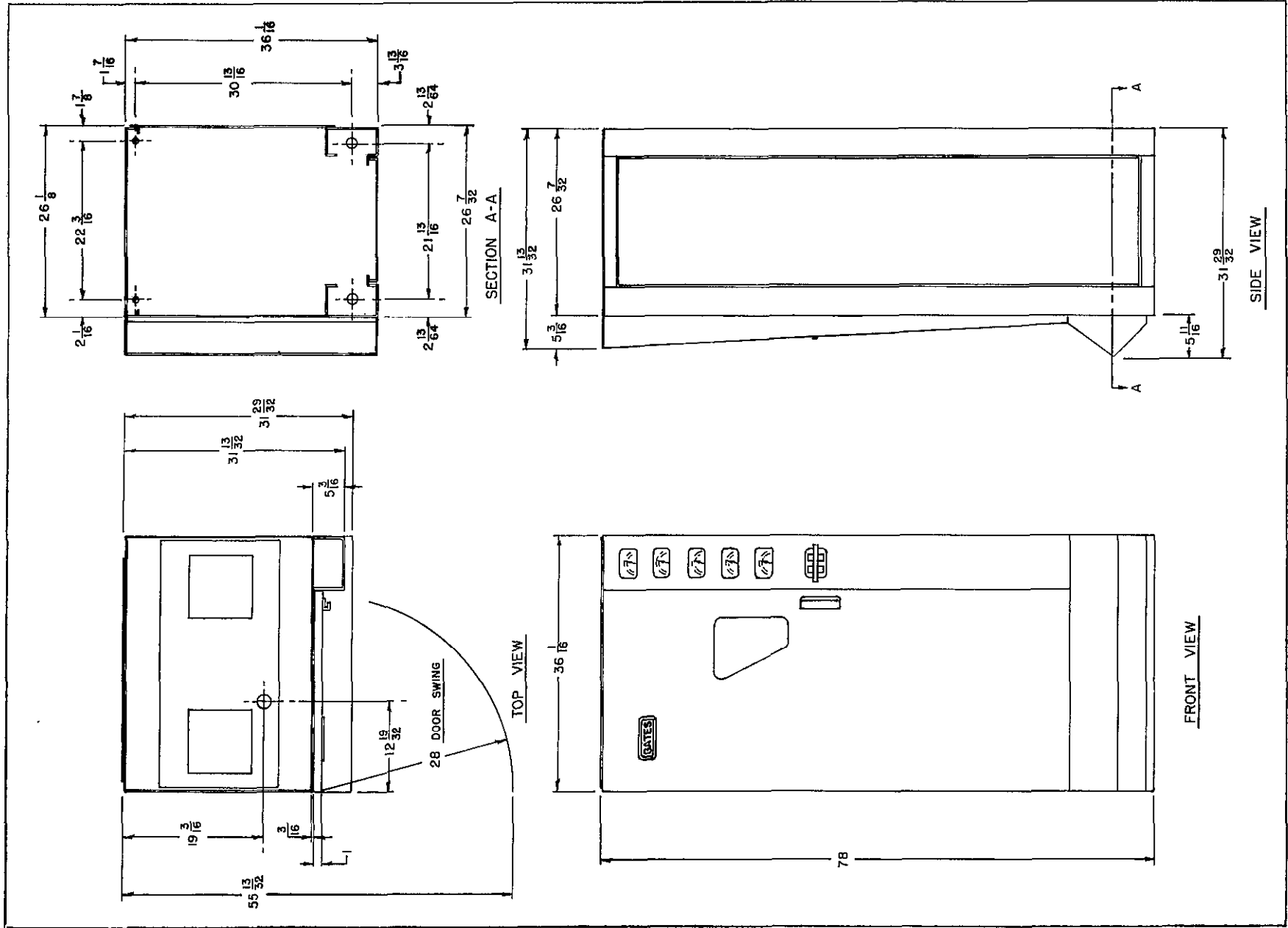

THIS DWG. PERTAINS TO -  
 1KW. XMTR, BC17, M5393  
 250W. XMTR, BC250T, M5427  
 500W. XMTR, BC500T, M5554

GATES RADIO COMPANY QUINCY, ILLINOIS										C-77723	
										SCALE	
LIST OF PARTS											
108	109	104	103	102	101	SR. NO.	REFERENCE	PT. OR G.N.	FIN.	DESCRIPTION	MATERIAL
QTY.	QTY.	QTY.	QTY.	QTY.	QTY.	ITEM					

NOTE: BC250T  
B1 AND B2 ARE NOT USED

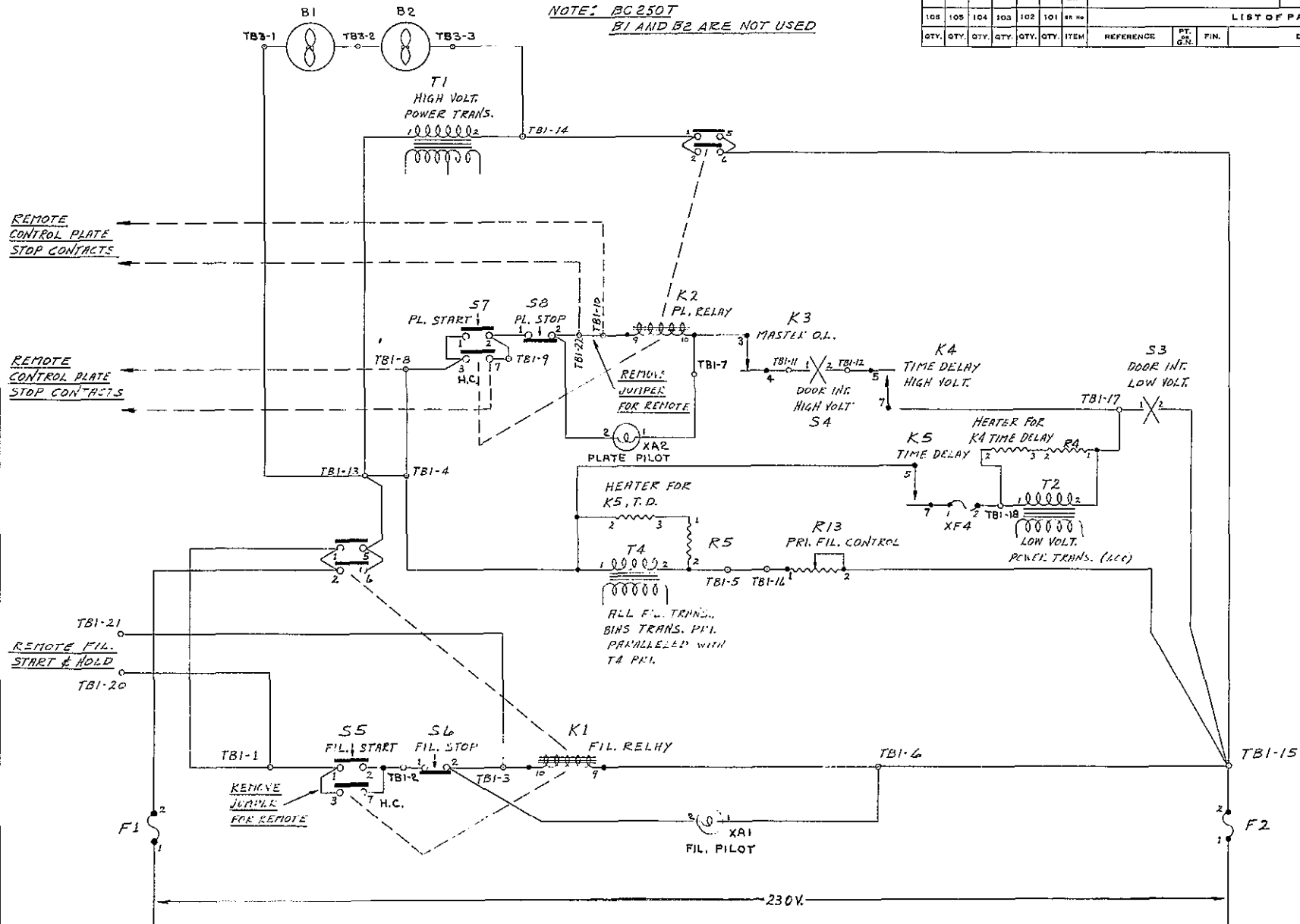

TITLE SIMPLIFIED CONTROL SCHEMATIC 1KW. XMTR, BC17, 15393 - 250W. XMTR, BC250T, M-5627 500W. XMTR, BC500T, 15554			
MTL		FIN.	
DR. BY: JI	CH. BY: JI	ENG. DATE: 1/11/45	DATE: 1/11/45
			C-77723

							FIRST MADE FOR	GATES RADIO COMPANY QUINCY, ILLINOIS			B-65323
											SCALE
106	105	104	103	102	101	GR. No.	LIST OF PARTS				
QTY.	QTY.	QTY.	QTY.	QTY.	QTY.	ITEM	REFERENCE	PT. OF G.N.	FIN.	DESCRIPTION	MATERIAL

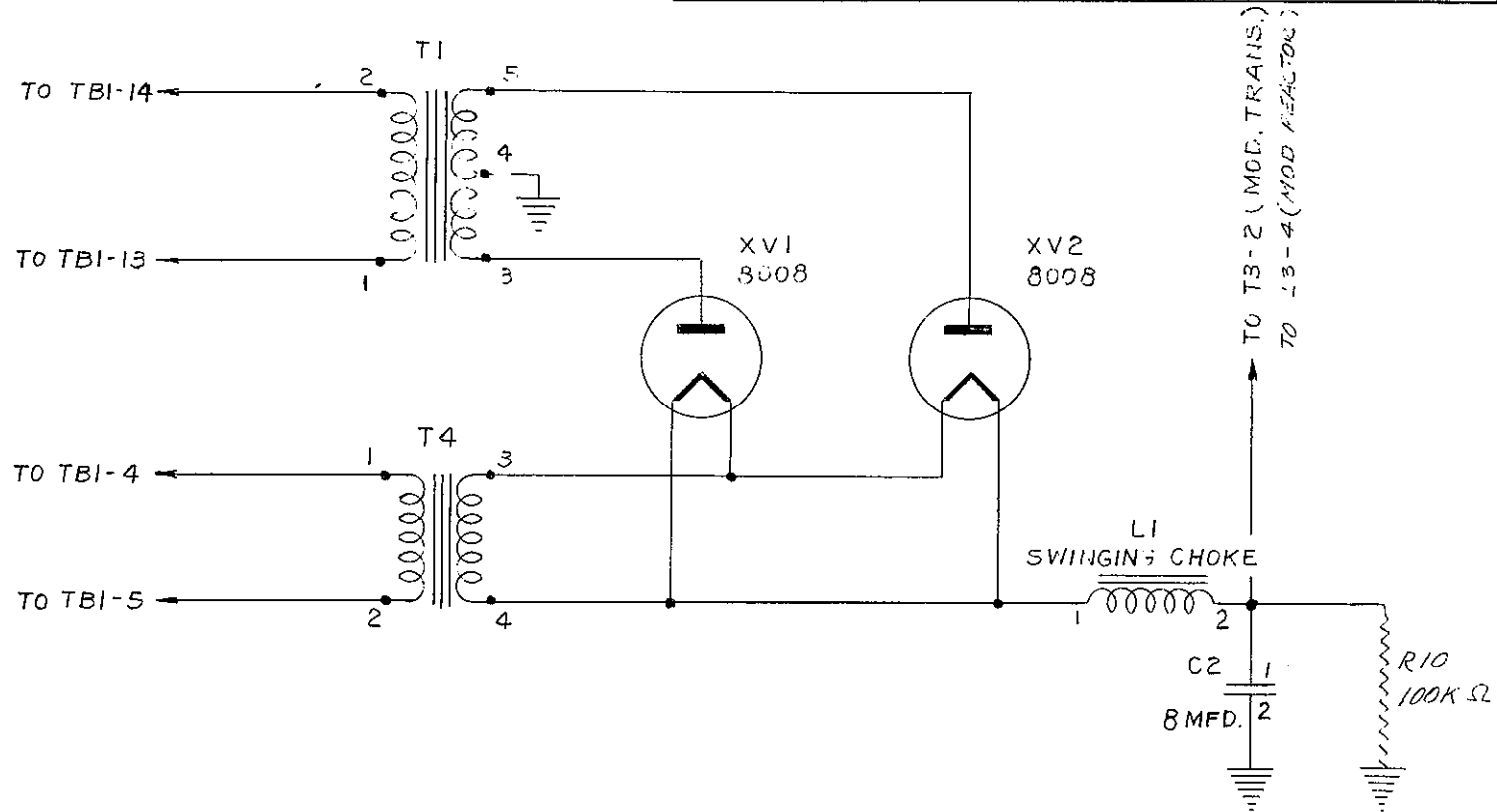

E.C.H. 7270 0.570 1-2-58	TITLE		HIGH VOLTAGE (2500V.) POWER SUPPLY BC-1T, M5393 1KW AM. TRANSMITTER	
	MTL	FIN.	UNLESS OTHERWISE SPECIFIED, ALL TOLERANCES PER GATES SPEC. OR MDI.	
	DR. BY D.L.	CH. BY F.W.	ENG. DATE	DATE
			B-65323	

							FIRST MADE FOR	GATES RADIO COMPANY QUINCY, ILLINOIS			B- 65324		
								LIST OF PARTS					SCALE
108	105	104	103	102	101	GR. NO.							
QTY.	QTY.	QTY.	QTY.	QTY.	QTY.	ITEM	REFERENCE	PT. OR G.N.	FIN.	DESCRIPTION		MATERIAL	

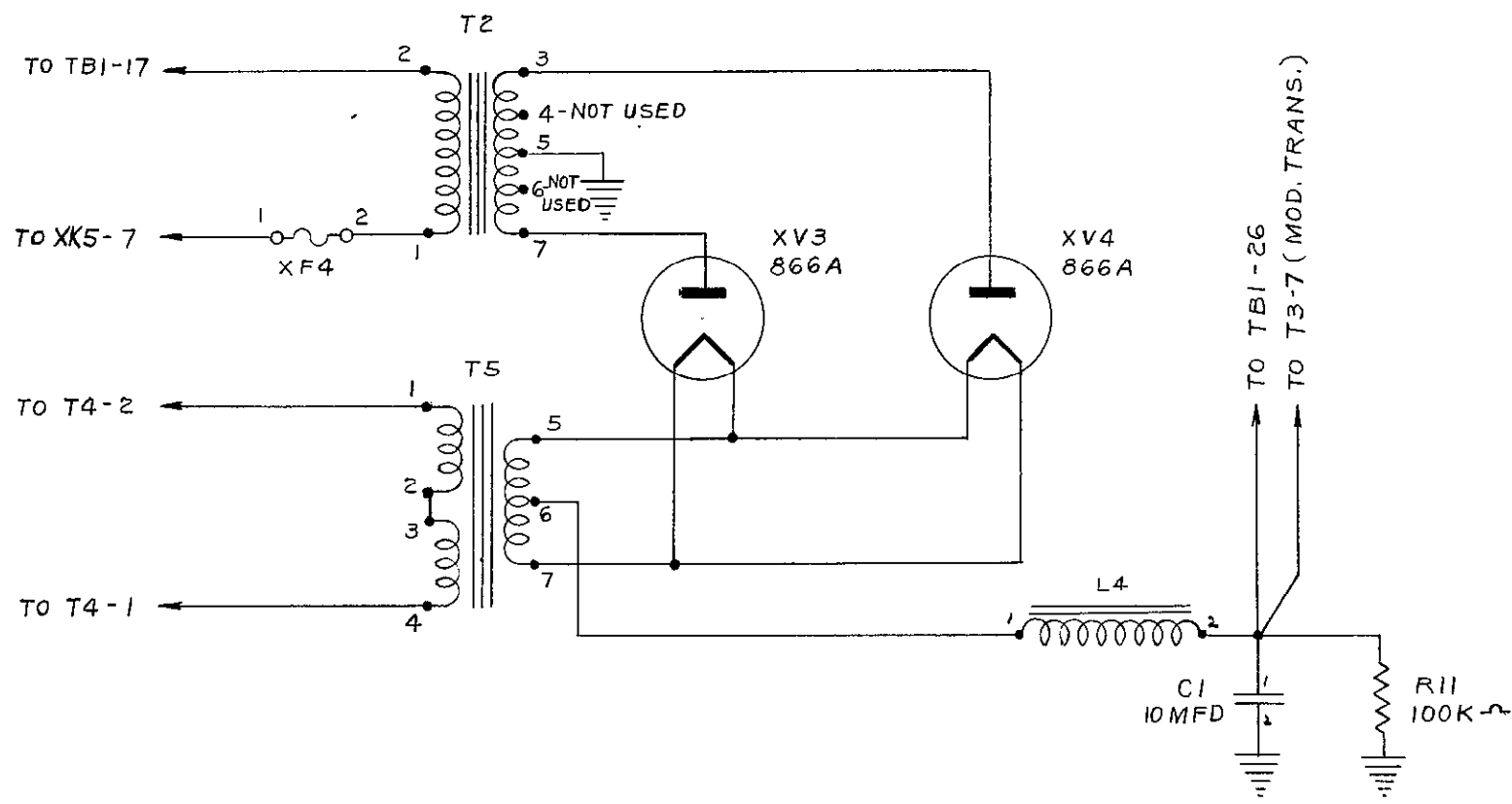

TITLE				INT. VOLTAGE (600/650V.) POWER SUPPLY 1 KW. TRANSMITTER, BCIT, M5393 500W TRANSMITTER, BC500T, M5554			
MTL		FIN.		UNLESS OTHERWISE SPECIFIED, ALL TOLERANCES PER GATES SPEC. GEMDS.			
DR. BY D.L.	CH. BY	ENG.	DATE	B- 65324			
DATE 7-15-57	DATE	DATE	DATE				

							GATES RADIO COMPANY QUINCY, ILLINOIS			B-65293	
										SCALE _____	
106	105	104	103	102	101	DR. NO.	LIST OF PARTS				
QTY.	QTY.	QTY.	QTY.	QTY.	QTY.	ITEM	REFERENCE	PT. OR G.N.	FIN.	DESCRIPTION	MATERIAL

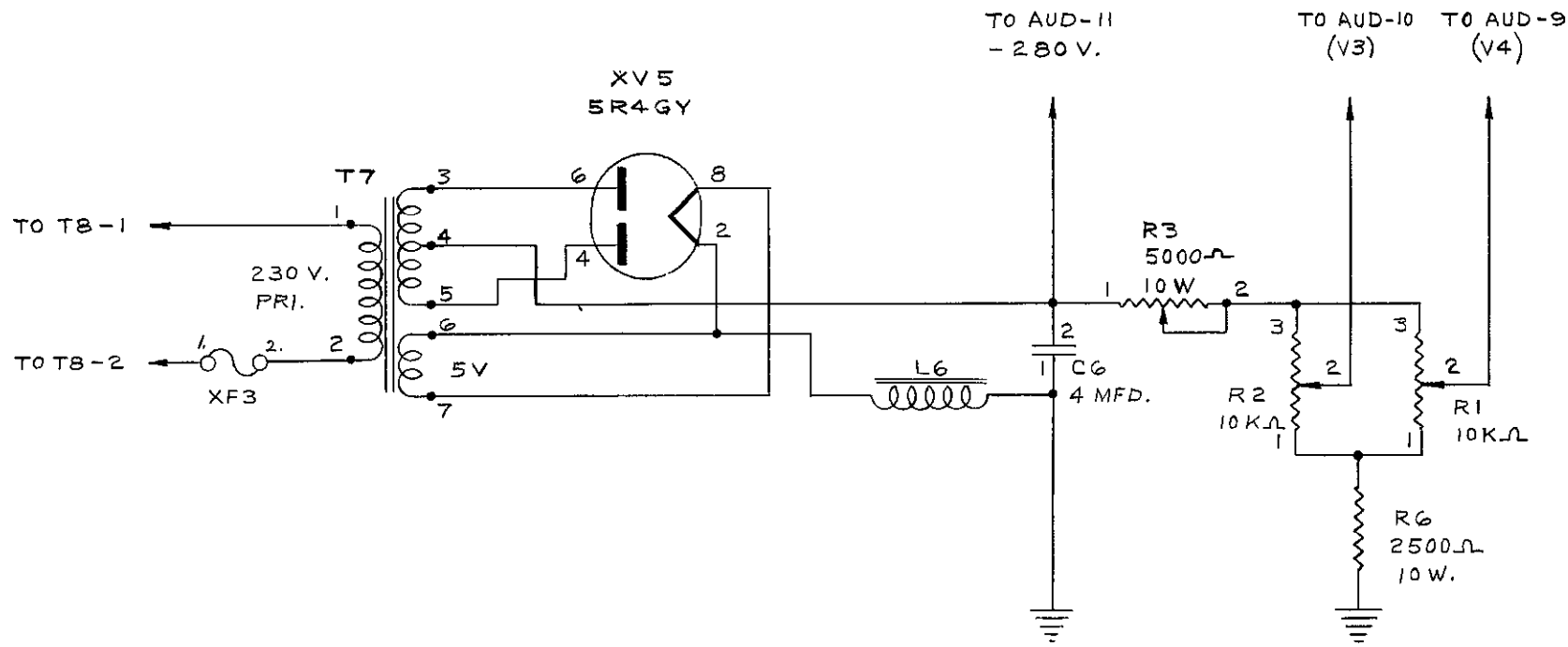

TITLE *BIAS SUPPLY (SCHEMATIC)*  
*1KW. XMTR, BC17, M5393-250W XMTR, BC250T-M5627*  
*500W XMTR, BC500T, M5554*

MTL _____	FIN. _____	UNLESS OTHERWISE SPECIFIED, ALL TOLERANCES PER GATES SPEC 08M102.
DR. BY <i>FW</i> DATE <i>7/5/57</i>	CH. BY <i>FW</i> DATE _____	ENG. <i>FW</i> DATE _____

B-65293

										GATES RADIO COMPANY QUINCY, ILLINOIS		C-77712	
												SCALE	
106	108	104	103	102	101	DR. NO.	LIST OF PARTS						
QTY.	QTY.	QTY.	QTY.	QTY.	QTY.	ITEM	REFERENCE	PT. OF C.N.	FIN.	DESCRIPTION		MATERIAL	

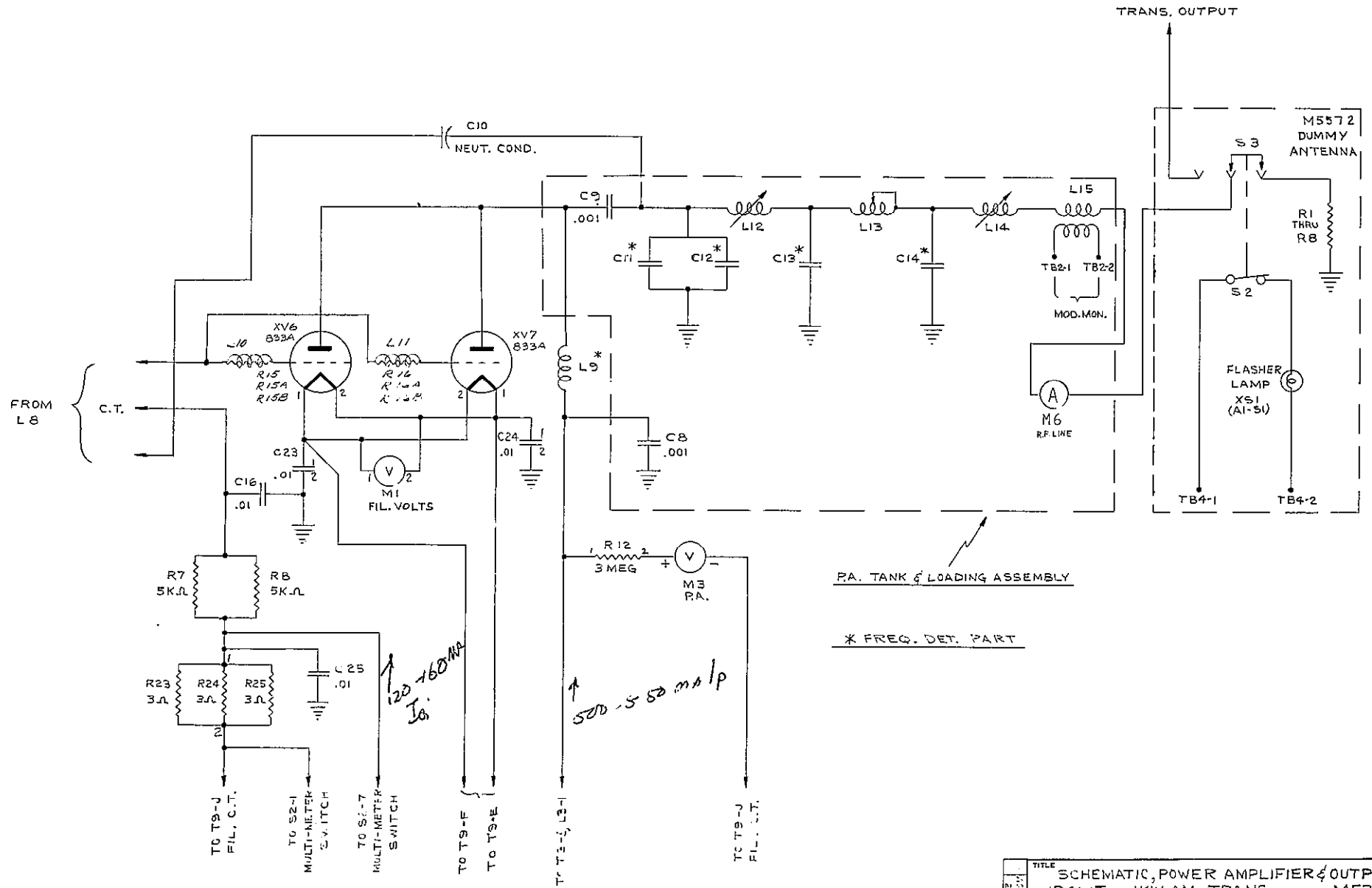

TITLE		SCHEMATIC, POWER AMPLIFIER & OUTPUT CIRCUIT. 1KW AM TRANS. M5393	
MTL	FIN.	UNLESS OTHERWISE SPECIFIED, ALL DIMENSIONS ARE IN INCHES AND DECIMALS THEREOF.	
DR. BY <i>W. J. W.</i>	CH. BY <i>W. J. W.</i>	DATE <i>7/1/57</i>	DATE <i>7/1/57</i>
		C-77712	



## REPLACING COMPONENTS ON THE PRINTED CHASSIS

Since this is a destructive operation, the engineer must be reasonably sure that the part is defective before removing it. He may determine this from the D.C. and signal voltage measurements or by visual observation.

**WARNING:** The copper conductors are only .0027" thick on the printed chassis. They are easily damaged! Do not attempt to pull one component lead loose to check the component. Use only the approved procedure as outlined in the sketches and the sub-paragraphs listed below.

Use a small electric soldering iron (60 watts or less) and allow it to come up to full heat before starting the repair job. The tip must be clean and well tinned.

**CAUTION:** Do not use a soldering gun. The extremely high temperature of the tip will damage the phenolic board.

Put the iron tip on the fillet under the chassis, right beside the component lead being removed. Put a gentle, but firm pressure on all leads and components being moved while the heat is applied. Do not hold the iron to the printed chassis for long periods of time. If the lead or component is difficult to remove, make repeated short passes at it rather than one long period that may overheat the board.

### 1. REMOVING PARALLEL MOUNTED COMPONENTS WITH AXIAL LEADS:

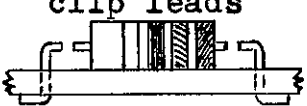
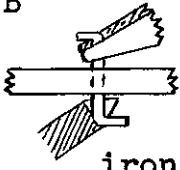
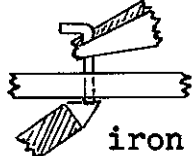
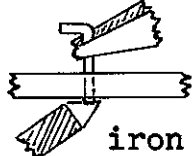
- A  clip leads
- B  pliers push wire through hole until hook can be clipped off.
- C  pliers clip off hook that was soldered to chassis.
-  iron tip place iron on fillet again and pull the wire out of the hole on the top side of the chassis.

### 2. REMOVING VERTICALLY MOUNTED RESISTORS AND COMPONENTS WITH AXIAL LEADS:

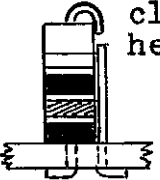
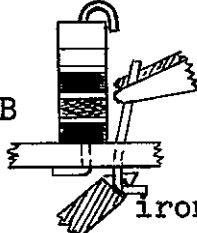
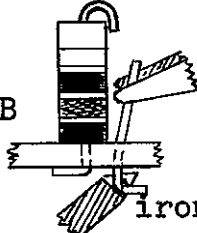
- A  clip here
- B  pliers push wire through the hole until the hook can be clipped off.
-  iron tip clip off hook that was soldered to chassis.
- remove wire as illustrated in paragraph 1. (c).

2. (continued)

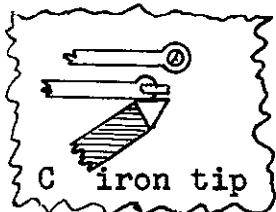

place the iron against the folded wire and rotate it away from the conductor leading into the fillet (2-c).

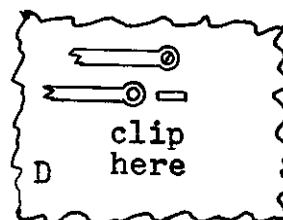

cut the wire as near the chassis as possible after removing as much excess solder as possible. Remove solder by carrying it away with the iron tip and wiping the tip on a clean cloth. Repeat until the hook can be clipped with small sharp diagonal cutters, illustrated in (2-D).

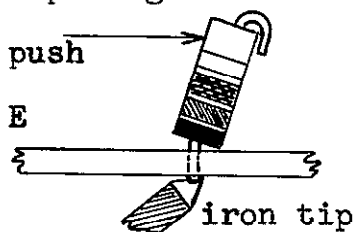

place iron on fillet again and push the resistor body over until the lead comes out of the hole.

3. REMOVING PRINTED WIRING TYPE CAPACITORS:

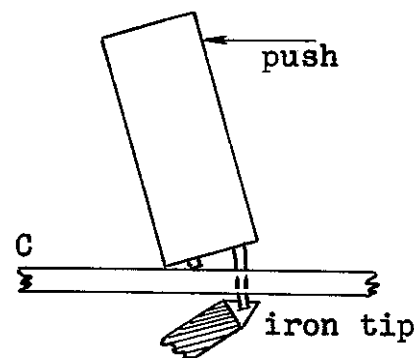
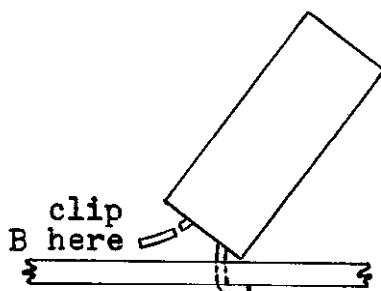
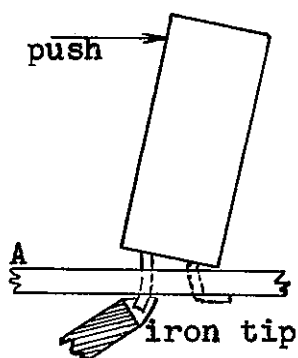

(A) hold iron tip on one of the folded leads, as soon as the solder melts - push gently but firmly on the side that will lift this lead. The capacitor should be pushed over just far enough to clear the lead from the hole.

(B) cut the lead off to prevent it from going back into the hole when removing the other lead.

(C) hold the iron tip to the other lead and push the capacitor over until it comes free.

4. REMOVING SADDLE TYPE ELECTROLYTIC CAPACITORS:

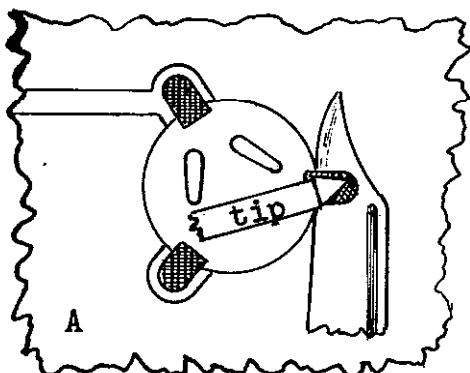

Place the iron tip on top of the folded over mounting ear. As the solder melts, slip a thin knife between the mounting ear and the copper conductor pad. DO NOT PRY THE TAB UP WITH THE KNIFE! See (4-B) for bending ears away from chassis. When the knife is completely under the ear, remove iron and let the solder cool.

Repeat on other two mounting ears.

4. (continued)

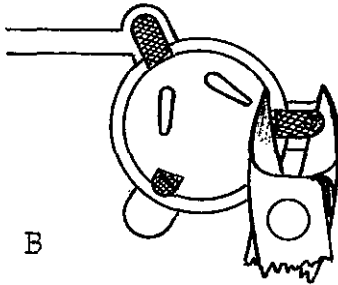

Using a pair of small sharp diagonal cutters, bend the mounting ears up and away from the copper conductor pads. **DO NOT PRY THE MOUNTING EARS UP WITH A KNIFE OR SCREWDRIVER!**

Repeat the process on the other two mounting ears and drop the capacitor off the board.

5. PREPARING THE HOLES FOR THE REPLACEMENT COMPONENT:

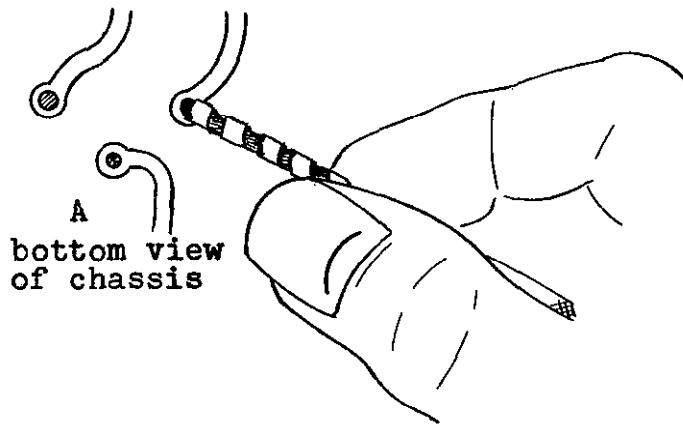

Use a small metal twist drill ( $1/8$ " dia. or less) to clear the hole only in the fillet of solder. Twirl the drill by hand. Do not attempt to remove all of the solder in one turn, do it slowly and carefully.

Do not attempt to increase the hole size, just remove the solder. It is soft and easily removed in this way.

6. REPLACING THE COMPONENTS:

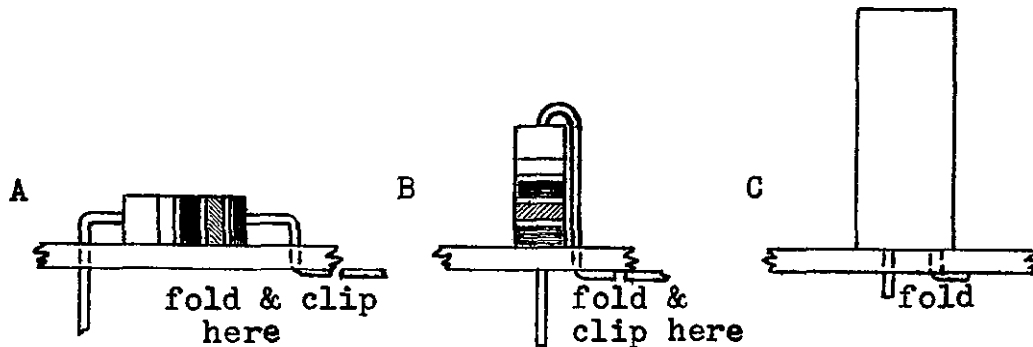

(A) & (B) Fold the leads on the new part to the same spacing as the mounting holes. Insert the part and fold the leads under the chassis to hold the part tightly against the top of the chassis. Clip off the excess wire.

Put the iron tip on the fillet and lead. Solder swiftly and securely. If the printed chassis is damaged by accident it is seldom necessary to scrap it. If one of the conductors is broken, lay a piece of small wire (#18 to #24 AWG) across the break and solder each end to the conductor. If a fillet is pulled loose, break it off to get rid of the loose end. Fold the new component lead toward the end of the conductor and solder the lead to the conductor. If the component lead is cut too short, lay a small piece of wire across the gap solder it in.

## 7. REPLACING TUBE SOCKETS:

Tube sockets are very difficult to replace and should not be replaced until you are positive that the one in question is actually defective. Resolder all of the socket pin fillets to assure that this is not the trouble. Inspect the top side to see if the tube pin sleeve is bent and can be straightened. Use a socket alignment tool to re-size. Check continuity from the top to the bottom side of the chassis. If there is a connection and the socket sleeve is not out of alignment or spread open, the socket is O.K. and should not be removed.

(A) If the socket has been damaged or is excessively corroded it must be replaced. Stand the unit so that the chassis is vertical. Hold a small iron to the hex nut in the center of the socket (if the socket is retained in this manner). After the solder has melted, unscrew the retaining screw.

(B) Remove the excess solder from all pin fillets by carrying it away with the tip of the iron. Repeat until all solder that will come loose is removed. Do not hold the iron to the chassis for long periods of time.

(C) Starting at pin 1 or pin 7 (8 or 9 on other sockets), apply the iron and push against the socket to raise it at this point. Use the thumb and fingers only to raise socket to prevent damage to the board. The socket will not move very much but any movement at all is helping. Place the iron on each pin in rotation around the socket while pushing up on the side of the socket adjacent to the pin being heated. After several passes around the socket it will no longer be held in by solder. Gently rock the socket and pull it free of the holes.

(D) Use a small metal twist drill as illustrated in paragraph 5 of these instructions to clear the fillet holes of solder.

(E) Install the new socket and put in a new retaining screw similar to the one removed (if retaining screws are used). Do not tighten the nut excessively and put a great strain on the phenolic board.

(F) Solder the screw, nut and each socket pin fillet swiftly and securely. Be sure that there is no solder bridging between adjacent fillets or conductors.

(G) If one of the fillets was damaged in the replacement operation, form a small loop on the end of a small piece of wire. Drop the loop over the socket pin and lay the wire to join the proper conductor. Flow solder on the connections and clip off the excess wire.

From the Engineering Department of  
The Gates Radio Company  
A Subsidiary of the Harris-Intertype Corp.

## HOW CAN WE HELP YOU?

Where problems exist, we want to help. — The best way is to work out the problems together. In that way, you are completely familiar with what is done and future maintenance will be routine.

1. You will note the SERVICE QUESTIONNAIRE. Fill this out completely and mail back today, if possible. Use an extra sheet of paper if further comments are necessary. The following are statements of fact or things to look for. Always remember that most problems have a simple solution. If some of the statements below are elementary, it is because busy, intelligent people often assume that the simple, elementary things are okay.
2. LOW OR HIGH EFFICIENCY. This is important as a first test. As efficiency will vary with transmitter powers, these estimates will help:

250 watts	----	65 to 75% efficiency
500 watts	----	65 to 75% efficiency
1000 watts	----	68 to 77% efficiency
5000 watts	----	72 to 80% efficiency

(a) The above variances in limits could be for many reasons such as slight meter error, tune-up and/or variance in transmission line length.

3. COMPUTING EFFICIENCY. To compute wattage input, multiply the plate voltage by the plate current in the final radio frequency amplifier. For example, if plate volts were 2500 and plate current was 550 MA., we have:

$$\begin{array}{r} 2500 \\ \times .550 \\ \hline 1375.000 \end{array}$$

This means the power input to the final P.A. stage as required to compute power is 1375 watts, which would be approximate for a 1000 watt transmitter. If, at this power input, the transmitter is delivering 1000 watts output as computed by antenna current (see Par. 4), then we find the transmitter is approximately 73% efficient, or:

$$\frac{1000}{1375} = 73\%$$

4. COMPUTING POWER OUTPUT. The formula  $I^2R$  is employed here. I = the current reading of your antenna meter at the tower and R = the resistance measurement of your tower as provided by your consultant who measured your tower after it was erected. If the tower resistance was 50 ohms (they vary widely from tower to tower), then the antenna current squared, multiplied by the tower resistance, would be the power output. Using 1000 watts as the transmitter power, we find if the antenna current was  $4\frac{1}{2}$  amperes that the square of this, or  $4.5 \times 4.5$ , is 20.25 and we have this simple problem:

$$20.25 \times 50 = 1012.5 \text{ (watts)}$$

5. CORRECTING LOW EFFICIENCY. Basically a broadcast transmitter by inherent design cannot produce low efficiency unless it is tuned up incorrectly. If you have low efficiency, your first check should be into an approved dummy antenna. Light bulbs or dummy antennas of unknown resistance under power do not help. As every station should have a dummy antenna for off-hours testing, etc., this should be part of your test equipment. Several types are listed in the Gates catalog and they are not expensive. By use of the dummy antenna, we have a known resistance to compute the transmitter efficiency without using the antenna tower, antenna coupling equipment or transmission line. By using the formula in Par. 4 above, we use the resistance of the dummy antenna as R. The  $I^2R$  gives us the power out of the transmitter.
6. When using a dummy antenna and efficiency is low or below that in Par. 2, the first thing to do is check the accuracy of the plate voltmeter and P.A. milliammeter. This is the gas tank that is always full but often turns out to be the offender. Meters are delicate and the transportation company could have dropped the box in just a way to render a meter inaccurate. You must have another meter of known accuracy for both circuits. A reliable volt-ohm-meter will suffice. Be careful as the voltage is lethal. If you find either of these meters is off, you have found the trouble.
7. If all is normal, then reconnect the transmitter to the antenna. Get another R.F. ammeter (perhaps you can borrow one from a nearby station) and check the accuracy of this meter. An error of only a couple tenths on the scale makes a huge difference. Using our example in Par. 4 above, you will note we used a meter reading of 4.5 amperes as an example which gave us 1012.5 watts output. If this meter had read 4.4 amperes, the output would have been 968 watts. Thus, if the meter was off only 0.1 amperes, we lose 44 watts or nearly 5% of our 1000 watts output.
8. ARCING PROBLEMS. Power must go to the antenna. When it gets sidetracked, it has to go somewhere and this often causes arcing. As efficiency, discussed above, tells many stories, we often find that low efficiency and arcing go together. If the dummy antenna shows good efficiency and the antenna itself shows poor efficiency, it means part of the power is not getting to the antenna. This could indicate several things:

- Improper tuning of antenna coupler.
- Standing waves on the transmission line usually indicated by different current readings at each end of the line.
- Improper ground return from the ground radials to the transmitter.
- Incorrect resistance measurement of the tower.

9. TUNING ANTENNA COUPLER. Your consultant can help you by tuning up your coupler with an R.F. bridge at the same time he measures your tower. -- Where this is not possible and a bridge is not available, consult the graphs in the instruction book and use the cut and try method. Result desired is the greatest antenna current without increasing the power input to the transmitter to get the increased antenna current.
10. STANDING WAVES on the transmission line are caused by improper impedance match between the output of the line and the antenna coupler. Poor match between transmitter output and input to line will reduce power transfer and cause low efficiency. Standing waves may also be caused by a poor or no ground on the outer shield of the transmission line. This line should be grounded to the ground radials at the tower end and to the transmitter at the transmitter end.
11. IMPROPER GROUND. Here is where many good installations go astray. We plow in 120 ground radials but fail to connect them well to the transmitter. Remember, this is the second conductor of our radiating circuit. Where the radials are bonded together at the tower, extend at least a 2-inch copper strap directly to the ground of the broadcast transmitter. Do not attach to one radial closest to the transmitter. Vision your transmitter the same as an ordinary light bulb circuit. The transmission line to the tower is one wire. The other is the ground strap from the radials under the tower back to the transmitter. And don't forget to ground the antenna coupler box too. In fact, you can't do enough good grounding.
12. INCORRECT RESISTANCE MEASUREMENT OF TOWER. Here is where Gates might offend a consulting engineer. It can be said that consultants seldom miss because they know the importance but it has happened. We recall one world-famous consultant that came up with a wrong one and there are lots of good reasons, such as an error in the R.F. bridge. One cause is making changes in the ground system after the measurements are made. This one has upset all of us at times. Any good consultant will recheck his measurements if everything points that way. Be sure first because these consultants are mighty accurate. -- The importance of this point is understood by reading Par. 4 again. If the resistance was actually 40 ohms instead of 50 ohms, the power output would be 20% less and the efficiency would be nothing short of horrible.
13. FUSE BLOWING. This doesn't happen often but when it does, it is a big problem. Especially in remote control unattended operation. It is a little embarrassing to suggest the fuses as too small. Don't forget the fuse power is computed by a good safety factor as you may have some things on these fuses that you have forgotten about, such as a window fan or a well pump. --- Also fuse rating and heat go together. A hot day and border line fuses is asking for trouble.
14. More important is the deeper causes of fuse blowing. Here are a few points:
  - In extremely cold weather if you blow a fuse at morning turn-on, it is a safe bet the temperature of the room has gone very low and the mercury in your rectifiers has collected, causing an arc-back. You can correct this by placing a light bulb or small heating element next to the rectifiers which turns on when the transmitter is turned off.
  - Dirt or scum is the evil of all transmitters. Enough will cause arc-overs that will blow fuses.
  - Look for cable abrasions.
15. It is also important to note that if you have had a fuse blowing ordeal, that after locating the cause, the fuse clips may be so badly charred that you will continue to blow fuses until the clips are replaced. Fuses will often blow while circuit breakers either in the transmitter or in the wall will not act. Fuses are faster but if you have proper size fuses the circuit breaker ahead of them will usually operate first.
16. UNEXPLAINED OUTAGES. This is the one that puzzles all technicians and often the best of them. A transmitter that goes off the air for no reason and can be turned back on by pushing the start button always brings the question, "What caused that?" -- Of course, if this happens infrequently we can say it is normal as power line dips, a jump across the arc gap at the tower base, or other normal things will cause this and it should remove the transmitter momentarily to protect it. Some circuits include an automatic carrier reset while other transmitters require the operator, either remote or in attendance, to push the start button. In either case, frequent outages demand the cause to be located.
17. Your transmitter always looks like the offender. It is the device with meters and it is the device that quits if there is a failure anywhere in the entire system. An open or short circuit in a transmission line does not hoist a flag at the point of trouble in the transmission line. It does react at the transmitter. A faulty insulator in an antenna guy wire or a bad connection in the antenna tuning unit only shows at the transmitter. --- In fact, as you can see, the transmitter always shows as the offender. Often it is not, in fact more often it is not. --- If the drive shaft between your car motor and the rear wheels fails, it does not mean the motor is defective.
18. Earlier we mentioned the need of a dummy antenna at every radio station. Here again we see how valuable it becomes because you can disconnect everything after the transmitter and use the dummy antenna. By quick process of elimination of the tower, coupler, transmission line, tower chokes and ground system, you are able to determine if the transmitter is the offender. By modulating the transmitter and doing regular programming for an hour or so into the dummy antenna you experience the same transmitter outages, then you can hang it on the transmitter. Conversely, if the transmitter gives no trouble into the dummy, you can conclude that the fault is not the transmitter but in what is connected to it.
19. Step by step trouble shooting is always best. Trouble shooting is never on the basis of "It might be this or that." Instead, follow through from the beginning. If the transmitter was okay on the dummy antenna, the question becomes -- "Where is the trouble?" If a transmission line connects the transmitter to the antenna coupler, then move the dummy antenna to the far end of the line and repeat the tests. Always remember that tests should be made, in part, under full modulation because often an open or an arc will occur under conditions of the greatest voltage and/or current. If, in this condition, an irregularity is noted, you have found the point of trouble in the transmission line. If not, reconnect the antenna coupler and the next job is to visually observe the antenna coupler under operation. In so doing, you may actually note a small arc or corona during a modulation peak. This could be caused by dirt, a bad connection, or even a component that is defective.

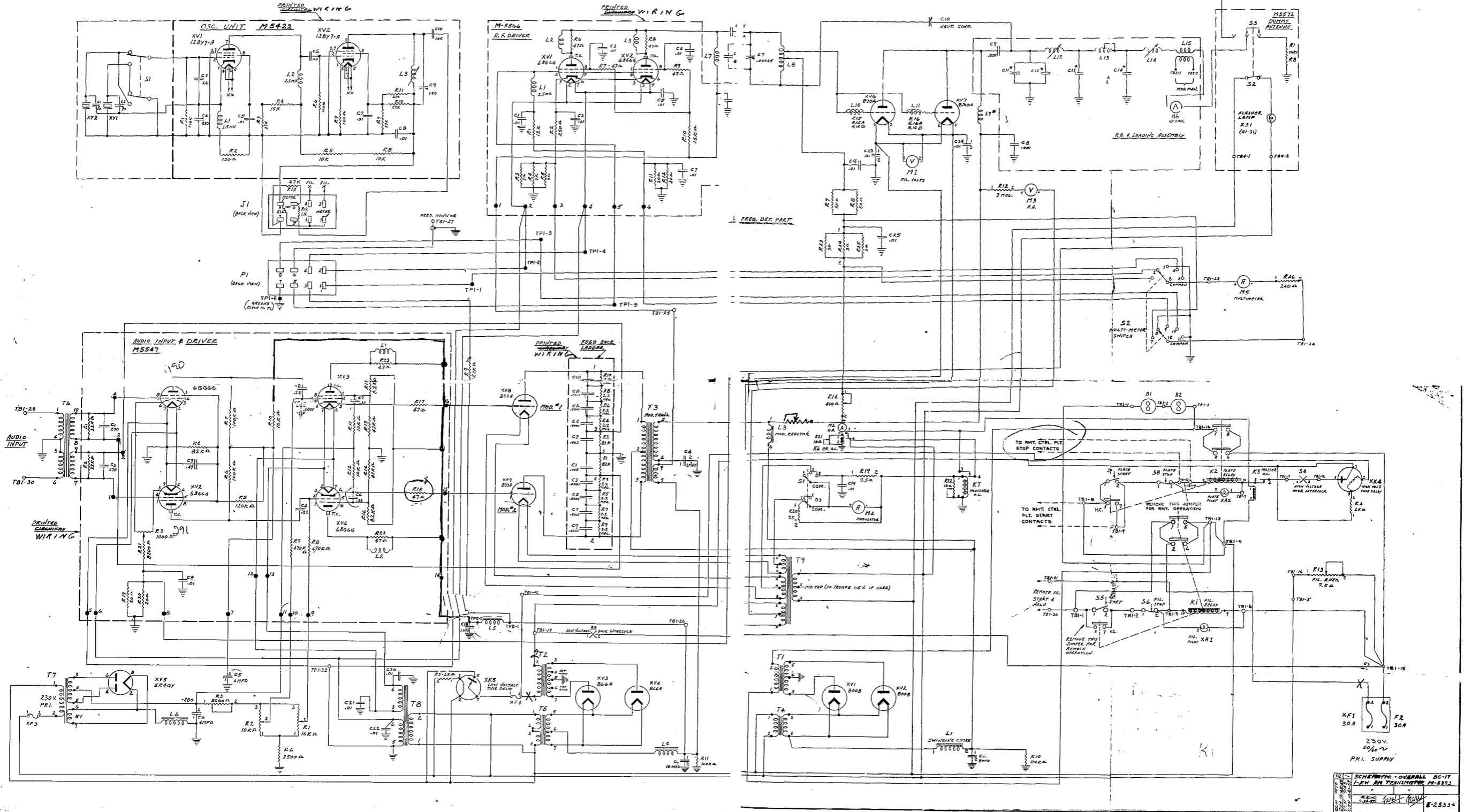

5-  
200  
50  
600

17-9918

GATRS  
BALDWIN 2-5202

V FIL ON N.O. to TB1-20 + TB1-21 - must hold closed / Fail safe or fil stop locks it open  
 FIL OFF  
 PLT ON N.O. TB1-8 to TB-9  
 PLT OFF N.C. TB1-23 to TB1-10 (Remove jumper from TB1-10 to TB1-22)

NO.	REVISION	DATE	BY
1	SCHEMATIC - OVERALL DC-IT		
2	1-KV AM TRANSMITTER M-5512		
3			
4			
5			
6			
7			
8			
9			
10			
11			
12			
13			
14			
15			
16			
17			
18			
19			
20			
21			
22			
23			
24			
25			
26			
27			
28			
29			
30			