

**RADIO BROADCAST
AND COMMUNICATIONS
EQUIPMENT**

HARRIS



GATES DIVISION
Harris-Intertype Corporation

INTRODUCTION

Gates Division of Harris-Intertype Corporation proudly presents one of the most comprehensive selections of radio broadcast equipment ever assembled in one catalog. Here you will find a complete line of AM, FM and Short-wave Broadcast Transmitters together with the world's most extensive line of audio control consoles and studio equipment.

Television transmitters, VHF and UHF antennas, studio and film cameras and video equipment are covered in Part Two of Catalog No. 100.

Harris' broadcast equipment produced by its Gates Division is noted for its quality of craftsmanship and excellence of engineering design. Our goal has always been to set the standards for others to meet. In recent years this determination has led to the pioneering of such outstanding products as: The first FCC type accepted 100% solid-state FM exciter, a 50 kW AM Transmitter with the patented Gates' Pulse Duration Modulator, Criterion tape cartridge equipment, Touch-Control Digital Program Automation Systems, and the first solid-state Digital AM Frequency Monitor unaffected by percentages of modulation over 95%. You will find these, and many more Gates' "firsts", on the following pages.

Field sales and service is extensive. Branch offices are located in New York, Washington, Cleveland, Atlanta, Houston, Chicago, Denver and Los Angeles. Gates' Service Centers carry a large inventory of equipment and service parts, serving the Eastern Seaboard from the Service Center located in New York City and the entire South and Southwest from the Service Center located in Houston. In Canada, sales are handled by Gates Canada, a Division of Harris-Intertype (Canada) Limited. Gates' International Sales Department, located in New York City, coordinates all international market activities with representatives located in most countries of the world.

Gates is a Division of Harris-Intertype Corporation, a world leader in graphic arts and electronics, and one of the nation's 500 largest corporations. The corporation's electronics divisions, in addition to Gates, include Radiation Systems, Harris Semiconductor, Harris Control, PRD Electronics, RF Communications and Intertype. Several research centers within Harris' electronic group enable Gates to draw from a large staff of scientists and engineers, as well as from the large engineering organization at Quincy, to assure our customers that Gates' broadcasting and communications equipment is synonymous with product leadership.

If your need is for any type of radio or television broadcasting equipment, we wholeheartedly invite your patronage. Each member of the Gates organization will do his very best to justify your confidence.

GATES DIVISION

HARRIS-INTERTYPE CORPORATION

Our Modern Manufacturing Facilities



Situated on an attractive 40-acre plot in Quincy, Illinois, the Gates factory has a total floor space of 108,000 square feet—and is one of the nation's most modern facilities devoted to the manufacturing of broadcast and electronics equipment.

Sales and Service Facilities

NEW YORK—Centralized Eastern Facilities of Gates Radio and Television Field Sales Offices, International Sales Department, and Gates New York Service Center are located at:

130 East 34th Street
New York, New York 10016

Telephone:

New York Service Center—Area (212) 889-0790
International Sales Dept.—Area (212) 725-9800

Gates New York and Houston Service Centers carry thousands of sundry items just for the broadcaster. Fast and efficient service from the New York Service Center to broadcasting stations on the East Coast and from the Houston Service Center to broadcasting stations in the South/Southwest, is available through today's air transportation system.



HOUSTON—Gates stock carrying branch.
4019 Richmond Avenue,
Houston, Texas 77027
Telephone: Area (713) 623-6655

WASHINGTON, D. C.—Gates Radio Company.
730 Federal Building, 1522 K Street, N.W.
Washington, D.C. 20005
Telephone: Area (202) 223-5508

LOS ANGELES—Attractive Western field sales office.
1945 South Figueroa,
Los Angeles, California 90007
Telephone: Area (213) 747-7129

CANADIAN SALES

MONTREAL OFFICE—Gates Radio Company
(Canada) Ltd.
212 Brunswick Boulevard,
Pointe-Claire, Quebec, Canada
Telephone: Area (514) 695-3751

TORONTO OFFICE—Gates Radio Company
(Canada) Ltd.
19 Lesmill Road,
Don Mills, Ontario, Canada
Telephone: Area (416) 447-7234



Table Of Contents

| | PAGE |
|--|------|
| AM BROADCAST TRANSMITTERS | 5 |
| <i>100 kW to 250 watt medium wave transmitters • Phasing and antenna coupling equipment • Modulation and frequency monitors • Dummy antennas</i> | |
| FM BROADCAST TRANSMITTERS | 35 |
| <i>40 kW to 10 watt transmitters • Dual FM transmitters • Stereo and SCA generators • FM relay packages • Transmitting antennas • Modulation frequency monitors</i> | |
| BROADCAST TRANSMITTER ACCESSORIES | 67 |
| <i>Transmission line • Antenna towers • Tower lights • Inductors and mica capacitors</i> | |
| AUDIO CONTROL CONSOLES | 77 |
| <i>Monaural and stereo four-channel mixers • Multi-channel and dual programming consoles</i> | |
| PROGRAM AUTOMATION | 107 |
| <i>Digital touch-control programmer • Multiple cartridge program sources • Digital clock • Time announce • Clear-text program logging • Music service</i> | |
| AUDIO EQUIPMENT | 119 |
| <i>Solid state limiter • Automatic gain control amplifiers • System-type audio amplifiers • Accessories • Speakers and baffles • Microphones • Remote amplifiers • Turntables • Equipment cabinets • Criterion cartridge system • Tape recorders</i> | |
| HIGH FREQUENCY BROADCAST TRANSMITTERS | 165 |
| <i>100 kW to 10 kW shortwave transmitters • Multi transmitter control consoles</i> | |
| SINGLE SIDEBAND AND COMMUNICATIONS TRANSMITTERS | 173 |
| <i>ISB Exciters • HF linear amplifiers • ISB HF transmitters</i> | |
| REMOTE CONTROL EQUIPMENT | 185 |
| <i>Transmitter remote control • Remote pick-up equipment • STL equipment • Transmitting tubes • Transistors</i> | |
| INDEX | 197 |

The mechanical and electrical design of the equipment described herein is subject to change without notice as deemed necessary by Gates Division of Harris-Intertype Corporation or its suppliers in the interest of advancing industry requirements or the state of the art.

Copyright by Gates Division of Harris-Intertype Corporation

Price: \$10.00

AM BROADCAST TRANSMITTERS

HARRIS
 **GATES DIVISION**
Harris-Intertype Corporation

100,000 Watt Medium Wave Broadcast Transmitter



MODEL VP-100

Gates VP-100 is the most advanced 100 kW medium wave transmitter in the world. It provides an over-all performance superior to that of any other AM broadcast transmitter in the same power range—at lower operating costs. With its amazingly high efficiency, and advanced cooling system design, this transmitter represents the latest state-of-the-art in high power broadcast equipment.

HIGH EFFICIENCY—EXCEEDS 65%: The modulation system employed in the VP-100 transmitter is almost 90% efficient (instead of the usual 50% or 60%), enabling the transmitter to achieve an unusually high over-all efficiency of greater than 65%. This means about one-third less power consumption than that of other high-level plate modulated 100 kW transmitters.

ONLY FIVE TUBES: The entire transmitter employs just five tubes—with modern ceramic 4CV100,000C tetrode power tubes operating well below manufacturer's dissipation ratings. All power supplies utilize long-life solid state silicon rectifiers. Highest quality components, conservatively rated, are used throughout the VP-100 to assure a maximum degree of reliability.

CONTINUOUS 100% MODULATION RATING: This continuous sine wave modulation capability permits a higher average modulation (such as trapezoidal) to boost signal strength, without increasing transmitted carrier power. Another feature of this high efficiency modulation system is convenient front panel carrier power adjustment over a wide range.

QUIET OPERATION: Cooling by the Vapor Phase method reduces noise by eliminating the need for large blowers. The heat exchanger is cooled by a single two horsepower blower, resulting in whisper-quiet operation. Vapor Phase Cooling also extends tube life by helping to eliminate "hot spots" and maintains tube anode temperatures far below those attained by other methods.

GREATLY REDUCED FLOOR SPACE: Due to the high efficiency of the transmitter, and the elimination of large iron core components such as the modulation transformer and modulation reactor, the VP-100 requires only 8.8 square meters (95 square feet) of floor space. The advanced cabinet design provides easy accessibility to all components.

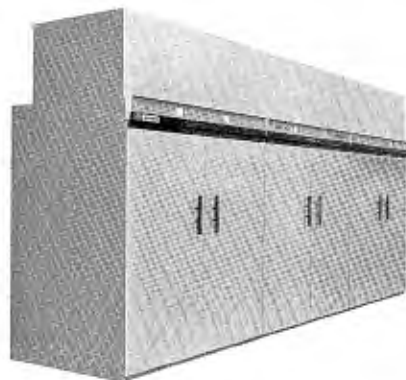

VP-100 with heat exchanger.

100,000 Watt Medium Wave Broadcast Transmitter—VP-100

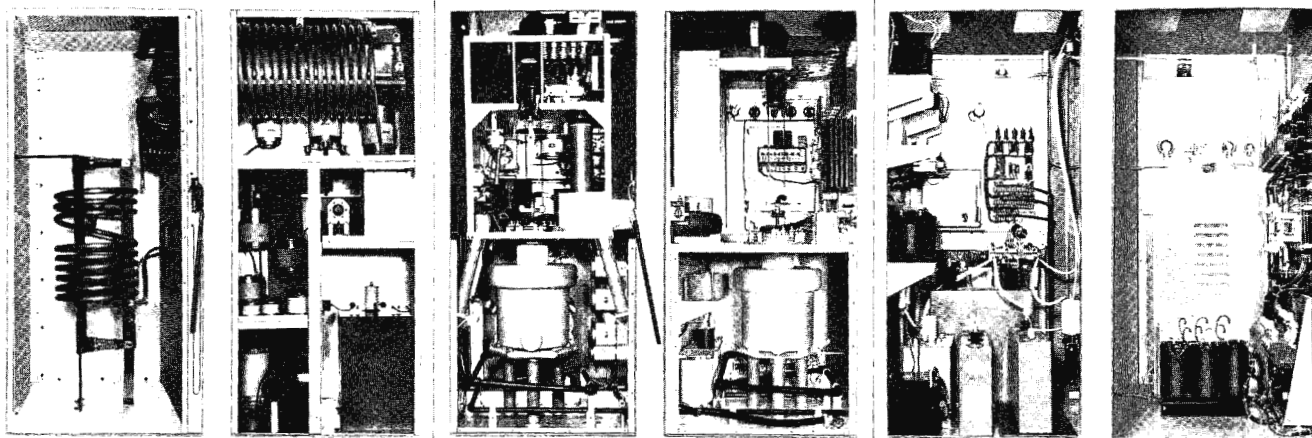

RF Output Cabinet.

Power Amplifier and Modulator Cabinet.

AC Control Cabinet.

Rear View of VP-100 with doors removed.

RF SECTION: The RF chain is conventional, using a transistorized oscillator, buffer, emitter follower, and a 4CX1500B tetrode tube amplifier to drive a single 4CV100,000C tetrode Class C power output stage. An automatic drive control limits the PA screen current to 2.2 amps, eliminating the usual problem of over dissipating the screen of a tetrode during tune-up. A convenient efficiency meter peaks as the efficiency of the transmitter increases, to allow rapid tuning. No "trial-and-error" tune-up methods are necessary.

THE MODULATION SYSTEM: This advanced system is characterized by low plate dissipation and low tube peak currents; peak cathode currents are about one-half that of other 100 kW transmitters. Average plate dissipation runs substantially below rated levels, and all peak voltages are main-

tained well below component ratings. Wide frequency response is possible as large reactive components are not used in the system. Control of the transmitter power output over a wide range is by means of a front panel vernier control. No adjustment is necessary in any high power RF circuits, including the loading coil.

PROTECTIVE CIRCUITS: All major components of the VP-100 are protected by circuit breakers. Tubes and transistors are protected by overload relays or current-limiting devices. A quick-acting series "crowbar" circuit protects against damage from high voltage arcs by limiting the energy in such arcs to less than 10 watt seconds. Protection against voltage standing wave ratios of greater than 1.2 to 1.0 is provided . . . both forward and reflected power is metered at the front panel. In case of momentary RF overloads the VP-100 will recycle twice automatically. Should a third overload occur within a thirty second period, the transmitter will remain off until manually reset. However, if the time between overloads is greater than thirty seconds, continuous recycling will occur.

TRAPEZOIDAL RESPONSE: Trapezoidal modulation may be used to gain additional power on the air without increasing transmitted carrier power. To do this the audio input wave (A), at left, is flattened at the top, by clipping, then reamplified to form a trapezoidal wave (B). The shaded areas in the diagram indicate the power gain. All the additional power gained by clipping the audio input is delivered at the output of the transmitter, thus increasing volume at the receiver.

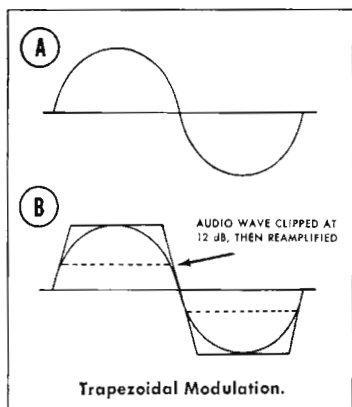

100,000 Watt Medium Wave Broadcast Transmitter—VP-100

DUAL OSCILLATOR AND MODULATOR: Gates has provided redundancy in all transistor sections to relieve any concern over solid state circuitry in high-power transmitters. Although the reliability of transistor circuitry has been proven in transmitters now operating under extreme conditions, this duplication is your double assurance of dependability.

DESIGNED FOR A WIDE RANGE OF CLIMATES: The VP-100 will give top performance in a wide range of climates—from hot and humid, to dry and dusty. With Vapor Phase Cooling, ducting outside air into the transmitter is not necessary. All transformers and similar components are hermetically sealed, encased, or vacuum impregnated. All high power radio frequency networks contain silver-plated inductors and vacuum capacitors.

TRANSMITTER LAYOUT: The standard VP-100 consists of three cabinets, a heat exchanger designed for mounting on top of the cabinets, and an external high voltage power transformer. Front and rear doors, and meter panel are magnetically latched. External connections to the transmitter are made through the top of the units so that floor ducts are not necessary.

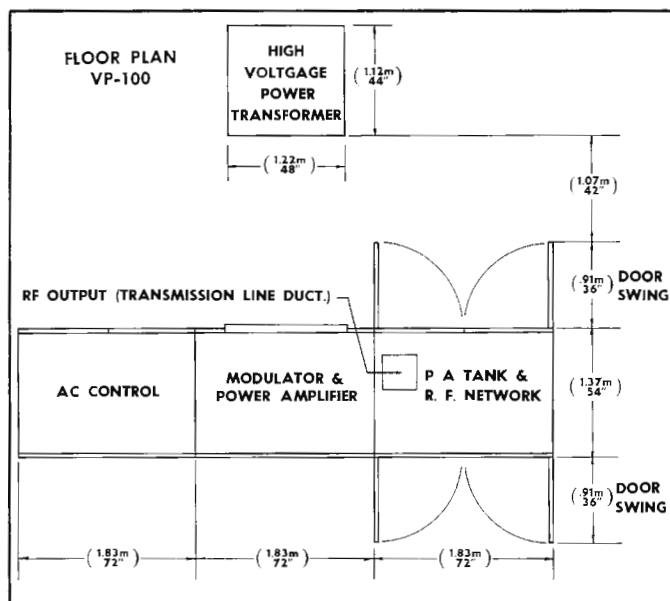

SPECIFICATIONS

POWER OUTPUT: 100,000 watts nominal unmodulated; capable 110,000 watts.

RF FREQUENCY RANGE: 535 kHz to 1620 kHz.

RF OUTPUT IMPEDANCE: 230 ohms, unbalanced. Other output impedances available as specified.

FREQUENCY STABILITY: ± 10 Hz of assigned frequency.

CARRIER SHIFT: Less than 4% at 100% modulation.

MODULATION: High level.

TRAPEZOIDAL MODULATION: Less than 5% tilt or overshoot 100 Hz to 2,000 Hz.

MODULATION LEVEL: 100% sinusoidal, continuously, over an audio frequency range of 50-5000 Hz.

RF HARMONICS: -80 dB below fundamental (well within CCIR requirements).

AUDIO FREQUENCY RESPONSE: ± 1.5 dB from 50 to 10,000 Hz, referenced to 1000 Hz at 95% modulation.

AUDIO FREQUENCY DISTORTION: Less than 3% from 100 to 7500 Hz; 4% from 50 to 10,000 Hz at 95% modulation.

NOISE: -55 dB below 1000 Hz, 100% modulated level.

AUDIO INPUT IMPEDANCE: 600/150 ohms, balanced or unbalanced.

AUDIO INPUT LEVEL: +10 dBm ± 2 dB at 1000 Hz for 100% modulation.

POWER CONSUMPTION: 155 kW—No Modulation.
160 kW—30% Modulation.
215 kW—100% Modulation.

POWER INPUT: Any specified voltage 380 V to 480 V, $\pm 5\%$, 3 phase, 50 or 60 Hz as ordered.

POWER FACTOR: 95%.

VOLTAGE REGULATOR: Built-in electronic voltage regulator for all power supplies other than high voltage.

CROWBAR RESPONSE: Less than 5 microsecond operate time.

OVER-ALL EFFICIENCY: 65% @ average modulation.

ALTITUDE: Up to 1829 meters (6000 feet) above sea level (higher on special order).

TEMPERATURE RANGE: Ambient air temperature from -20°C to $+50^{\circ}\text{C}$ (with Dowanol* in water system).

STORAGE TEMPERATURE: -35°C to $+60^{\circ}\text{C}$.

HUMIDITY: Up to 95% maximum within the above temperature range.

SIZE: Each of the three cabinets measures 1.83 meters (6 feet) wide, 1.37 meters (4.5 feet) deep, and 1.98 meters (6.5 feet) high. The heat exchanger adds another 1.21 meters (4 feet) in height. The HV transformer measures 1.21 x 1.12 x 1.52 meters (48" x 44" x 60").

WEIGHT: Export packed 8165 kilograms (18,000 lbs.). Main transmitter assembly 5443 kg (12,000 lbs.). Power transformers 2268 kg (5000 lbs.). Heat exchanger 454 kg (1000 lbs.).

CUBAGE: Export packed 39.6 cubic meters (1400 cubic feet). Main transmitter assembly 31.6 cu. meters (1115 cu. ft.). Power transformer 3.8 cu. meters (135 cu. ft.). Heat exchanger 4.1 cu. meters (150 cu. ft.).

FINISH: Two-tone beige-gray.

TUBES: Two, 4CV100,000C; two, 4CX1500B; one, F-1099 (damper diode).

ORDERING INFORMATION

Model VP-100 with one set of tubes and two crystals.....994-6561

100% set spare tubes for VP-100 transmitter.....990-0566

Recommended minimum spare tubes for VP-100 transmitter.....990-0567

* Trademark of Dow Chemical Company.

HARRIS
GATES DIVISION
Harris-Inter-type Corporation

50,000 Watt Medium Wave Broadcast Transmitter

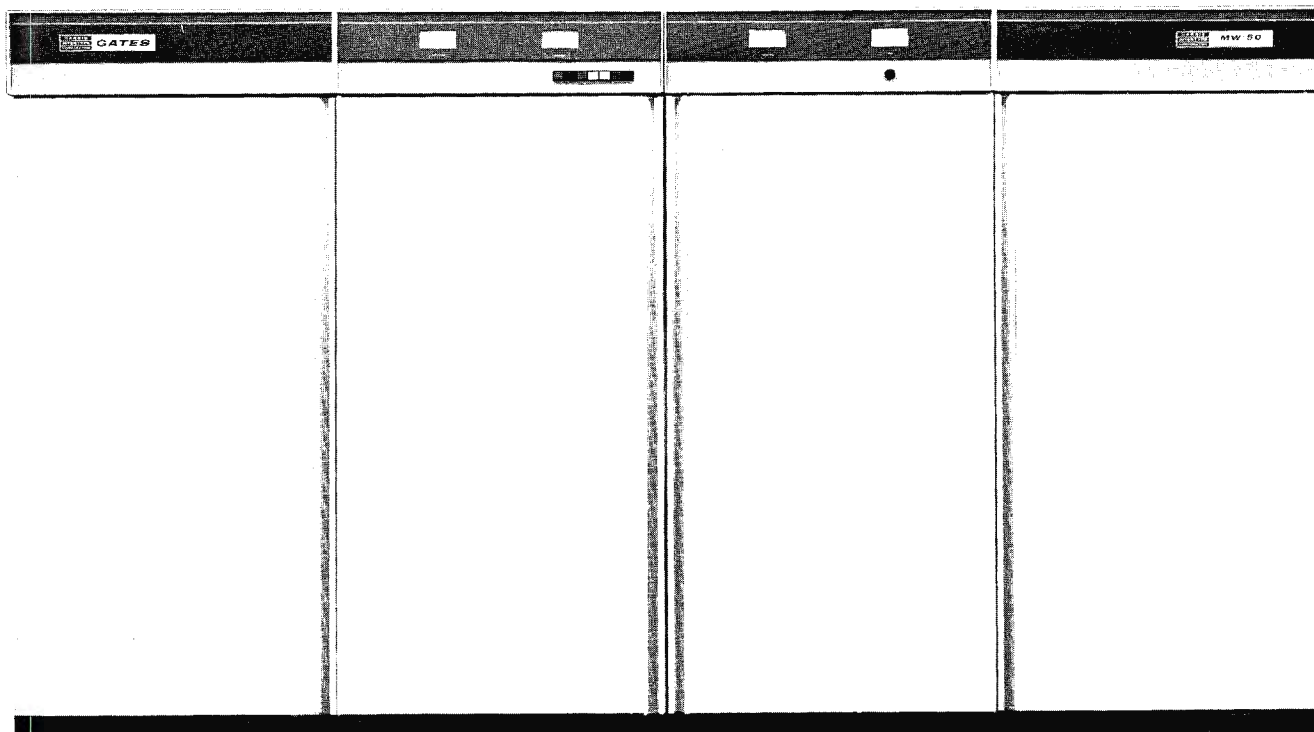

MODEL MW-50

Gates' MW-50 is the most advanced 50 kilowatt medium wave transmitter in the world, providing an overall performance superior to that of any other AM broadcast transmitter in the same power range, at lower operating costs. With Gates' exclusive high level plate modulation, using a Pulse Duration Modulator (PDM), this transmitter represents the latest state of the art in high power broadcast equipment.

HIGH EFFICIENCY—EXCEEDS 60%: The Pulse Duration Modulator employed in the MW-50 is nearly 90% efficient (instead of the usual 50% or 60%), enabling the transmitter to achieve an unusually high overall efficiency of greater than 60%. This means less power consumption than that of the other 50 kilowatt medium wave transmitters currently available.

ONLY FIVE TUBES: The entire transmitter employs just five tubes—with modern ceramic 4CX35,000C tetrode power tubes operating well below manufacturer's dissipation ratings. Only three tube types are used, which simplifies the stocking of spares. All power supplies use long-life solid state silicon rectifiers. Highest quality components, conservatively rated, are used throughout the MW-50 to assure a maximum degree of reliability.

CONTINUOUS 100% MODULATION RATING: This continuous sine wave modulation capability permits a higher aver-

age modulation to boost signal strength without increasing transmitted carrier power. The MW-50 provides 130% positive peak capability when operating at full 50 kilowatt RF power output. Another feature of this high efficiency series type modulator is that the carrier power may be adjusted from the front panel without changing the loading.

MAXIMUM CARRIER POWER 60 KILOWATTS: The Gates MW-50 provides a maximum carrier power of 60 kilowatts, which allows more reserve for driving directional arrays than any other 50 kilowatt medium wave broadcast transmitter. The MW-50 uses DC feedback for power output stability, which insures a minimum RF power output change with a change of the power line voltage. The MW-50 can be switched smoothly from high to low power with the carrier on.

EASY TUNING: Output network tuning is accomplished by PA plate tune and loading control of the power amplifier stage, which operates as a standard Class C amplifier. Automatic gain control on the power amplifier screen allows tuning of the Type 4CX35,000C tetrode as if it were a triode, without any risk of over-dissipating the screen. After PA tuning and loading controls are optimized, power output is controlled in the low level PDM stage. In case of a power line failure, the MW-50 is equipped to automatically return to full power operation.

50,000 Watt Medium Wave Broadcast Transmitter—MW-50

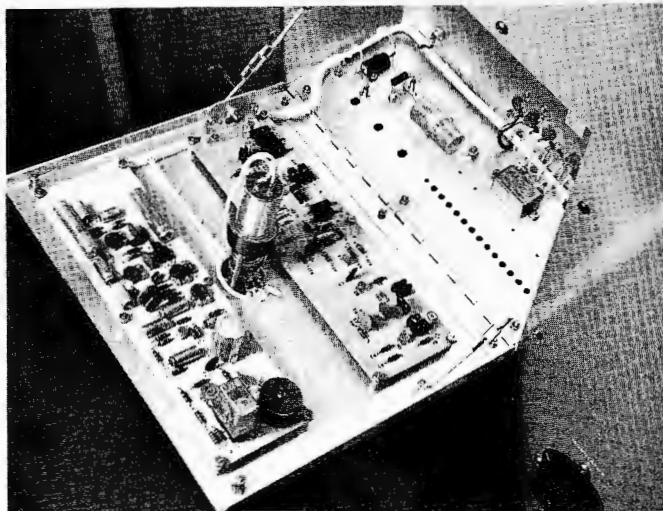

Low level Pulse Duration Modulator chassis, showing power control, low level Pulse Duration Modulator and audio input/control board.

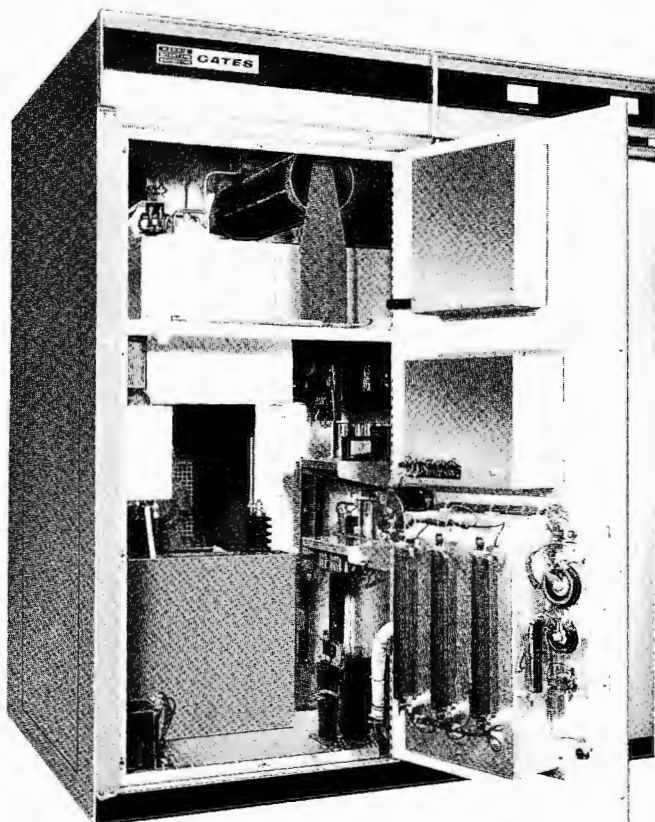

Modulator cubicle, showing modulator, modulator driver, 70 kHz filter, power supplies and control.

THE MODULATION SYSTEM: Gates' exclusive Pulse Duration Modulation system produces conventional high level plate modulation—the difference is simply the manner in which the audio signal is amplified and applied in series with the RF amplifier plate supply. The Pulse Duration Modulator is characterized by low plate dissipation and low tube peak currents. Peak cathode currents are about one-half that of other 50 kilowatt transmitters. Average plate dissipation runs substantially below rated levels, and all peak voltages are maintained well below component ratings. In addition, the PDM design allows continuous 100% sine wave modulation.

The modulator efficiency is about 90%, and a wide frequency response is possible, as large reactive components are not used in the modulation system.

Control of the transmitter power output over a wide range is accomplished in a low-level stage of the modulator by means of a convenient front panel vernier control. No adjustment is necessary in any high power RF circuit, including the loading capacitor.

RF SECTION: The RF chain is conventional, using a transistorized oscillator, buffer, emitter follower, and a 4CX1500A tetrode tube amplifier to drive a single 4CX35,000C tetrode Class C power output stage.

An automatic drive control limits the PA screen current to 1.8 amps, eliminating the usual problem of over-dissipating the screen of a tetrode during tune-up.

PROTECTIVE CIRCUITS: All major components of the MW-50 are protected by circuit breakers. Tubes and transistors are protected by overload relays or current-limiting devices.

In case of momentary RF overloads, the MW-50 will recycle automatically. Should a repeated overload occur within a thirty-second period, the transmitter will remain off until manually reset. However, if the time between overloads is greater than thirty seconds, continuous recycling will occur.

QUIET AIR COOLING: Cooling of the MW-50 is accomplished by a 3 horsepower blower, 3200 CFM at 2" water, located in the transmitter cabinet, which provides cooling for the power tubes at a very low noise level. The transmitter cabinet air is flushed with a low speed fan which also operates at a very low noise level. Provisions are made at the top of the transmitter for ducting the exhaust air to the outside of the transmitter building.

EASY ACCESS: All components are readily accessible through the four rear doors and one front access door. Meter panels are hinged for easy inspection and maintenance.

TRANSMITTER LAYOUT: The MW-50 consists of two cabinets and an external high voltage power transformer. External connections to the transmitter are made through either the top or the bottom of the unit, as desired, for great installation flexibility.

50,000 Watt Medium Wave Broadcast Transmitter—MW-50

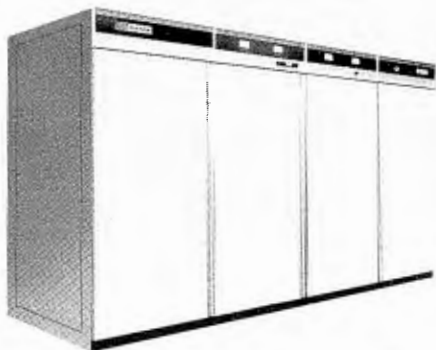
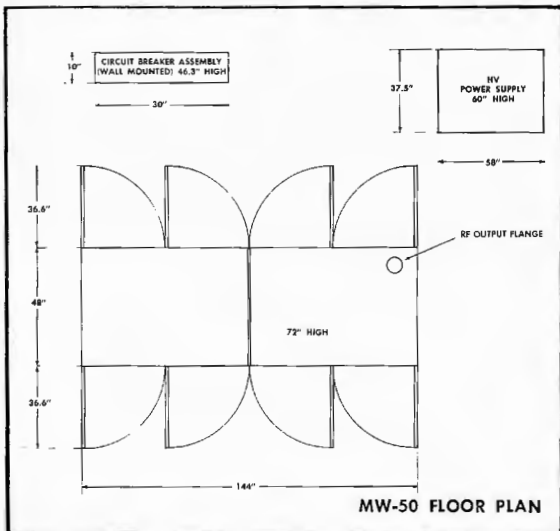
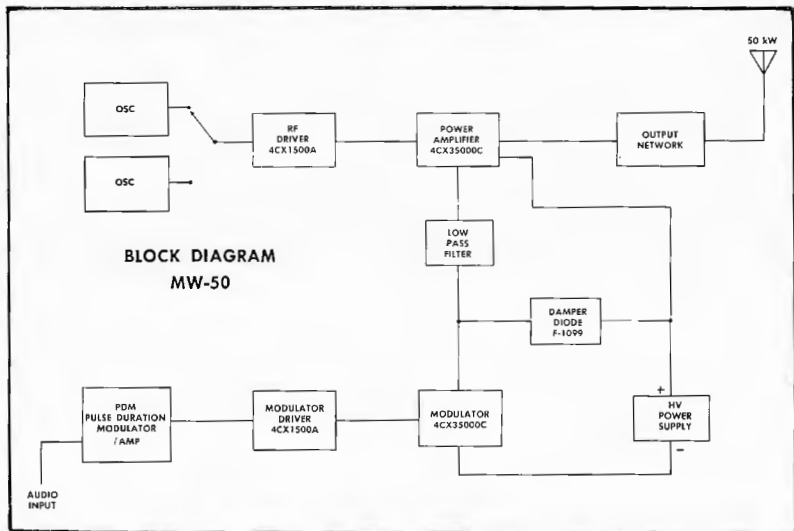

SPECIFICATIONS

POWER OUTPUTS: 50,000 watts (rated), 60,000 watts (capable). Convenient power reduction to 25,000 or 10,000 watts.

RF FREQUENCY RANGE: 535 kHz to 1620 kHz, supplied to frequency as ordered.

RF OUTPUT IMPEDANCE: Any impedance from 50 to 300 ohms unbalanced.

RF FREQUENCY STABILITY: ± 5 Hz.

RF HARMONICS: Exceeds FCC and CCIR specifications.

CARRIER SHIFT: Less than -2% at 100% modulation.

MODULATION CAPABILITY: Positive peaks 130%, negative peaks 100%.

AUDIO FREQUENCY RESPONSE: ± 1.5 dB, from 20 to 10,000 Hz, referenced to 1,000 Hz, at 95% modulation.

AUDIO FREQUENCY DISTORTION: Less than 3%, 20 to 10,000 Hz at 95% modulation.

NOISE: (Unweighted) -60 dB or better below 100% modulation.

AUDIO INPUT: 600/150 ohms at $+10$ dBm ± 2 dB, for 100% modulation.

POWER INPUT: 380 V, or 480 V $\pm 5\%$, 3 phase, 50/60 Hz.

POWER CONSUMPTION: 80 kW at 0% modulation
87 kW at 30% modulation
110 kW at 100% modulation

OVERALL EFFICIENCY: Better than 60% at average modulation.

POWER FACTOR: 95%

TEMPERATURE RANGE: 0°C to $+50^{\circ}\text{C}$.

HUMIDITY: 95%.

ALTITUDE: Up to 3,048 meters (10,000 feet) above sea level. (Higher on special order.)

SIZE: 78 inches high, 144 inches wide, 48 inches deep (transmitter cabinet). External components include high voltage power supply and wall mounted circuit breaker assembly.

FLOOR SPACE: Main transmitter assembly 48 square feet. Power supply 15 square feet.

WEIGHT: (APPROXIMATE) Main transmitter assembly

| | |
|---------------------|------------|
| Net unpacked | 5,000 lbs. |
| Domestic packed | 6,000 lbs. |
| Export packed | 7,200 lbs. |
| Power Supply | |
| Net unpacked | 1,650 lbs. |
| Domestic packed | 1,780 lbs. |
| Export packed | 2,080 lbs. |

CUBAGE: Packed: 700 cubic feet.

FINISH: Beige-gray.

TUBES USED: (2) 4CX35,000C; (2) 4CX1500A; (1) F-1099.

ORDERING INFORMATION

| | |
|---|----------|
| Model MW-50, with one set of tubes and two crystals | 994-6994 |
| 100% set of spare tubes for MW-50 transmitter | 990-0711 |
| Recommended minimum spare tubes for MW-50 transmitter | 990-0712 |



20,000 Watt Medium Wave Transmitter

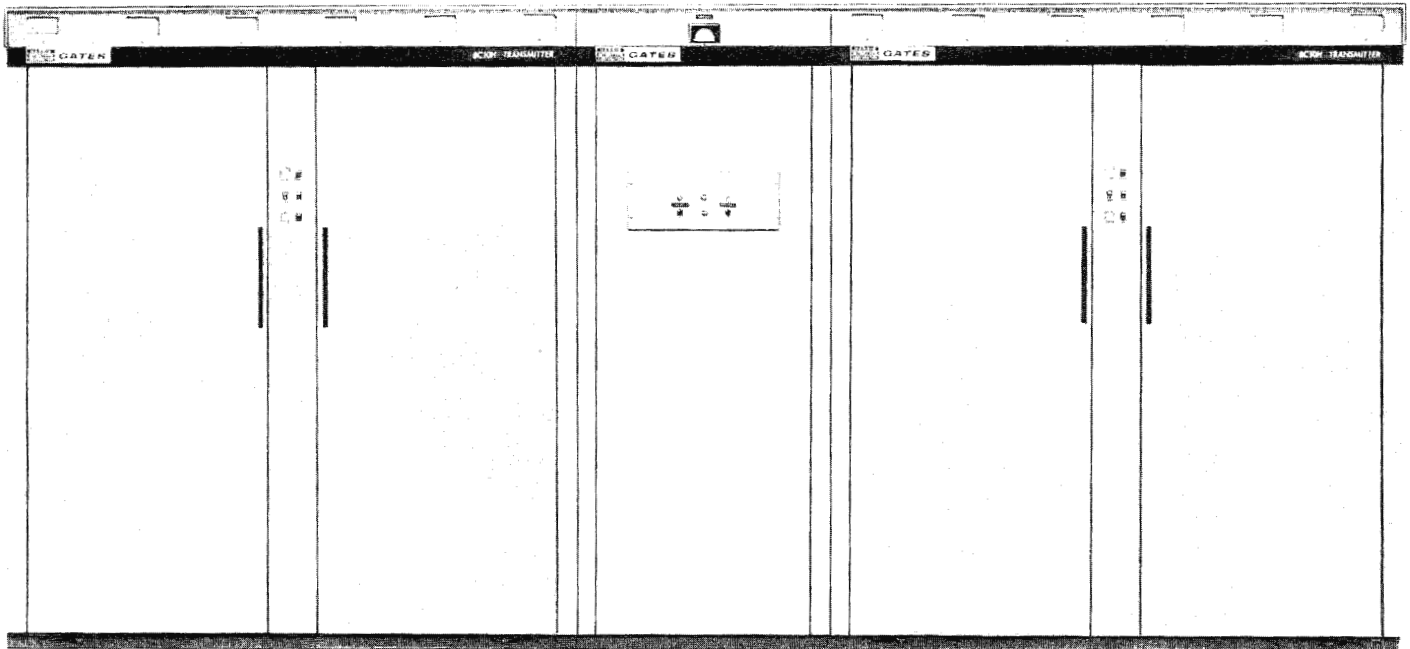

MODEL BC-20H

The BC-20H, 20 kW transmitter consists of two standard BC-10H 10 kW transmitters, a 20 kW combiner, and a common drive unit. All components are housed within the transmitter cabinet, eliminating the need for external ducting and enclosures. Askarel (oil) filled modulation transformers are provided as standard equipment for added reliability.

SOLID STATE CIRCUITRY: The BC-20H employs transistors in all circuitry except the RF driver, power amplifier and modulator for superior performance. Only ten tubes are used in the entire transmitter.

RF SECTION: In addition to the oscillator/exciter incorporated in each 10 kW transmitter, a third oscillator is provided in the BC-20H to permit maximum operating flexibility. This independent exciter is used as a common drive to each transmitter and is enclosed in the center cabinet. Output of this unit is split and drives independent buffer amplifiers for isolation and phase adjustment. The RF signal then feeds individual oscillators in each 10 kW transmitter, which in turn excites the 4-400 driver and the high level plate modulated 3CX2500F3 power amplifiers. Overall efficiency of the power amplifiers is typically 85% or better, a direct benefit of the

high efficiency RF circuits that are utilized.

RF output of each transmitter is fed into a bridged-tee combiner network, housed in the middle cabinet. A 10 kW dummy load is provided with an in-line RF ammeter for visual indication of current to the reject branch of the combiner network. Under optimum conditions, no current will exist in this branch. No critical adjustments are required and simplified overall operation is stable.

In the event that maintenance or adjustment, such as initial tune-up of the transmitters is required, the 10 kW dummy load may be switched manually so that the output of one power amplifier feeds the load directly while the other amplifier can drive the antenna system. While in the combined mode, monitoring is accomplished by a pickup loop at the combiner output for indication of modulation level of the entire transmitter system.

AUDIO SECTION: Audio is processed by a transistorized audio amplifier which drives the Class B 3CX2500F3 modulators. High level plate modulation techniques are used with enhanced performance obtained by applying audio to the RF driver stage.

20,000 Watt Medium Wave Transmitter-BC-20H

RELIABILITY: The design philosophy employed in the BC-20H assures long term operation with no lost air time. 100% redundancy of equipment means that a signal can remain on the air with no down time for maintenance. One transmitter can be turned off while the other continues to operate.

ADDITIONAL FEATURES: Important features include reliable silicon diodes in all power supplies; built-in circuitry for remote control; ample cooling for all climatic conditions with quiet, low-speed blowers; and low operating cost, with only two tube types used in the BC-20H.

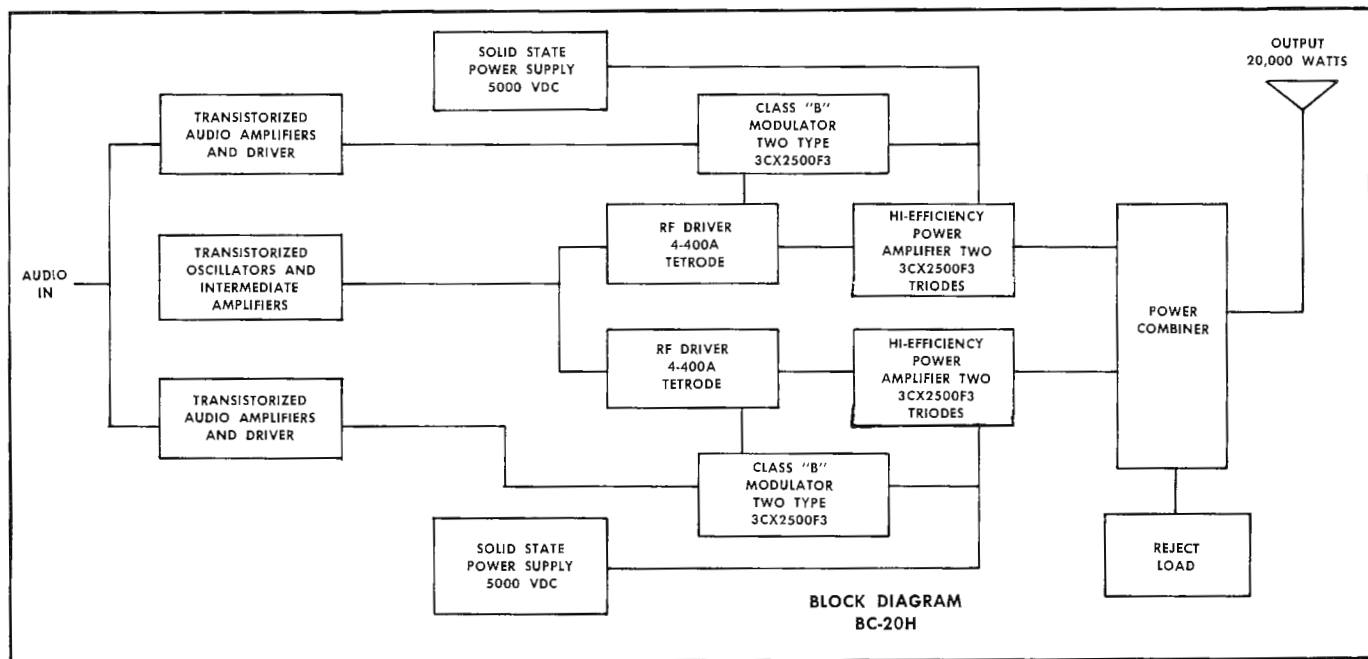

SPECIFICATIONS

POWER OUTPUT: (Rated) 20,000 watts. (Capable) 21,600 watts.

RF FREQUENCY RANGE: 535 kHz to 1620 kHz, supplied to one frequency as ordered.

RF OUTPUT IMPEDANCE: Supplied for 50 ohms, or other as specified.

RF FREQUENCY STABILITY: ± 2 Hz.

CARRIER SHIFT: Less than 3% at 100% modulation.

RF HARMONICS: Meets or exceeds FCC specifications.

AUDIO FREQUENCY RESPONSE: ± 1 dB, 50 to 10,000 Hz. $\pm 1\frac{1}{2}$ dB, 30-12,000 Hz.

AUDIO FREQUENCY DISTORTION: 2.5% or less 50 Hz to 10,000 Hz at 95% modulation.

NOISE: (Unweighted) 60 dB or better below 100% modulation.

AUDIO INPUT: 600/150 ohms at +10 dBm, ± 2 dB.

POWER INPUT: 208/230 volts, 3 phase, 50 or 60 Hz. 37 kW no modulation. 42 kW average modulation. 55 kW 100% modulation.

AMBIENT TEMPERATURE RANGE: -20° to $+50^{\circ}$ C.

ALTITUDE: To 7,500 feet standard (higher altitudes on special order).

SIZE: 78" high, 177" wide, 32" deep (completely self-contained).

WEIGHT: 5200 lbs. unpacked (approximate). 6800 lbs. export packed (approximate).

CUBAGE: 390 cubic feet packed.

FINISH: Beige-gray.

TUBES USED: (8) 3CX2500F3; (2) 4-400A. Total: 10.

GENERAL INFORMATION: Monitors: 10 RF volts output at 50/70 ohms for frequency and modulation monitors.

ORDERING INFORMATION

Model BC-20H transmitter, consisting of two standard BC-10H 10 kW transmitters, a 20 kW combiner and a common drive unit

994-6669

10,000 Watt Medium Wave Broadcast Transmitter



MODEL BC-10H

The most outstanding 10,000 watt AM transmitter on the market today, the BC-10H has gained wide acceptance and approval from broadcasters throughout the country since its introduction. Excellent on-the-air quality, high reliability, and low operating costs are proven features that have helped to make the BC-10H so popular.

SOLID STATE CIRCUITRY: The BC-10H uses transistors in all circuits except the RF driver, power amplifier and modulator to provide a richer, fuller sound for the listener, and increased reliability for the broadcaster.

LOW TUBE COST: Ceramic type 3CX2500F3 triode tubes are used in the power amplifier and modulators, and a type 4-400A tetrode is used as the RF driver. All tubes are operated well below their maximum ratings for long tube life. This combination provides the lowest cost tube complement of any 10 kW AM broadcast transmitter on the market today.

RF SECTION: Two transistor oscillators are instantly switchable, and oscillator output is amplified to provide the proper signal level for the driver, a 4-400A tetrode, which is modulated to improve the over-all transmitter performance. The 4-400A drives two 3CX2500F3 power amplifiers which are high level plate modulated. These air-cooled power amplifiers have an efficiency as high as 90%, and feed a full Tee network. The RF output capability of the BC-10H, 10,800 watts, easily accommodates complicated multi-tower phasors.

AUDIO SECTION: Four push-pull solid state audio amplifier stages amplify the audio signal from input level to full drive power for the modulator stage. The modulator consists of two 3CX2500F3 triodes, operated Class AB₁. Inverse feedback, and an advanced design low leakage reactance modulation transformer/reactor group, results in signal quality of the highest fidelity. The modulation transformer is oil (Askarel) filled.

10,000 Watt Medium Wave Broadcast Transmitter—BC-10H

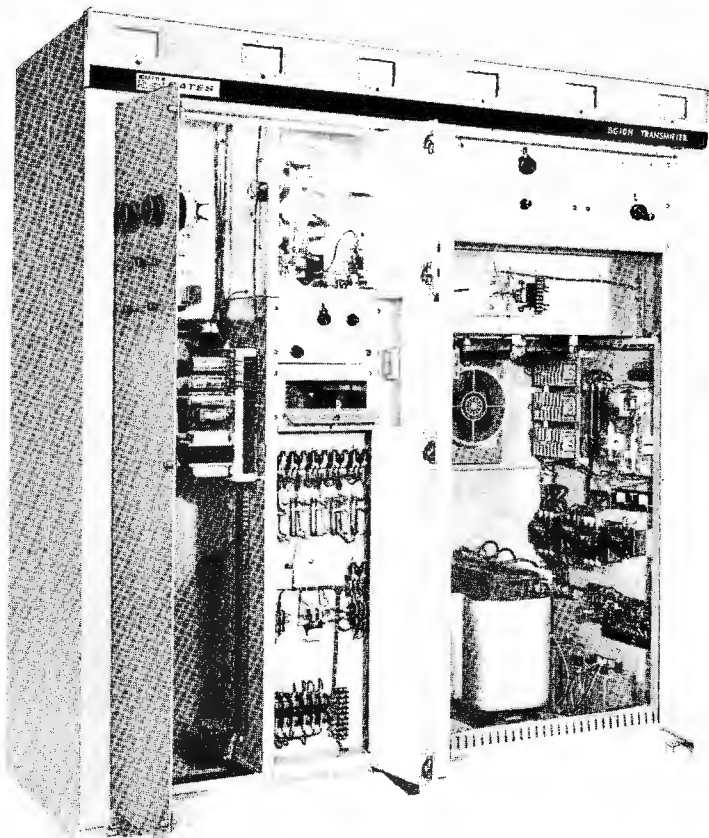

Front view, interior.

INTERCHANGEABILITY: Added tube life may be achieved from the 3CX2500F3 triodes by interchanging the modulators and the power amplifiers, as the same tube type is used in both stages.

SOLID STATE POWER SUPPLIES: Lifetime silicon rectifiers in all power supplies provide a 2 to 1 voltage and a 5 to 1 current safety factor. This high margin of safety assures trouble-free performance.

CONTROL CIRCUITRY: Careful attention has been given to the design of the control circuitry in the BC-10H. Complete AC and DC overload protection is standard equipment. A recycling feature, which will automatically turn the transmitter off when an overload occurs, is built-in.

HARMONIC RADIATION: A full Tee network and second harmonic trap are assurance that the BC-10H can exceed harmonic reduction regulations within the transmitter itself without relying on the harmonic attenuation of a phasor or

antenna coupler. Either of these then becomes a bonus factor in harmonic suppression.

EFFICIENT COOLING: Individual low-speed Rotron blowers in the RF and modulator stages, and a specially designed air exhaust, allow only a limited amount of direct heat to be dissipated into the interior of the BC-10H—for extra-cool operation.

OPERATING ECONOMY: Long tube life, low tube cost, and the highly efficient tank circuit combine to make economy of operation an important feature of the BC-10H.

ACCESSIBILITY: Designed for easy servicing, the transmitter front features 2 full length doors, with operational controls located between the two. Meters which indicate transmitter operating parameters are located across the front of the cabinet, above the doors. All necessary tuning controls are adjustable in full view of these meters. Further access to the transmitter from the front may be gained by releasing the catches on various front access panels. In addition, 4 panels may be removed from the rear of the transmitter for 100% accessibility.

The BC-10H is completely self-contained within one cabinet.

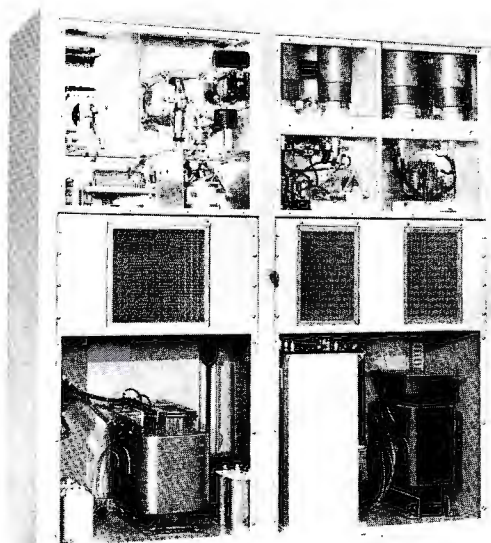

Rear view, interior.

HARRIS
GATES DIVISION
Harris-InterType Corporation

10,000 Watt Medium Wave Broadcast Transmitter—BC-10H

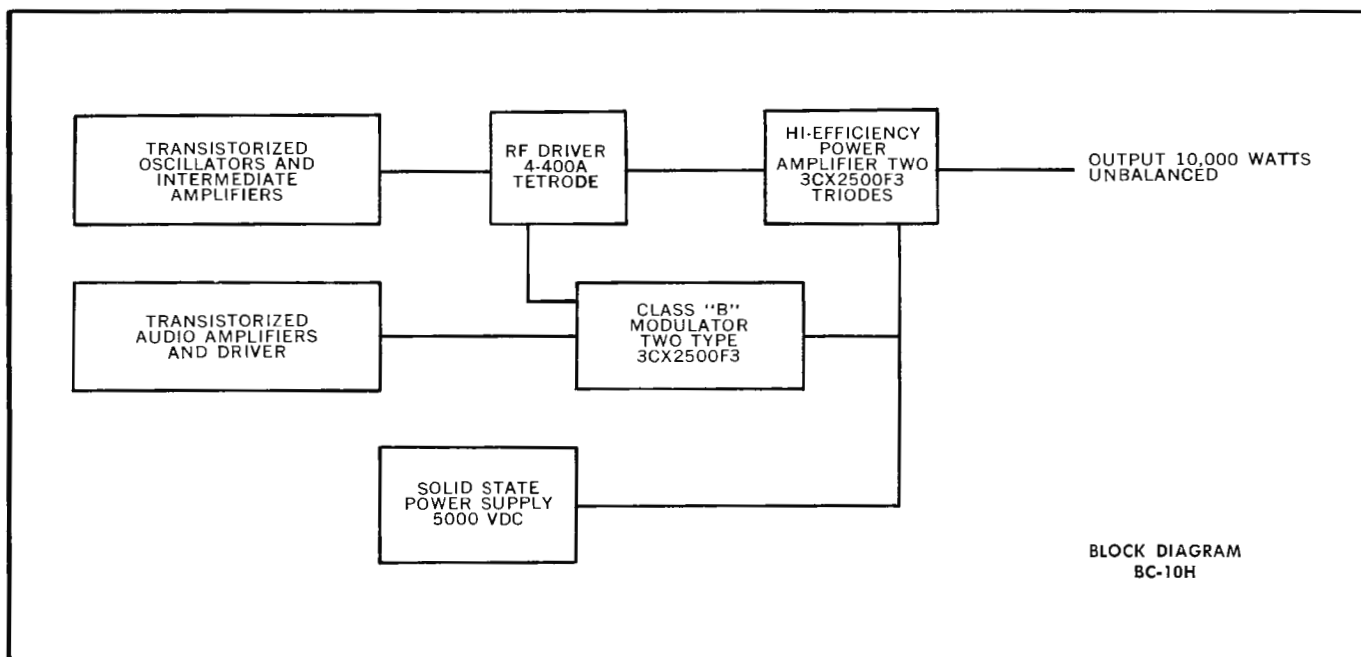

SPECIFICATIONS

POWER OUTPUT: (Rated) 10,000 watts. (Capable) 10,800 watts. Power reduction to approximately 2,500 watts included.

RF FREQUENCY RANGE: 535 kHz to 1620 kHz supplied to one frequency as ordered.

RF OUTPUT IMPEDANCE: Supplied for 50 ohms, or other as specified.

RF FREQUENCY STABILITY: ± 2 Hz.

CARRIER SHIFT: Less than 3% at 100% modulation.

RF HARMONICS: Meets or exceeds FCC specifications.

MODULATION CAPABILITY: Positive peaks 125%, negative peaks 100%.

AUDIO FREQUENCY RESPONSE: ± 1 dB, 50 to 10,000 Hz. $\pm 1\frac{1}{2}$ dB, 30-12,000 Hz.

AUDIO FREQUENCY DISTORTION: 2.5% or less 50 Hz to 10,000 Hz at 95% modulation.

NOISE: (Unweighted) 60 dB or better below 100% modulation.

AUDIO INPUT: 600/150 ohms at +10 dBm, ± 2 dB

POWER INPUT: 208/230 volts, 3 phase, 50 or 60 Hz. 18.5 kW zero modulation. 21.0 kW average modulation. 27.5 kW 100% modulation.

AMBIENT TEMPERATURE RANGE: -20°C to $+50^{\circ}\text{C}$.

ALTITUDE: To 7,500 ft. standard (higher altitudes on special order).

SIZE: 78" high, 72" wide, 32" deep (completely self-contained).

WEIGHT: 2,500 lbs. unpacked (approximate). 3,050 lbs. domestic packed (approximate). 3,250 lbs. export packed (approximate).

CUBAGE: 184 cubic feet packed.

FINISH: Beige-gray.

TUBES USED: (4) 3CX2500F3, (1) 4-400A. Total—5.

GENERAL INFORMATION Monitors: 10 RF volts output at 50/70 ohms for frequency and modulation monitors.

ORDERING INFORMATION

| | |
|--|----------|
| Model BC-10H transmitter with one set of tubes and two crystals..... | 994-6522 |
| 100% set spare tubes for BC-10H transmitter..... | 990-0539 |
| Set of spare transistors for BC-10H (diodes not included)..... | 990-0540 |
| Kit for remote control of power output..... | 994-6548 |

5000 Watt Medium Wave Broadcast Transmitter

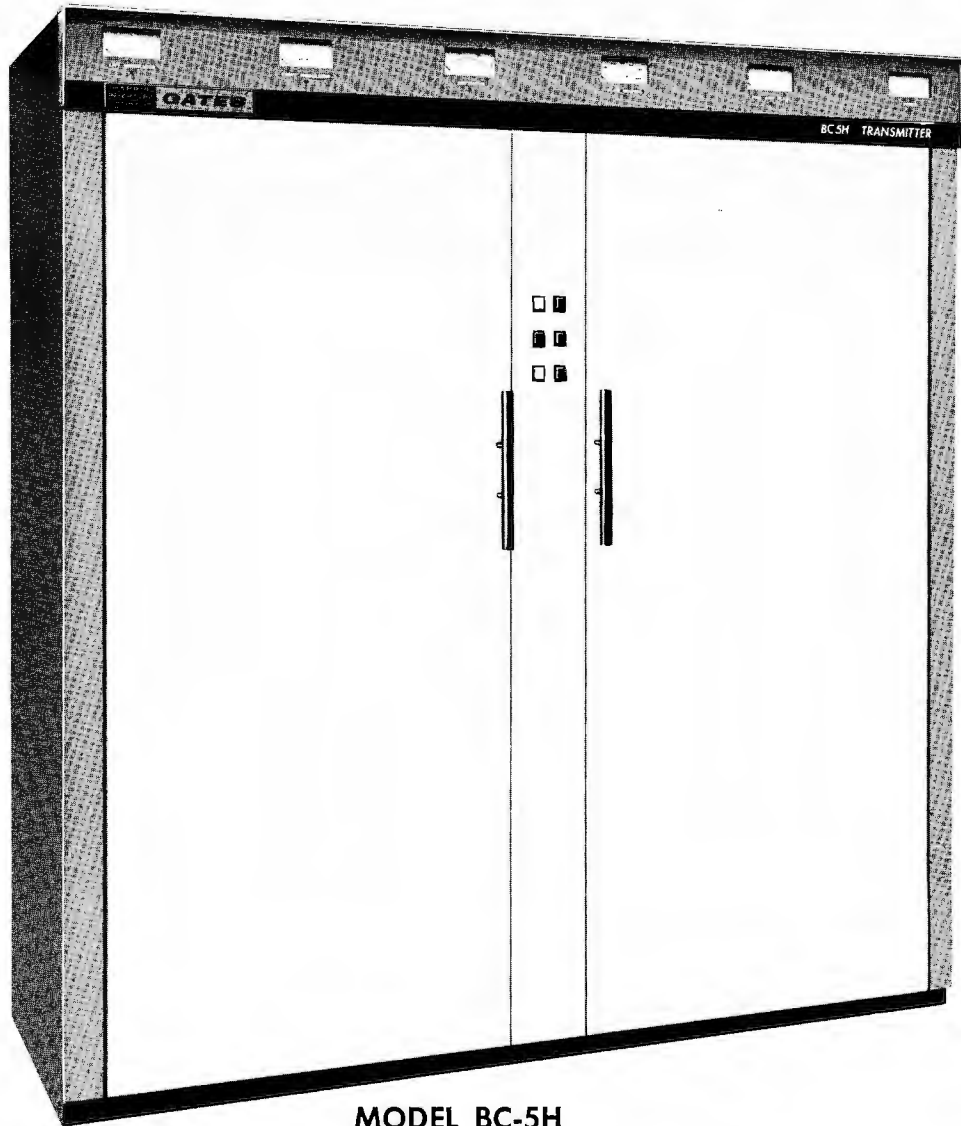

MODEL BC-5H

Representing the finest in engineering design, the BC-5H provides superb over-all performance, with top quality audio, high reliability, and extra low power consumption through the use of high efficiency power amplifier circuits.

The transmitter is completely self-contained, and requires a floor space of only 72 inches (wide) and 32 inches (deep). The over-all height is 78 inches.

Other features that have helped to make the BC-5H the most popular broadcast transmitter in its power range are: large edgewound silver plated tank and Tee network coils; a low leakage reactance modulation transformer for excellent sound quality; a design that permits easy attachment of remote control; unusually high efficiency; and lowest tube cost of any 5000 watt AM transmitter.

TRANSMISSION FIDELITY: Wide frequency response and low carrier shift are important considerations in the design of an AM transmitter. The extremely wide audio response and superior reproduction of audio dynamic range in the BC-5H testify to its advanced engineering development—evident to all who hear this transmitter's excellent broadcast signal.

RF SECTION: In the RF circuit, a transistor oscillator (instantly switchable to a back-up oscillator), drives a transistorized amplifier, which provides drive for the type 4-400A tetrode RF driver. This driver stage is modulated to improve the over-all performance of the transmitter. The 4-400A drives a single 3CX2500F3 power amplifier tube, which is high level plate modulated, and uses high efficiency RF circuits to improve the power amplifier efficiency to 90%. The power amplifier feeds a full Tee network.

5000 Watt Medium Wave Broadcast Transmitter—BC-5H

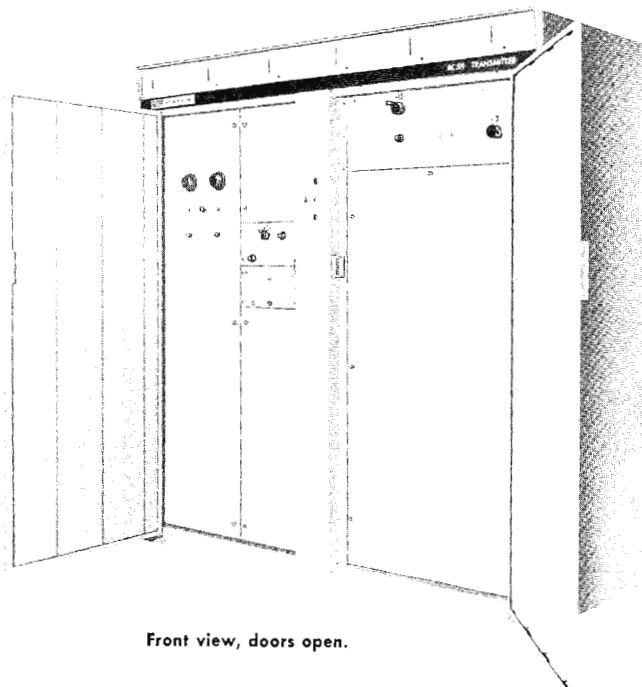
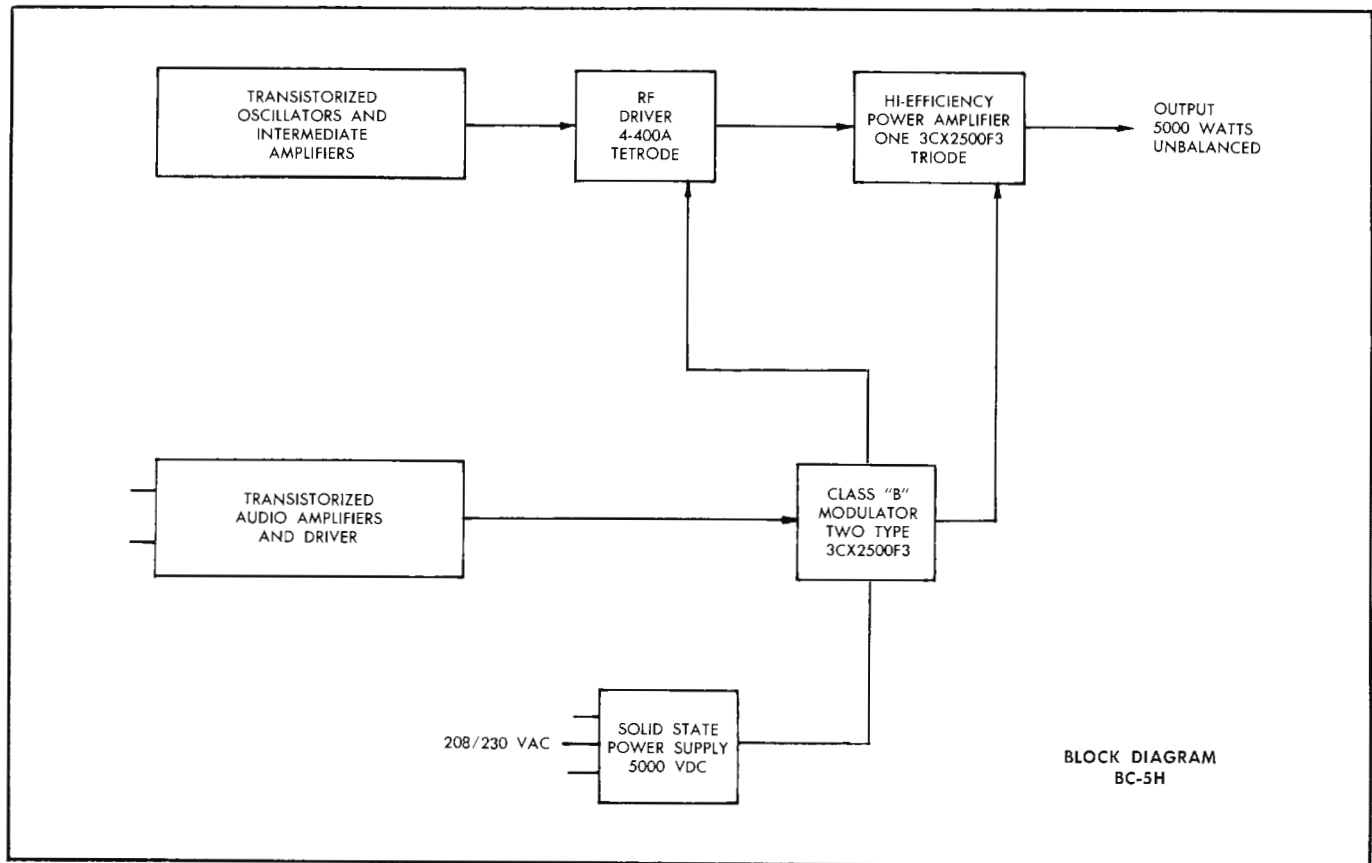

AUDIO SECTION: Four push-pull solid state audio amplifier stages amplify the audio signal from input level to full drive power for the modulator stage. The modulator stage, consisting of two Class B type 3CX2500F3 triodes, provides more than ample power to high level modulate the power amplifier, and modulate the RF driver. Inverse feedback, and an advanced design low leakage reactance modulation transformer/reactor group, results in signal quality of the highest fidelity. The rugged modulation transformer is oil (Askarel) filled for additional protection.

TUBE INTERCHANGE: Both the RF power amplifier and modulator stages use 3CX2500F3 long-life triodes. By periodic rotation many added tube life hours may be gained. Only four tubes of two different types are used in the entire transmitter.

SOLID STATE POWER SUPPLIES: Five separate power supplies assure fine regulation, and add to reliability. Lifetime silicon rectifiers in all power supplies provide a 2 to 1 voltage and a 5 to 1 current safety factor.

HARMONIC ATTENUATION: Harmonic reduction meets rigid FCC regulations, and is achieved through the use of a Tee network in the output circuit, and a second harmonic filter. The harmonic attenuation from the phasor or antenna coupler thus becomes a bonus for still greater harmonic reduction.

5000 Watt Medium Wave Broadcast Transmitter—BC-5H

REMOTE CONTROL: Use of relays in the transmitter control circuits makes installation of remote control simple. Terminals are factory installed in the transmitter, so that circuits to be remote controlled may be easily connected.

PROTECTIVE CIRCUITS: Relays are provided for overload, start/stop and interlock circuits, along with pressure type switches. An output power/VSWR meter is standard equipment, and is interlocked in the transmitter control circuitry as a protective device against antenna system malfunction.

RECYCLING: In the event of a direct short in the high voltage supply, the transmitter will recycle three times and then shut down. In the event of flashover, due to an electrical storm, the transmitter will momentarily shut down and then return to the air with no mechanical limit on the number of times recycling may occur.

EFFICIENT COOLING: One low speed Rotron blower cools all tubes, and a special air exhaust vents heat directly to the transmitter exterior to prevent heat circulation within the transmitter cabinet.

ACCESSIBILITY: The BC-5H is 100% accessible, with full length front doors, drop down front panels and removable rear panels. The transmitter control panel is located between the two front doors, and necessary tuning controls are adjustable from the front, in full view of meters which indicate operating parameters.

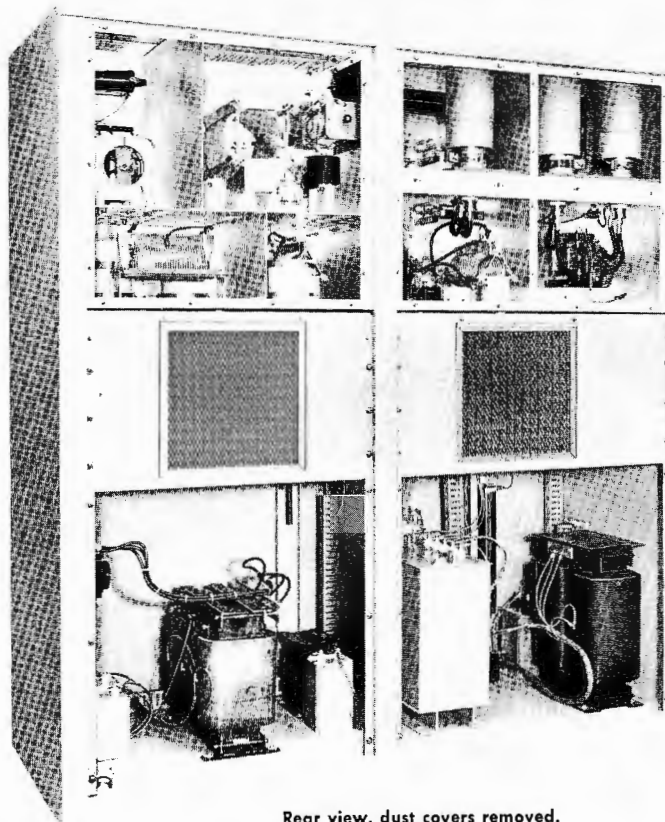

Rear view, dust covers removed.

SPECIFICATIONS

POWER OUTPUT: (Rated) 5000 watts. (Capable) 5600 watts. Power reduction to approximately 1000 or 500 watts available.

RF FREQUENCY RANGE: 535 kHz to 1620 kHz—supplied to one frequency as ordered.

RF OUTPUT IMPEDANCE: Supplied for 50 ohms, or other as specified.

RF FREQUENCY STABILITY: ± 2 Hz.

CARRIER SHIFT: Less than 3% at 100% modulation.

RF HARMONICS: Meets or exceeds FCC specifications.

MODULATION CAPABILITY: Positive peaks 125%, negative peaks 100%.

AUDIO FREQUENCY RESPONSE: ± 1 dB 50 to 10,000 Hz. $\pm 1\frac{1}{2}$ dB 30 to 12,000 Hz.

AUDIO FREQUENCY DISTORTION: 2.5% or less 50 Hz to 10,000 Hz at 95% modulation.

NOISE: (Unweighted) 60 dB or better below 100% modulation.

AUDIO INPUT: 600/150 ohms at +10 dBm, ± 2 dB.

POWER INPUT: 208/230 volts, 3 phase, 50 or 60 Hz. 10.7 kW zero modulation. 11.9 kW average modulation. 15.6 kW 100% modulation.

AMBIENT TEMPERATURE RANGE: -20°C to $+50^{\circ}\text{C}$.

ALTITUDE: To 7500 feet standard (higher altitudes on special order).

SIZE: 78" high, 72" wide, 32" deep. Completely self-contained.

WEIGHT: 1850 lbs. unpacked (approximate); 2200 lbs. domestic packed (approximate); 2450 lbs. export packed (approximate).

CUBAGE: 120 cubic feet packed.

FINISH: Beige-grey.

TUBES USED: (3)3CX2500F3, (1)4-400A.

GENERAL INFORMATION: Monitors: 10 RF volts output at 50/70 ohms for frequency and modulation monitors.

ORDERING INFORMATION

| | |
|---|----------|
| Model BC-5H transmitter with one set of tubes and two crystals..... | 994-6521 |
| 100% set spare tubes for BC-5H transmitter..... | 990-0535 |
| 100% set spare transistors for BC-5H (diodes not included)..... | 990-0540 |
| Kit for remote control of power output..... | 994-6548 |

1000/500/250 Watt AM Broadcast Transmitter

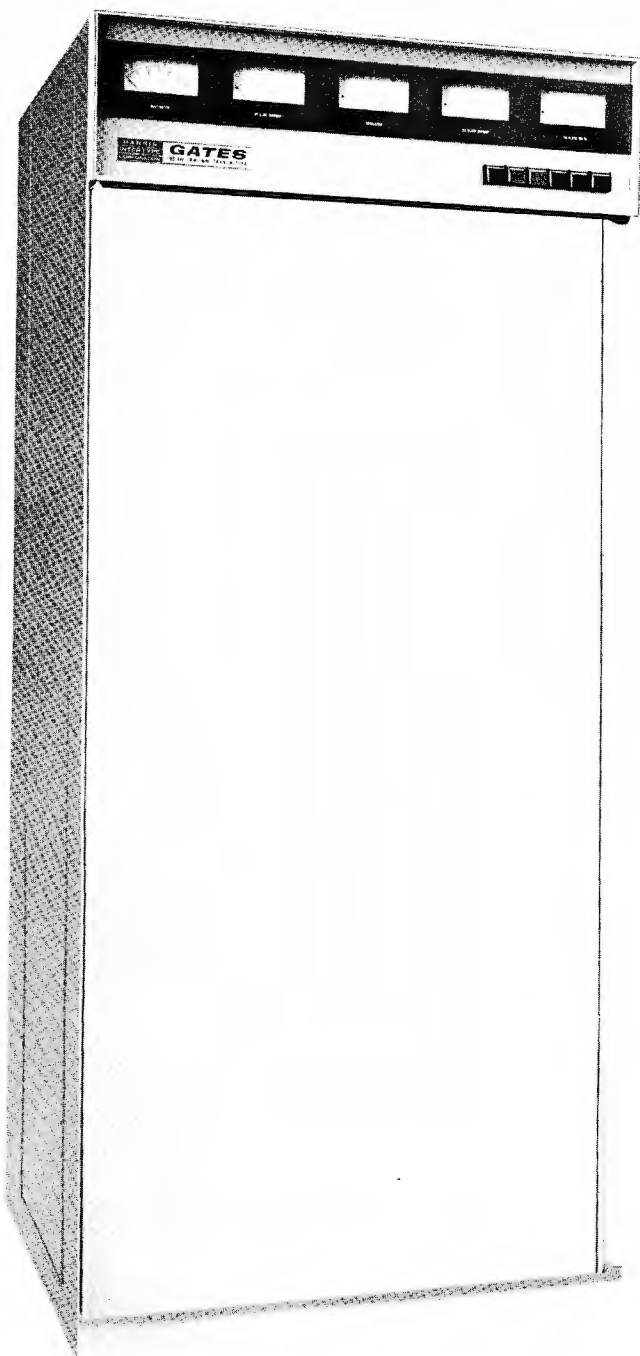

MODEL BC-1H

The BC-1H combines high positive peak modulation capability, long-life 833A power amplifier and modulator tubes for dependability, and unusually low power consumption to bring you the finest one kilowatt AM transmitter on the market today. Utilizing only two tube types, the BC-1H transmitter is completely self-contained in one sturdy steel cabinet only six feet (72") high.

HARRIS
GATES DIVISION
Harris-InterType Corporation

POWER AMPLIFIER TUBES: Chosen for performance, reliability and low cost per hour, 833A tubes are employed for both RF power amplifier and modulator output circuits. The 833A provides a combined hourly tube cost of approximately 2¢, and has world-wide availability. Also, as a husky triode, it is free of spurious emissions and tolerant of changing operating conditions caused by variances in load or fluctuations in cooling.

SOLID STATE AUDIO: A solid-state amplifier utilizing 8 transistors drives the long-life 833A high level modulator tubes, providing reserve performance capability to achieve modulation percentages up to 125% on positive peaks . . . with distortion products still within FCC specifications. Conservative circuit design has achieved excellent audio response with minimum audio distortion. Distortion is typically under 2% from 50 to 16,000 Hz under normal programming conditions.

RF SECTION: Dual vacuum-type ovenless crystal units and solid state components in the frequency determining stages generate a very stable signal. Frequency adjustment and crystal changeover are made from the front panel. Four RF stages provide isolation to assure better frequency stability. Two long-life 833A tubes feed 1000 watts into a newly designed full "T" output network with excellent tuning characteristics. A second harmonic filter helps provide an unsurpassed RF signal. The final amplifier and output network are tuned by large, variable edgewound coils.

POWER REDUCTION: Quick and efficient power reduction to 500 or 250 watts is another important feature of the BC-1H. Switching in the primary of the main plate transformer eliminates power consuming, voltage dropping resistors. Plate voltage is reduced on both the power amplifier and modulator tubes, resulting in added tube life, as well as savings in power costs.

REMOTE CONTROL: Designed for remote control operation, the BC-1H features built-in metering kits for both plate voltage and plate current. Advance-design control circuitry permits almost instantaneous adaptation to remote control, and eliminates the need for outboard attachments. All electrical connections for remote control are brought out to appropriate terminal boards.

BUILT-IN DUMMY LOAD: The BC-1H may be tested at a full kilowatt output with 100% modulation, using this built-in feature.

RECTIFIER SYSTEM: The BC-1H has three separate power supplies, all with large silicon rectifiers for lower power consumption and lifetime reliability. The three are: (1) main HV supply, (2) intermediate supply, and (3) bias supply.

1000/500/250 Watt AM Broadcast Transmitter—BC-1H

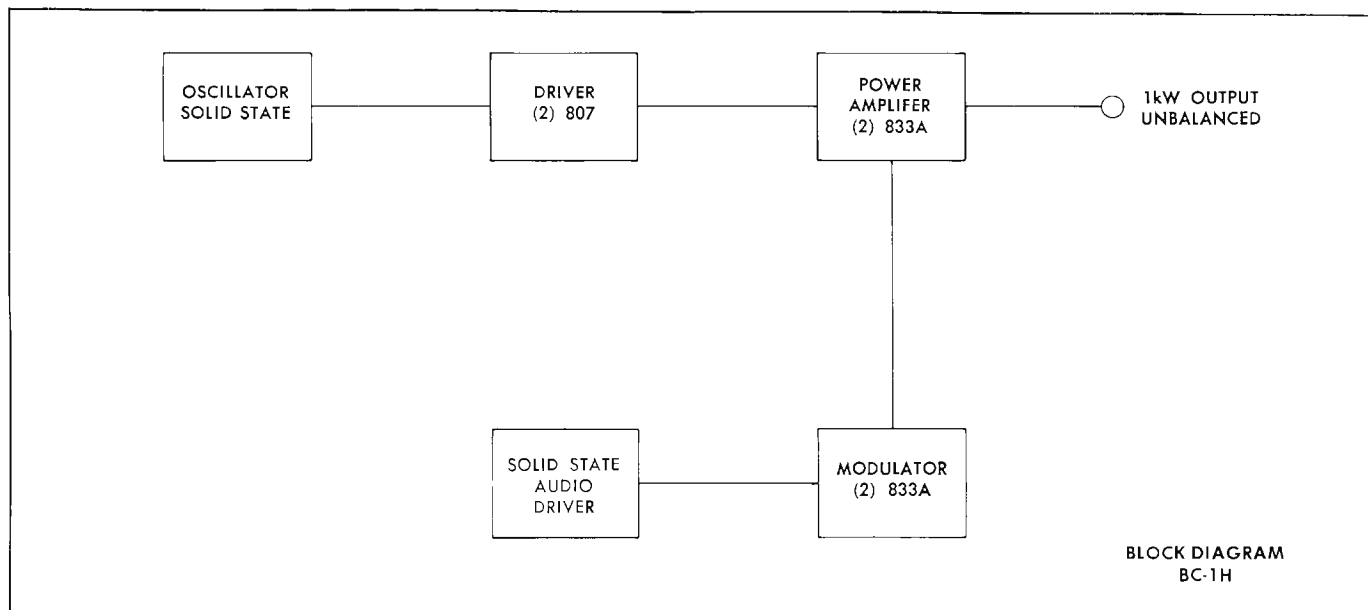

RECYCLING: In the event of an overload, the transmitter will recycle up to three times and then shut down if the overload has not been removed.

EFFICIENT COOLING: One low speed blower provides quiet, efficient cooling of all tubes. An air exhaust on the top of the transmitter vents heat to the exterior of the cabinet. The blower, located at the rear of the transmitter, is interlocked with the rear door, so that when the door is opened the blower shuts off automatically.

GENERAL DESIGN: The BC-1H is completely self-contained in a modern, low profile, sturdy steel cabinet. The front door is hinged on the left, and opens to reveal all tuning controls. Color-coded switches for start-stop and power change functions are accessible from the front when the door is closed. These switches illuminate to show the transmitter operating status at a glance. The lift-up meter panel raises for easy access to allow inspection and maintenance. The rear door is also hinged, and offers instant accessibility to all transmitter components.

SPECIFICATIONS

POWER OUTPUT: 1000/500/250 watts. Capable output to accommodate phasor loss, etc., 1100 watts.

FREQUENCY RANGE: 535-1620 kHz (supplied to one frequency as ordered).

OUTPUT IMPEDANCE: 50 ohms. Other output impedances available on special order.

RF HARMONICS: Exceeds FCC requirements.

FREQUENCY STABILITY: ± 2 Hz or better.

CARRIER SHIFT: 3% or less with adequate power mains. Typical is 2%.

MODULATION: High level.

MODULATION CAPABILITY: Positive peaks 125%, negative peaks 100%.

AUDIO RESPONSE: ± 1 dB 50-10,000 Hz, ± 1.5 dB 30-12,000 Hz.

AUDIO DISTORTION: 2.5% or less 50-10,000 Hz, 95% modulation. Under practical programming conditions 2% or less 50-16,000 Hz.

NOISE: (1000 watts) 60 dB or better below 100% modulation.

AUDIO INPUT IMPEDANCE: 150 or 600 ohms at +10 dBm ± 2 dB.

POWER CONSUMPTION: (1 kW) unmodulated, 2650 watts; average modulation, 3150 watts; 100% modulation, 3850 watts.

POWER INPUT: 208/230 volts, 1 phase, 3 wire, 50/60 Hz.

DUMMY ANTENNA: 50 ohms. Capable of dissipating full modulated output.

TEMPERATURE: -20 degrees to $+50$ degrees C.

SIZE: 72" high, 31½" wide, 31½" deep. Front and rear door swing, 32".

WEIGHT: Net, 770 lbs. Domestic packed, 950 lbs. Export packed, 1,075 lbs. Cubage: 68.7 cubic feet.

TUBES: (2) 807 intermediate driver amplifiers, (2) 833A RF power amplifiers, (2) 833A modulators.

ORDERING INFORMATION

BC-1H transmitter, 1000/500/250 watts.....994-6813
 Spare 100% tube complement for BC-1H.....990-0703

NOTE: Be sure to specify carrier frequency when ordering.

500/250/100 Watt AM Broadcast Transmitter

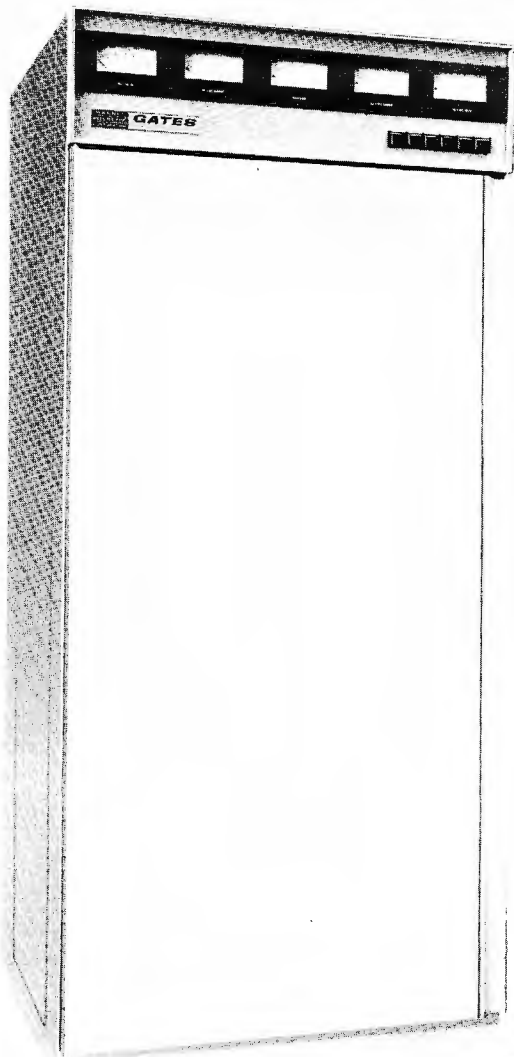

MODEL BC-500H

The BC-500H is essentially the same transmitter as the BC-1H, except only one 833A tube is used as the power amplifier. This means you get all the features included in the BC-1H, such as high positive modulation capability, great dependability from the use of husky 833A's, and low operating cost. Other features include: solid-state oscillator, solid-state audio driver, and silicon rectifiers; built-in dummy antenna rated for full 100% modulation; and quick and efficient power reduction to 250 or 100 watts.

Designed for remote control operation, the BC-500H has built-in metering kits for both plate voltage and plate current. Advance design control circuitry permits almost instantaneous adaptation to remote control, and eliminates the need for outboard attachments.

A recycling circuit, normally available only in higher power transmitters, is included in the BC-500H. This circuit quickly and automatically restores the transmitter to "On air" operation should lightning hit the antenna system, or after momentary severely high modulation peaks.

The BC-500H is completely self-contained in one modern, sturdy steel cabinet only six feet (72") high.

SPECIFICATIONS

POWER OUTPUT: 500/250/100 watts. Capable output to accommodate phasor loss, etc., 550 watts.

FREQUENCY RANGE: 550-1620 kHz (supplied to one frequency as ordered).

OUTPUT IMPEDANCE: 50 ohms. Other output impedances available on special order.

RF HARMONICS: Exceeds FCC requirements.

FREQUENCY STABILITY: ± 2 Hz or better.

CARRIER SHIFT: 3% or less with adequate power mains. Typical is 2%.

MODULATION: High level.

MODULATION CAPABILITY: Positive peaks 125%, negative peaks 100%.

AUDIO RESPONSE: ± 1 dB 50-10,000 Hz, ± 1.5 dB 30-12,000 Hz.

AUDIO DISTORTION: 2.5% or less 50-10,000 Hz, 95% modulation. Under practical programming conditions 2% or less 50-16,000 Hz.

NOISE: (500 watts) 60 dB or better below 100% modulation.

AUDIO INPUT IMPEDANCE: 150 or 600 ohms at +10 dBm ± 2 dB.

POWER CONSUMPTION: (500 watts) unmodulated, 1900 watts; average modulation, 2200 watts; 100% modulation, 2600 watts.

POWER INPUT: 208/230 volts, 1 phase, 3 wire, 50/60 Hz.

DUMMY ANTENNA: 50 ohms. Capable of dissipating full modulated output.

TEMPERATURE: -20° to $+50^{\circ}$ C.

SIZE: 72" high, 31½" wide, 31½" deep. Front and rear door swing, 32".

WEIGHT: Net, 770 lbs. Domestic packed, 950 lbs. Export packed, 1,075 lbs. Cubage: 68.7 cubic feet.

TUBES: (2) 807 intermediate driver amplifiers, (1) 833A RF power amplifier, (2) 833A modulators.

ORDERING INFORMATION

BC-500H transmitter, 500/250/100 watts 994-6872

Spare 100% tube complement for BC-500H..... 990-0705

Recommended minimum spare tube complement for BC-500H..... 990-0704

NOTE: Be sure to specify carrier frequency when ordering.

250 Watt AM Broadcast Transmitter

MODEL BC-250GY

Gates 250 watt AM broadcast transmitter is a performance-plus, high fidelity transmitter, complete in every detail for today's modern broadcasting. Features include attractive shadow mold styling, vacuum crystal, and full size back door for 100% accessibility. Fully FCC type approved, Gates BC-250GY transmitter has a world-wide reputation for long, trouble-free service. From Greenland to the Marianas, broadcasters acclaim the excellence and simplicity of this most widely used 250 watt medium wave transmitter.

RADIO FREQUENCY AND AUDIO STAGES: The RF tube line-up consists of a 12BY7 in an oscillator circuit that utilizes a vacuum crystal. A second 12BY7 is used as an intermediate power amplifier to drive a rugged 813, which in turn feeds the parallel 810 power amplifiers. The audio section is push-pull with 6L6 driver tubes operating into the Class B 810 modulator tubes. Interchange of power amplifier and modulator tubes gives added economy and longer tube life.

OPERATING FEATURES: The emphasis is on accessibility, ease of service and well ventilated design. Convection cooling is employed. As a result, the BC-250GY transmitter is silent in operation, and may be operated adjacent to a microphone. Vertical construction permits "walk-in" access. The audio section is a hinged sub-section. Seven meters allow direct simultaneous reading of all important functions. For a conservative, superb performing transmitter, the Model BC-250GY will fill the needs of most discriminating broadcasters.

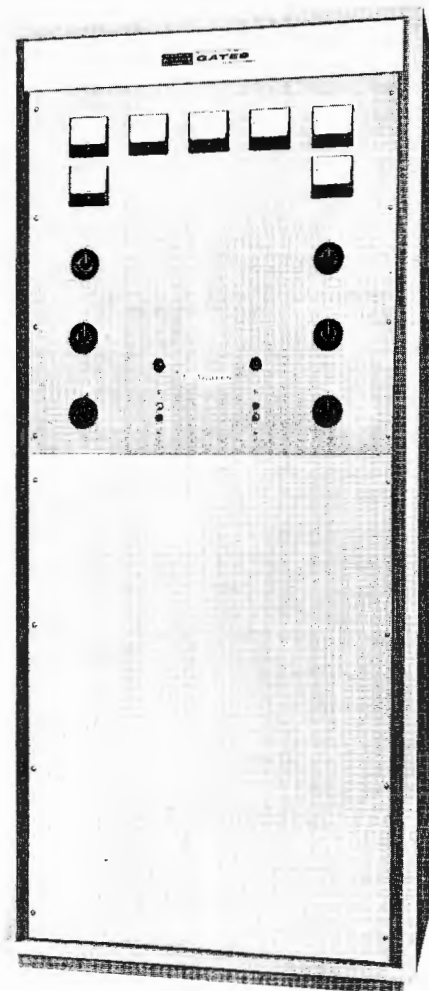

SPECIFICATIONS

POWER OUTPUT: Rated 250 watts, capable 280 watts.

FREQUENCY RANGE: 540-1620 kHz, as ordered.

RF OUTPUT IMPEDANCE: 30/300 ohms unbalanced, as ordered.

FREQUENCY STABILITY: ± 5 Hz.

CARRIER SHIFT: 3% or less, 100% modulation.

MODULATION: High-level plate.

AUDIO RESPONSE: ± 1.5 dB 30-10,000 Hz.

AUDIO DISTORTION: 3% or less, 50-7500 Hz at 90% modulation.

NOISE: 55 dB below 100% modulation.

AUDIO INPUT: 500/600 ohms at +8 dBm ± 2 dB, 100% modulation.

POWER CONSUMPTION: 1.6 kW at 90% modulation.

POWER INPUT: 230 volts AC, 2 wire, single phase, 50/60 Hz.

POWER FACTOR: Better than 90%.

MONITORS: Will accommodate all modern frequency and modulation monitors.

SIZE: 78" high, 34" wide, 33" deep.

WEIGHT: Domestic, packed—770 lbs.; export—900 lbs.

CUBAGE: 112.

FINISH: Two-tone beige-gray.

TUBES: (4) 810, (2) 6L6, (2) 12BY7, (1) 813, (2) 800B, (1) 5Y4G.

ORDERING INFORMATION

| | |
|---|----------|
| BC-250GY Transmitter, 250 watts, complete with one set of tubes and one vacuum crystal..... | 994-3760 |
| Spare 100% set of tubes..... | 990-0507 |
| Recommended minimum set of spare tubes..... | 990-0508 |

NOTE: Please state carrier frequency and RF output impedance when ordering.

HARRIS
GATES DIVISION
Harris-Intertype Corporation

Antenna Phasing Equipment



Custom-built Phasor for 5 kW,
5-tower directional AM station.

*HANDLE ONLY
813-0971-001*

*CYCLOMETER
994-6233-001*

Gates phasing equipment is custom built, utilizing Gates manufactured inductors and other quality components for precise coverage patterns requiring a minimum of adjustment and a maximum of stability. Some of the most complex phasing systems in existence have been built by Gates.

ADVANCED RESEARCH: As the world leader in the design and manufacture of phasing equipment, Gates engages in highly advanced phasor research and development. All Gates phasing systems are computer designed to assure maximum accuracy and most efficient circuitry. Phasor construction is carried out by a group of design and production experts, with years of experience in specialized phasing equipment. This group is under the direction of a registered professional engineer.

CONSTRUCTION: Antenna tuning units are constructed as a panel and shelf type for wall mounting in a doghouse, or in weatherproof metal cabinets. Phasor cabinetry built to your specifications is available, and becomes an integral planning factor in the coordination of design and styling to reflect over-all system compatibility and appearance.

Gates manufactures phasing equipment for any power, for any number of towers; 250 watt to 250 kilowatt tuning units; diplexers for medium wave and for 2-30 MHz short wave; triplexers, rejection filters, and a wide range of radio frequency networks. Each is custom tailored for the particular application, to assure the broadcaster's complete satisfaction.

Antenna Phasing Equipment

*Feed thru bowl
994-5200-001
DRW# 821-3407-001*

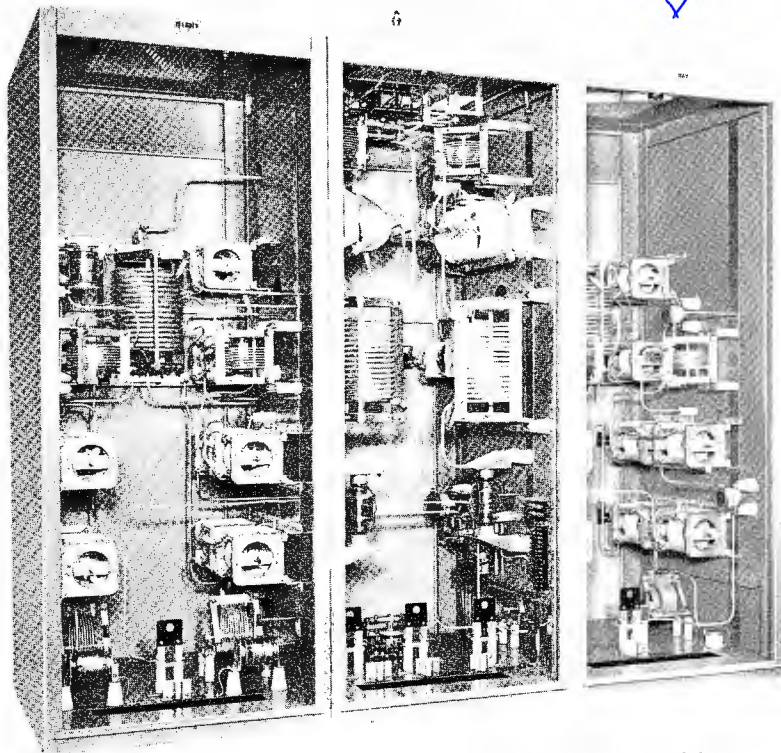

Rear view of Phasor at left, with panels removed. Note the clean mechanical layout.

STABILITY AND EFFICIENCY: All directional phasing equipment is designed to the parameters provided by the station's consulting engineer, and work is not initiated until the consultant and customer approve the design. To furnish custom designed phasors suited for specific broadcasting needs, Gates provides detailed specifications for your equipment, so you may determine exactly what you are buying. The full range of adjustment can be precisely determined by computer—before it is delivered. This avoids the possibility of having to replace inadequate components, or make costly field modifications of design to relieve difficult adjustment.

The careful design and construction practices maintained by Gates give you more than reasonable assurance of the best possible long term stability and efficiency. This avoids expensive readjustments and reproof of pattern later on.

Gates phasors are constructed to give a safety factor of 1.4 times on RMS current and four times on maximum RMS voltage based on expected operating adjustments.

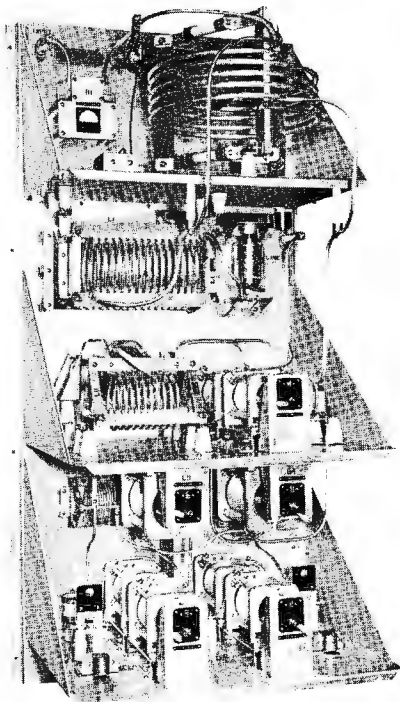

CUSTOM-BUILT OPEN PANEL PHASOR.

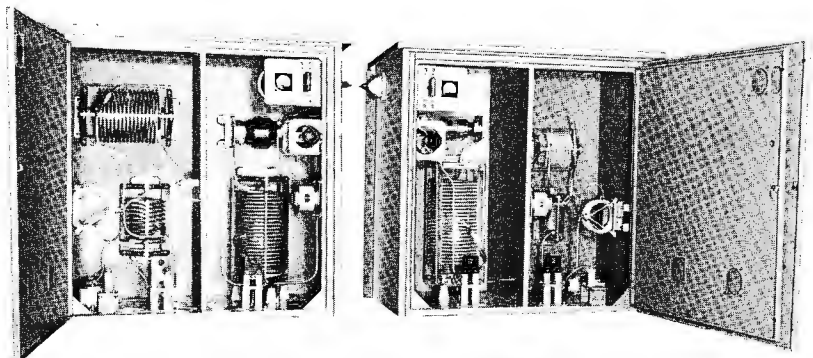

10 kW MEDIUM WAVE DIPLEXER

Numerous diplexers, triplexers, RF filters and custom designed networks are considered normal design and construction activity at Gates. The above illustrates a 10 kW medium wave diplexer that permits two AM transmitters to feed a common vertical radiator.

Common Point Impedance Bridge

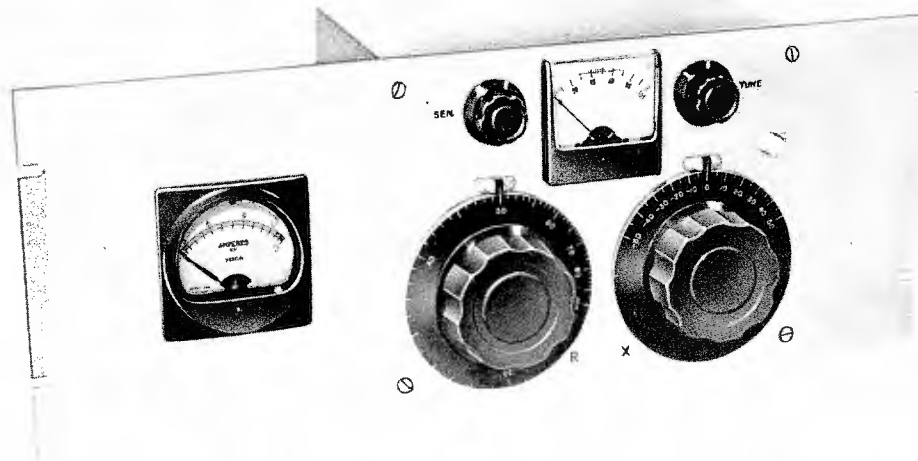

An instrument for permanent installation in the common point of a directional antenna system. Permits the common point resistance and reactance to be measured during normal operation without transmitter shutdown. Panel ammeter reads common point current so that direct antenna power can be determined.

The Model CPB-1 and CPB-1A Common Point Impedance Bridges are operating impedance bridges similar to the Model OIB-1, but designed for permanent installation in your phasing equipment at the antenna common point. Instruments have two 4" dials calibrated directly in resistance and reactance. A panel meter is provided for a null detector. The R & X dials are manipulated as a normal bridge while the transmitter is operating at full or reduced power to give a null indication on the panel meter. The value of the common point resistance and reactance can then be read directly from the two dials.

It has been found that many directional antennas have common point impedances which vary from time to time due to seasonal changes in the ground system and minor tuning drift of the antenna parameters. On many occasions it was found from remeasurement of the common point impedance that the station had been transmitting with somewhat less than full power for some time because of these changes. The CPB-1 and CPB-1A permit the station operator to determine the common point impedance at any time, even during normal operating hours. By minor adjustment of the common point resistance control, he can maintain his radiated power at the full license value at all times. He also has a method of detecting changes in his antenna system which affect the common point. This may alert him to equipment faults and prevent citations for antenna misadjustment.

CPB-1 and CPB-1A bridges are normally supplied mounted on a standard 19" x 7" rack panel. A cutout can be made in

the antenna phasing equipment for mounting this panel. Both bridges are also available without the rack panel. A drill template is then supplied, permitting the station engineer to mount the bridge in the existing panel of the antenna phasor.

SPECIFICATIONS

FREQUENCY RANGE: 500-1650 kHz.

POWER RATING: CPB-1—5 kW—100% amp. mod. continuous. CPB-1A—50 kW—100% amp. mod. continuous.

RESISTANCE RANGE: 30-100 ohms.

REACTANCE RANGE: ± 50 ohms (1000 kHz).

ACCURACY: Resistance $\pm 2\% \pm 1$ ohm. Reactance $\pm 5\% \pm 1$ ohm. (Provision is made for your consultant to adjust the calibration to agree exactly with your licensed resistance value).

RF SOURCE: Your transmitter operating at normal or reduced power acts as source—no generator is required.

DETECTOR: Tuned internal detector with 25 ua panel meter—no external detector is required.

AMMETER: Panel hole is provided for Weston Model 308, 3½" square ammeter. A meter recessing bracket is supplied for high power applications. A matching meter for your power and resistance can be supplied.

TERMINALS: Screw terminals or standoff insulators at rear of bridge box for connection to tubing, strap, or jumper to coax is provided.

MOUNTING: Standard 7" x 19" engraved gray rack panel—can be supplied without panel for mounting behind your phasor panel (drill template supplied).

DIMENSIONS: Bridge box without panel: Height: 7", Width: 9", Depth: 9¼". Panel dimensions: 7" x 19".

ORDERING INFORMATION

CPB-1 Common Point Impedance Bridge, 5 kW.....700-0055

CPB-1A Common Point Impedance Bridge, 50 kW.....700-0056

Operating Impedance Bridge

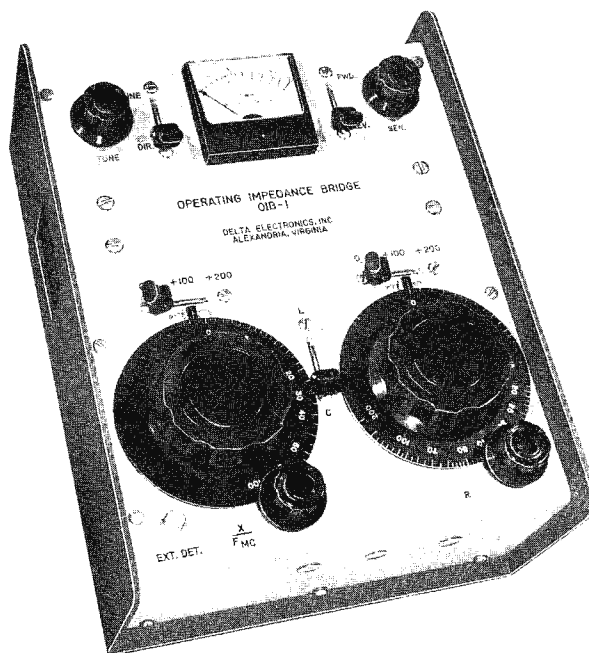

- Measures "in circuit" operating impedance—500 kHz to 5 MHz.
- Handles through power up to 10 kW.
- No signal generator or external detector required for measurement under power.
- Can be used with signal generator and receiver as a normal bridge.
- Measures negative impedance loads.
- Ideal for use in adjusting multi-tower directional antennas.
- Based on new principle.

The Model OIB-1 Operating Impedance Bridge measures the operating impedance of the individual radiators, networks, transmission line sections, and common point of directional antenna systems while they are functioning normally and under power. This "operating impedance" cannot be measured by normal impedance bridge methods because the system characteristics are disrupted when the bridge is inserted in the circuit. The OIB-1 thus satisfies a critical requirement long felt by consulting and broadcast station engineers. In addition it has many applications in other fields that cannot be duplicated by any other instrument.

The OIB-1 is inserted directly in series with the transmission line, network, or antenna. The transmitter power is applied and a bridge balance is obtained by manipulating the R and X dials on the face of the bridge. Balance is indicated by a null reading on the meter which is mounted on the front panel

of the bridge. Operating resistance and reactance are then read directly from the bridge dials. The VSWR on a transmission line can be read directly from a scale on the meter.

SPECIFICATIONS

FREQUENCY RANGE: 500 kHz to 5 MHz.

THROUGH POWER RATING: 10 kW, carrier only, no modulation with VSWR 3:1.

INSERTION EFFECT: Equal to 9" of 150-ohm line.

FUNCTIONS: Direct reading in R, -400 to +400 ohms. Direct reading in X, -300 to +300 ohms. Measures VSWR, $Z_0=0$ to 400 ohms. Indicates relative forward and reflected power.

ACCURACY: R and X, $\pm 2\%$ ± 1 ohm. Dials individually calibrated and engraved.

RF SOURCE: Transmitter, transmission line, etc., or signal generator with adapting connector.

DETECTOR: Internal for high power source. Connector on front panel for external detector when used with signal generator. Amplifier for internal detector available as factory installed option if high sensitivity is desired.

TERMINALS: Input and output are large UHF receptacles (UG-357/U). 12" input and output clip leads are supplied as standard with bridge. 18" leads optional at no extra cost when specified with order. External detector connection is BNC.

ACCESSORIES: Aluminum polyurethane-lined transport case.

DIMENSIONS: 12½" x 9½" x 5¼" deep.

WEIGHT: 10 lbs.

ORDERING INFORMATION

Model OIB-1 Operating Impedance Bridge. Specify whether 12" or 18" leads are desired _____700-0063

D. C. Amplifier. Used to increase sensitivity of Bridge for use with power sources as low as 25 watts _____700-0064

TC-1 Transport Case. For OIB-1 _____700-0065

HARRIS
GATES DIVISION
Harris-InterType Corporation

939 - 7888 - 001
Dog House

See pg. 75
994 - 2870 - 004
Feed Thru Bowl

AM Antenna Couplers

"Mo 44"

WEATHERPROOF SERIES—FED ANTENNA COUPLER, 1250 WATTS

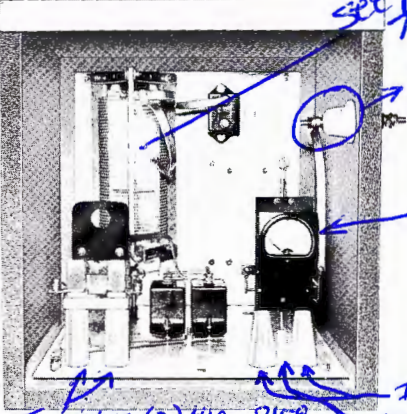

L-4 494-0070-000

see pg. 76

Feed thru Ins. 994-3302-001

Slider for sheet SW 910-5712-001
Sheet SW p. 29

Insulators (2) 410-0159
410-0014-001 (1) DC?

Recommended for broadcast transmitter powers of 1,000, 500 and 250 watts, 100% modulated. Heavy edgewound micaex insulated silver plated coil has generous inductance for a full Tee network along with fixed mica capacitors supplied. Extra room is provided to install either diode or thermocouple remote metering equipment. Heavy duty meter shorting switch eliminates antenna meter from the circuit when not in use for lightning protection. Meter is observed through plexi-glass porthole. Front door of cabinet has been removed for illustrative purposes.

SPECIFICATIONS

CARRIER POWER: Up to 1250 watts AM.
FREQUENCY: 525-1700 kHz as ordered.
LINE IMPEDANCE: 40-230 ohms as ordered.
TO MATCH: Series-fed tower of from 70° to 95° electrical length.
CIRCUIT: Full Tee Network.
WEIGHT: 98 lbs.
SIZE: 20" high, 20 1/4" wide, 18 3/4" deep.

ORDERING INFORMATION

Antenna Coupler with antenna meter 994-3494
NOTE: When ordering, state transmission line impedance, frequency, tower height, and tower measurements, if known. For remote meters, see below. Couplers to match unusual loads such as short or tall towers, shunt feed, etc., are available on special order at extra cost.

SERIES AND SHUNT FED COUPLERS

994-5280-001 Bowl Assy.

Also
410-0174-000
1/2" silver pl.
2 Copper strap
003-4030-010



GATES

Both series and shunt fed models are constructed in a non-weatherproof cabinet with slip-off front door and large lead in bowl at top. Coil is micaex insulated edgewound silver plated and capacitors are supplied to tune to buyer's specific frequency. Size: 21" high, 10" wide, 9" deep. Usually mounted in small dog house at base of tower. Rating 1250 watts, 100% modulated.
*SERIES FEED MODEL: Provides full Tee network inductance with capacitors to match wide range of input and output impedances. State frequency line impedance, and tower height when ordering. -----994-5178
*SHUNT FEED MODEL: Includes inductor and capacitors to tune out reactance in shunt fed antenna coupling. If tower measurements are known, these are always especially helpful. State line impedance and frequency...994-5179
*NOTE: METER NOT INCLUDED.

ISOLATION COIL

This isolation coil is quickly made to customer's order by carrying all basic materials in stock. The same type of coaxial cable is used in winding the coil as is used for sampling line. If the customer used Heliac sampling line, then the isolation coil would be wound with Heliac coaxial cable. Nominal inductance 85 uH. Available in weatherproof or open model. Sizes (weatherproof model), 20" wide, 12 1/2" high and 18 1/2" deep. (Open model), 16" wide, 10" high and 16" deep. When ordering, please state type or make of sampling line or preferred coaxial cable for coil construction. Resonating capacitor is not included.

ORDERING INFORMATION

Weatherproof isolation unit.....994-3073
Open unit coil only, less cabinet.....994-4561

WEATHERPROOF 5-10 KW ANTENNA COUPLING UNITS

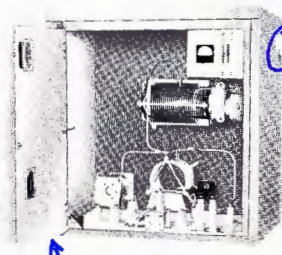

994-5281-001 Bowl

Cabinet 942-1465-003

Housed in aluminum cabinet with double front doors. Porthole for meter reading and heavy duty meter shorting switch operates with doors closed. Large micaex insulated silver plated coils combined with capacitors of generous voltage and current ratings to assure a lifetime of service under extreme heat or cold. A large antenna lead in bowl is provided. Mounting is with metal flanges on the back of the tuning unit for attachment to wooden poles set in ground or for mounting on wall.

SPECIFICATIONS

CARRIER POWER: M-5309A 5,000 watts AM.
M-5309B 10,000 watts AM.
FREQUENCY: 525-1,700 kHz as ordered.
LINE IMPEDANCE: 40-230 ohms as ordered.
TO MATCH: Series fed tower of from 70° to 95° electrical length.
CIRCUIT: Full Tee Network.
WEIGHT: Approximately 200 lbs.
SIZE: 38" high, 37" wide, 21 1/2" deep.

ORDERING INFORMATION

Antenna Coupling Unit, 5 kW.....994-5309A
Antenna Coupling Unit, 10 kW.....994-5309B
NOTE: When ordering, state carrier frequency, transmission line impedance, power, tower height and tower measurements, if known. Couplers to match unusual loads such as short or tall towers, shunt feed, etc., are available on special order, at extra cost.

R. F. ANTENNA METERS

Internal thermocouple standard scale. Weston Model 308, three-inch square case. Other ranges not listed below are available with many carried in stock. Also expanded scale meters in inventory.

ORDERING INFORMATION

Meter, 0-3 R. F. amperes.....634-0206
Meter, 0-6 R. F. amperes.....634-0238
Meter, 0-8 R. F. amperes.....634-0209
Meter, 0-10 R. F. amperes.....634-0210

DIODE TYPE REMOTE METER EQUIPMENT

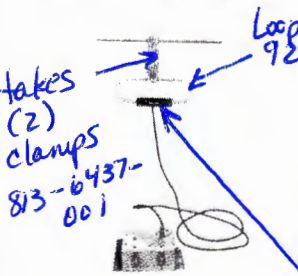

takes (2) clamps 813-6437-001

Loop 927-5846-001

For remote indication of RF current. Consists of a carefully constructed pickup loop attached through a short coaxial cable to a solid state rectifier assembly. RF current is measured without breaking the main lead. No AC power is required. May be used with any good 1 MA DC meter. Power range: 250 watts to 50,000 watts. Frequency range: 540 kHz to 1600 kHz.

NOTE: This clamp on loop assy. is part of loop assy. + cable

Diodes 384-0307

ORDERING INFORMATION

Diode remote meter unit, less meter.....994-6112
Meter 3" sq. case, scale 0-3 R. F. amperes.....632-0418
Meter 3" sq. case, scale 0-5 R. F. amperes.....632-0419
Meter 3" sq. case, scale 0-8 R. F. amperes.....632-0420
Meter 3" sq. case, scale 0-10 R. F. amperes.....632-0421
Meter 4" sq. case, scale 0-3 R. F. amperes.....632-0424
Meter 4" sq. case, scale 0-8 R. F. amperes.....632-0426
Meter 4" sq. case, scale 0-10 R. F. amperes.....632-0361
Meter 4" sq. case, scale 0.15 R. F. amperes.....632-0428

NOTE: Other meter scale ranges available at extra cost. Above for use with diode remote unit, not thermocouple.

888 0731 001
IB for



Plug? 610-0370-000

AM Antenna Coupling Accessories

SOLENOID TOWER CHOKES

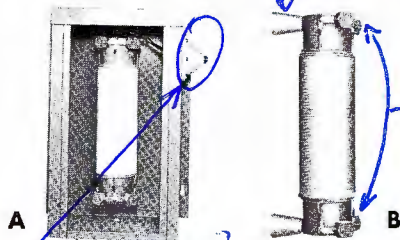

*Bowl 410-0174
Clamp 810-4056-002
washer 335-0022-000*
(20 AMP AC RATING)

Most popular of all tower light isolation chokes. Available in 2 or 3 section and in open type, or weatherproof as illustrated. Wound on heavy triple X tubing with mica-by-pass condensers on each circuit end. Inductance approximately 350 uH. 3" stand-off insulators are part of coil. (Weatherproof type), 24" high, 17 3/4" wide, 10 1/4" deep. Illustration to left shows weatherproof unit with front cover removed.

ORDERING INFORMATION

| | |
|---|----------|
| Tower Choke, 2 wire, weatherproof, Fig. A..... | 994-3937 |
| Tower Choke, 3 wire, weatherproof, Fig. A..... | 994-3938 |
| Tower Choke, 2 wire, open type, Fig. B..... | 994-3935 |
| Tower Choke, 3 wire, open type, Fig. B..... | 994-3936 |

RADIO FREQUENCY CONTACTOR

A heavy duty solenoid operated RF contactor for most switching applications through 50 kW power. Available in either SPDT or DPDT types and in two voltage ratings. Will operate on 115/230 volts AC, latching type. Will handle up to 25 amperes RF per contact.

ORDERING INFORMATION

| | |
|---|----------|
| Contactor SPDT insulated 17 kV peak voltage..... | 570-0001 |
| Contactor DPDT insulated 17 kV peak voltage..... | 570-0002 |
| Contactor SPDT insulated 22 kV peak voltage..... | 570-0003 |
| Contactor DPDT insulated 22 kV peak voltage..... | 570-0004 |

*IN 398 - 384 - 0134 → SAME
IN 914 - 384 - 0205*

HEAVY DUTY SAMPLING LOOP

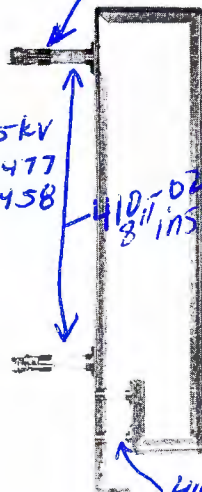

ins. 410-0173-000
BRACKETS 620-0078
910-5712-001 Board for
*CAPS: 01-2.5KV
500-0477
500-0458*
*410-0212
8" INSULATORS*
*410-0211
INS. 4"*

This is a very rugged fixed non-shielded RF sampling loop. It is heavily galvanized after welding, and is fitted with large steatite insulators and heavy duty tower leg clamps for easy and positive mounting. Complete with type "N" jack. For 50 to 70 ohm sampling line.

ORDERING INFORMATION

Heavy duty sampling loop.....994-6126

ROTATING SAMPLING LOOPS

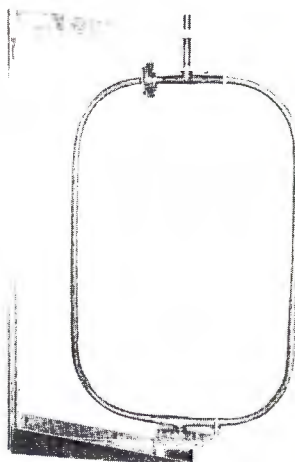

This model is especially applicable where high current ratios are to be sampled. May be rotated so that phase monitor amplitude values are nearly equal. Electrostatically shielded and insulated from tower. May be used with or without isolation coil at base of tower. Coil is single loop, heavily insulated from base frame. Matches either 50 or 70 ohm line. Size: 48" wide, 32" high.

ORDERING INFORMATION

Rotating Sampling Loop.....994-3283

METER JACK AND SHORTING BAR-MOUNTING PLUG

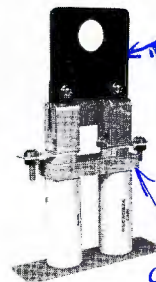

*910-4938-001
ISA
994-3281-001*
*994-3280-003
Both Parts*

A great convenience to allow RF current measurements to be made by simply plugging in a meter. Will accommodate most 3" or 4" meters. A "must" in critical RF circuit areas in phasors, couplers, etc. Rating up to 50 kW on a 50 ohm line.

ORDERING INFORMATION

Meter jack and shorting bar.....994-3280-003
Meter mounting plug.....994-3281-001

METER SHORTING SWITCH

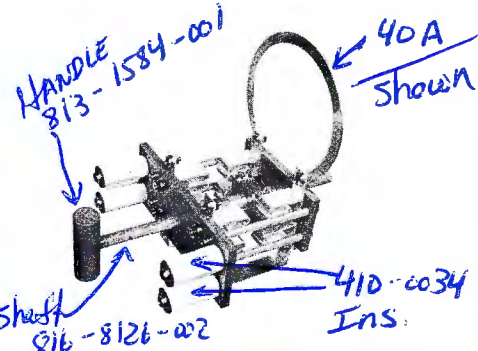

HANDLE 813-1584-001
*40A
Shown*
SHOCK 816-8126-002
*410-0034
INS.*

A heavy duty, make-before-break meter shorting switch of the plunger or push type. Heavy bronze tempered spring grips on both sides assure accuracy and durability.

ORDERING INFORMATION

Meter Shorting Switch, rating 15
amperes.....994-3493
Meter Shorting Switch, rating 40
amperes.....994-6527

40A → DRW# 942-7141-001

LARGE INVENTORY OF METERS

In the manufacture of transmitting and audio equipment for broadcasting, communications and defense, Gates is required to carry thousands of meters in inventory. Whether AC, DC, or RF, or microammeter, milliammeter or ammeter, it is very likely the meter you need in emergency or expansion is quickly available. Give us desired case size, range and type of movement and we will serve you speedily. Many meters are also carried at our Houston and New York branches.



AM Modulation Monitor

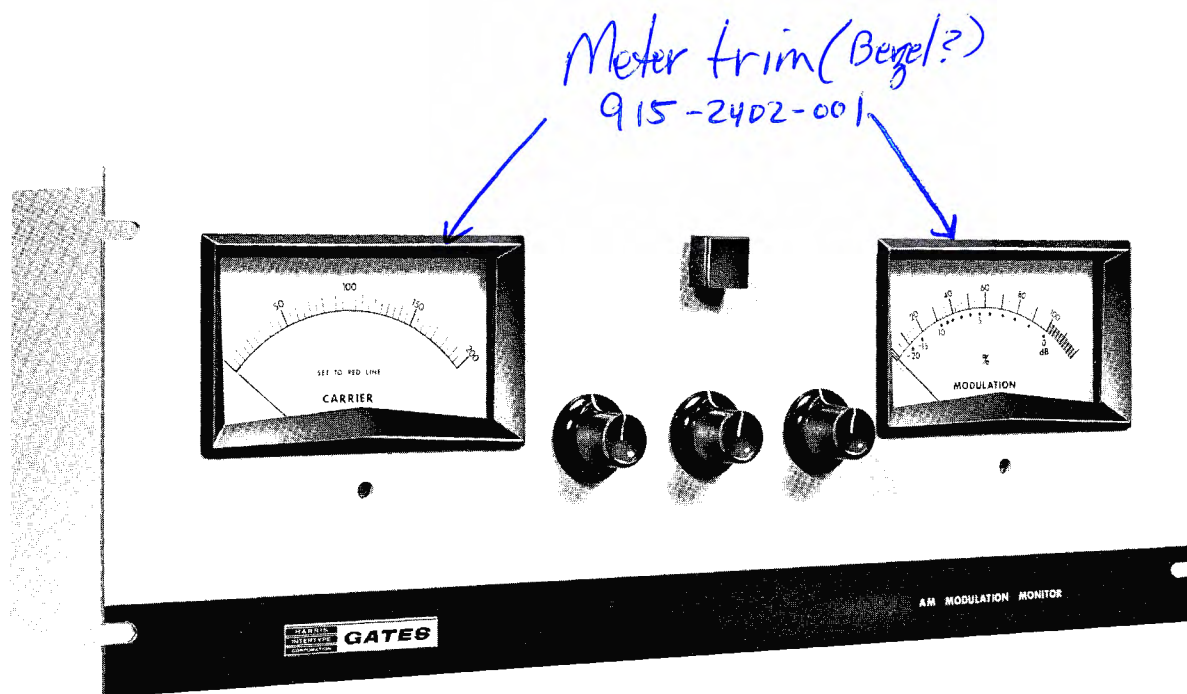

MODEL M-6659

Gates' AM Modulation Monitor is an FCC type-accepted solid-state instrument designed to meet or exceed all requirements for measuring modulation percentages of broadcast and short-wave stations in the frequency range 540 kHz to 30 MHz. It will provide the accurate and dependable monitoring required by the FCC, and is suitable for proof-of-performance measurements.

CONTROLS: Three functional controls are located on the front panel, and mounted in-line for easy adjustment: (1) carrier-level setting, (2) a range selector control covering negative peak percentages, and (3) a modulation meter switch for choosing either negative or positive peaks. Switches and terminal connections are mounted on the rear of the chassis.

MONITOR ACCURACY: Gates monitors are factory calibrated by precision instruments and need no further adjustment. The monitor's solid-state circuits are not affected by ageing and the resulting change in circuit constants that normally affect calibration accuracy.

MODULATION METER: Correct positive or negative peak indications, even on program bursts as short as 40 to 90 milliseconds, assure true peak measurement regardless of the wave forms encountered.

OVER-MODULATION FLASHER: Operation of the flasher light is adjusted by the calibrated negative-peak control, and has the same superior accuracy as the meter.

AUDIO OUTPUTS: Proof-of-performance measurements can be taken from the monitor's high-fidelity output with absolute assurance that readings of transmitter performance are accurate. A 600-ohm audio output is also provided to supply aural monitoring in the control room.

REMOTE OPERATION: Modulation readings by meter and flasher at a distant location are obtainable with a Gates optional remote meter panel. Separate output circuits provide (1) a ballistically correct signal for a remote meter and (2) a remote flasher, connected by two loops with a length of up to 2,000 ft. of #22 or larger wire.

AM Modulation Monitor—M-6659

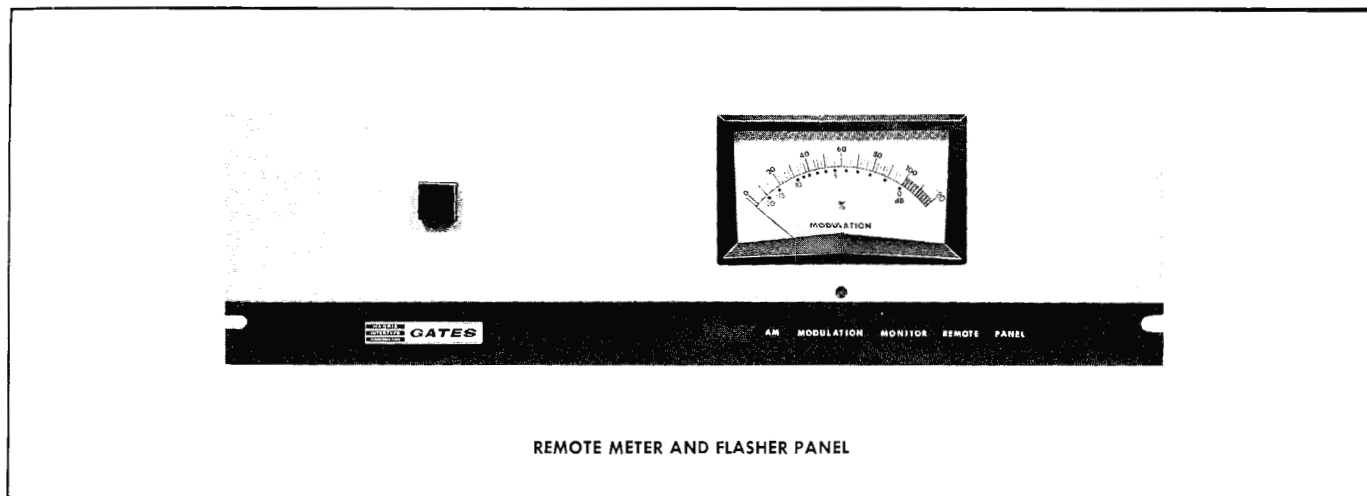

SPECIFICATIONS

FREQUENCY RANGE: 540 kHz to 30.0 MHz.

RF INPUT: For 50/75 ohm line at 6 to 20 volts.

MODULATION INDICATION:

METER: 0% to 100% on negative peaks.
0% to 120% on positive peaks.

FLASHER: 50% to 100% in 5% steps on negative peaks. Flashes when negative modulation is within 2% of dial setting.

ACCURACY: Meter is $\pm 2\%$ of full scale at 1000 Hz. Flasher is $\pm 2\%$ at 1000 Hz.

WITH ADAPTOR PANEL: 0 to 125% on positive peaks, with adaptor panel listed below.

RESPONSE TIME:

METER: Responds to within 90% of correct reading with a single 65 (± 25) millisecond pulse of modulation. Needle returns to 10% of reading in 650 (± 150) milliseconds after signal is removed.

FLASHER: Responds to less than one millisecond pulse of modulation and remains on for about 0.5 second.

AUDIO MONITOR OUTPUT:

FREQUENCY RESPONSE: ± 0.5 dB from 20 Hz to 20 kHz.

DISTORTION: Less than 0.3% with 600-ohm load at 100% modulation.

OUTPUT VOLTAGE: At 100% modulation, output is 0.55 volts into a 600-ohm load, approximately -10 dBm average.

OUTPUT IMPEDANCE: 600 ohms, unbalanced.

FIDELITY MEASURING OUTPUT:

FREQUENCY RESPONSE: ± 0.5 dB, 20 Hz to 20 kHz.

DISTORTION: Less than 0.3%.

OUTPUT VOLTAGE: At 100% modulation, output is 4.4 volts with a load resistance greater than 100,000 ohms.

OUTPUT IMPEDANCE: 4000 ohms, unbalanced.

NOISE: 70 dB below nominal outputs of both monitoring and fidelity outputs.

REMOTE OUTPUT: For meter and flasher indications at another location, use Gates remote meter panel: 994-6687.

PHYSICAL & MECHANICAL DIMENSIONS:

SIZE: 19" long x 7" high x 6" deep. Will mount in a standard relay rack.

WEIGHT: Domestic, 12 lbs. Export, 21 lbs. Cubage, 3 cu. ft.

POWER SOURCE: 105-125 volts, 50/60 Hz, 10 watts.

SERVICE CONDITIONS:

AMBIENT TEMPERATURE RANGE: -4° to 125° F. (-20° to $+52^{\circ}$ C.).

AMBIENT HUMIDITY RANGE: 0% to 95% relative humidity.

ALTITUDE: Sea level to 7500 feet.

ORDERING INFORMATION

| | |
|---|----------|
| Solid-State AM Modulation Monitor | 994-6659 |
| Remote Meter Panel | 994-6687 |
| Positive Peak Adaptor Panel | 994-7056 |

AM Frequency Monitors

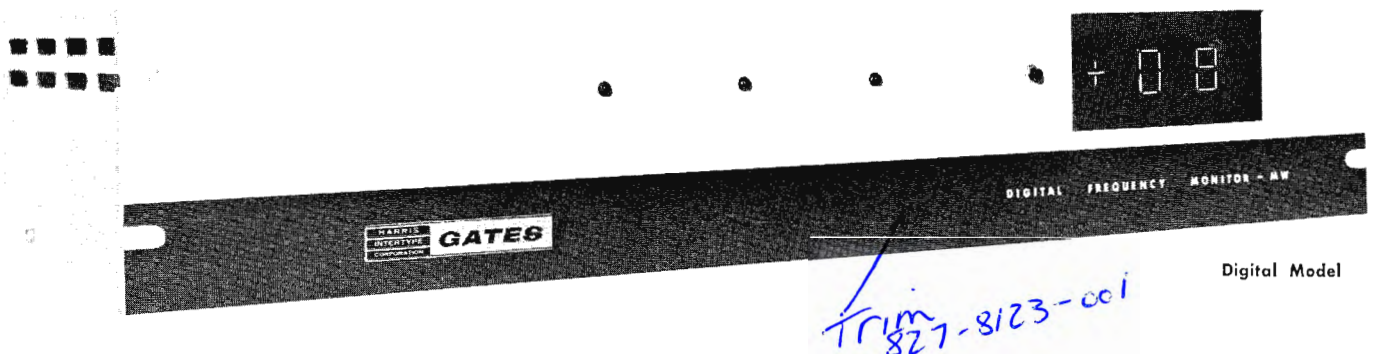

AM FREQUENCY MONITORS

Gates' medium wave frequency monitors are FCC type accepted instruments designed to meet or exceed all requirements for measuring carrier frequencies of standard AM broadcast transmitters.

Available in a digital read-out model, or in a version with conventional analog (meter) display, these frequency monitors employ solid-state integrated circuits throughout, and feature light-emitting diode (LED) indicators.

The monitors will accept as input any standard AM frequency, and will indicate the deviation from assigned frequency. The input may be a modulated RF signal of 0.2 volts to 10 volts RMS. Unlike other designs, there is no loss of indication when the sample RF is modulated above 95%. A unique circuit "remembers" the last valid measurement until the modulation of the RF input is less than 95% for a normal one-second counting period.

In the digital model, a two-digit display indicates the magnitude of the frequency error, and a plus-minus indicator shows if the frequency is above or below the assigned frequency. Above ± 31 Hz error, the digits are blanked, but the sign indicator continues to operate.

In the analog version, a zero-center analog meter indicates the magnitude and sign of the frequency error. With a devi-

ation greater than ± 31 Hz, the meter indicates in a red "off scale" zone. In both models an "Alarm" indicator and relay contact closures warn of frequency errors greater than ± 20 Hz.

After A.C. power is applied, the monitors stabilize to reliable readings within 5 minutes. There are no delicate thermostats or heater controls. The reference oscillator is heated by a proportional oven which maintains the unit's accuracy at a constant level over a wide range of ambient temperatures.

Only one crystal is needed to cover the entire broadcast band. Setting up to the station frequency simply entails "programming" the counter. The procedure is so simple that it can easily be accomplished in the field should the station change frequencies.

A test button, when depressed, checks all LED's and read-out tubes (or the meter in the analog model).

Remote indicators for either the digital or the analog unit may be operated over telephone lines of up to 5000 ohms loop resistance. The optional remote accessories may be factory installed or added later in the field. In either case the remote panel contains an analog meter display. One control adjusts calibration of the remote meter, and the test button confirms that the meter is polarized correctly.

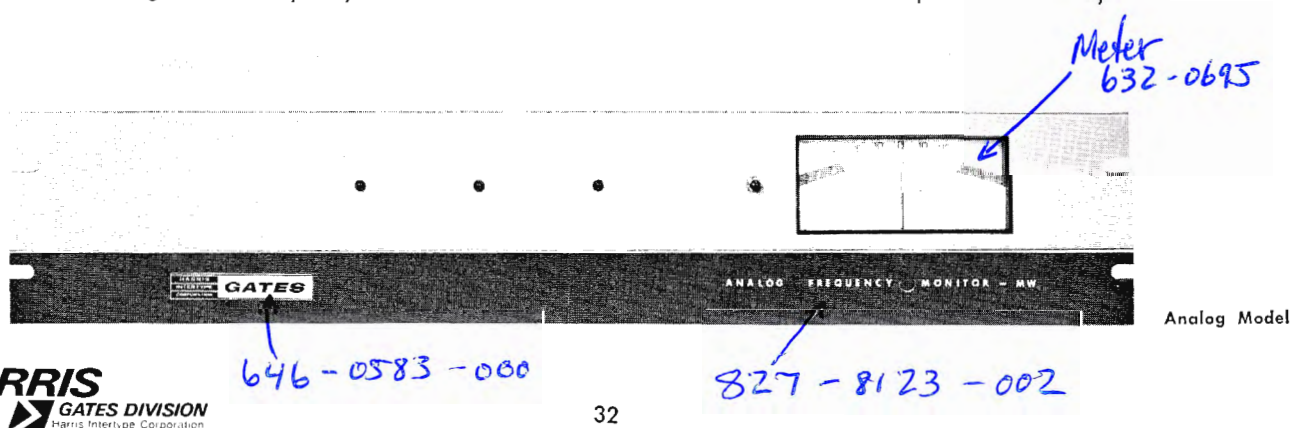

AM Frequency Monitors, AM Accessories

SPECIFICATIONS

FREQUENCY RANGE: 540-1600 kHz as ordered.

RF INPUT IMPEDANCE: 50 ohms.

RF INPUT CONNECTOR: BNC.

RF INPUT SENSITIVITY: (Unmodulated) 10 mV to 10 V RMS carrier. (Modulated) 0.2 V to 10 V RMS RF, 0-95% modulation.

A.C. POWER INPUT: 115/230 VAC, 50/60 Hz, 40 watts.

REFERENCE OSCILLATOR: Crystal-controlled in proportional oven.

ACCURACY: Better than 1.85 ppm (0.5 Hz @ 540 kHz).

DEVIATION INDICATOR RANGE: ± 31 Hz deviation.

STATUS INDICATORS (LED): Low input alarm; ± 20 Hz deviation alarm; Count period.

ALARM RELAY: 120 VAC/28 VDC @ 5A N/O & N/C contacts at ± 20 Hz or greater deviation.

REMOTE: Maximum remote loop resistance . . . 5000 ohms.

AMBIENT TEMPERATURE RANGE: 0 to 55° C.

AMBIENT HUMIDITY RANGE: 0 to 95% relative humidity.

ALTITUDE: 0 to 7500 feet above sea level.

DIMENSIONS: 19" wide, 3.5" high, 10.25" deep.

WEIGHT: (Domestic packed) 20 lbs. (Export packed) 45 lbs. (Cubage) 2.4 cu. ft.

ORDERING INFORMATION

| | |
|---|----------|
| Medium wave frequency monitor, digital read-out ----- | 994-6698 |
| Medium wave frequency monitor, analog (meter) display ----- | 994-6865 |
| Remote (analog) meter panel for Model 994-6698 above ----- | 994-6863 |
| Remote (analog) meter panel for Model 994-6865 above ----- | 994-6864 |

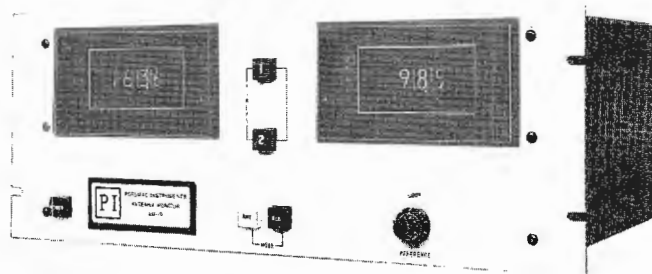

PHASE MONITOR

A completely solid state AM phase monitor for directional systems up to 12 towers. Phase readings are not affected by modulation, and are accurate to $\pm 1^\circ$. Silicon transistors and taut-band meters assure greatest reliability.

The Model AM-19 phase monitor is easy to operate, easy to read, and it is fully adaptable to remote control operation.

SPECIFICATIONS

FREQUENCY RANGE: 540-1600 kHz.

ACCURACY: $\pm 1^\circ$. Phase resolution: 0.5°.

INPUT IMPEDANCE: 50 or 75 ohms.

NUMBER OF INPUTS: Up to 12.

INPUT LEVEL: .5 to 20 volts RMS.

POWER REQUIRED: 105/130 VAC, 80 watts, 50/60 Hz.

SIZE: 19" W \times 7" H \times 12 $\frac{3}{4}$ " D.

WEIGHT: 20 pounds.

ORDERING INFORMATION

Model AM-19 Phase Monitor (State number of towers) ----- 731-0239



FIELD INTENSITY METER

The solid state battery operated Model FIM-21 field intensity meter is universally used to measure field strength in the 540-1600 kHz broadcast band. Voltage regulation insures that circuit operation is independent of power supply voltage changes due to battery aging or extreme temperatures.

SPECIFICATIONS

FREQUENCY RANGE: 535-1605 kHz.

MEASUREMENT RANGE: 10 microvolts to 10 volts per meter.

ACCURACY: 2%.

OUTPUT INDICATOR: 4" mirrored scale meter. Provision for recorder.

BATTERIES: (6) 1.5 volt flashlight type "D" cells.

SIZE: 8 $\frac{3}{4}$ " H \times 11 $\frac{1}{2}$ " W \times 5 $\frac{1}{8}$ " D.

WEIGHT: 11 $\frac{1}{2}$ pounds.

ORDERING INFORMATION

Model FIM-21 Field Intensity Meter (less batteries) ----- 700-0077

Dummy Antennas

The dummy antenna is perhaps the most needed test device in a broadcasting station. Principal use is tune-up and test without the signal being on the air. For daytime stations, this means routine work may be done after station sign off instead of after 1 a.m. The dummy antenna is most valuable in the event of a transmitting system malfunction. At this time the

5 KW AIR COOLED DUMMY ANTENNA

For use with standard broadcast transmitters in the 5 kW power range for tune-up and efficiency tests. Essentially non-reactive. Handles 5000 watts 100% sine wave modulated. For operation between 200 kHz and 2000 kHz. 27½" × 26" × 10¼" high. Available in 50 ohm (Model DU-551) and 70 ohm (Model DU-570).



50 KW WATER COOLED DUMMY ANTENNA

The Gates 50 kW water cooled dummy antenna is available either for medium wave or short wave application. The medium wave unit is essentially non-reactive in the 200-2000 kHz band, and does not usually require a matching network. Both models will easily handle a full 50 kW 100% modulated when provided with suitable water flow. Water of reasonable purity can be used; normal required flow is approximately 15 gallons per minute. Dual thermometers and flow meter are provided for precise power measurement by the calorimetric method. Available in medium wave type with 50, 70, 150, 300 or 600 ohms input impedance as ordered. The high frequency model for operations between 2-30 MHz is available only for 300 or 600 ohms. Size: 78" high, 42" wide, 48½" deep.

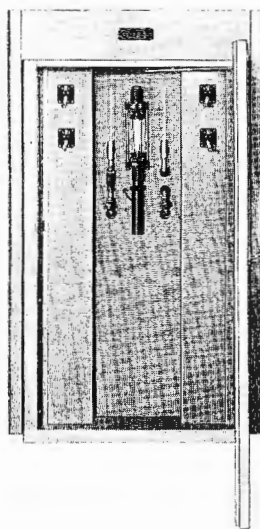

first problem is always locating the source of the trouble. An open transmission line, a short in the coupler or phasor, a short in a tower light, etc., will usually react by operating the overload relay in the transmitter. By attaching the dummy antenna, the trouble spot is quickly isolated as either in the transmitter or elsewhere in the system.

Res. heater Element 910-7362-001

10 KW AIR COOLED DUMMY ANTENNA

An air cooled 10,000 watt dummy antenna that will permit 100% sine wave modulation for long periods of time. Essentially non-reactive, it can be used at full rating between 200 kHz and 2000 kHz. Resistance, 50 ohms. This air cooled dummy antenna eliminates need for water connections and is a practical device for tune-up and measurement. 29½" × 26" × 16½" high. Model M-6107.

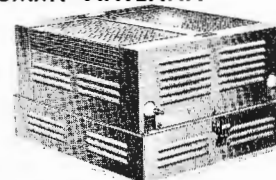

Blower 430-0024-000

75 KW AIR COOLED DUMMY ANTENNA

Designed for high power application, this air cooled dummy antenna dissipates 75,000 kilowatts AM, and is particularly useful in the frequency range of DC-2MHz because of the very low VSWR. A current meter is included to facilitate transmitter tuning. An airflow interlock is supplied to prevent damage to the transmitter should the airflow be interrupted. Impedance 50 ohms, 230 ohms—unbalanced. Power handling capability: 75,000 watts average, 150,000 P.E.P. Net weight: 295 lbs. Size: 72" H × 28" W × 23" D. Power requirement: 208/260 V, 60 Hz, 10 amps.

(8) Resistors

1 KW AIR COOLED DUMMY ANTENNA

This unit may be used for any medium wave transmitter at a maximum power rating of 1 kW, 100% modulated. Consists of non-inductive resistors heavily banded together to arrive at correct load resistance. For 200 kHz to 2000 kHz. 20¼" × 12½" × 5" high. Available in 50 ohm and 70 ohm models.

*410-0062
410-0019
Sub*

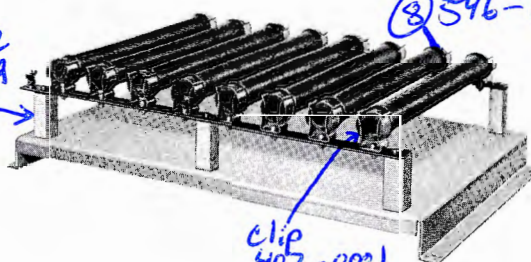

(6) 546-0216

*clip
402-0001*

ORDERING INFORMATION

| | |
|--|--------------|
| DU-551 Dummy Antenna, 5 kW, 50 ohms..... | 994-3968-001 |
| DU-570 Dummy Antenna, 5 kW, 70 ohms..... | 994-3968-002 |
| M-6107 Dummy Antenna, 10 kW, 50 ohms..... | 994-6107 |
| M-5497 Dummy Antenna, 50 kW, medium wave (see Note 1)..... | 994-5497-001 |
| M-5497A Dummy Antenna, 50 kW, high frequency (see Note 1)..... | 994-5497-002 |
| Dummy Antenna, 75 kW..... | On Request |
| DU-151 Dummy Antenna, 1 kW, 50 ohms..... | 994-4354 |
| DU-170 Dummy Antenna, 1 kW, 70 ohms..... | 994-3483 |

NOTE: (1) Be sure to state resistance, such as 50 ohms.

*1kw only
has (6)
resistors
above*

FM BROADCAST TRANSMITTERS

HARRIS
 **GATES DIVISION**
Harris-Intertype Corporation

Solid State "DCFM" Exciter

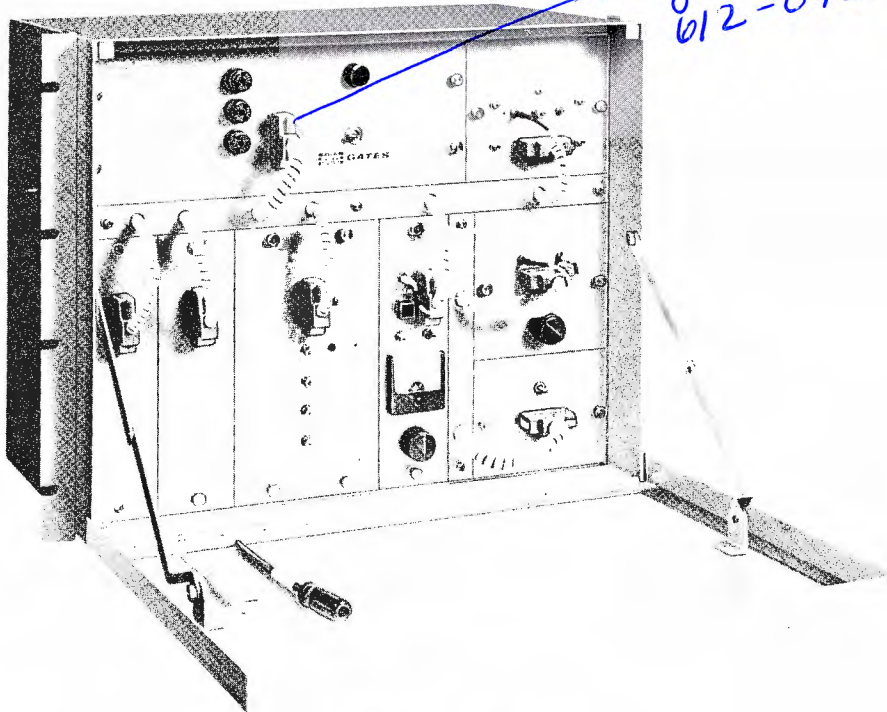

MODEL TE-3

Gates' advance-design solid state TE-3 Exciter, combining the superior stereo performance of Direct Carrier Frequency Modulation (DCFM) with the extreme frequency stability of Digital Automatic Frequency Control (DAFC), is the heart of every Gates "H3" transmitter.

The "H3" FM transmitter series is FCC type accepted, and thoroughly field tested. There are nine models, covering all power ranges:

- A one tube 250 watt FM transmitter
- A one tube 1000 watt FM transmitter
- A two tube 2500 watt FM transmitter
- A two tube 3000 watt FM transmitter
- A two tube 5000 watt FM transmitter
- A two tube 7500 watt FM transmitter
- A two tube 10,000 watt FM transmitter
- A three tube 20,000 watt FM transmitter
- A seven tube 40,000 watt FM transmitter

FULL 10 WATTS OF RF SOLID STATE POWER: The Model TE-3 Exciter was designed to upgrade FM transmitter reliability by using solid state devices to reduce the greatest danger to electronic equipment—heat. Only performance-proven solid state devices and precision temperature-compensated components are used to assure continuous duty service. A full 10 watts of composite RF signal at carrier frequency is produced easily by this 100% transistorized exciter. The TE-3 can be used to drive most modern FM transmitters requiring 10 watts carrier frequency input.

ADVANCED DESIGN: The oscillator in the Model TE-3 Exciter operates at the carrier output frequency, eliminating

frequency multipliers. This, combined with Digital Automatic Frequency Control, means improved carrier stability and excellent frequency response. With this exciter, phase shift and distortion resulting from frequency multiplier tuned circuits are now a thing of the past. There is no longer a need to retune critical stages, which means more stable and efficient operation.

STEREO SEPARATION 35 DB MINIMUM: Optimum 35 dB separation is the result of Direct Carrier Frequency Modulation of the oscillator at the output frequency. As carrier generation and modulation take place "on frequency," the wide bandwidth needed for high fidelity reproduction is easily attained. The result is better FM stereo separation and minimum crosstalk between main channel and sub channels used for SCA and FM stereo.

MODULAR CONSTRUCTION: The Model TE-3 is composed of seven modules, each individually shielded, and connected within the exciter enclosure by an advanced intercabling technique. Connections are made at the front of each module with premium quality quick-disconnect plugs. Test voltage measurements and adjustments can be made easily by this advanced modular mechanical design. Modular construction allows the addition of stereo or SCA at a later date by simply plugging in the factory adjusted module(s).

SUPERB SCA OPERATION: In the TE-3 Exciter crosstalk from the main channel to the SCA channel is virtually eliminated through new filtering techniques, and cancellation of the second harmonic of the composite stereo signal.

Dual FM Transmitters

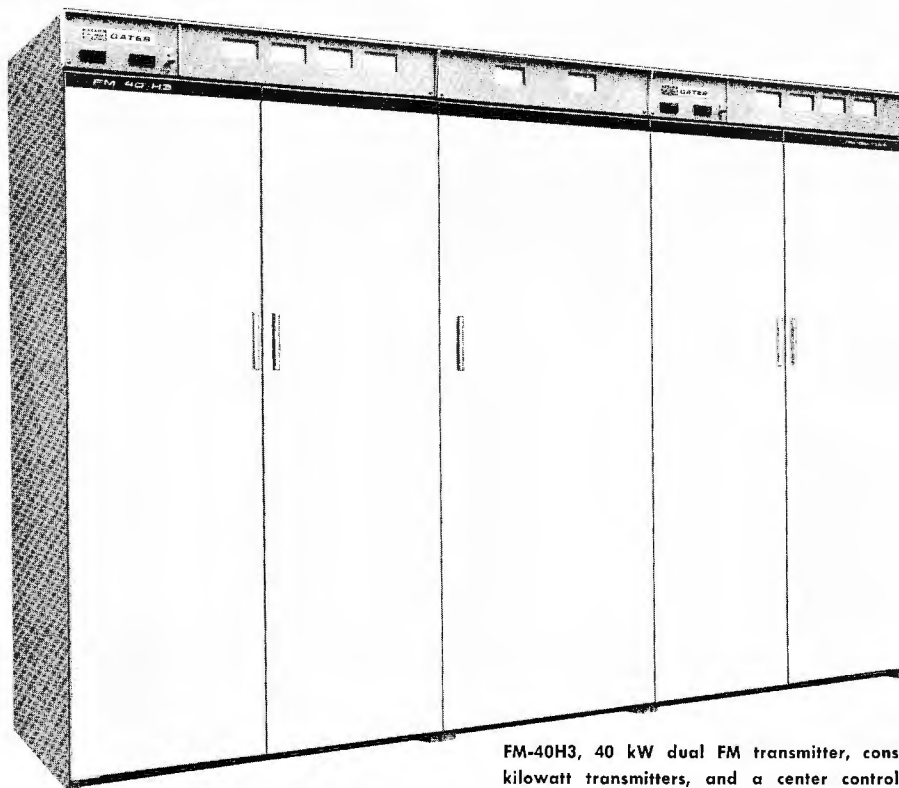

FM-40H3, 40 kW dual FM transmitter, consisting of two FM-20H3, 20 kilowatt transmitters, and a center control cabinet.

DUAL FM TRANSMITTERS

Gates' dual FM transmitters offer total reliability through total redundancy. You get complete protection from expensive "down" time, plus the superb mono or stereo performance of Gates' "DCFM" design.

Dual FM transmitters from Gates are available in the following power ranges: FM-40H3 (a 40 kilowatt system consisting of two FM-20H3, 20 kilowatt transmitters, and a center control cabinet); FM-10/10H3 (a 20 kilowatt system consisting of two FM-10H3, 10 kilowatt transmitters, and a center control cabinet); and the FM-5/5H3 (a 10 kilowatt system consisting of two FM-5H3, 5 kilowatt transmitters, and a center control cabinet). In all three models the center cabinet contains the exciter(s), plus switching and control equipment.

Each of the three dual FM transmitters is available in three different configurations. The basic dual system provides redundancy in all areas except the exciter—and provides for one-quarter normal power output in case emergency operation is required. With the addition of the Automatic Exciter/IPA Switching Kit to the basic system, automatic back-up exciter protection is provided. And with the further addition of the RF Output Switching System, power output becomes one-half the normal output, instead of one-quarter, during emergency operation.

Either or both of the options may be added to a Gates' basic dual FM transmitter system at any time in the field, or may be included in the original system.

In addition to complete protection from "down" time, Gates' dual FM transmitters offer all of the advantages provided by our standard "DCFM" transmitters . . . including high efficiency, high reliability from extensive use of solid-state circuitry, and outstanding mono and stereo performance specifications.

Operation of a Gates dual system is as simple as operating a single transmitter, and the system is readily adaptable to remote control!

The TE-3 exciter(s) employed in Gates' dual FM transmitters is 100% solid state and employs Direct Carrier Frequency Modulation (DCFM) and Digital Automatic Frequency Control for unsurpassed frequency response and great carrier stability. Modular construction of the TE-3 allows easy addition of stereo and SCA at any time by simply plugging in the appropriate generator modules.

Environmental tests, in conditions surpassing those of any location a transmitter is likely to encounter, have been imposed on Gates' dual FM systems. The transmitter systems are capable of operating at altitudes to 7,500 feet, in an ambient temperature range of -20°C to $+45^{\circ}\text{C}$.

Model TE-3 Exciter Modules

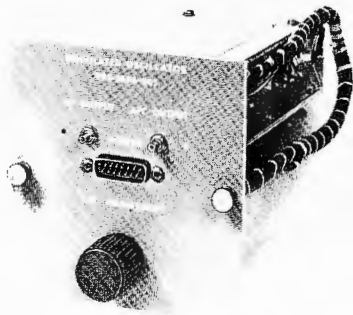

Modulated Oscillator Module

Operating at carrier frequency, the ultra stable modified Clapp oscillator is modulated by the direct application of mono, stereo and SCA input signals. For the most precise stability, the oscillator circuit is constructed with temperature compensated components and isolated by shock mounts. Gates "DCFM" is generated in this module, and feeds the solid state 10 watt amplifier module.

992-1715-002

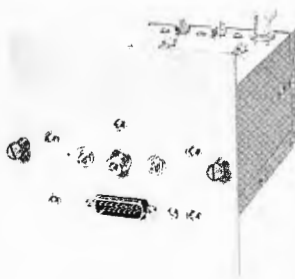

Power Amplifier Module

The power amplifier of the Model TE-3 FM Exciter is all solid state and provides a 10 watt signal at carrier frequency to the driver or final amplifier of Gates "H3" Series Transmitters. Amplifier bandwidth is approximately 3 MHz, which assures optimum stereo separation.

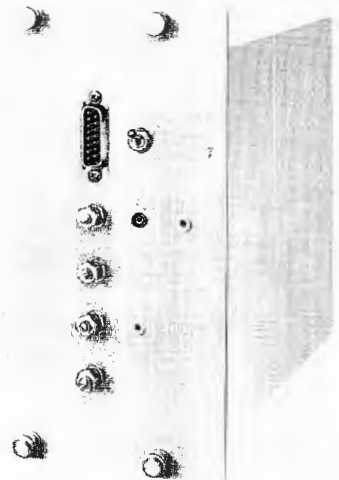

Stereo Generator Module (Optional)

With Gates solid state stereo generator, stereo separation left to right and right to left is always better than 35 dB from 50 Hz to 15 kHz. This performance is assured by the Gates "DCFM" exciter design. The modular construction allows you to order a Gates FM transmitter for monophonic operation, and add the factory aligned stereo generator later.

Blank Panel 992-1898-001

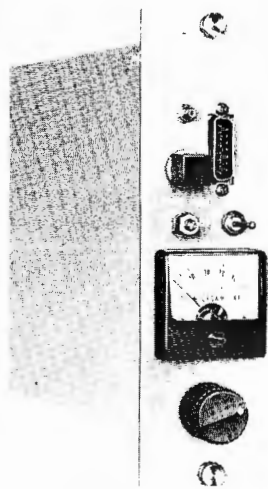

Automatic Frequency Control Module

Continuous carrier stability, within ± 1 kHz ($\pm .001\%$) of the assigned center frequency, is provided by a precision crystal controlled oscillator. Digital devices count down the output of the modulated oscillator and the crystal frequency for phase comparison. The two oscillators are then "phase locked" for error-free frequency control.



Audio Input Control Module

Control, processing and input switching of mono, stereo and 41 kHz SCA inputs to the modulated oscillator are provided in this module. During monophonic operation the right channel is automatically switched to the 41 kHz SCA input, which allows use of this program line for SCA operation.

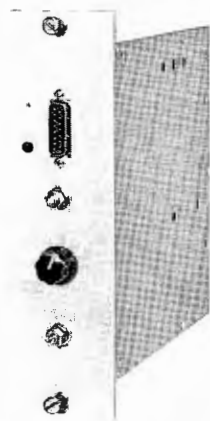

SCA Module (Optional)

Stable, self-excited oscillators are used to provide 41 kHz or 67 kHz SCA operation of excellent quality, with very low distortion. Automatic muting is included, with provision for control of both mute level and mute time constant. Factory pre-aligned SCA modules can be installed in the Model TE-3 Exciter by simply plugging into the space provided.

Power Supply Module

The solid state regulated DC power supply provides 24 volts DC to all modules in the Model TE-3 Exciter. Temperature compensated zener diodes are used to provide constant voltages over a temperature range of -20° C to $+70^{\circ}$ C, and power line variations from 85 volts to 130 volts. Ample power is available for the optional stereo and SCA modules.

Dual FM Transmitters

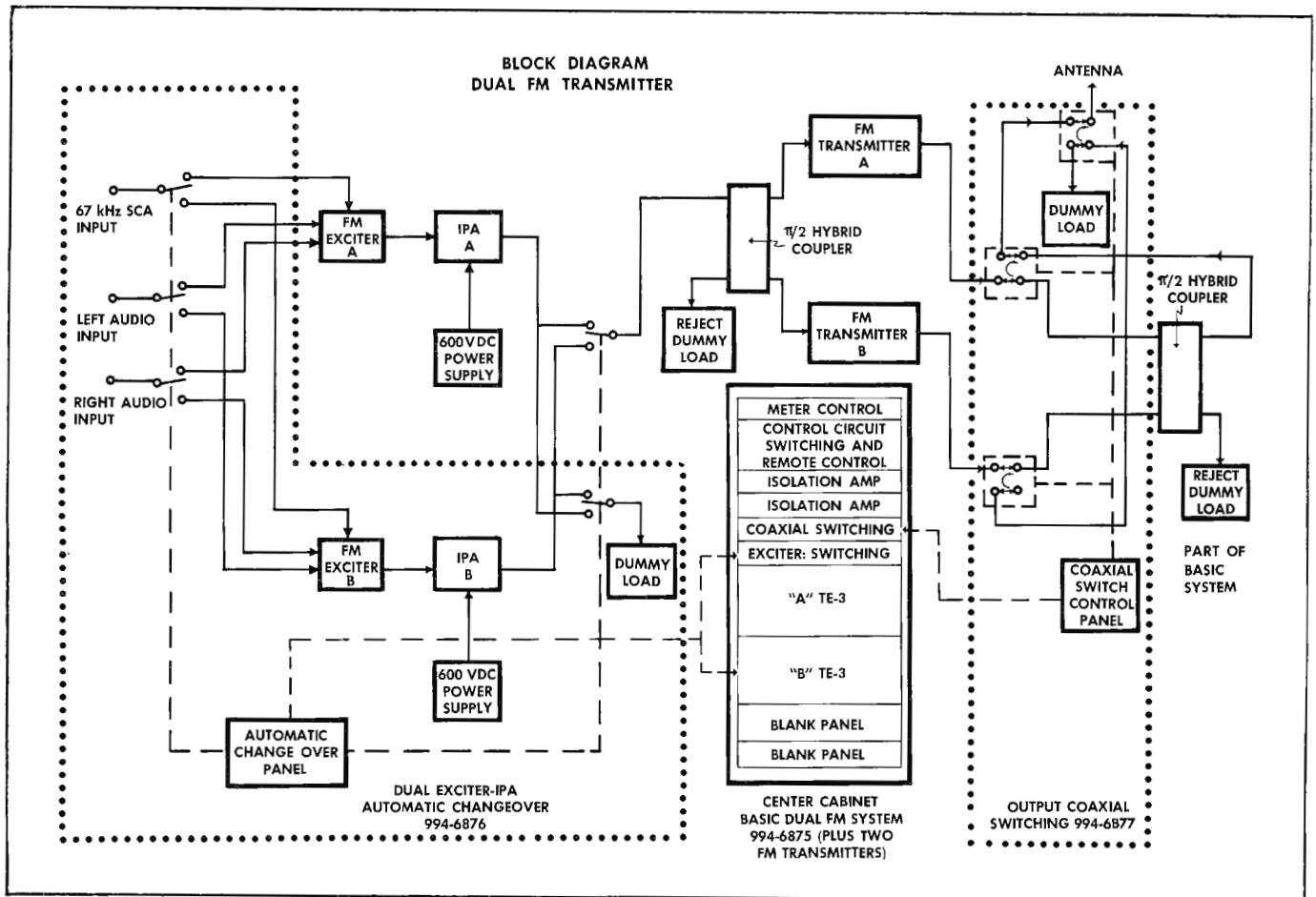

GATES' DUAL FM TRANSMITTER CONFIGURATIONS

Employing two standard FM transmitters (less exciters).

BASIC DUAL SYSTEM

- One TE-3 exciter.
- One isolation amplifier with power supply.
- One center cabinet.
- One high-power hybrid coupler (combiner) with plumbing to interconnect two transmitters.
- One low-power hybrid coupler.
- One reject load.
- One 50-watt reject load.

AUTOMATIC EXCITER/I.P.A. SWITCHING KIT

For exciter redundancy, the following additional equipment may be added to the basic system:

- One TE-3 exciter.
- One isolation amplifier with power supply.
- One dummy load for isolation amplifier.
- One automatic change-over contact panel (mounts in center cabinet).

RF OUTPUT SWITCHING

For RF switching of the high-power output amplifiers, the following equipment may be added to the basic system:

- One control panel (mounts in center cabinet).
- 3 coaxial transfer switches.
- One kit consisting of rigid coaxial line, elbows and flanges.
- One dummy load required—select from Optional Equipment below.

OPTIONAL EQUIPMENT FOR DUAL FM TRANSMITTERS

- Stereo generators.
- SCA generators.
- VSWR overload protection for each transmitter.
- Status light system for each transmitter.
- 50 kilowatt air-cooled dummy load.
- Water-cooled dummy load.
- Thru-line wattmeter with element.

ORDERING INFORMATION

Basic Dual FM System (does not include transmitters) ----- 994-6875
 Automatic Exciter/I.P.A. Switching Kit ----- 994-6876
 RF Output Switching ----- 994-6877

20,000 Watt FM Transmitter

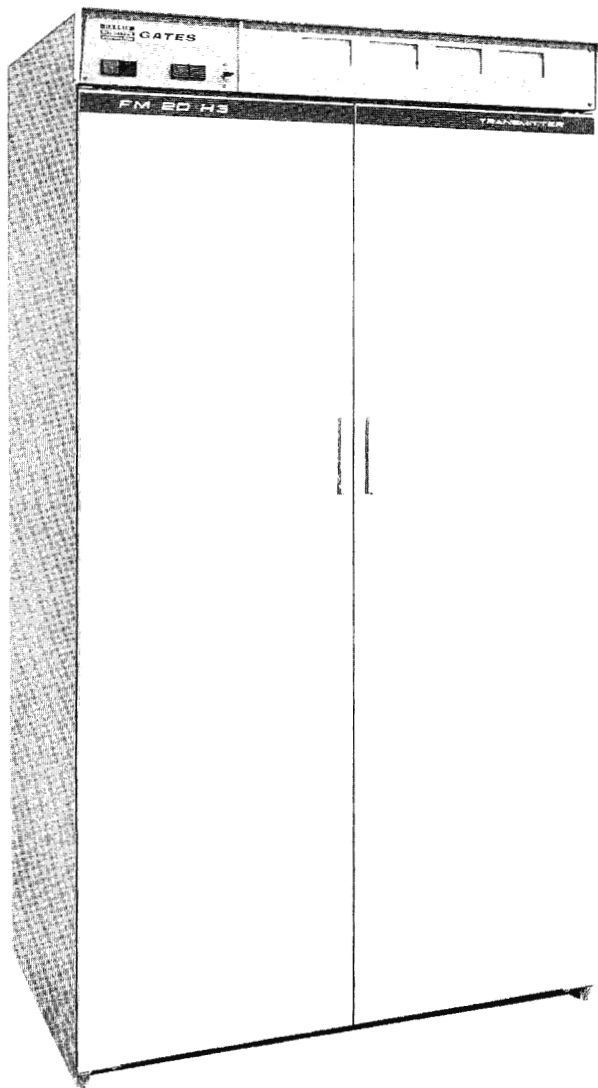

MODEL FM-20H3

The pace-setting engineering which produced Direct Carrier Frequency Modulation (DCFM), as employed in the FM-20H3, has made possible a three tube, 20,000 watt transmitter with the ultimate in performance standards. Fully FCC type accepted for stereo and monaural broadcasting in the 88 to 108 MHz FM band.

ONLY THREE TUBES: Solid state reliability is achieved, as the transmitter uses only three tubes for 20,000 watts output. The transistorized model TE-3 exciter delivers ten watts. This is followed by the only tubes employed—two parallel 4CX250B drivers and the rugged high-efficiency 4CX15000A single ended power amplifier.

POWER AMPLIFIER TUBE: The ceramic type 4CX15000A output tube assures excellent performance and long tube life for 20,000 watt FM service. This high power gain tetrode operates at a leisurely pace, dissipating little more than 5000 watts at a full 20,000 watts output.

SOLID STATE "DCFM" EXCITER: The 100% solid state model TE-3 exciter employs an advanced Gates design wherein the oscillator is modulated at the carrier frequency (DCFM). The result is improved carrier stability and unsurpassed frequency response. Modular construction of the TE-3 exciter allows plugging in of the solid state individually shielded stereo and SCA modules at any time.

PLUG-IN STEREO/SCA GENERATOR MODULES: To equip your FM-20H3 transmitter for stereo or SCA just plug the appropriate modules into the TE-3 exciter. For SCA you have your choice of 41 kHz and 67 kHz modules.

OPERATIONALLY TESTED: Environmental tests that surpass conditions of any location a transmitter is likely to encounter were imposed upon the FM-20H3 before it entered production. In addition, each transmitter is fully tuned and tested to the assigned frequency before shipment.

PUSHBUTTON OPERATION: On-off functions are controlled by lighted pushbuttons at the top left of the transmitter. These are plainly marked "filament on-off"; "plate on-off".

POWER OUTPUT CONTROL: In the FM-20H3 transmitter, Gates supplies a built-in motor-operated screen voltage control, for power output adjustment.

REMOTE CONTROL BUILT IN: All necessary functions can be remote controlled in the FM-20H3. No additional equipment is required for Gates remote control systems.

AUTOMATIC RECYCLING: In case of momentary overload, the FM-20H3 will recycle automatically. Should the overload reoccur in excess of the desired number of times preset in the transmitter, the transmitter will then remain off the air until reset locally or remotely.

HV SILICON POWER SUPPLIES: Two separate three-phase all-silicon power supplies are used in the FM-20H3. The 9000 volt supply, for PA plate voltage, is housed in a separate high voltage enclosure, and includes a manual switch to allow power cutback to approximately 5 kW. The other three-phase power supply, which powers the IPA plate and screen circuit, and also the PA screen, is housed in the main transmitter cabinet.

HANDSOME STYLING: The main transmitter cabinet is attractively, yet functionally styled, with double front doors, and an eye-catching meter panel framed in contoured brushed aluminum. The finish is in two-tone beige-gray. A separate enclosure for the HV power supply complements the main FM-20H3 cabinet.

20,000 Watt FM Transmitter—FM-20H3

HARMONIC FILTERS STANDARD EQUIPMENT: Included as standard equipment is a Tee type notch filter for second harmonic reduction, a micromatch VSWR section for direct meter reading on the transmitter of both power output and standing wave ratio, and a low pass filter which effectively eliminates third and higher order harmonics. Tuning and testing, which includes adjustment of filters for maximum harmonic attenuation, is accomplished at the factory on the customer's frequency.

EFFICIENT AIR COOLING: A heavy-duty impeller type blower was selected for use in the FM-20H3 to help increase component life. This blower moves up to 200% more air than required for normal heat dissipation of the transmitter when operating at altitudes up to 7500 feet—which means fast, efficient cooling for all components.

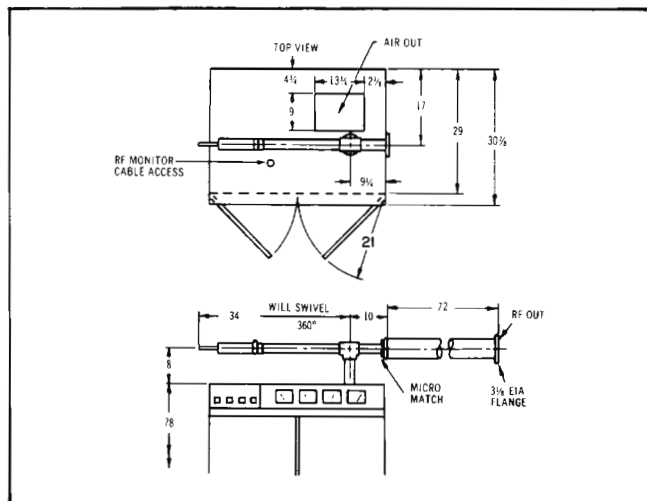

SPECIFICATIONS

GENERAL

POWER OUTPUT: 20 kW.
FREQUENCY RANGE: 87.5 to 108 MHz, tuned to specified operating frequency.
RF OUTPUT IMPEDANCE: 50 ohms.
OUTPUT TERMINATION: 3/4" EIA flange.
FREQUENCY STABILITY: .001% or better.
TYPE OF MODULATION: Direct Carrier Frequency Modulation.
MODULATION CAPABILITY: ±100 kHz.
AC INPUT POWER: 208/240 V, 3-phase 60 Hz. Power consumption 30,000 watts (approx.). 115 V single phase, 60 Hz, 300 watts. (50 Hz available on special order.)
RF HARMONICS: Suppression meets all FCC requirements.
POWER SUPPLY RECTIFIERS: Silicon.
ALTITUDE: 7,500 feet.
BLOWER: 1,250 cfm @ 6.3 inches.
AMBIENT TEMPERATURE RANGE: -20°C to +45°C.
MAXIMUM VSWR: 1.7 to 1.
OVER-ALL CABINET SIZE: Transmitter cabinet 42" W x 78" H x 32 3/4" D. HV power supply cabinet 30" W x 30" D x 49" H.
FRONT DOOR SWING: 21".
FINISH: Two-tone, beige-gray.
WEIGHT & CUBAGE: Export: 2,300 lbs. Domestic: 2,000 lbs. 150 cu. ft.

MONAURAL MODE

AUDIO INPUT IMPEDANCE: 600 ohms balanced.
AUDIO INPUT LEVEL: +10 dBm ±2 dB for 100% modulation at 400 Hz.
AUDIO FREQUENCY RESPONSE: Standard 75 microsecond, FCC pre-emphasis curve ±1 dB, 30-15,000 Hz.
DISTORTION: 0.5% or less, 30-15,000 Hz.
FM NOISE: 65 dB below 100% modulation (ref. 400 Hz).
AM NOISE: 50 dB below reference carrier AM modulated 100%.

STEREOPHONIC MODE (Stereo Generator optional)

PILOT OSCILLATOR: Crystal controlled.

PILOT STABILITY: 19 kHz ±1 Hz.
AUDIO INPUT IMPEDANCE: (left and right) 600 ohms balanced.
AUDIO INPUT LEVEL: (left and right) +10 dBm ±1 dB for 100% modulation at 400 Hz.
AUDIO FREQUENCY RESPONSE: (left and right) Standard 75 microsecond, FCC pre-emphasis curve ±1 dB, 50-15,000 Hz.
DISTORTION: (left or right) 1% or less, 50-15,000 Hz.
FM NOISE: (left or right) 60 dB minimum below 100% modulation, reference 400 Hz.
STEREO SEPARATION: 35 dB minimum 50-15,000 Hz.
SUB-CARRIER SUPPRESSION: 42 dB below 90% modulation.
CROSSTALK: (main to sub-channel or sub to main channel) 42 dB below 90% modulation.

SCA MODE (SCA Generator optional)

FREQUENCY STABILITY: ±500 Hz.
FREQUENCY: Between 25 and 75 kHz.
OSCILLATOR TYPE: Two Colpitts heterodyned to produce desired output frequency.
MODULATION: Direct FM.
MODULATION CAPABILITY: ±7.5 kHz.
AUDIO INPUT IMPEDANCE: 600 ohms balanced.
AUDIO INPUT LEVEL: +8 dBm, ±3 dB for 100% modulation at 400 Hz.
AUDIO FREQUENCY RESPONSE: 41 kHz and 67 kHz, 50 microsecond, modified pre-emphasis. 67 kHz response modified for proper operation when used with stereo to conform to FCC specifications.
DISTORTION: Less than 1.5% 30-7,000 Hz.
FM NOISE: (main channel not modulated) 55 dB minimum (ref. 100% modulation 400 Hz).
CROSSTALK: (sub-channel to main channel) -60 dB or better.
CROSSTALK: (main channel to sub-channel) 50 dB below 100% modulation (ref. 400 Hz).
AUTOMATIC MUTE LEVEL: Variable from 0 to 40 dB below 100% modulation.

ORDERING INFORMATION

| | |
|--|----------|
| FM-20H3, 20,000 watt FM broadcast transmitter, with TE-3 exciter | 994-6745 |
| 100% spare tube kit | 990-0552 |
| Stereo generator (add for stereo operation) | 994-6533 |
| SCA sub-carrier generator (add for SCA operation) | 994-6507 |

HARRIS
GATES DIVISION
Harris-Intertype Corporation

10,000 Watt FM Transmitter

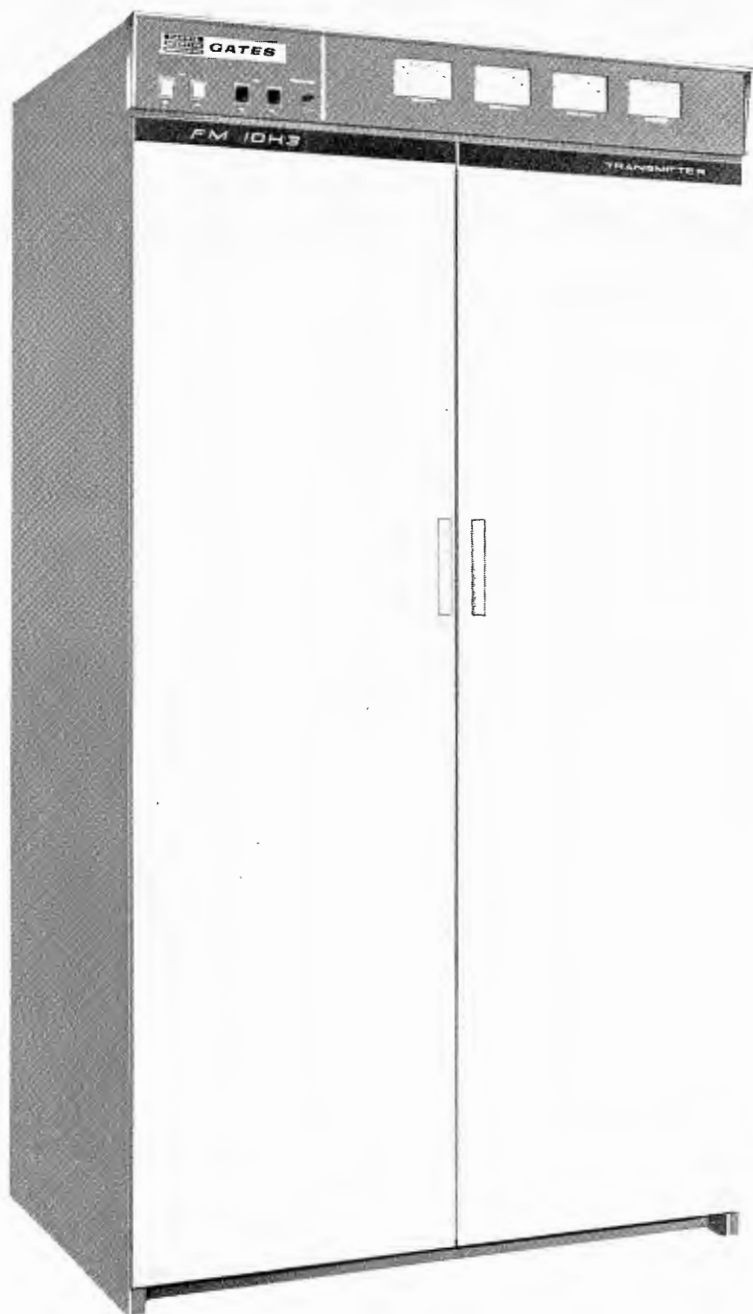

MODEL FM-10H3

Gates FM-10H3 is the most advanced 10,000 watt FM transmitter ever offered. It incorporates the TE-3 solid state "DCFM" exciter for unsurpassed stereophonic and monaural sound, and only two tubes are required to produce a full 10,000 watts. Gates model FM-10H3 is fully FCC type accepted for stereophonic (with optional stereo generator) and monaural FM broadcasting in the 88 to 108 MHz band.

TWO TUBES: Only two tubes are used in the entire transmitter. 10 watts is delivered from the model TE-3 transistorized exciter to the 4CX300A driver, which supplies a nominal 250 watts to drive the 4CX10,000D power amplifier. This power tetrode operates at a leisurely pace, providing ample power to deliver a high fidelity signal with proven economy.

TYPE 4CX10,000D POWER OUTPUT TUBE: Use of the power packed ceramic 4CX10,000D tube as the final amplifier assures excellent performance. It was selected because of its 10 kW plate dissipation, its ability to produce more power . . . and its proven longer, useful life.

SELF-CONTAINED: Except for the top-mounted Tee notch and low pass filters, the FM-10H3 transmitter is completely self-contained. The power transformer, solid state exciter, and optional stereo/SCA generating equipment are all housed in one attractively styled cabinet.

"DCFM" EXCITER: As in other "H3" series transmitters, the FM-10H3 employs the 100% solid state TE-3 exciter. An advanced design used first by Gates, the exciter employs Direct Carrier Frequency Modulation (DCFM) and Digital Automatic Frequency Control. This makes possible improved carrier stability and unsurpassed frequency response.

BUILT-IN REMOTE CONTROL: Connect the transmitter control unit to the transmitter, tie in the telephone line to the studio control unit, and you are ready for complete remote control operation. All necessary functions can be controlled remotely—and no additional equipment is required for a Gates remote control system.

POWER GUARD: The FM-10H3 employs a special power supply protective circuit, Power Guard, to assure maximum protection from transient voltages or on-off power surges.

AUTOMATIC RECYCLING: Should a momentary overload occur, the FM-10H3 will recycle automatically. If the overload reoccurs in excess of the number of times preset in the transmitter, the transmitter will remain off the air until it is reset, either manually or by remote control.

SILICON RECTIFIERS: For increased reliability, silicon power rectifiers are used in all FM-10H3 power supplies. Operated well below their rated levels, they provide years of dependable service in the transmitter. In the HV power supply, a generous number of 16 ampere silicon cells operate in a three phase bridge, and are so rugged that maximum transmitter current demand is only 50% of the peak rating of the supply. Three solid state power supplies are used; high voltage, bias, and exciter.

10,000 Watt FM Transmitter—FM-10H3

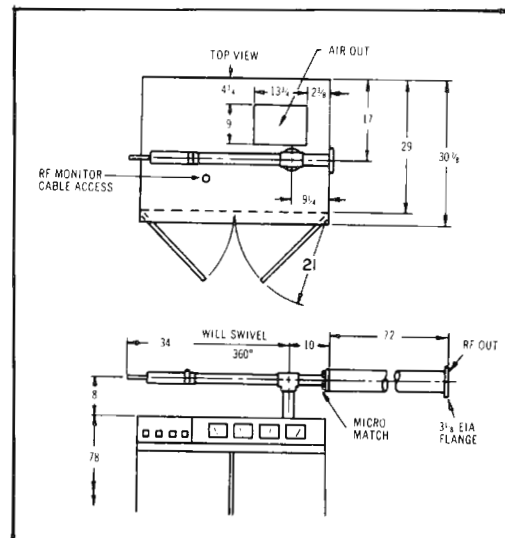
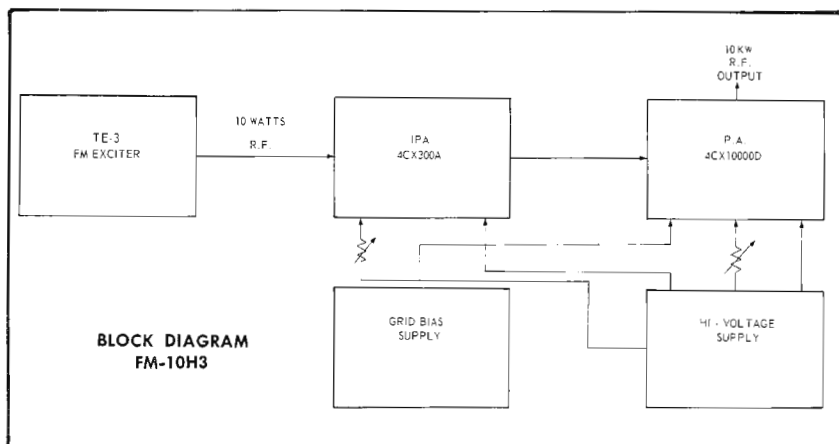

SPECIFICATIONS

GENERAL

POWER OUTPUT: 10 kW.
FREQUENCY RANGE: 87.5 to 108 MHz, tuned to specified operating frequency.
RF OUTPUT IMPEDANCE: 50 ohms.
OUTPUT TERMINATION: 3/8" EIA flange.
FREQUENCY STABILITY: .001% or better.
TYPE OF MODULATION: Direct Carrier Frequency Modulation.
MODULATION CAPABILITY: ±100 kHz.
AC INPUT POWER: 208/240 V, 3 phase, 60 Hz at 17 kW. 115 V, single phase, 60 Hz, 300 watts, (50 Hz available on special order.)
POWER SUPPLY RECTIFIERS: Silicon.
RF HARMONICS: Suppression meets all FCC requirements.
ALTITUDE: 7,500 feet.
BLOWER: 430 cfm @ 2.6 inches.
AMBIENT TEMPERATURE RANGE: -20°C to +45°C.
MAXIMUM VSWR: 1.7 to 1.
OVER-ALL CABINET SIZE: 42" W x 78" H x 32 3/4" D.*
 *32 3/4" is over-all depth dimension. With rear door and front door handles removed, minimum depth is 29 3/4".
FRONT DOOR SWING: 21".
FINISH: Two-tone, beige-gray.
WEIGHT & CUBAGE: Export: 975 lbs. Domestic: 825 lbs. 110 cu. ft.

MONAURAL MODE

AUDIO INPUT IMPEDANCE: 600 ohms balanced.
AUDIO INPUT LEVEL: +10 dBm ±2 dB for 100% modulation at 400 Hz.
AUDIO FREQUENCY RESPONSE: Standard 75 microsecond, FCC pre-emphasis curve ±1 dB, 30-15,000 Hz.
DISTORTION: 0.5% or less, 30-15,000 Hz.
FM NOISE: 65 dB below 100% modulation (ref. 400 Hz).
AM NOISE: 50 dB below reference carrier AM modulated 100%.

STEREOPHONIC MODE (Stereo Generator optional)

PILOT OSCILLATOR: Crystal controlled.
PILOT STABILITY: 19 kHz ±1 Hz.
AUDIO INPUT IMPEDANCE: (left and right) 600 ohms balanced.
AUDIO INPUT LEVEL: (left and right) +10 dBm ±1 dB for 100% modulation at 400 Hz.
AUDIO FREQUENCY RESPONSE: (left and right) Standard 75 microsecond, FCC pre-emphasis curve ±1 dB, 50-15,000 Hz.
DISTORTION: (left or right) 1% or less, 50-15,000 Hz.
FM NOISE: (left or right) 60 dB minimum below 100% modulation, reference 400 Hz.
STEREO SEPARATION: 35 dB minimum 50-15,000 Hz.
SUB-CARRIER SUPPRESSION: 42 dB below 90% modulation.
CROSSTALK: (main to sub-channel or sub to main channel) 42 dB below 90% modulation.

SCA MODE (SCA Generator optional)

FREQUENCY STABILITY: ±500 Hz.
FREQUENCY: Between 25 and 75 kHz.
OSCILLATOR TYPE: Two Colpitts heterodyned to produce desired output frequency.
MODULATION: Direct FM.
MODULATION CAPABILITY: ±7.5 kHz.
AUDIO INPUT IMPEDANCE: 600 ohms balanced.
AUDIO INPUT LEVEL: +8 dBm, ±3 dB for 100% modulation at 400 Hz.
AUDIO FREQUENCY RESPONSE: 41 kHz and 67 kHz, 50 microsecond, modified pre-emphasis. 67 kHz response modified for proper operation when used with stereo to conform to FCC specifications.
DISTORTION: Less than 1.5% 30-7000 Hz.
FM NOISE: (main channel not modulated) 55 dB minimum (ref. 100% modulation 400 Hz).
CROSSTALK: (sub-channel to main channel) -60 dB or better.
CROSSTALK: (main channel to sub-channel) 50 dB below 100% modulation (ref. 400 Hz).
AUTOMATIC MUTE LEVEL: Variable from 0 to 40 dB below 100% modulation.

ORDERING INFORMATION

| | |
|---|----------|
| FM-10H3, 10,000 watt FM broadcast transmitter, with TE-3 exciter..... | 994-6744 |
| 100% spare tube kit..... | 990-0551 |
| Stereo generator (add for stereo operation)..... | 994-6533 |
| SCA sub-carrier generator (add for SCA operation)..... | 994-6507 |

3000-5000-7500 Watt FM Transmitters

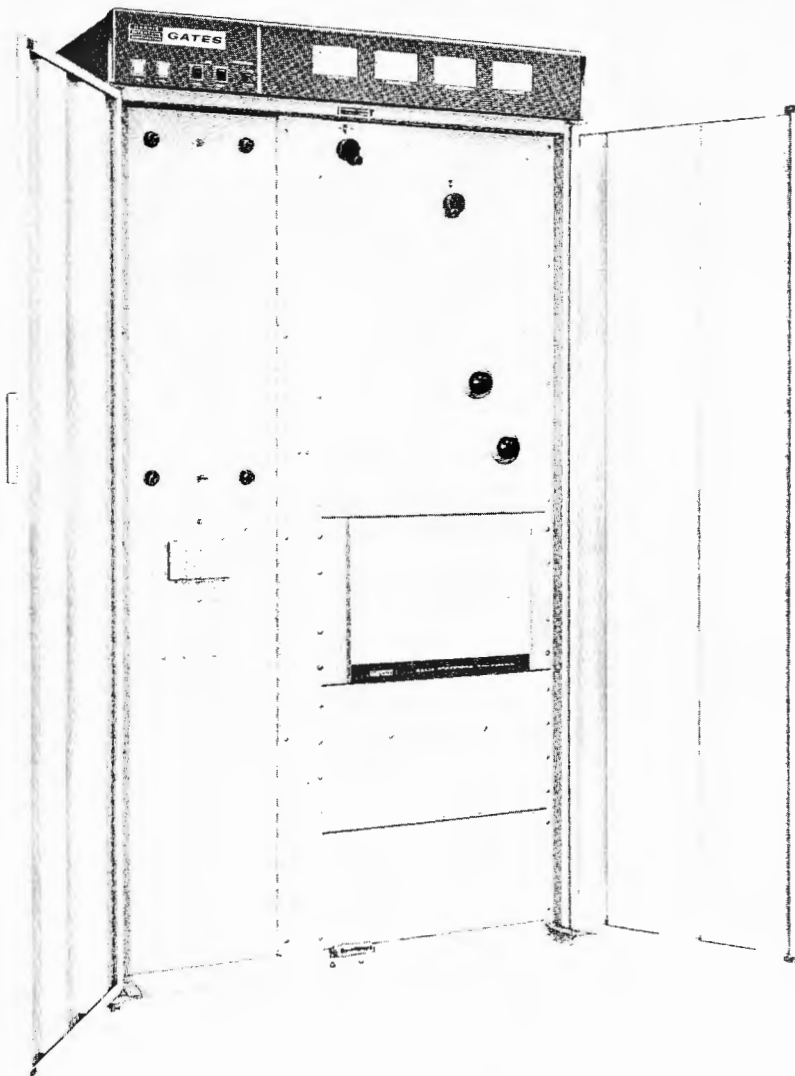

MODELS FM-3H3—FM-5H3—FM-7.5H3

Gates FM-3H3, FM-5H3 and FM-7.5H3 transmitters provide 3,000-5,000-7,500 watts output with just two tubes—and feature the performance proven solid state TE-3 exciter, employing Direct Carrier Frequency Modulation. Quality all the way, both transmitters combine the reliability of solid state circuitry and the superb performance of "DCFM" for outstanding stereo (with optional stereo generator) and monaural transmission. Each transmitter is FCC type accepted for stereophonic and monaural FM broadcasting in the 88 to 108 MHz band.

ONLY TWO TUBES: With the transistorized 10 watt model TE-3 exciter incorporated into these transmitters, only two tubes are needed. A type 4CX250B tube amplifies the solid state exciter output and supplies a nominal 250 watts to drive the ceramic 4CX-5000A final tube. This power tetrode operates as a single ended amplifier to produce 3, 5 or 7.5 kilowatts of power.

HARRIS
GATES DIVISION
Harris-Intertype Corporation

"DCFM" PERFORMANCE: The superior engineering design of Gates TE-3 exciter includes Direct Carrier Frequency Modulation for superior stereo performance and Digital Automatic Frequency Control for maximum stability.

In all three transmitters stereo separation is 35 dB minimum from 50 Hz to 15 kHz.

Self-contained within these transmitters, the "DCFM" exciter is of modular construction so that the solid state stereo and SCA modules may be plugged in at any time.

VARI-LINE TUNING: Field proven for dependability, Gates Vari-Line tuning is used in the FM-3H3, FM-5H3 and FM-7.5H3 transmitters. This is an advanced method of tuning a single ended FM amplifier to achieve optimum output efficiency.

HARMONIC REDUCTION: Included as standard equipment in the transmitters is a Tee type notch filter for second harmonic reduction, a micro-match VSWR section for direct meter reading of both power output and standing wave ratio, and a low pass filter which effectively eliminates third and higher order harmonics.

SPECIAL PROTECTIVE CIRCUIT: The transmitters are protected by Power Guard, a Gates developed power supply protective circuit, that provides maximum protection from transient voltages.

If a momentary overload occurs, the transmitter will recycle automatically up to the number of times preset.

For increased dependability, solid state rectifiers are standard in these transmitters.

OPERATING CONVENIENCE: "On-off" functions in the transmitters are controlled by two lighted pushbuttons at the top left of the transmitter. The multimeter control switch is located just to the right of these pushbuttons.

Full metering is provided with four large, front panel meters, including a VSWR power indicator that permits direct reading of both power output and standing wave ratio.

SELF-CONTAINED: The power supply, exciter, power transformers and optional stereo generating/SCA equipment are all housed in one cabinet, for simplified transmitter installation.

REMOTE CONTROL: In the FM-3H3, FM-5H3 and FM-7.5H3, all functions can be remote controlled. Simply connect the transmitter control unit of the Gates remote control system and remote operation is ready.

3000-5000-7500 Watt FM Transmitters

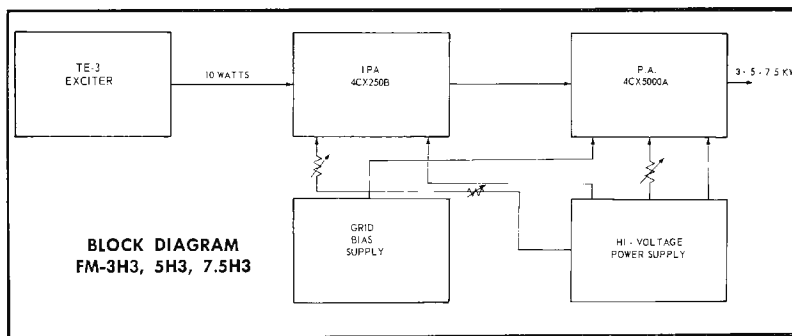
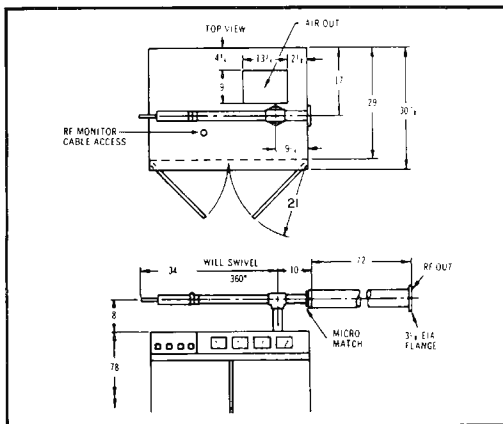

SPECIFICATIONS

GENERAL

- POWER OUTPUT:** 3, 5 or 7.5 kW.
- FREQUENCY RANGE:** 87.5 to 108 MHz, tuned to specified operating frequency.
- RF OUTPUT IMPEDANCE:** 50 ohms.
- OUTPUT TERMINATION:** 3/8" EIA flange.
- FREQUENCY STABILITY:** .001% or better.
- TYPE OF MODULATION:** Direct Carrier Frequency Modulation.
- MODULATION CAPABILITY:** ±100 kHz.
- AC INPUT POWER:** 208/240 V, 3 phase. 6.8 kW consumption at 3 kW output. 10 kW consumption at 5 kW output. 15 kW consumption at 7.5 kW output. 115 V single phase, 60 Hz 300 watts. (50 Hz available on special order.)
- POWER SUPPLY RECTIFIERS:** Silicon.
- RF HARMONICS:** Suppression meets all FCC requirements.
- ALTITUDE:** 7,500 feet.
- BLOWER:** 390 cfm @ 3.2 inches.
- AMBIENT TEMPERATURE RANGE:** -20°C to +45°C.
- MAXIMUM VSWR:** 1.7 to 1.
- OVER-ALL CABINET SIZE:** 42" W x 78"H x 32 3/4" D.*
*32 3/4" is over-all depth dimension. With rear door and front door handles removed, minimum depth is 29 3/4".
- FRONT DOOR SWING:** 21".
- FINISH:** Two-tone beige-gray.
- WEIGHT AND CUBAGE:** Export: 900 lbs. Domestic: 750 lbs. 110 cu. ft.

MONAURAL MODE

- AUDIO INPUT IMPEDANCE:** 600 ohms balanced.
- AUDIO INPUT LEVEL:** +10 dBm ±2 dB for 100% modulation at 400 Hz.
- AUDIO FREQUENCY RESPONSE:** Standard 75 microsecond, FCC pre-emphasis curve ±1 dB, 30-15,000 Hz.
- DISTORTION:** 0.5% or less, 30-15,000 Hz.
- FM NOISE:** 65 dB below 100% modulation (ref. 400 Hz).
- AM NOISE:** 50 dB below reference carrier AM modulated 100%.

STEREOPHONIC MODE (Stereo Generator optional)

- PILOT OSCILLATOR:** Crystal controlled.
- PILOT STABILITY:** 19 kHz ±1 Hz.
- AUDIO INPUT IMPEDANCE:** (left and right) 600 ohms balanced.
- AUDIO INPUT LEVEL:** (left and right) +10 dBm ±1 dB for 100% modulation at 400 Hz.
- AUDIO FREQUENCY RESPONSE:** (left and right) Standard 75 microsecond, FCC pre-emphasis curve ±1 dB, 50-15,000 Hz.
- DISTORTION:** (left or right) 1% or less, 50-15,000 Hz.
- FM NOISE:** (left or right) 60 dB minimum below 100% modulation, reference 400 Hz.
- STEREO SEPARATION:** 35 dB minimum 50-15,000 Hz.
- SUB-CARRIER SUPPRESSION:** 42 dB below 90% modulation.
- CROSSTALK:** (main to sub-channel or sub to main channel) 42 dB below 90% modulation.

SCA MODE (SCA Generator optional)

- FREQUENCY STABILITY:** ±500 Hz.
- FREQUENCY:** Between 25 and 75 kHz.
- OSCILLATOR TYPE:** Two Colpitts heterodyned to produce desired output frequency.
- MODULATION:** Direct FM.
- MODULATION CAPABILITY:** ±7.5 kHz.
- AUDIO INPUT IMPEDANCE:** 600 ohms balanced.
- AUDIO INPUT LEVEL:** +8 dBm, ±3 dB for 100% modulation at 400 Hz.
- AUDIO FREQUENCY RESPONSE:** 41 kHz and 67 kHz, 50 microsecond, modified pre-emphasis. 67 kHz response modified for proper operation when used with stereo to conform to FCC specifications.
- DISTORTION:** Less than 1.5% 30-7000 Hz.
- FM NOISE:** (main channel not modulated) 55 dB minimum (ref. 100% modulation 400 Hz).
- CROSSTALK:** (sub-channel to main channel) -60 dB or better.
- CROSSTALK:** (main channel to sub-channel) 50 dB below 100% modulation (ref. 400 Hz).
- AUTOMATIC MUTE LEVEL:** Variable from 0 to 40 dB below 100% modulation.

ORDERING INFORMATION

| | |
|---|----------|
| FM-3H3, 3000 watt FM broadcast transmitter with TE-3 exciter..... | 994-6574 |
| FM-5H3, 5000 watt FM broadcast transmitter with TE-3 exciter..... | 994-6736 |
| FM-7.5H3, 7500 watt FM broadcast transmitter with TE-3 exciter..... | 994-6743 |
| 100% spare tube kit for all of above..... | 990-0549 |
| Stereo generator (add for stereo operation)..... | 994-6533 |
| SCA sub-carrier generator (add for SCA operation)..... | 994-6507 |

2500 Watt FM Transmitter

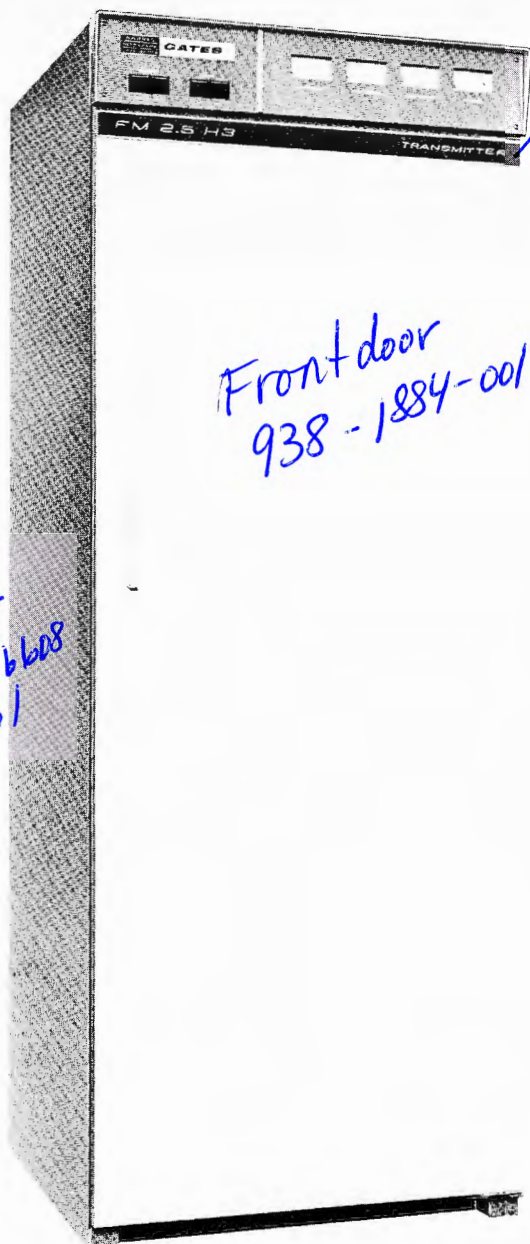

MODEL FM-2.5H3

The FM-2.5H3 employs only two tubes for an output of 2,500 watts, assuring greater reliability. Driven by Gates' TE-3 solid-state exciter, the two stages are a 4X150A intermediate power amplifier, and the 5CX1500A single-ended final amplifier.

Sophisticated broadband circuitry assures maximum stereo separation and minimum crosstalk to provide listeners with the finest sound in FM. The FM-2.5H3 is FCC type accepted for 2,500 watts output for both monaural and stereophonic transmission in the 88 to 108 MHz band.

STABLE, EASY OUTPUT TUNING: Plate tuning of the final amplifier is stable and easily adjusted. The plate circuit is a shorted, one-quarter wave-length configuration, with the plate-line operated at DC ground potential. Coarse plate tuning is pre-set for the operating frequency on the quarter wave plate circuit. Fine adjustment is made with the plate tuning knob on the front panel. Amplifier loading is changed by a variable output loading control.

POWER OUTPUT CONTROL: The transmitter has a built-in motor-operated rheostat connected to the screen supply for adjusting the power output. A built-in reflectometer with a VSWR power meter makes adjustments of the power output easy and accurate.

PUSHBUTTON OPERATION: Manual operation of the transmitter is simple. On-Off functions are controlled by lighted, dual pushbuttons at the top left of the cabinet. They are clearly marked Filament On and Off, Plate On and Off. After the filaments of the tubes are turned on, a time-delay relay allows the cathodes to reach operating temperatures before the Plate power can be turned on.

AUTOMATIC RECYCLING: In case of momentary overload, the transmitter will recycle automatically. If the overload repeats more than the desired number of times pre-set in the transmitter, the transmitter will then stay off the air until it is reset locally or by remote control.

REMOTE CONTROL: All necessary operating functions can be remote controlled. No additional equipment is required to adapt a Gates Remote Control System to the transmitter. Connections are easily made at a terminal on the side of the cabinet.

PLUG-IN STEREO AND SCA: A station engineer can equip the transmitter for stereo and/or SCA operation at any time. Gates' unique modular design of the TE-3 solid-state exciter makes this possible using plug-in units.

Initially, the transmitter can be ordered for monophonic service. Later, plug-in stereo and SCA can be added.

Stereo separation of 35 dB minimum from 50 to 15,000 Hz makes the FM-2.5H3 outstanding for stereophonic broadcasting.

HARMONIC FILTERS STANDARD: Supplied with a Gates-designed harmonic filter, the transmitter fully meets FCC requirements for spurious radiation. All filtering is mounted inside the transmitter cabinet and provides rapid cut-off of second and higher order harmonics.

QUALITY COMPONENTS: Every transmitter component is conservatively operated and chosen to give optimum performance in continuous duty service. In Gates' TE-3 exciter, only performance-proven solid-state devices and precision temperature compensated components are used throughout.

2500 Watt FM Transmitter—FM-2.5H3

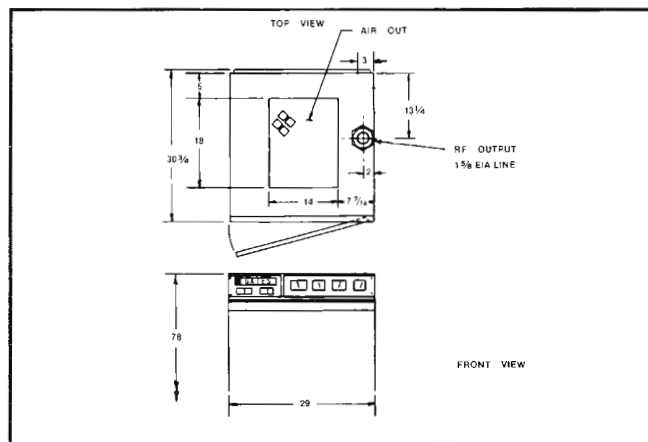
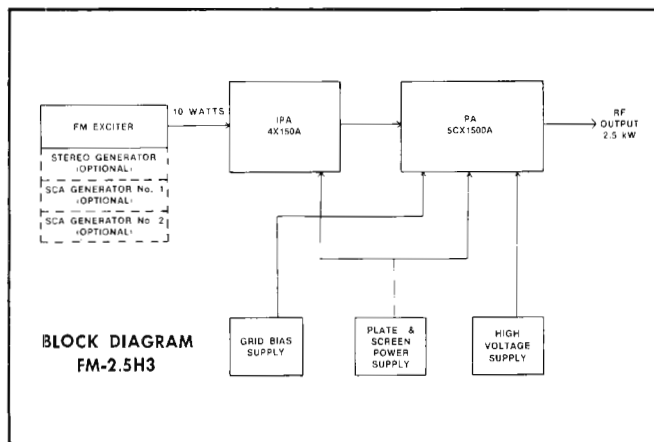

SPECIFICATIONS

GENERAL:

POWER OUTPUT: 1 to 2.5 kW.
FREQUENCY RANGE: 87.5 to 108 MHz, tuned to specified operating frequency.
RF OUTPUT IMPEDANCE: 50 ohms.
OUTPUT TERMINATION: 1 1/2" EIA flange.
FREQUENCY STABILITY: .001% or better.
TYPE OF MODULATION: Direct Carrier Frequency Modulation.
MODULATION CAPABILITY: ±100 kHz.
AC INPUT POWER: 197/250 V., 50/60 Hz, single phase, two wire.
 Power consumption: 4800 watts (approx.) 115 V., 50/60 Hz, 100 watts for TE-3.
RF HARMONICS: Suppression meets all FCC requirements.
POWER SUPPLY RECTIFIERS: Silicon.
ALTITUDE: 7500 feet.
AMBIENT TEMPERATURE RANGE: -20°C to +45°C.
MAXIMUM VSWR: 1.7 to 1.
OVERALL CABINET SIZE: 29" W. × 78" H. × 33" D.
FRONT DOOR SWING: 29".
FINISH: Two-tone, beige-gray.
WEIGHT & CUBAGE: Export: 700 lbs. Domestic: 580 lbs. 72 cu. ft.

MONAURAL MODE:

AUDIO INPUT IMPEDANCE: 600 ohms balanced.
AUDIO INPUT LEVEL: +10 dBm ±2 dB for 100% modulation at 400 Hz.
AUDIO FREQUENCY RESPONSE: Standard 75 microsecond, FCC pre-emphasis curve ±1 dB, 30-15,000 Hz.
DISTORTION: 0.5% or less, 30-15,000 Hz.
FM NOISE: 65 dB below 100% modulation (ref. 400 Hz).
AM NOISE: 55 dB below reference carrier AM modulation 100%.

STEREOPHONIC MODE:

PILOT OSCILLATOR: Crystal controlled.
PILOT STABILITY: 19 kHz ±1 Hz.
AUDIO INPUT IMPEDANCE: (left and right) 600 ohms balanced.
AUDIO INPUT LEVEL: (left and right) +10 dBm ±1 dB for 100% modulation at 400 Hz.
AUDIO FREQUENCY RESPONSE: (left and right) Standard 75 microsecond, FCC pre-emphasis curve ±1 dB, 50-15,000 Hz.
DISTORTION: (left or right) 1% or less, 50-15,000 Hz.
FM NOISE: (left or right) 60 dB minimum below 100% modulation. Reference 400 Hz.
STEREO SEPARATION: 35 dB minimum 50-15,000 Hz.
SUB-CARRIER SUPPRESSION: 42 dB below 90% modulation.
CROSSTALK: (main to sub-channel or sub-to main channel) 42 dB below 90% modulation.

SCA SPECIFICATIONS:

FREQUENCY STABILITY: ±500 Hz.
FREQUENCY: Between 25 and 75 kHz.
OSCILLATOR TYPE: Two Colpitts heterodyned to produce desired output frequency.
MODULATION: Direct FM.
MODULATION CAPABILITY: ±7.5 kHz.
AUDIO INPUT IMPEDANCE: 600 ohms balanced.
AUDIO INPUT LEVEL: +8 dBm, ±3 dB for 100% modulation at 400 Hz.
AUDIO FREQUENCY RESPONSE: 41 kHz and 67 kHz, 50 microsecond modified pre-emphasis. 67 kHz response modified for proper operation when used with stereo to conform to FCC specifications.
DISTORTION: Less than 1.5% 30-7000 Hz.
FM NOISE: (main channel not modulated) 55 dB minimum (ref. 100% modulation 400 Hz).
CROSSTALK: (sub-channel to main channel): -60 dB or better.
CROSSTALK: (main channel to sub-channel): 50 dB below 100% modulation (ref. 400 Hz), with main channel modulated 70% by frequencies 30-15,000 Hz.
AUTOMATIC MUTE LEVEL: Variable from 0 to -40 dB below 100% modulation.

ORDERING INFORMATION

| | | |
|---|-------|----------|
| FM-2.5H3 2500-watt FM broadcast transmitter with TE-3 exciter | ----- | 994-6871 |
| 100% spare tube kit | ----- | 990-0587 |
| Stereo generator (add for stereo operation) | ----- | 994-6533 |
| SCA generator (add for SCA operation) | ----- | 994-6507 |

1000 Watt FM Transmitter

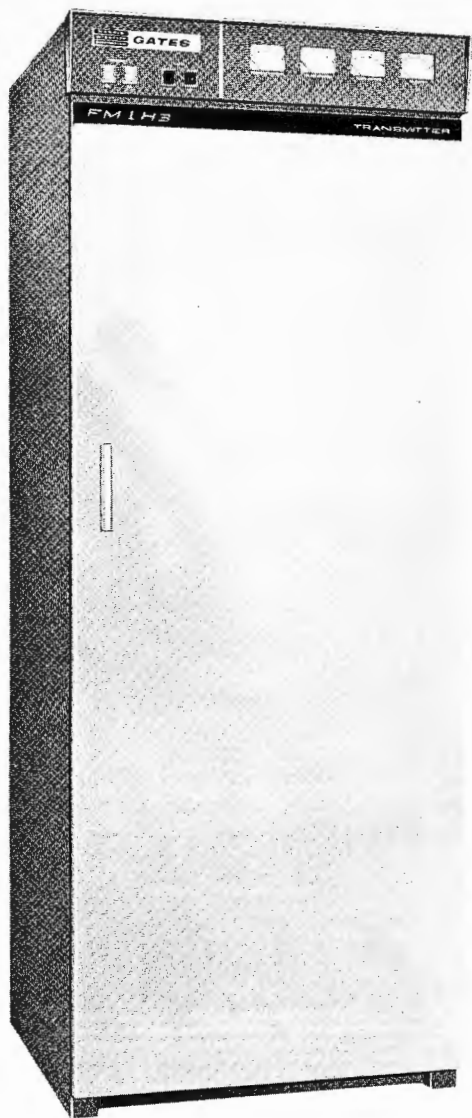

MODEL FM-1H3

Superb for stereo, multiplex or monaural sound, the one tube, 1000 watt model FM-1H3 transmitter incorporates the all solid state TE-3 exciter, employing Direct Carrier Frequency Modulation. The FM-1H3 is FCC type accepted for 1000 watt output for both monaural and stereophonic transmission in the 88 to 108 MHz band.

ONE TUBE DESIGN: Just one tube—a modern type 4CX1000A tetrode—is all that is needed to supply 1000 watts output in the FM-1H3. Driven directly by the 10 watt exciter, the 4CX-1000A serves as the power amplifier and is operated well within its ratings. A voltage regulated filament assures longer useful tube life, and greater on-the-air reliability.

STABILITY AND EFFICIENCY: Forced air cooled, the 4CX-1000A power amplifier stage is mounted in a fully shielded enclosure to eliminate power losses by radiation or interaction. A shorted quarter-wave type plate circuit reduces harmonics and spurious radiation to a minimum, and the entire amplifier has a high degree of stability.

ADVANCED TE-3 EXCITER: The 100% solid state Direct Carrier Frequency Modulation (DCFM) exciter provides a full 10 watts output, and is completely self-contained within the FM-1H3. With "DCFM" and Digital Automatic Frequency Control, highly improved carrier stability and excellent frequency response are assured.

STEREO/MULTIPLEX OPERATION: In the FM-1H3, stereo separation is 35 dB minimum from 50 to 15,000 Hz. Plugging in the optional stereo or SCA generators takes only a few seconds, as pre-wired spaces are provided in the TE-3 exciter for these modules.

SOLID STATE RECTIFIERS: Silicon rectifiers are standard equipment in this modern slimline transmitter. These dependable rectifiers provide generous voltage and current safety factors throughout.

HARMONIC FILTERS: Supplied with a Gates designed multi-section harmonic filter, the FM-1H3 transmitter fully meets FCC requirements regarding spurious radiation. The Tee filter section provides rapid cut off in the second harmonic region, and is located in the transmitter cabinet. The remaining filter elements, for further attenuation of the second and higher order harmonics, are housed in a six foot section of standard 3½-inch transmission line. They may be considered as part of the over-all transmission line system for installation purposes.

READY FOR REMOTE CONTROL: Remote control capabilities are built into the FM-1H3 transmitter, including terminations to attach to most remote control equipment. A motor driven loading control to vary power output from the remote point is supplied as standard equipment.

AUTOMATIC RECYCLING: The FM-1H3 recycles and is again turned on in case of momentary overload. If, after three or four consecutive overloads, it fails to turn itself on, the transmitter remains off until the "Plate On" function is activated either locally or by remote control.

STEREO AND SCA MODULES: Operating flexibility is assured by the all solid state stereo and SCA modules. Plugging directly into the model TE-3 exciter, these units provide unexcelled performance standards for modern FM broadcasting.

1000 Watt FM Transmitter—FM-1H3

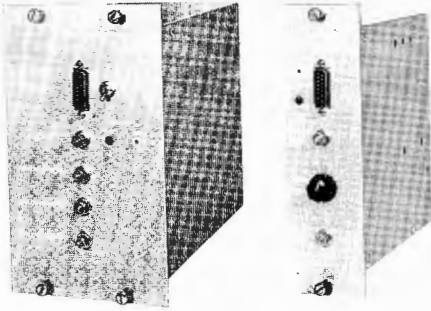

STEREO AND SCA MODULES: Plugging directly into the model TE-3 exciter, these units provide unexcelled performance for modern FM broadcasting.

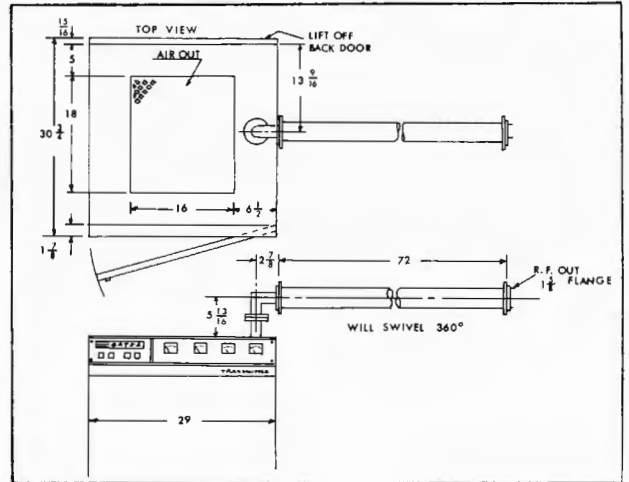

SPECIFICATIONS

GENERAL

POWER OUTPUT: 1 kW.
FREQUENCY RANGE: 87.5 to 108 MHz, tuned to specified operating frequency.
RF OUTPUT IMPEDANCE: 50 ohms.
OUTPUT TERMINATION: 1 1/2" EIA female flange.
FREQUENCY STABILITY: .001% or better.
TYPE OF MODULATION: Direct Carrier Frequency Modulation.
MODULATION CAPABILITY: ±100 kHz.
AC INPUT POWER: 208/240 V, 50/60 Hz, single phase, 3 wire. Power consumption 2500 watts (approx.).
POWER SUPPLY RECTIFIERS: Silicon.
RF HARMONICS: Suppression meets all FCC requirements.
ALTITUDE: 7500 feet.
BLOWER: 115 cfm @ .45 inches.
AMBIENT TEMPERATURE RANGE: -20°C to +45°C.
MAXIMUM VSWR: 1.7 to 1.
OVER-ALL CABINET SIZE: 29" W x 78" H x 32 3/4" D.
FRONT DOOR SWING: 29".
FINISH: Two-tone, beige-gray.
WEIGHT & CUBAGE: Export: 670 lbs. Domestic: 550 lbs. Cubage: 72.

MONAURAL MODE

AUDIO INPUT IMPEDANCE: 600 ohms balanced.
AUDIO INPUT LEVEL: ±10 dBm ±2 dB for 100% modulation at 400 Hz.
AUDIO FREQUENCY RESPONSE: Standard 75 microsecond FCC pre-emphasis curve ±1 dB, 30-15,000 Hz.
DISTORTION: 0.5% or less, 30-15,000 Hz.
FM NOISE: 65 dB below 100% modulation (ref. 400 Hz).
AM NOISE: 50 dB below reference carrier AM modulated 100%.

STEREOPHONIC MODE (Stereo Generator optional)

PILOT OSCILLATOR: Crystal controlled.

PILOT STABILITY: 19 kHz ±1 Hz.
AUDIO INPUT IMPEDANCE: (Left and right) 600 ohms balanced.
AUDIO INPUT LEVEL: (left and right) +10 dBm ±1 dB for 100% modulation at 400 Hz.
AUDIO FREQUENCY RESPONSE: (Left and right) standard 75 microsecond, FCC pre-emphasis curve ±1 dB, 50-15,000 Hz.
DISTORTION: (Left and right) 1% or less, 50-15,000 Hz.
FM NOISE: (Left and right) 60 dB minimum below 100% modulation, reference 400 Hz.
STEREO SEPARATION: 35 dB minimum 50-15,000 Hz.
SUB-CARRIER SUPPRESSION: 42 dB below 90% modulation.
CROSSTALK: (Main to sub-channel or sub to main channel) 42 dB below 90% modulation.

SCA MODE (SCA Generator optional)

FREQUENCY STABILITY: ±500 Hz.
FREQUENCY: Between 25 and 75 kHz.
OSCILLATOR TYPE: Two Colpitts heterodyned to produce desired output frequency.
MODULATION: Direct FM.
MODULATION CAPABILITY: ±7.5 kHz.
AUDIO INPUT IMPEDANCE: 600 ohms balanced.
AUDIO INPUT LEVEL: ±8 dBm, ±3 dB for 100% modulation at 400 Hz.
AUDIO FREQUENCY RESPONSE: 41 kHz and 67 kHz, 50 microsecond, modified pre-emphasis. 67 kHz response modified for proper operation when used with stereo to conform to FCC specifications.
DISTORTION: Less than 1.5% 30-7000 Hz.
FM NOISE: (Main channel not modulated) 55 dB minimum (ref. 100% modulation 400 Hz).
CROSSTALK: (Sub-channel to main channel) -60 dB or better.
CROSSTALK: (Main channel to sub-channel) 50 dB below 100% modulation (ref. 400 Hz).
AUTOMATIC MUTE LEVEL: Variable from 0 to 40 dB below 100% modulation.

ORDERING INFORMATION

| | | |
|--|-------|----------|
| FM-1H3, 1000 watt FM broadcast transmitter with TE-3 exciter | | 994-6740 |
| 100% spare tube kit | | 990-0550 |
| Stereo generator (add for stereo operation) | | 994-6533 |
| SCA sub-carrier generator (add for SCA operation) | | 994-6507 |



250 Watt FM Transmitter

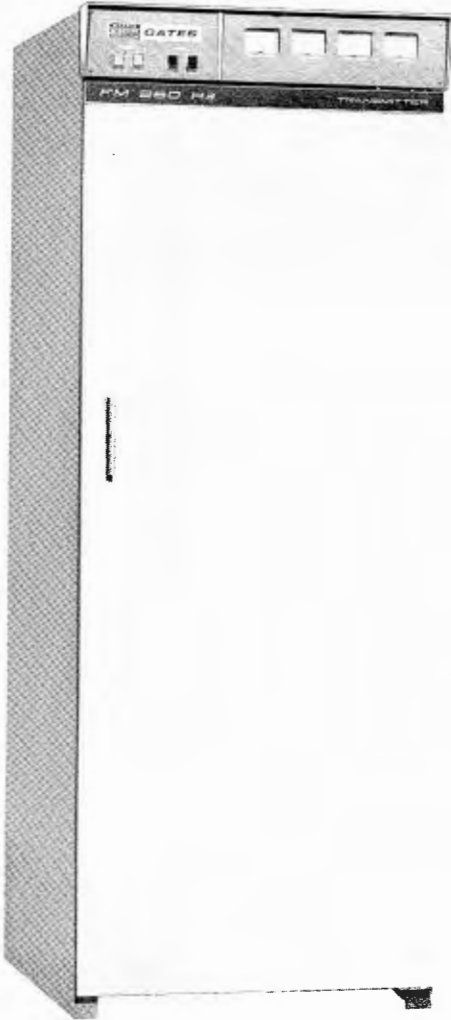

MODEL FM-250H3

Only one tube, a 4CX250B tetrode power amplifier, is used in the FM-250H3 for a full 250 watts power output. This transmitter incorporates Gates exclusive TE-3 exciter, employing Direct Carrier Frequency Modulation for unsurpassed audio fidelity in FM broadcasting. The FM-250H3 transmitter is fully FCC type accepted for stereophonic and monaural transmission in the 88 to 108 MHz FM broadcast band.

The TE-3 exciter is completely self-contained within the transmitter. Modular construction allows the addition of stereo and/or SCA at any time by simply plugging in the appropriate module. Stereo separation in the FM-250H3 is a minimum of 35 dB from 50 Hz to 15 kHz.

SOLID STATE RECTIFIERS: Transmitter reliability is greatly enhanced by the use of silicon diodes in all power supplies in the FM-250H3.

HARMONIC OUTPUT FILTER: Provided as standard equipment, the harmonic filter is contained within the FM-250H3 transmitter cabinet. Harmonics are attenuated well below FCC requirements.

AUTOMATIC RECYCLING: In case of momentary overload, the FM-250H3 will recycle automatically—a feature seldom provided in 250 watt FM transmitters.

REMOTE CONTROL: Wiring for remote control is built in, including a motor driven control to vary power output. No outboard components are needed in the transmitter, when used with a Gates remote control system.

SPECIFICATIONS

GENERAL

POWER OUTPUT: 250 watts.
FREQUENCY RANGE: 87.5 to 108 MHz, tuned to specified operating frequency.
RF OUTPUT IMPEDANCE: 50 ohms.
OUTPUT TERMINATION: Type N receptacle.
FREQUENCY STABILITY: .001% or better.
TYPE OF MODULATION: Direct Carrier Frequency Modulation.
MODULATION CAPABILITY: ± 100 kHz.
AC INPUT POWER: 115 volts, 60 Hz, 850 watts (approximate).
POWER SUPPLY RECTIFIERS: Silicon.
RF HARMONICS: Suppression meets or exceeds all FCC requirements.
ALTITUDE: 7,500 feet.

AMBIENT TEMPERATURE RANGE: -20°C to $+45^{\circ}\text{C}$.
MAXIMUM VSWR: 1.7 to 1.
OVER-ALL CABINET SIZE: 29" W x 78" H x 32 $\frac{3}{4}$ " D.
FINISH: Two-tone beige-gray.
WEIGHT AND CUBAGE: Export: 620 lbs. Domestic: 600 lbs. 6.5 cu. ft.

MONAURAL OPERATION

AUDIO INPUT IMPEDANCE: 600 ohms balanced.
AUDIO INPUT LEVEL: +10 dBm ± 2 dB for 100% modulation at 400 Hz.
AUDIO FREQUENCY RESPONSE: Standard 75 microsecond, FCC pre-emphasis curve ± 1 dB, 30-15,000 Hz.
DISTORTION: 0.5% or less 30-15,000 Hz.
FM NOISE: 65 dB below 100% modulation (ref. 400 Hz).
AM NOISE: 50 dB below reference carrier AM modulated 100%.

ORDERING INFORMATION

| | |
|--|----------|
| FM-250H3, 250 watt FM broadcast transmitter..... | 994-6739 |
| Spare tube 4CX250B..... | 374-0081 |
| Stereo generator (add for stereo operation)..... | 994-6533 |
| SCA sub-carrier generator (add for SCA operation)..... | 994-6507 |

10 and 50 Watt FM Transmitters



The BFE-10G3 and BFE-50G3 are housed in identical cabinets, as above.

MODEL BFE-10G3 MODEL BFE-50G3

MODEL BFE-10G3: The BFE-10G3 10-watt FM transmitter is FCC type approved for educational FM broadcasting, and is equally suitable for STL service, or for any applications where 10 watts FM output is required. A compact, self-contained unit designed specifically for desk or wall mounting, this 10-watt model incorporates Gates' TE-3 exciter, featuring Direct Carrier Frequency Modulation.

Immediate "full view" access is available by removing the front grill or the rear full-length slip-off door. This complete 10-watt FM transmitter is used by many schools, colleges, universities and overseas broadcasters in conjunction with the Gates' FM-11 single-ring or the FM-22 double-ring FM antenna.

MODEL BFE-50G3: For 88 to 108 MHz FM service, the BFE-50G3 is similar in design to the BFE-10G3 transmitter, but delivers five times as much power, or 50 watts. A 50-watt power amplifier is added to the 10-watt section to provide the higher powered output. The amplifier utilizes two 6146 tubes and a separate 600 volt power supply. Identical in external appearance to the standard BFE-10G3 transmitter, the BFE-50G3 also incorporates the TE-3 exciter.

SPECIFICATIONS

GENERAL

POWER OUTPUT: BFE-10G3, 10 watts; BFE-50G3, 50 watts.
FREQUENCY RANGE: 87.5 to 108 MHz, tuned to specified operating frequency.
RF OUTPUT IMPEDANCE: 50 ohms.
FREQUENCY STABILITY: .001% or better.
TYPE OF MODULATION: Direct Carrier Frequency Modulation.
MODULATION CAPABILITY: ± 100 kHz.
AC INPUT POWER: 117 volts, 50/60 Hz.
RF HARMONICS: Suppression meets all FCC requirements.
ALTITUDE: 7500 feet.
AMBIENT TEMPERATURE RANGE: -20°C to $+45^{\circ}\text{C}$.
MAXIMUM VSWR: 1.7 to 1.
OVER-ALL CABINET SIZE: 26½" H, 28" W, 14" D.
FINISH: Two-tone, beige-gray.
WEIGHT & CUBAGE: BFE-10G3: 100 lbs, 15 cu. ft. BFE-50G3: 125 lbs., 16 cu. ft.

MONAURAL MODE

AUDIO INPUT IMPEDANCE: 600 ohms balanced.
AUDIO INPUT LEVEL: $+10$ dBm ± 2 dB for 100% modulation at 400 Hz.

AUDIO FREQUENCY RESPONSE: Standard 75 microsecond FCC pre-emphasis curve ± 1 dB, 30-15,000 Hz.
DISTORTION: 0.5% or less, 30-15,000 Hz.
FM NOISE: 65 dB below 100% modulation (ref. 400 Hz).
AM NOISE: 50 dB below reference carrier AM modulated 100%.

STEREOPHONIC MODE (Stereo Generator optional)

PILOT OSCILLATOR: Crystal controlled.
PILOT STABILITY: 19 kHz ± 1 Hz.
AUDIO INPUT IMPEDANCE: (Left and right) 600 ohms balanced.
AUDIO INPUT LEVEL: (left and right) $+10$ dBm ± 1 dB for 100% modulation at 400 Hz.
AUDIO FREQUENCY RESPONSE: (left and right) standard 75 microsecond, FCC pre-emphasis curve ± 1 dB, 50-15,000 Hz.
DISTORTION: (left and right) 1% or less, 50-15,000 Hz.
FM NOISE: (left and right) 60 dB minimum below 100% modulation, reference 400 Hz.
STEREO SEPARATION: 35 dB minimum 50-15,000 Hz.
SUB-CARRIER SUPPRESSION: 42 dB below 90% modulation.
CROSSTALK: (Main to sub-channel or sub to main channel) 42 dB below 90% modulation.

NOTE: SCA specifications are the same as those of the FM-1H3, page 49.

ORDERING INFORMATION

BFE-10G3, 10-watt FM transmitter utilizing TE-3 solid-state exciter.....994-6737
 BFE-50G3, 50-watt FM transmitter utilizing TE-3 solid-state exciter994-6738
 100% set spare rectifiers, tubes and transistors for BFE-50G3.....990-0575

10 and 50 Watt FM Transmitters



MODEL BFE-10C
MODEL BFE-50C

MODEL BFE-10C MODEL BFE-50C

Gates has consistently offered the most complete line of low-powered wide-band FM broadcast transmitters in the industry. Especially designed for educational FM broadcasting and for STL (studio-transmitter link) service, two popular models featuring direct crystal controlled cascade modulation are available. Included are the 10-watt BFE-10C and 50 watt BFE-50C versions for the standard FM broadcast band of 88 to 108 MHz. The same low distortion, wide frequency response and reliability, characteristic of Gates' higher powered FM models, will be found in these lower powered units.

Metering consists of an audio level meter to indicate proper modulation level and individual meters for RF output, plate current and plate voltage. The transmitters are 100% complete without external accessories other than antenna and audio equipment.

SPECIFICATIONS

POWER OUTPUT: BFE-10C, 10 watts; BFE-50C, 50 watts.
FREQUENCY RANGE: Models BFE-10C and BFE-50C, 88-108 MHz, as ordered.
STABILITY: 0.001% or better.
MODULATION: Direct crystal controlled cascade modulation.
RESPONSE: Within 1 dB of standard 75 microsecond pre-emphasis curve or flat ± 1 dB, 50-15,000 Hz.
 Note: Will supply with 75 microsecond pre-emphasis curve unless ordered for flat curve.
FREQUENCY DEVIATION: ± 100 kHz; (± 75 kHz = 100% modulation in FM broadcasting).
DISTORTION: 1% or less 30-15,000 Hz. 0.5% 100-10,000 Hz.
RF HARMONICS: Suppression meets or exceeds all FCC requirements.
INPUT: +10 dBm ± 2 dB at 600 ohms impedance.
POWER: 117 volts, 50/60 Hz. BFE-10C, 120 watts; BFE-50C, 230 watts.

RF OUTPUT: 50 ohms (Type N connector).
OSCILLATOR: Direct crystal controlled.
NOISE: 65 dB below 100% modulation (FM).
TEMPERATURE: -20° to $+45^{\circ}$ C.
TUBES:
 BFE-10C: (6) 6AU6, (3) 6J6, (3) 6Z01, (3) 7025, (2) OA2, and (1 each) 12AX7, 6AQ5, GZ34/5AR4, 6080, 6360.
 BFE-50C: Same as above, with (2) 6146 and (1) 5R4GYA tubes added.
ALTITUDE: 7500 feet.
FINISH: Gates two-tone beige-gray with trim in brushed aluminum and black.
SIZE: 26½" high, 28" wide, 14" deep.
WEIGHT: (Packed):
 BFE-10C (domestic) 100 lbs.; (export) 205 lbs.; 15 cu. ft.
 BFE-50C (domestic) 125 lbs.; (export) 230 lbs.; 16 cu. ft.

ORDERING INFORMATION

BFE-10C, 10 watt FM transmitter, 88-108 MHz, with tubes and crystal.....994-5594
 Spare 100% tube kit for BFE-10C.....990-0391
 Manufacturer's recommended minimum tube kit for BFE-10C.....990-0488
 BFE-50C, 50 watt FM transmitter, 88-108 MHz, with tubes and crystal.....994-5595

Spare 100% tube kit for BFE-50C.....990-0489
 Manufacturer's recommended minimum tube kit for BFE-50C.....990-0490
 FM-11A Single Ring Educational (88-108 MHz) FM Antenna.....710-0102
 FM-22A Double Ring Educational (88-108 MHz) FM Antenna.....710-0103

State carrier frequency when ordering all models and antennas.

FM Antennas, Broadcast Link And Relay System

EDUCATIONAL FM ANTENNAS

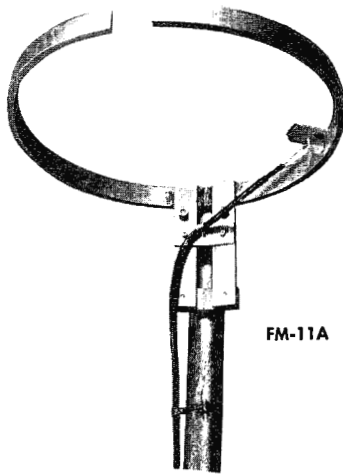

FM-11A

Gates' FM-11A is a lightweight, horizontally polarized ring type radiator having a horizontal radiation pattern that is essentially omni-directional. Power gain is 0.8. Power handling capability up to 500 watts. Weight of antenna element is approximately 9 lbs.

ORDERING INFORMATION

FM-11A single ring FM antenna.....710-0102

Gates' FM-22A is a 2-ring antenna designed to fulfill the requirements of low powered FM stations. It has a horizontal radiation pattern that is essentially omni-directional. Power gain is 1.8. Power handling capability up to 800 watts. Weight of the two elements is approximately 20 lbs.

ORDERING INFORMATION

FM-22A 2-ring
FM Antenna.....710-0103



FM-22A

FM BROADCAST LINK AND RELAY SYSTEM

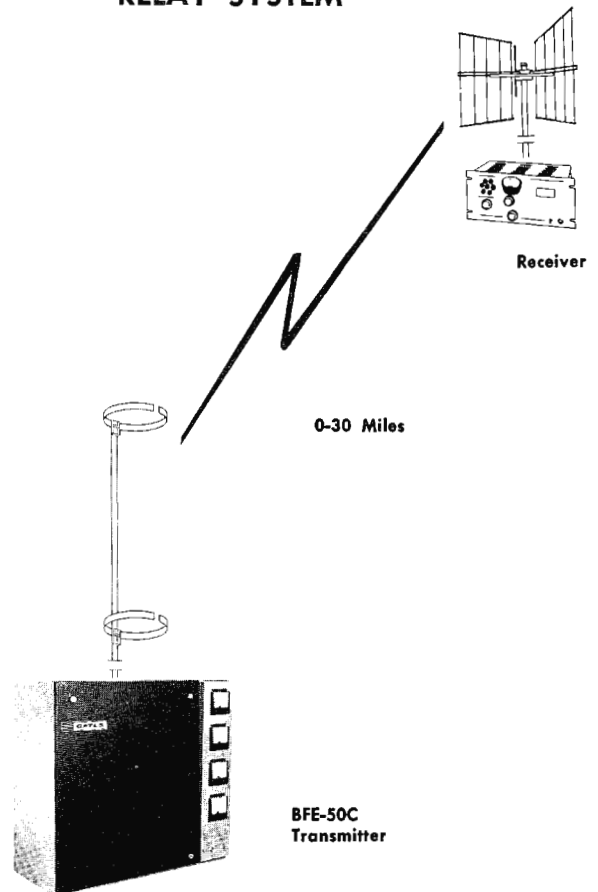

0-30 Miles

BFE-50C
Transmitter

NON-DIRECTIONAL: This system is a non-directional 88-108 MHz FM system using a non-directional antenna for transmitting and a high gain directional antenna for receiving. This system provides a high fidelity studio-to-transmitter link, and, where regulations permit, allows simultaneous FM broadcasting of the AM program. The system features the Gates BFE-50C 50 watt transmitter, which has built-in RF output indicator and audio level meters. Line-of-sight reception with 50 watt transmitter is estimated at 30 miles.

ORDERING INFORMATION

1—50 watt FM transmitter.....BFE-50C
1—Receiver, 88-125 MHz.....731-0003
Alternate Transmitter for shorter distances: 10 watt FM transmitter, 88-108 MHz.....BFE-10C
1—Two ring FM transmitting antenna, gain 1.6.....FM-22
1—FM receiving antenna.....LPL-FM-6
100'—Coaxial Cable, for transmitter.....RG-8/U
100'—Twin line 300 ohm, for receiver.....8235
Complete 50 watt system as described above.....FML-50ND
Complete 10 watt system using alternate transmitter described above.....FML-10ND

HARRIS
GATES DIVISION
Harris-Intertype Corporation

Circularly Polarized FM Antenna

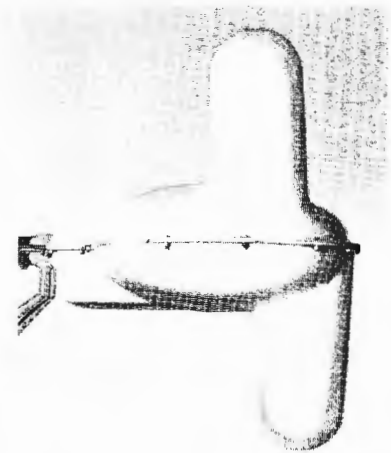
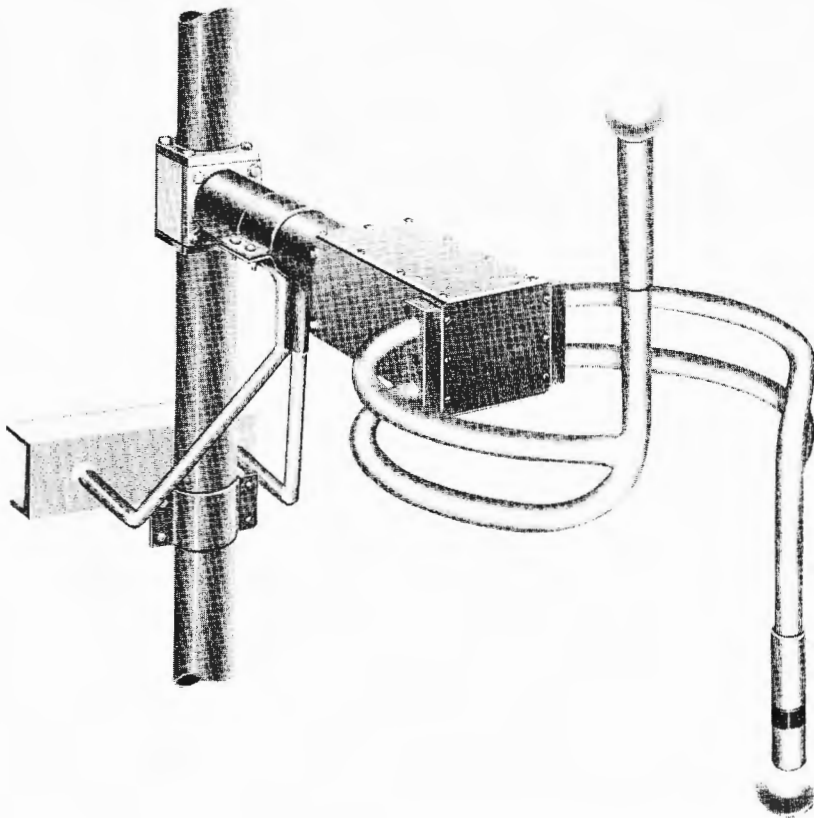

Radomes are available with the Dual Cycloid antennas.

The Gates Dual-Cycloid Type FMS antenna transmits circular polarization as authorized by FCC rules and regulations. The station's effective radiated power will still be determined by the signal radiated in the horizontal plane. This is determined by the antenna gain (see table) in the horizontal plane multiplied by the power input to the antenna.

Any number of elements from one to sixteen may be utilized, providing maximum flexibility in the selection of power gain for a particular installation. Special antennas with null fill and beam tilt are available. Radomes or deicers are available for climates that experience icing conditions.

The Dual-Cycloid consists of two basic parts: (1) the radiating element and, (2) interconnecting transmission line sections. The radiating elements in an array are all identical electrically and mechanically. Utilizing the effective ring design of the Cycloid as the basic unit, two vertical elements have replaced the fixed end plates; the rear terminal block is now a matching balun mating the antenna impedance to the interconnecting transmission line.

The vertical sections have adjustable caps for a fine adjustment of the horizontal/vertical radiation ratio. Corona sup-

pression balls are included as a standard item. Designed for rugged trouble-free operation, all antenna elements are fabricated of a durable weather resistant brass alloy with excellent electrical properties.

Antenna elements are normally spaced one wavelength apart with interconnecting transmission line sections and feed through a common system input termination of 50 ohms, which is a standard 3/8" EIA female flange.

CIRCULARITY: Both the horizontal and vertical radiation pattern of the Dual-Cycloid antenna have been measured within ± 2 dB in free space. When side mounted, the antenna pattern will be somewhat affected by the supporting structure.

Supplied on a standard 3/8" EIA line, the antenna is complete with mounting brackets for standard AM and FM towers.

FEED POINT: Antennas of 8 bays or less are end fed through a 6 ft. transmission line section; 9 or more bays are usually center fed through a 6 ft. transmission line section, 90° elbow and coaxial "T" connector. Antennas with null fill and/or beam tilt must be center fed.

Circularly Polarized FM Antenna—Dual-Cycloid

MOUNTING: The antenna is mounted on a specially designed supporting bracket, fabricated to mate with the tower in a mounting arrangement specified by the purchaser. Antennas are usually mounted on the leg or tower face of a guyed or self-supporting tower. A special quotation will be made for brackets on TV towers and nonstandard radiators and poles.

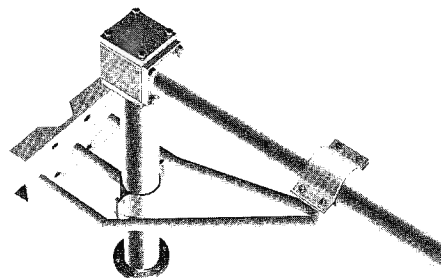

FMS — SPECIFICATIONS

| GATES TYPE | POWER GAIN | | dB GAIN | | FIELD GAIN ¹ | | POWER RATING | APPROX. ² LENGTH | APPROX. WEIGHT ³ (lbs.) | WIND- LOAD ⁴ |
|---------------|------------|----------|------------|----------|-------------------------|----------|-----------------|--------------------------------|--|----------------------------|
| | Horizontal | Vertical | Horizontal | Vertical | Horizontal | Vertical | | | | |
| FMS-1 | 0.46 | 0.46 | -3.37 | -3.37 | 0.678 | 0.678 | 10 kW | 0 | 76 | 124 |
| FMS-2 | 1.0 | 1.0 | 0 | 0 | 1.0 | 1.0 | 20 kW | 10 ft. | 168 | 276 |
| FMS-3 | 1.5 | 1.5 | 1.76 | 1.76 | 1.23 | 1.23 | 30 kW | 20 ft. | 250 | 428 |
| FMS-4 | 2.1 | 2.1 | 3.22 | 3.22 | 1.45 | 1.45 | 40 kW | 30 ft. | 332 | 580 |
| FMS-5 | 2.7 | 2.7 | 4.31 | 4.31 | 1.64 | 1.64 | 40 kW | 40 ft. | 414 | 732 |
| FMS-6 | 3.2 | 3.2 | 5.05 | 5.05 | 1.79 | 1.79 | 40 kW | 50 ft. | 496 | 883 |
| FMS-7 | 3.8 | 3.8 | 5.80 | 5.80 | 1.95 | 1.95 | 40 kW | 60 ft. | 578 | 1035 |
| FMS-8 | 4.3 | 4.3 | 6.34 | 6.34 | 2.07 | 2.07 | 40 kW | 70 ft. | 660 | 1187 |
| FMS-9 | 4.9 | 4.9 | 6.87 | 6.87 | 2.21 | 2.21 | 40 kW | 80 ft. | 763 | 1386 |
| FMS-10 | 5.5 | 5.5 | 7.40 | 7.40 | 2.35 | 2.35 | 40 kW | 90 ft. | 845 | 1538 |
| FMS-12 | 6.6 | 6.6 | 8.20 | 8.20 | 2.57 | 2.57 | 40 kW | 110 ft. | 1009 | 1841 |
| FMS-14 | 7.8 | 7.8 | 8.92 | 8.92 | 2.79 | 2.79 | 40 kW | 130 ft. | 1173 | 2145 |
| FMS-16 | 8.9 | 8.9 | 9.49 | 9.49 | 2.98 | 2.98 | 40 kW | 150 ft. | 1337 | 2449 |

FREQUENCY RANGE: Factory tuned to one frequency in the 88 to 108 MHz band.

POLARIZATION: Circular, clockwise.

POWER GAIN (Over Dipole): Approximately equal to half the number of stacked bays for horizontal polarization; same for vertical polarization. See table above.

AZIMUTHAL PATTERN: Circular ± 2.0 dB in free space for horizontal polarization; same for vertical polarization. See table above.

VSWR AT INPUT (Without field trimming): Top mounting, 1.1:1 or better. Side mounting, 1.5:1 or better.

VSWR AT INPUT (With field trimming): Top or side mounting, 1.1:1 or better over ± 100 kHz.

INPUT IMPEDANCE: 50 ohms.

INPUT CONNECTION: 3/8-inch, 50 ohm EIA female flange.

POWER INPUT RATING: Approximately 10 kW per bay (see table).

WINDLOAD: 50 lbs. per square foot for flat surfaces; 33 lbs. per square foot for cylindrical surfaces.

DIMENSIONS: (One bay) 30 in. high, 35 1/2 in. long. (FMC-Antenna 45 1/2 in. long.)

FEED POINT: One to Eight bays, end fed. Nine bays and over, center fed with even number of bays, or at a point 1/2 bay below center with odd number of bays.

Equipment furnished: Antenna elements as required; antenna mounting hardware (specify tower manufacturer and type); interconnecting rigid coax transmission line section (6 ft.); standard 3/8-inch EIA female flange.

Accessory equipment: RF shielded deicer system, 300 watts per bay, 115 volts, 50/60 Hz . . . complete with conduit boxes and RF shielded interbay wiring harness. Thermo-switch for control of deicers. AC heater cable.

1. To obtain the effective free space field intensity at one mile in mv/m for one kilowatt antenna input power, multiply field gain by 138. 2. When determining coax line lengths on end feed antenna, add 6' to allow for matching stub. When determining coax line lengths on center feed antenna, termination will be 6' below center due to matching stub. 3. Weights given include brackets, interbay line and transformer section. Add 20 pounds for each Radome added to antenna. 4. Based on 50 psf wind pressure on flat surfaces, 33 psf on cylindrical surfaces (112 mph actual wind velocity).

Directional Dual Cycloid FM Antenna

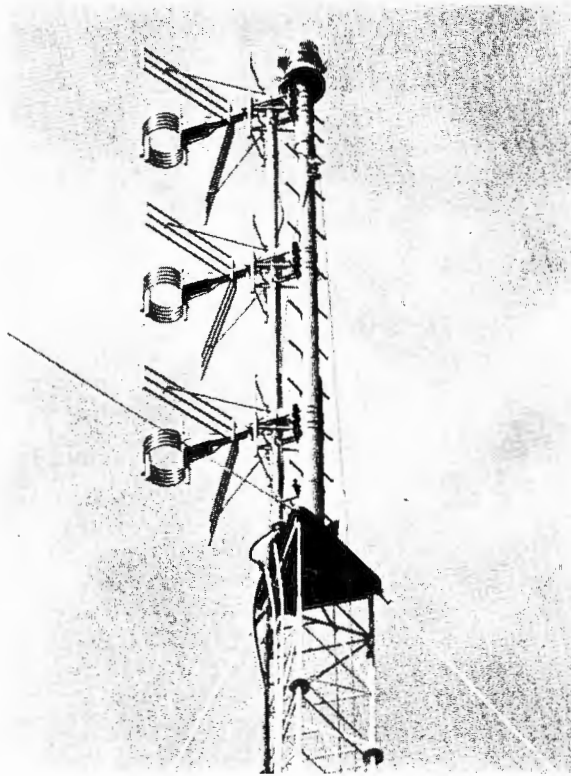

At station WKZN-FM, Kenosha, Wis., Gates' Directional Dual Cycloid FM antenna is pole mounted. Each bay of the directional antenna is equipped with heaters totaling 900 watts.

Gates' FMC-(X)DA is a directional dual polarized FM antenna designed for pole mounting. The antenna is available with up to eight bays (the X in the type number indicates the number of bays—the 4-bay antenna is FMC-4DA, etc.). The interbay transmission feed line uses 3/8-inch rigid coaxial line. Spacing between bays is one wavelength.

Typical horizontally measured relative field patterns for both polarizations are shown in the figures on the next page. Minor variations may be obtained, such as varying the null at 180°, decreasing or increasing the lobes at 90° and 270° by a small amount, or increasing or decreasing the lobe at 0° by a small amount. Any such changes would alter the power gain figures shown in the chart on the next page by a small amount. Extensive change of pattern is only available on a custom basis, and at added cost, since a special study would be required, including extensive pattern testing on the antenna range.

Each antenna bay uses a circularly polarized type driven element, plus one horizontal reflective screen and two parasitic vertical reflectors used for beam shaping to achieve the directional radiation pattern for both polarizations. The directional antenna patterns are developed by mechanical means, no special phasing lines being used. Thus, keeping the driven elements and beam shaping elements in good mechanical condition should be all that is required to maintain the pattern in adjustment.

Orders for the Gates Directional Dual Cycloid should stipulate the desired true azimuth orientation, radiated power limitations, transmitter power output capability, transmission line efficiency (or type and length of such line) and complete dimensions on the size of the pole to be used for the antenna mount. Antenna pattern requirements are normally stipulated by the station's consultant.

Each directional antenna is carefully patterned on an antenna range, not at the customer's site. A single bay of the antenna is mounted on a pole essentially identical in cross section to that on which the antenna is to be finally installed. Thus, it is necessary that the factory be supplied with complete data on pole diameters, step bolt size and location, and the location of any conduits and/or coaxial lines so that they may be duplicated during final testing.

The Directional Dual Cycloid can be equipped with factory installed heaters, and heaters are recommended for installations where icing may occur. A total of 900 watts of heat is used per antenna bay, which should assure proper deicing and maintenance of the antenna pattern during such weather conditions. Six 150-watt, 120-volt elements are used in each heater-equipped bay, and these individual elements may be replaced in the field. If a 240-volt supply for the heaters is desired, the order should so state so that heaters may be properly connected.

Directional Dual Cycloid FM Antenna

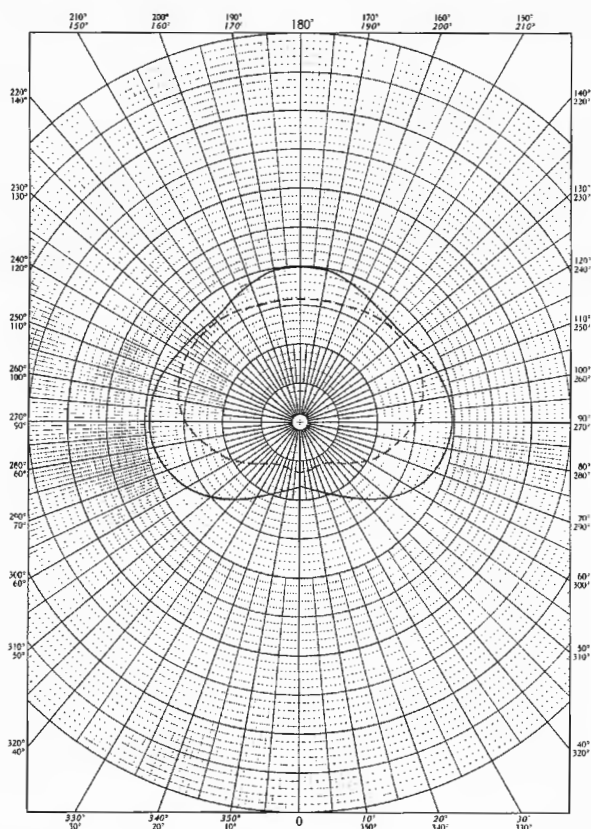

PATTERN "A"

Horizontal Relative Field Patterns

Solid line—horizontal polarization Dashed line—vertical polarization
 HRMS 0.830 HRMS 0.659

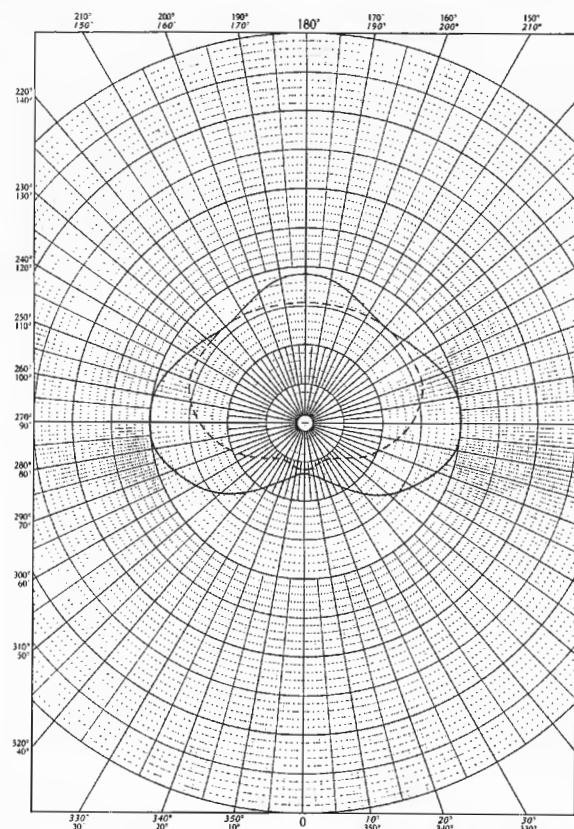

PATTERN "B"

Horizontal Relative Field Patterns

Solid line—horizontal polarization Dashed line—vertical polarization
 VRMS 0.798 VRMS 0.619

| GATES TYPE | PATTERN "A" | | PATTERN "B" | | APPROX. WEIGHT* | CALCULATED WIND LOAD—50/33 PSF# |
|---------------|------------------|-----------------|------------------|-----------------|--------------------|------------------------------------|
| | Horiz. Pwr. Gain | Vert. Pwr. Gain | Horiz. Pwr. Gain | Vert. Pwr. Gain | | |
| FMC-1DA | 0.795 | 0.575 | 0.878 | 0.564 | 137 lbs. | 354 |
| FMC-2DA | 1.71 | 1.23 | 1.89 | 1.21 | 284 lbs. | 738 |
| FMC-3DA | 2.66 | 1.92 | 2.94 | 1.89 | 432 lbs. | 1122 |
| FMC-4DA | 3.63 | 2.62 | 4.02 | 2.59 | 579 lbs. | 1506 |
| FMC-5DA | 4.61 | 3.33 | 5.11 | 3.28 | 727 lbs. | 1809 |
| FMC-6DA | 5.61 | 4.05 | 6.20 | 3.99 | 874 lbs. | 2274 |
| FMC-7DA | 6.60 | 4.77 | 7.30 | 4.69 | 1022 lbs. | 2658 |
| FMC-8DA | 7.60 | 5.49 | 8.42 | 5.41 | 1169 lbs. | 3042 |

The above power gain figures will vary with the pattern shape. The power gain figures are given merely as a guide for roughly determining the number of bays required. Some variance may be expected in designing a given directional pattern, so that the exact gain figures are not known until the directional antenna pattern is finally achieved. Using pole mounting, the patterns should be quite similar to those patterns shown, but minor pattern changes may be achieved to fit given requirements.

* Weight includes interbay line, transformer section, brackets, heaters, heater junction boxes and heater wiring.

50 PSF wind pressure on flat surfaces, 33 PSF on cylindrical surfaces (110 MPH actual wind velocity). Wind load calculations include interbay line, transformer section, brackets, heater junction boxes and external heater wiring.

Circularly Polarized FM Antenna

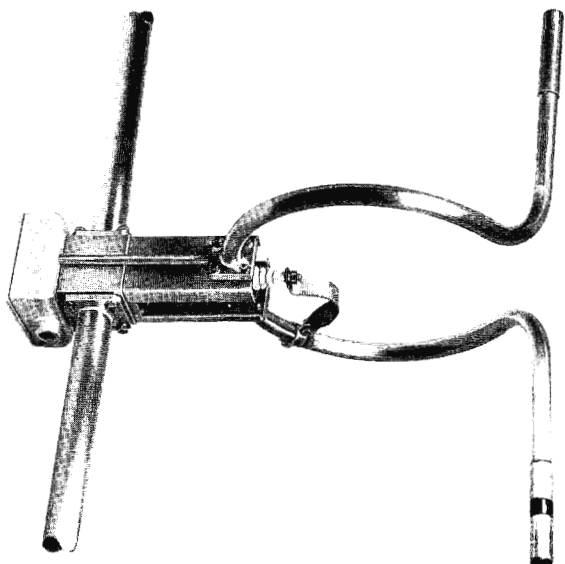

DUAL-CYCLOID II FOR MEDIUM POWER STATIONS

Gates' Dual-Cycloid II circularly polarized FM antenna provides all of the electrical advantages of the Dual-Cycloid, in a lighter weight, low silhouette design for minimum windloading. The antenna features center feed for medium power handling capabilities—from four to twelve bays handle transmitter powers through 10 kilowatts. Antenna elements are normally spaced one wavelength apart with interconnecting transmission line sections and feed through a common antenna system input termination of 50 ohms, with a standard 3/8-inch EIA female flange.

The vertical sections have factory adjustable caps for the fine adjustment of the horizontal/vertical radiation ratio. All antenna elements are fabricated of a durable, weather-resistant brass alloy. Null fill and beam tilt available. Standard brackets for mounting the antenna on the tower leg are included with the antenna. Optional deicers consist of two 150-watt heating elements per bay, replaceable in the field. Interbay wiring is not included. Order Type FMC-(X)B. (X indicates the number of bays required.)

SPECIFICATIONS

FREQUENCY RANGE: Factory tuned to one specific frequency in the 88 to 108 MHz band.

POLARIZATION: Circular, clockwise.

FREE SPACE PATTERN: Horizontal component circular ± 2 dB.
Vertical component circular ± 2 dB.

VERTICAL TO HORIZONTAL POWER RATIO: Fixed at 50/50.

VSWR: 1.2 to 1 or better ± 200 kHz as tuned at the factory.
VSWR when tower mounted 1.5 to 1 or better ± 200 kHz. Capable of

adjustment 1.1 to 1 ± 100 kHz with field tuning.

POWER GAIN: Horizontal polarization: see table. Vertical polarization: see table. Referred to a half wave dipole in free space and 95% efficiency.

POWER INPUT RATING: Maximum of 10 kW.

INPUT CONNECTION: 3/8" EIA female flange, 50 ohm.

WINDLOAD: Designed for 50 psf for flat surfaces, 33 psf for cylindrical surfaces.

| GATES TYPE | POWER GAIN | | dB GAIN | | FIELD GAIN ¹ | | POWER RATING | APPROX. ² LENGTH | WEIGHT ³ (Lbs.) | WIND- ⁴ LOAD |
|------------|------------|----------|------------|----------|-------------------------|----------|--------------|-----------------------------|----------------------------|-------------------------|
| | Horizontal | Vertical | Horizontal | Vertical | Horizontal | Vertical | | | | |
| FMC-4B | 2.025 | 2.025 | 3.064 | 3.064 | 1.423 | 1.423 | 10 kW | 30 | 147 | 340 |
| FMC-5B | 2.577 | 2.577 | 4.111 | 4.111 | 1.605 | 1.605 | 10 kW | 40 | 175 | 412 |
| FMC-6B | 3.134 | 3.134 | 4.961 | 4.961 | 1.770 | 1.770 | 10 kW | 50 | 204 | 485 |
| FMC-7B | 3.695 | 3.695 | 5.676 | 5.676 | 1.922 | 1.922 | 10 kW | 60 | 232 | 557 |
| FMC-8B | 4.258 | 4.258 | 6.292 | 6.292 | 2.063 | 2.063 | 10 kW | 70 | 261 | 629 |
| FMC-9B | 4.823 | 4.823 | 6.833 | 6.833 | 2.196 | 2.196 | 10 kW | 80 | 289 | 701 |
| FMC-10B | 5.390 | 5.390 | 7.316 | 7.316 | 2.322 | 2.322 | 10 kW | 90 | 318 | 773 |
| FMC-11B | 5.958 | 5.958 | 7.751 | 7.751 | 2.441 | 2.441 | 10 kW | 100 | 346 | 845 |
| FMC-12B | 6.527 | 6.527 | 8.147 | 8.147 | 2.555 | 2.555 | 10 kW | 110 | 375 | 917 |

- To obtain the effective free space field intensity at one mile MV/M for one kilowatt antenna power, multiply field gain by 137.6.
- The feed point of center fed antennas is 10 ft. below the center of the antenna. Center fed antennas have a 3/8" line input.
- The weights given are less brackets, but the interbay transmission line, transformer section, the center fed tee section and elbow, are all included in the weight.
- Windload based on 50 psf on flat surfaces and 33 psf for cylindrical surfaces (actual wind velocity 110 mph). Computed for 100 MHz antenna less mounting brackets and less heater junction boxes and heater cables.

Circularly Polarized FM Antenna

DUAL-CYCLOID III

FOR STATIONS UP TO 5 KILOWATTS

Designed for lower power stations, Gates' Dual-Cycloid III circularly polarized FM antenna is an end-fed version of the Dual-Cycloid II—it is lighter in weight, and has less windloading. From one to eight bays handle transmitter powers through 5 kilowatts.

The antenna consists of a 1½-inch transmission line with individual bays separated by approximately one wavelength at the operating frequency. All antenna elements are fabricated of a durable, weather-resistant brass alloy. Null fill and beam tilt are not available on the Dual-Cycloid III.

Deicers consist of two 150-watt heating elements per bay—interbay wiring is not included. These elements are factory installed, and are replaceable in the field. Standard brackets for mounting the antenna on the tower leg are included with the antenna. Order Type FMC-(X)A. (X indicates the number of bays required.)

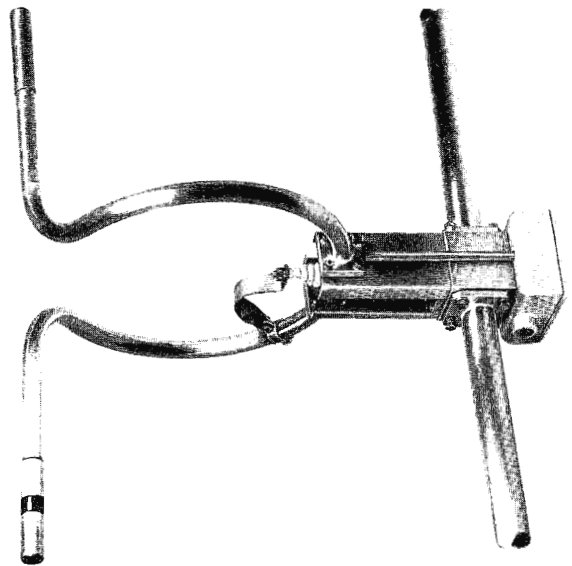

SPECIFICATIONS

FREQUENCY RANGE: Factory tuned to one specific frequency in the 88-108 MHz band.

POLARIZATION: Circular, clockwise.

FREE SPACE PATTERN: Horizontal component circular ± 2 dB. Vertical component circular ± 2 dB.

VERTICAL TO HORIZONTAL RATIO: Fixed at 50/50.

VSWR: 1.2 to 1 or better ± 200 kHz as tuned at the factory. VSWR when tower mounted 1.5 to 1 or better ± 200 kHz. Capable of adjustment to 1.1 to 1 ± 100 kHz with field tuning.

POWER GAIN: Horizontal polarization: see table. Vertical polarization: see table. Referred to a half wave dipole in free space and 95% efficiency.

POWER INPUT RATING: Maximum of 5 kW for two to eight bays. 3 kW for single bay.

INPUT CONNECTION: A six foot transformer section is provided on the bottom of each antenna system which has a 1½" 50 ohm EIA female connector.

WINDLOAD: Designed for 50 psf for flat surfaces, 33 psf for cylindrical surfaces.

WEIGHT: Single bay 24 lbs., less brackets. 1½" interbay coaxial line weights approximately 10 lbs. per section.

DIMENSIONS: Single bay height approximately 42". Length approximately 16".

| GATES TYPE | POWER GAIN | | dB GAIN | | FIELD GAIN ¹ | | POWER RATING | APPROX. ² LENGTH | WEIGHT ³ (Lbs.) | WIND- ⁴ LOAD |
|------------|------------|----------|------------|----------|-------------------------|----------|--------------|-----------------------------|----------------------------|-------------------------|
| | Horizontal | Vertical | Horizontal | Vertical | Horizontal | Vertical | | | | |
| FMC-1A | 0.438 | 0.438 | -3.585 | -3.585 | 0.662 | 0.662 | 3 kW | | 24 | 54 |
| FMC-2A | 0.947 | 0.947 | -0.237 | -0.237 | 0.973 | 0.973 | 5 kW | 10 | 53 | 126 |
| FMC-3A | 1.480 | 1.480 | 1.702 | 1.702 | 1.216 | 1.216 | 5 kW | 20 | 81 | 198 |
| FMC-4A | 2.025 | 2.025 | 3.064 | 3.064 | 1.423 | 1.423 | 5 kW | 30 | 110 | 271 |
| FMC-5A | 2.577 | 2.577 | 4.111 | 4.111 | 1.605 | 1.605 | 5 kW | 40 | 138 | 343 |
| FMC-6A | 3.134 | 3.134 | 4.961 | 4.961 | 1.770 | 1.770 | 5 kW | 50 | 167 | 414 |
| FMC-7A | 3.695 | 3.695 | 5.676 | 5.676 | 1.922 | 1.922 | 5 kW | 60 | 196 | 486 |
| FMC-8A | 4.258 | 4.258 | 6.292 | 6.292 | 2.063 | 2.063 | 5 kW | 70 | 225 | 558 |

1. To obtain the effective free space field intensity at one mile in MV/M for one kilowatt antenna power, multiply field gain by 137.6.

2. When determining coax length, add six feet to antenna length.

3. The weights given are less brackets, but the interbay transmission line and transformer section are all included in the weight.

4. Windload based on 50 psf on flat surfaces and 33 psf for cylindrical surfaces (actual wind velocity 110 mph). Computed for a 100 MHz antenna less mounting brackets and less heater junction boxes and heater cables.

Horizontally and Vertically Polarized FM Antennas



CYCLOID

Gates' Cycloid horizontally polarized FM antenna fills the need for a modern, easy to install and highly efficient antenna, with minimum standing wave ratio for FM stereo and monaural service. The field-proven Cycloid offers high gain and high power handling capabilities incorporated in an electrical design available exclusively from Gates.

The antenna is factory pretuned to the customer's frequency, assuring optimum on-the-air performance. Mounting brackets are supplied as a standard item. The Cycloid antenna is available with any number of bays from one to sixteen and with 1½-inch or 3½-inch line. See the price list for complete listing.

SPECIFICATIONS

FREQUENCY RANGE: Factory tuned to specified frequency in 88-108 MHz band.

POLARIZATION: Horizontal.

HORIZONTAL PATTERN: Circular, ± 1.0 dB in free space.

INPUT IMPEDANCE: 50 ohms, on 1½" or 3½" coax.

FEED POINT: 1 to 8 bays inclusive—end feed. 9 to 16 bays inclusive—center feed.

POWER RATING: 3 kW per section on 1½" line.

VSWR: (With field tuning) Top mounting, 1.1 to 1. Side mounting, 1.1 to 1. (Factory tuned) Top mounting 1.2 to 1. Side mounting, 1.5 to 1.

WINDLOAD: 20 lbs. per square foot.

DIMENSIONS: (One bay): Height (over-all), 6 inches. Ring diameter, approx. 18 inches (depends on frequency).

WEIGHT: Antenna, 25 lbs. per ring. 1½" line, 12½ lbs. per 10 ft. section. 3½" line, 27½ lbs. per 10 ft. section.

EQUIPMENT FURNISHED: Antenna mounting hardware (specify tower make, height and type number when ordering). Correct number of antenna elements as ordered. Interconnecting rigid coax (1½" or 3½") as ordered. Standard EIA (1½" or 3½") flanges as ordered.

ACCESSORY EQUIPMENT (Optional): Deicers: 300 watts (FMH-300). 600 watts (FMH-600). Antenna Heater Control.



TYPE 300G

The 300G vertically polarized FM antenna enables an FM station to transmit a supplemental vertically polarized signal to achieve elliptical or circular polarization as authorized in the FCC Rules and Regulations. It may be used in combination with any type of horizontally polarized FM antenna.

Both the 1½-inch and 3½-inch vertical antennas carry type number 300G. As these antennas are usually ordered as a system of several bays with connecting lines and breakers, the Gates price list is employed for more complete listings. Power division networks, both variable and fixed, are available to combine vertical and horizontal antennas, and are listed in the price list.

SPECIFICATIONS

FREQUENCY RANGE: Factory tuned to specified frequency in 88-108 MHz band.

POLARIZATION: Vertical.

POWER GAIN: Approximately equal to number of dipoles.

HORIZONTAL LINEARITY: Dipole circular ± 1 dB in free space.

INPUT IMPEDANCE: 50 ohms on 1½" or 3½" coax.

FEED POINT: For 9 bays or less, the antenna is end fed. For 10 bays or more, the antenna is center fed where number of bays is even, and for odd number of bays feed point is ½ bay length below center.

POWER RATING: 3 kW per dipole.

VSWR: Tuned to 1.1:1 or less; less than 1.5:1 when mounted on side of tower.

WINDLOAD: 60 psf. on flat surfaces, 40 psf. on cylindrical surfaces (123 mph actual wind velocity).

DIMENSIONS: Length of dipole—3.75 ft. From center of transmission line to center of dipole—2.83 ft.

WEIGHT: 1½" dipole—26.5 lbs. 3½" dipole—34.0 lbs. Typical mounting bracket—22.0 lbs. per bay.

DEICERS: Not required.

FM Isolation Transformers, Antenna Accessories

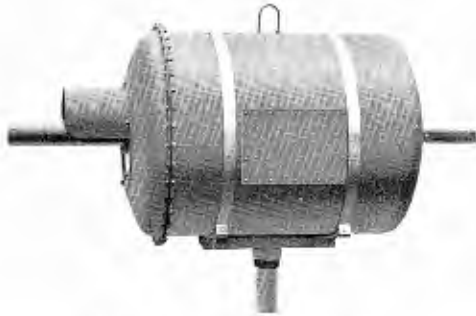

25 kW ISOLATION TRANSFORMER.

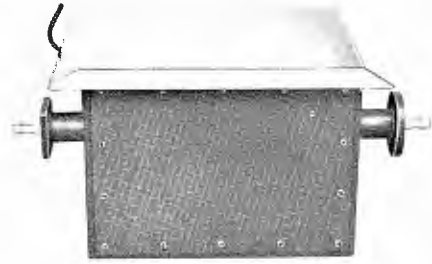

7.5 kW ISOLATION TRANSFORMER.

The FM isolation transformer is designed to couple FM transmitter power across the base of an insulated tower used jointly as an AM and FM radiator, without objectionable mismatch being introduced into the FM transmission line. Single AM antennas and antennas which are part of an AM directional antenna system are not affected when the isolation transformer is used.

SPECIFICATIONS

(7.5, 10 and 25 kW Units)

FREQUENCY: 88 to 108 MHz (adjusted to the customer's operating frequency at the factory).

VSWR: Less than 1.05 to 1 on specified frequency, ± 0.5 MHz when terminated in a matched 50 ohm load.

INSERTION LOSS: 0.10 dB or less.

INPUT AND OUTPUT: (7.5 kW unit) EIA 1 $\frac{1}{2}$ " flange, male* or female. (10 kW unit) EIA 3 $\frac{1}{8}$ -inch flange, female. (25 kW unit) 3 $\frac{1}{8}$ -inch 50 ohm EIA male flange will mate with the 3 $\frac{1}{8}$ -inch female flange such as the Andrew type 78-AR-F used on 3 $\frac{1}{8}$ -inch Heliax cable, or the flange on Andrew type 562A 50 ohm 3 $\frac{1}{8}$ -inch rigid coaxial transmission line.

*Box has EIA male connector. The male-to-male adapter may be removed

if box connects to female fitting. Subtract 6" from flange to flange length for each adapter if removed.

WEIGHT: (7.5 and 10 kW units) 48 lbs. (25 kW unit) 255 lbs.

LENGTH: (7.5 and 10 kW units) 20" flange to flange. (25 kW unit) 44" flange to flange.

MOUNTING: (7.5 and 10 kW units) 2" pipe flange on bottom of box. (25 kW unit) Separate 3" pipe flange on bottom. Two stainless steel straps secure tank to cradle.

PRESSURIZATION: Designed for use in a pressure system with gas passing through the unit.

ORDERING INFORMATION

7.5 kW Isolation Transformer, adjusted to the customer's operating frequency at the factory. Standard EIA 1 $\frac{1}{2}$ " flanges. For use with a maximum transmitter power of 7.5 kW-----620-0397

10 kW Isolation Transformer, adjusted to the customer's operating frequency at the factory. Standard 3 $\frac{1}{8}$ " flanges. For use with a maximum transmitter power of 10 kW-----620-0415

25 kW Isolation Transformer, adjusted to the customer's operating frequency at the factory. Standard EIA 3 $\frac{1}{8}$ " flanges. For use with a maximum transmitter power of 25 kW-----620-0444

FM ANTENNA ACCESSORIES

SPECIFICATIONS

POWER INPUT: 115 VAC, 60 Hz.

INPUTS: Temperature sensors; precipitation sensor; heater failure sensor.

INDICATORS: Rain, freeze, low temperature, heaters, heater fail. Selectable aural alarm for any or all of those listed.

MOUNTING: Standard 3 $\frac{1}{2}$ " x 19" rack panel. 8 inches deep.

OPTIONS: 12 VDC function outputs for telemetering status data. Model 2570-CA calibration box. Power contactors and enclosures.

ORDER NUMBER: (Antenna heater control system)-----710-0139



AUTOMATIC ANTENNA HEATER CONTROL SYSTEM: (shown above). Fully automated control of FM, TV and other types of electrically operated broadcast and communications antenna heater systems. Suitable alarms indicate visually and aurally existing weather conditions and register partial and total heater failure.

REPLACEMENT ANTENNA HEATER ELEMENTS



Dual-Cycloid Antennas (2 elements per bay)-----710-0136
 Dual-Cycloid II (2 elements per bay)-----710-0137
 Cycloid Antenna (2 elements per bay)-----710-0138

FM Stereo Modulation Monitor

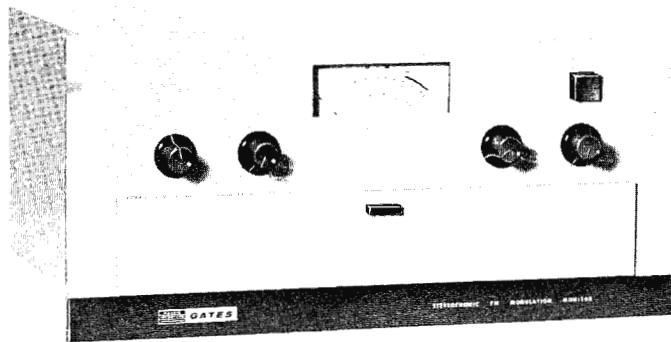

MODEL GTM-88S

The GTM-88S measures all modulation characteristics of an FM stereo or monaural signal in accordance with FCC requirements. All normal operating controls are accessible from the front panel. Instrument outputs for the right and left channels on the rear of the monitor can be connected to such auxiliary test equipment as oscilloscopes, distortion analyzers and frequency monitors, which may remain connected without affecting monitor performance or accuracy. Left channel instrument output is switchable to either channel by front panel control.

Printed circuit construction is used throughout, and, combined with the total solid state design, improves over-all dependability, and assures stable operation even under adverse operating conditions. Space age integrated circuits combine all circuit components into a single silicon semi-conductor device, thus eliminating many physical components as well as their associated interconnections, for the ultimate in performance and reliability. Provision has been made for the addition of an SCA adapter to measure SCA modulation in accordance with FCC rules and regulations.

SPECIFICATIONS

ELECTRICAL

OPERATING FREQUENCY: 87.5 to 108 MHz.
RF INPUT IMPEDANCE: 50 ohms, unbalanced.
RF INPUT SENSITIVITY: 0.1 to 1 watt.
COMP. INPUT SENSITIVITY: 0.7 V peak-to-peak for 100% modulation.
COMP. INPUT IMPEDANCE: 4000 ohms.
COMP. OUTPUT: 3 V peak-to-peak at 100% modulation.
COMP. OUTPUT IMPEDANCE: 600 ohms.
COMP. OUTPUT FREQ. RES.: ± 0.5 dB, 30 Hz to 100 kHz.
19 kHz OUTPUT: 0.75 V peak-to-peak into 20 K ohms load.
HEADPHONE OUTPUT: Levels for loads from 4 ohms to several megohms with distortion 1% or less. Separate level control.
POWER REQUIREMENTS: 100-130 VAC, 50/60 Hz, 40 watts.

INSTRUMENT OUTPUT (left or right)

IMPEDANCE: 20,000 ohms.
FREQUENCY RESPONSE: ± 0.5 dB, 50 Hz, to 15 kHz.
DISTORTION (Stereo): 0.5% or better from 50 Hz to 15 kHz at 100% modulation.
INTERNAL NOISE: -70 dB or better in mono or stereo below 100% modulation at 400 Hz.
CHANNEL SEPARATION: 35 dB or better 50 Hz to 15 kHz.

CROSSTALK CAPABILITY

MAIN TO SUB: 50 dB or better.
SUB TO MAIN: 55 dB or better.
SCA TO MAIN OR SUB: 70 dB or better.
SUBCARRIER SUPPRESSION: 50 dB or better with modulation from 5 to 15 kHz.

MODULATION METER

ACCURACY: $\pm 5\%$ or better.
BALLISTICS: Conform to FCC rules 73.322 (b).
PEAK MODULATION INDICATOR: Adjustable to indicate from 50% to 120% modulation.
AM NOISE MEASUREMENT: AM noise up to -70 dB from 30 Hz to 75 kHz.
FCC TYPE APPROVAL: No. 3-144.

MECHANICAL

RF INPUT CONNECTOR: UHF plug.
DIMENSIONS: 19" wide, 8 $\frac{3}{4}$ " high, 14 $\frac{1}{4}$ " deep.
WEIGHT: 26 lbs. (net).
AMBIENT TEMPERATURE: 10°C (50°F) to 55°C (131°F).
AMBIENT HUMIDITY: 0 to 95% relative.
ALTITUDE: Sea level to 10,000 feet.
MOUNTING: Standard 19" rack panel or free standing.

ORDERING INFORMATION

GTM-88S FM Stereo Modulation Monitor, complete with crystal, calibrated to specified operating frequency.....994-6569

FM Monaural Modulation Monitor



MODEL GTM-88M

Incorporating all of the advanced performance features of the stereo unit, the GTM-88M monophonic monitor can be readily converted to stereo operation with full FCC type approval. Printed circuit modular construction used in the GTM-88M allows conversion to stereo operation with no wiring changes. The conversion is accomplished by plugging in the appropriate modules and filters, then calibrating for stereo operation. The design also provides for the addition of an adapter for measurement of SCA modulation.

Silicon solid state and silicon integrated circuits used in the monitor were selected for their dependability.

All normal operating controls are on the front panel, with other controls behind a hinged front panel. When converted to stereo, the monophonic monitor requires no control changes. The peak modulation indicator is adjustable in 10 degree steps from 50% to 120%.

Separate headphone and instrument outputs receive an FM signal with de-emphasis, while the modulation meter receives the complete signal with pre-emphasis to provide accurate modulation readings. Compact in size, the GTM-88M is designed for standard rack mounting.

SPECIFICATIONS

ELECTRICAL

OPERATING FREQUENCY: 87.5 to 108 MHz.
RF INPUT IMPEDANCE: 50 ohms, unbalanced.
RF INPUT SENSITIVITY: 0.1 to 1 watt.
HEADPHONE OUTPUT: Load levels from 4 ohms to several megohms with 1% or less distortion. Separate level control.
POWER REQUIREMENTS: 100 to 130 VAC, 50/60 Hz, 40 watts.

INSTRUMENT OUTPUT

IMPEDANCE: 20,000 ohms.
FREQUENCY RESPONSE: ± 0.5 dB, 50 Hz to 15 kHz.
DISTORTION: 0.25%, 50 Hz to 15 kHz at 100% modulation.
INTERNAL NOISE: -70 dB below 100% modulation at 400 Hz.

MODULATION METER

ACCURACY: $\pm 5\%$.
BALLISTICS: Meet FCC rule 73.322 (b).
PEAK MODULATION INDICATOR: Adjustable from 50 to 120% modulation.
AM NOISE MEASUREMENT CAPABILITY: -70 dB, 30 Hz to 75 kHz.
FCC TYPE APPROVAL: No. 3-145.

MECHANICAL

RF INPUT CONNECTOR: UHF plug.
DIMENSIONS: 19" wide, 8 $\frac{3}{4}$ " high, 1 $\frac{1}{4}$ " deep.
WEIGHT: 24 lbs. (net).
AMBIENT TEMPERATURE: 10° to 55°C, (50° to 131°F).
AMBIENT HUMIDITY: 0 to 95% relative.
ALTITUDE: Sea level to 10,000 feet.
MOUNTING: Standard 19" rack panel or free standing.

ORDERING INFORMATION

GTM-88M FM Monaural Modulation Monitor, complete with crystal, calibrated to specified operating frequency-----

994-6581

HARRIS
GATES DIVISION
Harris-Intertype Corporation

SCA Modulation Monitor Adapter



MODEL GTA-6741

Gates SCA modulation monitor adapter measures all modulation characteristics of an SCA signal when used in conjunction with Gates FM modulation monitors. This adapter can also be used with the GTA-88F SCA frequency comparator to measure the accuracy of SCA frequencies as specified by the FCC. Total solid state circuitry, plus integrated circuits throughout the GTA-6741, assures trouble-free operation.

A built-in peak modulation flasher provides indication of peak or over-modulation on the SCA channel. The GTA-6741 is also equipped with an instrument output for connection of external test equipment without affecting performance of the adapter. A separate audio output provides a +10 dBm signal to drive an external amplifier. A separate headphone jack is also provided.

Measurements that can be made using this SCA modulation monitor adapter and Gates GTM-88S stereo or GTM-88M monophonic modulation monitor include:

1. SCA channel modulation (41 and/or 67 kHz).
2. Crosstalk—SCA into main channel.
3. Crosstalk—SCA into stereo channel.
4. Crosstalk—Main into SCA channel.
5. Crosstalk—Stereo into SCA channel.
6. Crosstalk—67 kHz into 41 kHz SCA channel.
7. Crosstalk—41 kHz into 67 kHz SCA channel.
8. FM noise measurements—SCA channel.
9. SCA frequency accuracy (when used with Gates GTA-88F frequency comparator).
10. Distortion on the SCA channel (with external distortion analyzer).

SPECIFICATIONS

OPERATING FREQUENCY: 41 kHz and 67 kHz.

SCA PEAK MODULATION INDICATOR: Adjustable to indicate from 50% to 120% modulation. Meets FCC Rules 73.332D (4).

CROSSTALK CAPABILITY

SCA INTO MAIN OR SUB: (10% SCA) 70 dB or better.

MAIN INTO SCA: (SCA 8:1) 50 dB or better (30 Hz - 15kHz).

STEREO INTO SCA: (SCA 8:1) 40 dB or better (30 Hz - 15 kHz).

41 KHZ INTO 67 KHZ: (both SCA at 10%) 45 dB (30 Hz - 5 kHz).

67 KHZ INTO 41 KHZ: (both SCA at 10%) 45 dB (30 Hz - 5 kHz).

AUDIO OUTPUT

HEADPHONE OUTPUT: Provides sufficient level for headphones from 4 ohms to several megohms. Separate level control provided. ± 1 dB 30 to 7,500 Hz.

AUDIO OUTPUT: +10 dBm at 600 ohms (unbalanced).

INSTRUMENT OUTPUT

IMPEDANCE: 20,000 ohms.

DISTORTION: 1% or better (30 Hz - 7.5 kHz).

FREQUENCY RESPONSE: ± 0.5 dB (30 Hz - 7.5 kHz).

GENERAL

POWER SOURCE: All DC voltages provided from GTM-88M or GTM-88S FM modulation monitors.

SIZE: 19" wide, 8 $\frac{3}{4}$ " high, 11" deep. Including knobs and rear connectors, 13" deep.

WEIGHT: 20 lbs. (net).

AMBIENT TEMPERATURE: 10°C to 55°C (50°F to 131°F).

AMBIENT HUMIDITY: 0 to 95% relative.

ALTITUDE: Sea level to 10,000 feet.

MOUNTING: Standard 19-inch rack panel or free standing.

ORDERING INFORMATION

GTA-6741 SCA Modulation Monitor Adapter.....994-6591

HARRIS
GATES DIVISION
Harris-Intertec Corporation



MODEL GTM-88F

FM FREQUENCY MONITOR

Gates all solid state FM frequency monitor measures the precise operating frequency of the FM transmitter by utilizing pulse counting techniques. A crystal controlled wide band pulse signal is compared with the FM transmitter center frequency to determine any frequency deviation from the assigned operating channel. The pulse counting technique assures a measurement accuracy of better than 0.0001%, and full compliance with all FCC requirements.

FREQUENCY RANGE: 88 to 108 MHz (fixed).

POWER: 100 to 130 VAC, 50/60 Hz, 40 watts, 19" W x 7" H x 10" D.

GTM-88F FM frequency monitor, complete with crystal, calibrated to specified operating frequency.....994-6588

PILOT-SCA FREQUENCY COMPARATOR

Gates pilot-SCA frequency comparator determines the accuracy of the pilot frequency when used with Gates GTM-88S stereophonic modulation monitor, and SCA frequencies when used with the GTA-6741 SCA modulation adapter. Three integrated circuits, one transistor, and nine diodes (all silicon) are used for stability and reliability. The GTA-88F is factory calibrated, and will provide years of dependable service in full compliance with existing FCC rules.

OPERATING FREQUENCIES: 19, 41 and 67 kHz as supplied.

POWER: 100 to 130 VAC, 50/60 Hz, 10 watts. 19" W x 5 1/4" H x 6 3/4" D. (8 3/4" deep with knobs and rear connectors.)

GTA-88F 19 kHz pilot/SCA 41 and 67 kHz frequency comparator...994-6603

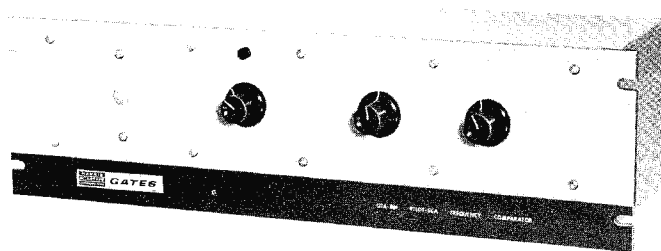

MODEL GTA-88F

FM RF AMPLIFIER

Designed to operate in conjunction with Gates FM frequency and modulation monitors, the GTM-88R amplifier is used at a remote location to provide sufficient RF power to drive the monitors. This is ideal for applications where the monitors are located at the studio and the transmitter is at a remote location. It permits the operator to monitor the frequency and modulation of the transmitter as required by FCC regulations. Solid state silicon circuitry plus extensive use of integrated circuits throughout assures dependable, trouble-free operation.

FREQUENCY RANGE: 87.5 to 108 MHz.

POWER: 115 V, 50/60 Hz, 12 watts. 19" W x 5 1/4" H x 10" D.

GTM-88R FM RF amplifier complete with antenna, less interconnecting cable.....994-6614

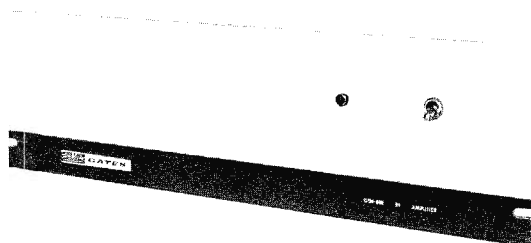

MODEL GTM-88R

Coaxial Transmission Line Systems

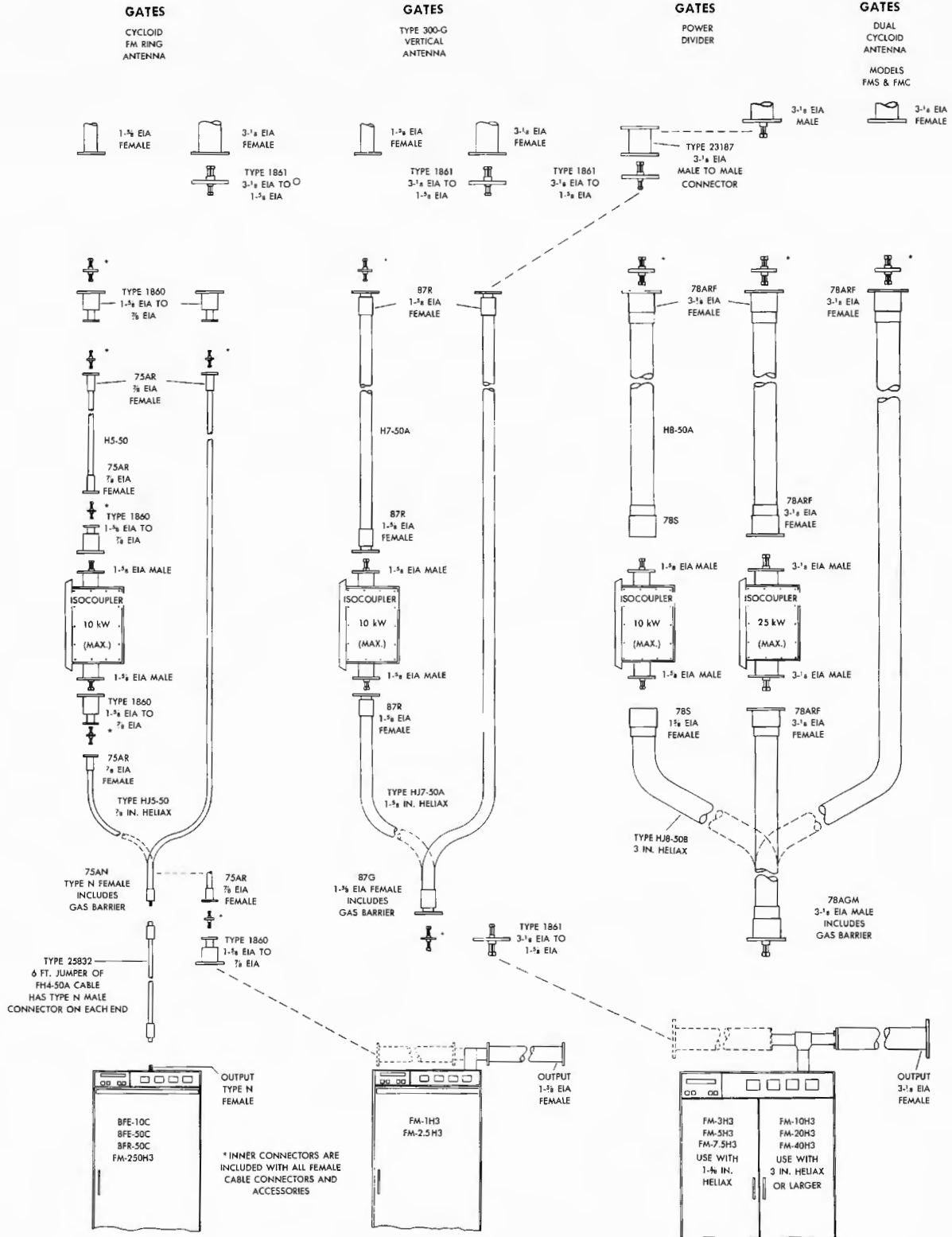

**RADIO
BROADCAST
TRANSMITTER
ACCESSORIES**

HARRIS
 **GATES DIVISION**
Harris-Intertype Corporation

Antenna Towers

FOR AM, FM AND TV

Available in choice of design and exact height for your frequency and power.

AM, FM and TV towers are available in the six basic designs shown here, insulated or non-insulated. All have superior *Utility* engineering and workmanship and always meet or exceed EIA specifications. In the five standard models, round members are welded together in 20-foot sections except for top section which is to your measurement. You have choice of hot dip galvanized or rust-inhibitive primer finish. All models available in knockdown design for compact export shipping. The Type 170KD tower is of bolted angle iron construction in 10-foot sections.

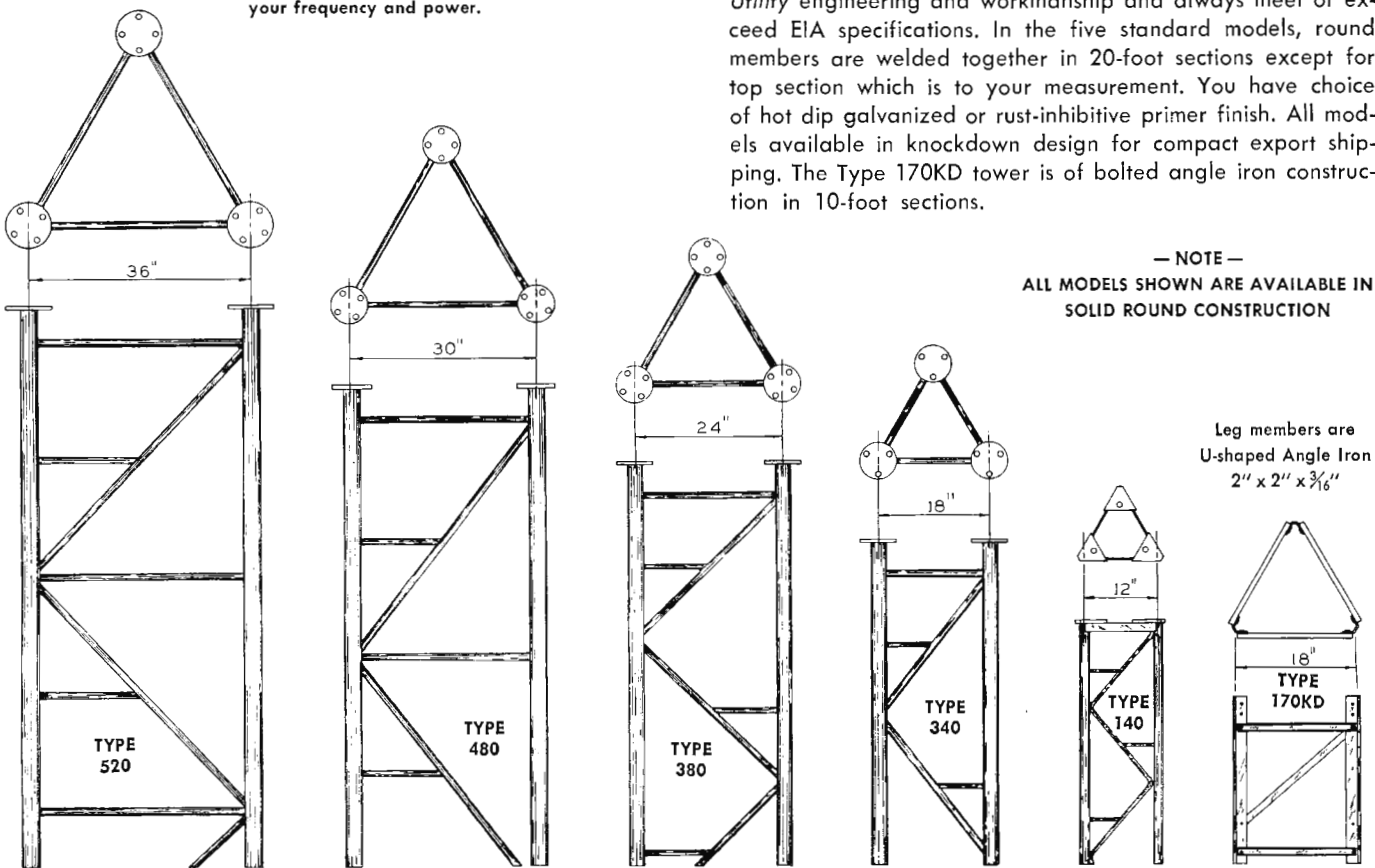

— NOTE —
ALL MODELS SHOWN ARE AVAILABLE IN SOLID ROUND CONSTRUCTION

Leg members are U-shaped Angle Iron 2" x 2" x 3/16"

RIGID ANCHOR BEAMS: Anchors are individually designed to meet the requirements of each tower installation. *Utility* uses the I-beam with its proven structural rigidity. When installed by *Utility* tower crews, on normal soil, this beam is imbedded in concrete slab reinforced with steel rods and with earth fill on top.

SOLID BASE INSULATORS: Insulated vertical radiators are equipped with the latest *Utility* 3401 or *Utility* 2201 pivot base insulators for positive insulation between base and ground. *Utility* base insulators have much higher compression rating than hollow insulators of similar size. They are resilient and shatter-proof. Each insulator is proof tested for a load approximately eight times greater than ever carried in normal broadcast service.

GALVANIZED HARDWARE: All *Utility* tower hardware is hot dipped galvanized to prevent rust and corrosion.

EASY MAINTENANCE: Round members and welded construction provide smooth surfaces for easy painting and servicing. Steps are built into bracing to eliminate need for scaffolding and to make entire height of tower easy for maintenance men to reach.

SPECIFICATIONS

| TOWER TYPE | MAXIMUM RECOMMENDED HEIGHT | TOWER WIDTH | WEIGHT PER FOOT* | TYPE OF BASE INSULATION |
|------------|----------------------------|-------------|------------------|-------------------------|
| 520 | 500 FT. | 36 IN. | 31 LBS. | LOCKE OR LAPP |
| 480 | 480 FT. | 30 IN. | 28 LBS. | |
| 380 | 400 FT. | 24 IN. | 19 LBS. | UTILITY 3401 |
| 340 | 350 FT. | 18 IN. | 17 LBS. | UTILITY 3401 |
| 140 | 200 FT. | 12 IN. | 12 LBS. | UTILITY 2201 |
| 170KD | 320 FT. | 18 IN. | 17 LBS. | UTILITY 3401 |

*Tower steel only—Weight of guys, insulators, etc., not included.

ORDERING INFORMATION

Specify: Type of tower; tower height; insulated or non-insulated; galvanized or non-galvanized. Self-supporting, tall TV towers, or towers over 520' will be quoted upon request. Installation services for towers, FM, TV antennas, transmission line, AC lighting and ground systems also available on request.



Tower Lights And Accessories

BEACON FLASHERS

| NON-FUS. | FUSED | DESCRIPTION | NO. OF SWITCHES | MAX. RATING WATTS/SWITCH | HOUSING TYPE | TAPS or K.O. | WEIGHT SHIP | (LBS.) NET |
|----------------------------------|----------------------------------|--|-----------------|--------------------------|----------------------------|--------------|----------------|----------------|
| BF 60A-1 BF 60A-2 BF 60A-3 | BF 60F-1 BF 60F-2 BF 60F-3 | Single Pole, Single Throw 117 Volt, 60 Hz | ONE | 2800 | OUTDOOR INDOOR PANEL | ¾" | 12 11 4½ | 11 10 3 |
| BF 61A-1 BF 61A-2 BF 61A-3 | BF 61F-1 BF 61F-2 BF 61F-3 | Single Pole, Double Throw (for Load Balance Resistor) 117 Volt, 60 Hz | ONE | 1500 | OUTDOOR INDOOR PANEL | ¾" | 12 11 4½ | 11 10 3 |
| BF 62A-1 BF 62A-2 BF 62A-3 | BF 62F-1 BF 62F-2 BF 62F-3 | Single Pole, Single Throw 240 Volt, 60 Hz | ONE | 2800 | OUTDOOR INDOOR PANEL | ¾" | 12 11 4½ | 11 10 3 |
| BF 63A-1 BF 63A-2 BF 63A-3 | BF 63F-1 BF 63F-2 BF 63F-3 | Double Pole, Single Throw 117 Volt, 60 Hz, or 120/240 Volt, 60 Hz | TWO | 2800 | OUTDOOR INDOOR PANEL | 1" | 13 11 5 | 12 10 3½ |
| BF 64A-1 BF 64A-2 BF 64A-3 | BF 64F-1 BF 64F-2 BF 64F-3 | Two Circuit 117 Volt, 60 Hz, or 120/240 Volt, 60 Hz | TWO | 2800 | OUTDOOR INDOOR PANEL | 1" | 13 11 5 | 12 10 3½ |
| BF 65A-1 BF 65A-2 BF 65A-3 | BF 65F-1 BF 65F-2 BF 65F-3 | Single Pole, Single Throw 240 Volt, 50 Hz | ONE | 2800 | OUTDOOR INDOOR PANEL | ¾" | 13 11 5 | 12 10 3½ |
| BF 66A-1 BF 66A-2 BF 66A-3 | BF 66F-1 BF 66F-2 BF 66F-3 | Single Pole, Single Throw 117 Volt, 60 Hz with BY-PASS | ONE | 1500 | OUTDOOR INDOOR PANEL | ¾" | 28 23 9 | 23 18 6 |
| BF 67A-1 BF 67A-2 BF 67A-3 | BF 67F-1 BF 67F-2 BF 67F-3 | Single Pole, Double Throw 117 Volt, 60 Hz with BY-PASS (for Load Balance Resistor) | ONE | 1500 | OUTDOOR INDOOR PANEL | ¾" | 28 23 9 | 23 18 6 |
| BF 68A-1 BF 68A-2 BF 68A-3 | BF 68F-1 BF 68F-2 BF 68F-3 | Two Circuit, Double Pole 120/240 Volt, 60 Hz | FOUR | 2800 | OUTDOOR INDOOR PANEL | 1¼" | 36 25 10 | 29 21 7 |
| BF 69A-1 BF 69A-2 BF 69A-3 | BF 69F-1 BF 69F-2 BF 69F-3 | Three Circuit 120/240 Volt, 60 Hz or 120/208 Volt, 3 PH. | THREE | 2800 | OUTDOOR INDOOR PANEL | 1¼" | 35 24 10 | 28 20 7 |
| BF 70A-1 BF 70A-2 BF 70A-3 | BF 70F-1 BF 70F-2 BF 70F-3 | Four Circuit 120/240 Volt, 60 Hz or 120/208 Volt, 3 PH. | FOUR | 2800 | OUTDOOR INDOOR PANEL | 1¼" | 36 25 10 | 29 21 7 |

*Mercury Switch
710 - 0016 - 000
604 - 0449 - 000 Switch*

ACCESSORIES

TOWER LIGHTS: Single obstruction light, bottom entrance conduit fitting furnished with lamp receptacle to accommodate 116 watt, 120 V medium screw base lamp, or 1020 lumen pre-focus series lamp.

Single obstruction light.....710-0012

Single obstruction light, same as above, but side entrance conduit fitting. Order.....710-0013

Double obstruction light, with two lamp receptacles, each accommodating 116 watts, medium screw base. Bottom entrance fitting type for one-inch conduit.

Double obstruction light710-0014

Clear traffic signal lamp. 107 watt, 115 V.

Signal lamp 107A21/TS396-0141

Code Beacon 300 MM, standard fully approved FCC and CAA model supplied with two red filters.

For 1" conduit, 3-wire Grn Ground710-0063

For 1" conduit, 4-wire Grn Ground710-0075

Beacon lamp, 620 watt 620P540396-0129

PHOTO-CELL AND BEACON FLASHER: A combination unit in weatherproof housing. Photo-cell may be rotated to north regardless of mounting position on tower. Turns on at 35 foot candles and off at 58 foot candles.

For 1 pole 30 amperes, flashes one circuit.....710-0058

FISHER-PIERCE PHOTO-CELL UNIT: A unit completely weatherproof, fully approved for turning on and off tower lights; has time delay of 5-7 seconds to prevent operation by chance.

For 105/130 V, 3000 watt rating, SPST, double break.....670-0007

HARRIS
GATES DIVISION
Harris-InterType Corporation

Coaxial And Rigid Transmission Lines

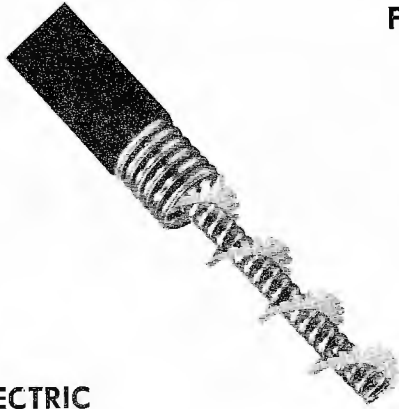

AIR DIELECTRIC

FLEXIBLE COAXIAL CABLE

Produced in continuous splice-free lengths, Heliax® low-loss cable is ideally suited for any application where use of coaxial transmission line is indicated. For medium wave VHF and UHF applications, long, continuous lengths provide ease of installation and maintenance-free service. Corrugated copper conductors provide a combination of flexibility and low loss. Although Heliax connectors and fittings are easily attached, it is recommended that all cable assemblies be ordered with fittings factory attached with specialized manufacturing equipment. Please order by type number.

® Registered trademark, Andrew Corporation.

SPECIFICATIONS

| SIZE: | 7/8" | 1 5/8" | 3" | 5" |
|------------------------------------|--------|---------|---------|--------|
| TYPE NUMBER, JACKETED: | HJ5-50 | HJ7-50A | HJ8-50B | HJ9-50 |
| IMPEDANCE: OHMS | 50 | 50 | 50 | 50 |
| ATTENUATION @ 100 MHz, dB/100 FT.: | 0.37 | 0.21 | 0.14 | 0.080 |
| VELOCITY: %: | 91.6 | 92.1 | 92.3 | 93.0 |
| AVERAGE POWER, @ 100 MHz-kw: | 6.4 | 14.5 | 37.0 | 73.0 |
| BEND RADIUS (MINIMUM)—INCHES: | 10 | 20 | 30 | 50 |
| NET WEIGHT—UNJACKETED: POUNDS/FT.: | .43 | — | — | — |
| NET WEIGHT—JACKETED: POUNDS/FT.: | .53 | 1.04 | 1.8 | 3.3 |

*10ft
618-0170*

FOAM DIELECTRIC COAXIAL CABLE



Foam Heliax is used in those broadcast installations requiring low loss coaxial cable in which pressurizing is not desirable. A corrugated copper outer conductor and foam dielectric provide a combination of high strength, low loss and power handling not available in solid dielectric cables. The flexibility of foam Heliax provides maximum resistance to crushing, kinking or denting, and enables it to be pulled through conduits and around obstructions. Please order by type number.

SPECIFICATIONS

| SIZE: | 1 1/2" | 7/8" |
|------------------------------------|-----------|----------|
| TYPE NUMBER, JACKETED: | FHJ4-50B | FHJ5-50A |
| IMPEDANCE: | 50 ohms | 50 ohms |
| ATTENUATION @ 100 MHz, dB/100 FT.: | 0.82 | 0.44 |
| VELOCITY, %: | 79 | 79 |
| AVERAGE POWER, @ 100 MHz, kW | 2.3 | 4.8 |
| BENDING RADIUS (MINIMUM)—INCHES: | 5 | 10 |
| NET WEIGHT—JACKETED: | .185 lbs. | .42 lbs. |

RIGID TRANSMISSION LINES

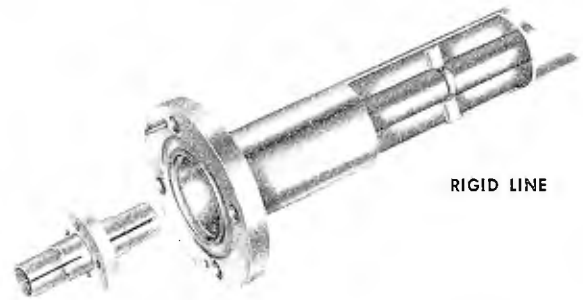

RIGID LINE







Teflon insulated rigid copper coaxial transmission lines for broadcast application. Line and connectors meet all EIA applicable standards. Mitered elbows are compensated to provide low VSWR. All rigid sections and components include inner connectors, "O" ring and hardware. Please order by type number, and specify frequency.

SPECIFICATIONS

| SIZE: | 1 5/8" | 3 1/8" |
|------------------------------------|---------|---------|
| TYPE NUMBER: | 561 | 562A |
| IMPEDANCE: | 50 ohms | 50 ohms |
| ATTENUATION @ 100 MHz, dB/100 FT.: | 0.20 | 0.11 |
| VELOCITY, %: | 99.8 | 99.8 |
| AVERAGE POWER, @ 100 MHz: | 15.0 kW | 48.0 kW |
| NET WEIGHT—POUNDS/FEET: | 1.25 | 2.75 |

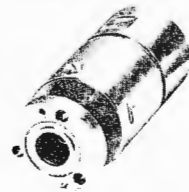
Coaxial Transmission Line Accessories

Fittings: Flanged items are EIA standard and include inner connector, "O" ring, silicon grease and hardware kit.





| | | | | | |
|--|--|---|---|---|--|
| EIA FLANGE  | EIA FLANGE  | REDUCER CONNECTOR  | END TERMINAL  | TYPE N JACK  | SPLICE  |
| Use with copper Heliac cable. | Includes gas barrier. | Reduce cable size to EIA flange sizes. | For strap connection to center conductor. | Female, mates with (-). | Use with copper Heliac cable. |

FOAM DIELECTRIC

| | | | | | | | |
|------|------|-----|-----|------|------|-------------|------|
| 1/2" | 44AR | --- | --- | 1/2" | 44AT | (UG21) 44AN | 44AZ |
| 7/8" | 45AR | --- | --- | 7/8" | 45AT | (UG21) 45AN | 45AZ |

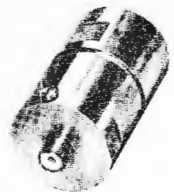
AIR DIELECTRIC

| | | | | | | | |
|--------|-------|-------|--------------------------|--------|----------------|-------------|------|
| 7/8" | 75AR | 75AG | --- | 7/8" | 75AT | (UG21) 75AN | 75AZ |
| 1 3/8" | 87R | 87G | 1 3/8"-7/8" 87S | 1 3/8" | 87T | (UG21) 87N | 87Z |
| 3" | 78ARM | 78AGM | 3 3/8"-1 5/8" 78AS | 3" | (78ARM + 2062) | --- | 78AZ |
| 5" | 79R | 79G | 6 1/8"-3 1/8" (79R+1872) | 5" | (79R + 2073) | --- | 79Z |

| | | | | |
|--|--|--|---|---|
| TYPE UHF JACK  | NON-INSULATED HANGER  | INSULATED HANGERS  | INSULATED HANGERS  | HANGER ADAPTERS |
| Female. | Kit of 10 hangers. Spacing 3' for 1 3/8" cables, 5' for 3" and 5" cables. | Use on insulated tower spacing 3 feet apart. | Use on insulated tower spacing 3' apart for 1 3/8", 5' for larger sizes. | INSULATED Adapters used to mount insulated hangers to tower without drilling. Angle Members 13555A Round Members up to 3" 13550 |
| | | | | NON-INSULATED Kit consists of 10 adapters to mount hangers to tower. |

FOAM DIELECTRIC

| | | | | | |
|------|------|----------|------|---------|-----|
| 1/2" | 44AU | WRAPLOCK | 1/2" | 11662-3 | --- |
| 7/8" | 45AU | 12395-1 | 7/8" | 11662-2 | --- |

AIR DIELECTRIC

| | | | | | |
|--------|------|----------|--------|---------|---------|
| 7/8" | 75AU | WRAPLOCK | 7/8" | 11662-2 | --- |
| 1 3/8" | 87U | 33598-1 | 1 3/8" | --- | 33948-3 |
| 3" | --- | 33598-3 | 3" | --- | 33948-2 |
| 5" | --- | 33598-5 | 5" | --- | 33948-1 |

ANGLE MEMBER TOWERS

| | |
|-------------------|---------|
| 1 3/8" hangers | 31768 |
| 3" and 5" hangers | 33981-1 |

ROUND MEMBER TOWERS

| Member Diameter | Use With | |
|-----------------|----------|---------|
| | 1 3/8" | 3-5" |
| 1"-2" | 31670-1 | --- |
| 2"-3" | 31670-2 | 33984-1 |
| 3"-4" | 31670-3 | 41108-1 |
| 4"-5" | 31670-4 | 41108-2 |
| 5"-6" | 31670-5 | 41108-3 |

WRAPLOCK

One hundred feet of stainless steel wraplock, complete with fasteners. Use at three-foot intervals for all cables 1 3/8" and smaller.
Type 12395-1

GROUNDING KITS

| Cable Size | Jacketed |
|------------|----------|
| 1/2" | 26892-2 |
| 7/8" | 24810-2 |
| 1 3/8" | 24811-2 |
| 3" | 28708-2 |
| 5" | 30417-2 |
| 8" | 30417-2 |









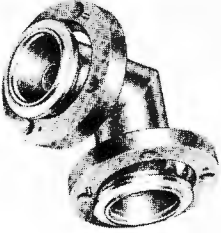
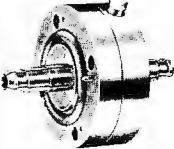

HOISTING

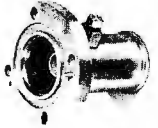
| Jacketed |
|----------|
| --- |
| 19256B |
| 24312A |
| 26985A |
| 31031-1 |
| 31031-2 |

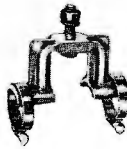
HARRIS
GATES DIVISION
Harris-Intertec Corporation

Coaxial Transmission Line Accessories

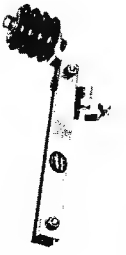
Fittings: All flanged items are EIA standard and include inner connector, "O" ring, silicon grease and hardware kit. All hangers require round member or angle adapters for attachment to tower.

| 90° MITER ELBOW | GAS BARRIER | REDUCER | END TERMINAL | INNER CONNECTOR | ROUND MEMBER CLAMP |
|---|---|--|---|---|---|
|  |  |  |  |  |  |
| Brass construction with swivel flanges on both ends. Includes one inner connector. | With fixed male connector on both ends. May be used as gas inlet fitting. | Reduces line size. | For strap connection. Gas tight with vent plug. Includes inner connector. | With Teflon anchor bead. | Attaches hangers to tower members up to 3" diameter. |
| 7/8" 1060 1 5/8" 1061 3 1/8" 1062 | 7/8" 1260A 1 5/8" 1261B 3 1/8" 1262A | 7/8"-1 5/8" 1860A 1 5/8"-3 5/8" 1861 3 1/8"-6 1/8" 1872 | 7/8" — 1 5/8" 2061 3 1/8" 2062 | 7/8" 34389A 1 5/8" 34660 3 1/8" 15093A | 7/8" 13550 1 5/8" 13550 3 1/8" 13550 |
| RIGID HANGER | SLIDING HANGER | SPRING HANGERS | INSULATED SLIDING HANGERS | INSULATED SPRING HANGER | ANGLE ADAPTER |
|  |  |  |  |  |  |
| Mounts to 3/16" diameter hole with 1 1/2" bolt or angle adapter. Use at 300' intervals. | 7/8" size use at 6' intervals. 1 5/8" use at 10 foot intervals. | 7/8" size use at 100' intervals. 1 5/8" size use at 50' intervals. 3 1/8" size use at 10' intervals. | Same as Type 14378 except includes insulator, 14063. | Same as spring hangers except includes insulator, 14063. | Galvanized clamp for attaching hangers to tower angle members up to 7/8" thick. |
| 1 5/8" 13924 3 1/8" 13927 | 1 5/8" 14378 3 1/8" — | 1 5/8" 14379 3 1/8" 13925 | 1 5/8" 14442 3 1/8" — | 1 5/8" 14441 3 1/8" 13926 | 1 5/8" 13555A 3 1/8" 13555A |

INNER CONNECTOR ADAPTER, 50-51 ohms—7/8" size, Type 4850A; 1 5/8", Type 4851; 3 1/8", Type 4852.

HARDWARE KIT for use on one pair of flanges—7/8" size, Type 11381-5; 1 5/8" size, Type 11381-2, 3 1/8" size, Type 11381-3.

"O" RING GASKET, 7/8" size, Type 10683-197; 1 5/8" size, Type 10683-406; 3 1/8" size, Type 10683-405.

Coaxial Transmission Line Accessories

PRESSURIZATION EQUIPMENT

Automatic Dehydrators—Types 1920A and 1930 are heatless, fully automatic dehydrators capable of delivering continuous supplies of dry air. No down time is necessary to activate the dry agent. Both units will operate over an ambient range of 0° to 120°F with an input humidity of 95%.



| | | |
|------------------------------|----------------------|-------------------------|
| TYPE: | 1920A | 1930 |
| OUTPUT: | 1.2 CFM @ 4 psig | .2 CFM |
| POWER: | 120V, 60 Hz | 120V, 60 Hz |
| INTERNAL OPERATING PRESSURE: | 60 psig | 30 psig |
| OUTLET DEWPOINT: | Below -37°F | Below -20°F |
| DIMENSIONS, INCHES: | 15 3/8 x 24 x 14 1/4 | 13 1/4 x 7 1/4 x 14 7/8 |

DRY AIR HAND PUMP

Type 878A, dry air hand pump, pressurizes up to 1000 feet of 7/8" cable or 250 feet of 1 1/2" line. One pound of silica gel and seven feet of hose is supplied.



Please order by type number.....878A

NITROGEN TANK FITTINGS

Type 858C, nitrogen tank fittings—includes pressure regulator, high and low pressure gauges and 10 feet of 3/8" O.D. poly tubing and fittings to fit 1/8" MPT.

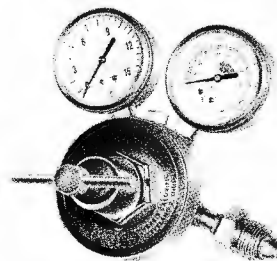

Please order by type number.....858C

Replacement cartridge 620-1457-000

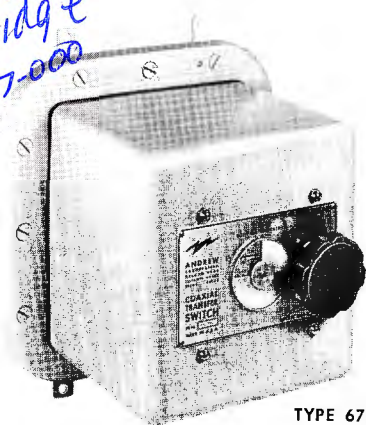

TYPE 6740A

| | | |
|----------------------------|--------------|--------------|
| LINE SIZE, INCHES: | 1 5/8" | 3 1/8" |
| TYPE NUMBER: | 6730E | 6740A |
| FREQUENCY BAND MHz: | 0-1000 | 0-1000 |
| CURRENT REQUIREMENT, AMPS: | 0.3 | 2.0 |
| POWER PEAK* kW: | 100 | 400 |
| VSWR, MAXIMUM: | 1.03-500 MHz | 1.02-500 MHz |
| SWITCHING TIME, SECONDS: | 2 | 2 |
| DIMENSION, INCHES: | 8 x 8 x 10 | 14 x 14 x 14 |
| WEIGHT, POUNDS: | 13 | 65 |

* At unity VSWR and 40°C (104°F) ambient temperature.

COAXIAL SWITCHING EQUIPMENT

These 1 5/8" and 3 1/8" coaxial transfer switches are used wherever RF power must be rerouted quickly and reliably from a central control point. Since the switches can be controlled from a remote location, or combined with an automatic switching system, they are ideally suited for use in unattended transmitter operations.

The combination of high power capability and guaranteed low VSWR makes these switches the choice of engineers for routing RF power quickly and reliably. The switches are of the four-part transfer type and also can be used as single-pole, double-throw switches. This allows planning flexibility for present and future switching requirements.

Transfer switches are available in three basic sizes incorporating 1 5/8", 3 1/8" or 6 1/8" EIA flanges. Each size is available for either 120 or 220/240V., 50/60 Hz operation. In the event of control power failure, the switches can be operated manually.

Transmission Line Pressurization Systems

All air dielectric cable and rigid line should be pressurized with dry air or dry gas. Changes in temperature can cause moisture condensation from outside air and seriously impair the electrical efficiency of the line. For this reason, cable or rigid line should be under pressure at all times.

Pressurization can be accomplished by manual or automatic means, depending upon the amount of line in use at the station and whether or not the site is attended. Automatic electric dehydrators are recommended for unattended sites or those where larger amounts of cable or rigid line are employed. A dry air hand pump is usually satisfactory for attended sites using a relatively small amount of cable. A cylinder of dry nitrogen gas can also be used. All installations of air dielectric cable, line or microwave waveguide should be purged prior to putting the system in service and at any

time moist air enters the line. To purge the system, pressurize at the equipment end of the line (5-10 psig) with the Type 1920A automatic dehydrator, nitrogen gas cylinder, or Type 878 hand pump. Bleed the line using the gas port plug located at the antenna end of the line and allow the pressure to drop to zero.

Repeat this procedure three times to ensure that the moist air is replaced by dry air or dry gas.

When it is too difficult or inconvenient to bleed the air at the antenna end of the line, let the air escape at the transmitter or dehydrator end after pressurizing the line three times, allowing an hour each time for the air to mix.

Type 1920A dehydrator will automatically maintain from 3 to 8 psi while gas cylinder output pressure should be set between 2 and 10 psig.

Automatic Dehydrator System

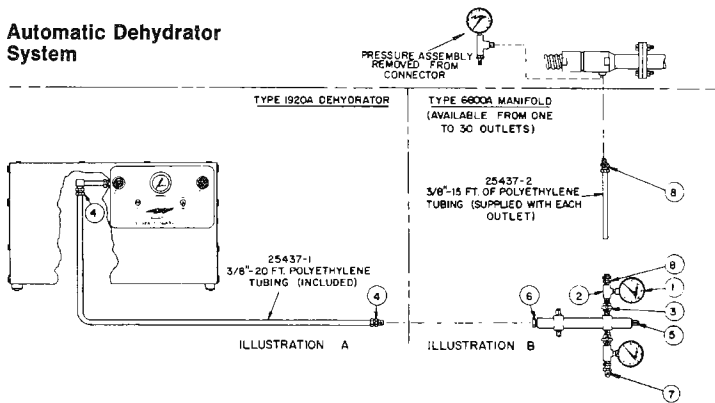

AUTOMATIC DEHYDRATOR SYSTEM

- 1) 3500 pressure gauge *620 - 0076 - 000*
- 2) 3028 tee (brass) 1/8 F.P.T. on all three
- 3) 4944 needle valve (40 P.S.I.) 1/8 male to 1/8 male
- 4) 25436-5 male fitting (brass) 3/8 tube to 1/8 M.P.T.
- 5) 9908-2 plug (brass) 1/4 M.P.T. Sq. Hd.
- 6) 4960 bushing (brass) 1/8 F.P.T. to 1/4 M.P.T.
- 7) 25436-1 cap (polyethylene) 3/8 O.D.
- 8) 25436-2 half union (brass) 3/8 tube to 1/8 M.P.T.

NOTE: For reference only. Parts listed are included with Types 1920A and 6600A.

Compressed Gas System

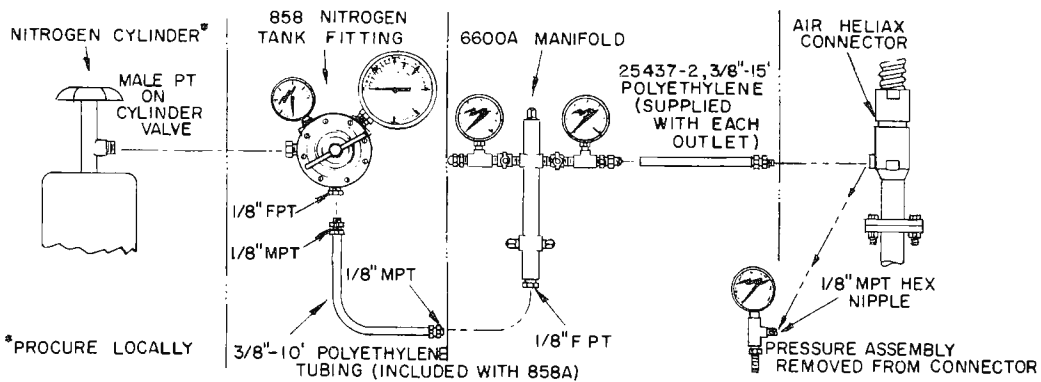

Manual System

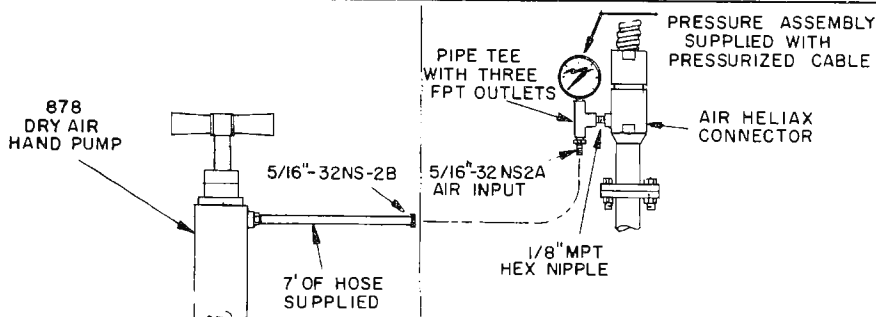

Open Wire Transmission Line



M-3327 Bracket.

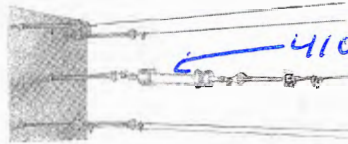

M-3328 End Plate.



M-2870D Feed-thru Bowl.



M-3322 Horn Gap.



M-3864 Center Post.

HORN GAP

A very desirable item where higher power is employed. Connects to hot side of line and ground to drain off lightning and heavy static discharges. Usually one is employed for each 200 feet of line. Insulator for 150 kW. Arc gaps heavy chrome plate. Galvanized throughout.

Horn Gap994-3322

CENTER POST ASSEMBLY

Has variety of uses such as end or corner angling of transmission line, support insulator for two wire line or rhombic antennas, and a guide insulator such as end of building or coupling unit. Rating 150 kW. Galvanized throughout.

Center Post Insulator994-3864

HARD DRAWN WIRE

If desired, when ordering transmission line components, Gates will gladly supply No. 6, 8 or 10 hard drawn copper wire at current market prices. State length in feet desired, remembering to multiply the length of line by the number of wires in line, either 5 or 6.

SPECIAL OPEN WIRE LINES

Gates engineers have designed many special open wire lines for both short and long distances. Most celebrated was a 30-mile line supplied for use in the Arctic Circle. Upon receipt of a sketch or word description of the requirements, Gates engineers will gladly submit layout and quotation.

TRANSMISSION LINE BRACKET

For 5 or 6 wire transmission line. Rating up to 150 kW modulated. Made of 1/4" steel 3" wide with welded L section on each side to fully prevent twisting under ice or wind load. Supplied with 8 1/4" ribbed insulator, wire guides and all hardware. Galvanized throughout.

Line Bracket994-3327

LINE END PLATE

To terminate the open wire line at each end. Plate is 1/4" thick, 20" square. Fully galvanized. Includes turnbuckles, 25 1/2" strain insulator and all hardware. Rating up to 150 kW modulated.

End Plate994-3328

FEED-THRU BOWLS

A large feed-thru bowl with 50 kW modulated rating. Available in single and double units and with solid or hollow studs as listed below. Bowls are Alsimag. Hardware, heavy brass. Velutex seals are provided for weathertight installation.

Solid stud, 2 bowls, for walls to 10 1/2" thick994-2870

Same as above but hollow stud994-3254

Solid stud, single bowl, for walls 1" thick994-5280

Same as above but hollow stud994-5281

DESIGN AND IMPEDANCE CHART

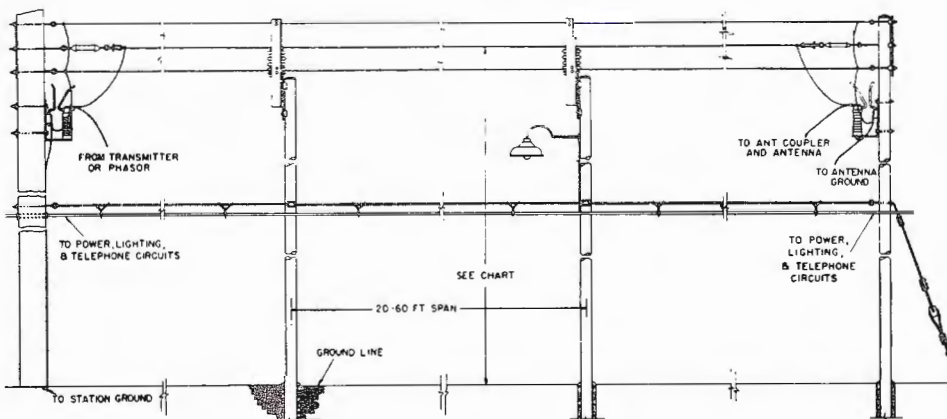

AVERAGE SURGE IMPEDANCE FOR 6 WIRE TRANSMISSION LINES

| HEIGHT OF CENTER WIRE | WIRE SIZE | | |
|-----------------------|-----------|-------|-------|
| | 6 | 8 | 10 |
| 9' | 232 Ω | 246 Ω | 250 Ω |
| 10' | 234 Ω | 250 Ω | 256 Ω |
| 12' | 240 Ω | 252 Ω | 260 Ω |

AVERAGE SURGE IMPEDANCE FOR 5 WIRE TRANSMISSION LINES

| HEIGHT OF CENTER WIRE | WIRE SIZE | | |
|-----------------------|-----------|-------|-------|
| | 6 | 8 | 10 |
| 9' | 330 Ω | 346 Ω | 364 Ω |
| 10' | 333 Ω | 350 Ω | 365 Ω |
| 12' | 332 Ω | 348 Ω | 363 Ω |

Chart above illustrates typical five or six wire open type transmission line. Table is provided to show impedances with various wire sizes at certain heights above ground. Transmission line brackets are M-3327, end plate M-3328. Horn gap is M-3322. The power, lighting and telephone circuits shown are optional, according to requirements of installation.



Heavy Duty Inductors and Capacitors

② 827-5594-001
827-5594-002
per coil

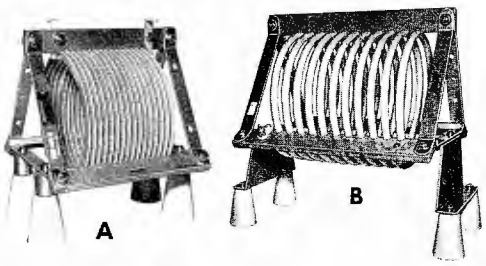

Gates manufactured inductors put the emphasis on solid mechanical construction. Variable coils have double gripping contact wheels. Other sizes and ratings available on special order.

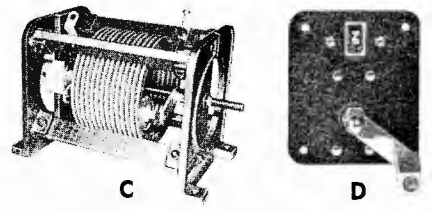

EXPLANATION OF TYPE NUMBER

| | | | | | | |
|-----------------------------|-----------------------|--|--|------------------|--|----------------------------|
| 87 | F | A | | 46 | 3 | 4 |
| Inductance in microhenries. | F—Fixed V—Variable | A— $\frac{1}{4}$ " B— $\frac{3}{8}$ " C— $\frac{1}{2}$ " | No letter here indicates ribbon. "T" indicates tubing. | Number of turns. | Pitch of winding in $\frac{1}{16}$ " for ribbon, $\frac{1}{8}$ " for tubing. | Inside diameter in inches. |

SPECIFICATIONS AND ORDERING INFORMATION

| ORDER NO. | TYPE NO. | FIG. | OVER-ALL LENGTH IN INCHES | ORDER NO. | TYPE NO. | FIG. | OVER-ALL LENGTH IN INCHES |
|--------------|-----------|------|---------------------------|--------------|-----------|------|---------------------------|
| 931-6138-010 | 87FA4634 | A | 12 | 931-6337-003 | 32FBT1658 | B | 15 |
| 931-6138-039 | 6FC0854 | A | 6 $\frac{1}{4}$ | 931-6337-004 | 45FBT2158 | B | 18 $\frac{1}{2}$ |
| 931-6138-040 | 10FC0855 | A | 6 $\frac{1}{4}$ | 931-6372-002 | 65FBT2559 | B | 24 $\frac{1}{2}$ |
| 931-6138-041 | 13FC0856 | A | 6 $\frac{1}{4}$ | 931-6337-001 | 17FCT1178 | B | 14 |
| 931-6138-025 | 17FC1654 | A | 8 $\frac{3}{4}$ | 931-6372-001 | 35FCT1769 | B | 24 $\frac{1}{2}$ |
| 931-6138-026 | 24FC1655 | A | 8 $\frac{3}{4}$ | 931-6583-008 | 6VC0854 | C | 8 |
| 931-6138-027 | 32FC1656 | A | 8 $\frac{3}{4}$ | 931-6583-001 | 15VC1444 | C | 9 |
| 931-6138-036 | 42FC2266 | A | 12 $\frac{1}{2}$ | 931-6583-002 | 26VC2144 | C | 10 $\frac{3}{4}$ |
| 931-6138-030 | 67FC2856 | A | 13 | 931-6583-003 | 42VC2145 | C | 10 $\frac{3}{4}$ |
| 931-6337-007 | 10FBT1066 | B | 12 $\frac{1}{2}$ | 931-6583-004 | 62VC2845 | C | 12 $\frac{1}{2}$ |
| 931-6337-002 | 20FBT1656 | B | 15 | | | | |

$\frac{1}{4}$ Coil clip for FA coils 402-0029
 $\frac{1}{2}$ Coil clip for FC coils 402-0031
 Coil clip for FBT coils 402-0033
 Coil clip for FCT coils 402-0034
 910-4483-001 contact roller VC Series
 910-4483-002 " " VB "

Counter dial for variable coils reads 1/10 turns.
 Size: 3" wide, 3 $\frac{1}{2}$ " high. Figure D.
 With removable crank handle 994-6233-001
 With non-removable crank handle 926-5509-003



MICA CAPACITORS FOR TRANSMITTERS AND PHASORS

Designed for continuous service with each sheet of mica carefully gauged for thickness and inspected for absence of impurities. Tolerance plus or minus 5%. Cast end bells and ceramic insulated. Sizes over-all: Model G1: 3 $\frac{3}{4}$ " x 2 $\frac{1}{2}$ ". Model G2: 4 $\frac{1}{4}$ " x 3". Model G3: 6 $\frac{1}{2}$ " x 4". Model G4: 6 $\frac{1}{2}$ " x 5 $\frac{3}{4}$ ". Usually all sizes carried in stock. Please order by type number and capacity. Example: Model G2, capacity .0003 mfd. Other sizes and ratings available on special order.

| CAPACITY mfd. | MODEL G1 | | MODEL G2 | | MODEL G3 | | MODEL G4 | |
|------------------|----------|-------|----------|--------|----------|--------|----------|--------|
| | Amps | Volts | Amps | Volts | Amps | Volts | Amps | Volts |
| .0002 | 3 | 6000 | 4.3 | 10,000 | 5.6 | 20,000 | | |
| .00025 | | | 5.1 | 10,000 | | | 8.2 | 30,000 |
| .0003 | | | 5.6 | 10,000 | 6.8 | 20,000 | 9.1 | 30,000 |
| .0004 | 4.7 | 6000 | 6.2 | 10,000 | 8.2 | 20,000 | | |
| .0005 | 5.1 | 6000 | 6.8 | 10,000 | 9 | 20,000 | 12 | 30,000 |
| .0008 | | | | | 12 | 20,000 | 15 | 30,000 |
| .001 | 7.5 | 6000 | 10 | 10,000 | 13 | 20,000 | 16 | 30,000 |
| .0015 | 9.1 | 6000 | 12 | 10,000 | 16 | 15,000 | 20 | 25,000 |
| .002 | 11 | 6000 | 13 | 10,000 | 20 | 15,000 | 22 | 20,000 |
| .003 | 13 | 6000 | 16 | 8,000 | 24 | 12,000 | 27 | 20,000 |
| .004 | 15 | 6000 | 18 | 8,000 | 27 | 12,000 | 30 | 20,000 |
| .005 | 16 | 4000 | 20 | 6,000 | 30 | 10,000 | 33 | 15,000 |
| .006 | 18 | 4000 | 22 | 5,000 | 33 | 10,000 | 36 | 15,000 |
| .008 | | | | | 36 | 10,000 | 39 | 12,000 |
| .01 | 20 | 4000 | 24 | 5,000 | 39 | 8,000 | 43 | 10,000 |
| .02 | | | | | 47 | 5,000 | | |

AUDIO CONTROL CONSOLES

HARRIS
 **GATES DIVISION**
Harris-Intertype Corporation

Television Audio Control Console

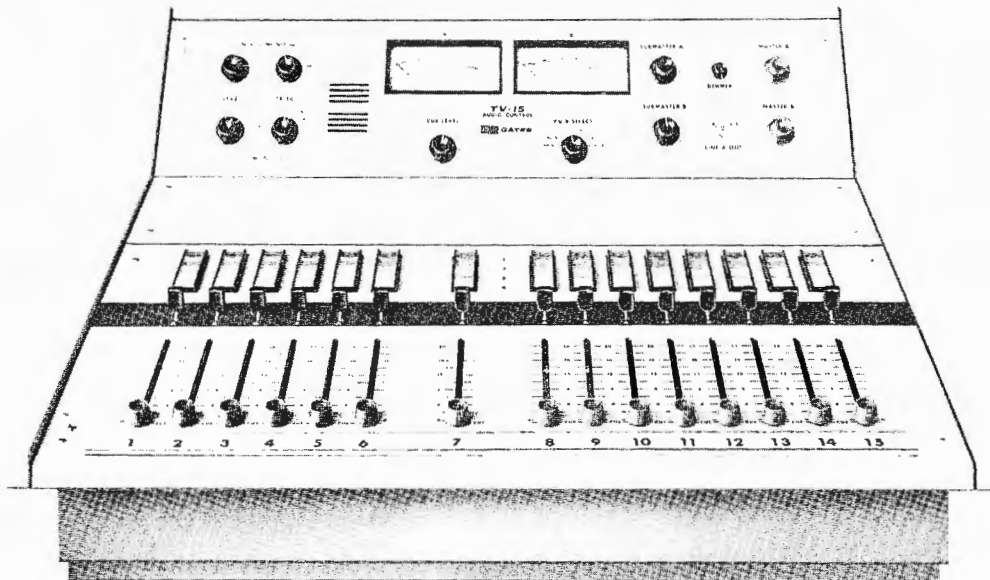

THE TV-15

Gates' TV-15 audio control console provides extensive facilities for a wide range of audio control situations where a maximum number of inputs and/or mixing channels are required for a minimum amount of space. It was designed for all television stations and, because of maximum flexibility, fulfills a wide range of requirements.

The TV-15 is capable of mixing 15 signals from up to 60 sources. It is a dual-channel console, providing completely independent program and audition line outputs for simultaneous on-air work, rehearsal or production.

MIXING CHANNELS: Six studio-microphone channels, an identical announce-booth channel, and eight medium-level channels are provided—for a total of fifteen mixing channels. Each of these fifteen channels has an illuminated four-station interlocked pushbutton selector to expand the total number of inputs to sixty. This means that the same source may appear on two channels for cross-fading, or 60 different sources may be accommodated.

All channels contain an isolation transformer with 150/600 ohms on the primary. All channels also have a plug-in card receptacle to accept a medium level jumper card or plug-in microphone preamplifier. The 994-6549 preamplifier in the TV-15 will accept input levels up to -17 dBm without overload, and is provided as standard on microphone input channels 1 through 7. By purchasing additional preamplifiers, every channel can accommodate microphone inputs if desired. Each of the 60 inputs will mute any of the 4 studio speakers, as assigned by simple jumper connectors.

VERTICAL ATTENUATORS: High-quality vertical attenuators

are used, on $1\frac{1}{2}$ " spacing, for operating ease. Every attenuator, including microphone channels, has a cue position feeding the inbuilt cueing amplifier. A complete set of mylar transparencies with equipment nomenclature is provided for labeling all inputs and channels.

AUDIO-FOLLOW-VIDEO: Each input channel also has a relay socket wired, and relays can be easily added for audio-follow-video remote-controlled operation in large systems.

SUB-MASTERS OR DUAL-CHANNEL: The mixing bus of the TV-15 is split into seven channels on one bus, and eight channels on the other, to reduce bus loss and maintain satisfactory signal-to-noise ratios. These bus sections are then fed through 994-6549 booster amplifiers, thence to a combining pad and into the sub-master control.

Sub-masters can be combined and fed through a program amplifier or operated independently with the "A" bus feeding output line 1, and the "B" bus feeding a second program amplifier into output line 2. The sub-masters and following combining pad allow "A+B" operation for multiple microphone fading. Normal dual-channel operation may be used for regular programming or simultaneous rehearsals.

TWO MONITOR CHANNELS: Two separate eight-watt monitoring amplifiers allow selection from six sources, such as the main output line A or line B, sub-master channels A or B, or from two external sources. The control room and studio monitors operate independently from one another. The announce microphone is considered a booth source, thus the control room speaker remains unmuted. Muting is provided only for studio speakers in the TV-15.

Television Audio Control Console—TV-15

AMPLIFIERS: Only the preamplifiers, booster amplifier cards, and their associated power supply, are contained within the console cabinet. Program amplifiers, monitor amplifiers, and other power supplies are rack-mounted in a standard 19" shelf assembly near-by. A completely pre-wired and pre-formed interconnecting cable (25 ft.) is provided to interconnect the console proper with its associated rack-mounted components.

Gates modular equipment cabinetry provides a functional and attractive desk assembly for the TV-15, and also provides space for accessories such as: turntables, cartridge tape equipment, telco gear, etc. (Cabinets are optional.)

STYLING: The TV-15 styling is handsome and low silhouette. The lower panel contains vertical faders and input and channel selector switches. Input switches are illuminated, and a complete set of mylar transparencies with equipment nomenclature is provided for labeling all inputs and channels.

The top panel contains VU meters, auxiliary controls and switches for monitoring, sub-master assignment, master gain, etc.

A 5¼" high blank center panel is provided for use by the customer. Program equalizers, reverberation (echo) controls, remote control, etc., may be mounted in this area.

SPECIFICATIONS

INPUT CHANNELS: Total—15. Instantly convertible to microphone (−60 dBm) or medium level (−20 dBm) channels by insertion of preamplifier or shorting card. Factory supplied with preamps in channel 1 through channel 7, jumper cards in channel 8 through channel 15.

INPUT CIRCUITS: 60 maximum. Four into each of the 15 channels, with push-button selection of desired input. Each input may direct speaker muting with any of the four muting relays built into the console.

OUTPUT CHANNELS: 2 line outputs with switching facilities to instantly convert both "A" and "B" program busses to either separate output channels or to combine A+B into the "A" output channel only. 5 speaker outputs, one monitoring amplifier feeding a control room speaker (unmuted) only; the second monitoring amplifier feeding up to 4 studio speakers (with selective muting) through the factory supplied matching transformers. Individual monitor amplifier gain controls allow independent setting of levels.

SOURCE IMPEDANCE: 30/50-150/250 ohms on mic channels, 150/250-500/600 ohms on medium level channels. Balanced bridging an external monitor and air monitor inputs allows wide latitude of source impedances on these inputs.

LOAD IMPEDANCE: 600 ohms (may be modified to 150 ohms) on line output. 4-16 (8 ohms nominal) ohms total monitor load. Four matching transformers provided to allow paralleling up to four speakers off either monitor amplifier.

GAIN: 110 dB maximum, microphone to line. 70 dB maximum, medium-level inputs to line.

RESPONSE: ±1.0 dB, 30 to 15,000 Hz program circuits. ±1.5 dB, 30 to 15,000 Hz, monitor circuits.

DISTORTION: 1% maximum, 30 to 15,000 Hz, program circuits @ +18 dBm output; monitor circuits @ +38 dBm output.

NOISE: 73 dB below −50 dBm input and +18 dBm output from 30 to 15,000 Hz on microphone inputs (−123 dBm relative input noise). 75 dB below −10 dBm input and +18 dBm output from 30 to 15,000 Hz on medium level inputs.

CROSSTALK: Less than 5 dB out of noise at normal control settings.

AUDIO-FOLLOW-VIDEO RELAYS: 15 relay sockets provided with jumpers that can be removed to insert relays in every input channel, if desired.

ISOLATION TRANSFORMERS: 15 on the input channels to provide balanced inputs on every channel, with or without preamps.

CUE POSITION: On every channel attenuator and connected into cue amplifier and speaker.

SUB-MASTER CONTROLS: Provided to permit gain control of "A" bus separate from "B" bus when in the A+B mode. In the individual output mode, the sub-masters can be used to ride level on the two output lines. Master controls are used more for range controls than operating controls.

VU METERS: 2—one connected permanently to Program Line Out, the other switchable to six points.

INDIVIDUAL MONITOR INPUT SELECTORS: Connect either monitoring amplifier to: Sub A, Sub B, Line A, Line B, Ext 1 or Ext 2 positions of front panel switches.

INTERCONNECTING CABLES: Terminated in plugs and receptacles furnished with console to quickly connect the remotely-located, shelf-mounted program amplifiers, monitoring amplifiers and power supplies. 25-foot inter-connecting cable allows flexibility of location.

FINISH: Cabinet color beige-gray.

SIZE: 31¼ in. wide, 27 in. deep, 12½ in. above desk top. (Requires desk cut-out 29" wide, 22¾" front-to-back, 4" deep.)

SHIPPING DATA: Packed weight, domestic, 400 pounds.

ORDERING INFORMATION

TV-15 Audio Control Console. Complete with housing, 7 mic preamplifiers, 4 booster amplifiers, 2 program amplifiers, 2 monitor amplifiers, 1 cue amplifier, 1 power supply 30V, 1 power supply 33V, 1 power supply 24V, shelf assembly, and 25 feet of inter-connecting cable -----

994-6610

Dual Programming Eight Channel Transistor Console

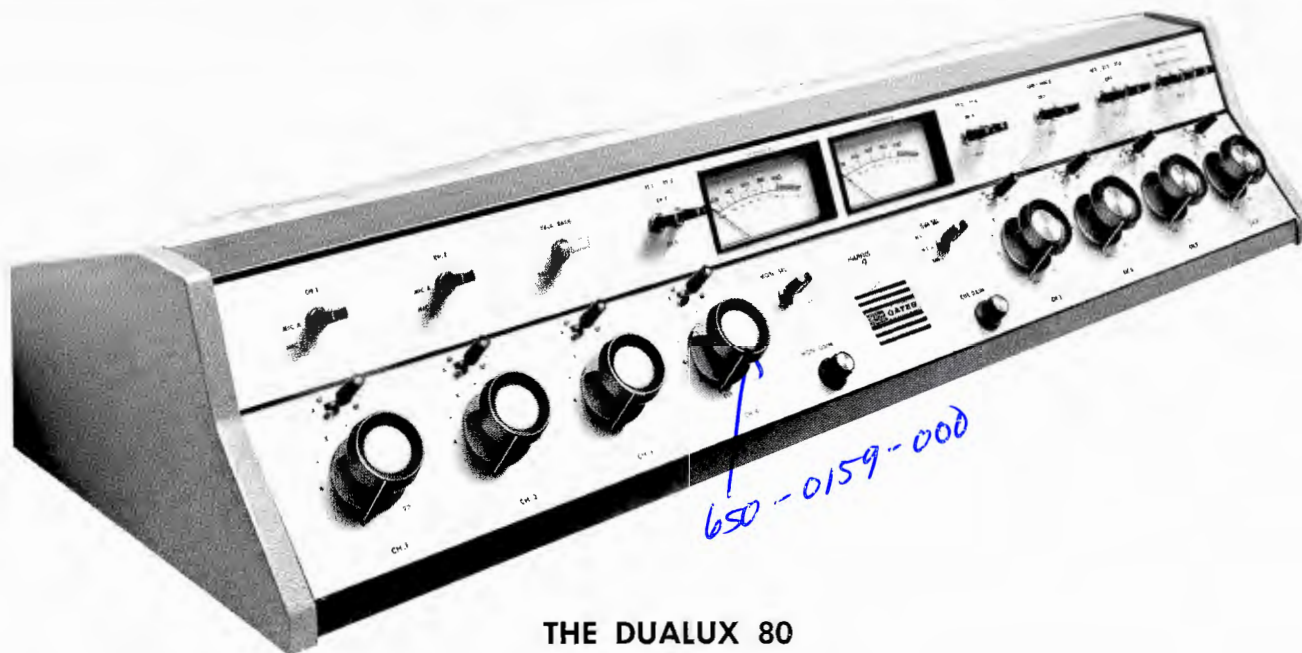

THE DUALUX 80

One of the most versatile monaural audio consoles on the market today, the solid-state Dualux 80 features dual programming channels, a wide choice of inputs and excellent audio.

The extensive capabilities of the Dualux 80 make this console ideal for the broadcaster who wishes to control AM and monaural FM from the same control point, or who wants a second programming channel for recording, network feed, etc.

INPUTS: Eighteen inputs can be fed into eight mixing channels. These include five microphones, four turntables, five tapes (cartridge or reel-to-reel), three remotes and network.

MIXING CHANNELS: Channels 1 and 2 are to be used with low-impedance, broadcast-type microphones, and are equipped with low-noise preamplifiers. Each of these channels may select from two different input signals by means of a front-panel switch.

Channel 3 is equipped with a low-noise preamplifier and is also intended for use with a low-impedance, broadcast-type microphone. This channel, with a single input, functions as part of the talkback system, and is assigned to the control room.

Channels 4, 5, 6 and 7 are all medium level inputs and may be used with turntable preamplifiers, cartridge machines, or reel-to-reel machines. All channels have input transformers whose center taps may or may not be grounded, depending upon the given installation. They are shipped with the center taps ungrounded. A nominal level of -20 dBm or $+4$ dBm at 600 ohms is required. Input pads for the $+4$ dBm are provided on the various tape inputs.

Channel 8 is specifically designed to function with network and remote lines as sources. Various combinations of pre-

view, talkback, and program cue are possible using the front panel switches. A nominal input of at least -20 dBm at 600 ohms is required.

All eight channels may be switched to either the program or audition positions to permit independent monitoring of any of the incoming sources without disturbing programming. Channels 4 through 8 have a cue position associated with the channel attenuator which provides signal to the amplified cue system. This signal can be monitored by an internal speaker or external headphones. On Channels 1 and 2, the center position of the program audition key switch provides a microphone cue signal to the cue selector switch. On Channel 3 this position is used with the control room microphone for talkback.

SPEAKER MUTING: A protective system of warning lights and relay speaker muting is provided to prevent acoustic feedback and broadcasting of cue signal when "live" microphones are nearby.

UNSURPASSED AUDIO: Audio response is excellent, and distortion is at an extremely low level. One of the big reasons for this is the use of Gates' advanced all solid-state plug-in amplifiers. The Dualux 80 provides first-class audio quality for AM, FM, TV broadcasting, and recording studios.

MODULAR CONSTRUCTION: Each amplifier is mounted on a separate printed circuit board, which in turn mounts in a card-rack holder. These modules are as follows: three pre-amplifier modules, three booster amplifier modules, three output amplifier modules and two power supply regulator modules. Silicon transistors are used to assure the meeting of performance specifications and assure optimum console operation over a wide ambient temperature range. All amplifiers

Dual Programming Eight Channel Transistor Console—Dualux 80

are completely accessible when the top of the console is opened, simplifying maintenance.

INTERCHANGEABILITY: Program, cueing, and monitor amplifiers all have the same electrical design and construction, and are completely interchangeable. As a result, two backup program amplifiers are provided as part of the console.

HIGH LEVEL, HIGH FIDELITY OUTPUT: The dynamic range of the preamplifiers will accommodate microphone levels to -17 dBm without overload or distortion. The program amplifiers deliver $+32$ dBm output after the 6 dB pad, and the

monitor amplifiers $+40$ dBm, all with wide frequency response, low distortion and low noise.

STYLING: The Dualux 80 is handsomely styled with satin-anodized aluminum front panels, and rich beige-gray Pebble-Tex cabinet. The modern design will complement any control room decor.

"ADD-ON" UNITS: "Add-on" or sub-mixer units are available with four extra channels each to increase the flexibility of the Dualux 80. These sub-mixer units may be added at either or both ends of the console, and are described on Page 83.

SPECIFICATIONS

OPERATING MODE: Dual channel mono with audition positions.

MIXING CHANNELS: Total—8. Three microphones, two turntables, two tapes and one remote/network.

INPUT CIRCUITS: Total—18. Five microphones, four turntables, two tape machines, three cartridge tape machines, three remote lines, one network.

AMPLIFIERS AND POWER SUPPLIES PROVIDED: Three preamplifiers, three boosters, four output modules—program, monitor and cue (interchangeable as supplied). Two power supply modules.

OUTPUT CIRCUITS: Two program outputs @ $+8$ VU, one monitor speaker output unmuted for lobby, three monitor speakers muted, two headphone outputs.

MONITOR OUTPUT: $+40$ dBm @ 8 ohm minimum load. Multi-speaker operation should use high impedance speakers (32-45 ohm) or accessory speaker-matching transformer (48/8 ohm) for minimum load of 8 ohms.

GAIN: Microphone to line: 100 dB, ± 2 dB. Medium level to line: 60 dB/36 dB, ± 2 dB.

IMPEDANCES: Microphones: 150/250 ohms balanced. Turntable/tape: 600 ohms balanced. Monitor output: 8 ohms nominal unbalanced. Program output: 600/150 ohms balanced.

RESPONSE: Program: ± 1.0 dB, 20 Hz to 20 kHz. Monitor: ± 1.0 dB, 30 Hz to 15 kHz.

DISTORTION: Program circuits: 0.5% maximum, 20 Hz to 20 kHz @ $+18$ dBm. Monitor circuits: 1.0% maximum, 30 Hz to 15 kHz @ $+40$ dBm (10 watts).

NOISE: Program circuits: 75 dB below $+18$ dBm with -50 dBm input (-125 dBm equivalent input noise, measured 20 Hz to 20 kHz). Medium level inputs: (program) 80 dB below $+18$ dBm with -10 dBm input. Monitor circuits: signal/noise = 80 dB below $+40$ dBm output.

POWER: 117/234 volts, 50/60 Hz, single-phase. Consumption: 60 watts, maximum.

FINISH: Satin-anodized aluminum panels with lettering in black. Cabinet color—beige-gray Pebble-Tex.

MECHANICAL SIZE: 45 inches wide, 15½ inches deep, 7¾ inches high. Weight: 96 pounds.

SHIPPING DATA: Packed weight: domestic, 190 lbs.; export, 230 lbs. Cubage: 17.5 cubic feet.

ORDERING INFORMATION

Dualux 80, dual programming eight-channel console, complete with three preamplifiers; three boosters; four program A/program B/monitor/cue output modules (interchangeable) and two power supplies.....994-6866
Speaker matching transformer.....478-0291

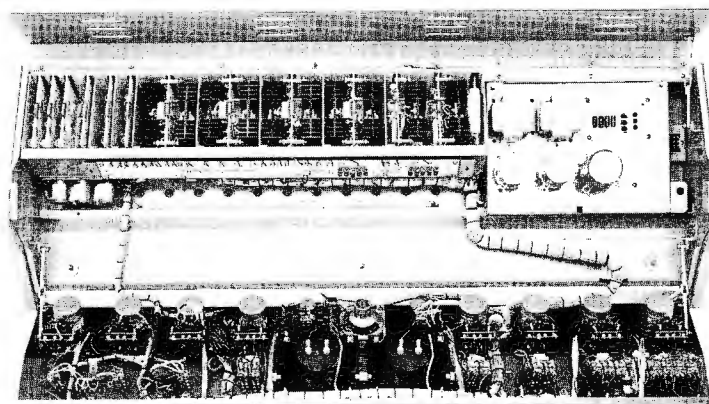

Hinged cabinet cover and front panel provide full accessibility to all components of the Dualux 80.

Dual Programming Eight Channel Transistor Console—Dualux 80

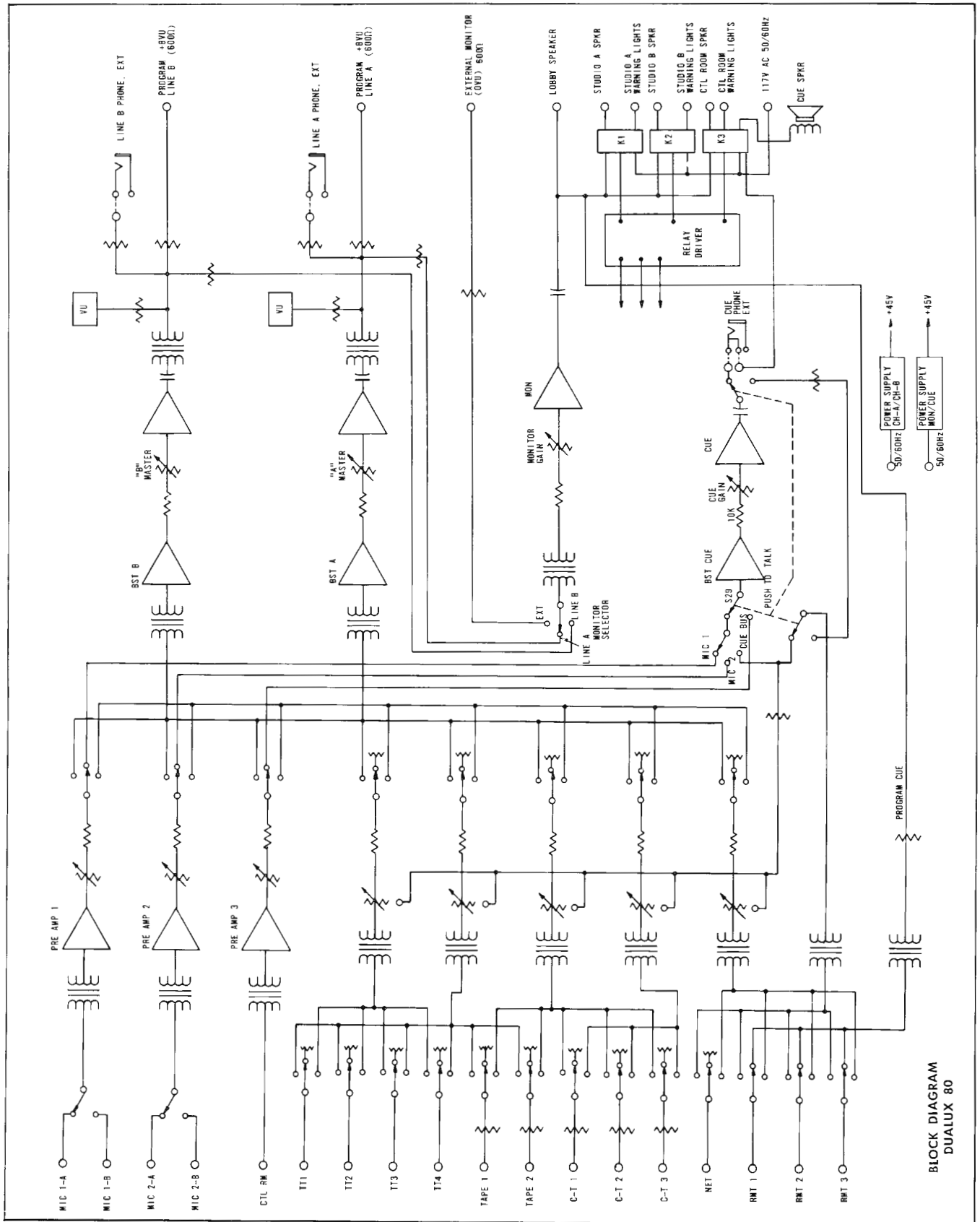

BLOCK DIAGRAM
DUALUX 80

Four Channel Side Cabinet

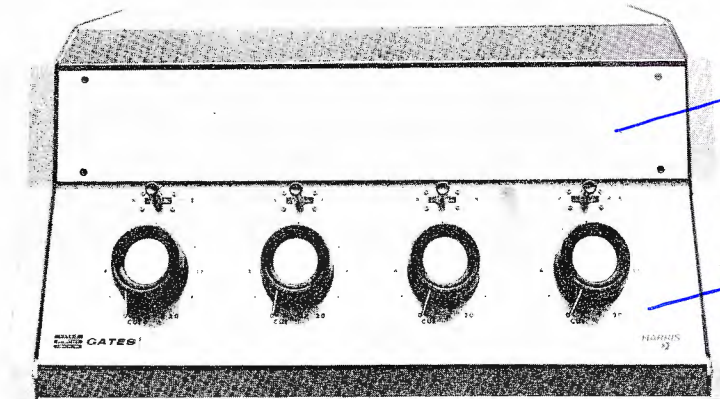

"ADD-ON" UNIT FOR DUALUX 80, GATESWAY 80 AND OTHER GATES CONSOLES

Gates' four channel side cabinet is a high quality monophonic console accessory designed to enable users of consoles to increase the number of available input channels. The side cabinet may be installed at either end of the main console, or at an angle to the console. If eight additional input channels are required, side cabinets may be installed at both ends of the main console.

Uniformity of appearance is achieved with external styling identical to the Gatesway 80 or Dualux 80 consoles. Ease of service is retained by the use of plug-in circuit modules.

The basic monophonic side cabinet is equipped with four

medium level inputs followed by two booster amplifiers, one each for a program output and an audition output. In addition, separate cue outputs for each channel are provided.

Any channel of the side cabinet may be converted to a microphone input by substituting the optional set of plug-in modules. Muting control circuitry is provided and assignments may be made within the side cabinet.

DC voltage for operation of the side cabinet circuits is obtained from the main console via the connecting cable. The upper front panel overlay is left blank to allow custom modification.

SPECIFICATIONS

NOTE: With respect to Response, Distortion, Noise, and Maximum Gain, the electrical performance is measured with the side cabinet connected to, and drawing power from, the Dualux 80 or Gatesway 80 consoles. Measurements are made at the appropriate console output using the side cabinet input facilities. Thus connected, the system will meet the specifications noted below.

INPUT IMPEDANCE: Medium level channels: 600 ohms, balanced.

MICROPHONE IMPEDANCE: Microphone channels: 150 ohms, balanced; 37.5 ohms, no C. T.

FREQUENCY RESPONSE: Program circuit: ± 1 dB maximum from 20 to 20,000 Hz at +24 dBm output level. Monitor circuit: ± 1 dB maximum from 30 to 15,000 Hz at +40 dBm (10 watts) output level.

HARMONIC DISTORTION: Program circuit: 0.5% maximum from 20 to 20,000 Hz at +18 dBm output level. Monitor circuit: 1.0% maximum from 30 to 15,000 Hz at +40 dBm output level.

RELATIVE INPUT NOISE: Microphone channels: -125 dBm from 20 to 20,000 Hz.

NOISE LEVEL: Medium level channels: 80 dB below -10 dBm input and +18 dBm output levels from 20 to 20,000 Hz.

MAXIMUM GAIN: Microphone input to line output: 100 dB, ± 2 dB. Medium level input to line output: 60 dB, ± 2 dB.

CROSSTALK: Less than 10 dB above noise level from 30 to 15,000 Hz at normal console gain settings.

TRANSIENTS: Degradation of noise levels will not exceed 15 dB from 30 to 15,000 Hz when any side cabinet switch is operated.

POWER REQUIREMENT: 13.4 mA at nominal signal level. 34.7 mA @ 45 VDC with 4 preamplifiers and 2 booster amplifiers.

FINISH: Satin anodized aluminum panels with lettering in black. Cabinet color . . . beige-gray Pebble-Tex.

MECHANICAL SIZE: 19½" wide, 15½" deep, 7¼" high. Net weight: 42 lbs.

SHIPPING DATA: Packed weight: domestic, 100 lbs.; export, 140 lbs. Cubage: 10 cubic feet.

ORDERING INFORMATION

| | | |
|---|-------|----------|
| Four channel side cabinet | ----- | 994-6868 |
| Low-level transformer card (optional) | ----- | 994-7052 |
| Microphone preamplifier card (optional) | ----- | 994-6911 |

Eight Channel Monophonic Transistor Console

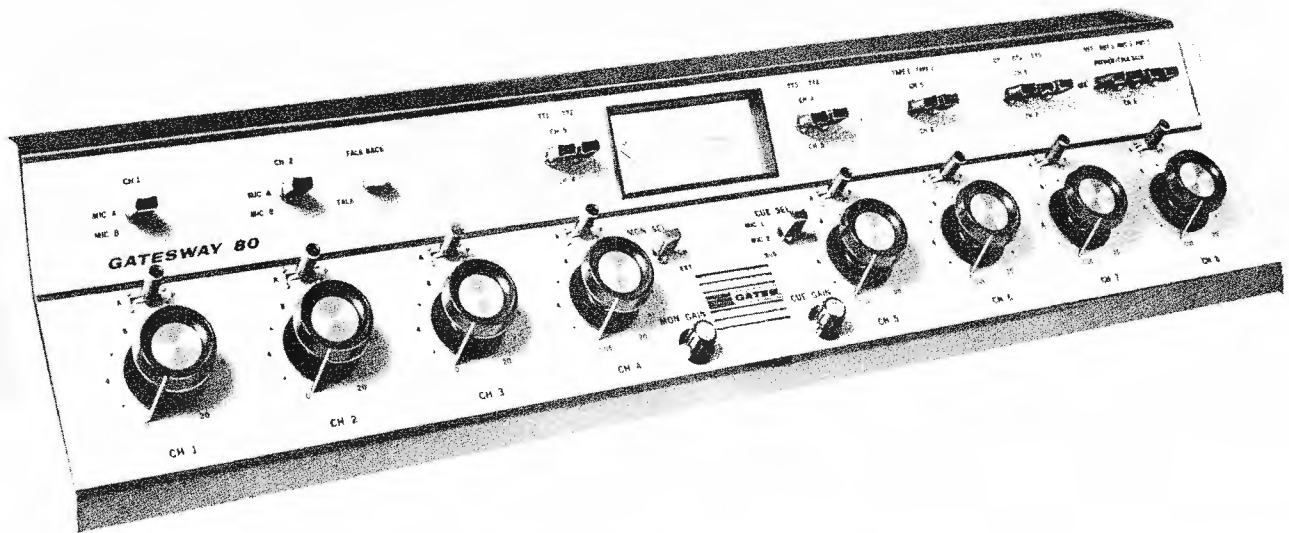

THE GATESWAY 80

The Gateway 80 is the third generation of the world-famous Gateway consoles, and combines excellent audio, a wide choice of inputs, and operating ease in a unit which is attractively and functionally styled.

This is a high-quality monophonic console which provides all necessary studio functions and facilities for the typical AM, FM, or TV station that broadcasts monophonic programs exclusively.

INPUTS: The flexibility of the Gateway 80 is in its wide choice of inputs. Eighteen inputs can be switched into eight mixing channels. These include five microphones, four turntables, five tapes (cartridge or reel-to-reel), three remotes and network.

MIXING CHANNELS: Channels 1 and 2 are equipped with low-noise preamplifiers, and are to be used with low-impedance, broadcast-type microphones. Each of these channels may select from two different input signals by means of a front-panel switch.

Channel 3 is equipped with a low-noise preamplifier and is also intended for use with a low-impedance, broadcast-type microphone. This channel has a single input and is assigned to the control room since this microphone functions as part of the talkback system.

Channels 4, 5, 6 and 7 are all medium level inputs and may be used with turntable preamplifiers, reel-to-reel tape, or cartridge machines. All channels have input transformers whose center taps may or may not be grounded, depending upon the given installation. They are shipped with the center taps ungrounded. A nominal level of -20 dBm or $+4$ dBm at 600 ohms is required. Input pads for the $+4$ dBm are provided on the various tape inputs.

Channel 8 is specifically designed to function with network and remote lines as sources. Various combinations of preview, talkback, and program cue are possible using the front panel switches. A nominal input of at least -20 dBm at 600 ohms is required.

All eight channels may be switched to either the program or audition positions to permit independent monitoring of any of the incoming sources without disturbing programming. Channels 4 through 8 have a cue position associated with the channel attenuator which provides signal to the amplified cue system. This signal can be monitored by an internal speaker or external headphones. On Channels 1 and 2, the center position of the program audition key switch provides a microphone cue signal to the cue selector switch. On Channel 3 this position is used with the control room microphone for talkback.

SPEAKER MUTING: A protective system of warning lights and relay speaker muting is provided to prevent acoustic feedback and broadcasting of cue signal when "live" microphones are nearby.

UNSURPASSED AUDIO: Gates' advanced all solid-state plug-in amplifiers are one of the many reasons for the excellence of the Gateway 80. Audio response is excellent, and distortion is at an extremely low level. The Gateway 80 provides first-class audio quality for AM, FM, TV broadcasting, and recording studios.

MODULAR CONSTRUCTION: Each amplifier is mounted on a separate printed circuit board, which in turn mounts in a card-rack holder. These modules are as follows: three pre-amplifier modules, three booster amplifier modules, three output amplifier modules and two power supply regulator mod-

Eight Channel Monophonic Transistor Console—Gateway 80

ules. Silicon transistors are used to assure the meeting of performance specifications and assure optimum console operation over a wide ambient temperature range. All amplifiers are completely accessible when the top of the console is opened, simplifying maintenance.

INTERCHANGEABILITY: Program, cueing, and monitor amplifiers all have the same electrical design and construction, and are completely interchangeable. As a result, two backup program amplifiers are provided as part of the console.

HIGH LEVEL, HIGH FIDELITY OUTPUT: The dynamic range of the preamplifiers will accommodate microphone levels to -17 dBm without overload or distortion. The program amplifiers deliver $+32$ dBm output after the 6 dB pad, and the monitor amplifiers $+40$ dBm, all with wide frequency response, low distortion and low noise.

STYLING: The Gateway 80 is handsomely styled with satin-anodized aluminum front panels, and rich beige-gray Pebble-Tex cabinet. The modern design will complement any control room decor.

"ADD-ON" UNITS: "Add-on" or sub-mixer units are available with four extra channels each to increase the capabilities of the Gateway 80. These sub-mixer units may be added at either or both ends of the console, and are described on Page 83.

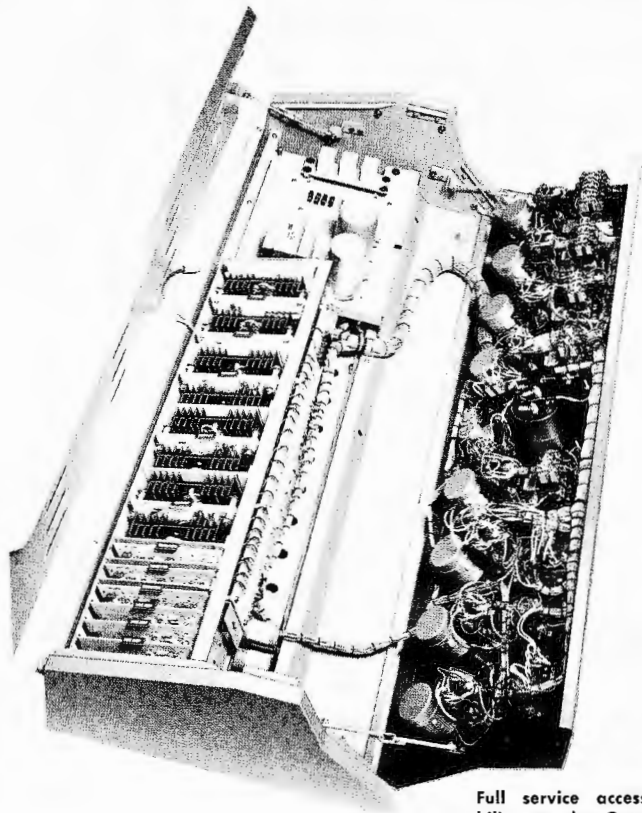

Full service accessibility to the Gateway 80 is through the hinged cabinet cover and panel.

SPECIFICATIONS

OPERATING MODE: Single channel mono with audition positions.

MIXING CHANNELS: Total—8. Three microphones, two turntables, two tapes and one remote/network.

INPUT CIRCUITS: Total—18. Five microphones, four turntables, two tape machines, three cartridge tape machines, three remote lines, one network.

AMPLIFIERS AND POWER SUPPLIES PROVIDED: Three preamplifiers, three boosters, three output modules—program, monitor and cue (interchangeable as supplied). Two power supply modules.

OUTPUT CIRCUITS: One program output @ $+8$ VU, one monitor speaker output unmuted for lobby, three monitor speakers muted, two headphone outputs.

MONITOR OUTPUT: $+40$ dBm @ 8 ohm minimum load. Multi-speaker operation should use high-impedance speakers (32-45 ohms) or accessory speaker matching transformer (48/8 ohms) for minimum load of 8 ohms.

GAIN: Microphone to line: 100 dB, ± 2 dB. Medium level to line: 60 dB, ± 2 dB.

IMPEDANCES: Microphones: 150/250 ohms balanced. Turntable/tape: 600 ohms balanced. Network/remote: 600 ohms balanced. Monitor output: 8 ohms nominal unbalanced. Program output: 600/150 ohms balanced.

RESPONSE: Program: ± 1.0 dB, 20 Hz to 20 kHz. Monitor: ± 1.0 dB, 30 Hz to 15 kHz

DISTORTION: Program circuits: 0.5% maximum, 20 Hz to 20 kHz @ $+18$ dBm. Monitor circuits: 1.0% maximum, 30 Hz to 15 kHz @ $+40$ dBm (10 watts).

NOISE: Program circuits: 75 dB below $+18$ dBm with -50 dBm input (-125 dBm equivalent input noise, measured 20 Hz to 20 kHz). Medium level inputs: (program) 80 dB below $+18$ dBm with -10 dBm input. Monitor circuits: signal/noise = 80 dB below $+40$ dBm output.

FINISH: Satin-anodized aluminum panels with lettering in black. Cabinet color . . . beige-gray Pebble-Tex.

POWER: 117/234 volts, 50/60 Hz, single-phase. Consumption: 60 watts, maximum.

MECHANICAL SIZE: 39 inches wide, 15 $\frac{3}{4}$ inches deep, 7 $\frac{3}{4}$ inches high. Weight: 88 lbs.

SHIPPING DATA: Packed weight: domestic, 190 lbs; expart, 230 lbs. Cubage: 17.5 cubic feet.

ORDERING INFORMATION

Gateway 80, eight channel console, complete with three preamplifiers; three boosters; three program/monitor/cue output modules (interchangeable and two power supplies)-----994-6699
Speaker Matching Transformer-----478-0291

Eight Channel Monophonic Transistor Console—Gateway 80

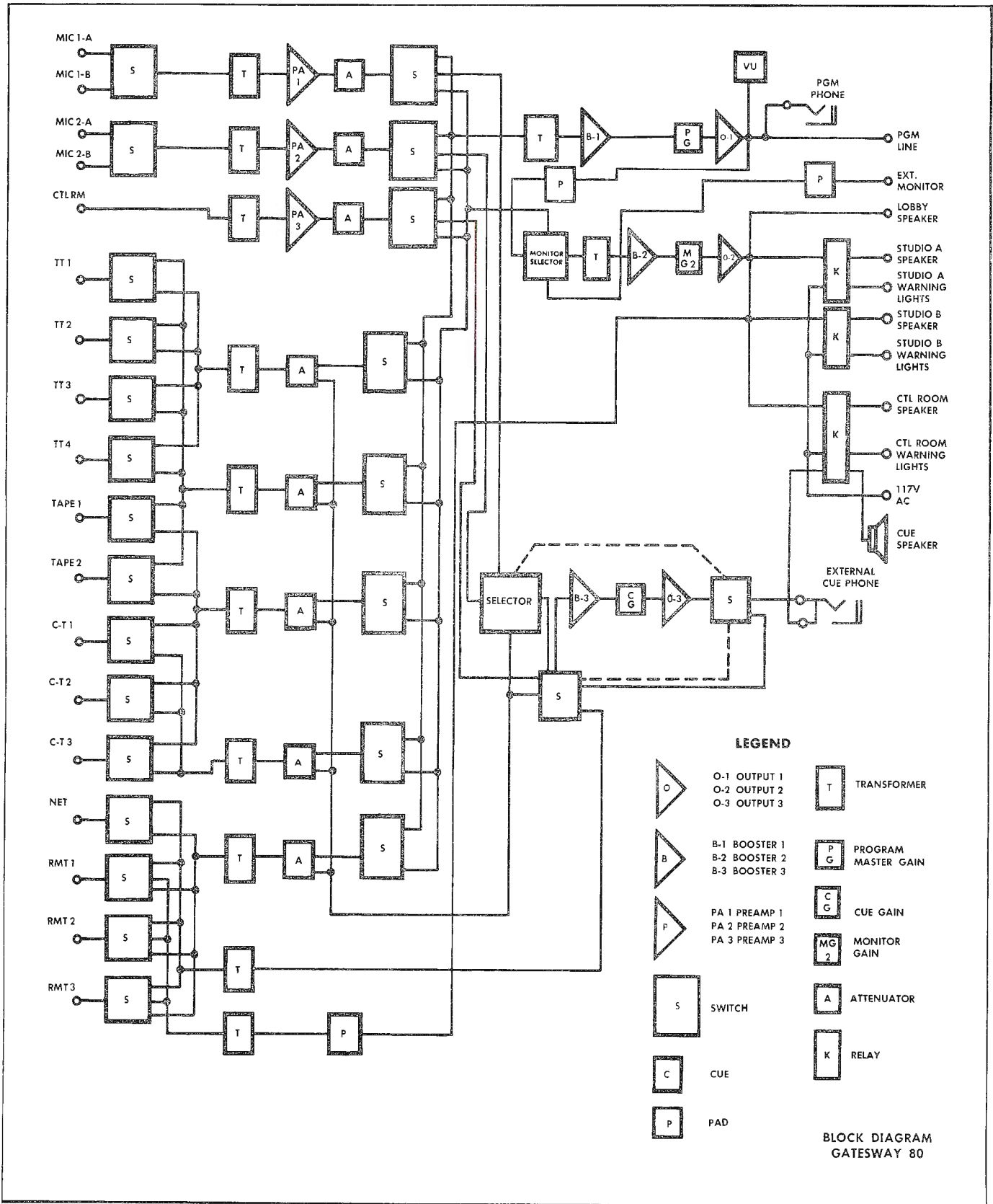

Eight Channel Monophonic Transistor Console

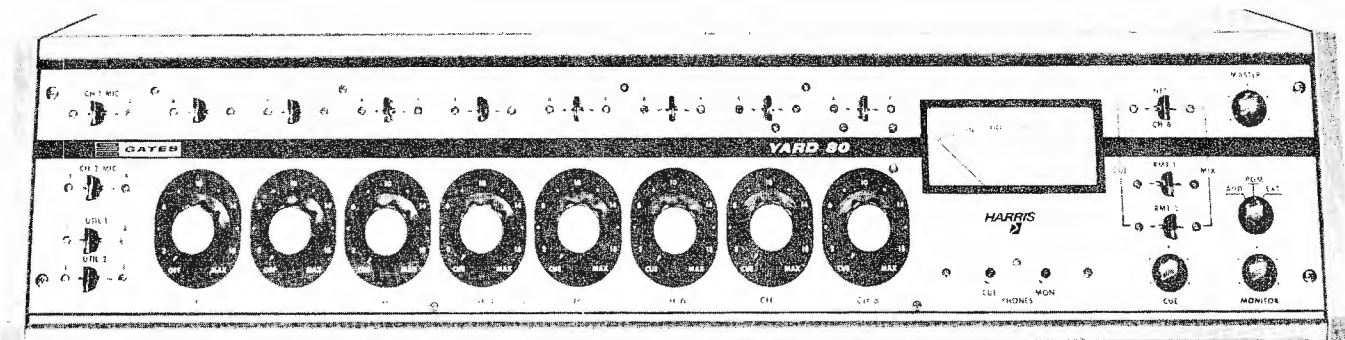

THE YARD 80

Successor to the famous Yard II console, the new Yard 80 offers great versatility with the reliability of total solid-state design. Just over a yard wide, Gates' Yard 80 console offers 12 inputs into 8 mixing channels. It is ideal as a full-control facility for smaller AM and FM monophonic stations, and a perfect sub-master control or production console in larger operations. The new low silhouette styling is extremely attractive and fits in with any studio decor.

Functionally arranged, the eight mixing channels are in the center of the board, with the meter to the right, near the Master, Monitor, and Cue gain controls. Preamplifiers used on microphone channels 1 and 2 may select from two low-impedance microphones to each channel. Five medium-level channels can be used with any sources, such as turntables, tape recorders, etc. The eighth channel is specifically designed for use with network and two remote sources, and separate front-panel switches provide selection of any of these sources.

INDEPENDENT CHANNEL MONITORING AND RECORDING: Any of the 8 input channels may be switched to either the program or audition position to permit independent monitoring or recording of any incoming sources without disturbing programming.

HIGH FIDELITY PERFORMANCE: Frequency response of the Yard 80 is uniform within ± 1 dB from 30 to 15,000 Hz. Noise is better than 73 dB below normal output with crosstalk below the noise at normal levels and control settings. Distortion is less than 0.75% from 30 to 15,000 Hz at a +18 dBm output.

LOW-SILHOUETTE STYLING: Only 8¼ inches high, the Yard 80 offers an excellent over-the-top view, especially good for television operations.

ACCESSIBILITY: All components can be quickly reached through the hinged cover. In addition, the entire console is hinged at the rear for complete access to the underside of the cabinet and rear of P-C circuitry.

INPUTS: There are four microphones, five medium-level inputs, and three external-line inputs. The cue bus is connected to mixers 3 through 8 to provide rapid cueing on all six channels.

CUE AMPLIFIER: The built-in cue speaker in the top of the console provides cue from channels 3 through 8 to either the speaker built into the console or through the separate cue headphone jack.

BOOSTER AMPLIFIER: A monitor booster amplifier is provided as standard equipment to allow switching the monitor amplifier from program to audition without changing level.

MUTING RELAYS: Two muting relays are supplied to operate warning lights as well as muting of the control room and studio speakers. A terminal strip on the console permits flexible selection of muting relay operation by simply changing jumper wires.

VU METER: A new four-inch, illuminated, 'B' scale VU meter with a modern, "flat" scale permits easier recognition for more accurate level measurement.

COLOR-CODED CONTROLS: Mixer knobs are supplied with various colored disc inserts to color code controls such as red for turntables, green for studio A, etc.

COMPACT AND LIGHTWEIGHT: The Yard 80 console is one of the most compact, full-facility consoles ever produced. It measures 38¼" wide, 8¼" high, and 13" deep—and weighs only 58 pounds.

Eight Channel Monophonic Transistor Console—Yard 80

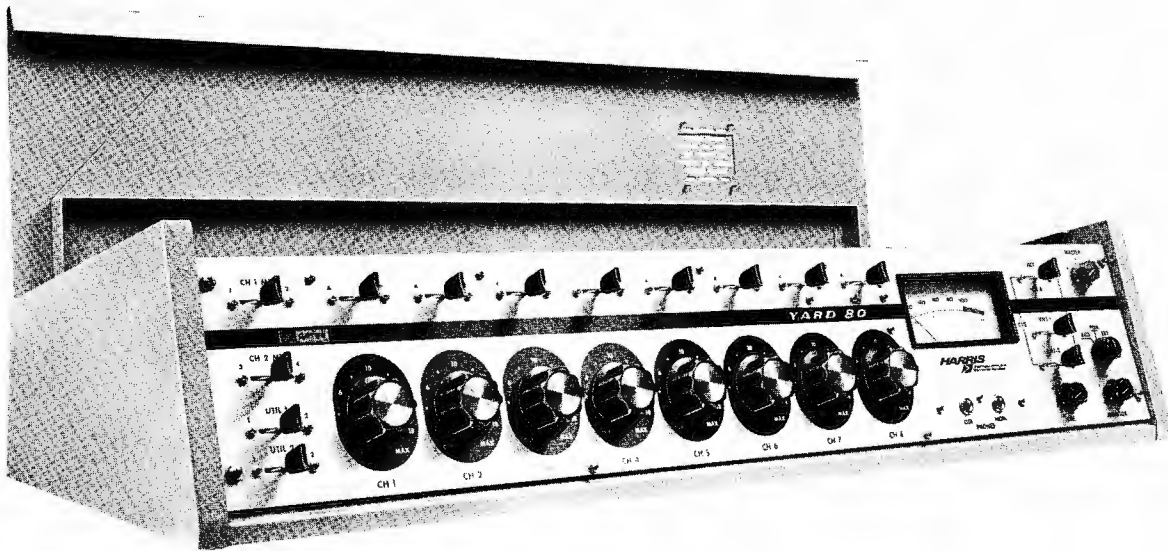

Complete access to all components is via the hinged cover of the Yard 80. All input and output connections can be made through the rear or the bottom of the console. Convenient knock-outs on the rear apron provide entry for wiring cables.

SPECIFICATIONS

GENERAL

MIXING CHANNELS: Total of eight, all monaural. Two microphone, five medium level, one network/remote.
AMPLIFIERS PROVIDED: Two preamplifiers, two booster amplifiers, one program amplifier, one monitor amplifier, and one cue amplifier.
OPERATING MODE: Monaural.
INPUT CIRCUITS: Four for microphones, two for turntables, two for tape, one utility, three for network/remote.
OUTPUT LINES: One program, two muted speaker, one non-muted speaker, one cue speaker (muted), two headphone (monitor and cue).

MICROPHONE (CH. 1 & 2) TO PROGRAM LINE OUT

MAXIMUM GAIN: 103 ± 2 dB.
FREQUENCY RESPONSE: ± 1 dB, 30 to 15,000 Hz.
DISTORTION: Less than 0.75%, 30 to 15,000 Hz, at +18 dBm output.
NOISE: More than 73 dB below +18 dBm output with -50 dBm input. Equivalent input noise is better than -123 dBm, 30 to 15,000 Hz.
CROSSTALK: Below noise level, with normal levels and control settings.
MICROPHONE IMPEDANCE: 30/50 or 150/250 ohms, balanced.

MEDIUM LEVEL (CH. 3-7) TO PROGRAM LINE OUT

MAXIMUM GAIN: 63 ± 2 dB.
FREQUENCY RESPONSE: ± 1 dB, 30 to 15,000 Hz.
DISTORTION: Less than 0.75%, 30 to 15,000 Hz at +18 dBm output.
NOISE: More than 73 dB below +18 dBm output with -10 dBm input, 30 to 15,000 Hz.
CROSSTALK: Below noise level, with normal levels and control settings.
INPUT IMPEDANCE: 150 ohms, unbalanced.

NETWORK/REMOTES (CH. 8) TO PROGRAM LINE OUT

MAXIMUM GAIN: 43 ± 2 dB.
FREQUENCY RESPONSE: ± 1 dB, 30-15,000 Hz.
DISTORTION: Less than 0.75%, 30 to 15,000 Hz at +18 dBm output.
NOISE: More than 73 dB below +18 dBm output with +10 dBm input, 30 to 15,000 Hz.
CROSSTALK: Below noise level, with normal levels and control settings.
INPUT IMPEDANCE: 600 ohms, balanced.

MONITOR CIRCUITS

*GAIN: Mic.—Pgm.—Mon. Out 124 ± 2 dB
Mic.—Aud.—Mon. Out 106 ± 2 dB
Med.—Aud.—Mon. Out 66 ± 2 dB
Ext. Mon.—Mon. Out 46 ± 2 dB

*Approximately 11 dB additional gain is available by shorting out the R37, 10,000 ohm resistor, connected between the Monitor Selector Switch and the Monitor Gain control.

FREQUENCY RESPONSE: ± 1 dB, 30 to 15,000 Hz.
DISTORTION: Less than 1%, 30 to 15,000 Hz at +40 dBm (10 watts) output.
NOISE: More than 73 dB below +40 dBm (10 watts) output, 30 to 15,000 Hz.
CROSSTALK: Below noise level, with normal levels and control settings.

POWER REQUIREMENTS

LINE VOLTAGE AND FREQUENCY: 117V (as shipped)/234V, 50/60 Hz.
POWER CONSUMPTION: 60 watts, maximum.

PHYSICAL SIZE

CONSOLE: 38 $\frac{1}{4}$ " wide, 13" deep, 8 $\frac{1}{4}$ " high.
CONSOLE WEIGHT: 58 lbs.
POWER TRANSFORMER: Approximately 6 $\frac{1}{2}$ " long \times 4" wide \times 3 $\frac{1}{2}$ " high.

ORDERING INFORMATION

Yard 80 Audio Console ----- 994-6996

HARRIS
GATES DIVISION
Harris-Intertype Corporation

Eight Channel Monophonic Transistor Console—Yard 80

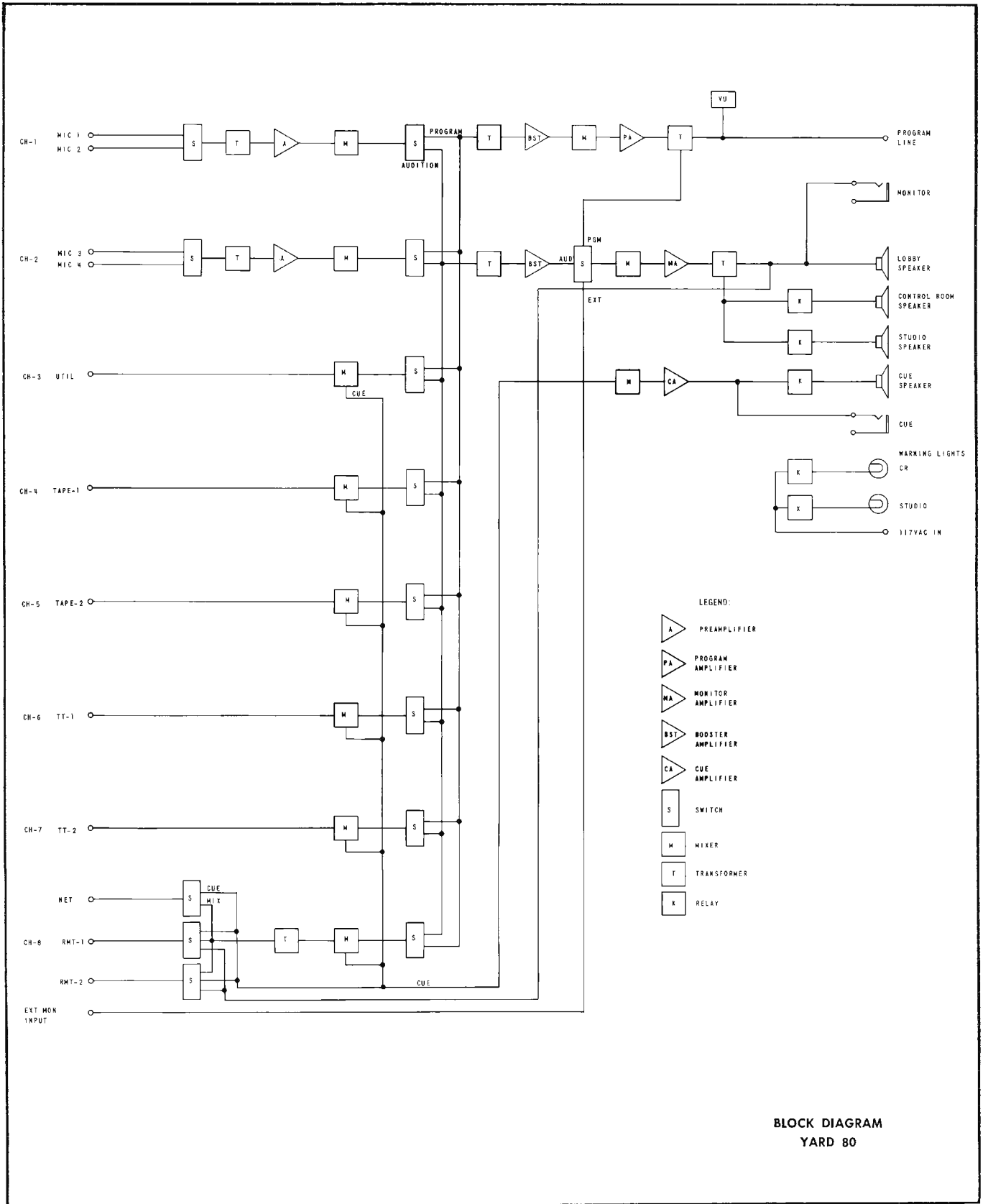

Eight Channel Stereo Transistor Console

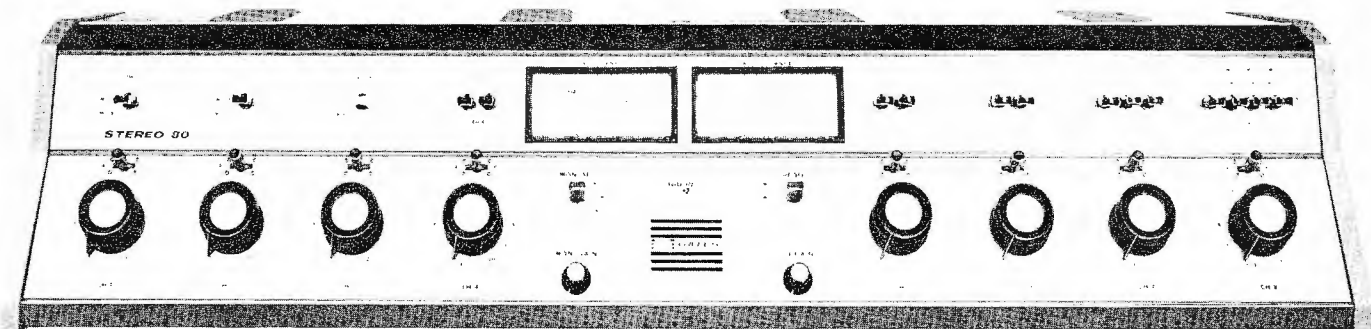

THE STEREO 80

Gates' Stereo 80 is designed for the FM stereo broadcaster who is looking for great flexibility and superb audio quality. The console features a wide choice of inputs and such outstanding performance specifications as: frequency response, 20 to 20,000 Hz with less than 1 dB variation; and distortion less than 0.5% at all frequencies.

INPUTS: Eighteen inputs may be switched into eight stereo mixing channels to provide a degree of flexibility that will satisfy virtually any stereo requirement. Inputs include five microphone, four turntables, five tapes (cartridge or reel-to-reel), three remotes and network.

MIXING CHANNELS: Channels 1 and 2 are equipped with low-noise preamplifiers, and are to be used with low-impedance, broadcast-type microphones. Each of these stereo channels may select from two different pairs of input signals by means of a front-panel switch.

Channel 3 is also equipped with low-noise preamplifiers, and is also intended for use with low-impedance, broadcast-type microphones. This channel has a stereo input and is assigned to the control room since these microphones function as part of the talkback system.

Channels 4, 5, 6 and 7 are all medium inputs and may be used with stereo turntable preamplifiers, reel-to-reel tape, or cartridge machines. All channels have input transformers whose center taps may or may not be grounded, depending upon the given installation. They are shipped with the center taps ungrounded. A nominal level of -20 dBm or $+4$ dBm at 600 ohms is required. Input pads for the $+4$ dBm are provided on the various tape inputs.

Channel 8 is specifically designed to function with network and remote lines as sources. Various combinations of preview, talkback, and program cue are possible using the front panel switches. A nominal input of at least -20 dBm at 600 ohms is required for remotes and -14 dBm for the network.

All eight channels may be switched to either the program or audition positions to permit independent monitoring of any of the incoming sources without disturbing programming.

Channels 4 through 8 have a cue position associated with the channel attenuator which provides signal to the amplified cue system. This signal can be monitored by an internal speaker or external headphones. On Channels 1 and 2, the center position of the program audition key switch provides a microphone cue signal to the cue selector switch. On Channel 3 this position is used with the control room microphones for talkback.

SPEAKER MUTING: A protective system of warning lights and relay speaker muting is provided to prevent acoustic feedback and broadcasting of cue signal when "live" microphones are nearby.

AMPLIFIERS: Each solid-state plug-in amplifier is mounted on a separate printed circuit board, which in turn mounts in a card-rack holder. These modules are as follows: six pre-amplifier modules, five booster amplifier modules, five output amplifier modules and one power supply regulator panel. Silicon transistors are used to assure the meeting of performance specifications and assure optimum console operation over a wide ambient temperature range. All amplifiers are completely accessible when the top of the console is opened, simplifying maintenance.

Program, cueing and monitor amplifiers all have the same electrical design and construction, and are completely interchangeable. As a result, two backup program amplifiers are provided as part of the console.

HIGH LEVEL, HIGH FIDELITY OUTPUT: The dynamic range of the preamplifiers will accommodate microphone levels to -17 dBm without overload or distortion. The program amplifiers deliver $+32$ dBm output and the monitor amplifiers $+40$ dBm, all with wide frequency response, low distortion and low noise.

STYLING: The Stereo 80 is handsomely styled with satin anodized aluminum front panels, and rich beige-gray Pebble-Tex cabinet. The modern design will complement any control room decor.

Eight Channel Stereo Transistor Console—Stereo 80

SPECIFICATIONS

OPERATING MODE: Single output stereo programming with audition positions.

MIXING CHANNELS: Total—8. Three for microphones, two for turntables, two for tapes and one for remote/network.

INPUT CIRCUITS: Total—18. Five stereo pairs of microphones, four turntables, two tape machines, three cartridge tape machines, three remote lines and one mono network.

AMPLIFIERS AND POWER SUPPLIES PROVIDED: Six preamplifiers, five boosters, five output modules—program, monitor and cue (interchangeable as supplied). One rack-mount power supply panel.

OUTPUT CIRCUITS: One stereo program output @ +8 VU, one monitor speaker pair unmuted for lobby, three monitor speaker pairs muted, one mono and one stereo headphone output.

MONITOR OUTPUTS: +40 dBm @ 8 ohm minimum load. Multi-speaker operation should use high impedance speakers (32-45 ohm) or accessory speaker-matching transformer (48/8 ohm) for minimum load of 8 ohms.

GAIN: Microphone to line: 100 dB, ± 2 dB. Medium level to line: 60 dB/36 dB, ± 2 dB.

IMPEDANCES: Microphones: 150/250 ohms balanced. Turntable/tape: 600

ohms balanced. Network/remote: 600 ohms balanced. Monitor output: 8 ohms nominal unbalanced. Program output: 600/150 ohms balanced.

RESPONSE: Program: ± 1.0 dB, 20 Hz to 20 kHz. Monitor: ± 1.0 dB, 30 Hz to 15 kHz.

DISTORTION: Program circuits: 0.5% maximum, 20 Hz to 20 kHz @ +18 dBm. Monitor circuits: 1.0% maximum, 30 Hz to 15 kHz @ +40 dBm (10 watts).

NOISE: Program circuits: 75 dB below +18 dBm with -50 dBm input (-125 dBm equivalent input noise, measured 20 Hz to 20 kHz). Medium level inputs: (program) 80 dB below +18 dBm with -10 dBm input. Monitor circuits: signal/noise = 80 dB below +40 dBm output.

FINISH: Satin anodized aluminum panels with lettering in black. Cabinet color . . . beige-gray Pebble-Tex.

POWER: 117/234 volts, 50/60 Hz, single-phase. Consumption: 120 watts maximum.

MECHANICAL SIZE: (Console) 45" wide, 15½" deep, 7¾" high. Weight: 105 lbs. (Power supply panel) 19" wide, 7¾" deep, 7" high. Weight: 21 lbs.

SHIPPING DATA: Packed weight: domestic, 210 lbs.; export, 250 lbs. Cubage: 19 cubic feet.

ORDERING INFORMATION

Stereo 80 eight channel stereo console, complete with six preamplifiers; five boosters; five program/monitor/cue output modules (interchangeable) and one power supply panel.....994-6867
Speaker matching transformer.....478-0291

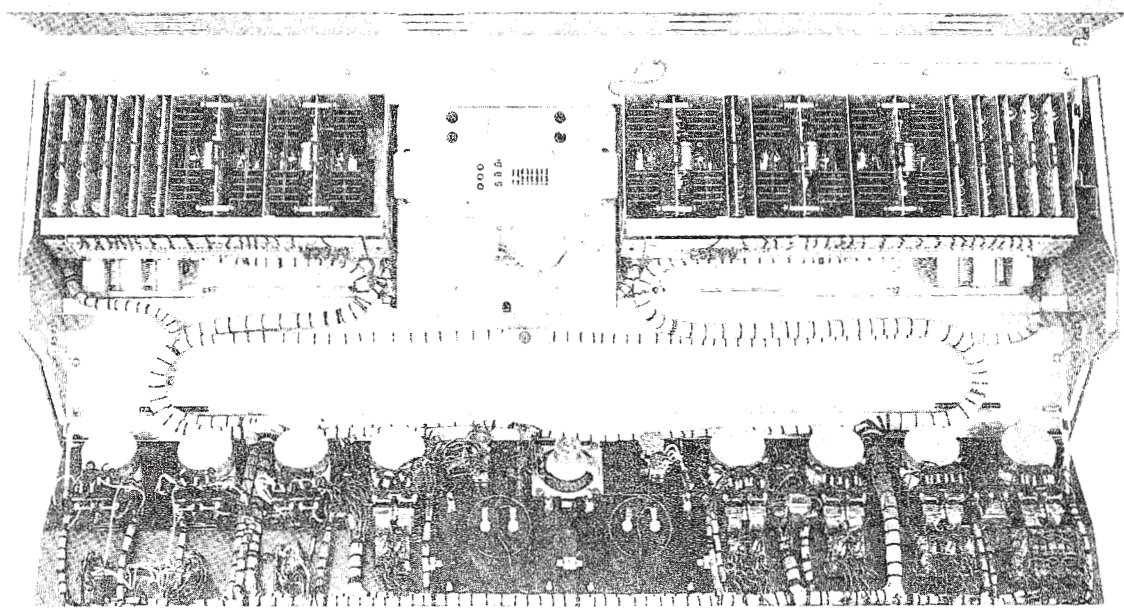

The hinged top of the Stereo 80 raises and the front panel lowers to provide easy access to all console components.

Five Channel Stereo Transistor Console

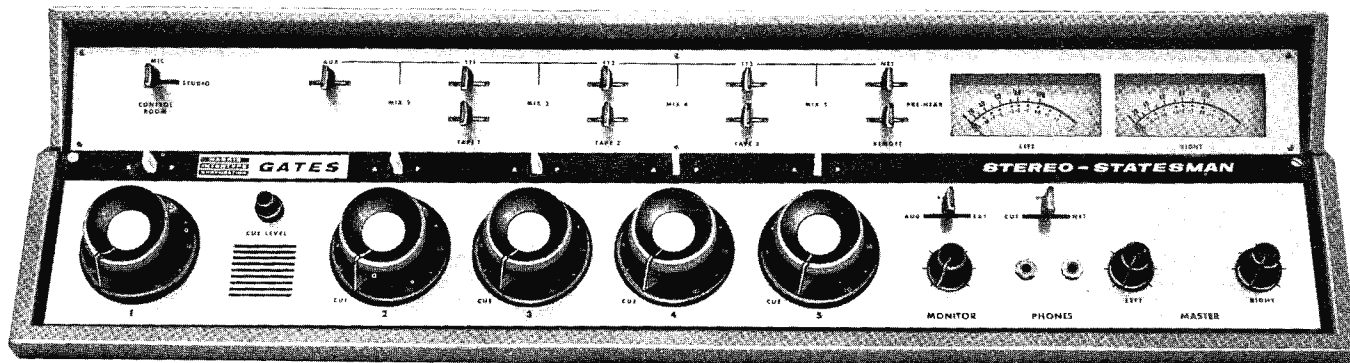

THE STEREO STATESMAN

Designed and built to provide the soundest sound for FM broadcasting, the completely transistorized Stereo Statesman console is equally at home in the studio of the small market broadcaster, or with the large, metropolitan broadcaster as a production or secondary control board.

The performance figures of this console are at the quality level which builds and holds listeners. Frequency response is 20 to 20,000 Hz with less than 1 dB variation. Distortion is less than 0.5% at all frequencies.

Other important features include: Full logic audio switching; all solid state modular amplifiers with printed circuit boards; two monitor amplifiers; rugged program keys; and Gates' exclusive control knobs.

VERSATILE INPUT SWITCHING: Eleven inputs may be switched into the five stereo mixing channels in a manner that satisfies virtually any stereo programming requirement. These inputs can include: two stereo microphone pairs; three stereo turntables; three stereo tape reproducers; one remote; one network and one auxiliary stereo source.

MICROPHONE CHANNEL: Two stereo pairs of microphones may be selected into channel 1. One position is designated "Control Room" and the other position "Studio". Muting is automatically transferred when key is operated.

MEDIUM LEVEL CHANNELS: Channels 2, 3, 4 and 5 may be used for turntables, tape or other medium level inputs. Three tapes, three turntables and one auxiliary source may be switched into these four channels. Each tape and turntable input is switchable to either of two mixers, with tab switches for maximum flexibility. Channel 5 may also select

from "Network" or "Remote". If these signals are monophonic, splitting pads are provided to drive both the right and left stereo mixer on that channel.

HIGH FIDELITY SOUND: The superb audio qualities of the Stereo Statesman—such as a frequency response of 20 to 20,000 Hz with less than 1 dB variation, and a signal to noise ratio of -74 dB—are achieved through the use of silicon transistors, and low impedance mixing.

AMPLIFIERS: All amplifiers are modular in construction, with plug-in connections for easy interchange and maintenance. Components are mounted on etched circuit boards to increase reliability and contribute to the excellent crosstalk and noise specifications of the console. Silicon transistors assure optimum console performance over a wide ambient temperature range. All amplifiers are completely accessible when the top of the console is opened, simplifying maintenance.

WIDE DYNAMIC RANGE: The preamplifiers in the Stereo Statesman will accommodate microphone levels from -77 to -17 dBm without overload or distortion. The program amplifiers deliver $+32$ dBm output before the output pad, and the monitor amplifiers $+40$ dBm output, all with excellent frequency response, low distortion and low noise.

MONITORING: Two monitor amplifiers, each capable of providing up to 10 watts each ($+40$ dBm) are included. Monitor input is selectable from "program", "audition" or "external source". Muting is provided for control room and studio loudspeakers and the console cue speaker. Conventional high impedance headset jacks for stereophonic headphones are provided on the front of the console and can be switched to monitor program, network or cue.

Five Channel Stereo Transistor Console—Stereo Statesman

SPECIFICATIONS

MIXING CHANNELS: Total—5. One microphone. Four tape, turntable, remote or network.

AMPLIFIERS AND POWER SUPPLIES PROVIDED: Two preamplifiers, five program/monitor/cue amplifiers (interchangeable as supplied), three power supply modules.

OPERATING MODE: Stereophonic.

INPUT CIRCUITS: Total—11. Two pairs of stereo microphones, three turntables, three tape, one remote, one network, one auxiliary.

OUTPUT CIRCUITS: Two program outputs at +8 dBm, two audition outputs at -12 dBm, two stereo pair muted speakers (control room, studio), one stereo pair unmuted speakers (labby), headphone.

IMPEDANCES: Microphone: 30/50 or 150/250 ohms balanced. Turntable/tape: 150/250 ohms. Network/remote: 600 ohms balanced, (478-0009 line matching transformer optional). Audition output: 600 ohms. Monitor output: 8 ohms nominal. Program output: 600/150 ohms balanced.

GAIN: Microphone to line: 102 dB, ± 2 dB. Medium level to line: 60 dB, ± 2 dB.

RESPONSE: Program and monitor: ± 1.0 dB, 20 Hz to 20 kHz @ +18 dBm.

DISTORTION: Program circuits: 0.5% maximum, 20 Hz to 20 kHz @ +18 dBm. Monitor circuits: 1.0% maximum, 20 Hz to 20 kHz @ +40 dBm.

NOISE: Program circuits: 74 dB below +18 dBm with -50 dBm input (-124 dBm equivalent input noise measured 20 Hz to 20 kHz). Monitor circuits: 74 dB below +40 dBm with -50 dBm input (-124 dBm equivalent input noise measured 20 Hz to 20 kHz). Medium level inputs (Program) 80 dB below +18 dBm.

POWER: 117 volts, 50/60 Hz, 1 phase.

FINISH: Satin anodized aluminum panels with lettering in black. Cabinet color—two-tone beige-gray.

SIZE: 36 $\frac{3}{4}$ " wide, 17" deep, 8 $\frac{3}{4}$ " high.

SHIPPING DATA: Packed weight: Domestic, 170 lbs. Export, 210 lbs. Cubage, 13 cubic feet.

ORDERING INFORMATION

Stereo Statesman, five channel stereophonic audio console, complete with two preamplifiers, five program/monitor/cue modules (interchangeable), power supply modules, and one transformer panel.....994-6540

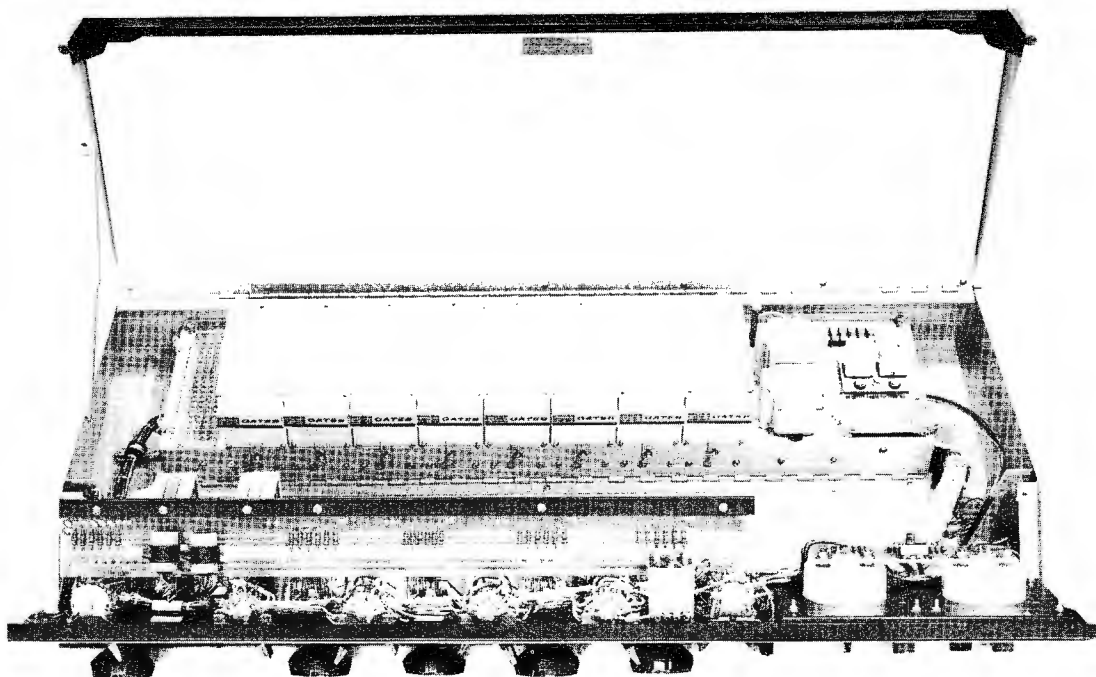

The Stereo Statesman top cover hinges up and the front panel swings down to reveal every "behind the panel" component. This layout and logical access is typical of the complete line of Gates consoles, and reflects the engineering and planning required for neat, professional installations.

Ten Channel Stereo Or Monaural Transistor Console

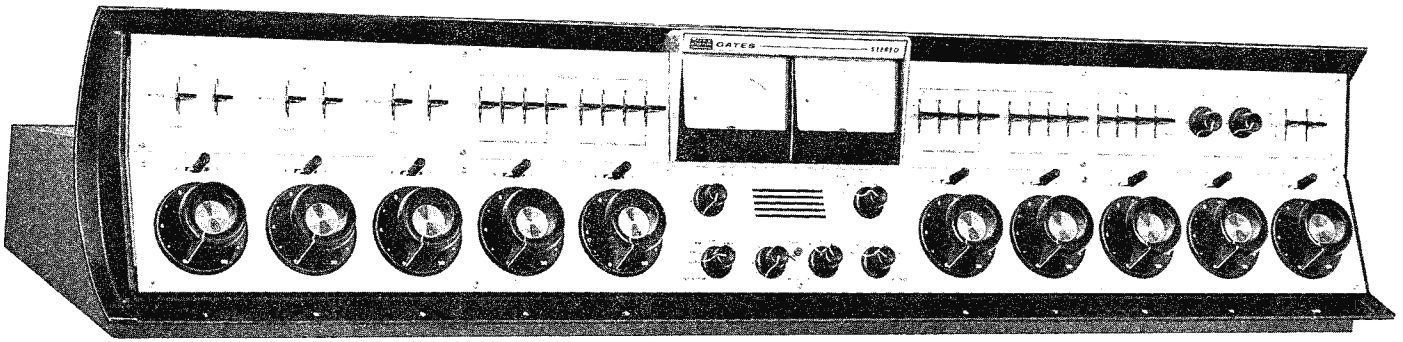

THE EXECUTIVE

With ten full stereo mixers, the dual channel Executive is one of the most complete transistorized audio consoles for stereo or monaural programming on the market today.

Amazingly versatile, this console is a member of Gates Solid-Statesman family—a term applied only to transistorized products that meet the most rigid engineering and manufacturing specifications.

STEREO AND MONAURAL: All ten mixing channels of the Executive are stereo, including network and remote inputs. These channels may also be operated monaurally. By simply adding a third plug-in program amplifier, a compatible “left plus right” signal is available to feed monaural and stereo programming simultaneously to AM and FM (monaural to AM, stereo to FM). Likewise, stereo may be carried on FM with completely different monophonic programming being broadcast on AM.

AMPLIFIERS: The amplifier complement includes six microphone preamplifiers (three stereo pairs), two program amplifiers, two high fidelity monitoring amplifiers, and a cue/intercom amplifier. Also supplied are two audition booster amplifiers, which are part of the internal circuit arrangement. Space is provided for two additional preamplifiers and one additional program amplifier. The power supply is also self-contained and is fully regulated. The amplifiers and power supply are completely solid state.

MIXING SYSTEM: The mixing system contains 10 channels, all with dual (stereo) controls. Channels 1, 2 and 3 are for microphones. Channels 4 and 5 will accept four stereo turntables in any combination, while channels 6 and 7 accommodate four stereo tape inputs. Channel 8 handles four remote lines, and channels 9 and 10 are network and auxiliary channels respectively. The separate fader for incoming network programming is especially convenient for taping delayed broadcast material without tying up the other high-level input to the console. Faders 4 through 10 are all cueing attenuators which feed the inbuilt cue/intercom system.

MICROPHONE INPUTS: Six preamplifiers in three stereo pairs are connected to dual-position input selector keys, permitting 12 microphones (6 stereo pairs) to be selected. Space is provided for two additional M-6034 preamplifiers.

TURNTABLE-TAPE INPUTS: Four turntables may be switched to mixers 4 and 5, and four tape sources may be switched into channels 6 and 7 in any sequence. All faders are stereo, and cue positions are provided on each of these attenuators.

REMOTE-NETWORK INPUTS: Four remote lines may be switched into channel 8 through a line isolation transformer provided. Channel 9 is for network input. Both channels are stereo control equipped, but have removable splitting pads attached for present monophonic signals. Cue positions are provided on these attenuators.

AUXILIARY CHANNEL: This tenth channel has dual line isolation transformers and is uniquely equipped to accommodate extra stereo or monaural functions, either in the studio or from an external source. A cue position is also provided on this fader.

CUE-INTERCOM SYSTEM: An inbuilt cue-intercom amplifier is included, with its speaker centered below the VU meters. The cue signals from mixers 4 through 10 feed the system. The cue-intercom also provides remote talk-back, studio intercom and network preview monitoring. The console muting system also protects against feedback from the cue-intercom speaker.

OPERATING MODES: Stereo only, or monaural only, may be fed to either program or audition mixer circuits. Likewise, monaural FM may be broadcast separately from monaural AM. When the optional M-5700 program amplifier is added, stereo FM and monaural AM may be broadcast either simultaneously, or separately.

Ten Channel Stereo Or Monaural Transistor Console—Executive

VU METERS: Dual 4-inch illuminated meters are provided. The left meter connects to the left channel, while the right meter connects to the right channel (or it may be switched to the output of the optional M-5700 program amplifier). The right meter also switches to parallel the left meter for stereo calibration or to check incoming network level. A third external VU meter, in an attractive "shadow mold" housing, is available for larger installations where simultaneous metering of three program channels is required.

MUTING RELAYS: Three are supplied to mute three pairs of loudspeakers. Warning light contacts are also provided. These relays operate from the microphone keys and cue-intercom system.

ADDITIONAL FACILITIES: These include: dual headphone jacks; a cue-intercom selector switch; left and right master gain controls for the program amplifier; a dual monitoring amplifier gain control; a fully regulated power supply; and 28 tab keys (top row) performing a large number of switching functions.

STYLING: Exclusively styled by one of America's leading industrial designers, the Executive's satin anodized aluminum control panel floats in a 3-dimensional setting, and the "shadow mold" styling is strikingly modern in appearance. The front panel hinges down and the cabinet top cover hinges up.

SPECIFICATIONS

MIXING CHANNELS: Total—10. All stereo. (3) microphone, (2) turntables, (2) tape or projectors, (1) remote, (1) network, (1) all purpose.

AMPLIFIERS PROVIDED: 2 program, 2 booster, 2 monitor, 6 preamplifiers (3 pairs), 1 cue amplifier. Space provided for two optional added preamplifiers and one optional added program amplifier.

OPERATING MODE: Stereo and monaural.

INPUT CIRCUITS: 12 for mics., 4 turntables, 4 tape/projectors, 4 remote lines, 1 network line, 1 all purpose utility.

OUTPUT LINES: 2 program, 6 muted speaker (3 pairs), 2 non-muted speaker, 2 intercom, 2 headphones, 2 record. NOTE: Add one more program output if optional program amplifier is purchased.

IMPEDANCES: Microphones: 30/50 or 150/250 ohms. Turntable/tape: 150/250 ohms unbalanced. Remote lines: 500/600 ohms, balanced. Network: 500/600 ohms. Utility: 500/600 ohms. Programming output: 500/600 ohms. Recording output: 500/600 ohms. Intercom output: 48 ohms. Monitor speaker output: 8/16 ohms.

GAIN: Turntable, tape, network (high level) input to program line output, 55 dB. To monitor amplifier output, 55 dB. From microphone input to program line output, 102 dB. To monitor amplifier output, 102 dB. NOTE: All measurements ± 2 dB.

RESPONSE: All segments of program circuit ± 1 dB, 30-15,000 Hz. Monitoring circuit $\pm 1\frac{1}{2}$ dB, 30-15,000 Hz. NOTE: Typical response all circuits: 20-20,000 Hz, ± 2 dB.

DISTORTION: Any segment of program circuit 0.5% or less between 30-15,000 Hz at +8 dBm output level or 0.5% at +18 dBm, 50-15,000 Hz. Monitor amplifier 1% at +39 dBm (8 watts).

NOISE: Program circuits 70 dB or better below +18 dBm output, with -50 dBm input (equivalent noise input is -120 dBm). Monitor circuits, 60 dB below +39 dBm output. Crosstalk: All circuits below noise level with normal gain settings for proper programming.

STEREO ISOLATION: Below noise level all channels.

POWER: 115 volts, 50/60 Hz, 1 phase. Power consumption, 50 watts at 60 Hz.

FINISH: Cabinet, beige-gray. Panel, natural anodized aluminum lettered in black. Knobs with decal color inserts.

SIZE: 53 $\frac{1}{2}$ " wide, 11 $\frac{1}{2}$ " high, 17 $\frac{1}{2}$ " deep.

SHIPPING DATA: Packed weight: Domestic, 220 lbs. Export, 270 lbs. Cubage: 27 cubic feet.

OPTIONAL ACCESSORIES: Space is provided to add two model 994-6034 preamplifiers, and one model 994-5700 program amplifier.

NOTE: For optimum performance the load on the monitor amplifier should not be less than 8 ohms. Where it is necessary to operate several loudspeakers on one amplifier, use the 478-0291 matching transformer. Four of these transformers are supplied with the console.

ORDERING INFORMATION

| | |
|---|----------|
| Executive Audio Console (includes 4 speaker matching transformers)..... | 994-6158 |
| Optional Preamplifier..... | 994-6034 |
| Optional program amplifier..... | 994-5700 |
| Speaker matching transformer..... | 478-0291 |
| Optional 3rd VU meter..... | 994-6208 |
| Intercom sub-station..... | 994-6424 |

HARRIS
GATES DIVISION
Harris-Intertype Corporation

Ten Channel Stereo Or Monaural Transistor Console-Executive

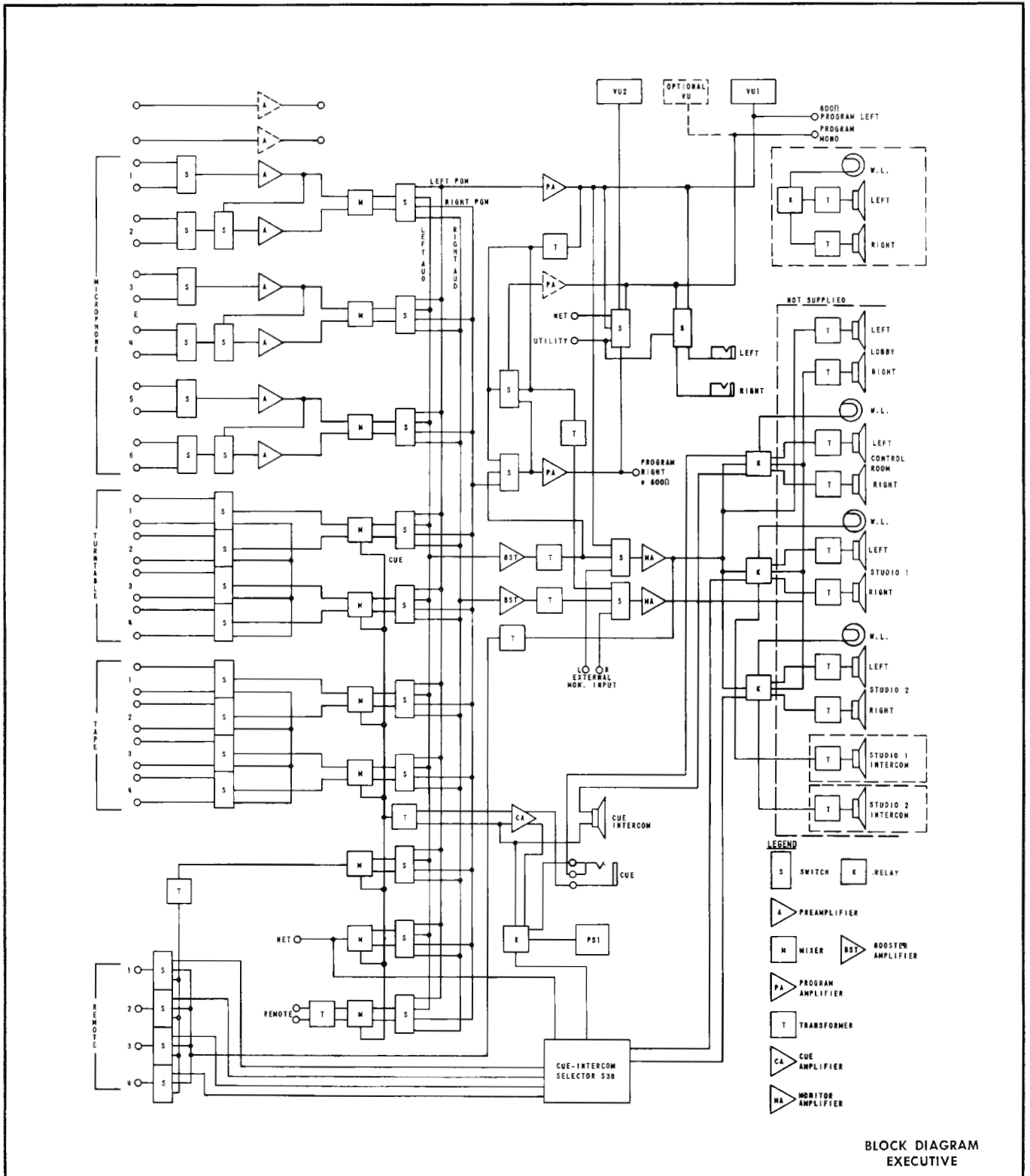

Dual Programming Ten Channel Transistor Console

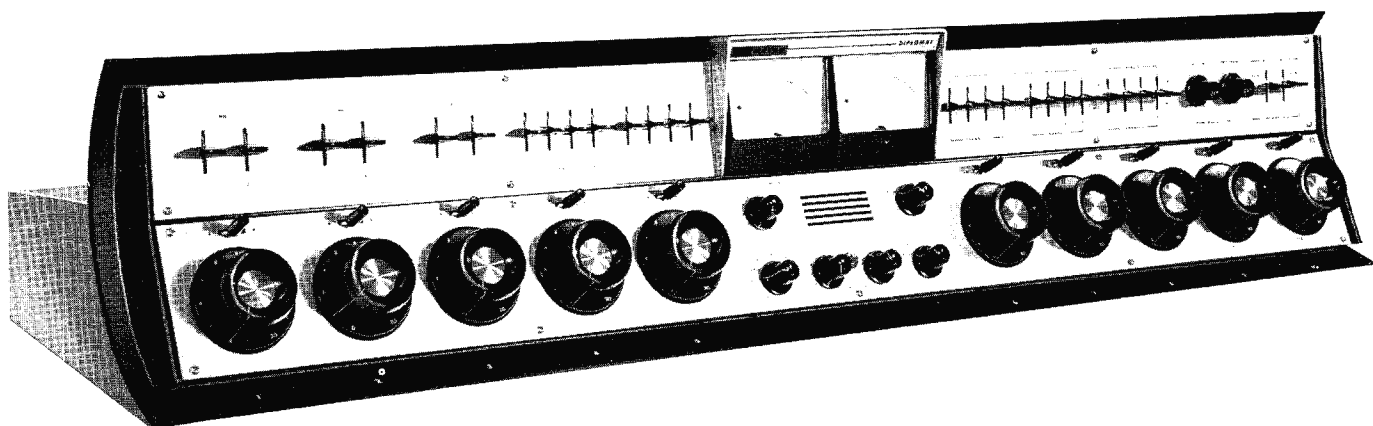

THE DIPLOMAT

The Diplomat is the senior partner in the fully transistorized Gates line of Solid-Statesman monaural consoles. This dual channel console has 10 mixing channels, cue-intercom, 28 upper level tab keys for nearly every conceivable input and output circuit function, and features the VA knob and "shadow mold" styling—designed exclusively for Gates by one of the country's leading industrial stylists.

MIXING SYSTEM: The mixing system is a ten channel, low impedance type, using ladder controls throughout in a minimum loss circuit design. The key switch above each channel control switches the mixer to either program amplifier.

MICROPHONE CHANNELS: Six microphones are tab key selected into 3 preamplifiers and associated mixing channels 1, 2 and 3. Channel keys operate the three muting relays.

TURNTABLE CHANNELS: Mixing channels 4 and 5 handle four turntables into either mixer in any sequence. Four upper level tab keys on each channel select the turntable to be used. Cue position on faders connects any turntable input to the cue amplifier.

TAPE CHANNELS: Mixing channels 6 and 7 handle four tape or projector inputs into either mixer in any sequence. Four upper level tab keys on each channel select the input to be used. Cue position on fader connects any tape input to cue amplifier.

REMOTE CHANNEL: Mixing channel 8 accommodates four remote lines by upper tab key selection. A line isolation transformer is part of this circuit. Cue position on fader connects any remote line to cue amplifier.

NETWORK CHANNEL: Mixing channel 9 is for network or similar input. Cue position on fader connects network to cue amplifier for preview.

AUXILIARY CHANNEL: Mixing channel 10 is for any input source such as a second network or much used remote. This auxiliary channel has a cue position on the fader connected to cue amplifier.

CUE-INTERCOM SYSTEM: The built-in intercom system provides network monitoring, remote over-ride, remote talk-back, studio intercom, turntable cueing, tape cueing and general previewing and cueing. The control room and studio speakers are muted by the channel keys and muting relays when there is a live microphone in any of these locations. The cue amplifier and speaker/microphone is self-contained, and the cue speaker/microphone is located directly under the VU meters.

PROGRAM SWITCHING FUNCTIONS: A single key changes the master operation of the console from simultaneous to separate operation as desired by the operator. Dual program amplifiers are standard equipment. Space is provided for an optional third program amplifier. If the third program amplifier is utilized, this will permit, for example, recording while broadcasting AM and FM simultaneously from the second of the dual channels.

VU METERS: Two 4" illuminated VU meters are supplied. The left meter is connected to program channel 1 at all times. The right meter may be switch selected to (a) program channel 1 for calibration, (b) program channel 2, (c) output of optional third program amplifier, (d) network input, or (e) external connections.

MONITORING AMPLIFIER: The self-contained 8 watt monitoring amplifier input may be switched to (a) output of master program channel, (b) output of program channel 2 or (c) external input. Amplifier output feeds the loudspeaker system.

MUTING RELAYS: Three relays mute speakers and operate studio warning lights in the control room and are controlled from microphone mixer channel keys. Intercom is also interlocked to prevent feedback.

Dual Programming Ten Channel Transistor Console—Diplomat

PHONE JACKS: Phone jacks are provided on a separate mounting plate which attaches to the desk, thus eliminating phone cords over the desk top.

POWER SUPPLY: The power supply is fully regulated and self-contained except for the small AC transformer, which is external to assure extremely low noise.

SERVICING: The Diplomat front panel hinges down and cabinet lid hinges up to expose all components for easy maintenance. All terminations are in the rear.

RECOMMENDED USE: The Diplomat may be described as an unusually wide facility audio console of network or large station caliber. It is excellent for TV as well as radio.

SPECIFICATIONS

MIXING CHANNELS: Total 10. Three microphone, two turntable, two tape/projector, one remote, one network and one auxiliary.

AMPLIFIERS PROVIDED: 2 program, 1 monitor, 3 preamplifiers, 1 cue amplifier. Room provided for 1 additional program amplifier and 2 additional preamplifiers.

OPERATING MODE: Dual channel monaural.

INPUT CIRCUITS: 6 for microphones, 4 turntables, 4 tape/projectors, 4 remote lines, 1 network line, 1 auxiliary line.

OUTPUT CIRCUITS: 2 program, 1 audition, 3 muted speakers, 1 non-muted speaker, 2 intercom, 2 headphones.

IMPEDANCES: Microphones: 30/50 or 150/250 ohms. Turntable: 600 ohms. Tape/projector: 600 ohms. Remote lines: 600 ohms. Network: 600 ohms. Auxiliary: 600 ohms. Programming output: 600 ohms. Audition output: 600 ohms. Intercom output: 48 ohms. Monitor speakers: 8/16 ohms. Recording outputs: 600 ohms.

NOTE: Where more than two loudspeakers are used, it is mandatory that the 478-0275 speaker matching transformer or similar be used with each loudspeaker. This assures correct loudspeaker performance and protects power transistors in the monitoring amplifier.

GAIN: Turntable, tape, network (medium level) input to program line output 55 dB. From microphone input to program line output 102 dB. All measurements ± 2 dB.

RESPONSE: All segments of program circuit ± 1 dB 30-15,000 Hz. Monitoring circuit $\pm 1\frac{1}{2}$ dB 30-15,000 Hz.

NOTE: Typical response: 20-20,000 Hz.

DISTORTION: Any segment of program circuit 0.5% or less between 30-15,000 Hz at +8 dBm output level, or at +18 dBm output 0.5% 50-15,000 Hz. Monitor amplifier 1% at +38 dBm (8 watts). Intermodulation distortion: 0.5% program and 1.0% monitor circuits.

NOISE: Program circuits: 70 dB or better below +18 dBm output, with -50 dBm input (equivalent noise input -120 dBm). Monitor circuits: 60 dB below +39 dBm output. Crosstalk: All circuits below noise level with normal gain settings for proper programming.

POWER: 117 volts, 50/60 Hz, 1 phase. Power consumption 34 watts at 60 Hz.

FINISH: Satin anodized aluminum panel with lettering in black. Cabinet in beige-gray, with shadow mold in black. Knob color insert decal kit included.

SIZE: 53½" wide, 11¾" high, 17¾" deep.

SHIPPING DATA: Packed weight: Domestic, 220 lbs.; export, 242 lbs. Cubage: 26 cubic feet.

ORDERING INFORMATION

| | |
|---|----------|
| Diplomat audio console complete with four speaker matching transformers | 994-6377 |
| Optional program amplifier | 994-5700 |
| Optional preamplifier | 994-6034 |
| Speaker matching transformer | 478-0291 |
| Spare 100% semi-conductor kit | 990-0505 |
| Studio cue/intercom speaker | 994-6424 |

IMPORTANT: For optimum performance the load on the monitor amplifier should not be less than 8 ohms. Where it is necessary to operate several loudspeakers on one amplifier, use the 478-0291 matching transformer. Four of these transformers are supplied with the console.



STUDIO CUE-INTERCOM SPEAKER

Beautifully styled to match all Gates Solid Statesman products. Cast aluminum housing in non-reflecting black with heavy fabric grill cloth front. Speaker 600/48 ohms to match console intercom impedances. Size: 5½" wide, 6¾" high, 4" deep. ORDER MODEL 994-6424.

Dual Programming Ten Channel Transistor Console—Diplomat

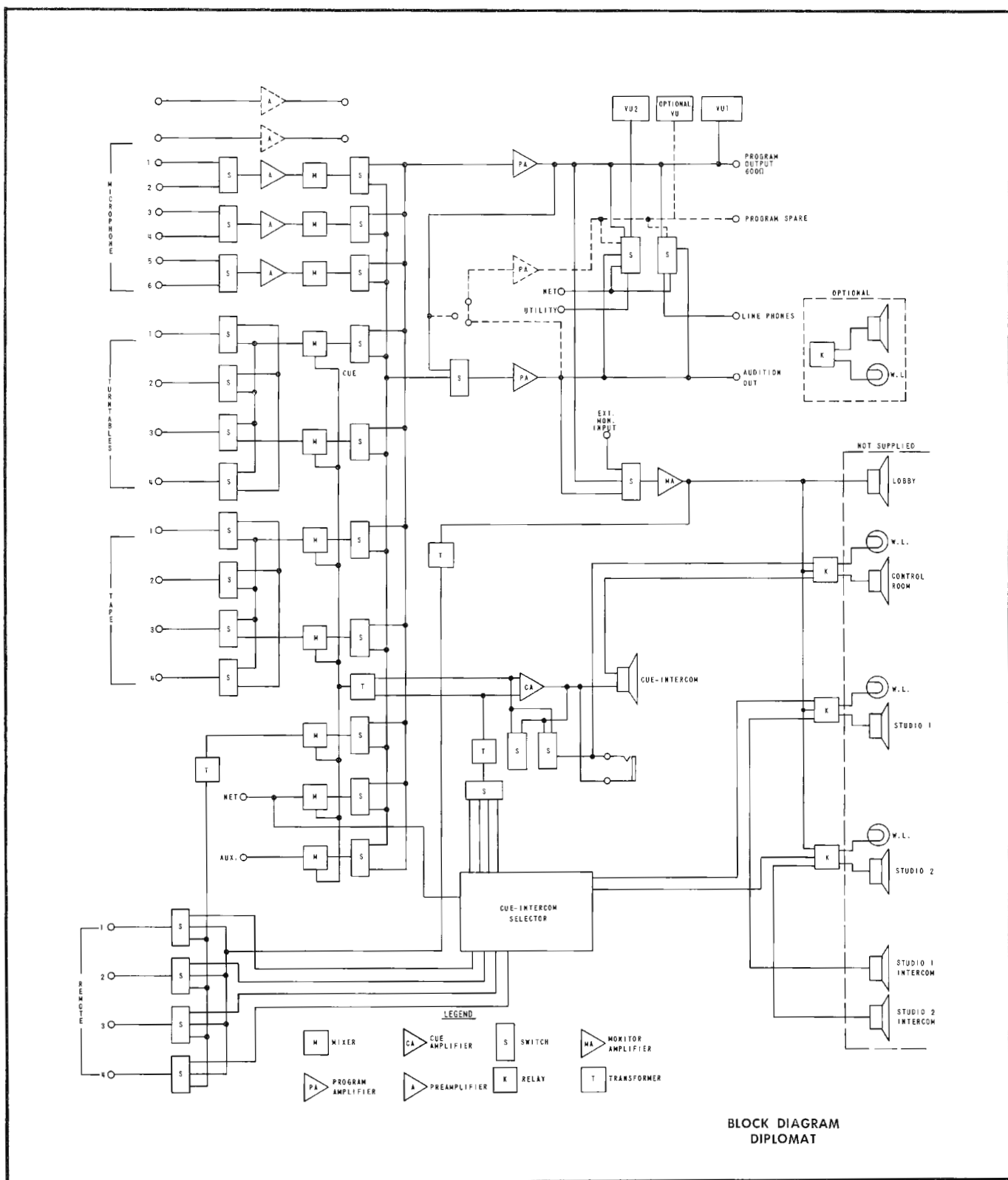

Four Channel All-purpose Transistor Console

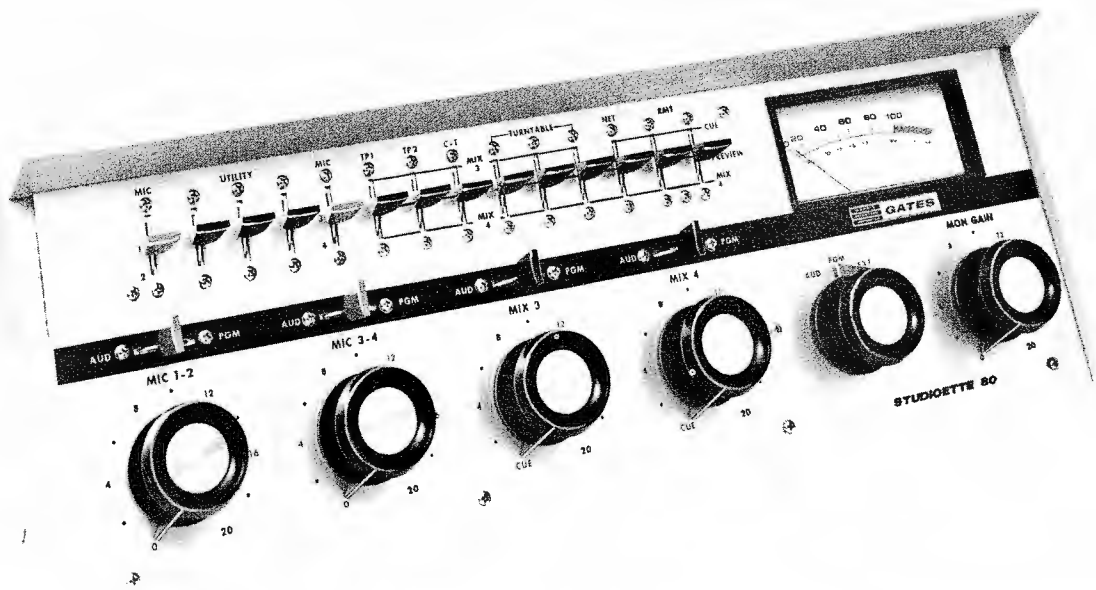

THE STUDIOETTE 80

A successor to Gates' famous Studioette, the Studioette 80 is a solid-state, four-mixer monophonic console that provides a high degree of flexibility through the use of 11 input selector switches.

Although compact in size, the Studioette 80 offers a wide range of facilities, and is ideal as a main console in medium and smaller size stations. In larger stations, the Studioette 80 will find application as a production console, or may be used for independent programming from a second studio. It is also excellent for use in mobile units and at other remote locations.

OPERATION: Although a small console, the Studioette 80 has a great number of input facilities. It provides 4 mixing channels with channel keys and a row of 11 input keys for multiple circuit combinations. Three utility keys are provided for specialized station needs and may be wired into any input. The channel attenuators are high quality step-type controls. Channels 3 and 4 include a cue position attenuator. In addition, the inputs and outputs have isolation transformers which prevent ground loops and subsequent system problems.

Four microphones may be key-selected into two preamplifiers. Three turntables, two reel-to-reel and one cartridge machine, two remote lines and network are also accommodated. A 10-watt monitoring amplifier, the same high-quality product found in larger Gates' consoles, is standard equipment.

MUTING SYSTEM: Dual muting relays handle speaker and warning light functions. These relays are shock mounted on a sub-chassis to prevent mechanical noise during switching.

ADDITIONAL FACILITIES: A monitor-selector key switches the monitoring amplifier input to (1) program circuit, (2) terminals for an external source, and (3) audition circuit. A headphone jack is always available across the program line. The 4-inch illuminated VU meter has modern scale and bezel styling. This meter is connected to the program line, indicating +8 VU output at "0" scale reading. A special cueing amplifier/speaker system is available and can be ordered as an accessory item. The Studioette 80 is designed for 117/234 VAC, 50/60 Hz.

MECHANICAL FEATURES: Silicon transistors are used throughout the Studioette 80. Mounted in a smartly-styled, all-metal housing, the console is finished in dark-gray pebble texture.

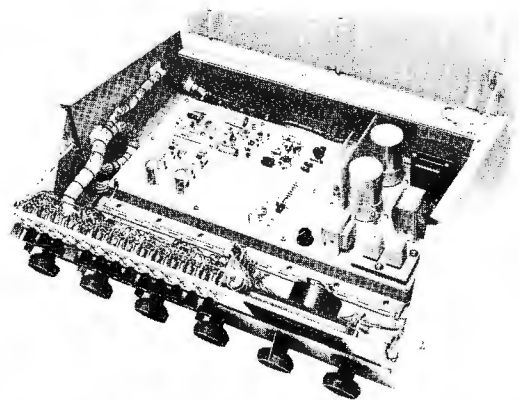

Hinged top cover and front panel swing open for easy access to components.

Four Channel All-purpose Transistor Console—Studioette 80

SPECIFICATIONS

MIXING CHANNELS: Total 4. Key selected to program or audition bus. Channels 1 and 2 for microphones, 3 and 4 for multi-input use such as turntables, tapes, etc. Cue position on faders 3 and 4.

AMPLIFIERS PROVIDED: 1 program, 1 monitor, 2 preamplifiers.

OPERATING MODE: Single channel monaural.

INPUT CIRCUITS: 4 microphones, 3 turntables, 2 reel-to-reel and 1 cartridge machine, 2 remote lines, 1 network line. (1 external input for the monitor amplifier).

OUTPUT LINES: 1 program, 2 muted speakers, 1 nonmuted speaker, 1 cue bus for accessory amplifier/speaker.

IMPEDANCES: Microphones—30/50 or 150/250 ohms, balanced; turntable/tape/network/remote—600 ohms, balanced. Programming output—600 ohms, balanced. Monitor speakers 8 ohms, balanced. Note: where more than 3 loudspeakers are used, see ordering information for additional transformers.

GAIN: (Maximum) Microphone input to program line output 100 dB. Turntable/tape/network (medium level) input to program line output 60 dB. All measurements ± 2 dB.

RESPONSE: Program and monitor circuits ± 1 dB 30 to 15,000 Hz.

DISTORTION: Program circuit 1% or less between 30-15,000 Hz at +8 dBm output level. Monitor amplifier 1% or less at 40-15,000 Hz at +40 dBm (10 watts).

NOISE: Program circuits: 70 dB or better below +18 dBm output with -50 dBm input (equivalent input noise is -120 dBm).

MONITOR CIRCUITS: More than 70 dB below +40 dBm output.

CROSSTALK: Less than 10 dB above noise level with normal control gain settings for proper programming.

POWER: 117 volts (as shipped)/234 volts, 50/60 Hz. Power consumption: 25 watts maximum.

CABINET DATA: Size: 24" wide, 8" high, 18" deep. Finish: Front panel—satin natural anodized aluminum with black markings. Cabinet—beige gray with pebble texture. Weight: 46 lbs. unpacked.

SHIPPING DATA: Packed weight: (domestic) 75 lbs.; (export) 120 lbs. Cubage: 5 cubic feet.

ORDERING INFORMATION

Studioette 80 transistor audio console ----- 994-6769-001

Recommended spare parts kit (100% semi-conductors, fuses, pilot lights) ----- 994-6905-001

Isolation transformer ----- 478-0009-000

Monitor speaker transformers:
For one speaker ----- 478-0291-000
For three speakers ----- 478-0290-000

Cueing amplifier with built-in speaker ----- 994-5377-001

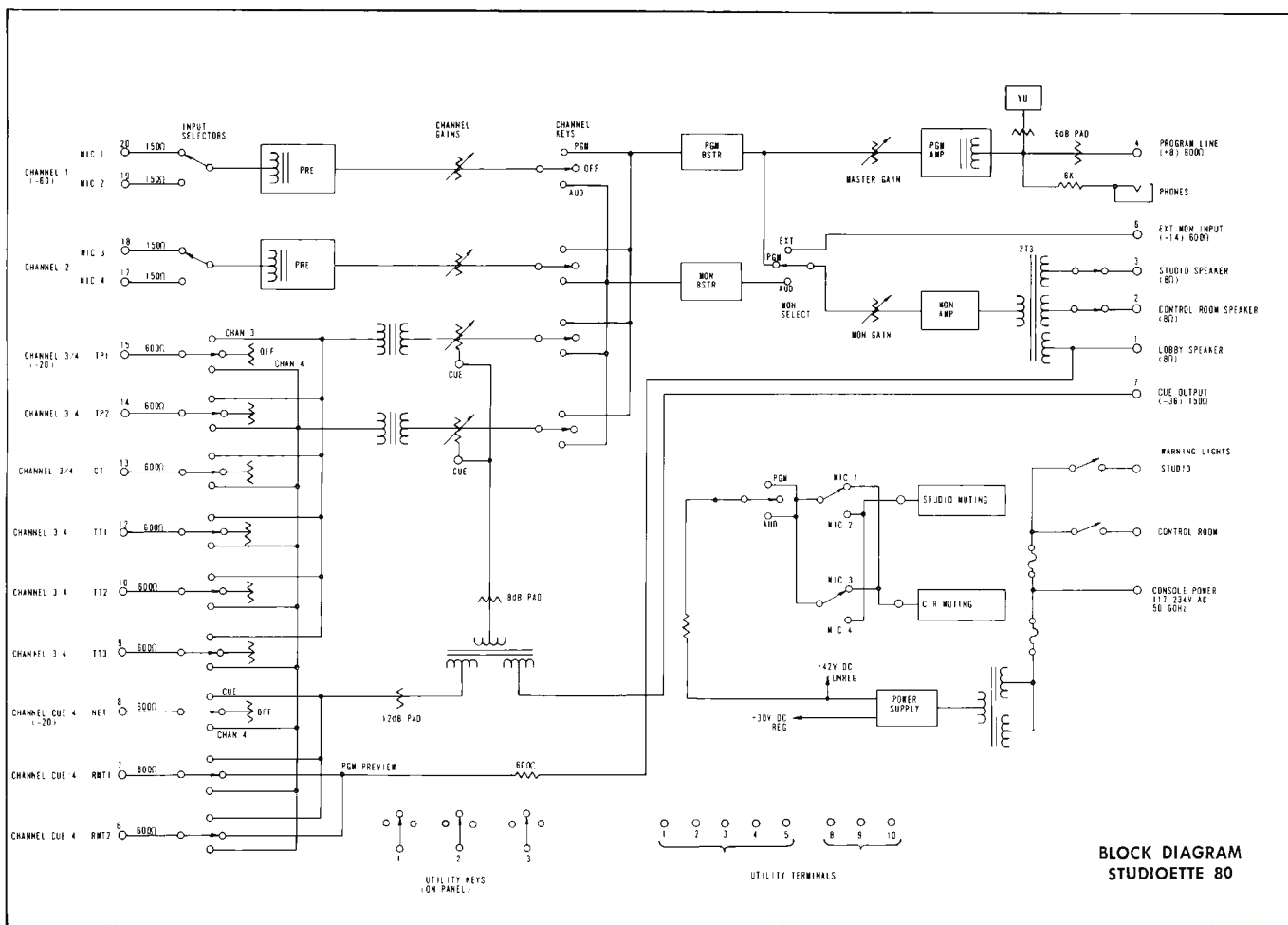

BLOCK DIAGRAM
STUDIOETTE 80

Four Channel Stereo Recording Mixer



THE STEREO PRODUCER

Gates' Stereo Producer is a solid-state four-channel stereophonic production mixer, providing all facilities for direct recording, dubbing, sound-on-sound recording, editing and monitoring.

ADAPTABILITY: The Stereo Producer may be used in almost any situation not requiring a complete speech input console. It is small enough to take to sporting events, concerts, city council meetings, etc. for on-the-spot remote coverage. Ideal for stereo newscasts, and as a sub-studio console for programming outside the main control room.

SOUND-ON-SOUND: An important feature of the Stereo Producer is its ability to make sound-on-sound recordings. The monitoring amplifiers normally bridge the program amplifier outputs. However, if it is desired to add voice-over on a prerecorded music or voice track, the monitor amplifier is switched to either of the high-level inputs, ahead of the mixers, to prevent acoustic feedback.

STEREO BALANCING: Circuitry is provided to allow accurate stereo channel balancing, using the "null" method, with the aid of the large, 4-inch console VU meters.

INPUTS: The console has transformer-balanced inputs on each channel. Inputs include: six microphones into two faders, and ten turntable, cartridge or reel-to-reel recorders into two faders (for each stereo channel).

OUTPUTS: High-gain program amplifiers furnish 600-ohm balanced outputs at +8 VU, after an isolation pad. The monitor amplifiers provide +32 dBm (1½ watts) for driving monitoring loudspeakers. Monitor-speaker muting on the microphone channels is standard.

Large "feel-of-the-board" VA control knobs are used for speed and accuracy in mixing. Installation of the Stereo Producer is simple, with all cable connections made to barrier-type terminal strips. All components are readily accessible through the lift-off top.

Four Channel Stereo Recording Mixer–Stereo Producer

SPECIFICATIONS

MIXING CHANNELS: Total of 4. 2 microphone channels, 2 medium level (TT/Tape/Projector) channels. Cue provision on medium level channels.

AMPLIFIER SYSTEM: 2 identical printed-circuit board assemblies are used, 1 for each stereo channel. Each printed-circuit board contains 2 microphone preamps, 1 booster amp, 1 program amp, 1 monitor amp, and 1 power supply.

OPERATING MODE: Stereophonic.

INPUT CIRCUITS: 6 microphone or low-level, 10 medium level per stereo channel.

OUTPUT LINES: Stereo program line, stereo monitor output, and stereo high impedance headphone jack.

IMPEDANCES (All Balanced): Microphone, 30/50 or 150/250 ohms. Medium level, 150/600 ohms. Program output, 150/600 ohms. Monitor outputs, 8/16 ohms.

GAIN: Microphone input to line output, 100 dB \pm 3 dB.
Medium level input to line output, 55 dB \pm 3 dB.
Medium level input to monitor output, 80 dB \pm 3 dB.

RESPONSE: \pm 1.0 dB from 30 to 15,000 Hz in program circuits. \pm 1.5 dB from 30 to 15,000 Hz in monitoring circuits.

DISTORTION: Harmonic, 1.0% maximum, 50 to 15,000 Hz @ +18 dBm output in program circuits, and @ +32 dBm in monitor circuits. Inter-modulation, 1.0% maximum in program circuits.

NOISE: -120 dBm relative input noise on microphone channels. -75 dBm relative input noise on medium level channels.

CROSSTALK: 55 dB below -60 dBm input and +8 dBm output, 30 Hz to 15,000 Hz, microphone channels. 55 dB below -15 dBm input, +8 dBm output, 30 Hz to 15,000 Hz, medium level channels.

POWER: 117 volts, 50/60 Hz, power consumption 28 watts.

FINISH: Beige/gray with black trim.

SIZE: 28" long, 10½" high, 18" deep.

WEIGHT: 60 lbs.

SHIPPING DATA: Packed weight, domestic, 75 lbs.; export, 125 lbs., cubage, 5 cubic feet.

ORDERING INFORMATION

M-6642 Stereo Producer recording mixer, four channels complete with preamplifiers, program amplifiers, monitor amplifiers and self-contained power supplies 994-6642

100% spare semi-conductor kit for the Stereo Producer 990-0583

Speaker matching transformers for using external 8-ohm speakers, 48/8 ohms (two required for stereo) 478-0291

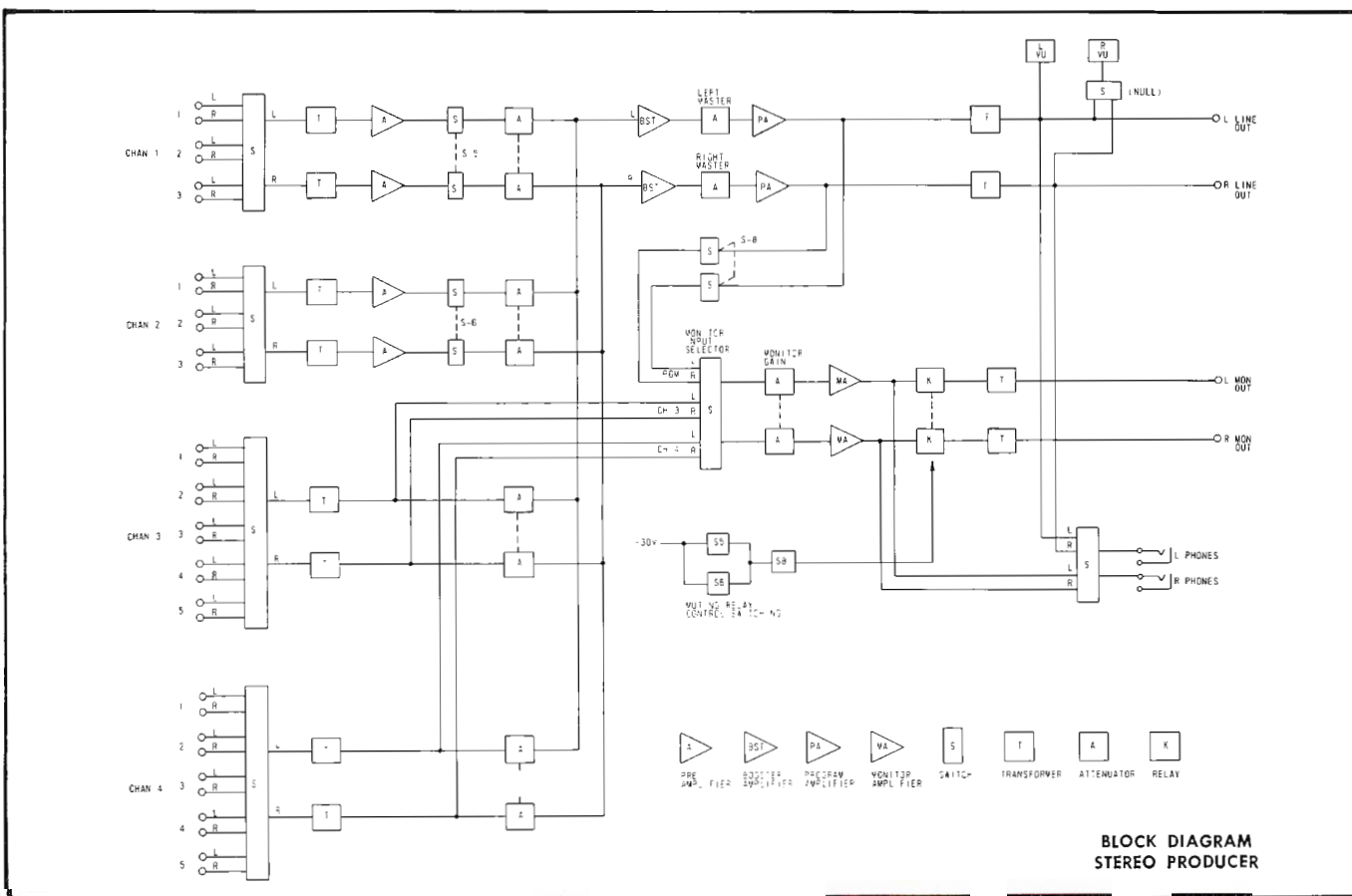

Four Channel Recording Mixer

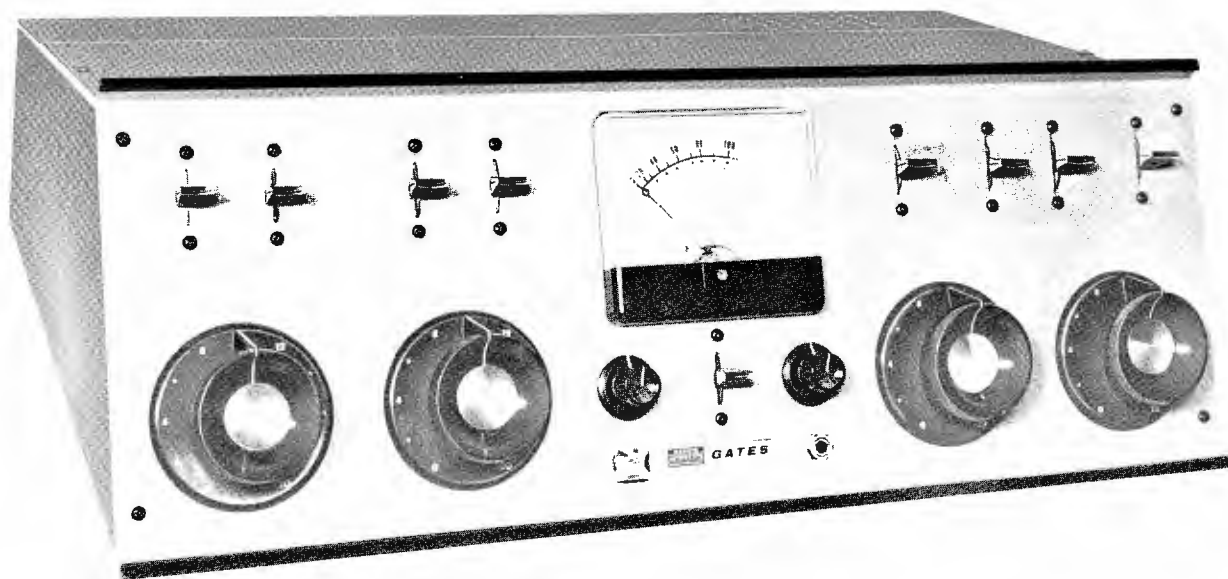

THE PRODUCER

The rapid growth of cartridge tape recorders and increased use of reel-to-reel recorders in radio and television broadcasting demands an audio control system specifically designed for production mixing. Completely transistorized, Gates Producer provides the facilities for direct recording, dubbing, sound-on-sound recording, editing and monitoring. The use of the VA mixing control knob, the same as used on all Gates Solid Statesman consoles, adds to the accuracy and speed called for in the handling of a production operation.

ADAPTABILITY: Though designed primarily for recording, the Producer is adaptable to other services not requiring a complete speech input console. Such services might include news rooms, mobile units and small sub-stations.

INPUTS: Professional in every respect, the Producer provides transformer balanced inputs on each channel. Twelve inputs through the four mixing channels provide six microphones into two faders, plus six turntables, cartridges, or reel-to-reel recorders into two faders. Two-stage, 45 dB preamplifiers on microphone channels 1 and 2 provide high level mixing. Completely self-contained, the Producer also includes a high gain program amplifier which furnishes a 600 ohm balanced output at +8 VU, after a 6 dB pad. A monitor amplifier is provided, driving the 3" x 5" loudspeaker mounted internally (or an external speaker, if desired). Mon-

itor speaker muting on the microphone channels is standard. Muting defeat is also provided.

SOUND-ON-SOUND: An exclusive feature in the Producer is the ability to make "sound-on-sound" recordings with ease. The monitoring amplifier normally bridges the program amplifier output. If it is desired to add voice over a pre-recorded voice or music track, this amplifier is switched to monitor either high level input, ahead of the mixers, without fear of feedback.

A four-inch illuminated VU meter, a headphone monitor jack, and a self-contained power supply are all standard on the Producer.

DESIGN: This console is a fine example of functional design and versatility, tailored specifically for broadcast production requirements. All amplifier components are on two printed boards, one containing the two microphone preamplifiers and program amplifier, the other housing the monitor amplifier and power supply. All transistors are plug-in for ease of maintenance.

The regulated power supply is short-circuit protected by a self-restoring sealed circuit breaker, eliminating the need for fuses. Installation of the Producer is fast and simple, with all cable connections made to barrier-type terminal strips.

Four Channel Recording Mixer-Producer

Note complete transistorized construction and immediate access to all components. Self-contained 3" x 5" speaker located at top rear is ideal for cueing and production.

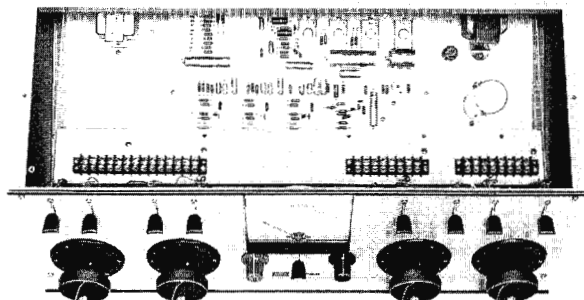

SPECIFICATIONS

MIXING CHANNELS: Total—4. 2 microphone channels, 2 TT/tape/projector channels. Cue provision on high level channels.

AMPLIFIERS PROVIDED: 1 program, 2 preamplifiers, 1 monitor amplifier and power supply.

OPERATING MODE: Single-channel monophonic.

INPUT CIRCUITS: 6 microphone or low level, 6 turntable/tape or high level.

OUTPUT LINES: 600 ohms balanced. One 45/48 ohm internal or external loudspeaker. One high-impedance headphone monitor.

IMPEDANCES: Microphone, 30/50 or 150/250 ohms. Turntable, tape, or cartridge, 150 or 600 ohms. Programming output, 600 ohms balanced. Loudspeaker, 45/48 ohms.

GAIN: Microphone input to line output, 100 dB \pm 3 dB. Turntable input to line output, 55 dB \pm 3 dB. Microphone input to speaker output, 125 dB \pm 3 dB. Turntable input to speaker output, 80 dB \pm 3 dB.

RESPONSE: \pm 1.0 dB from 30 to 15,000 Hz in program circuits. \pm 1.5 dB from 30 to 15,000 Hz in monitoring circuits.

HARMONIC DISTORTION: 0.5% maximum, 30 to 15,000 Hz at +8 dBm output in program circuits.

INTERMODULATION DISTORTION: 0.5% maximum in program circuits.

NOISE: -120 dBm relative input noise on microphone channels. -75 dBm relative input noise on turntable channels.

POWER: 117 volts, 50/60 Hz, power consumption 30 watts.

FINISH: Beige-gray with black trim.

SIZE: 24" long, 10 1/2" high, 15" deep.

SHIPPING DATA: Packed weight, domestic, 50 lbs.; export, 80 lbs. Cubage; 4.6 cubic feet.

ORDERING INFORMATION

The Producer recording mixer.....994-6407
 100% spare semi-conductor kit.....990-0512
 Speaker matching transformer.....478-0291

NOTE: When using external monitoring loudspeakers, the 478-0291 matching transformer must be used.

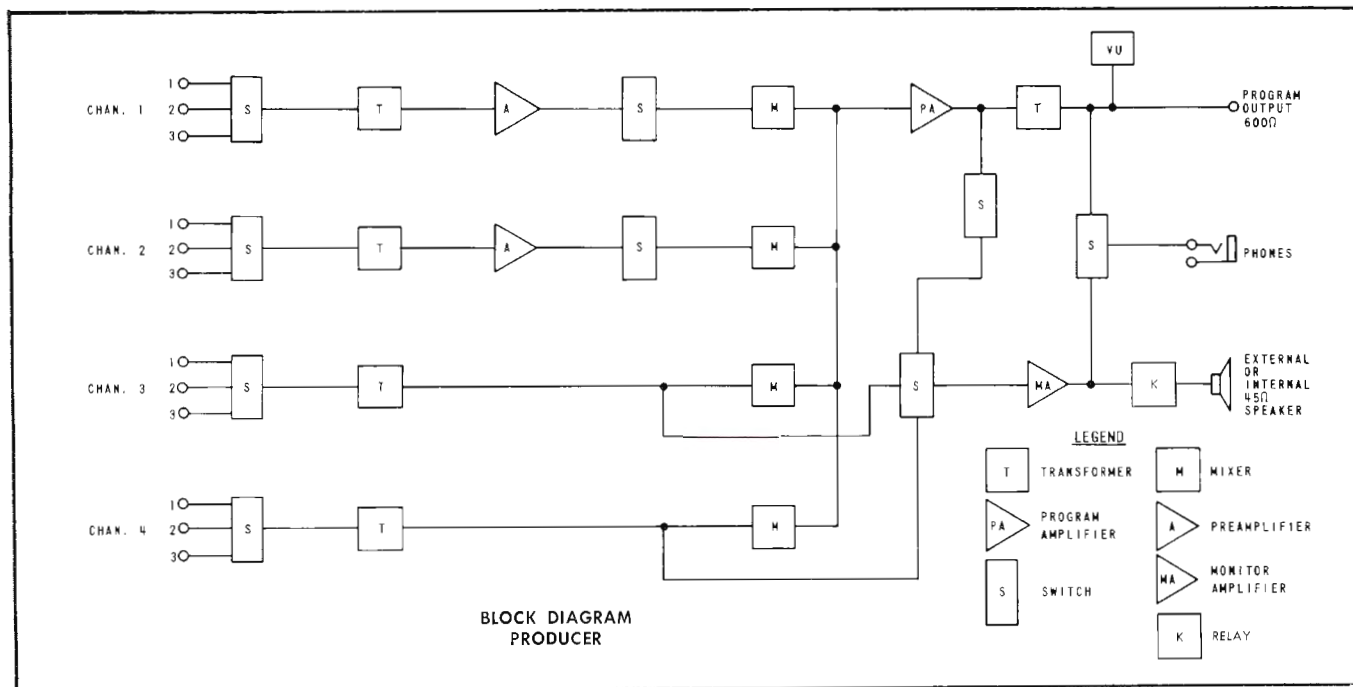

Reference Information

FIXED ATTENUATOR DATA

The data shown below provides information to construct H pads, commonly used in audio applications. Usually 1/2 watt resistors are sufficient. 5% resistors are recommended. For T pads, double the values of R1 and R2 and delete R4 and R5.

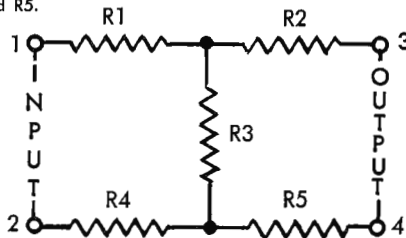

| dB LOSS | R1, R4 OHMS | R2, R5 OHMS | R3 OHMS |
|---------------------------------------|----------------|----------------|------------|
| 600 OHMS INPUT/600 OHMS OUTPUT | | | |
| 1 | 18 | 18 | 5100 |
| 2 | 33 | 33 | 2700 |
| 3 | 51 | 51 | 1800 |
| 4 | 68 | 68 | 1300 |
| 5 | 82 | 82 | 1000 |
| 6 | 100 | 100 | 820 |
| 7 | 110 | 110 | 680 |
| 8 | 130 | 130 | 560 |
| 9 | 150 | 150 | 470 |
| 10 | 160 | 160 | 430 |
| 12 | 180 | 180 | 330 |
| 15 | 200 | 200 | 220 |
| 20 | 240 | 240 | 120 |
| 25 | 270 | 270 | 68 |
| 30 | 270 | 270 | 39 |
| 35 | 300 | 300 | 22 |
| 40 | 300 | 300 | 12 |
| 600 OHMS INPUT/150 OHMS OUTPUT | | | |
| 12 | 270 | 4.7 | 160 |
| 15 | 270 | 24 | 110 |
| 20 | 270 | 47 | 62 |
| 25 | 270 | 56 | 33 |
| 30 | 300 | 68 | 20 |
| 35 | 300 | 68 | 11 |
| 40 | 300 | 75 | 6.2 |
| 150 OHMS INPUT/150 OHMS OUTPUT | | | |
| 1 | 4.3 | 4.3 | 1300 |
| 2 | 8.2 | 8.2 | 620 |
| 3 | 13 | 13 | 430 |
| 4 | 18 | 18 | 300 |
| 5 | 20 | 20 | 240 |
| 6 | 24 | 24 | 200 |
| 7 | 30 | 30 | 160 |
| 8 | 33 | 33 | 150 |
| 9 | 36 | 36 | 120 |
| 10 | 39 | 39 | 100 |
| 12 | 47 | 47 | 82 |
| 15 | 51 | 51 | 56 |
| 20 | 62 | 62 | 30 |
| 25 | 68 | 68 | 16 |
| 30 | 68 | 68 | 10 |
| 35 | 75 | 75 | 5.6 |
| 40 | 75 | 75 | 3 |
| 150 OHMS INPUT/50 OHMS OUTPUT | | | |
| 10 | 62 | 0 | 62 |
| 12 | 62 | 5.1 | 47 |
| 15 | 62 | 11 | 33 |
| 20 | 68 | 16 | 18 |
| 25 | 68 | 20 | 10 |
| 30 | 75 | 22 | 5.6 |
| 35 | 75 | 24 | 3.3 |
| 40 | 75 | 24 | 2.2 |

FM FREQUENCIES BY CHANNEL NUMBER

For convenience, the frequencies available for FM broadcasting (including those assigned to noncommercial educational broadcasting) are given numerical designations which are shown in the table below:

| Channel No. | Frequency (MHz) | Channel No. | Frequency (MHz) |
|-----------------------------|-----------------|-------------|-----------------|
| EDUCATIONAL CHANNELS | | | |
| 201 | 88.1 | 211 | 90.1 |
| 202 | 88.3 | 212 | 90.3 |
| 203 | 88.5 | 213 | 90.5 |
| 204 | 88.7 | 214 | 90.7 |
| 205 | 88.9 | 215 | 90.9 |
| 206 | 89.1 | 216 | 91.1 |
| 207 | 89.3 | 217 | 91.3 |
| 208 | 89.5 | 218 | 91.5 |
| 209 | 89.7 | 219 | 91.7 |
| 210 | 89.9 | 220 | 91.9 |
| COMMERCIAL CHANNELS | | | |
| 221 | 92.1 | 261 | 100.1 |
| 222 | 92.3 | 262 | 100.3 |
| 223 | 92.5 | 263 | 100.5 |
| 224 | 92.7 | 264 | 100.7 |
| 225 | 92.9 | 265 | 100.9 |
| 226 | 93.1 | 266 | 101.1 |
| 227 | 93.3 | 267 | 101.3 |
| 228 | 93.5 | 268 | 101.5 |
| 229 | 93.7 | 269 | 101.7 |
| 230 | 93.9 | 270 | 101.9 |
| 231 | 94.1 | 271 | 102.1 |
| 232 | 94.3 | 272 | 102.3 |
| 233 | 94.5 | 273 | 102.5 |
| 234 | 94.7 | 274 | 102.7 |
| 235 | 94.9 | 275 | 102.9 |
| 236 | 95.1 | 276 | 103.1 |
| 237 | 95.3 | 277 | 103.3 |
| 238 | 95.5 | 278 | 103.5 |
| 239 | 95.7 | 279 | 103.7 |
| 240 | 95.9 | 280 | 103.9 |
| 241 | 96.1 | 281 | 104.1 |
| 242 | 96.3 | 282 | 104.3 |
| 243 | 96.5 | 283 | 104.5 |
| 244 | 96.7 | 284 | 104.7 |
| 245 | 96.9 | 285 | 104.9 |
| 246 | 97.1 | 286 | 105.1 |
| 247 | 97.3 | 287 | 105.3 |
| 248 | 97.5 | 288 | 105.5 |
| 249 | 97.7 | 289 | 105.7 |
| 250 | 97.9 | 290 | 105.9 |
| 251 | 98.1 | 291 | 106.1 |
| 252 | 98.3 | 292 | 106.3 |
| 253 | 98.5 | 293 | 106.5 |
| 254 | 98.7 | 294 | 106.7 |
| 255 | 98.9 | 295 | 106.9 |
| 256 | 99.1 | 296 | 107.1 |
| 257 | 99.3 | 297 | 107.3 |
| 258 | 99.5 | 298 | 107.5 |
| 259 | 99.7 | 299 | 107.7 |
| 260 | 99.9 | 300 | 107.9 |

NOTE: The frequency 108.0 MHz is assigned to aircraft navigation service subject to the condition that there will be no interference with the reception of FM broadcast stations, present or future.

PROGRAM AUTOMATION



Program Automation Systems

In keeping with Gates' goal to supply broadcasters with the most versatile program automation systems available, the company now provides an advanced digital-design touch-control automation concept.

At the heart of Gates' touch-control program automation systems are five control units. These units employ the latest in digital technology to add even further to the capabilities, flexibility and reliability of Gates' systems. The units include: KSP-10 Digital System Programmer; RA-10 Random Access Digital Programmer; TS-4 Digital Time Selector; Digital Clock; and SSC Digital System Switching Center.

Digital program automation has been designed by Gates to bring you a totally "live" sound, while allowing you to hold down costs and improve production through more efficient utilization of manpower. Every Gates system is a custom installation, as each is tailored to the broadcaster's particular needs. Standard modular components are employed so that the system may be changed or expanded easily at any time.

Also designed for ease of operation, Gates' systems feature keyset touch controls and convenient numerical readouts. These readouts allow immediate verification of operational

sequence and upcoming events, and display numerically such information as exact time, time corrections, and the nature of the corrections by code function. Programming Gates' systems is uncomplicated, as all instructions are numbers, and no special computer language is required. Station staff members will be able to operate any Gates system after a minimum of instruction.

When considering automation, the broadcaster must exercise great care in selecting a system that fits his exact programming requirements. The philosophy behind Gates automation is to create a system to fit the format, rather than change a format to fit the system. At the same time, all Gates automation systems can be easily expanded as the station prospers . . . utilizing standard control components . . . at the lowest possible cost consistent with quality. Gates' program automation offers a realistic means of obtaining substantial operating economies while building a superior and more saleable program product.

To learn how Gates program automation can benefit your operation, contact your Gates District Manager, or a Gates Broadcast Automation Specialist.



View of Gates' automation demonstration studio in Quincy, Illinois, showing a digital touch-control system. The studio is designed for station management and engineering evaluation of broadcast automation techniques.

KSP-10 Programmer And SSC System Switching Center

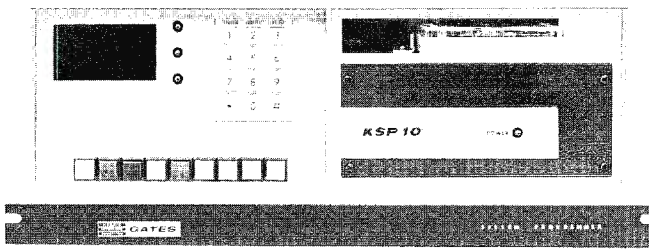

KSP-10 PROGRAMMER

Gates' KSP-10 Digital Touch-Control System Programmer provides fully automatic control of an automation programming system when used in conjunction with Gates' SSC Switching Center. It can sequentially call on up to 10 audio sources, such as cartridge, reel-to-reel, network, remote or audio console output. Time correction and sub-programmer block advance information may also be entered into the magnetic cartridge memory of the KSP-10. Any stored event within the tape cartridge memory may be changed at any time simply by accessing that event and rewriting it. An entry error may be immediately corrected by following it with an ERROR entry, then rewriting it. This eliminates the necessity of reprogramming the entire memory tape because of an entry error or any desired change in programming information.

Unassigned events, time correction and sub-programmer block advance information space may be reserved in the memory tape by entering a "Skip" event at any place desired in the memory sequence. They may be later accessed and programmed at any time to change or expand the operating sequence.

Five digits of information (source numbers, time correction

entries, etc.) are stored in approximately one second of tape time. The average half hour in a Top-40 format would require almost 5 seconds of memory tape, so a typical 18-hour broadcast day can be programmed on a 3-minute cartridge.

An important verification feature of the KSP-10 permits the use of audio tape, rather than certified digital tape, for encoding the BCD signals in the memory cartridge. Each digit must be verified by actually reading the recorded signal in the "write" portion of the read/write head before an entry sequence is complete. If tape drop-outs are encountered, the KSP-10 will automatically re-enter the command until full verification is received. Each incomplete entry will receive an error code as a part of the re-entry cycle, so the incomplete entry will always be skipped in the playback service.

The magnetic memory portion of the KSP-10 consists of a cartridge tape transport similar to Gates' Criterion Compact. The front panel of the tape transport contains only an LED power indicator. Full control of the tape deck is obtained through the manual and automatic operation of the associated programming section of the KSP-10. Convenient keyset touch controls mean faster, easier operation. Both sections have removable rear interconnecting cables, and slide-out of the twin rack-mount housing for easy maintenance.

SPECIFICATIONS

MEMORY CARTRIDGE: NAB size A or B.

INPUTS: Maximum of 10 sources, including RA-10 Sub-Programmer.

POWER REQUIREMENTS: 117 volts ($\pm 10\%$), 60 Hz (50 Hz available).
Power consumption: 90 watts maximum.

EMERGENCY POWER: External 12-volt source required.

DIMENSIONS: 7 in. high, 19 in. wide, 14 in. deep.

WEIGHT: 36 pounds.

ORDERING INFORMATION

KSP-10 Digital System Programmer (60 Hz).....994-6970-001
KSP-10 Digital System Programmer (50 Hz).....994-6970-002

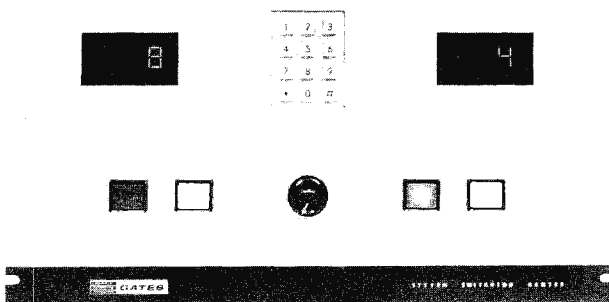

SSC SWITCHING CENTER

The Digital Touch-Control SSC is the switching center and control point of the KSP-10 program automation system. Nearly all of the control commands, control responses, audio programming, auditioning, logging, etc., are routed through

the SSC for precision switching and processing. The Switcher circuitry prevents the accidental starting of two or more sources automatically, and will not connect any source to the program buss when started with the source machine switches. The SSC System Switching Center will connect up to 10 system sources to the control and output circuitry of the system. Both sub-programmer controlled sources and main programmer controlled sources connect to the SSC Switcher. A nine source extender for the SSC is available for expanding the system from 10 to 19 source capability when the RA-10 is used in the system.

ORDERING INFORMATION

SSC Digital System Switching Center
(with 10 channel modules).....994-7031-001
Nine Source Extender (less channel modules).....994-6881-001
Source Channel Module.....994-6882-001
Booster Amplifier (order one for stereo).....994-6883-001

SC-48 Simplex Programmer

This easy-to-operate programmer is readily adapted to a sophisticated program schedule to provide variety in generating a "live" sound. The unit controls as many as nine sources in any combination of cartridge and reel-to-reel units. Thumb-wheel selectors are used to sequentially select the order of source appearance in the program. Up to 48 events can be sub-divided into two, four, or eight program segments with 24, 12 or 6 events in each segment.

A time pulse generator associated with the SC-48 programmer is capable of providing up to four individual time corrections each hour. The actual correction time of each is determined by four rotary switches marked in five-minute increments. These switches are adjustable internally so that the exact time of correction may be offset from the true five-minute point. The rotary selector switch of each time correction point may be disabled if less than four corrections per hour are desired.

The program need not fade when it is time to make a time correction. Rather, after the selection playing is completed, the programmer will skip to the first event of the next program segment. In this way it is not necessary to exactly time program content and "fill" material can easily be added to each segment. Unused fill material is automatically skipped, assuring desired continuity.

OPC-3A accessory provides controlled audio overlap capability in SC-48 automation systems.

With additional optional equipment it is possible to use the SC-48 programmer in an exact time correction system which will fade program material immediately upon correction by the time pulse generator and skip to the first event of the next program segment, which could be either network news or a spot or cartridge into preceding network news. A system of this type is fully capable of joining a network during unattended operation.

No changes in internal programmer wiring are needed to add or change audio sources controlled by the SC-48. A

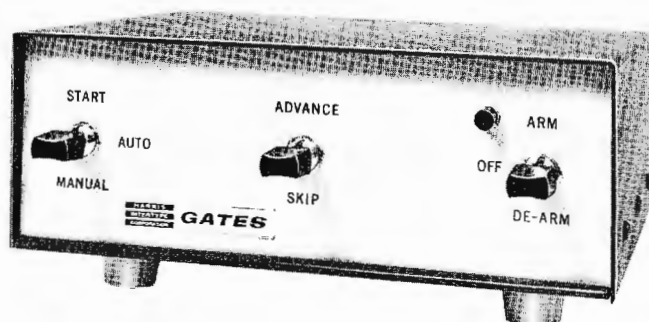

RC-48A Remote Control Unit. Provides manual control of primary SC-48 Programmer functions: Start/Stop; Advance/Skip; and Arm/De-Arm.

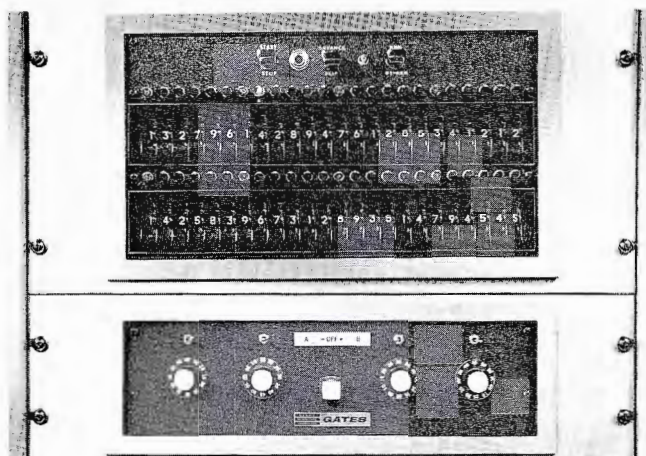

socket is provided for each source. To add or change sources, it is only necessary to plug-in the tape unit's connecting cable at the back of the unit.

All relays used in the programmer are plug-in and completely sealed to provide protection from dust and dirt. Relays have gold contacts to assure dependable operation and years of trouble free service, even under demanding broadcast reliability standards.

SPECIFICATIONS

- INPUTS:** Maximum of nine sources.
- SOURCE SELECTION:** Maximum of nine by thumbwheel switch.
- SEQUENTIAL EVENTS:** Forty-eight before repetition.
- TIME CORRECTIONS:** One, two, three or four may be inside each hour at any five-minute time during the hour.
- SENSING:** 25 Hz, left channel only (silence sensing on special order).
- CONTROL VOLTAGES:** 24-volt DC self-contained power supply.
- POWER SOURCE:** 105-125 volts, 60 Hz. (50 Hz available)
- RELAYS:** Plug-in with dust covers. AE stepping switch with gold-plated contacts.
- AUDIO OUTPUT:** 600 ohms, balanced, -4 dBm.
- AUDITION CIRCUIT:** Headphone and rear panel output.
- TIMER PULSE:** One circuit each 2½ minutes. Two circuits vernier adjustable within 2½ minute increments.
- HOUSING:** Rack mount with slide-out chassis.
- SIZE:** (SC-48 w/25 Hz detector) 8¾" H x 19" W x 15" D.
(Time pulse generator) 5¼" H x 19" W x 15" D.

ORDERING INFORMATION

- SC-48 Program Control System, 9-source, 60 Hz. Includes:
SC-48 control panel and TPC-2 time pulse generator.....900-0225-001
- As above, except 50 Hz.....900-0225-002
- OPC-3 Overlap Program Control accessory for SC-48. Provides audio overlap in automation system.....900-0146-001
- RC-48A Remote Control Unit.....900-0089-002

Multiple Cartridge Reproducers

CRITERION 855

With ample capacity for broadcast and storage of 55 NAB type A tape cartridges, and using the performance-proven Criterion 80 playback unit, the Criterion 855 provides increased flexibility for automation systems, while assuring excellent audio broadcast quality. It can be added to any Gates automation system.

Up to 55 cartridges are placed in the rack in the exact order they appear on the broadcast schedule. The deck moves from top to bottom and stops only at the slots which have a cartridge. It pulls the cartridge into position on the deck, and positively locks it against the microset head assembly, assuring unsurpassed audio quality.

SPECIFICATIONS

AUDIO OUTPUT: 600 ohms +12 dBm maximum, (150 ohms optional) balanced.
FREQUENCY RESPONSE: ± 2 dB 70 to 12,000 Hz, ± 4 dB 50 to 15,000 Hz.
DISTORTION: Record to playback, 2% at 0 VU record level, 400 Hz.
NOISE: 55 dB below tape signal reference of 400 Hz with 3% THD.
RECYCLE TIME: 62 seconds from rejection of bottom cartridge until top cartridge is ready. Four seconds from shelf to shelf.
SIZE: 77 $\frac{1}{2}$ " high x 22" deep x 23 $\frac{3}{4}$ " wide. Net weight, 405 lbs.

ORDERING INFORMATION

Criterion 855-M Multiple Cartridge Unit, monophonic, 60 Hz.....900-0028-003
Criterion 855-S Multiple Cartridge Unit, stereophonic, 60 Hz.....900-0029-003

NOTE: Above units sold less side panels for installation in automation systems. If panels desired, use 2 each, RAK-70 side panels (see page 141).

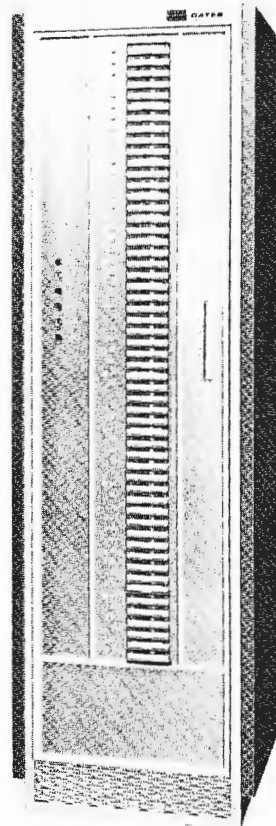

G-824 CAROUSEL®

Gates' G-824 Carousel tape unit is a rotary drum mechanism for tape cartridges that can be operated by manual, automatic, and random access selectors. Each drum holds a maximum of 24 standard cartridges, and revolves to allow positioning of the cartridges against the stationary transport. The G-824 positions cartridges in sequence unless an optional random access unit is employed.

G-824 mono and stereophonic units are compatible with most existing automation systems. Modular solid-state electronics provide for the NAB standard controls of 1000 Hz, 150 Hz, and 8000 Hz. In addition, logic control of the start-stop functions may be used.

Exclusive Gates features adapted from the Criterion 80 cartridge machine for improved reliability include the microset head assembly and vapor-blasted large diameter capstan drive for increased torque and superior audio reproduction.

All units are Random Accessible with optional accessories. A manual remote control or a Random Access Programmer for automated use are available.

SPECIFICATIONS

AUDIO OUTPUT AND DISTORTION: +4 VU max. into 600 ohms (less than 1% THD) from NAB reference level tape.
FREQUENCY RESPONSE: +1 dB to -2 dB 50-12,000 Hz at 7 $\frac{1}{2}$ ips.
SIGNAL-TO-NOISE RATIO: -56 dB @ 7 $\frac{1}{2}$ ips (mono), -52 dB @ 7 $\frac{1}{2}$ ips (stereo).
SIZE: 19" wide x 19" deep x 19 $\frac{1}{4}$ " high. Net weight, 95 lbs.

ORDERING INFORMATION

G-824-M Multiple Cartridge Unit, monophonic, 60 Hz.....994-7036-001
G-824-S Multiple Cartridge Unit, stereophonic, 60 Hz.....994-7037-001

NOTE: Above units include Gates' exclusive features and Carousel interface for extended logic and control in automation systems. Carousel interface available separately (order 994-6985-001).



Random Access Programmers

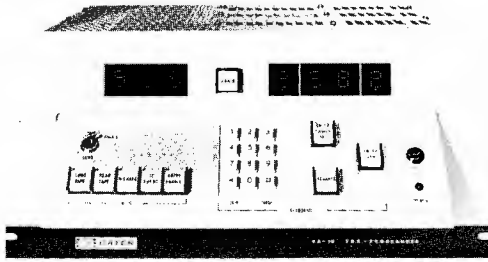

MODEL RA-10

Gates' RA-10 is a digital touch-control random access sub-programmer capable of controlling up to 10 Gates' G-824M/S Multiple Cartridge Reproducers, or other program sources with 1 to 99 shelf addresses. Its MOS IC Read/Write Memory has a capacity of 1,000 events that may be programmed by its telephone-type keyset, or from a magnetic storage tape. Any one of 10 function codes may be programmed with each event to perform a variety of special system operations, such as the End-Of-Cluster function.

Seven Numitron® readouts display the following: EVENT (3 digits), SOURCE (1 digit), SHELF (2 digits) and FUNCTION (1 digit). Keyset control is provided by the ENTER SOURCE/SHELF or ENTER EVENT pushbuttons, which permit convenient data entry for any desired event or the associated source/shelf/function information. Entry or editing of one section of the 1,000-event memory does not interfere with the system operation of any other section.

A unique feature of the RA-10 and associated system control units permits the main programmer to move the RA-10 to any desired new event in its memory to provide a change from one block of programming to another. With the 1,000 event capacity, this greatly increases system flexibility. Repetitive segments of programming, such as special newscast formats, may be entered into the RA-10 memory once and called upon many times throughout the day.

A charging circuit is built-in for the rechargeable Gel-Cell® battery, which is used to keep the MOS Memory information valid during AC power dropouts. Source interface cards are provided for controlling up to four G-824M/S Multiple Cartridge Reproducers. Additional dual-source plug-in cards may be ordered below. Sources which are not random accessed, such as Criterion 855, do not require interface cards.

SPECIFICATIONS

TAPE LOAD OUTPUT: TTL and DTL compatible. BCD data in and out.

POWER REQUIREMENTS: 117/234 volts ($\pm 10\%$), 50/60 Hz single phase, 150 watts maximum.

DIMENSIONS: 8¾" high, 19" wide, 16½" deep.

WEIGHT: 28 pounds.

ORDERING INFORMATION

RA-10 Digital Touch-Control Random Access Programmer...994-6969-001

Plug-in Dual-Source Interface Card (each card controls two G-824M/S Multiple Cartridge Reproducers).....992-3443-001

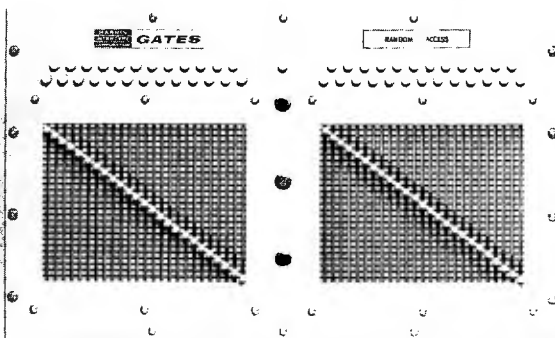

MODEL RA-1

Gates' RA-1 random access unit is intended to provide random selection for a single Gates multiple cartridge reproducer (G-824M/S).

Assignment of cartridge sequence is determined by the positions of fifty vertical slider switches located on the front panel of the equipment. Thus, fifty selections can be made from any of the 24 shelves in the G-824 before repetition or re-programming. The fifty-step sequence is repetitive in that

step one follows step fifty, and the sequence may be shortened to less than fifty events by setting any of the sliders to the lowest, or 25th position. This is the "S" or SKIP position. The usual procedure for setting up the RA-1 involves setting slider number 1 (left side) to the shelf number containing the first desired tape cartridge. Each succeeding slider, in sequence, is set as required to indicate the desired sequence of shelf assignment for the G-824. The INDEX button is pressed once to initiate the action required to access the first selected tape cartridge.

It is possible to alter the sequence midway so that a cartridge already selected will be rejected. This may be accomplished through the use of the ADVANCE and INDEX buttons, even though a tape cartridge is playing at the time.

The RA-1 measures 10½" H x 19" W x 10" D, and is intended for standard rack mounting. The device is completely solid state, making use of SCR's for counting. Control signals and power are supplied from the service unit assembly of the G-824 unit.

ORDERING INFORMATION

RA-1 Random Access Programmer for use with single G-824M/S Multiple Cartridge Reproducer.....900-0191-002

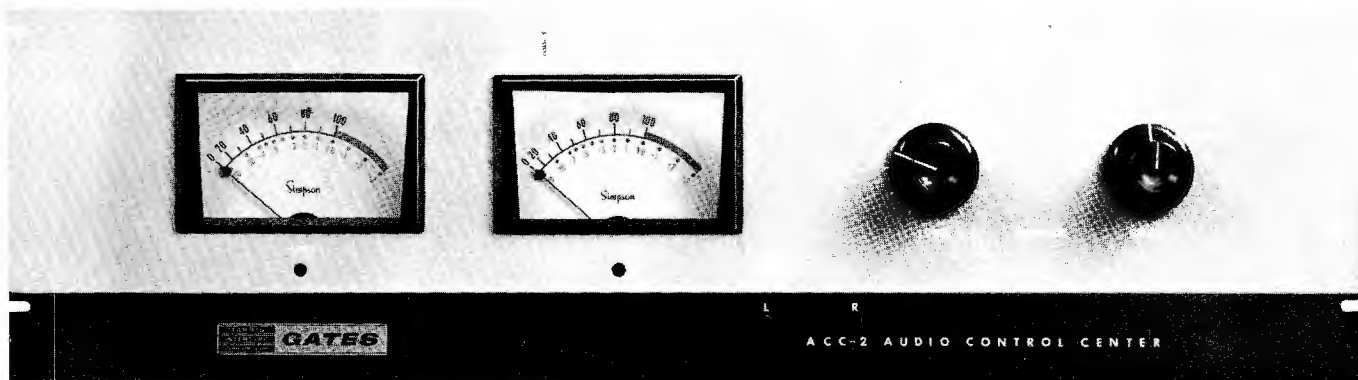

ACC-2
STEREO
AUDIO
CONTROL
CENTER

AUDIO CONTROL CENTER

The ACC-1 and ACC-2 audio control centers provide a consolidated program output and monitoring unit for Gates' program automation systems. Solid-state modular amplifiers, as used in Gates' studio audio consoles, provide outstanding performance, with program amplifier output capability up to +26 dBm (+8 dBm nominal), and plug-in monitoring amplifiers at 10 watts (+40 dBm) per channel.

Both the monophonic ACC-1 and stereophonic ACC-2 control centers accept 25 Hz high-pass filter(s) for use in automation systems with reel-to-reel tape audio sources. The ACC-2 stereo audio control center also provides for the installation of an optional L + R sum channel output amplifier. Power supplies and all modular amplifiers plug into the rack-mount chassis.

The audio control center front panel facilities include VU metering, monitor gain control, and meter/monitor selector switch for visually and aurally checking: PGM, program output; CAL, processing equipment such as overlap, etc.; AUD, audition; and EXT, external audio source such as an air monitor.

In stereophonic ACC-2 units, a fifth switch position (NULL) provides an accurate check of channel phasing. Adjustment of program output levels is by screwdriver through access holes in the front panel.



ACC-1 MONOPHONIC AUDIO CONTROL CENTER

The Gates ACC-1 monophonic audio control center is fully self-contained in a 5¼-inch rack-mounted unit. The ACC-2 stereophonic package includes a separate 3½-inch power supply panel which may be mounted adjacent to the ACC-2 control center or separated up to ten feet. External connections are to terminal strips in the rear of all units.

SPECIFICATIONS

PROGRAM INPUT: 600 ohms, balanced. -40 to -7 VU for full output level, +8 dBm nominal.

AUDITION/EXTERNAL INPUTS: Bridging or matching as a function of input pad configuration. -25 to +14 VU.

GAIN: System input to program output, 21 dB nominal, 41 dB \pm 2 dB maximum. Adjustment of fixed pads can accommodate input levels of -40 VU for systems with complex pre-processing losses.

RESPONSE: 30 to 15,000 Hz \pm 1 dB.

DISTORTION: Program circuits 0.5% maximum 30 Hz to 15 kHz @ +18 dBm output; 1.0% maximum @ +26 dBm output. Monitor circuits 1.0% maximum 30 Hz to 15 kHz @ +40 dBm output (10 watts).

NOISE: -75 dB or better, 30 Hz to 15 kHz on all circuits with normal levels and control settings (-30 dBm input and +18 dBm output for program channels).

POWER: 117 volts, 50/60 Hz, 1 phase. 100 watts maximum for full stereophonic package.

SIZE: ACC-1 (complete) and ACC-2 audio section—front panel 5¼ inches high, 19 inches wide, 15½ inches deep behind front panel. ACC-2 power supply—3½ inches high, 19 inches wide, 15½ inches deep.

ORDERING INFORMATION

ACC-1 Audio Control Center, monophonic. Includes program amplifier. Less monitor amplifier, 25 Hz filter (order separately) ----- 900-0273

ACC-2 Audio Control Center, stereophonic. Includes two program amplifiers and power supply. Monitor amplifiers and 25 Hz filters must be ordered separately----- 900-0274

ACC/MON Monitor Amplifier Module. Order 2 for stereo----- 900-0276

ACC-F 25 Hz High-Pass Filter. For systems with reel-to-reel music sources. Two required for stereo----- 484-0066

ACC/SCN Sum Channel Output Package. For ACC-2 units if L + R output desired. Includes 3rd program amplifier module ----- 900-0277

Automation Systems Equipment

TIME ANNOUNCER

Gates' time announcer system provides pre-recorded time announcements automatically at the discretion of an operator or according to the pre-schedule of an automation system. Two standard Criterion 80 cartridge tape playback units are used (one for odd-minute announcements, one for even minutes), and are automatically synchronized by the time announce control unit. An external time pulse source is required by the unit. Systems with automatic program logging may utilize a digital clock, or use the TPM module listed below.

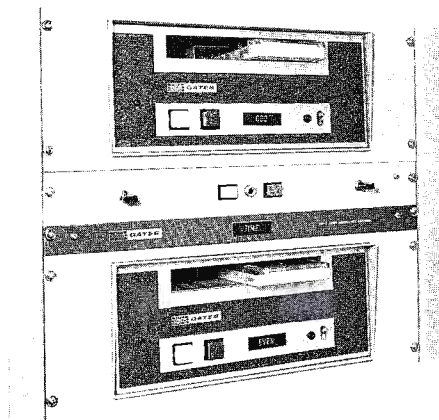

ORDERING INFORMATION

| | |
|--|--------------|
| TA-1 Control Panel (also requires 2 Criterion 80 cartridge playback units and either DC-10 Clock or Time Pulse Module) | 900-0056-001 |
| TA-2 Control Panel (also requires 2 Criterion 80 cartridge playback units and Digital Clock) | 900-0056-002 |
| TPM Time Pulse Module | 900-0192-001 |

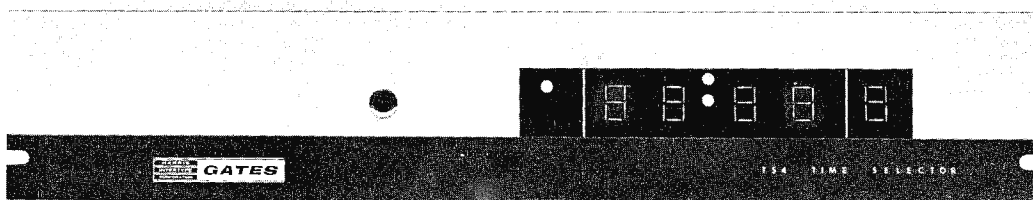

TS-4 DIGITAL TIME SELECTOR

The Gates TS-4 Digital Time Selector is an exact time control device that performs a switching function on a time-programmed basis in Gates' KSP-10 automation systems. "Time assignment" instructions are stored in the KSP-10 memory tape cartridge and are supplied to the TS-4 as required. Real time information is provided by Gates' Digital Clock, which is required in a system incorporating the TS-4 time selector.

Typical operation of the TS-4 would consist of exact time operation of the automation system for network joining,

exact time station identifications, to control back-timed audio sources, etc. The time selector will operate only in conjunction with a Gates' Digital Clock and the KSP-10 programmer.

ORDERING INFORMATION

| | |
|-----------------------|--------------|
| TS-4 Time Selector | 994-6909-001 |
| Digital Clock (60 Hz) | 994-6759-001 |
| Digital Clock (50 Hz) | 994-6759-002 |

NETWORK JOINING

Network joining with an automation system is accomplished by system logic apparatus synchronized by a real-time clock base associated with the system. Depending on the broadcaster's preference, network joining usually incorporates fade-in or fade-out of program material.

The Gates MDF-M (mono) and MDF-S (stereo) Motor-Driven Faders provide an economical method of smoothly fading down programming to skip and join a network or other source on an exact time basis.

The Gates F1-M (mono) and F1-S (stereo) Fade-In Units are designed to start a theme or other program material at a pre-determined interval before an exact-time event, and

smoothly fade into that source so that the material will conclude precisely before starting the next event, typically a network program. The fade-in unit is used with a specific audio source, normally a Criterion 80 tape cartridge unit, for playing the pre-timed music selections.

ORDERING INFORMATION

| | |
|---|--------------|
| MDF-M Motor-Driven Fader, monophonic | 900-0044-001 |
| MDF-S Motor-Driven Fader, stereophonic | 900-0067-001 |
| F1-M Fade-In Unit, monophonic. (Requires Criterion 80 audio source) | 900-0255-001 |
| F1-S Fade-In Unit, as above except stereo | 900-0255-002 |

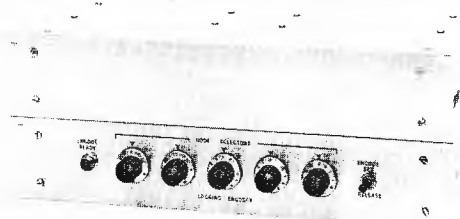

Logging Encoder

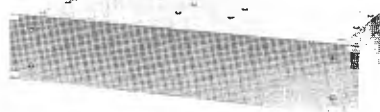

Logging Decoder



Digital Clock

*Plunger
358-0948-000
Gromit
358-0947000*

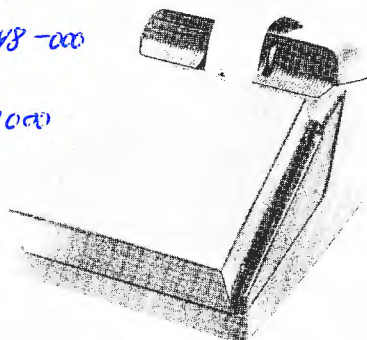

Logging Printer

AUTOMATIC PROGRAM LOGGING

Gates' system of automatic program logging provides an accurate, printed record of programming actually broadcast. This system has been the basis for FCC license renewal at many automated broadcast stations and meets FCC log verification requirements. A logging printer, similar to an adding machine, prints the time at which each source in the system is started, along with a five digit code for all entries which require identification. If identification is not required, the code is automatically replaced by five zeros, making all logging complete.

The program logging equipment consists of a logging encoder for recording a five digit logging code on the control track of any tape cartridge; a logging decoder for reading the five digit code during playback; a logging printer to print the broadcast time and the logging code; and a solid state clock interface card. (A solid state Digital Clock must also be included in the system.)

DIGITAL CLOCK

The Gates Digital Clock (shown above) is used in Gates' program automation as a centralized source of real time information, and provides this information for the systems time selector and automatic program logging equipment. The Digital Clock may also be used to control the operation of auxiliary apparatus within the program automation system or external non-related equipment. Hours, minutes and seconds are displayed on 7-segment readouts. A multiple card holder is provided on the rear for plug-in interface cards to operate other equipment.

When driven from the AC line input, the Digital Clock is as accurate as the power company frequency allows. This frequently permits clocks to wander around several seconds, however, and is not adequate for joining network or other events requiring precise timing. The Clock Frequency Stand-

SPECIFICATIONS

- RECORD PRINT-OUT:** Standard adding machine tape . . . may be set single, double or triple space.
- PRINT-OUT INFORMATION:** Time and five digit code.
- TIME PRINT-OUT ACCURACY:** Within 30 seconds of time shown on print-out tape.
- OPERATION:** Uses 8 kHz tone pulse clusters on cartridge control track to form digits.
- POWER SOURCE:** 105-125 volts, 2 amps, 60 Hz.

ORDERING INFORMATION

- APL-G Automatic Program Logging System for use with KSP-10 or SC-48 systems. Includes logging encoder, logging decoder, logging printer, and solid state clock interface card. (A Digital Clock must be used with this system.) 60 Hz.....994-7032-001
- As above, except 50 Hz.....994-7032-002
- CG-8 Special Code Generator (optional). Provides 8 different five digit logging codes to identify non-cartridge automation sources such as network, live studio, etc.....900-0040-001

ard is available in either a 60 Hz or 50 Hz model to plug into the Digital Clock. No other change is required to guarantee accuracy within one second per month, which is more than adequate for the operation of automation systems on a real time basis. Either 12-hour or 24-hour time information is obtainable.

ORDERING INFORMATION

- Digital Clock (60 Hz line frequency).....994-6759-001
- Digital Clock (50 Hz line frequency).....994-6759-002
- 60 Hz Clock Frequency Standard (optional)*.....994-6828-001
- 50 Hz Clock Frequency Standard (optional)*.....994-6828-002
- 5-digit Logger Card.....994-6830-001
- Battery (4 required) for emergency power supply.....660-0024-000

*With the Clock Frequency Standard module, the Digital Clock may be used either on 50 or 60 Hz.

AUTOMATIC CLEAR-TEXT PROGRAM LOGGING

An accurate program log is an absolute necessity for any AM or FM station. Performed manually, this can be a difficult and time-consuming task for station personnel . . . but it is greatly simplified for the automated station with Gates' Clear-Text Program Logging.

INSTANT VERIFIED LOGGING: In designing the alpha/numeric (ANL) system, Gates had two basic goals in mind:

1. To provide Clear-Text printed copy as the logging output from an automation system, with true verification of the program content on-the-air.
2. To provide a "computer-compatible" system which can be interfaced with standard data processing equipment at the station or remote locations.

Gates' Clear-Text Program Logging provides printed lines of data from the control track of a tape cartridge as the program material is broadcast. A considerable amount of information about the particular audio message can be reproduced on the log sheet in text form, including: identification code; broadcast time; program name and length; and commercial or public service announcement name and time. Data impulses are decoded directly from the material being broadcast and, unlike other "printed logs", prints what actually played—not what is hoped was played. This is verified program logging for modern management.

THE LOGGING LANGUAGE: In setting up the ANL Clear-Text Logging System, Gates selected the ASCII Code (American Standard Code for Information Interchange). This commonly-used EDP code makes the Gates' Automation System compatible with most major data processing systems of computer terminals. The Gates' logging concept may be employed with your present or future EDP system—computer, magnetic tape, disc, punched cards or tape.

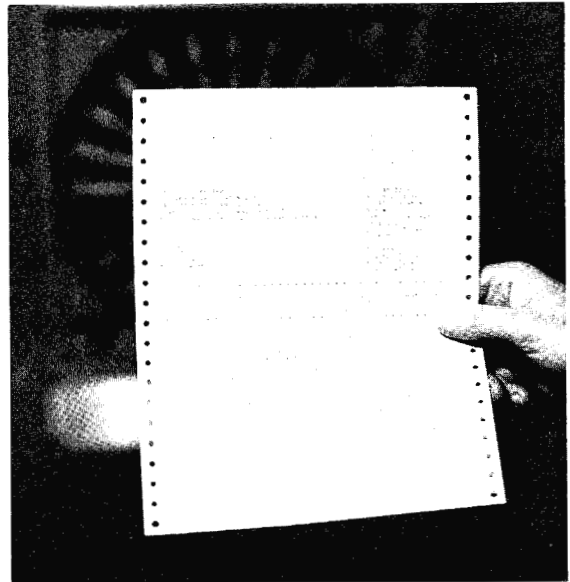
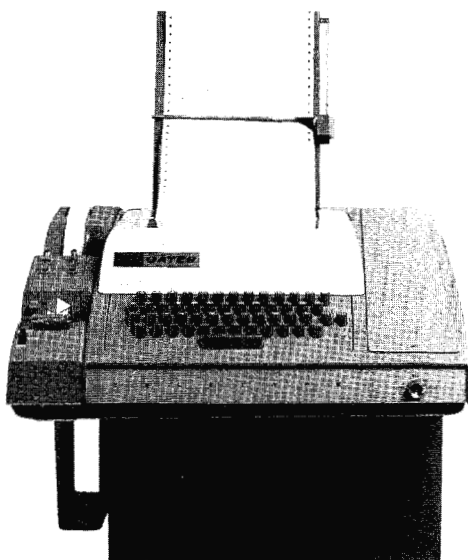

PREPARATION: After producing the program content of the commercial, the tape cartridge is encoded with all the pertinent data to be retrieved at air time. This step employs a Criterion 80 cartridge unit and suitable ASCII data device of the customer's choice. This equipment is interfaced with the Criterion cartridge record amplifier for the purpose of encoding control tracks of broadcast tape cartridges.

COMPLETE INFORMATION: The product of the page printer in a system is capable of providing all of the information required by the FCC, since it is an accurate record of what was broadcast. In addition to commercial announcements and public service announcements, programs can be logged by providing a cartridge with an opening theme; time announcements can be logged, since length of the audio message is not a consideration. Time information is recovered from a digital clock each time decoding starts.

OTHER SYSTEM USES: The "computer compatibility" of Gates' Clear-Text logging approach frees much of the system for applications in other data acquisition areas of the broadcast operation . . . or vice-versa. Since encoding of commercial cartridges can be accomplished from a wide variety of EDP devices, the special equipment required within the program automation system itself is minimized. As compared to a standard broadcast automation system, additional components required for ANL/Clear-Text Program Logging are: ASCII encoder and decoder electronics; ASCII source modules for each logging source; and a page printer of the station's choice. A unit such as the 33ASR printer/keyboard with tape reader and punch can serve both as encoding terminal and/or decoding page printer with feed to DataPhone, etc. At the end of the day, this tape is fed into a high-speed reader which is coupled by DataPhone to a leased computer center. Here the information for each account is stored, and re-leased in the form of itemized bills each month.

ORDERING INFORMATION AVAILABLE ON REQUEST

GateSound Programming

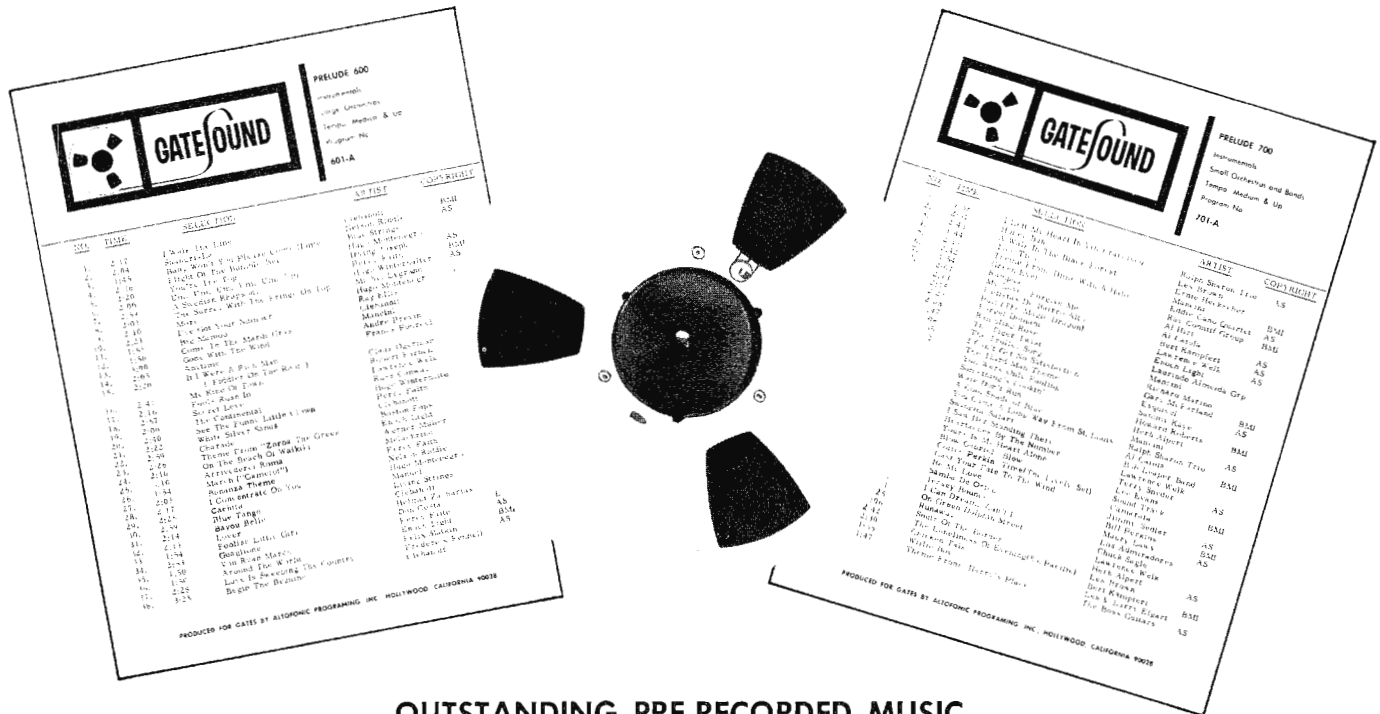

OUTSTANDING PRE-RECORDED MUSIC

GateSound is designed to provide you with a basic taped music library of selections with the widest possible appeal. These tapes are intended as a starter package of musical programming for automation systems, and are appropriately named the "Prelude" series. They are equally suitable for any broadcaster wishing to expand a tape library simply and economically.

TYPE OF MUSIC: All-time country and western favorites, show tunes, motion picture sound tracks and great standards are presented in vocal and instrumental arrangements, carefully selected for "middle-of-the-road" content, to serve as a sound base on which to build your future programming. Selections likely to become outdated are not included, to assure a modern, up-to-date sound for your listeners.

PRODUCTION QUALITY: The "Prelude" series is produced exclusively for Gates by AltoFonic Programming, Inc. While these tapes are completely separate from the library services of AltoFonic, the same expert programming know-how and professional recording techniques are utilized to produce tapes of amazing fidelity and consistency. These tapes are exclusive through GateSound, and not available elsewhere.

BASIC CATEGORIES: GateSound "Prelude" series separates music into these categories:

- Prelude 200—Vocals, Male.
Up-tempo country and western selections.
- Prelude 300—Vocals, Male.
Medium and slow tempo country and western selections.
- Prelude 400—Vocals, Female and Group.
Mixed tempo country and western selections.

- Prelude 500—Instrumentals.
Mixed tempo country and western selections.
- Prelude 600—Instrumentals.
Standard and popular selections, M-O-R.
- Prelude 700—Instrumentals.
Standard and popular selections, M-O-R.
- Prelude 800—Vocals, Mixed.
Standard and popular selections, M-O-R.
- Prelude 900—Instrumentals, Mixed.
Mixed tempo conservative standard selections.

Comprehensive coverage of all recording companies provides the most extensive musical variety within the categories. Complete listings are available on request for ordering information.

TAPE DATA: "Prelude" tapes are unannounced for maximum flexibility in any operation, and allow the use of local voices if desired. All tapes are supplied on 1.0 mil polyester tape. Bi-directional tapes are supplied with metallic foil at both ends for reversing systems. All music is matched at both ends (no fading).

A 25 Hz tone, 5 dB below program reference level and 1.5 seconds long, appears 1.5 seconds before the end of each selection. This tone is followed by one second of silence, then the next selection begins exactly 2.5 seconds after the beginning of the tone. On stereo tapes the tone appears on the left channel only.

Tapes are available in 10½ or 14 inch reel sizes, and in any popular track configuration. The entire GateSound library is available in monaural or stereo.



Touch Control Automation System

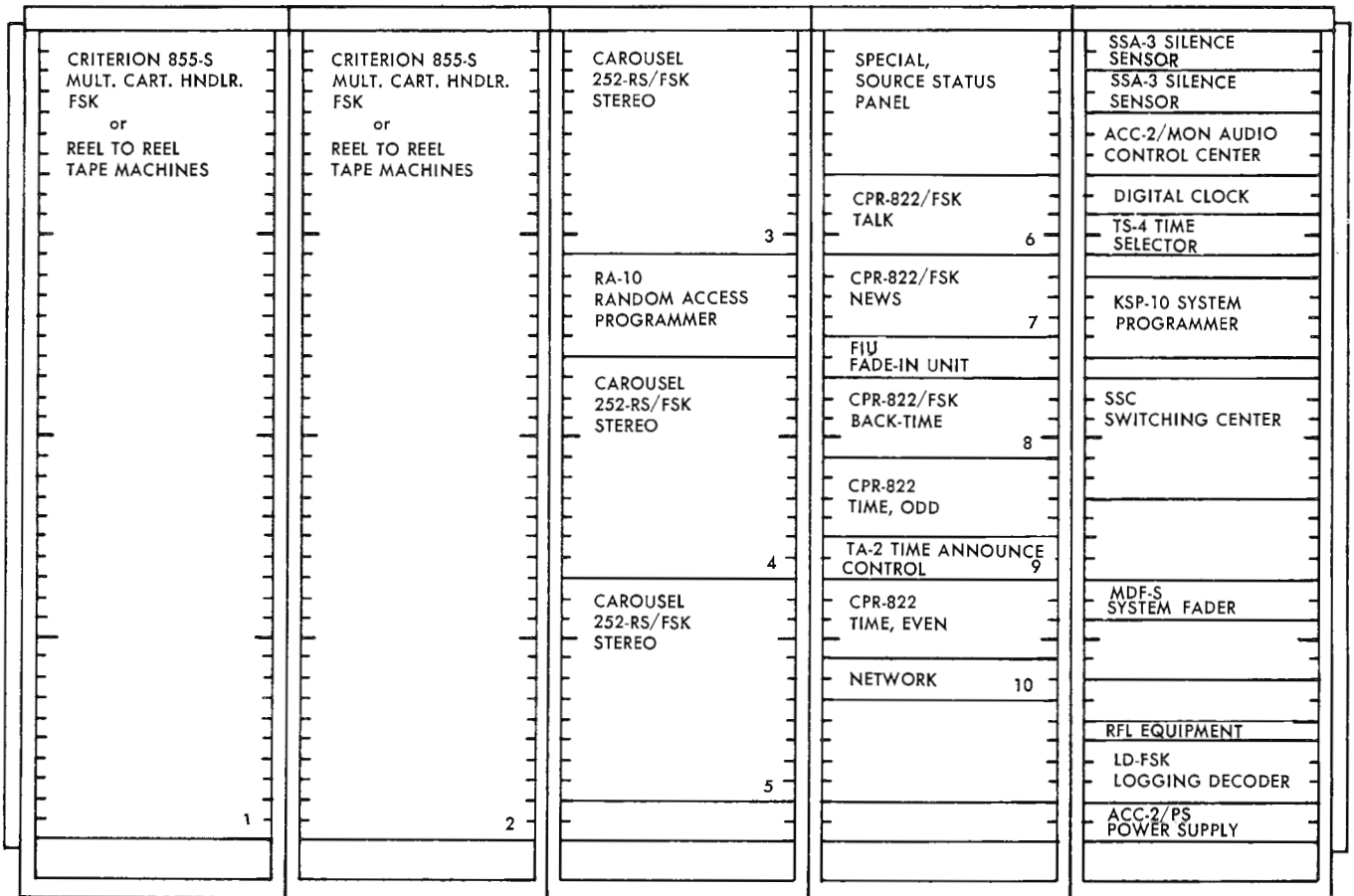

RACK LAYOUT

STEREO ORDERING INFORMATION

| | | | |
|---|--------------|---------------------------------------|--------------|
| 2 — Criterion 855-S..... | P/N 900-0029 | 1 — System Programmer, KSP-10..... | P/N 994-6970 |
| 2 — Carousel,® G-824-S..... | P/N 994-7037 | 1 — System Switching Center..... | P/N 994-7031 |
| 1 — Random Access, RA-10..... | P/N 994-6969 | 1 — Audio Fader, MDF-S..... | P/N 900-0067 |
| 5 — Criterion 80 Playback, CPR-822..... | P/N 994-6702 | 3 — Equipment Racks, AUTORACK 70..... | P/N 900-0263 |
| 1 — Audio Fader, FIU-S..... | P/N 900-0255 | 2 — Side Panel..... | P/N 994-6664 |
| 1 — Time Announce Control, TA-2..... | P/N 900-0056 | | |
| 2 — Silence Sensor, SSA-3..... | P/N 900-0130 | | |
| 1 — Audio Control Center, ACC-2..... | P/N 900-0274 | | |
| 1 — Digital Clock..... | P/N 994-6759 | | |
| 1 — Time Selector, TS-4..... | P/N 994-6909 | | |

SPECIAL EQUIPMENT IN SYSTEM

Source Status Panel
RFL Equipment
Logging Decoder

AUDIO EQUIPMENT

HARRIS
 **GATES DIVISION**
Harris-Intertype Corporation

Professional Tape Cartridge System

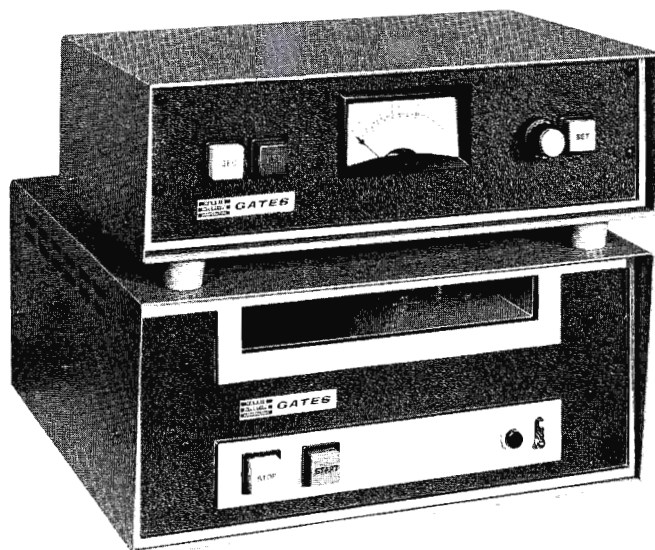

CRITERION 80

From the originators of the cartridge tape system for broadcasting comes the ultimate in cartridge unit design . . . the Criterion 80 series, with built-in, performance-proven features. From the sleek slide-out chassis and plug-in electronics to better timing, better wow and flutter, and dependable direct capstan drive for split-second timing accuracy, the Criterion 80 represents over 13 years of actual experience in the design, engineering and manufacturing of broadcast tape cartridge equipment. Consequently, the Criterion 80 series offers all of the many features most desired by broadcasters, plus superlative workmanship which assures long and dependable service.

The Criterion 80 has design improvements for still more efficient operation not found in its predecessors. Backed up by the rugged deck and tape drive assembly for which it is famous, the Criterion 80 in addition has the latest in silicon transistors, plug-in printed circuit boards, and independent gain controls for the cue amplifiers.

The individual Criterion 80 circuits have been RFI proofed to make them impervious to strong RF fields. The printed circuit boards, however, are easily accessible for quick maintenance.

Other Criterion 80 advancements include output gain controls accessible from the front panel, automatic audio muting and transient suppression, and a +10 dBm output capability. All external cables have latching connectors for a more dependable installation.

PRECISION MECHANICAL CONSTRUCTION: The excellence of Criterion 80 performance lies in the outstanding engineering and quality of its tape deck, motor mechanism, and exclusive Micro-Set head assembly. The massive direct-drive capstan motor provides speed accuracy comparable to the finest reel-to-reel machines.

MODELS AND TYPES: The Criterion 80 series is available in playback and record/playback combination models, in mon-

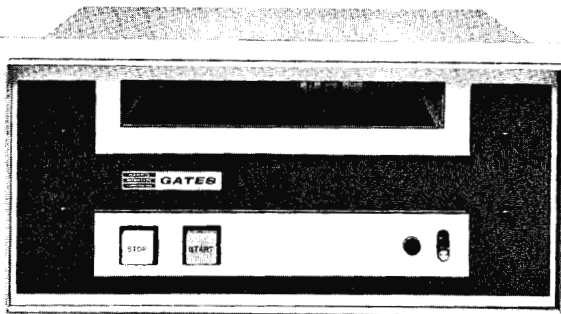

Professional Tape Cartridge System—Criterion 80

aural or stereo. The basic desk-mount design may be adapted to rack mounting with optional rack adapters. The primary 1 kHz cue tone is standard. Second and third tone operation is optional at additional cost on both monophonic and stereophonic models. All versions of the Criterion 80 playback series meet National Association of Broadcasters specifications and offer features such as 24 volt DC external function switching

for safety in remote controlled applications.

RECORDING UNITS: The Criterion 80 recording amplifier, like the playback unit, is housed in a trim-line desk console, and may be rack mounted with the appropriate adapter panel. Latest state-of-the-art circuitry in Criterion 80 electronics provides a master-quality recorder for professional use.

SPECIFICATIONS

PLAYBACK UNIT

POWER SOURCE: 105-125 volts, 60 Hz or 50 Hz.

POWER REQUIREMENTS: 70 watts maximum.

SYSTEM FREQUENCY RESPONSE: ± 2 dB 50 to 15,000 Hz.

NOISE: 45 dB (Stereo), 48 dB (Mono) below NAB Std. Ref., 52 dB (Stereo), 55 dB (Mono) below tape signal reference of 400 Hz, 3% THD.

DISTORTION: Record to playback, less than 2% at 6 dB above NAB Std. Ref.

EQUALIZATION: NAB Standard Response.

AMBIENT TEMPERATURE: 55° C, maximum.

AUDIO OUTPUT: 600 ohms, balanced, 0 dBm nominal, +10 dBm maximum.

CUE SIGNALS: NAB Standard Cue signals.

REMOTE CONTROL: All Control Functions.

HEAD ASSEMBLY: Laminated Hyperbolic heads in Micro-Set assembly.

TAPE SPEED: 7½ inches per second.

TAPE DRIVE SYSTEM: Direct Capstan Drive, sealed ball bearings.

FLUTTER AND WOW: 0.2% or less.

TIMING REPEAT ACCURACY: 99.9%.

TAPE START AND STOP TIME: Less than 0.1 second.

TAPE PULLING FORCE: 2 pounds.

DIMENSIONS AND WEIGHT: Desk top cabinet, 6" high, 13½" wide, 14" deep. With rack adapter, 7" high, 19" wide. Net weight, 30 lbs.

RECORDING AMPLIFIER

POWER SOURCE: From playback unit.

AMBIENT TEMPERATURE: 55° C maximum.

AUDIO INPUT: 600 ohms balanced line, input levels from -20 to +10 dBm, matching; +10 to +40 dBm bridging (20 K).

REMOTE CONTROL: All functions and lamp indications.

BIAS OSCILLATOR: Push-pull, 80 kHz.

DIMENSIONS AND WEIGHT: Desk top cabinet, 4" high, 13½" wide, 12½" deep. With rack adapter, 5¼" high, 19" wide. Net weight, 12 lbs.

ORDERING INFORMATION

HOW TO ORDER: Order basic single tone unit. For playback units, order second and third tone sensors as accessories. If ordering record/playback combination, also order cue oscillator. For rack mounting, order rack adapter/s.

RECORD/PLAYBACK COMBINATIONS

MPD-811 Matched playback and record amplifier, monaural, 1000 Hz cue, desk mount, 60 Hz 994-6729-001
As above, except 50 Hz 994-6733-001
MPD-821 Matched playback and record amplifier, stereo, 1000 Hz cue, desk mount, 60 Hz 994-6731-001

PLAYBACK UNITS

CPD-811 Playback unit only, monaural, 1000 Hz cue, desk mount, 60 Hz 994-6701-002
As above, except 50 Hz 994-6703-002
CPD-821 Playback unit only, stereo, 1000 Hz cue, desk mount, 60 Hz 994-6702-002
As above, except 50 Hz 994-6704-002

ACCESSORIES

QS-150 150 Hz cue sensor assembly, plugs into basic playback unit for conversion to two tone 900-0154-001

QS-8 8000 Hz cue sensor assembly, plugs into basic playback unit for addition of third tone 900-0155-001
TO-23 150 Hz and 8000 Hz cue oscillator assembly, plugs into record amplifier for conversion to three tone 900-0165-001
Rack Adapter-Playback, adapts any Criterion 80 desk mount playback unit for 19" rack mounting 994-6790-001
Rack Adapter-Record Amplifier, adapts any Criterion 80 desk mount record amplifier for 19" rack mounting 994-6791-001
AMS-4A Automatic switcher, mono (2 for stereo), four inputs to one output 900-0024-001
RC-T-8 Remote control with elapsed time indicator. May be used with all Criterion models. Complete record control, 60 Hz 900-0266-001
RC-T-8 As above, except 50 Hz 900-0266-002
RC-RA-8 Remote control box, may be used with all Criterion models. Complete record control of one unit 900-0267-001
RC-P4-8 Remote control box, may be used with all Criterion models. For playback control (START only) of up to four units 900-0268-001

Professional Tape Cartridge System

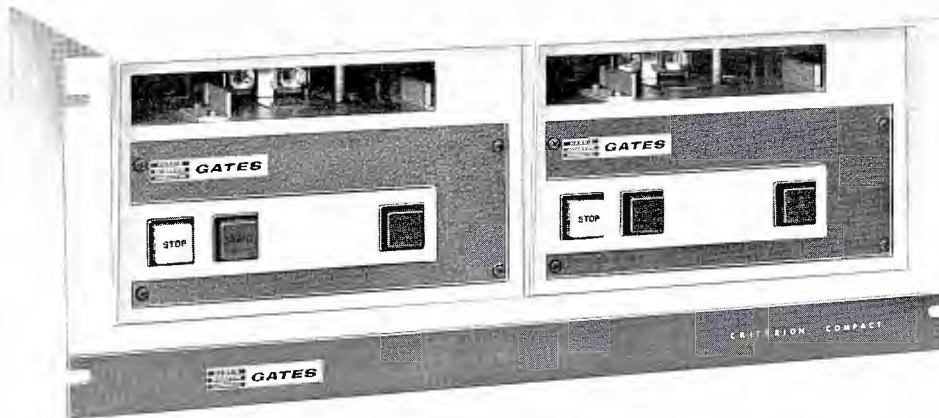

CRITERION COMPACT

The Criterion Compact is the newest, advance-design version of Gates' famous Criterion tape cartridge system. Designed for convenient installation in today's crowded studios and for conservation of valuable rack space in automation systems, two units of the Criterion Compact mounted side-by-side in a standard 19-inch equipment rack occupy the same space as that normally required for a single playback machine.

Popular in both automated systems and control rooms, the Criterion Compact retains all those features which have made Criterion the industry standard for cartridge machine excellence: rugged deck; massive direct drive capstan motor; and a new Micro-set precision head assembly.

Many new performance features have been incorporated into the Criterion Compact playback. The pressure roller solenoid is air-damped for quiet control room operation; single card electronics for mono or stereo units conserve space; il-

luminated pushbutton switches glow brightly to verify secondary and tertiary control tones on multi-cue units. As an optional feature, high-speed cueing is now available for the Criterion Compact.

All Criterion Compact units are equipped for three-tone cueing—just plug in the appropriate relay. Secondary and tertiary control tones are sensed on a single PC card.

HIGH-SPEED CUEING: An optional feature, high-speed cueing is provided for rapidly cueing cartridges to the 1 kHz primary cue tone after sensing the 150 Hz end-of-message signal. The primary cue tone logic is tailored for sensing in the fast cue mode. This can also be accomplished manually from a front panel pushbutton.

SUPERB ELECTRONICS: Improved silicon transistor circuitry is the basis for Criterion Compact's excellence in quality and reliability. Audio output capability is +18 dBm (0 dBm nominal) to overcome losses in complex studio or system installations. Audio distortion is virtually unmeasurable, limited only by the recorded tape being played.

Reduction in size of the Criterion Compact is achieved without sacrificing any of the quality features for which the Criterion is renowned. Only two printed circuit cards carry all the electronic circuitry for mono or stereo units.

MODELS AND TYPES: The Criterion Compact playback is available for monophonic or stereophonic reproduction. The basic single playback unit is designed for desk mounting—with an optional rack adapter available for mounting two Criterion Compacts side by side.

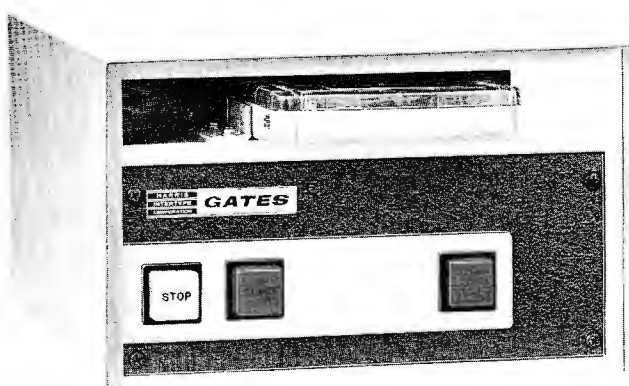

Professional Tape Cartridge System—Criterion Compact

SPECIFICATIONS

POWER: 102-125 volts, 60 Hz (50 Hz on special order). 70 watts maximum.

FREQUENCY RESPONSE: ± 2 dB 50 to 15,000 Hz.

NOISE: 45 dB (stereo), 48 dB (mono) below NAB standard reference. 52 dB (stereo), 55 dB (mono) below tape signal reference of 400 Hz, 3% THD.

DISTORTION: Less than 1% at NAB standard reference level.

AUDIO OUTPUT: 600 ohms, balanced, 0 dBm nominal, +18 dBm maximum.

TAPE SPEED: 7½ inches per second. Optional 30 ips fast cue accessory available.

TAPE DRIVE SYSTEM: Direct Capstan drive, sealed ball bearings.

FLUTTER AND WOW: 0.2% or less.

TIMING REPEAT ACCURACY: 99.9% or better.

TAPE START AND STOP TIME: Less than 0.1 second.

DIMENSIONS AND WEIGHT: Desk Mount: 5⅞ inches high, 8⅞ inches wide, 12½ inches deep. Net weight 20 pounds. Rack mount: 7 inches high, 19 inches wide (with rack mounting kit) for two Criterion Compact desk mount housings bolted side-by-side.

ORDERING INFORMATION

| | |
|--|----------|
| Criterion Compact Playback, monaural, desk mount..... | 994-6794 |
| Criterion Compact Playback, stereo, desk mount..... | 994-6815 |
| Rack Mounting Kit, for mounting two Criterion Compact playbacks in a single 19 in. rack..... | 994-6812 |
| Quick-Cue Kit for conversion of Criterion Compact to high-speed cueing..... | 994-6816 |
| 2nd and 3rd Cue Tone Relay. Add one for each tone desired..... | 574-0162 |

CRITERION COMPACT-II

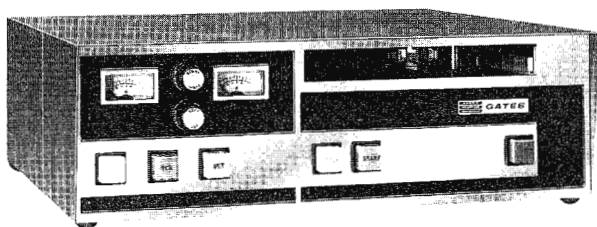

Criterion Compact-II is designed to handle "C" size cartridges (which cannot be used in the Criterion Compact) in addition to "A" and "B" sizes. Criterion Compact-II is available in record/playback models, or in playback units only. The CC-II record amplifier is not available as a separate unit. All models are mounted in desk top cabinets, with optional rack adapters available.

SPECIFICATIONS

Electrical specifications of the Criterion Compact-II playback are the same as those of the Criterion Compact shown above.

RECORDING AMPLIFIER:

POWER SOURCE: From playback unit.

AMBIENT TEMPERATURE: 55°C maximum.

AUDIO INPUT: 600 ohms balanced line, input levels from -20 to +18 dBm, matching; +10 to +40 dBm bridging (20 K).

REMOTE CONTROL: All functions and lamp indications.

BIAS OSCILLATOR: Push-pull, 80 kHz.

DIMENSIONS: Playback unit only, desk mount: 5⅞ inches high, 12½ inches deep, 10⅞ inches wide. Record/playback unit, desk mount: 5⅞ inches high, 12½ inches deep, 17⅞ inches wide. Playback unit or record/playback unit, rack mount: 7 inches high, 12½ inches deep, 19 inches wide.

ORDERING INFORMATION

HOW TO ORDER: For playback units, add 574-0162 relay for 2nd and 3rd tones—one each for each tone desired. The record amplifier in record/playback units has 150/1,000/8,000 Hz oscillator as standard equipment. Order optional rack adapters for rack mounting.

| | |
|--|--------------|
| Record/playback unit, mono, 60 Hz..... | 994-6901-001 |
| As above, except 50 Hz..... | 994-6901-002 |
| Record/playback unit, stereo, 60 Hz..... | 994-6900-001 |
| As above, except 50 Hz..... | 994-6900-002 |
| Rack mounting kit for record/playback unit..... | 994-7067-001 |
| Playback unit only, mono, 60 Hz..... | 994-6895-001 |
| As above, except 50 Hz..... | 994-6895-002 |
| Playback unit only, stereo, 60 Hz..... | 994-6896-001 |
| As above, except 50 Hz..... | 994-6896-002 |
| 2nd and 3rd cue tone relay for playbacks. Add one for each tone desired..... | 574-0162-001 |
| Rack mounting kit for playback units only..... | 994-7068-001 |

Tape Cartridge System Accessories

REMOTE CONTROL TIMER

Most control functions of the Criterion 80 record/playback unit can be remotely controlled with this unit. A built-in timer registers the elapsed time of recording. Starting the machine automatically activates the timer elapsed-seconds register. Stop, Start, Record Set, and all cue-tone functions of the Criterion 80 recorder are provided. Illuminated pushbuttons. 7¼" W. × 8" H. × 4½" D.

RC-T-8 Remote Control with elapsed time indicator.....900-0266

RECORD/PLAYBACK REMOTE CONTROL

All control functions of the Criterion 80 record/playback unit are remotely controlled from this desk-top unit. Stop/Start switches, also Record Set, Secondary Cue, and Auxiliary Cue functions. When used with Criterion 80 recorder in playback mode, pushbuttons illuminate as cue tones are detected to facilitate checking encoded cartridges. Size: 5¾ inches wide, 5½ inches high, 2¾ inches deep.

RC-RA-8 Remote Control.....900-0267

PLAYBACK REMOTE CONTROL

For remotely operating up to four Criterion 80 or four Criterion Compact playback units. Operates start circuit only. Includes ready lights and start switches.

RC-P4-8 Playback Control for Criterion 80
(5¾" W. × 5½" H. × 2¾" D.).....900-0268
RC-P4-C Playback Control for Criterion Compact.....994-6817

AUDIO SWITCHER PANEL

Up to four Criterion 80 units can be switched into one console input through this panel. Use two panels for stereo. Not for Criterion Compact.

AMS-4A Automatic Master Switcher.....900-0024

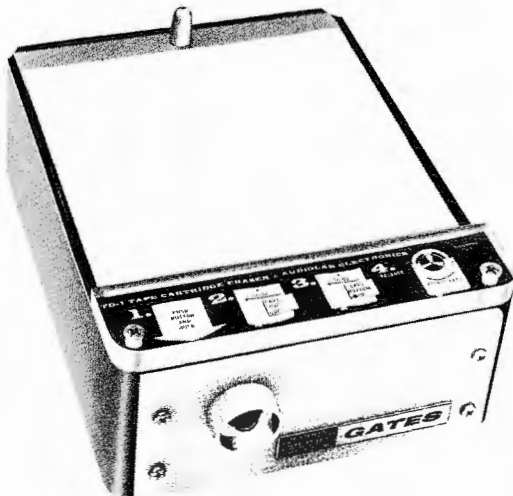

TD-1A TAPE ERASER

Professional model bulk magnetic tape eraser. Recommended for all sizes of tape cartridges, and reels up to 10½ inches. Lowers residual noise 3 to 6 dB below comparable hand-held units. Pushbutton operation. 117 volts, 50/60 Hz. Weight is 9 pounds. Manufactured by Audiolab.

TD-1A Tape Eraser.....732-0223

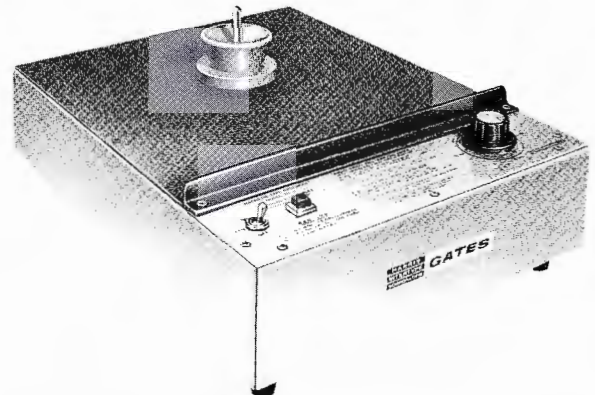

TD-2 TAPE DEGAUSSER

The Audiolab TD-2 tape degausser erases audio, video, computer and cartridge tape. It will erase tape reels up to 14" in diameter and 2½" wide. A built-in timer has adjustable "ON" cycle and automatic shut-off. Standard ⅝" center post and 3" NAB hub supplied. Size: 13" × 17" × 4". 108/135 VAC, 60 Hz.

TD-2 Tape Degausser732-0272

Tape Cartridges And Tape Cartridge Storage Units

TAPE CARTRIDGES

Gates tape cartridges are designed and manufactured to provide you with the finest over-all cartridge performance available today. Each careful production step assures this same high quality performance on the first and one-thousandth use of the cartridge. These tape cartridges meet and exceed all industry standards, and are fully compatible with all NAB standard tape machines.

In the manufacturing process, only the finest quality lubricated tape is used. It is wound on a precision automatic tape winding machine, and carefully spliced with magnifying glass attention. Special polyurethane pressure pads are installed in each cartridge to reduce wow and flutter to a minimum, while providing optimum tape-to-head contact.

The final production steps include a careful checkout on a tape deck attached to a precision wow and flutter meter, and an additional test involving recording and playback to assure audio excellence. Only after these tests have been completed is the Gates "Label of Quality" added to each cartridge.

| | |
|--|----------|
| A-300, 40 second cartridge..... | 900-0077 |
| A-300, 70 second cartridge..... | 900-0078 |
| A-300, 100 second cartridge..... | 900-0079 |
| A-300, 2½ minute cartridge..... | 900-0080 |
| A-300, 3½ minute cartridge..... | 900-0081 |
| A-300, 5½ minute cartridge..... | 900-0082 |
| A-300, 10½ minute cartridge..... | 900-0083 |
| B-600, 16 minute cartridge..... | 900-0084 |
| C-1200, 31 minute cartridge..... | 900-0085 |
| A-300, Empty cartridge..... | 900-0302 |
| B-600, Empty cartridge..... | 900-0303 |
| C-1200, Empty cartridge..... | 900-0304 |
| Cartridge Pressure Pads—(50 replacement foam plastic pads)..... | 994-6430 |
| Cartridge labels, white, 250..... | 646-0764 |
| Cartridge labels, red, 250..... | 646-0765 |
| Cartridge labels, green, 250..... | 646-0766 |
| Cartridge labels, yellow, 250..... | 646-0767 |
| FAL-1A Test Cartridge. Full track, for mono or stereo systems. Includes tones for azimuth alignment, frequency response, and standard level reference..... | 900-0090 |

TAPE CARTRIDGE STORAGE UNITS

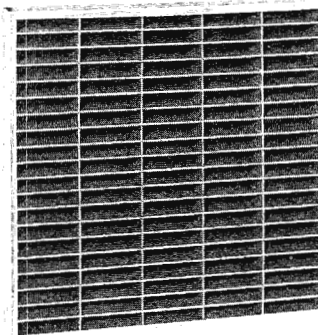

M-6887

Gates' Wall Mount Cartridge Rack provides for storage of 100 Series 300 cartridges in minimum space. May be wall or table top mounted. Walnut formica trim. 2' H × 2' W × 4¾" D.

Gates' Storage Rack 994-6887

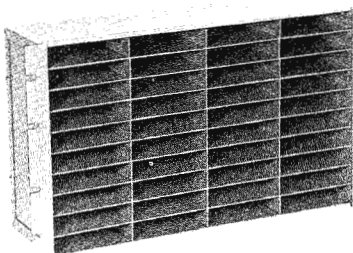

M-5986

M-5986 Storage Rack. Conveniently stores 40 Type A Series 300 cartridges in only 10½" of standard rack space.

Storage rack..... 994-5986

SECR-72 Storage Cabinet. Attractive walnut formica trim blends with any decor. Storage space for 72 Series 300 cartridges. Cabinet rotates on ball bearings. 22" H × 11" W × 11" D.

SECR-72 (not shown) 730-1189

SECR-200 Storage Cabinet. Walnut formica trim for attractive overall appearance. Capable of storing 200 Series 300 cartridges. Rotates on ball bearings. 29½" H × 15¾" W × 15¾" D.

SECR-200 (not shown)..... 730-1190

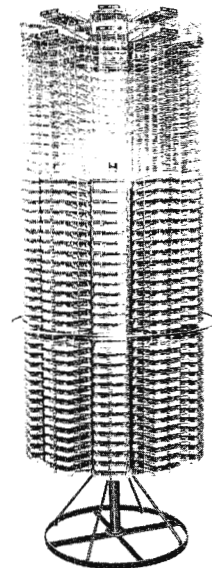

Lazy Susan

Wire Cartridge Rack. Holds 50 cartridges. 60" H × 5" W × 7" D. Includes tape mounting brackets.

Wire rack 730-1492

Lazy Susan Cartridge Rack Base. Holds up to 10 wire cartridge racks.

Lazy Susan rack base..... 730-1493

Professional Transcription Turntable—12-Inch



MODEL CB-1200

Gates' CB-1200 is a professional 12-inch transcription turntable designed for simplicity of operation and long, trouble-free service. Rapid start up time means easier cueing of records, while the specially-designed platter allows the playing of 45 rpm records with no accessory spindle.

The platter is directly driven through an idler-puck system by a high-quality, hysteresis synchronous motor, providing exceptional speed stability over the life of the turntable. The three-speed selector switch (33 $\frac{1}{3}$, 45 and 78 rpm) and the On/Off switch are located on the front panel. Order tone arm separately.

SPECIFICATIONS

CHASSIS SIZE: 16 $\frac{1}{4}$ " \times 16 $\frac{1}{4}$ ".

MOUNTING DIMENSIONS: 14 $\frac{7}{8}$ " \times 14 $\frac{7}{8}$ " cutout and 4 $\frac{1}{2}$ " clearance required below mounting surface.

SPEEDS: 33 $\frac{1}{3}$, 45 and 78.

START-UP TIME: 33 $\frac{1}{3}$ —less than $\frac{1}{6}$ revolution. 45—less than $\frac{1}{4}$ revolution. 78—less than $\frac{1}{3}$ revolution.

WOW & FLUTTER: .1% maximum.

RUMBLE: Stereo: at least 35 dB below 3.54 cm/sec RMS. Mono: at least 40 dB below 5.0 cm/sec RMS.

SPEED ACCURACY: 33 $\frac{1}{3}$ and 45: \pm .3%.

LINE VOLTAGE: 115 VAC, \pm 10% at 60 Hz.

MOTOR: 115 V, 60 Hz, 1800 rpm hysteresis synchronous. (50 Hz available, see below.)

FINISH: Dark beige gray pebble-tex and natural aluminum. Control panel is fawn metallic with natural aluminum edges and lettering. Platter covering is felt.

WEIGHT: Net: 22 lbs. Packed: domestic, 26 lbs.; export, 47 lbs. Cubage: 3.6 cubic feet.

ORDERING INFORMATION

CB-1200 12-inch transcription turntable, chassis only, 60 Hz.....994-6604-001
CB-1200 12-inch transcription turntable, chassis only, 50 Hz.....994-6604-002

HARRIS
GATES DIVISION
Harris-InterType Corporation

Turntable System Components

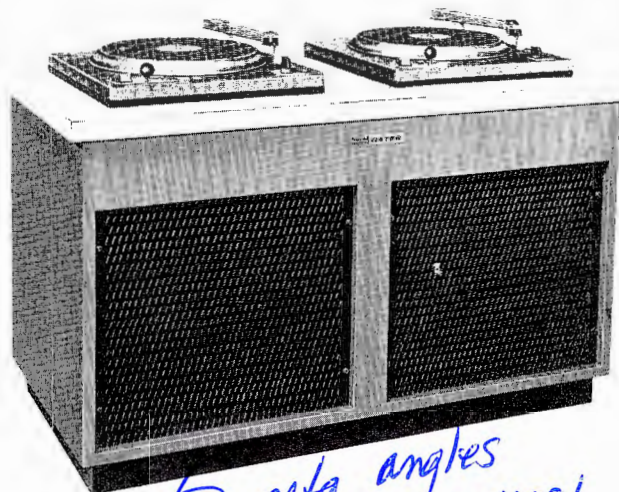

*(4) mtg angles
827-1304001*

12-INCH SYSTEM COMPONENTS

The following components are recommended to make up your 12-inch turntable system.

MONOPHONIC SYSTEM

| | |
|--|--------------|
| CB-1200 turntable, 60 Hz (50 Hz available)..... | 994-6604-001 |
| TA-12 12" tone arm..... | 723-0317 |
| Shure M-44-7 stereo dynetic cartridge w/.0007" diamond stylus..... | 723-0236 |
| IC turntable preamplifier..... | 994-6690 |

STEREOPHONIC SYSTEM

| | |
|--|--------------|
| CB-1200 turntable, 60 Hz (50 Hz available)..... | 994-6604-001 |
| TA-12 12" tone arm..... | 723-0317 |
| Shure M-44-7 stereo dynetic cartridge w/.0007" diamond stylus..... | 723-0236 |
| IC turntable preamplifier..... | 994-6977 |

NOTE: To order cabinet, see below.

DUAL TURNTABLE CABINET

Beautifully styled, and dimensioned to accommodate either 12- or 16-inch Gates turntables. For description, see Page 159.

Dual turntable cabinet..... 994-6449

16-INCH SYSTEM COMPONENTS

To make up a 16-inch turntable system, the following components are recommended.

MONOPHONIC SYSTEM

| | |
|--|--------------|
| CB-500 turntable, 60 Hz (50 Hz available)..... | 994-5739-003 |
| Gray 306 16" Micro-Trak tone arm..... | 723-0269 |
| Shure M-44-7 stereo dynetic cartridge w/.0007" diamond stylus..... | 723-0236 |
| IC turntable preamplifier..... | 994-6690 |

STEREOPHONIC SYSTEM

| | |
|--|--------------|
| CB-500 turntable, 60 Hz (50 Hz available)..... | 994-5739-003 |
| Gray 306 16" Micro-Trak tone arm..... | 723-0269 |
| Shure M-44-7 stereo dynetic cartridge w/.0007" diamond stylus..... | 723-0236 |
| IC turntable preamplifier..... | 994-6977 |

NOTE: To order cabinet, see below.



SINGLE TURNTABLE CABINET

Fits any decor. Accommodates either 12-inch or 16-inch Gates turntable. For description, see Page 159.

Single turntable cabinet..... 994-6448

Transcription Tone Arms And Pickups

*Anti Skate
Fluid
723-0350-006*



GATES 12" TA-12 TONE ARM

Gates' TA-12, which tracks as low as one gram without skipping, faithfully reproduces stereo records by minimizing the effect of the tone arm on sound reproduction and by reducing excessive record wear. Because of the advance design of the tone arm, resonance is less than 15 Hz, well outside the operating frequency range of the system. Distortion, due to tracking error in the arm and pickup, is reduced to a minimum by separate horizontal and vertical pivots.

Accurate tracking pressure is further achieved by rearweight adjustment with a calibration of approximately one gram per revolution. This arm will accept any broadcast type stereo cartridge.

TA-12 12-inch transcription tone arm.....723-0317

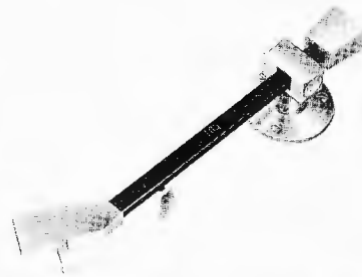

12" AND 16" MICRO-TRAK TONE ARMS

Especially designed for stereo, this durable arm will track distortion-free at micro-pressures of 1/10 gram. A new material never before used in a tone arm, wood impregnated with epoxy resins, was selected for this arm to achieve the extremely low tracking force and very low resonance characteristics. Sapphire bearings, floating in a unique elastomer ring, isolate the tone arm from its mounting and produce a tone arm with virtually no vertical friction.

Available for 12" and 16" turntables, this arm will accept any broadcast type stereo cartridge.

Gray 303 Micro-Trak 12" tone arm.....723-0268
Gray 306 Micro-Trak 16" tone arm.....723-0269

STEREOPHONIC PICKUP CARTRIDGES

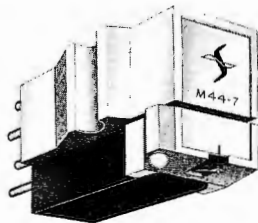

Model M44-7 stereo dynetic cartridge is recommended for faithful reproduction of both stereophonic and monophonic recordings. It offers superior stereo separation, smoother response, and is designed to complement the 15° effective cutting angle now being used on stereo recordings. The easily changed styli may be interchanged for various types of recordings.

SPECIFICATIONS

FREQUENCY RESPONSE: 20 to 20,000 Hz.
CHANNEL SEPARATION: More than 25 dB at 1000 Hz.
OUTPUT: 9 millivolts per channel at 1000 Hz at 5 cm/sec.
LOAD IMPEDANCE: 47,000 ohms per channel.
TRACKING: 1.5 to 3 grams.
STYLUS: Features "no scratch" retractable design.
INDUCTANCE: 680 millihenries.
D.C. RESISTANCE: 650 ohms.
MOUNTING: Standard 1/2" mounting center.
WEIGHT: 7 grams net.

ORDERING INFORMATION

Shure M44-7 stereo Dynetic Cartridge with 0.0007" diamond stylus.....723-0236
Replacement Stylus N-44-7 0.0007" diamond.....723-0237

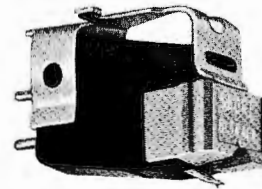

The Model M93E Hi-Track Elliptical Cartridge is an outstanding performer in tone arms that track in the 1½ to 3 grams range. While capable of reducing high frequency splatter, the M93E is rugged enough to withstand continued back-cueing. Clip-on, easy-mount design cuts cartridge mounting time in half. Alignment is precise and positive. This cartridge is excellent for broadcast applications where durability is a consideration.

SPECIFICATIONS

FREQUENCY RESPONSE: 20 to 20,000 Hz.
CHANNEL SEPARATION: More than 25 dB at 1000 Hz.
OUTPUT: 6.2 millivolts per channel at 1000 Hz at 5 cm/sec.
LOAD IMPEDANCE: 47,000 ohms per channel.
TRACKING: 1.5 to 3 grams.
STYLUS: Biradial elliptical with diamond tip.
INDUCTANCE: 720 millihenries.
D.C. RESISTANCE: 630 ohms.
MOUNTING: Snap-in type—standard 1/2" mounting centers on retaining clip.
WEIGHT: 6 grams.

ORDERING INFORMATION

M93E Hi-Track Elliptical Cartridge 1½ to 3 grams tracking.....723-0306
N-93E Elliptical replacement stylus.....723-0307



Transistorized IC Turntable Preamplifiers

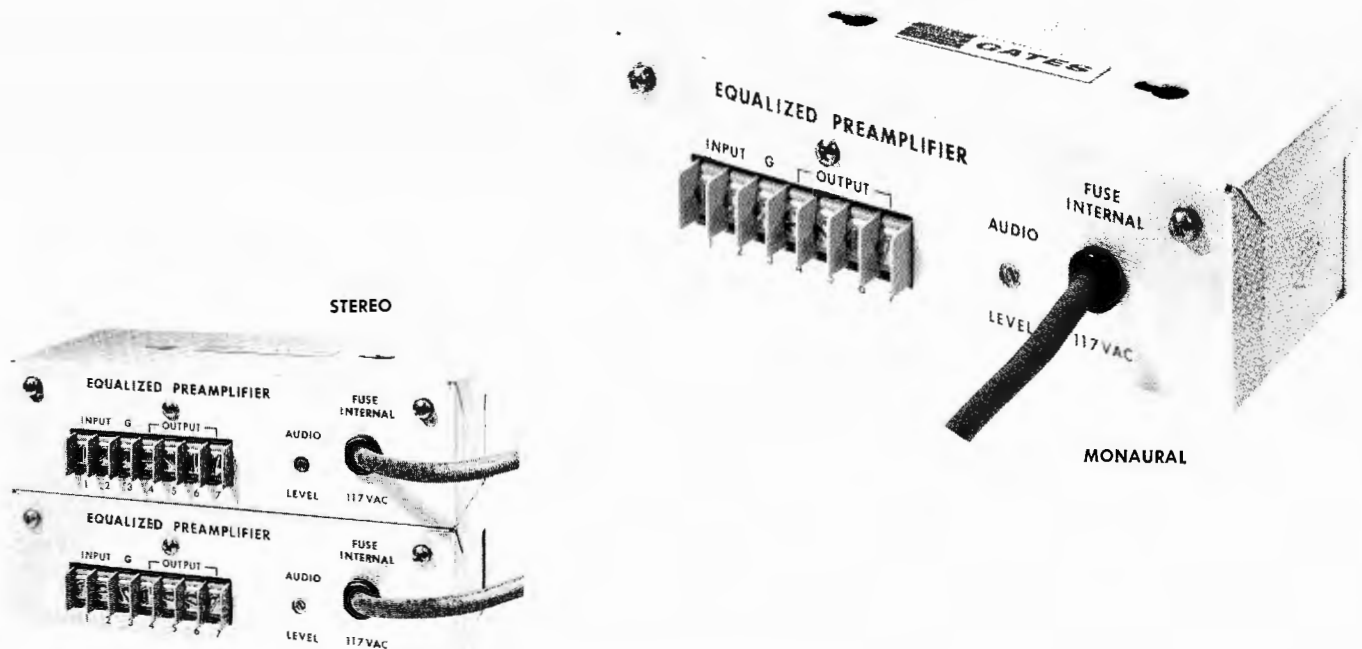

MONO-STEREO

Single-channel transistorized turntable preamplifier features low distortion and excellent frequency response. Designed for use in broadcasting, recording and for general sound requirements, Gates' IC preamp's input impedance of 47,000 ohms makes it compatible with virtually all magnetic cartridges (including stereo). It is self-equalized to the standard RIAA/NAB frequency response curve.

Special mounting holes have been provided on the top of the preamplifier housing to "piggyback" a second unit for stereo operation.

The preamplifier is completely self-contained in an aluminum housing, and includes an integrated circuit, current booster and associated components, plus the output and power transformers.

SPECIFICATIONS

INPUT: 47,000 ohms.

OUTPUT: -10 dBm with 3.6 mV input.

RESPONSE: Within ± 1 dB of RIAA/NAB standard curve.

DISTORTION: Less than 0.5% at normal levels (3.6 mV input and -10 dBm output). Less than 1.0% at 10 dB overload (0 dBm output).

NOISE: At least 70 dB below 0 dBm output, 20 Hz to 20 kHz.

LOAD IMPEDANCE: 600 ohms or 150 ohms, balanced or unbalanced.

OPERATING AMBIENT TEMPERATURE RANGE: 0° to +60° C.

POWER: 117/234 volts, 50/60 Hz, 1 watt.

MOUNTING: Two holes for mounting to Gates turntable or inside of any cabinet. May be mounted in any position.

SIZE: 7 $\frac{1}{16}$ " long, 3 $\frac{3}{8}$ " wide, 2 $\frac{1}{16}$ " high.

WEIGHT AND CUBAGE: Net weight, 1 lb. Packed weight, 8 lbs. Cubage: 1 cubic foot.

ORDERING INFORMATION

Monaural IC Turntable Preamplifier.....994-6690
Stereo IC Turntable Preamplifier.....994-6977

Professional Transcription Turntables—16-Inch



MODEL CB-500

Gates CB-500 is the most widely used 16-inch turntable in the broadcasting industry. Designed for continuous 24-hour commercial service, this turntable is ruggedly constructed to meet the strain of any control room operation, while maintaining its excellent quality of performance.

Time proven features include heavy machined aluminum platter, rubber-shock-mounted cast aluminum chassis, oilite hub bearing, self-centering neoprene idler wheel, monoball self-aligning speed shift bearings, and a functional speed selector mechanism. (Order pickup arm separately.)

SPECIFICATIONS

CHASSIS SIZE: 21¼" x 21¼" x 1½".

MOTOR HANG BELOW BOTTOM OF CHASSIS: 4¾".

CONSTRUCTION: Both platter and base of machined aluminum.

FINISH: Beige-gray with escutcheon in black and turntable platter cover in heavy gray felt.

PLATTER SIZE: 17".

CENTER SPINDLE: Spring-lacking type, snaps up for 45 rpm hub, locks down for smaller-spindle records.

CENTER BEARING: 1" diameter hardened steel, rotates in oilite bearing.

MOTOR: Hysteresis synchronous, single phase, 600 rpm, with 40°C temperature rise.

CUEING: At 33½ rpm, ½ turn. At 45 rpm, ¼ turn. At 78 rpm, 1¼ turn.

NOISE OR RUMBLE: At 33½ rpm, rated -45 dB. At 45 rpm, rated -40 dB. At 78 rpm, rated -35 dB.

WOW: Rated 0.1% at 33½ rpm, capable .08%.

FLUTTER: Rated 0.07% at 33½ rpm, capable .05%.

MOTOR START: Rocker-type illuminated mercury switch.

IDLER WHEEL: Special shear action neoprene, self-aligning.

SPEED CHANGE: To 33½, 45, or 78 rpm by single indexed lever control.

POWER: 117 volts, 60 Hz, 35 watts. (50 Hz available, see below.)

WEIGHT: Net: 34 lbs. Packed: domestic, 45 lbs.; export, 70 lbs. Cubage: 6 cubic feet.

ORDERING INFORMATION

CB-500 16-inch transcription turntable, chassis only, for 60 Hz.....994-5739-003

CB-500A 16-inch transcription turntable, chassis only, for 50 Hz.....994-5739-004

Portable Audio Turntable-Console

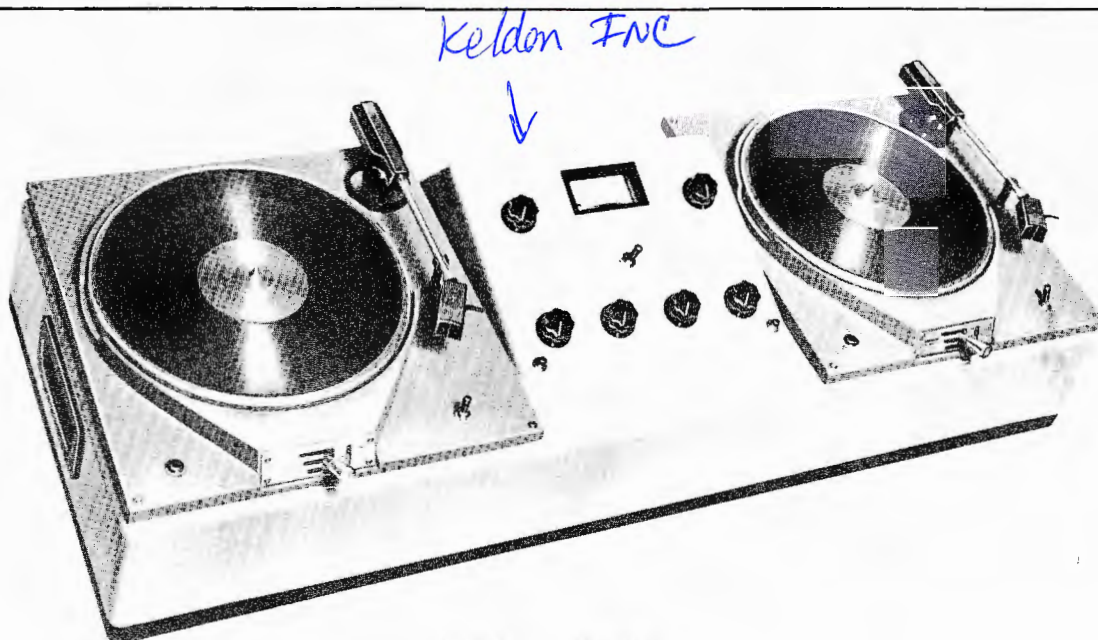

MODEL KD-20B

Rugged, compact, and all solid state, this economical unit is ideal for remote disc jockey shows and special on-the-spot broadcasts.

COMPLETE REMOTE CAPABILITY: Two high quality, three speed turntables, with individual mixing controls are provided. Two microphones and a remote input can also be mixed and are individually selectable by a three position switch. The remote input has a 50 dB pad which enables use of a high level source such as a tape recorder or remote amplifier, adding to the capability of the unit. Line feed and control, PA feed and monitoring are included.

COMPACT DESIGN: This unit is packaged for portability. Weighing only 68 pounds, the KD-20B has detachable legs which fasten underneath the base for ease in transporting. The base of this console is fiberglass to provide protection for the equipment. Side handles enable easy carrying, and the unit's overall size enables it to fit into the rear of a standard size car.

EXCELLENT AUDIO: Both turntable channels have integral RIAA equalization to match their respective cartridges. Microphone channel frequency response is ± 2 dB from 50 to

15,000 Hz. Output level is ± 6 VU with 3% or less distortion from 50 to 10,000 Hz.

The KD-20B's output passes through a 3 dB pad before feeding the broadcast line. The output also passes through a resistive isolation network before going to the monitor phone jack. Feed to the PA system is isolated by a bridging transformer, and a separate fader is used to control PA level.

SOLID STATE ELECTRONICS: All circuitry in this console from preamplifiers to power supply is solid state, using high quality, ruggedly mounted transistors and diodes. Etched wiring is used in all amplifiers. The full wave power supply is fully regulated.

EASE OF OPERATION: The control placement of this unit assures easy operation by one man. Faders for the two turntables and the microphone/remote input are on the lower portion of the control panel. The three position microphone/remote switch is in the center with the PA level control and master gain control to the right and left of the VU meter respectively. Cueing of the turntables can be accomplished through headphones; monitoring is done through the headphones or an external amplifier.

SPECIFICATIONS

MIXING CHANNELS: Four.

MODE: Monaural.

INPUTS: Total six—(2) turntables, (2) 50-250 ohm microphones, (1) high level 600 ohms, (1) medium level 600 ohms.

CUEING: Pushbuttons on turntable channels to headphone jack.

FREQUENCY RESPONSE: (Audio system), ± 2 dB, 50-15,000 Hz. (Pickups) Standard RIAA curve.

DISTORTION: 3% or less.

OUTPUT: 600 ohms @ ± 6 VU (after built-in 3 dB pad).

NOISE: (Microphone channel) -56 dB (relative input noise -106 dBm).

POWER: 117 volts, single phase, 60 Hz.

SIZE: 44" long, 16½" wide, 10" high.

WEIGHT: 68 pounds net.

ORDERING INFORMATION

Portable KD-20B audio turntable/console

740-0032

HARRIS
GATES DIVISION
Harris Intertype Corporation

AM Limiting Amplifier

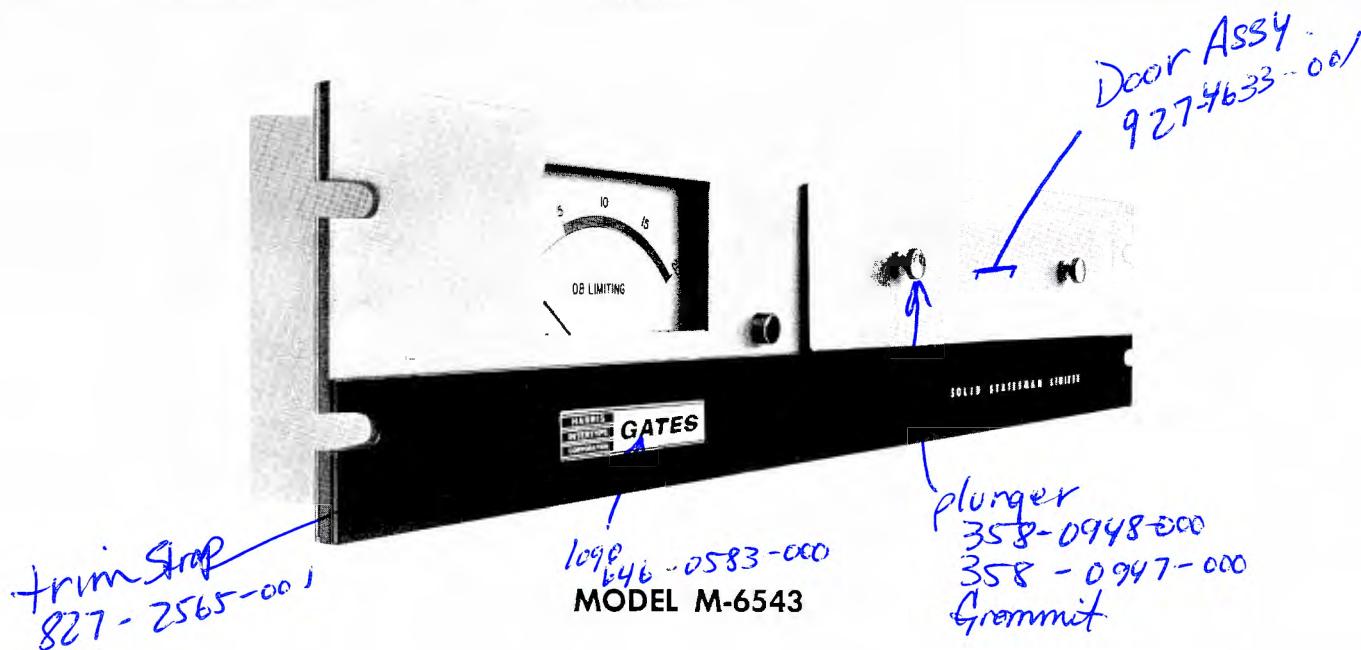

Designed to outperform all others, the Gates Solid Statesman Peak Limiting Amplifier ushers in a new age of advanced limiter capabilities.

PERFORMANCE: True limiting without peak clipping is achieved with an average 3 to 5 microsecond attack time. This eliminates the several milliseconds of clipping found in most limiters while the limiting action "catches up". Thus, in this new Peak Limiting Amplifier, even the most critical ear cannot detect the audible distortions that are apparent as a result of slow attack time.

LOW DISTORTION: Distortion is typically 0.2% at 30 Hz and 0.3% at 16 kHz with 10 dB of limiting, and is less than 1.0% with up to 30 dB of limiting. Frequency response remains uniform with or without limiting.

HIGHER MODULATION LEVELS: Fast attack time (in microseconds) and variable release time provide complete freedom from "pumping" with limiting of 15 to 20 dB on most program content. A 30:1 compression ratio allows 99.5% negative modulation without overmodulation. For AM stations,

asymmetrical limiting permits positive peak modulation levels of 110% or 125%, yet negative peaks are limited to 100% or less. This produces a louder-sounding signal.

AUTOMATIC PHASE REVERSAL: The highest peak of the audio signal is made positive to produce the highest AM modulation level in the transmitter. This asymmetrical limiting causes no base line shift in the limiter, and does not artificially alter the balance of the program content. It does permit greater modulation of the natural positive peaks with the resultant increase in transmitter power.

Symmetrical limiting is also available for operation where peaking and phasing of the signal are not desired. A front panel control also permits the limiter to be disabled for proof of performance tests.

CONTROLS: All operating controls are located behind the front access panel. Input and output connections are provided on a barrier terminal block, in addition to the AC power cord, on the rear of the unit.

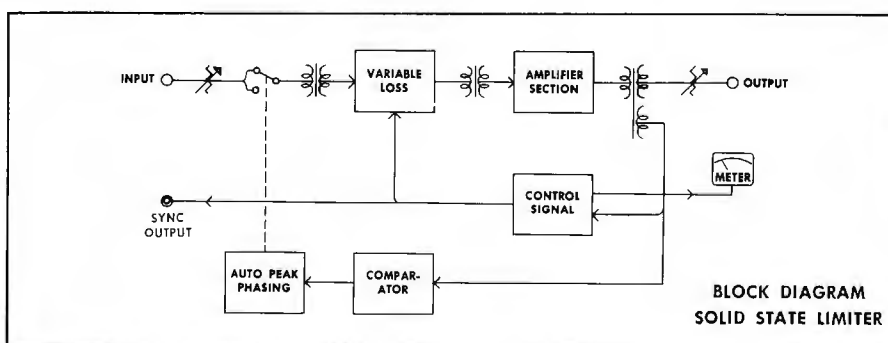

AM Limiting Amplifier

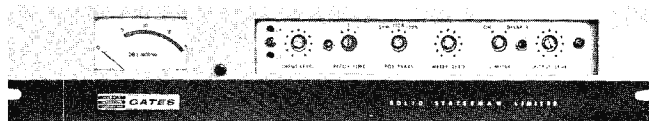

Front view, panel open.

The signal at "A" applied to a conventional limiter with a clipper produces output "B". Here the signal is first clipped, introducing distortion, and then several milliseconds later the true limiting is accomplished. Gates Solid Statesman Limiter completes the limiting action during the first half cycle of the pulse (output "C"). Any distortion produced would be during the first half cycle, and after that the signal would be truly limited without distortion.

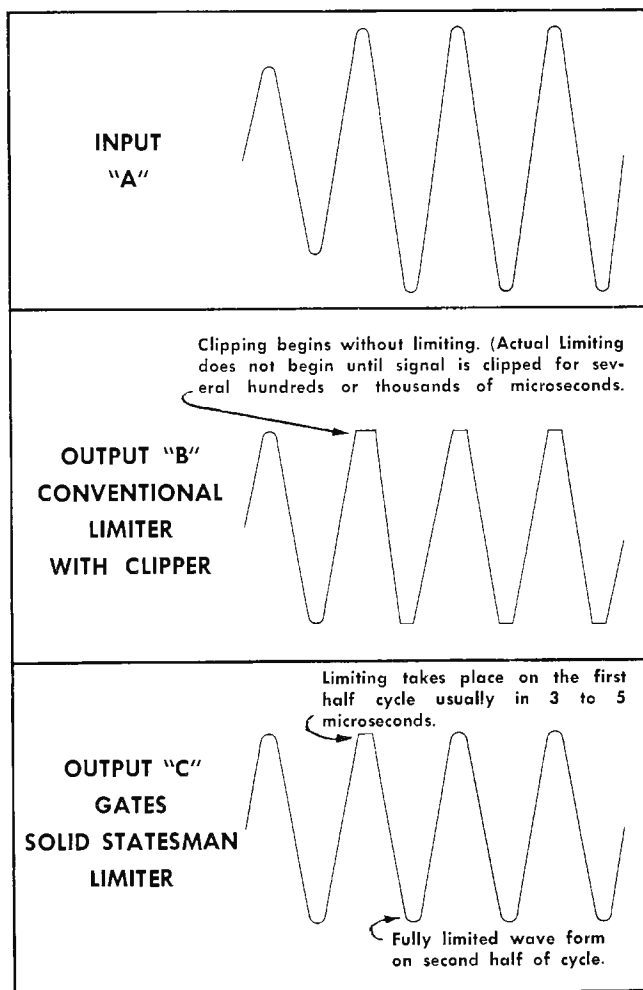

SPECIFICATIONS

GAIN: 50 dB, ± 2 dB max. @ 1 kHz. (May be reduced by built-in input and/or output attenuators).

FREQUENCY RESPONSE: ± 1.0 dB max., 30 to 16,000 Hz (with or without limiting).

HARMONIC DISTORTION: Less than 1.0% from 30 to 16,000 Hz, from 0 to 10 dB of limiting, except with fast recovery on low frequencies where there is partial recovery on each $\frac{1}{2}$ cycle.

NOISE: 70 dB below threshold of limiting, 30 to 16,000 Hz.

ATTACK TIME: Less than 10 microseconds (typical 3 to 5 microseconds).

RECOVERY OR RELEASE TIME: Gated to program content, with 3 positions for individual preferences.

AMOUNT OF LIMITING: 30 dB with a 30:1 compression ratio, an increase of 30 dB input level will increase output level 1 dB.

INPUT LEVEL: Adjustable -22 to +18 dBm for 5 dB of limiting.

OUTPUT LEVEL: Adjustable to +23 dBm maximum.

INPUT AND OUTPUT IMPEDANCE: 600 ohms, balanced or unbalanced.

TEMPERATURE RANGE: -20°C to $+55^{\circ}\text{C}$.

INPUT POWER: 115/230 volts, 50/60 Hz.

DIMENSIONS: $3\frac{1}{2}$ " H x 12" D x 19" W (standard rack).

WEIGHT: 13 lbs. net; 22 lbs. shipping.

ORDERING INFORMATION

AM Limiting Amplifier.....

994-6543

HARRIS
GATES DIVISION
Harris-Intertype Corporation

FM Limiting Amplifier

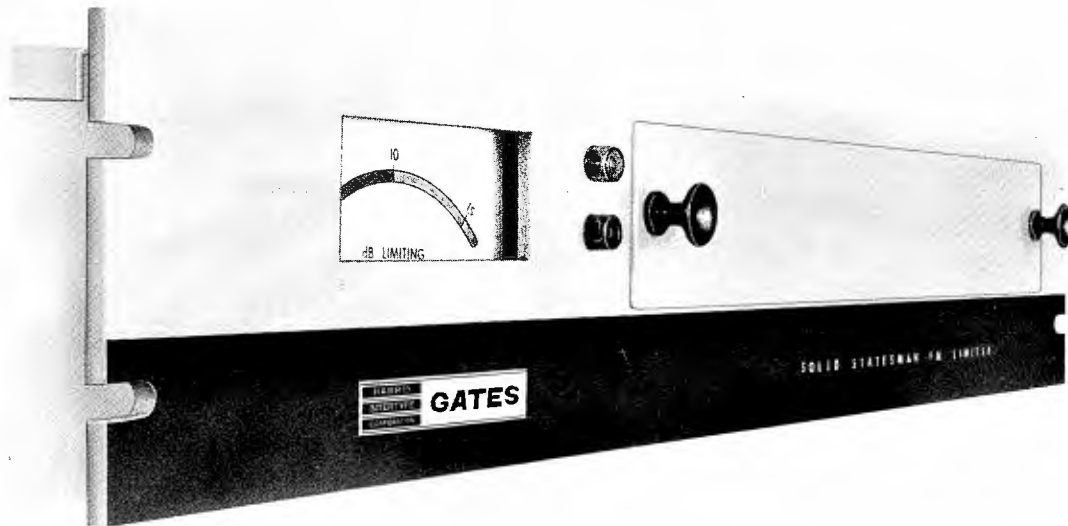

MODEL M-6631

Gates' Solid Statesman FM Limiter (M-6631) is designed to prevent FM over-modulation, while retaining the original fidelity of the program material. This is accomplished through a combination of limiting, pre-emphasis, instantaneous peak controlling and de-emphasis.

A wide control range, low distortion and rapid attack time are outstanding features of the M-6631—made possible by the extremely close balance of the "Differential Amplifier" used as the gain control device.

Another important feature is the selectable recovery time, which allows each station to choose the best recovery time (FAST, MEDIUM, SLOW) for its type of programming.

In the FAST mode of operation the FM Limiter has dynamic gated recovery. This permits very fast (200 millisecond) recovery times for the highest possible modulation levels, while distortion figures are almost as low at 30 Hz operation as at 1000 Hz.

The MEDIUM and SLOW positions are conventional and

offer slower recovery times for stations desiring protection from over-modulation, but more subtle operation.

The selectable frequency threshold for instantaneous peak controlling permits the local station to select the frequency at which the instantaneous peak controller starts operating. This control function is related to the FCC 75 microsecond pre-emphasis curve, and is intended to offer stations positive protection, but lesser amounts of control action if desired.

Two FM Limiters may be synchronized for stereo operation with a small phono-plug jumper supplied.

A front panel control permits the user to disable the unit for proof of performance tests.

Only 3½" of standard rack space is required for the M-6631 FM Limiter. All operating controls are located behind the easily removed front access panel. Circuit components are readily accessible by removing the top cover. Input and output connections are provided on a barrier terminal block on the rear of the unit along with the stereo sync jack and AC power and fuse.

FM Limiting Amplifier

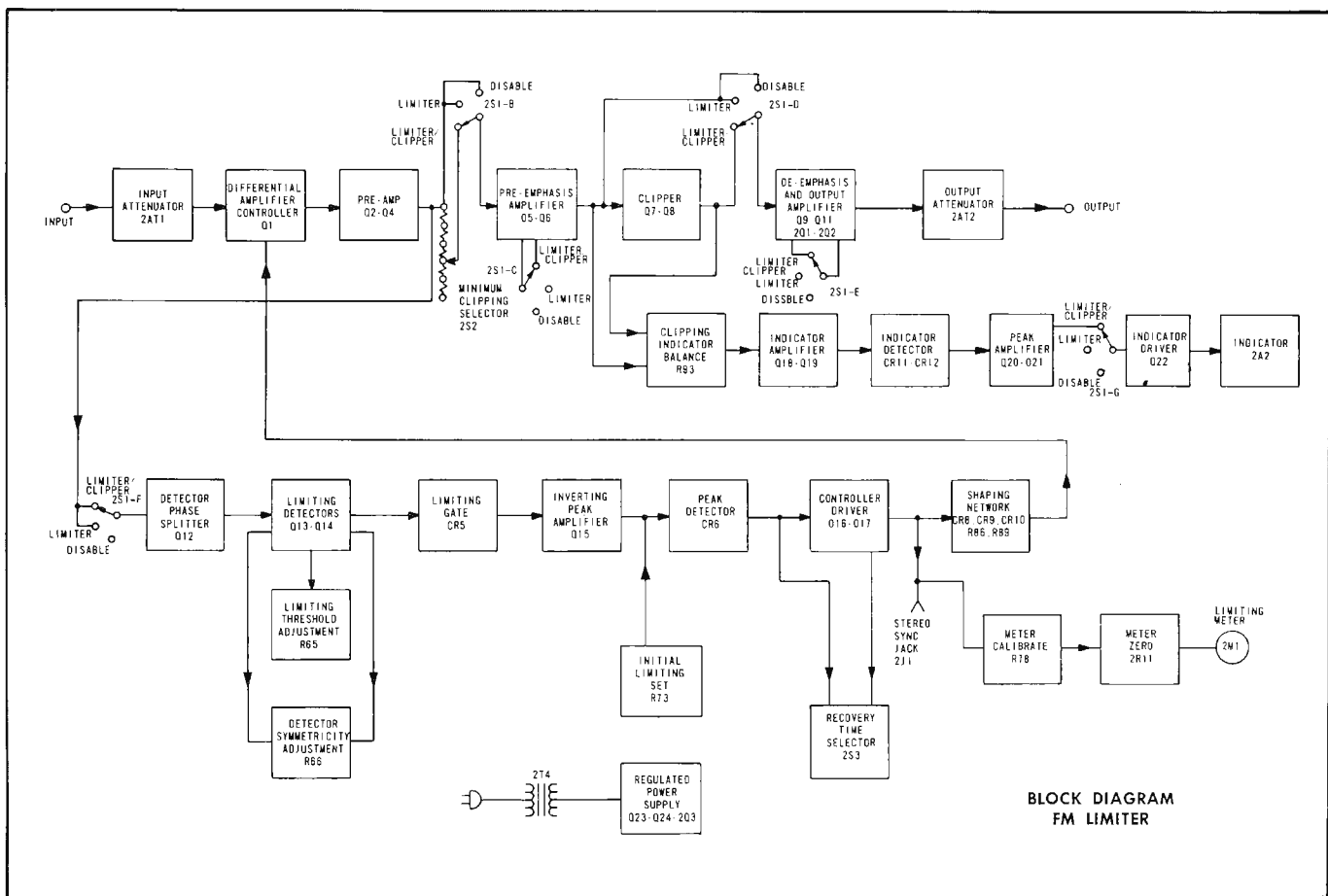

SPECIFICATIONS

GAIN: 50 dB, ± 2 dB max. @ 1kHz. (May be reduced by built-in input and/or output attenuators).

FREQUENCY RESPONSE: ± 1.0 dB, 30 Hz to 16 kHz, below threshold of instantaneous limiting.

HARMONIC DISTORTION: 1% Max. 30 Hz to 16 kHz, below limiting, or of 10 dB of limiting in any recovery mode.

NOISE: 70 dB below the threshold of limiting. (Limiting Threshold 30 Hz to 16 kHz.)

ATTACK TIME: 40 microseconds, maximum (no "thumping").

RECOVERY TIME:—Selectable:

FAST: Dynamically Gated for 200 milliseconds

MEDIUM: 2 seconds

SLOW: 10 seconds

AMOUNT OF LIMITING: 30 dB maximum capability.

LIMITING SLOPE: Better than 30:1. (A 30 dB increase in the input signal will produce less than a 1 dB rise in the output level.)

INPUT LEVEL: Adjustable from -17 dBm to $+23$ dBm for 10 dB of limiting.

OUTPUT LEVEL: Adjustable from -17 dBm to $+23$ dBm maximum with limiting. ~ 30 dBm amplifier maximum.

INPUT AND OUTPUT IMPEDANCE: 600 ohms, balanced or unbalanced.

DIMENSIONS: 3 $\frac{1}{2}$ " H \times 13 $\frac{3}{8}$ " D \times 19" W (standard rack).

WEIGHT: 14 lbs. net.; 23 lbs. shipping.

TEMPERATURE RANGE: -20°C to $+55^{\circ}\text{C}$. -4°F to $+131^{\circ}\text{F}$.

INPUT POWER: 115/230 volts, 50/60 Hz, 5 watts.

ORDERING INFORMATION

Solid Statesman FM Limiter 994-6631-005
 Matched Pair of FM Limiters (for stereo) 994-6631-006

HARRIS
 GATES DIVISION
 Harris-Intertype Corporation

Automatic Gain Control Amplifier

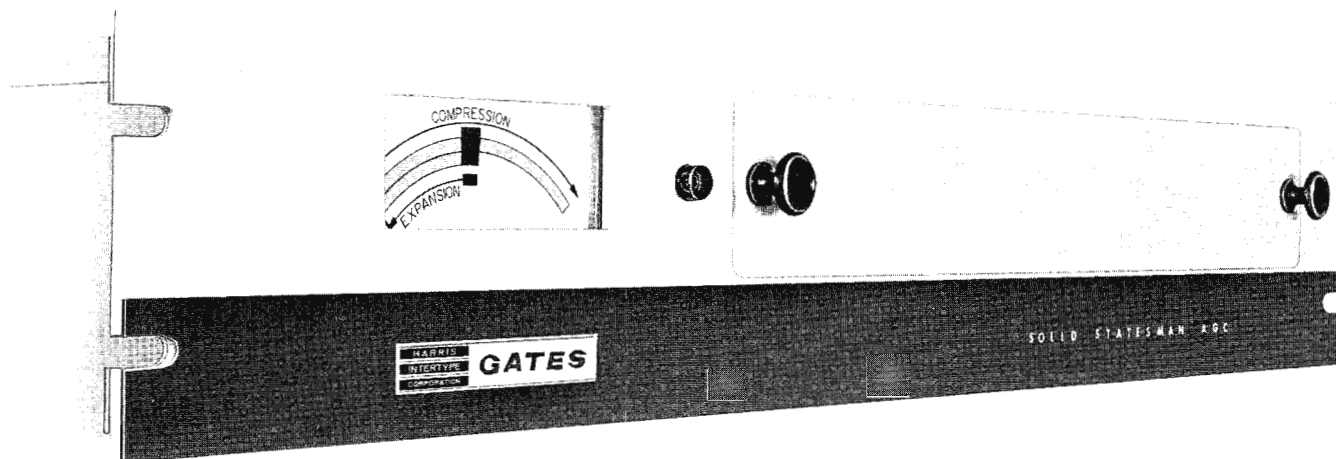

MODEL M-6629

Gates Solid Statesman AGC Amplifier (M-6629) is the most versatile automatic gain control system available today. A wide range of control on the amplifier, and an adjustable attack/recovery time feature, insure programming flexibility. The high compression ratio and rapid attack time generate consistently high modulation levels, while the slow attack/recovery mode will maintain control over average program material and extend dynamic range.

The wider control range, lower distortion and rapid attack time are made possible by the use of a "differential amplifier" as the gain controlling device. Extremely close balance of this amplifier provides the desirable characteristics of the M-6629. Another feature is the selectable attack/recovery time which allows each station to select the control time best suited to its program format.

In the FAST mode, the reaction time is similar to that of other limiters now on the market. This operating mode is most desirable for those stations wanting the highest possible modulation levels.

In the MEDIUM and SLOW modes, reaction times are considerably slower. These operating modes are available to those stations which desire a lesser amount of control action than that found in the FAST mode.

Two Solid Statesman AGC Amplifiers may be synchronized for stereo operation. A small jumper cable is all that is required.

Front panel controls permit the user to disable both the expansion and compression functions separately for proof of performance tests. Under these conditions the unit has the same gain as when 15 dB of compression, the ideal operating point, is being used. This provides a test position and at the same time maintains system calibration.

Only 3½" of standard rack space is required for the M-6629. All operating controls are located behind the easily removable access panel. Circuit components are readily accessible by removal of the top cover. Input and output connections are provided on a barrier terminal block on the rear of the unit, along with the stereo sync jack and AC power and fuse.

Automatic Gain Control Amplifier

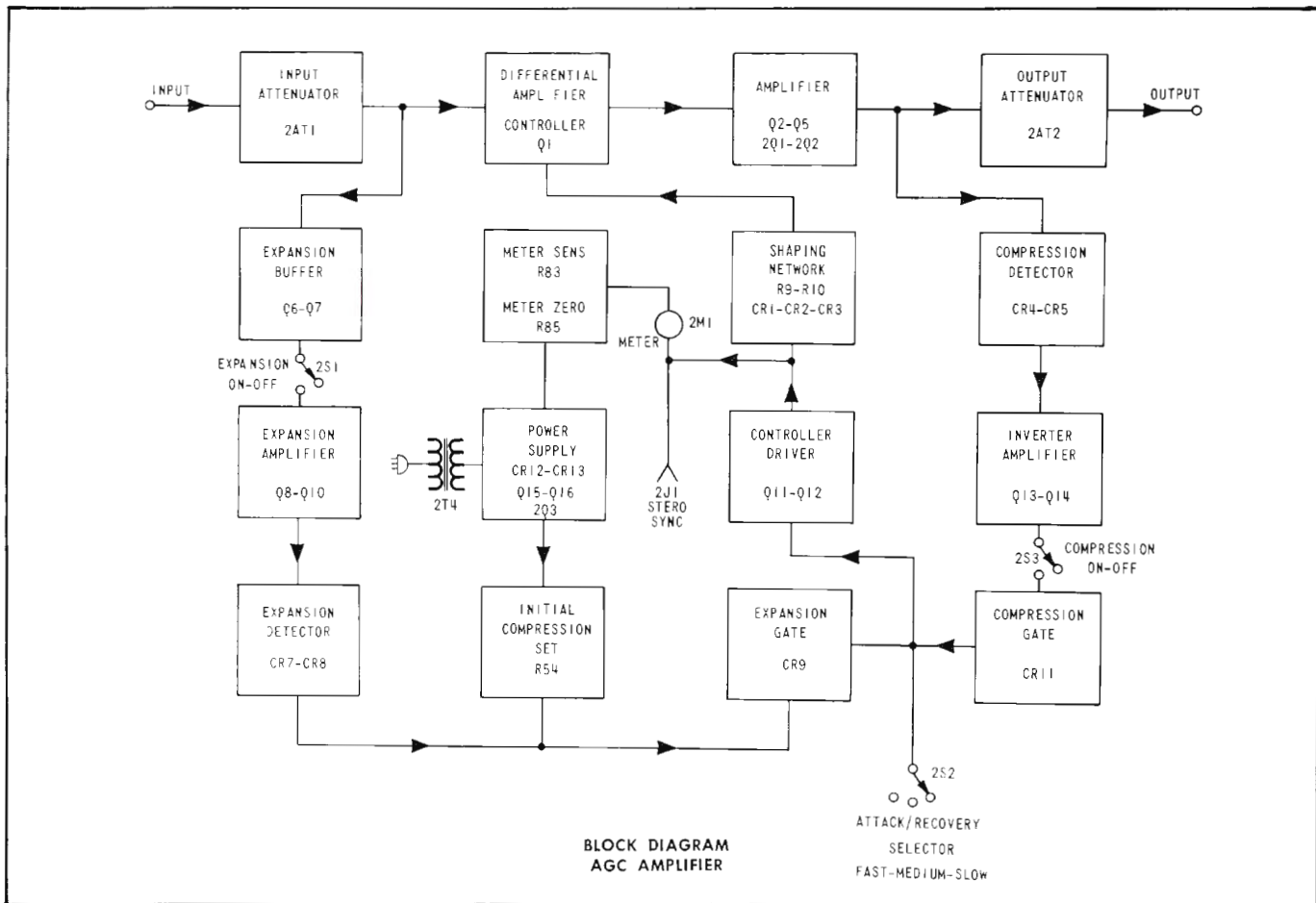

SPECIFICATIONS

GAIN: All figures given with no attenuation in input and output controls (wide open).

MAXIMUM GAIN: 50 dB \pm 2 dB @ 1 kHz with maximum expansion.

NOMINAL GAIN: 35 dB \pm 2 dB @ 1 kHz with nominal signal (15 dB of compression) or no signal condition.

MINIMUM GAIN: 20 dB \pm 2 dB @ 1 kHz with full (30 dB) compression.

FREQUENCY RESPONSE: \pm 1.0 dB, 30 Hz to 16 kHz with or without compression.

HARMONIC DISTORTION: Less than 1.0% from 30 Hz to 16 kHz. AGC on or off.

NOISE: 70 dB below the threshold of compression.

COMPRESSION ATTACK TIME: 30 dB, selectable. Fast: 100 μ Sec. Medium: 1-2 M Sec. Slow: 30 M Sec.

COMPRESSION RECOVERY TIMES: 30 dB, dependent upon compression attack time. Fast: 12 Sec. Medium: 22 Sec. Slow: 53 Sec.

EXPANSION ATTACK TIMES: 15 dB, dependent upon compression attack time. Fast: 7.5 Sec. Medium: 15 Sec. Slow: 35 Sec.

EXPANSION RECOVERY TIMES: 15 dB, dependent upon compression attack time. Fast: 4 Sec. Medium: 5 Sec. Slow: 10 Sec.

AMOUNT OF COMPRESSION: 30 dB.

AMOUNT OF EXPANSION: 15 dB.

COMPRESSION RATIO: Better than 30:1, a 30 dB increase in the input signal will produce less than 1 dB rise in the output level.

INPUT LEVEL: -15 dBm to +25 dBm for 15 dB of compression.

OUTPUT LEVEL: Adjustable to -20 dBm maximum with compression, +30 dBm amplifier maximum.

INPUT AND OUTPUT IMPEDANCE: 600 ohms, balanced or unbalanced.

DIMENSIONS: 3 1/2" H x 13 3/8" D x 19" W (Standard rack).

WEIGHT: 14 lbs. net. 23 lbs. shipping.

TEMPERATURE RANGE: -20°C to +55°C. -4°F to +131°F.

INPUT VOLTAGE: 117/234 V, 50/60 Hz.

INPUT POWER: 5 watts.

ORDERING INFORMATION

Solid Statesman Automatic Gain Control Amplifier 994-6629-004
 Matched Pair AGC Amplifiers (for stereo) 994-6629-006

Premium Solid State Plug-In Audio Amplifiers

6300 SERIES

Designed for custom audio equipment, these fully transistorized audio amplifiers incorporate engineering advances that provide excellent performance standards.

Included in this complete line are: Preamplifiers, program

amplifiers, program/automatic gain control amplifiers and power supplies. Mounting trays and a compact shelf assembly for rack mounting are listed on Page 140.

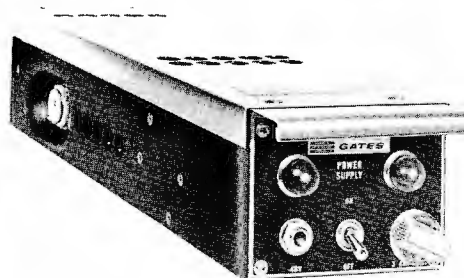
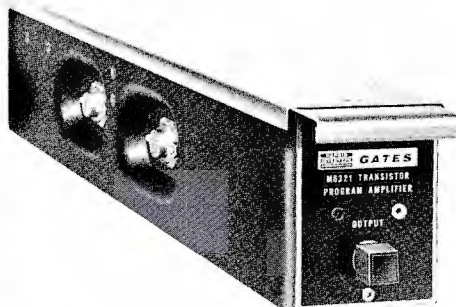
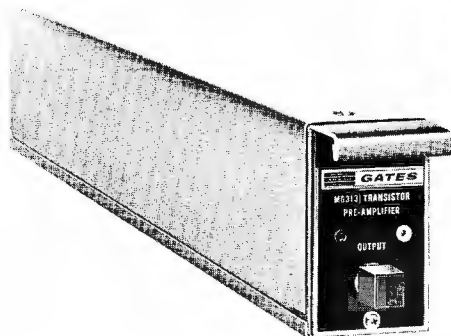

SPECIFICATIONS

M-6313A PREAMPLIFIER

GAIN: 40 dB, or 46 dB (by receptacle strapping), ± 0.3 dB.

FREQUENCY RESPONSE: ± 0.5 dB from 20 to 20,000 Hz, or ± 0.25 dB from 30 to 15,000 Hz.

DISTORTION: 0.25% maximum from 50 to 15,000 Hz @ +20 dBm output.

NOISE: -123 dBm relative input noise, 30 to 15,000 Hz, -11 dBm wideband.

SOURCE IMPEDANCE: 150/600 ohms balanced or unbalanced, center tapped.

LOAD IMPEDANCE: 150/600 ohms, balanced or unbalanced.

POWER: 48 volts DC @ 30 mA.

ORDER NUMBER.....994-6313A

M-6338 POWER SUPPLY

CAPACITY: Up to 50 M-6313 Transistor Preamplifiers, or up to 10 M-6314 Program/AGC amplifiers or any combination with a maximum rated current of 1.5 amps. Use for large systems or where growth is anticipated.

OUTPUT: 48 volts DC at 0 to 1.5 amps, continuous.

POWER: 110/117/123 volts, 50/60 Hz, 130 watts maximum.

SHORT CIRCUIT PROTECTION: Resistive short circuit protection allows full operation to resume after momentary short circuits on the output. Primary fuse prevents component damage with sustained short circuits.

ORDER NUMBER.....994-6338

M-6314A PROGRAM/AUTOMATIC GAIN CONTROL AMPLIFIER

GAIN: 62 dB, or 80 dB, ± 0.5 dB (by receptacle strapping).

FREQUENCY RESPONSE: ± 0.5 dB from 20 to 20,000 Hz.

DISTORTION: 0.25% maximum from 50 to 15,000 Hz (62 dB gain @ +32 dBm output level).

NOISE: -116 dBm relative input noise (62 dB gain mode) wideband.

GAIN REDUCTION: (AGC): Amplifier input/output characteristics linear below threshold of AGC @ +20 dBm output level. 6 dB gain reduction maximum in 62 dB gain mode. After maximum of 6 dB AGC, amplifier input/output characteristics become linear again. An input level of -24 dBm will result in 6 dB gain re-

duction and an output level of +32 dBm. Approximately 21 dB AGC in the 80 dB gain mode. An external switch permits disabling the AGC action without thumps or clicks in the program circuit.

ATTACK TIME: AGC attack time = 25, ± 3 milliseconds.

RECOVERY TIME: AGC recovery time = 0.5, ± 0.1 second.

SOURCE IMPEDANCE: 150/600 ohms, balanced or unbalanced, center tapped.

LOAD IMPEDANCE: 150/600 ohms, balanced or unbalanced, center tapped.

POWER: 48 volts DC @ 140 mA.

ORDER NUMBER.....994-6314A

M-6321 PROGRAM AMPLIFIER

GAIN: 62 dB, ± 0.3 dB, unterminated input.

FREQUENCY RESPONSE: ± 0.5 dB from 20 to 20,000 Hz or ± 0.25 dB, 30-15,000 Hz.

DISTORTION: 0.25% maximum from 50 to 15,000 Hz @ +32 dBm output.

NOISE: -116 dBm relative input noise, wideband.

SOURCE IMPEDANCE: 150/600 ohms, balanced or unbalanced, center tapped.

LOAD IMPEDANCE: 150/600 ohms, balanced or unbalanced, center tapped.

POWER: 48 volts DC @ 140 mA.

ORDER NUMBER.....994-6321

M-6421 POWER SUPPLY

CAPACITY: Up to ten M-6313 preamplifiers, or two M-6314 Program/AGC amplifiers, or any system combination with a maximum rated current not exceeding 300 mA for use in smaller systems.

OUTPUT: 48 volts DC at 0 to 300 mA continuous.

POWER: 117 volts nominal, 50/60 Hz, 30 watts.

SHORT CIRCUIT PROTECTION: Resistive momentary short circuits on output. Primary fuse prevents damage from sustained short circuits.

ORDER NUMBER.....994-6421

Solid State Plug-In Audio Amplifiers

5700 SERIES

For any audio system application in AM, FM, TV, recording or sound distribution, the "5700" series Solid-Statesman transistor plug-in amplifiers offer uniformly high quality performance exceeding the capabilities of vacuum tube amplifiers. Conservative design provides a 50% safety factor so that all amplifiers are capable of operation with a continuous

sine wave at maximum ambient temperatures, and at full rated output levels.

All circuits in the "5700" series utilize carefully chosen components with printed wiring on glass epoxy boards for uniformity, strength, and reliability. Connectors are gold-plated for absolute contact. Floating-type receptacles on the mating trays assure positive, fast alignment.

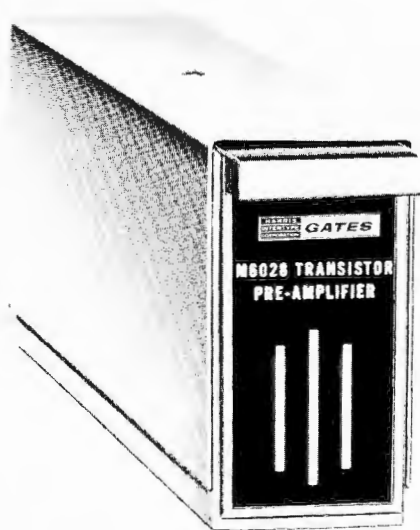

PREAMPLIFIER

Usually used to feed a mixing bus or program amplifier, this preamplifier operates from a microphone or similar low-level source and has sufficient gain to drive a line or monitor amplifier.

SPECIFICATIONS

GAIN: 40 dB.
RESPONSE: ± 0.5 dB, 30 to 15,000 Hz.
HARMONIC DISTORTION: Under 0.75% at 30 Hz, under 0.5% from 50 to 15,000 Hz at +18 dBm output.
NOISE: -122 dBm relative input noise, 30 to 15,000 Hz.
MOUNTING: Use Gates M-6030 mounting tray listed below.
POWER REQUIREMENTS: 30 volts DC at 30 mA.
SOURCE IMPEDANCE: 30/50-150/250-500/600 ohms (balanced or unbalanced).
LOAD IMPEDANCE: 150/250-500/600 ohms (balanced or unbalanced).
CONNECTORS: Gold-plated Blue Ribbon type.
SIZE AND FINISH: Size: 1 $\frac{3}{4}$ " wide, 3 $\frac{1}{8}$ " high, 10 $\frac{3}{4}$ " long. Finish: Cadmium-plated enclosure with black anodized escutcheon plate.
WEIGHT: 3 $\frac{1}{2}$ lbs. net.

ORDERING INFORMATION

Transistor plug-in preamplifier.....994-6028
 Mounting tray for M-6028.....994-6030

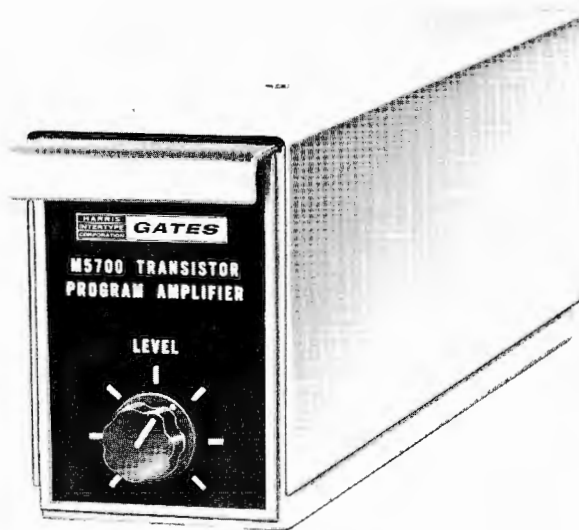

PROGRAM AMPLIFIER

A high performance program or line amplifier. Has gain control mounted on front. As many as seven amplifiers mount in one 19" x 3 $\frac{1}{2}$ " rack panel and shelf assembly.

SPECIFICATIONS

GAIN: 76 dB or less as adjusted by gain control.
RESPONSE: ± 1 dB from 30 to 15,000 Hz.
HARMONIC DISTORTION: Under 0.75% at 30 Hz; under 0.5% from 50 to 15,000 Hz at +24 dBm output.
NOISE: -122 dBm relative input noise, 82 dB below +24 dBm output with -40 dBm input.
MOUNTING: Use Gates' M-6031 mounting tray listed below.
POWER REQUIREMENTS: 30 volts DC at 90 mA.
SOURCE IMPEDANCE: 150/250 or 500/600 ohms (balanced or unbalanced).
LOAD IMPEDANCE: 150/250-500/600 ohms (balanced or unbalanced).
CONNECTORS: Gold-plated Blue Ribbon type.
SIZE AND FINISH: Size: 2 $\frac{1}{4}$ " wide, 3 $\frac{1}{8}$ " high, 10 $\frac{3}{4}$ " long. Finish: Cadmium-plated enclosure with black anodized escutcheon plate.
WEIGHT: 4 $\frac{1}{4}$ lbs. net.

ORDERING INFORMATION

Transistor plug-in program amplifier.....994-5700B
 Mounting tray for M-5700B.....994-6031

Audio Amplifier Accessories

ACCESSORIES

Complete mounting accessories are available for the "6300" series Solid-Statemans amplifiers. The M-6689 panel and shelf assembly unit occupies only 3½" x 19" of rack space. Built of heavy-gauge, plated, non-corrosive steel, finished in beige-gray, with hinged front panel. Individual mounting trays have been designed for each model amplifier and power supply.

In system practice a typical audio input signal may pass through four amplifiers, four faders, nine transformers, and be bridged a dozen or more times, yet the system performance at the output is equal to or better than any individual amplifier specification. Of particular importance is the higher rated output levels of both preamplifiers and program amplifiers to accommodate greater dynamic range at no increase in distortion.

NOTE: The source of load impedance of the amplifiers as listed in the specifications is the recommended impedance of the connecting device (such as a microphone, attenuator, line or loudspeaker). However, the input impedance of all four amplifiers is approximately ten times higher than the source impedance, giving the systems designer greater flexibility.

The output impedance is approximately 1/10 the load impedance, which permits multiple bridging without any degradation of the output signal.

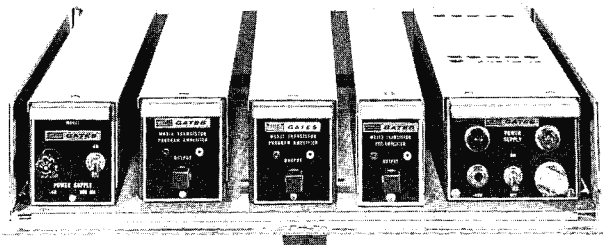

Above: M-6689 panel and shelf assembly, showing several "6300" series Solid-Statemans units. This assembly requires only 3½" x 19" of rack space.

ORDERING INFORMATION

| | |
|---|----------|
| Mounting tray for preamplifier | 994-6341 |
| Mounting tray for program amplifier | 994-6426 |
| Mounting tray for program/AGC amplifier | 994-6342 |
| Mounting tray for M-6421 power supply | 994-6422 |
| Mounting tray for M-6338 power supply | 994-6344 |
| Panel and shelf assembly | 994-6689 |

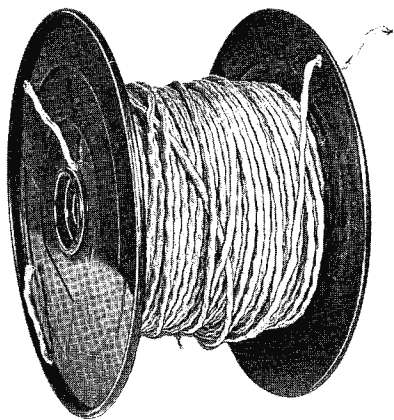

WIRE — AUDIO

| | |
|--|----------|
| 8410 Belden single conductor shielded, black rubber jacket..... | 250-0059 |
| 8412 Belden (Gates MIC-100) 2 conductor stranded 20 AWG Braided shield cotton wrap heavy rubber jacket..... | 250-0036 |
| 8428 Belden neoprene jacketed heavy duty mic cable. 2 conductor 18 AWG braided shield..... | 253-0024 |
| 5H-2-20 2 conductor stranded 20 AWG, 2/push back braided shield not insulated..... | 253-0018 |
| 1261 2 conductor stranded 24 AWG, braided shield, not insulated..... | 253-0001 |

The following are 2 conductor, color-coded broadcast audio cables which come in standard and miniature size. Type 8437 has a braided, tinned copper shield; types 8450 and 8451 have spiral-wrap aluminum-Mylar shields. All types have tinned drain wires. Available in 100, 500 or 1000 foot spools. Average shipping weight per 100 feet, 2½ lbs. Type 8451 available in black vinyl or gray jacket.

| | |
|---|----------|
| 8437 Belden 2 conductor 22 AWG solid, w/drain wire and braided shield, black vinyl jacket..... | 253-0062 |
| 8450 Belden miniature audio cable 2 conductor, 22 AWG solid, drain wire, foil shield vinyl jacket..... | 253-0054 |
| 8451 Belden miniature audio cable, 2 conductor 22 AWG stranded, drain wire, foil shield, vinyl jacket..... | 253-0059 |
| Cable 6 conductor, 3 pair, wire size 22 AWG..... | 250-0081 |
| Wire 18 AWG stranded, yellow..... | 252-0247 |
| High voltage wire 8 AWG 40 kV..... | 255-0006 |

Gates Division of Harris Intertype has a complete line of quality wire and cable to fill any broadcasting or communication need. Cable for every purpose—shielded, unshielded, multi-conductor, power, audio system and more.

The following wire recommended for microphone and shielded power supply cable has high abrasion resistance and extra flexibility. It is especially suited for installations where cable must take tight bends or lie perfectly flat. The cable has tinned conductors with tinned copper-braided shield.

Rack Cabinets

RAK-70

Designed with the flexibility to accommodate all types of equipment. Whether used as a rack only, or a complete cabinet with all accessories, the RAK-70 can fill almost any special requirement of the individual broadcaster.

Included with the RAK-70 are two panel mounting angles; an air filter mounted in rear of cabinet base; knock-outs for wiring in bottom and sides of base; universal-standard EIA panel hole spacing; and 10-32 panel hardware.

SPECIFICATIONS

SIZE: Height, 78"; Width, 22½"; Depth, 22".

PANEL SPACE: 19" × 70".

WEIGHT: Domestic packed 175 lbs., Export packed 275 lbs.; Cubage, 28 cubic feet.

FINISH: Beige-gray.

(NOTE: Each side panel adds ¾" to overall width, and door adds 1⅝" depth.)

RAK-70A

The RAK-70A and included items are similar to the RAK-70, except for height.

SPECIFICATIONS

SIZE: Height, 72"; Width, 22½"; Depth, 22".

WEIGHT: Domestic packed 170 lbs., Export packed 265 lbs.; Cubage, 26 cubic feet.

FINISH: Beige-gray.

RAK-80

The RAK-80 is designed with more depth than normally found in a standard rack cabinet to accommodate television monitors and test equipment. Provided are two panel-mounting angles, an air filter mounted in the rear of the cabinet base, knock-outs for wiring in bottom and sides of base, universal standard EIA panel hole spacing and 10-32 hardware. The RAK-80 may be used as a complete cabinet with all accessories or as a rack only.

SPECIFICATIONS

SIZE: Height, 72"; Width, 22½"; Depth, 25½".

PANEL SPACE: 19" × 64¾".

WEIGHT: Domestic packed, approx. 180 lbs., Export packed, 350 lbs.; Cubage, 34.3 cubic feet with doors.

RAK-7

Solid-side rack cabinet built of lightweight steel. Has solid sides, solid base, full size rear door with louvers at top and bottom.

SPECIFICATIONS

SIZE: Height, 78"; Width, 23½"; Depth, 19½".

OVERALL PANEL SPACE: 19" × 71¾".

WEIGHT: Domestic packed 115 lbs., Export packed 200 lbs.; Cubage, 18 cubic feet.

Universal standard EIA panel hole spacing, 10-32 panel hardware provided.

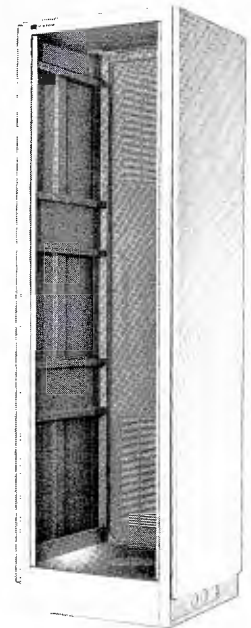

RAK-70
RAK-70A
RAK-80

NOTE: See ordering information below for all models.



RAK-7

ORDERING INFORMATION

RAK-70

| | |
|--|--------------|
| Basic cabinet assembly | 994-6643-002 |
| Side panel | 994-6664-001 |
| Louvered top | 994-6665-001 |
| Door with louvers | 994-6671-001 |
| Door without louvers | 994-6671-002 |
| Key-type lock for doors | 448-0320-000 |
| Fan kit | 994-6666-001 |
| Air filter kit (Recommended when using fan kit) | 994-6668-001 |
| (2) Rear panel mounting angles | 994-7035-001 |
| Panel mounting hardware (30 provided with basic racks) | 992-2539-001 |

RAK-70A

| | |
|--------------------------|--------------|
| Basic cabinet assembly | 994-6713-001 |
| Side panel | 994-6714-001 |
| Louvered top | 994-6665-001 |
| Door with louvers | 994-6715-001 |
| Door without louvers | 994-6715-002 |
| Key-type lock for doors | 448-0320-000 |
| Fan kit | 994-6717-001 |
| Air filter (replacement) | 448-0288-001 |

| | |
|--|--------------|
| (2) Rear panel mounting angles | 994-6716-001 |
| Panel mounting hardware (30 provided with basic racks) | 992-2539-001 |

RAK-80

| | |
|--|--------------|
| Basic cabinet assembly | 994-6761-000 |
| Side panel | 994-6762-001 |
| Louvered top | 994-6892-001 |
| Door with louvers | 994-6715-001 |
| Door without louvers | 994-6715-002 |
| Key-type lock for doors | 448-0320-000 |
| Fan kit | 994-6763-000 |
| Air filter replacement | 448-0288-000 |
| (2) Rear panel mounting angles | 994-6716-001 |
| Panel mounting hardware (30 provided with basic racks) | 992-2539-001 |

RAK-7

| | |
|-----------------------------------|--------------|
| Rack cabinet | 994-5527-003 |
| Joiner strip | 994-5577-001 |
| Extra panel mounting hardware kit | 994-6582-001 |

Program And Monitoring Amplifiers

PROGRAM OR LINE AMPLIFIER

Studio equipment facilities often may be expanded by adding a second or third program amplifier. In single channel consoles the audition bus may be used for separate programming of FM by inserting the M-5576B program amplifier between the bus and the line. For bridging, standby and network feeds, this amplifier mounted in the equipment rack is ideal.

This high gain, low distortion, 4-stage program amplifier includes a self-contained power supply and requires only 5¼" of rack space. A dual gain control with one section in the second stage grid and the other section in the third stage grid assures a low noise ratio at any gain setting.

SPECIFICATIONS

GAIN: 75 dB, ± 2 dB.
RESPONSE: $\pm 1\frac{1}{2}$ dB, 30-15,000 Hz.
DISTORTION: 0.75% at +12 dBm output, 30-15,000 Hz. 1% at +22 dBm output, 50-15,000 Hz.
NOISE: 60 dB below +12 dBm output or equal to -120 dBm relative input noise.



IMPEDANCES: Input and output: 150/250 or 500/600 ohms.
POWER: 117 volts, 50/60 Hz, 45 watts.
TUBES: (3) EF86 and (1 each) 12AU7, 6X4.
MECHANICAL: 19" x 5¼" x 7½" deep. Weight packed (domestic), 27 lbs.; (export) 50 lbs. Cubage: 2 cubic feet. Finish: beige-gray.

ORDERING INFORMATION

Program amplifier with tubes.....994-5576B
 Spare 100% tube kit.....990-0450



MONITORING AMPLIFIER

In quality audio systems, the need for excellence in loudspeaker distribution is paramount. Here is an outstanding ultra linear amplifier offering a variety of input impedances, very low distortion, excellent power output and high gain. Input impedances for matching 30/50 and 150/250 ohm lines or bridging at 30,000 ohms are available. An unusually high gain of 100 dB allows the M-5575 monitoring amplifier to be used directly from a mixer program bus, low level turntable output or a microphone. The distortion is less than 1%, though a full 10 watts of power is produced from a -60 dBm input.

SPECIFICATIONS

GAIN: 100 dB or bridging 50 dB.
RESPONSE: $\pm 1\frac{1}{2}$ dB, 30-15,000 Hz.
DISTORTION: 1% or less 50-15,000 Hz at +40 dBm (10 watts).
NOISE: 60 dB or better below +40 dBm, measured at -50 dBm input.
IMPEDANCES: (Input) 30/50 or 150/250 ohms at 100 dB gain. 30,000 ohms bridging at 50 dB gain. (Output) 8 and 16 ohms.
POWER: 117 volts, 50/60 Hz, 85 watts.
TUBES: (3) 12AX7, (2) EL84, (1) GZ34, (1) OA2, (1) OB2.
MECHANICAL: 19" x 7" x 8" deep. Weight packed (domestic), 34 lbs.; (export) 59 lbs. Cubage: 3 cubic feet. Finish: beige-gray.

ORDERING INFORMATION

Ultra linear monitoring amplifier, with tubes.....994-5575
 Spare 100% tube kit.....990-0303
 Speaker matching transformer.....478-0291

Monitoring And Utility Amplifiers

TRANSISTOR MONITOR AMPLIFIER

Offering the superb performance of transistors, Gates M-6108 professional 8-watt monitoring amplifier is designed for the exacting demands of modern broadcasting. Only 4½" x 8½" x 3½" including self-contained power supply, it will fit anywhere, even in the corner of a loudspeaker cabinet. The almost negligible operating temperature lends to its versatility.

The M-6108 will produce 20-20,000 Hz response within ±1 dB with no more than 1% distortion at a full eight watts output. Gain of 53 dB from a 600 ohm input or 39 dB from the 6,000 ohm bridging input assures wide versatility. The output of 4-16 ohms for direct speaker connection may be changed to other higher impedances through the use of an optional external matching transformer.



SPECIFICATIONS

GAIN: 53 dB using 600 ohm input; 39 dB using 6000 ohm bridging input.
RESPONSE: 20-20,000 Hz ±1 dB.
DISTORTION: 1% or less 8 watts output, 50-15,000 Hz. 1% or less 6 watts output, 30-15,000 Hz.
NOISE: 85 dB below +39 dBm output (8 watts).
IMPEDANCES: (Input) 600 ohms matching, 6000 ohms bridging, transformer input. (Output) 4 to 16 ohms.

POWER: 117 volts, 50/60 Hz, 18 watts.
SIZE: 4½" wide, 8½" long, 3½" high.
WEIGHT: 4 lbs. net.

ORDERING INFORMATION

Eight-watt transistorized monitor amplifier.....994-6108

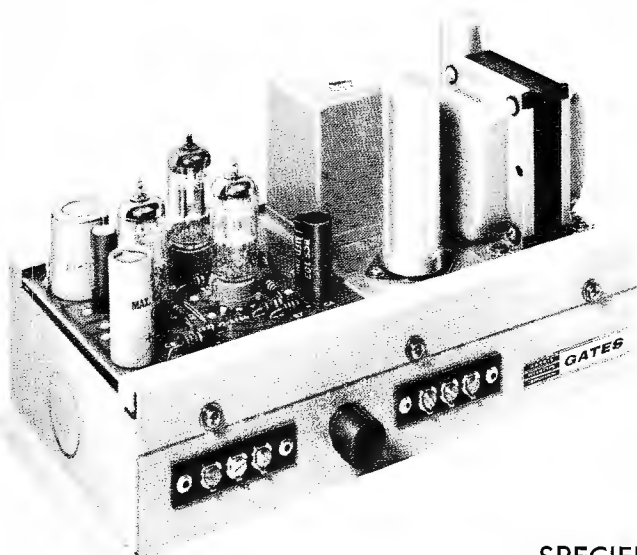

SINGLE CHANNEL UTILITY AMPLIFIER

Often called the most important of amplifiers, as it fills almost any amplifier need. AC operated and completely self-contained, the M-5530 all purpose amplifier operates as (a) a single microphone remote amplifier, (b) turntable preamplifier with ample gain for passive equalizers, (c) standby program amplifier, and (d) a microphone amplifier for medium level tape recording. Mounts nicely in turntable cabinet. Ideal for permanent remotes.

SPECIFICATIONS

GAIN: 81 dB.
RESPONSE: 30-15,000 Hz ±1½ dB.
DISTORTION: 1% or less 50 to 15,000 Hz at +8 dBm output or 2% at +18 dBm.
NOISE: 60 dB below +8 dBm.
IMPEDANCES: (Input) 30/50 or 150/250 ohms. (Output) 150/250 or 500/600 ohms.
POWER: 115 volts, 50/60 Hz. Consumption 15 watts.
TUBES: (2) EF86/6267, and (1 each) 12AU7, 6X4.

SIZE: 11" x 5" x 5¾" deep.
WEIGHT: Net 9½ lbs. Packed 20 lbs. Cubage: 2 cubic feet.

ORDERING INFORMATION

Single channel utility amplifier with tubes.....994-5530
 Chassis connector (female).....612-0194
 Microphone connector (male).....610-0182
 Spare 100% tube kit.....990-0280

HARRIS
 GATES DIVISION
 Harris Intertype Corporation

Audio Accessories

CUEING AMPLIFIER

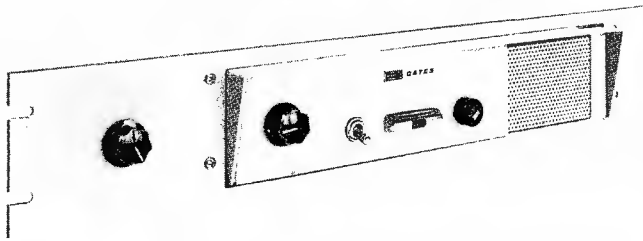

Program preview of 10 audio circuits may be selected by a rotary switch with this high gain, compactly designed cueing amplifier. Requiring only 3½" of rack space, Gates' Uni-Que amplifier has a self-contained loudspeaker and is easily adaptable to convenient desk mounting. High gain allows cueing direct from turntable, tape, projector circuits and microphone preamplifier outputs.

SPECIFICATIONS

GAIN: 70 dB low impedance matching, 35 dB bridging, ±2 dB.
INPUT LEVEL: -20 dBm matching or +22 dBm bridging.
RESPONSE: Peaked for high intelligibility.
IMPEDANCES: (Input) 30/50, 150/250 or 10,000 ohms bridging. (Output) to self-contained speaker with muting terminals external.
NOISE: 60 dB or better below speaker level of about +30 dBm.
POWER: 105/125 volts, 50/60 Hz, 25 watts.
POWER SUPPLY: Solid state, transformer input (not AC/DC).
TUBES: (1) 12AX7, (1) 50C5.
MECHANICAL: 19" × 3½" × 6½" deep. Weight packed: (domestic) 16 lbs., (export) 30 lbs. Cubage: 2 cubic feet. Finish: Beige-gray.

ORDERING INFORMATION

Cueing Amplifier with tubes 994-5377
 Spare 100% tube kit 990-0305

POWER CONTROL PANEL



Each rack of audio and radio frequency equipment should have a master power control panel. The Gates power control panel combines convenient on-off switching of 110 VAC and/or 220 VAC with the reliability of a modern magnetic circuit breaker. The circuit breaker eliminates the need to replace fuses and provides more accurate sensing of overload conditions. A neon pilot light indicates "power on" status. 19" × 3½" × 3½".

Power Control Panel 994-7001

VU METER PANEL

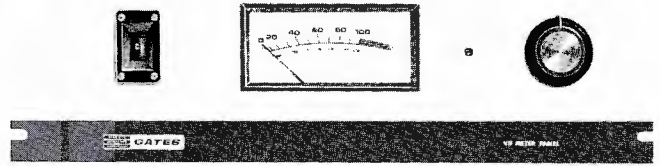

Gates' VU Meter Panel provides a standard instrument for interpreting program levels in terms of Volume Units. It uses a VU meter with the correct ballistic characteristics (ANSI Standard) to permit an industry-accepted measurement of complex waveforms. A precision variable attenuator extends the measurement capability to cover the most used range of program line levels. A 10-position channel selector switch is provided. The frequency is very nearly flat over the entire audio frequency range. Nominal input impedance: 7500 ohms. 19" W × 5¼" H × 2¾" D.

VU Meter Panel 994-6973

STUDIO WARNING LIGHTS



An unusually attractive studio fixture with edgewise lighting of a plexiglass transparent plate. Incandescent lamp is housed in gun-metal casing. Mounting is usually above studio door. "On Air" lettering is in red with other nomenclatures, such as "Studio A", etc. supplied in black. Housing is well ventilated, without light leakage. Size: 18" wide, 3" front to back, and 6½" from bottom of glass to top of housing. 117 volts, 50 watts. UL approved.

ORDERING INFORMATION

| LETTERING | ORDER |
|---|----------|
| On Air (in red) | 406-0269 |
| Special lettering up to 12 characters (specify) | 406-0278 |
| On The Air (QF-15 Rollins) | 406-0285 |
| Studio A (QF-15 Rollins) | 406-0280 |
| Studio B (QF-15 Rollins) | 406-0281 |

Audio Accessories

PATCH CORDS



Patch cords have double plug on each end, with cords in 4 lengths. Cords are shielded and covered with double black braid, with extra reinforcement 6" from each plug end.

ORDERING INFORMATION

| | |
|--|----------|
| Double patch cord with 2' cord (PJ-12) | 250-0002 |
| Double patch cord with 3' cord (PJ-13) | 250-0003 |
| Double patch cord with 4' cord (PJ-14) | 250-0004 |
| Double patch cord with 5' cord (PJ-15) | 250-0005 |

STUDIO CUE/INTERCOM SPEAKER

The studio cue/intercom speaker is a modern design, high efficiency cue speaker mounted in a cast aluminum housing and finished in black, with attractive grill. It may be used for cue listen or cue talk-back. Matches either 48 or 600 ohms. Size: 5 1/8" wide, 6 1/2" high and 4" deep, with a 30° slope when placed on desk.



ORDERING INFORMATION

| | |
|-----------------------------------|----------|
| Studio cue/intercom speaker | 994-6424 |
|-----------------------------------|----------|

DESK OR CONSOLE TOP VU METER

Used on Gates' Solid-Statesman consoles, this completely housed VU meter is ideal for many audio applications. Standard scale B illuminated 4" VU meter in cast aluminum housing 5 1/8" x 6 1/2" x 4" deep.



ORDERING INFORMATION

| | |
|--|----------|
| VU meter (30° slope when placed on desk) | 994-6208 |
|--|----------|

SPEAKER MATCHING TRANSFORMER

Where many speakers are used, the normal 8 ohm voice coil impedance will cause a mismatch. This transformer has a primary of 48 ohms and a secondary of 8 ohms. Thus, six transformers in parallel will reflect the normal 8 ohms output impedance of the studio monitor amplifier.

| | |
|--|----------|
| Speaker matching transformer (not shown) | 478-0291 |
|--|----------|

PATCH PANELS

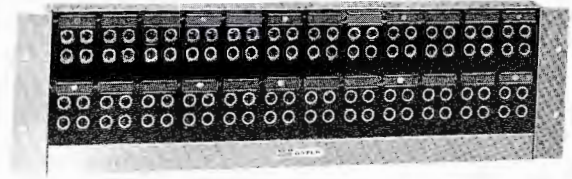

Illustrated above are two PJ-341 jack strips on a PD-2 jack mat to supply 48 pairs or 96 jacks in a 19" x 5 1/4" rack space.

Industry standard double jack panels. Jack strips and jack mats are listed separately below for ease in ordering. Jacks are closed circuit type to normal through audio circuits when patch cord plugs are not inserted.

ORDERING INFORMATION

| | |
|---|----------|
| Jack strip only (PJ-343), 24 jacks or 12 pairs (no jack mat required) | 612-0307 |
| Jack strip only (PJ-341), 48 jacks or 24 pairs (less mat) | 612-0306 |
| Jack mat for one PJ-341 jack strip (PD-1) | 994-4399 |
| Jack mat for two PJ-341 jack strips (PD-2) | 994-4400 |
| Jack mat for three PJ-341 jack strips (PD-3) | 994-4401 |

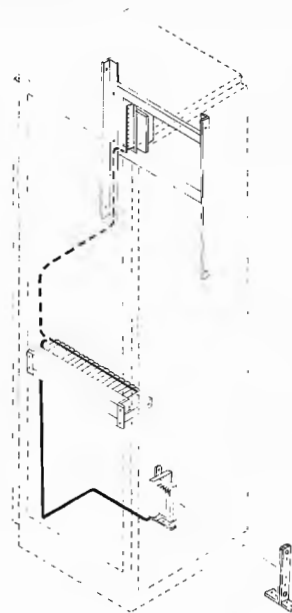

PRE-WIRED JACK PANEL AND TERMINAL BOARD

This assembly provides a 24-pair patch panel which is mounted on a Gates PD-1 mat and connected to a 120-terminal audio block. The connecting cord is eight feet long, and contains 24 shielded cables. The unit is ready for mounting in a rack or similar cabinet. All hardware for mounting is supplied.

ORDERING INFORMATION

| | |
|---|----------|
| Pre-wired jack panel and terminal board | 994-6891 |
|---|----------|



Audio Accessories

TRANSCRIPTION STORAGE CABINETS

For convenient filing and protection of records or tapes, use modern Wallach storage cabinets. Models available for all

sizes of discs and tape reels. Modular systems for desk and floor mounting, with doors and locks, also available.

DISC CABINET



Protect those expensive and fragile 12" LP's as they should be. Holds 540 12" LP's with a heavy red wallet for each. Includes two sets of numbers, 1620 printed catalog cards and card file. Size: 60" x 29" x 14" deep. Double door with lock and key.

Disc cabinet448-0134

LP ALBUM CABINET

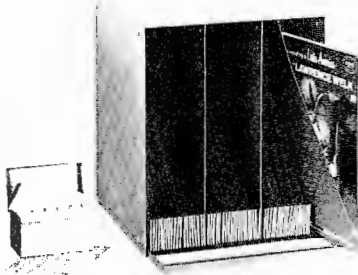

Holds sixty 7", 10" or 12" albums. Includes cataloging system with index cards for fingertip control. Size: 13 1/8" x 15 5/8" x 14" deep.

Cabinet for 60 albums448-0230
As above, with snap catch door448-0231

DOUBLE DOOR TAPE CABINETS, WITH LOCK

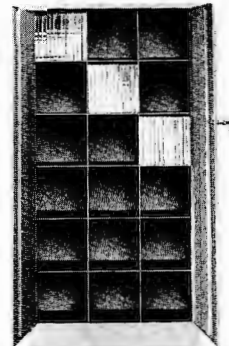

Cabinet for 7" reel boxes. 18 compartments — capacity to 288 reel boxes. 29" x 60" x 10" deep.

Cabinet448-0130

Cabinet for 10 1/2" reel boxes. 12 compartments — capacity to 192 reel boxes. 29" x 60" x 10" deep.

Cabinet448-0178

TAPE CABINETS



Holds 42 reel boxes of 7" tape reels. Has six compartments. May be stacked as desired. 13 1/8" wide, 12 5/8" high, 8 5/8" deep.

Cabinet448-0043

Holds 21 reel boxes of 10 1/2" tape reels. Has three compartments. May be stacked as desired. 13 1/8" wide, 12 5/8" high, 12" deep.

Cabinet448-0074

CONNECTORS

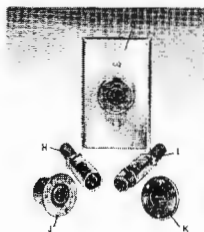

- (G) Single, 3 prong, female, 1 wall plate (XLR3-35) 612-0188
- (H) Cable plug, 3 prong, male. (XLR3-12C) 610-0182
- (I) Cable receptacle, female, 3 prong (XLR3-11X) 612-0182
- (J) Chassis receptacle, female, 3 prong (XLR3-13) 612-0194
- (K) Chassis receptacle, male, 3 prong (XLR3-14) 610-0194

AUDIO TERMINAL BLOCK

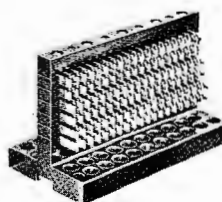

For inter-rack or jack field wiring. Molded one-piece black phenolic with base 3 1/2" x 6 1/8". 3 1/2" high. Plated brass terminals. Polished phenolic finish. Mounts in Gates rack cabinets with BRK-1 bracket. 120 terminals in six rows.

Audio terminal block614-0339

Audio Accessories

BOOM STANDS

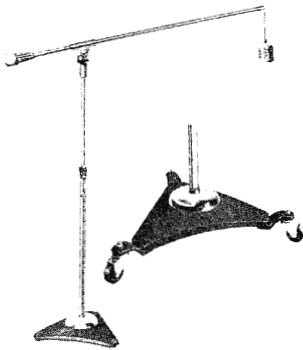

Provide convenient and proper microphone placement where correct position cannot be reached with conventional stands. Boom length 62 inches, height adjustable from 4 ft to 6 ft. Base diameter 17 inches, tubular sections super-chrome plated. "Snap On" hangers provided for microphone cable. Shipping weight 33 lbs.

Boom Stand without casters.....720-0061
Boom Stand with silent casters.....720-0062

ADJUSTABLE MICROPHONE ARM

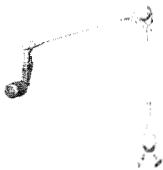

Flexo Mikester Mike Support Arm clamps or screws to any position. Swings to 36 inches fully extended. Mounts any microphone up to 4 lbs. Shipping weight 7 lbs.

Flexo Mikester.....720-0040

HEADPHONES



BA-200 Brush. Smartly styled, unusually sensitive high impedance crystal headset. Dual earpieces. Monophonic service.

Dual Headset.....721-0003

BA-201 Brush. Single headpiece version of above. High impedance crystal type.

Single Headset.....721-0004

TRIM economy headset. Featherweight dual earpiece model, recommended for utility monitoring use such as remotes, etc. Impedance 24,000 ohms.

Model 107 TRIM Dual Headset.....721-0006

STEREOPHONIC Headphones. High impedance dual headset for control room monitoring with stereophonic consoles such as the Gates Executive or Stereo Statesman.

BA-206B Stereo Headset.....721-0009

511 TRIM Headphone Plug.....610-0273

DESK STANDS



Model 419. Heavy weight desk stand for use with EV665 or similar microphones.

Desk Stand.....720-0028

Model 420. Die cast stand for G-700, EV654A, EV655C or similar microphones.

Desk Stand.....720-0029

Model 421. Desk stand for G-800, RE-10, RE-11, RE-15 and RE-16.

Desk Stand.....720-0248



DS-7. Adjustable desk stand for all popular microphones. Tubular section adjusts from 8 to 13 inches. Heavy chrome-plated stem and gray cast base with felt feet.

Desk Stand.....720-0076

DS-5. Non-adjustable desk stand. Chrome-plated tube 4" high. 6" diameter cast iron base with rubber feet.

Desk Stand.....720-0035

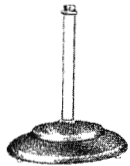

TS-8. Banquet stand. Adjustable 14 1/2" to 26". Chrome stem sections with velvet-action clutch adjustment. 8" diameter base.

Banquet Stand.....720-0150

TAPE SPLICER

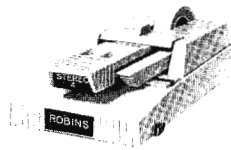

Deluxe "Stereo 4" tape splicer with integral tape dispenser for splicing tape. Two-position, replaceable cutting blades. Makes diagonal splice, cuts tiny trims on sides. Made of strong "Implex" plastic. With 100' roll of 1/2" splicing tape and instructions. Shipping wt., 1 lb. Made by Robbins.

"Stereo 4" Tape Splicer.....732-0099

EDIT-ALL PROFESSIONAL SPLICER

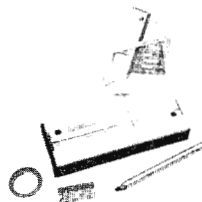

The standard editing device used by professional recording engineers. It is the only precision editing block especially designed with a curved groove to hold the tape firmly without damage. Designed by a network tape editor. Precision machined, will never wear out. Kit complete with block, Mylar splicing tape, blade, marking pencil, and instructions. Wt., 1 lb.

Edit-all Splicing Kit.....732-0167

FLOOR STANDS



MS-25. Professional microphone floor stand. "Air-Lock" cushion controls drop, prevents slippage and microphone damage. Adjusts from 37 to 66 inches. Heavy, triangular base 17 inches in diameter. Full chrome with medium gray base. Fits all microphones listed in this catalog. Weight, 25 lbs.

Professional Floor Stand.....720-0048

MS-10C. Excellent for average weight microphones. Has 10" diameter base, chrome 2-section tube. Adjusts 35 to 64 inches. Wt., 13 lbs.

Utility Floor Stand.....720-0047

BB-1. "Baby Boom" stand attachment. Converts any floor stand with 5/8"-27 thread to boom-type stand. 32" boom, adjustable counter balance for various microphones. Wt., 6 lbs.

Baby Boom attachment (no stand).....720-0059

NOTE: All mic stands on this page have 5/8"-27 thread, which is standard in the industry.

BULK TAPE ERASER



Professional model HD-11M. Heavy duty unit erases entire reel of tape at once, in seconds. Lowers residual noise 3 to 6 dB below most erase-head levels. Recommended for tape cartridges or reels up to 10 1/2". Adaptor hub available for 10 1/2" NAB reels. 117 volts, 50/60 Hz. Weight, 9 lbs. Made by Microtran.

Bulk Eraser.....732-0096

Adaptor Hub for 10 1/2" reels.....732-0043

JIFFY TAPE ERASER

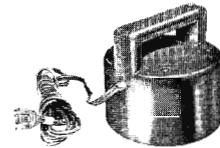

Compact unit erases tape conveniently. For cartridges or any size reel. Holds in hand, with momentary pushbutton operation. 117 volts, 60 Hz. Weight, 5 lbs.

Jiffy Hand-Type Tape Eraser.....730-0102

TAPE HEAD DEMAGNETIZER

Model 400. Removes residual magnetism from tape heads for optimum signal-to-noise ratio and protects tapes against deterioration. For 117 volts, 60 Hz. Wt., 1 lb.

Head Demagnetizer.....730-0180

HARRIS
 GATES DIVISION
 Harris-Intertype Corporation

Speakers and Speaker Systems

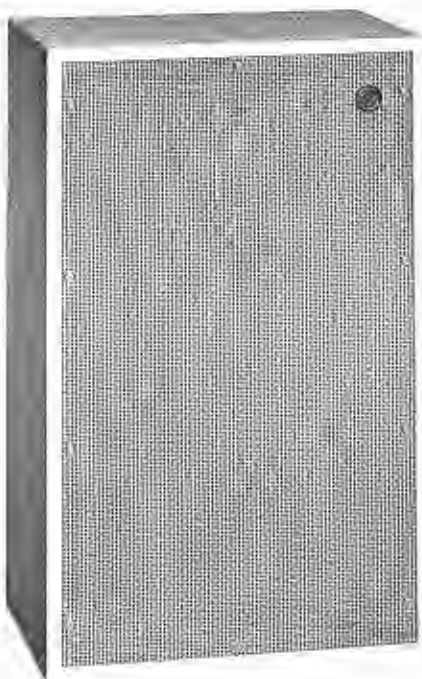

Sentry 11A floor model.



Sentry 1A wall or ceiling model

STUDIO MONITOR SYSTEMS

Designed specifically for monitor use in recording and broadcast studios, these loudspeaker systems permit precise monitoring and equalization uncolored by monitor speakers. Precision driver components include 12" Radax loudspeaker, diffraction horn, high frequency driver and special crossover. Quality hardwood cabinet, sanded and sealed, ready for finishing. Neutral cane grill cloth.

SPECIFICATIONS

FREQUENCY RESPONSE: 30 to 20,000 Hz.
EIA SENSITIVITY RATING: 49 dB.
POWER CAPACITY: 20 watts.
IMPEDANCE: Tapped transformer accommodates 16, 150 or 600 ohms.

ORDERING INFORMATION

FLOOR MODEL: Finished on all four sides. Size: 32" x 20" x 13" deep. Net weight: 63 lbs.
ORDER NUMBER722-0051
WALL MODEL: Size 21½" x 37" x 16¾" deep. Net weight: 82 lbs.
ORDER NUMBER722-0044

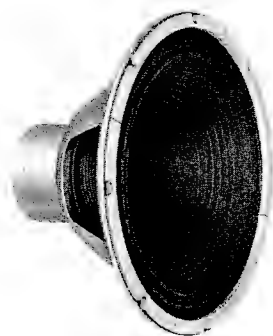

GATESPEAKER 12

This is an ideal monitor speaker for the broadcaster, with high-quality, wide range performance, plus heavy duty construction. Thirteen watts power handling capability and response from 35 to 17,000 Hz. 5½" over-all depth. An excellent replacement speaker.

SPECIFICATIONS

MAGNET WEIGHT: 4.64. **POWER:** 13 watts.
VOICE COIL IMPEDANCE: 8 ohms. **SIZE:** 12 inches.

ORDERING INFORMATION

Gatespeaker 12722-1200



GATESPEAKER 8

Offering wide range, sturdy construction and minimum cost, the Gatespeaker 8 is one of the finest utility monitor speakers available. Will reproduce lows to 50 Hz and highs to 12,000 Hz.

SPECIFICATIONS

MAGNET WEIGHT: 2.64. **POWER:** 11 watts.
VOICE COIL IMPEDANCE: 8 ohms. **SIZE:** 8 inches.

ORDERING INFORMATION

Gatespeaker 8722-0800

SPEAKER TRANSFORMERS AND PADS

TR-15 matching transformer. 15 watt capacity. 35-20,000 Hz, 2 dB. Pri 333/500/1000/2000 ohms. Sec 4/8/16 ohms.
 Matching transformer TR-15 478-0250
 Transformer, primary 45/48 ohms, sec. 8 ohms 478-0291*
 Volume control, 8-ohm T-pad 554-0227
 Volume control, 4-ohm T-pad 554-0180
 *Use with Gates audio control consoles.

Wall and Corner Baffles



DWB-12A



DWB-8A

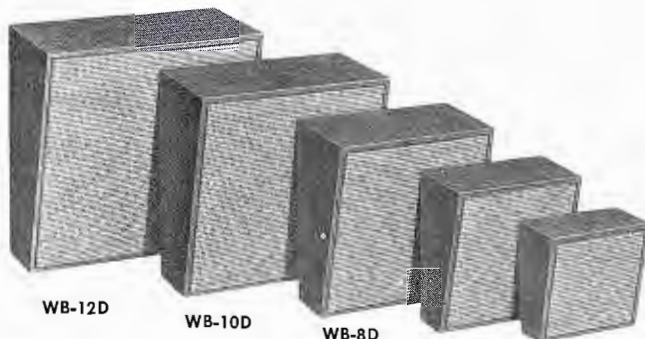

WB-12D

WB-10D

WB-8D

WB-6D

WB-4/5D

DELUXE WALL BAFFLES

Natural hardwood, richly finished in Dusk Walnut or Antique Birch . . . fits into the finest surroundings. Genuine birch has rich satin-smooth appearance. Grill cloth is attractive cane. Has many popular features for better sound and easy handling, including slanting front construction for increased cubic volume. Speaker hardware already firmly fixed in place. Mounting clip included.

DWB-8A—Takes 8-inch speaker, maximum speaker depth 4½".
Size: 10" x 10¾" x 6½". Shipping weight for 2, 5½ lbs. State birch or walnut finish.....DWB-8A

DWB-12A—Takes 12" speaker, maximum speaker depth 6½".
Size: 13¾" x 14" x 9½". Shipping weight for 2, 9 lbs. State birch or walnut finish.....DWB-12A

REGULAR WALL BAFFLES

Extremely durable, with rugged construction that not only increases rigidity but also eliminates the possibility of baffle resonance and sound distortion. A durable vinyl cover adds warmth and texture to the appearance. Cane grills provide a modern touch that blends with almost any installation decor. Topping off the appearance of these baffles is the sculptured look which dramatically frames the grill. Clips and all speaker hardware are included. Available in either blond or walnut wood-grained vinyl at the same price. State blond or walnut when ordering.

WB-4/5D—4" or 5" speaker, maximum speaker depth 2¾".
Shipping weight for 2, 3 lbs.....WB-4/5D

WB-6D—For 6" speaker, maximum speaker depth 3¾". Shipping weight for 2, 4 lbs.....WB-6D

WB-8D—For 8" speaker maximum speaker depth 4¾". Shipping weight for 2, 6 lbs.....WB-8D

WB-10D—For 10" speaker, maximum speaker depth 5¼". Shipping weight for 2, 8 lbs.....WB-10D

WB-12D—For 12" speaker, maximum speaker depth 6¾". Shipping weight for two, 11 lbs.....WB-12D



SLANTING CORNER BAFFLES

Rigid construction with wood-grain vinyl covering, and modern cane grill. Superb tone. Slant front aims sound down, corner location increases effective air mass.

Bass enhanced by acoustic padding. Bass reflex design. No screws to hold grill in place or mar its appearance. Mounting clips provide quick, sure, concealed mounting. All mounting hardware is included. State blond or walnut.

SCB-8D—Takes 8" speaker. Maximum speaker depth, 5½". Shipping weight 6 lbs.....SCB-8D

SCB-12D—For 12" speaker. Maximum speaker depth, 6½". Shipping weight 8 lbs.....SCB-12D

Regular and Deluxe Baffle Speaker Size

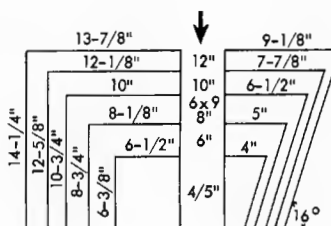

REDUCING RING

R-8/12—to mount 8" speaker in any 12" cabinet, console, or baffle. Made of ¾" plywood with all holes drilled and hardware included. Ship. Wt. 1 lb.R-8/12

Gates Professional Broadcast Microphones

EV 635A

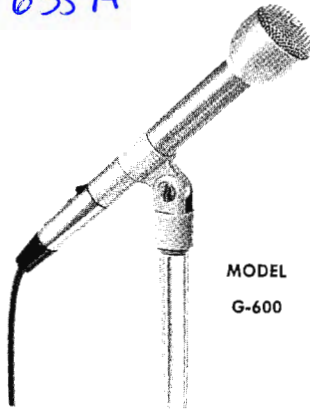

MODEL
G-600

Gates' G-600 is a dynamic, omnidirectional microphone designed for exacting professional applications—ideally suited for film production, recording, FM, AM and TV broadcasting. The high output level and low sensitivity to mechanical shock make it excellent for pass around use in audience participation, for hand-held use by vocalists, or as a lavalier.

SPECIFICATIONS

TYPE: Dynamic.
FREQUENCY RESPONSE: 80-13,000 Hz.
POLAR PATTERN: Omnidirectional.
IMPEDANCE: Low (150 ohms).
OUTPUT LEVEL: -55 dB (0 dB=1 mw/10 dynes/cm²).
FINISH: Fawn charcoal.
CABLE: 18 ft. two-conductor, shielded.
ACCESSORIES: Lavalier neck cord assembly and 310 clamp furnished.

ORDERING INFORMATION

Gates' G-600 microphone720-0267

EV 654A (obs.)
windscreen
720-0152



MODEL
G-700

Designed for professional use, FM, AM and TV broadcasting, the G-700 is a dynamic, omnidirectional microphone with outstanding performance characteristics. Wide frequency response, broad pickup range, and light weight make it excellent for TV staging and for pass around use.

SPECIFICATIONS

TYPE: Dynamic.
FREQUENCY RESPONSE: 50-15,000 Hz.
POLAR PATTERN: Omnidirectional, becoming slightly directional with increase in frequency.
IMPEDANCE: Matches all low impedances 50 through 250 ohms. Line balanced to ground and phased.
OUTPUT LEVEL: -57 dB (0 dB=1 mw/10 dynes/cm²).
FINISH: Fawn Charcoal.
CABLE: 18 ft. 3-conductor, shielded.
ACCESSORIES: Model 300 stand clamp (adapts to 1/2" or 3/8"-27 pipe thread), lavalier neck cord.

ORDERING INFORMATION

Gates' G-700 microphone720-0268

EV RE-10

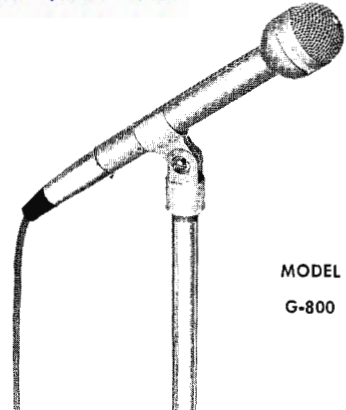

MODEL
G-800

The G-800 is a dynamic cardioid microphone created especially for professional applications requiring a sharply controlled super-cardioid directional pattern. The G-800 possesses a degree of directional control so effective that frequency response is virtually independent of location of sound source. An easily operated "bass-tilt" switch corrects spectrum balance for longer reach situations.

SPECIFICATIONS

TYPE: Dynamic.
FREQUENCY RESPONSE: 90-13,000 Hz.
POLAR PATTERN: Super cardioid.
IMPEDANCE: Lo-Z (150 ohms nominal).
OUTPUT LEVEL: -56 dB (0 dB=1 mw/10 dynes/cm²).
FINISH: Fawn charcoal.
CABLE: 18 ft. 2-conductor, shielded.
ACCESSORIES: 310 stand adapter, and protective metal carrying case.

ORDERING INFORMATION

Gates' G-800 microphone720-0269

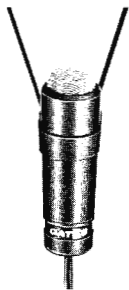

Shure
M570

MODEL
G-500

Dynamic lavalier microphone. A studio quality unit designed in size and performance for TV and similar applications where a miniature, tailored response microphone is required.

SPECIFICATIONS

RESPONSE: 50 to 12,000 Hz, rising to 6 kHz.
IMPEDANCE: 50-250 ohms.
OUTPUT LEVEL: -59 dB.
POLAR PATTERN: Omnidirectional.
FINISH: Non-reflecting gray with stainless steel grill.
CABLE: 30 foot, 2 conductor shielded.
DIMENSIONS: 2 3/8-inch diameter, 2 3/8" length.
NET WEIGHT: 2 ounces (less cable).

ORDERING INFORMATION

Gates G-500 dynamic lavalier microphone, with lavalier cord and clip...720-0197

STUDIO AND MICROPHONE CABLE

8412 Belden microphone cable. 2 conductor, stranded 20 AWG. Braided shield. Heavy rubber jacket..... 250-0036
 SH-2-20 General purpose audio cable. 2 conductor, stranded 20 AWG, with push-back braided shield. Not insulated.....253-0018
 8450 Belden miniature audio cable. 2 conductor, 22 AWG. Drain wire, foil shield, vinyl jacket..... 253-0054
 8451 Belden miniature audio cable. As above, except solid conductor... 253-0059

Professional Broadcast Microphones

MODEL DL42

Ideal for television, film, sports, or wherever a highly directional top quality microphone is required. Essentially cardioid unidirectional up to 500 Hz. Highly directional over balance of range. Working distance several times greater than conventional microphones. Excellent for boom use. Built-in shock mount. Made by Electro-Voice.

SPECIFICATIONS

TYPE: Dynamic, modified cardioid.
RESPONSE: Flat 30 to 10,000 Hz.
IMPEDANCE: 150 ohms nominal.
OUTPUT LEVEL: -50 dB.
FINISH: Cast aluminum with non-reflecting beige finish.
SIZE: 16 $\frac{1}{4}$ " long, 3 $\frac{3}{8}$ " maximum diameter.
WEIGHT: 1 pound 11 ounces.

ORDERING INFORMATION

Model DL42 microphone, complete with 1 $\frac{1}{2}$ -ft., 2 connector coil cord and permanent shock mount.....720-0285



MODEL RE51

Unique dynamic microphone which allows hands-free use for sports announcing. Lightweight unobtrusive mike assembly clips on eyeglass frame or special headband furnished. Small battery-powered transistor amplifier clips to user's belt, has on/off switch, cough button, battery test lamp, cable connector. Screwdriver slot output level adjustment.

SPECIFICATIONS

TYPE: Dynamic
RESPONSE: 80 to 10,000 Hz.
IMPEDANCE: Matches all low impedance inputs.
OUTPUT LEVEL: -56 dB (Max.)
FINISH: Non-reflecting Black.
SIZE: $\frac{1}{2}$ " Dio. and 1" Long. Two microphone tubes (3 $\frac{1}{2}$ " and 4 $\frac{1}{2}$ " long) furnished.
WEIGHT: Less than $\frac{1}{2}$ oz.

ORDERING INFORMATION

Model RE51 Microphone with two microphone tubes and battery-powered transistor amplifier.....720-0271

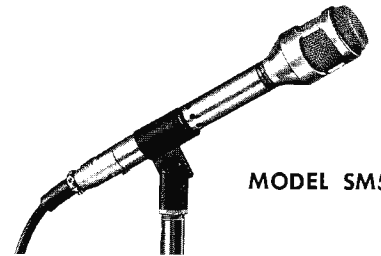

MODEL SM53

The frequency response of the SM53 is essentially flat across its broad frontal pickup area to the top end of the audible spectrum. Its response is natural, without strident peaks, without false coloration. Built-in low end roll-off filter switch. Soft, neutral glare-free finish is ideally suited for on-camera use.

SPECIFICATIONS

TYPE: Dynamic.
FREQUENCY RESPONSE: 70 to 16,000 Hz.
POLAR PATTERN: Cardioid (Unidirectional).
IMPEDANCE: 150 ohms to permit proper match with any input from 50 through 250 ohms.
OUTPUT LEVEL: -58.5 dB.
CABLE: 20-foot two-conductor shielded Broadcast type with Cannon XLR-3-11C connector attached on microphone end.
CONNECTOR: Cannon XLR-3-12 type in microphone.
FINISH: Matte metallic.
NET WEIGHT: (less cable) 8 ounces.

ORDERING INFORMATION

Model SM53 microphone.....720-0272

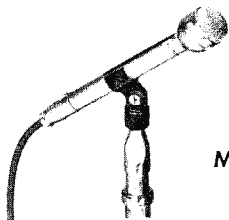

MODEL RE-15

ORDERING INFORMATION

Model RE-15 microphone, complete with 18-ft. cable, XLR3-11 connector, metal carrying case, and clamp 720-0240

The RE-15, by Electro-Voice, is a dynamic cardioid microphone created especially for the most exacting professional applications. The RE-15 features a degree of directional control so effective that response is independent of angular location of sound source. A super cardioid, this microphone provides the greatest possible rejection of unwanted sounds. An easily operated "bass tilt" switch corrects spectrum balance for boom use and other longer reach situations.

SPECIFICATIONS

FREQUENCY RESPONSE: 60-15,000 Hz.
POLAR PATTERN: Super Cardioid.
IMPEDANCE: 150 ohms.
OUTPUT LEVEL: -55 dB.
DIAPHRAGM: Acoustalloy.
DIMENSIONS: 6 $\frac{1}{16}$ " long, 1 $\frac{3}{8}$ " diam. ($\frac{3}{4}$ " shank dia.).
FINISH: Non-reflecting matte satin nickel.
NET WEIGHT: 8 oz. (not including cable).
CABLE: 18 feet, 2-conductor, shielded, broadcast type cable, synthetic rubber jacketed with Cannon XLR3-11 connector.
ACCESSORIES FURNISHED: Protective metal carrying case, Model 310 clamp.

The Shure SM58 is ideal for remote news, sports, interviews, or wherever the announcer or performer may need to work close to the microphone. Built-in spherical windscreen minimizes or eliminates explosive breath "pop." Wide response with slight presence rise for clean, bright and natural sound. Convenient size and weight for comfortable hand-held use. Slip-in stand adapter included.

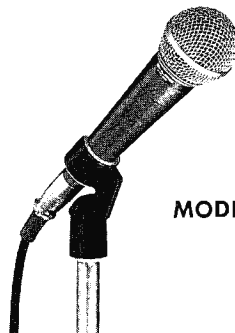

MODEL SM58

SPECIFICATIONS

FREQUENCY RESPONSE: 50-15,000 Hz.
POLAR PATTERN: Cardioid.
IMPEDANCE: Dual: 50 and 150 ohms.
OUTPUT LEVEL: -56 dB (0 dB = 1 milliwatt with 10 microbars).
DIMENSIONS AND WEIGHT: 6 $\frac{15}{32}$ " x 2" diam. (max.); 15 oz.

ORDERING INFORMATION

Model SM58, dynamic, cardioid, with built-in windscreen, cable, connector and stand adapter.....720-0228

HARRIS
 GATES DIVISION
 Harris-Intertype Corporation

Four Channel Solid Statesman Remote Amplifier



THE DYNAMOTE "70"

Broadcasting's finest remote amplifier—with such outstanding features as: completely transistorized circuits, designed to allow longer battery life; nine switchable inputs into four mixing channels; illuminated slide rule VU meter; built-in tone oscillator; PA feed; and amplified studio cue.

INPUT CIRCUITS: All mixing is high level. Four microphones feed four preamplifiers. All four preamplifier inputs are balanced and have input transformers as standard equipment. Five other input circuits are switch-selectable into the mixing system. These are: (1) tone oscillator, (2) dual turntable inputs, and (3) two high level inputs.

VERSATILE MIXING: Mixing channel 1 is for a microphone only; channel 2 accommodates a microphone or the built-in tone oscillator; channel 3, one microphone, one turntable or one high level input; and channel 4, one microphone, one turntable, or one high level input.

PROGRAM CUE: A front panel key switches the studio line into the Dynamote program amplifier and PA feed for ease in monitoring studio cues.

AMPLIFIERS: Four preamplifiers, each with transformer input, feed four mixing controls, which in turn feed the program amplifier. Distortion is 1% or less at +18 dBm output (10 dB overload) to the line (after 6 dB isolation pad).

FRONT PANEL CONTROLS: Four mixing channels are operated by specially-designed control knobs, created specifically for remote functions. Knobs are coordinated with the panel slope for positive-feel mixing. Other panel controls are (1) master gain, (2) PA gain control, (3) amplified cue selector control, (4) VU meter light control (the VU meter light operates from separate batteries), and (5) the slide rule VU meter.

REAR PANEL CONTROLS: All secondary switching is at the rear. The tone oscillator, dual turntable and dual high level inputs switch into mixing channels 2, 3 and 4. All input and output circuits connect to a recessed panel with standard XL-type receptacles for the microphones.

VU METER: The VU meter is of the slide rule type with full lateral scale area. Illumination is from two separate batteries, and the meter light may be turned on by pulling out on the PA feed control. Batteries will light the meter for 60 hours. A rear panel switch allows the meter to read either VU or battery condition.

PA FEED: The Dynamote "70" supplies an isolated output adjustable from the front panel to provide 0.5 volts into a 100,000 ohm unbalanced load.

HARRIS
GATES DIVISION
Harris Intertype Corporation

Four Channel Solid Statesman Remote Amplifier

TERMINAL FEATURES: Dual headphone jacks are provided for operator and director. The amplifier turns on when either headphone plug, or a dummy plug, is inserted. Microphone inputs are standard XL-type connectors. Jacks are provided for two turntables and two high level inputs, and terminals for telephone line and PA feed, and optional AC in-line power supply receptacle.

BATTERY AND AC POWER: Twelve "C" size standard 1½-volt dry batteries power the amplifier for 200 hours. As the amplifier design is based on full gain and output level at rated 1% distortion with as little as 12 volts, the useful battery life is greatly extended. The optional in-line power supply

operates about 2 volts above the batteries with diodes disabling the battery voltage. If power fails for any reason, batteries automatically take over without evidence in the program.

DYNAMOTE "70" PARALLELING: Any reasonable number of units may be paralleled for a large field broadcast. Rear panel jacks permit the feeding of additional Dynamotes directly to the mixer bus of the master Dynamote without losing a mixing channel on the master unit. For example, six Dynamotes will provide 24 microphone inputs—yet require only about 76 inches of width, or about 38 inches if two units are stacked on top of one another.



Rear view, Dynamote "70".

SPECIFICATIONS

OPERATING MODE: Single channel monaural.

MIXING CHANNELS: Total four; three switchable for other functions.

INPUT CIRCUITS: Channel 1, microphone input; Channel 2, microphone and tone oscillator; Channel 3, microphone, turntable and high level input; Channel 4, microphone, turntable and high level input. Input levels: Microphones -60 dBm, high level 600 ohm circuits rated -15 dBm to +8 dBm. Turntable inputs have RIAA equalization and accept standard VR-type phono cartridges without further preamplification.

OUTPUT CIRCUITS: 1 program line, 1 isolated PA feed, 1 mixer multiple output, 2 headphone monitoring jacks.

SOURCE IMPEDANCES: Microphones—30/50 and 150/250 ohms, balanced or unbalanced, with input transformers on all channels. High Level—600 ohms, unbalanced. (-15 dBm to +8 dBm input level.) Turntables—6200 ohms for VR type pickup cartridge equalization. Mixer Multiple Input—600,000 ohms.

INPUT IMPEDANCE: Preamplifiers, 1500 ohms or higher, 30-15,000 Hz.

LOAD IMPEDANCES: Program Output—600/150 ohms, balanced or unbalanced, (factory connected for 600 ohms). PA Feed—100,000 ohms unbalanced. Amplifier Paralleling—600,000 ohms bridging.

OUTPUT IMPEDANCE: Program Amplifier, 490 ohms nominal.

GAIN: Microphone input to line output, 97 dB \pm 2 dB.

RESPONSE: \pm 1½ dB, 25 to 16,000 Hz.

DISTORTION: 1.0% maximum, 30 to 15,000 Hz @ +18 dBm output (after 6 dB isolation pad).

NOISE: 62 dB or better below +8 dBm output with -60 dBm input. (Relative input noise -122 dBm.)

BATTERY COMPLEMENT: 12 Size "C" 1½ volt cells for amplifier. 2 Size "D" 1½ volt cells for VU light.

BATTERY LIFE: Approximately 200 hours for amplifier pack, and 60 hours for meter light.

EXTERNAL POWER: Four terminal plug on rear accepts optional 994-6435 in-line power pack for 117 volt AC operation.

CABINET DATA: Size: 12¾" wide, 4" high, 12½" deep. Finish: Charcoal gray vinyl with satin chrome trim accents. Weight: 12¼ pounds, including batteries.

SHIPPING DATA: Packed Weight: Domestic, 16 lbs.; Export, 35 lbs, Cubage, 2 cubic feet.

ORDERING INFORMATION

| | |
|---|------------------------------------|
| Dynamote "70" 4-channel remote amplifier, complete but less male microphone connectors and batteries..... | 994-6434 |
| Microphone plugs, male (four required) | 610-0182 |
| Battery complement for Dynamote "70" | 12 ea. 660-0020 and 2 ea. 660-0021 |
| Vinyl cover with accessory pocket..... | 725-0128 |
| In-Line power supply for 117 volt operation..... | 994-6435 |

HARRIS
GATES DIVISION
Harris-Intertype Corporation

All Purpose Remote Amplifier

MODEL M-6600

A compact, lightweight remote amplifier, the M-6600 Solid-Statesman provides fine remote performance, and makes an ideal all-purpose amplifier. Battery operated and 100% self-contained, it may be quickly installed to fill many studio requirements. Use it to temporarily replace a faulty program amplifier, as a preamplifier for cartridge or reel tape recorders, or as one of several feeder amplifiers for the extravaganza type of pickup. These are just a few of the possibilities.

The housing is all aluminum, and ribbed for added strength, providing complete electrical isolation for the floating printed board internal assembly. The gain control and combined on-off switch are on one end of the amplifier, and the microphone receptacle, phone jack, and line terminals are on the opposite end. The output transformer is "T" pad isolated and wired for 600 ohms, but internally changeable to 150 ohms where desired. For the installation requiring a number of widely spaced microphones, the use of the M-6600 amplifier permits connection to the central control point with unshielded telephone type wire, and individual gain adjustment for each microphone.

Two 8.4 volt standard mercury batteries, available nationwide, provide about 50 hours of service. Total weight is less than 2½ pounds with batteries and microphone connector.



SPECIFICATIONS

GAIN: 82 dB \pm 3 dB at 150/250 ohms source impedance. 77 dB \pm 3 dB at 50 ohms source impedance.

NOTE: With gain control setting reduced about 14 dB, this permits 68 dB operating gain for correct output level.

RESPONSE: 30-15,000 Hz \pm 2 dB.

DISTORTION: 1% maximum at +18 dBm, 30-15,000 Hz.

NOISE: -122 dBm relative input noise, 30-15,000 Hz.

BATTERIES: Two 8.4 volt mercury Eveready ET146X or Burgess H146X. Expected life at maximum amplifier performance, 50 hours under average programming.

SOURCE IMPEDANCE: 30/50 or 150/250 ohms unbalanced.

LOAD IMPEDANCE: 600/150 ohms balanced, wired for 600 ohms.

SIZE AND FINISH: 8¾" long, 2½" wide, 3" high. Finish: Natural aluminum.

WEIGHT: Net, with male connector, 2 lbs. Shipping weight 8 lbs.

ORDERING INFORMATION

Amplifier (less batteries).....994-6600
Battery (2 required).....660-0022

Proof Of Performance Equipment

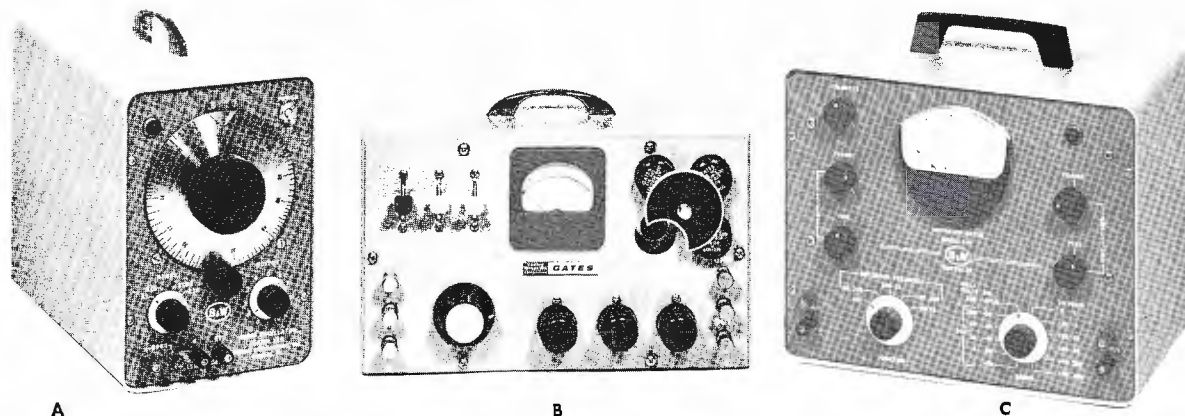

SA-131

A proof of performance package that assures accurate results and complete equipment to check audio and radio frequency performance. There are three basic units, plus two optional units: (A) type 210 audio oscillator, (B) M-3625 gain

set, (C) type 410 distortion meter, and optional RF pickup coil and diode rectifier for AM transmitter measurements. For FM transmitters the signal can be obtained directly from the modulation monitor for proof of performance tests.

AUDIO OSCILLATOR

Fig. A. An excellent source for audio signals from 10 to 100,000 Hz, the type 210 oscillator consists of an RC audio circuit followed by an amplifier of extremely low distortion. Response over the entire frequency range is ± 1 dB with wave form distortion of less than 0.2% at a 5 volt output. Calibration over the 10 to 100,000 Hz range is $\pm 2\%$. Output impedances are 600 ohms balanced, 600 ohms unbalanced and 150 ohms unbalanced. Maximum output is 10 volts into a 600 ohm load. The unit is 6" wide, 9" high and 12" deep, including a self-contained power supply. Weight is 11 pounds.

DISTORTION METER

Fig. C. The type 410 distortion meter measures audio distortion, noise level, audio gain or loss in decibels and AC voltages. This unit measures distortion on fundamental frequencies from 20 to 20,000 Hz and indicates harmonics up to 100 kHz. Distortion levels as low as 0.1% can be measured, and distortion measurements may be made on signal levels from 0.1 volt to 30 volts. For noise and response measurements the instrument is calibrated in 1 dB steps from 0 to -15 dB. The attenuator provides additional ranges from -60 dB to $+50$ dB in 10 dB steps. The unit is 11½" wide and 9" high. Weight is 11 pounds.

GAIN SET

Fig. B. The M-3625 gain measuring set consists of a VU meter with switching to accommodate all usable ranges for measuring purposes. The attenuation circuit includes a 10 step 2 dB per step variable attenuator of the balanced ladder type, and fixed plug-in pads which may be used in any number from 1 to 3. Pads are used for attenuation and impedance matching. Two are supplied, providing 40 dB attenuation at 600/600 ohms and one with 20 dB at 600/250 ohms, all balanced H. The gain set is completely shielded.

PICKUP COIL AND RECTIFIER

Optional accessory for AM transmitters only. Designed for use with the type 410 distortion meter, the pickup coil is supplied ready to couple to the tank circuit of an AM transmitter. It is supplied with 15 feet of coaxial cable that connects the coil to the diode rectifier unit. Complete RF filtering guarantees a pure audio output signal free from RF disturbances. 4" long, 2" wide, and 1¼" high.

SPECIFICATIONS

INPUT IMPEDANCE: 600 ohms, balanced.
OUTPUT IMPEDANCE: Variable 30 to 600 ohms.
OUTPUT LEVEL: Variable from +21 dBm to -136 dBm.
RESPONSE: ± 0.5 dB, 30-15,000 Hz.
DISTORTION AND NOISE: Negligible.
SIZE: 12¾" wide, 8¾" high, 4" deep.

ORDERING INFORMATION

SA-131 proof of performance package, consists of one each
 Model 210, M-3625, and Model 410.....994-3663
 Model 210 audio oscillator.....700-0045
 Model 3625 gain set.....994-3625
 Model 410 distortion meter.....700-0040
 Pickup coil and rectifier (optional for AM only).....994-3626

HARRIS
 GATES DIVISION
 Harris-Intertype Corporation

Modular Audio Equipment Cabinets



"Combo" desk system includes two dual pedestals (M-6449) and table top section (M-6450). Electronic equipment shown to demonstrate a typical installation.

MODERN, FLEXIBLE STYLING

The fullest flexibility of custom cabinetry, with the economy of standard production units, combine to offer broadcasters a totally modern concept in control room desks. Beautifully styled in walnut grain and textured Formica, these desks have the appearance of fine furniture, and the strength and durability to last for years.

"Building blocks" of single-width pedestal, double pedestal, uniform table top sections, plus two decorator leg sections can be assembled in dozens of configurations. Pedestal base sections have removable grill front and cabinet-finish rear doors that remove to reveal standard 19" rack mounting rails.

Cartridge tape equipment, leveling amplifiers, jack fields, etc., may be mounted for operator convenience. The interior of each cabinet is also finished, so cabinets may be used for disc or tape storage by removing the panels entirely.

When used with turntables, the pedestals conform to NAB standards for transcription cabinets. For console wiring, a cable trough is concealed under the table top section near the rear. The "horseshoe" or "combo" configuration shown above provides an attractive and functional control center in keeping with the aesthetic beauty of modern communications equipment.

ORDERING INFORMATION

Combo desk system, complete with 2 double pedestals and top section. For specifications on individual items that make up the system, see Page 159. Console, microphone and turntables pictured above are not included.-----994-6454

HARRIS
GATES DIVISION
Harris-Intertype Corporation

Modular Audio Equipment Cabinets

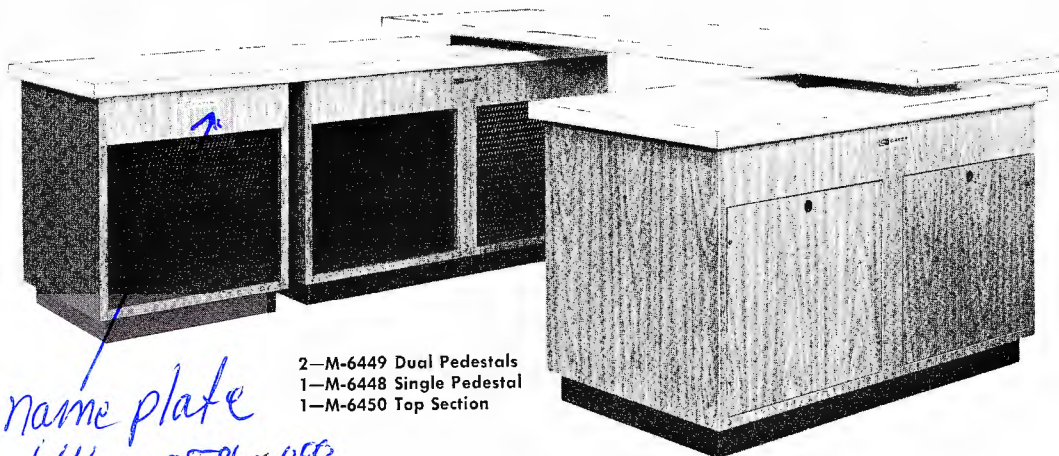

*name plate
646-0586-000*

2—M-6449 Dual Pedestals
1—M-6448 Single Pedestal
1—M-6450 Top Section

WIDE VARIETY OF COMBINATIONS

By choosing combinations of modular desk components, large and complex control room arrangements are made possible. Shown above is a desk system with one extended "wing". This could easily accommodate an extra turntable, two-way radio, or other miscellaneous equipment. Or, the top can be left bare for counter space, with the grilled area used for mounting any rack-mounted equipment such as reel-to-reel recorders, utility amplifiers, etc.

Development of this tasteful equipment cabinetry encompassed human engineering studies, styling analysis and comparison with established mechanical specifications where available. For instance, the turntable pedestals conform to the height standards of the NAB, and are four inches lower than the desk top section for comfortable operation. Color and texture of the cabinets blend easily with any studio color scheme and provide a pleasant setting in keeping with the trend of modern office furniture.

Many interesting variations in control room desks allow tailor-made arrangements for specific station operations. The single pedestal, serving as a right hand desk base, may also provide rack space for Criterion tape cartridge equipment, reel-to-reel recorder or storage. All pedestals have sturdy black steel bases with leveling feet. Expanded metal grill or finished access door removes to reveal 16" of standard 19" rack space. Double and single leg assemblies are of sturdy 1" satin chrome square steel tubing with leveling feet. Both 12" and 16" Gates turntables and all types of speech input consoles may be used with these cabinets.

For ordering information and specifications on pedestals, top and leg assemblies see Page 159.

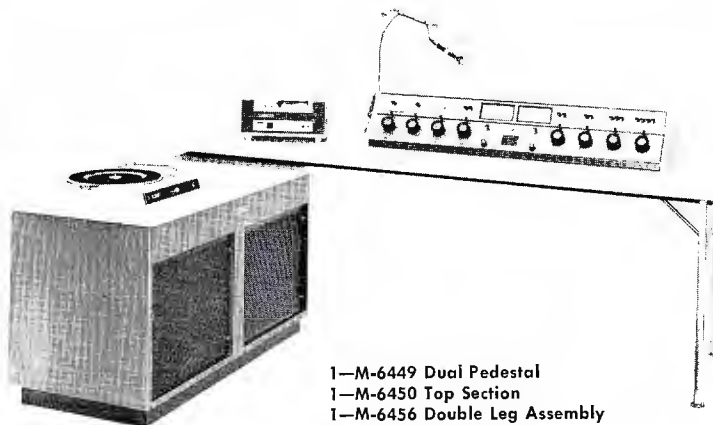

1—M-6449 Dual Pedestal
1—M-6450 Top Section
1—M-6456 Double Leg Assembly
1—M-6455 Single Leg Assembly

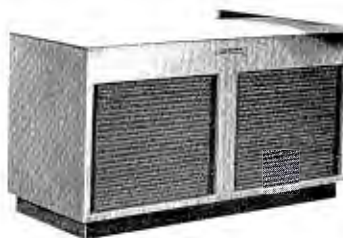

1—M-6449 Dual Pedestal
1—M-6448 Single Pedestal
1—M-6450 Top Section

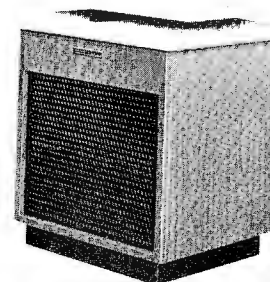

Modular Audio Equipment Cabinets

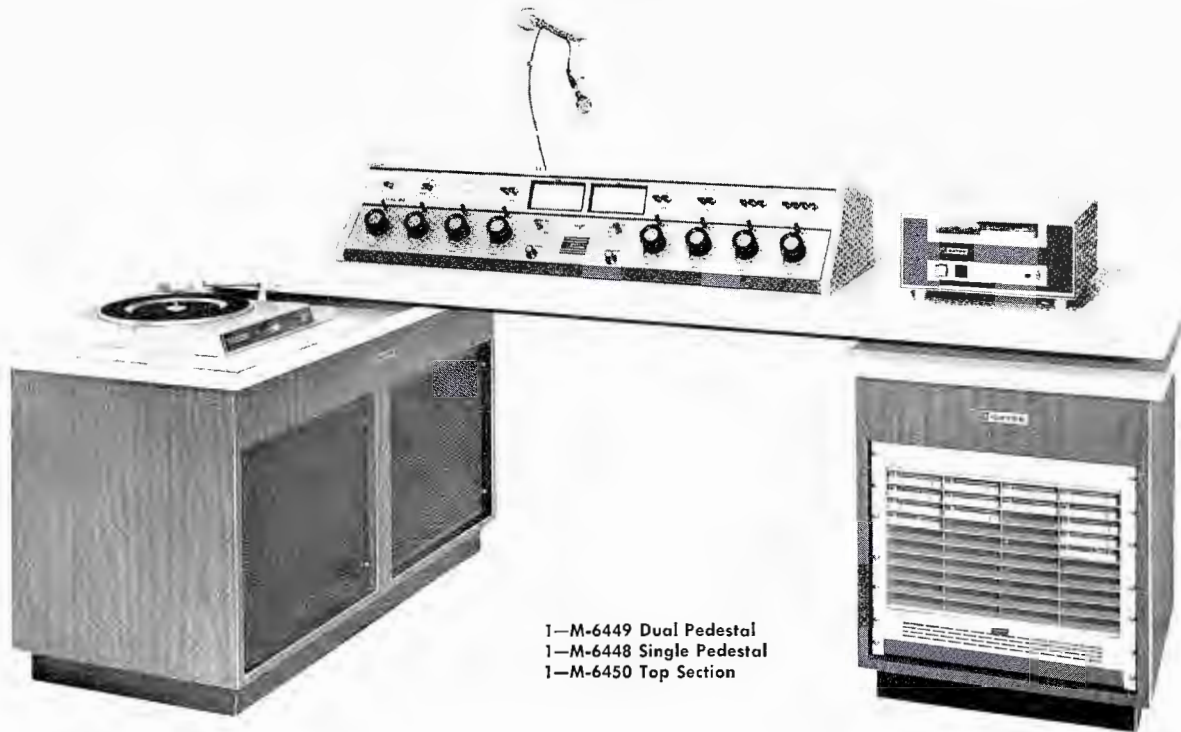

1—M-6449 Dual Pedestal
 1—M-6448 Single Pedestal
 1—M-6450 Top Section

TYPICAL SELECTIONS

Gates modular equipment cabinetry shown here serves to suggest how a modular system may be assembled to fit specific studio requirements. Note the convenient storage area provided by the double and single turntable pedestals.

In addition to modular studio furniture Gates also offers the world's most complete selection of standard production audio equipment. A Gates District Manager will be happy to discuss

particular programming requirements with you, and recommend a complete control room package suited to your individual needs.

For ordering information and specifications on audio equipment cabinetry items, see Page 159. Console, turntables, microphone, and cartridge tape equipment shown here are not included with the cabinet equipment.



M-6449 Double Turntable Pedestal.



M-6448 Single Turntable Pedestal.

Modular Audio Equipment Cabinets

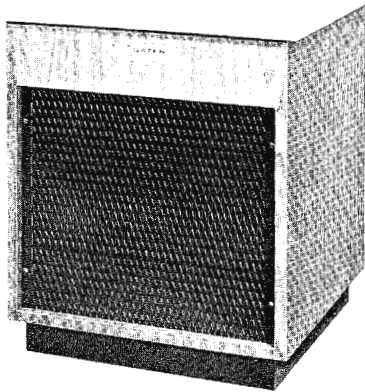

SINGLE PEDESTAL, M-6448

Mounts one 12" or 16" turntable. 16" rack mount space front with expanded metal grill. 16" rack mount space rear with wood-grain door. Constructed of 3/4" solid flake board, laminated with Formica. Furnished with 2 1/2" steel base and floor levelers.

FINISH: Walnut formica. Top in champagne formica and trim painted satin black.

SIZE: Height 26", width 23", depth 23".

WEIGHT: Net, 60 lbs.; packed 70 lbs.

CUBAGE: 12 cubic feet.

ORDER NUMBER 994-6448

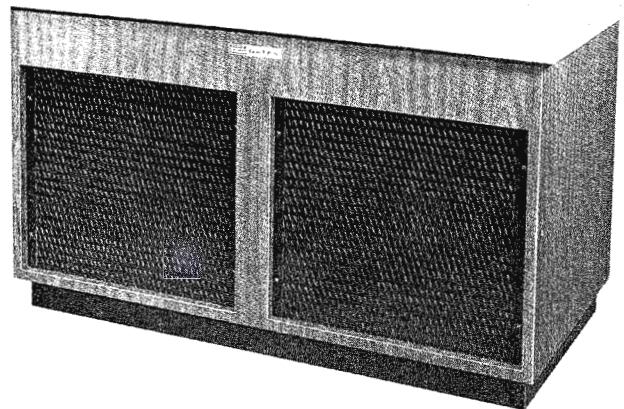

DOUBLE PEDESTAL, M-6449

Mounts two 12" or 16" turntables. Total 64" of 19" rack mount space available front and back, both sections. 3/4" flake board with Formica laminate. 2 1/2" steel base and floor levelers.

FINISH: Walnut formica. Top in champagne formica and trim painted satin black.

SIZE: Height 26", width 45", depth 23".

WEIGHT: Net, 108 lbs.; packed, 140 lbs.

CUBAGE: 18 cubic feet.

ORDER NUMBER 994-6449

NOTE: Cabinets normally supplied less cut-outs for turntables. If cut-outs desired, an added cost is involved.

METAL GRILL REPLACEMENTS

Where the expanded metal grill used on cabinet fronts, such as the M-6448 or M-6449, is to be eliminated in part for rack mounted items, other size grills are listed below to fill the unused portion. Example: full grill is 16" high. If 5 1/4" rack space used, order 994-6453-002 to fill remaining space.

Grill 10 1/2" high 994-6453-002

Grill 5 1/4" high 994-6453-003

Grill 3 1/2" high 994-6453-004

UNIFORM TABLE TOP SECTION

Complete with wiring trough, and angle brackets for assembly with pedestals or legs. When assembled, desk surface is 29" from floor. (Not illustrated.)

FINISH: Neutral champagne formica.

SIZE: Length 84", depth 29", thickness 1 3/16". (Other lengths on special order.)

WEIGHT: Net, 55 lbs.; packed, 70 lbs.

CUBAGE: 7.5 cubic feet.

ORDER NUMBER 994-6450

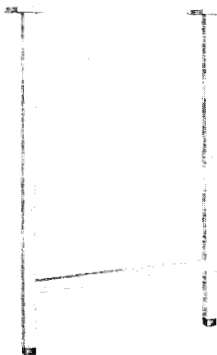

DOUBLE LEG, M-6456

For supporting top section. Square 1" steel welded construction with crossbrace. Complete with mounting flanges and floor levelers.

FINISH: Satin chrome steel.

SIZE: 1" x 1" x 28". Over-all width 21".

WEIGHT: Packed, 10 lbs.

CUBAGE: 2 cubic feet.

ORDER NUMBER 994-6456



SINGLE LEG, M-6455

Mounts beneath desk top section. Square 1" steel tubing with mounting flange and floor leveler.

FINISH: Satin chrome steel.

SIZE: 1" x 1" x 28".

WEIGHT: Packed, 5 lbs.

CUBAGE: 1 cubic foot.

ORDER NUMBER 994-6455

HARRIS
GATES DIVISION
Harris-InterType Corporation

SPECIFICATIONS

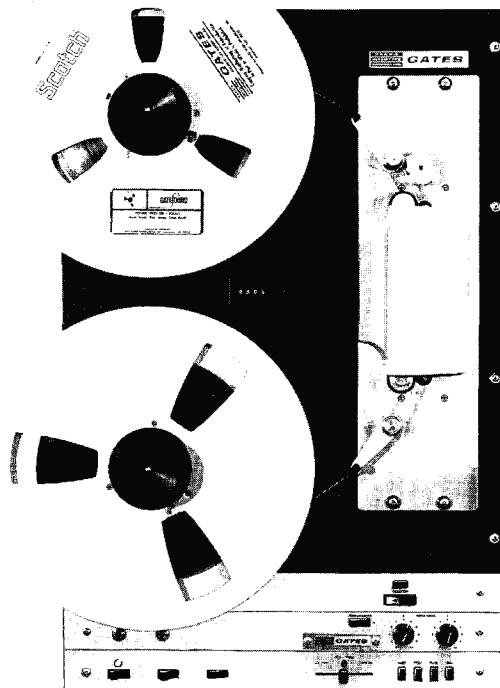

GATES' GBR-10/GBR-15 SERIES

The GBR Series recorder/reproducers have been designed specifically for the broadcaster.

The GBR-10 operates with reel sizes from 5 to 10½ inches. The GBR-15 is designed for reels of up to 15 inches for long-duration record or playback. GBR Series machines are available in either record/reproduce or playback-only configurations.

In the bidirectional configuration, Gates' GBR Series recorders are totally symmetrical machines. Separate capstan drive motors are used, one for each direction, allowing improved production and providing a full program automation capability. Tape is always pulled across the heads, thus improving head-to-tape contact.

Automatic reversing with the use of alternate tracks in each direction eliminates turning reels over and recueing. A new direct-drive system controlled by an electronic servo uses specially designed DC motors. This system eliminates several electrical and mechanical components that can affect tape speed stability and increase flutter. Tape speed is maintained regardless of voltage, frequency, and phase fluctuations from the input power line.

TAPE FORMAT: Full, half or quarter tracks on ¼-inch-wide tape, 1-mil or 1½-mil base. Specifications are based on Ampex recommended professional quality magnetic tape on 10½-inch aluminum reels.

TAPE SPEEDS: Standard, selectable pairs from 15/16, 1⅞, 3¼, or 7½ ips for either unidirectional or bidirectional operation.

REEL SIZE: 5 inches to 10½ inches in diameter for Model GBR-10. 5 inches to 15 inches in diameter for Model GBR-15.

FREQUENCY RESPONSE: 15 ips: 40 to 18,000 Hz, ±2 dB; 7½ ips: 40 to 15,000 Hz, ±2 dB; 3¼ ips: 40 to 10,000 Hz, ±2 dB.

CROSSTALK REJECTION: 60 dB or better at 1000 Hz (2-track head stacks).

BIAS OSCILLATOR: Nominal bias/erase frequency: 100 kHz.

FLUTTER AND WOW: 15 ips: 0.1%; 7½ ips: 0.15%; 3¼ ips: 0.18%; 1⅞ ips: 0.25%; 15/16 ips: 0.4%.

SIGNAL-TO-NOISE RATIO:

| Tape Speed | Full Track | Half Track | Quarter Track |
|------------|------------|------------|---------------|
| 15 ips | 66 dB | 63 dB | 57 dB |
| 7½ ips | 66 dB | 63 dB | 57 dB |
| 3¼ ips | 63 dB | 58 dB | 51 dB |
| 1⅞ ips | | 45 dB | 42 dB |
| 15/16 ips | | 40 dB | 40 dB |

(Peak record level to unweighted noise. Includes bias, erase, and playback amplifier noise.)

INPUT: 100,000 ohms unbalanced. Accepts line level from -17 dBm for recommended operating level.

OUTPUT: +4 dBm, balanced. +24 dBm clipping level. Amplifier total harmonic distortion at +20 dBm is less than 0.1%.

EQUALIZATION: 90 to 200 microseconds at 15/16, 1⅞, and 3¼ ips. NAB equalization for 7½ and 15 ips tape speeds.

FAST SPEED: Fast speed for rewind or search functions manually adjustable. Minimum rewind time: approximately 90 seconds for 2400-foot NAB reel. Approximately 3 minutes for 5000-foot, 14-inch reel.

START TIME: Operating speed obtained in 0.25 second or less; 3 seconds to normal flutter specification.

STOP TIME: At 15 ips (15-in. reel) tape moves 3 inches.

TAPE SPEED ACCURACY: Within ±0.08% from beginning to end of reel. With internal speed control, tape speed unaffected by line voltage or frequency fluctuations.

REFERENCE OSCILLATOR STABILITY: Bridge Oscillator: ±0.05%, 0° to 65°C. Crystal Oscillator: ±0.01%, -10° to 75°C.

POWER REQUIREMENTS: 105 to 125 VAC, 50/60 Hz.

POWER CONSUMPTION: 2.2 amps at 115 VAC.

SIZE AND WEIGHT: GBR-10, Tape Transport (bidirectional): 14 inches high x 19 inches wide; 42 pounds. GBR-15, Tape Transport (bidirectional): 24½ inches high x 19 inches wide; 50 pounds. Electronics and Control Units: 1¾ inches high x 19 inches wide (each unit); 4-6 pounds.

ORDERING INFORMATION AVAILABLE ON REQUEST

Professional Tape Recorders

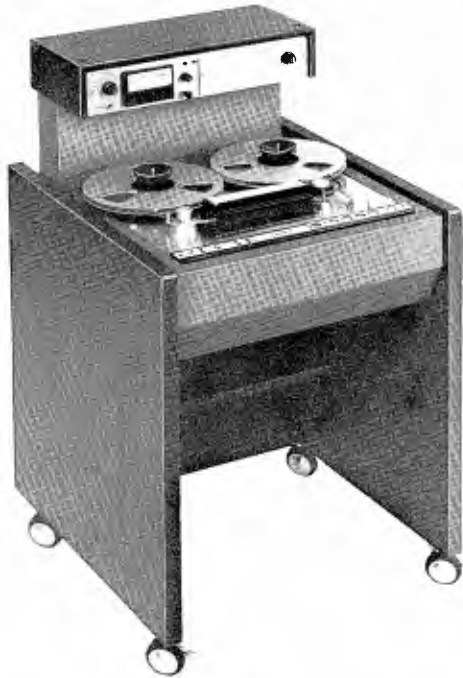

AMPEX 440-B TAPE SYSTEM

One of the finest commercial tape recorders available anywhere. The all-transistor Ampex 440-B series sets the highest standards in professional recording performance. Uncompromising quality characteristics, both electronic and mechanical, result in superiority of performance and long, trouble-free operation. Transport control buttons are recessed so that they cannot be accidentally pressed; all can be remote controlled. The 440-B is the professional broadcast version of Ampex recorders used by leading Hollywood recording companies. Rack, Portable, or Console mount, monophonic or stereophonic versions, dual speed: 7½-15, or 3¾-7½ ips.

Rigid die-cast frame provides absolutely flat mounting of all mechanical components for precise tape alignment. The AG-440-B has been designed for easy, rapid maintenance, and minimum downtime. Modular design with front panel plug-in circuit boards permits fast servicing and replacement. Individual head stacks can be replaced with a single screw and plug-in connector. Transport motors, guides, and major components can be quickly removed and replaced in exact alignment because of the precision milled transport casting. All relays plug-in and are fully interchangeable.

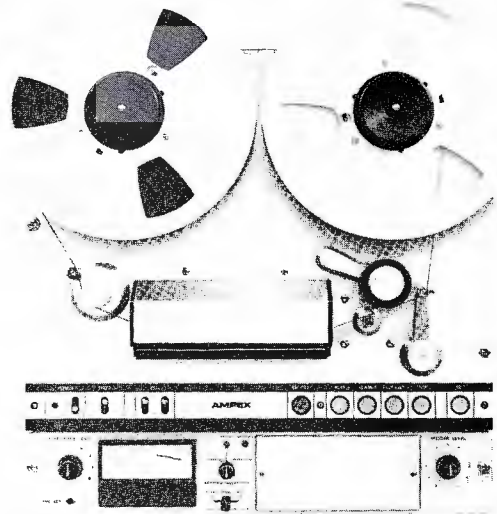

SPECIFICATIONS

TAPE SPEEDS: 7½ and 15 ips, or 3¾ and 7½ ips.
SIGNAL TO NOISE RATIO: 15 ips full track 68 dB, 2 track 60 dB; 7½ ips full track 68 dB, 2 track 60 dB; 3¾ ips full track 63 dB, 2 track 56 dB.
FREQUENCY RESPONSE (OVER-ALL): 15 ips ±2 dB, 30 to 18,000 Hz; 7½ ips ±2 dB, 40 to 10,000 Hz; 3¾ ips +2 to -4 dB, 30 to 15,000 Hz; 3¾ ips ±2 dB, 50 to 7500 Hz.
FLUTTER: 15 ips below 0.08% rms; 7½ ips below 0.10% rms; 3¾ ips below 0.15% rms.
PLAYBACK OUTPUT: +8 dBm into 600 ohms—restrappable for +4 dBm output balanced or unbalanced. Maximum of +29 dBm before clipping.
RECORD INPUT: 100 K ohm unbalanced bridging with dummy plug or 20 K ohm bridging with plug-in transformer -17 dBm to produce recommended operating level.
START/STOP: Start, tape at full speed in less than 1/10 second. Stop, tape travel 2" or less after depressing stop button.
PLAYBACK TIMING ACCURACY: ±0.2% (±3.6 seconds in 30 minutes).
EQUALIZATION: NAB standard, CCIR on special order.
POWER REQUIREMENTS: 117 volts, 50 or 60 Hz @ 2.5 amp. for 2 channel.
DIMENSIONS: Transport, 19" wide x 15¾" high. Electronics, 19" wide x 3½" high.
MOUNTING CONFIGURATIONS: Portable, Console, or Unmounted.
REEL SIZE: Standard up to 10½ inch, adjustable up to 11½" reels.
 Complete specification on request.

ORDERING INFORMATION

| | |
|--|----------|
| AG-440B-1 (4010131-01) full track, unmounted, 7.5/15 IPS, 60 Hz | 730-1164 |
| AG-440B-1 (4010131-03) as above, console mounted | 730-1165 |
| AG-440B-1 (4010131-09) half track, console mounted, 7.5/15 IPS, 60 Hz | 730-1168 |
| AG-440B-2 (4010132-01) two track stereo, unmounted, 7.5/15 IPS, 60 Hz | 730-1170 |
| AG-440B-2 (4010132-03) as above, console mounted | 730-1171 |
| AG-440B-2 (4010132-13) two track stereo, plus quarter track playback, unmounted, 7.5/15 IPS, 60 Hz | 730-1172 |
| AG-440B-2 (4010132-15) as above, console mounted | 730-1173 |
| AG-440B-2 (4010132-07) two track stereo, unmounted, 3.75/7.5 IPS, 60 Hz | 730-1174 |
| AG-440B-2 (4010132-09) as above, console mounted | 730-1175 |
| AG-445B-1 (4010141-19) half track, unmounted, 3.75/7.5 IPS, 60 Hz | 730-1181 |

HARRIS
 GATES DIVISION
 Harris-Intertype Corporation

Professional Tape Recorders



AMPEX AG-500 SERIES

The AG-500-1 is a versatile one-channel recorder with full or half-track heads. This portable single channel solid state unit has input controls that can mix two incoming line signals. Use of mike pre-amp accessory converts line inputs to accept low impedance microphones. Narration over music, music/voice mixing or special sound-on-sound capabilities are possible. Recorder will feed 600 ohm remote broadcast phone line.

SPECIFICATIONS

- SPEEDS:** 7½ and 15 ips, or 3¾ and 7½ ips (AG-500-4 for 4 track stereo, 3¾ and 7½ ips only).
- FREQUENCY RESPONSE (OVER-ALL):** 15 ips ±2 dB, 30 to 18,000 Hz; 7½ ips +2 dB -4 dB, 30 to 15,000 Hz; 3¾ ips +2 dB -4 dB, 40 to 8,000 Hz.
- SIGNAL TO NOISE RATIO:** 7½ and 15 ips, full track (60 Hz) 60 dB (50 Hz) 57 dB, half or two track 55 dB. 3¾ ips full track 55 dB, half and quarter track 50 dB.
- WOW AND FLUTTER:** 15 ips less than 0.15% rms, 7½ ips less than 0.18% rms, 3¾ ips 0.25% rms.
- TIMING ACCURACY:** ±0.25%, 7½ and 15 ips; ±0.40%, 3¾ ips.
- OUTPUT:** +4 dBm into 600 ohm balanced load.
- POWER REQUIRED:** 117 Volts, 60 Hz, 1.50 Amp. 230 Volts, 50 Hz, 0.75 Amp.
- RACK SPACE:** Transport, 8¾" H x 19" W x 6" D. Electronics, 3½" H x 19" W x 6" D.
- WEIGHT:** 1 channel portable 42 lbs., 2 channel portable 52 lbs.

ORDERING INFORMATION

- AG-500-1 Single channel Full track, rack mount, 7.5/15 ips, 60 Hz..... 730-0963
- AG-500-1 Same as above except half-track..... 730-0964
- AG-500-1 Single channel, full track, rack mount, 3.75/7.5 ips, 60 Hz..... 730-0965
- AG-500-1 Same as above except half-track..... 730-0966
- AG-500-2 Stereo, 2 track, rack mount, 7.5/15 ips, 60 Hz..... 730-0967
- AG-500-2 Stereo as above except 3.75/7.5 ips..... 730-0968
- Portable Case for AG-500 single channel..... 730-0970
- Portable Case for AG-500 two channel..... 730-0971



AMPEX AG-600B

The AG-600B series is designed for broadcast, where compact lightweight professional quality recording equipment is needed or where budgets are limited.

SPECIFICATIONS

- FREQUENCY RESPONSE:** 7½ ips: ±2 dB from 60 Hz to 10 kHz; +2.4 dB from 40 Hz to 15 kHz. 3¾ ips: ±2 dB from 50 Hz to 7 kHz; +2.4 dB from 40 Hz to 8 kHz.
- SIGNAL TO NOISE:** 7½ ips: Full track 57 dB; Half track 55 dB; 3¾ ips: Full track 52 dB; Half track 50 dB.
- CROSSTALK REJECTION:** Better than 40 dB mid-frequency.
- FLUTTER AND WOW:** (Measured by ASA Standards) 7½ ips less than 0.17%; 3¾ ips less than 0.25%.
- TIMING ACCURACY:** 7½ ips ±0.2% (±3.6 seconds in 30 minutes). 3¾ ips ±0.4% (±7.2 seconds in 30 minutes).
- FAST FORWARD OR REWIND TIME:** 90 seconds for full 1200 foot reel . . . 7½ ips, 180 seconds . . . 3¾ ips.
- SPEEDS:** Dual speed, 3¾ and 7½ ips.
- REEL SIZE:** 5" and 7".
- EQUALIZATION:** 117 volt, 60 Hz models: 3¾ ips, 120 microsecond. 7½ ips, NAB. 115/230 volt, 50 Hz models: 3¾ ips, 120 or 200 microsecond. 7½ ips, NAB or CCIR.
- POWER REQUIREMENTS:** For 117 volt operation 0.5 amperes. For 230 volt operation 0.3 amperes.
- WEIGHT:** Single channel: 28 lbs. portable. Dual channel 42 lbs. portable.

ORDERING INFORMATION

- AG-600-B NAB equalization, full track, unmounted, 60 Hz, 117 Volt..... 730-1018
- AG-600-B, as above in portable case..... 730-1019
- AG-600-B, NAB equalization, half track, unmounted, 60 Hz, 117 Volt..... 730-1020
- AG-600-B, as above in portable case..... 730-1021
- AG-600-B, two-channel, two track, one-half track stereo, NAB equalization, unmounted, 60 Hz, 117 volts..... 730-1022
- AG-600-B, same as above in portable case..... 730-1023
- AG-600-B, two channel, four track, one-quarter track stereo, NAB equalization, unmounted, 60 Hz, 117 volt..... 730-1026
- AG-600-B, same as above in portable case..... 730-1027
- AA-620 Portable speaker-amplifier for AG-600 and AG-500 series. 10" woofer, 3½" tweeter, 20 watt solid state amplifier in enclosure..... 730-1030

Professional Tape Recorders



MODEL 270

SCULLY PRECISION TAPE EQUIPMENT

The portable Scully 270 Reproducer is intended for broadcasters, background music operators or any application where long life, reliability and exacting performance specifications in tape handling equipment are essential. The companion model 280 complete record/reproduce system has the same fine features plus quality all-transistor recording amplifier.

SPECIFICATIONS

Model 270

TAPE SPEEDS: 3¾ ips-7½ ips or 7½-15 ips.
TAPE SIZE: ¼".
HEAD CONFIGURATION: Monophonic half or full track; stereo 2, 3, or 4 channel.
REEL SIZE: Up to 14".
REEL HUBS: NAB, CCIR.
STARTING TIME: 1/10th second.
STOPPING TIME: 1/5th second.
FAST WIND TIME: 4800 foot reel—105 seconds.
PLAYING TIME: 14" reel, 4800 feet 1½ mil tape @ 3¾ ips—8 hrs. 7½ ips—4 hrs; 14" reel, 9600 feet ½ mil tape @ 3¾ ips—16 hours; @ 7½ ips—8 hours.
FREQUENCY RESPONSE: ±2 dB 50-7500 Hz @ 3¾ ips. +2 —3 dB 50-15,000 Hz @ 7½ ips. ±2 dB 35-15,000 Hz @ 15 ips.
FLUTTER AND WOW: 0.2% RMS @ 3¾ ips. 0.1% RMS @ 7½ ips. .08% RMS @ 15 ips.
SIGNAL TO NOISE RATIO (FULL TRACK): —60 dB @ 7½ and 15 ips.
TIMING ACCURACY: Better than 99.8% (30 minute reel).
AMPLIFIER: Solid State, plug-in.
AMPLIFIER EQUALIZATION: Front panel switch.
AMPLIFIER OUTPUT: +18 dBm 600 ohms balanced line.
AMPLIFIER DISTORTION: Less than 0.5% total HD at +18 dBm.
OPERATING CONTROLS: Play, fast, Direction Change, Stop, Speed Selector, Equalization.
REMOTE FEATURES: All controls except motor speed change.
REVERSING: Foil using low current transistor switching, with mechanical memory.
MOTORS: Two torque and one hysteresis synchronous speed reversible capstan motor.
POWER REQUIREMENTS: 117 V, 50/60 Hz, 275 watts.

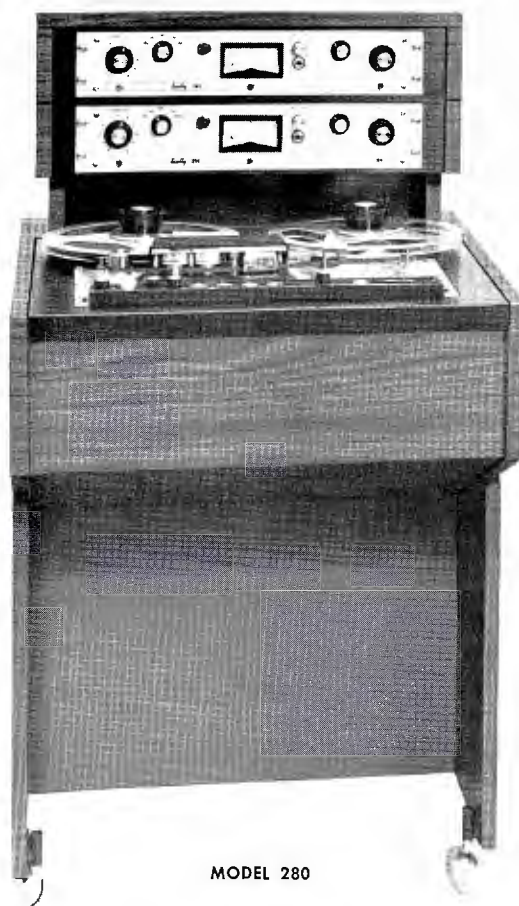

MODEL 280

CONTROL SYSTEM: All relays and solenoids 24 volts DC; plug-in relays.
CHASSIS FRAME: ¾" cast aluminum 2" depth.
MAIN PANEL: Precision aluminum plate.
FACE PLATE: Easily removable, permitting continuous operation.
BRAKING SYSTEM: Disc Type.
TAPE TENSION: Continuous adjustable electrical controls system.
WEIGHT: 79 lbs.
SHIPPING WEIGHT: 90 lbs.
SIZE: 19" x 24½" x 8¾".

ORDERING INFORMATION

Model 270-1 Rack mount reproducer, ½ track monophonic, 14" reel capacity, 7.5/15 ips.....730-0927
 Model 270-2 As above, except for stereophonic reproduction.....730-0928
 Model 280-1 Rack mount record/reproduce, ½ track monophonic, 10½ reel capacity, 7½-15 ips.....730-0923
 Model 280-2 As above, except for stereophonic.....730-0924
 Model 280-1 (SP-14) Rack mount model 280 monophonic recorder with 14" reel capacity.....730-0925
 Model 280-2 (SP-14) As above, except for stereo.....730-0926

HARRIS
 GATES DIVISION
 Harris-Interpre Corporation

Professional Tape Recorders



REVOX A77

The REVOX A77 is an open-reel tape recorder designed to fill the needs of the professional industry. It is a maximum performance machine that offers everything we believe to be of value. Detailed below are performance and convenience characteristics.

SERVO-CONTROLLED CAPSTAN MOTOR: By means of a tachometer reading the 120 teeth on the outer bell of the motor, speed accuracy is maintained at an unprecedented .2%. Furthermore, the speed consistency is completely independent of the normal voltage frequency and fluctuations. This design also allows accurate electronic speed change, effected by means of one simple low current switch ensuring high reliability and long life.

AUTOMATIC REWIND: When switched in on the remote control unit, this photo-cell activated provision stops the tape after play, rewinds it at high speed, and shuts off the transport automatically. Combined with the machine's long uninterrupted playing time, it provides all of the conveniences of conventional automatic reversing with none of the drawbacks.

OPTIMUM BIAS and equalization are realized through separate electronics for each speed and channel. Machine is biased and equalized for Scotch 203 or equivalent.

SPECIFICATIONS

Mechanical

TAPE TRANSPORT: Three motor. Electronically governed capstan motor. Electronic speed change. Solenoid operated via 3 relays.

TAPE SPEEDS: 3.75 and 7.5 ips; HS 7.5 and 15 ips \pm .2%.

WOW AND FLUTTER: Max. \pm .04% at 15 ips; max. \pm .08% at 7.5 ips; max. \pm .1% at 3.75 ips. (Weighted per DIN Standard 45507.)

TAPE SLIP: Less than .2%

REEL DIAMETER: Max. 10.5".

FORWARD/REWIND: Fast winding time for 1800' is 92 seconds.

TAPE HEADS: Three. (Separate precision erase, record and playback heads.)

GUIDE SYSTEM: The heads, the capstan drive, and the machine's tape guides are mounted to a one-piece casting to maintain precise alignment.

Electrical

MONITORING: Individual stereo record and playback heads with separate preamps, plus separate record and play circuits permit full source-tape monitoring.

EQUALIZATION: NAB Standard on both record and playback at all speeds. IEC Standard switchable on playback only.

RECORD PLAYBACK FREQUENCY RESPONSE: 15 ips—30 Hz-20 kHz \pm 1.5 dB; 7.5 ips—30 Hz-20 kHz +2/-3 dB; 3.75 ips—30 Hz-16 kHz +2/-3 dB. (Based on Scotch 203 or equivalent.)

SIGNAL TO NOISE: 15 ips—better than 64 dB; 7.5 ips—better than 61 dB; 3.75 ips—better than 58 dB. (Referenced with Scotch 203 or equivalent. Weighted as per CCITT C-curve to exclude supersonic bias noise.) Add 6 dB to the above figures with Dolby on, referenced to less than 2% THD.

DISTORTION AT FULL MODULATION AT 1kHz: Max. 2% at 15 and 7.5 ips. Max. 3% at 3.75 ips.

CROSSTALK AT 1kHz: Stereo, better than 45 dB; Mono, better than 60 dB.

BIAS FREQUENCY: 120 kHz, push-pull oscillator. Designed for the new low noise, high-output tapes.

INPUT SENSITIVITY PER CHANNEL: Microphone, switchable LOW/HIGH. LOW: 50-600 ohms (unbalanced), 15mV; HIGH: up to 100 K ohms, 2.5mV; RADIO: 33 K ohms, 2.5mV; AUX.: 1 M ohms, 33mV.

OUTPUTS PER CHANNEL: OUTPUT: max. 2.5 rms at 600 ohms; RADIO: max. 1.2 rms at 2.5 K ohms; PHONES: 200-600 ohms (no electrostatic).

REMOTE CONTROL: Fully electric for all operating functions.

OUTPUT AMPLIFIERS: Plug-in optional. 8 watts RMS/Channel, 4-16 ohms, less than 1% distortion.

POWER SUPPLY: Electronically stabilized.

MAINS VOLTAGES: 110, 130, 150, 220, 240, 250V/50-60 Hz, 80W.

DIMENSIONS: 16 $\frac{1}{4}$ " W x 14 $\frac{1}{4}$ " H x 8 $\frac{1}{2}$ " D. (Measurements include knobs but not reels.)

WEIGHT: Approximately 34 pounds.

ORDERING INFORMATION

| | |
|---|--------------|
| REVOX A77 MK3, Model 1102SSP Recorder/Reproducer 2-track stereo 3 $\frac{3}{4}$ -7 $\frac{1}{2}$ ips. Deck with wood cabinet and stainless steel faceplate..... | 730-1459-000 |
| Same as above, Model 1104SSP, $\frac{1}{4}$ -track, 2-channel, stereo..... | 730-1460-000 |
| REVOX A77 MK3, Model 1302SSP Recorder/Reproducer. Deck with metal case for custom mounting or rack mounting with adapter below. No audio output amplifiers. 2-track, stereo with stainless steel faceplate, 3 $\frac{3}{4}$ -7 $\frac{1}{2}$ ips..... | 730-1448-000 |
| Same as above, Model 1304SSP, $\frac{1}{4}$ -track, 2-channel, stereo..... | 730-1475-000 |
| Operator's manual (included with each machine)..... | 730-1483-000 |
| Service manual, complete schematics, parts lists, service information..... | 730-1451-000 |
| 19" Rackmount (for 1300 type)..... | 730-1453-000 |
| NAB locking reel adapter for 3" center reel (order 2 per deck)..... | 730-1570-000 |
| 10 $\frac{1}{2}$ " REVOX reels (empty, standard center)..... | 730-1484-000 |
| Model 1610 Remote Control, 30-ft. cord..... | 730-1456-000 |

HIGH FREQUENCY BROADCAST TRANSMITTERS

HARRIS



GATES DIVISION
Harris-Intertype Corporation

100 kW Short Wave Broadcast Transmitter

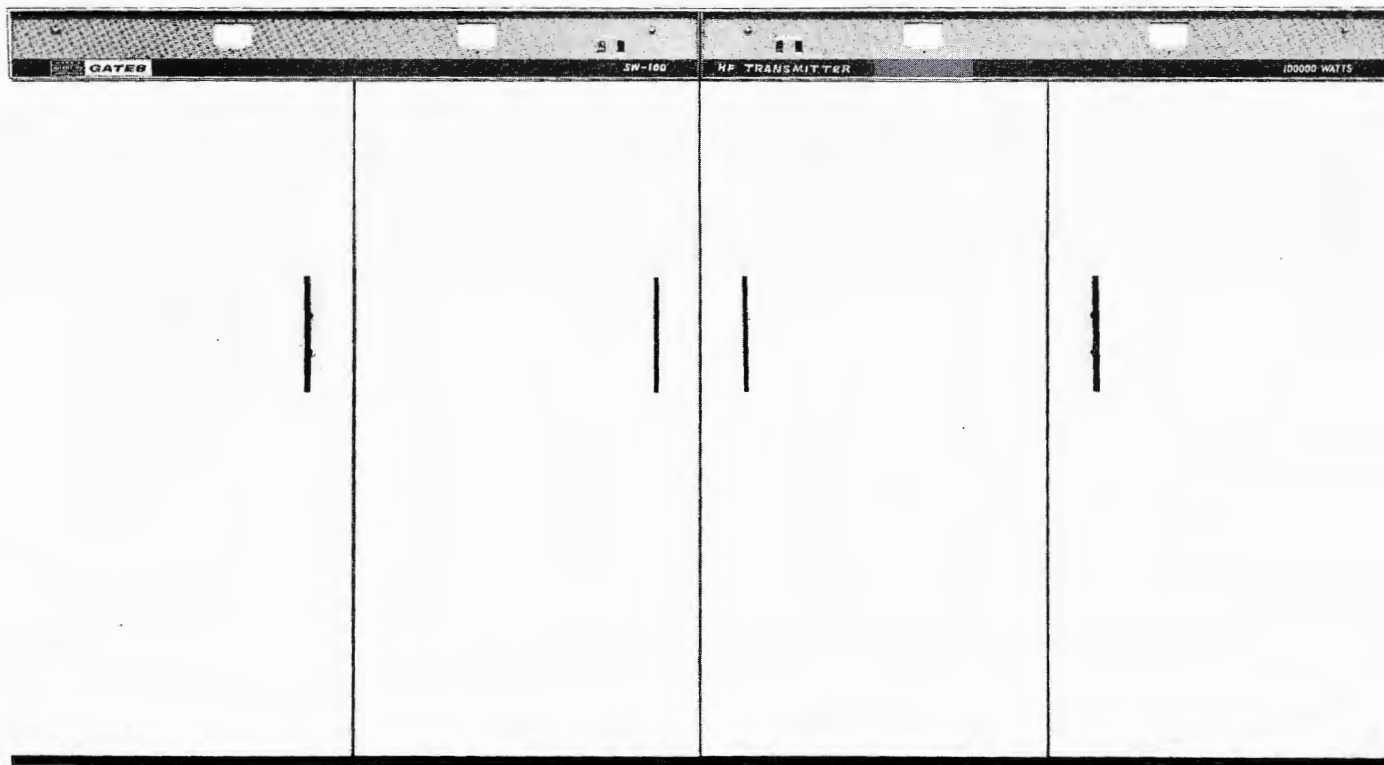

MODEL SW-100

Gates SW-100 provides overall performance superior to that of any other short wave broadcast transmitter in the same power range—and at significantly lower operating costs. This is made possible by Gates' exclusive high level Pulse Duration Modulator (U.S. Patent No. 3440566).

HIGH EFFICIENCY—EXCEEDS 60%: The Pulse Duration Modulator employed in the transmitter is almost 90% efficient (instead of the usual 50% or 60%), allowing an unusually high overall efficiency of more than 60%. This means about one-third less power consumption than that of other high level plate modulated 100 kilowatt transmitters.

ONLY FIVE TUBES: The transmitter employs just five tubes—with a modern ceramic 4CV50,000E power tetrode in the modulator and final RF power amplifier sockets. All power supplies utilize long-life solid-state silicon rectifiers. Highest quality components, conservatively rated, are used throughout the SW-100 to assure greatest reliability.

CONTINUOUS 100% MODULATION RATING: The high efficiency series type Pulse Duration Modulator permits continuous 100% sine wave or trapezoidal modulation. Another feature of this high efficiency series type modulator is convenient front panel carrier adjustment over a wide range.



High power tetrode, 4CV50,000E, used in both the RF amplifier and modulator. Weighs only 35 pounds, and can easily be handled by one man.

100 kW Short Wave Broadcast Transmitter

PRE-SET TUNING: After the SW-100 has been tuned to the desired frequency manually, the exact position of each variable tuning element is stored in a simple "memory". Up to ten different frequencies from 3.2 to 26.5 MHz can be "remembered", which allows pushbutton re-tuning to any pre-set frequency without further manual tuning. Few controls and ample metering make this the easiest tuning 100 kW transmitter available.

QUIET VAPOR PHASE COOLING: Vapor phase cooling reduces noise by eliminating the need for large blowers moving high velocity air. One two-horsepower fan cools the heat exchanger and flushes the transmitter cabinets, resulting in whisper-quiet operation. Vapor phase cooling also extends tube life by helping to eliminate "hot spots" and maintaining anode temperatures far below those attained by other methods.

GREATLY REDUCED FLOOR SPACE: Due to the high efficiency of the transmitter and the elimination of large iron

core components (no modulation transformer and reactor), the SW-100 requires only 7.0 square meters (76 square feet) of floor space. Careful cabinet design provides easy accessibility to all components.

TRANSMITTER LAYOUT: The standard layout of the transmitter consists of two cabinets, a heat exchanger designed for mounting on top of the cabinets, and an external high voltage power transformer. Front and rear doors, and meter panel are magnetically latched. External connections to the transmitter are made through the top so that floor ducts are not necessary.

Ideal for use in all types of climate, this transmitter greatly reduces the problems of cleaning and filtering of outside air. With vapor phase cooling, ducting outside air into the transmitter is not necessary. Also, the cooling system requires little attention other than maintaining the proper purity and water level in the reservoir tank.

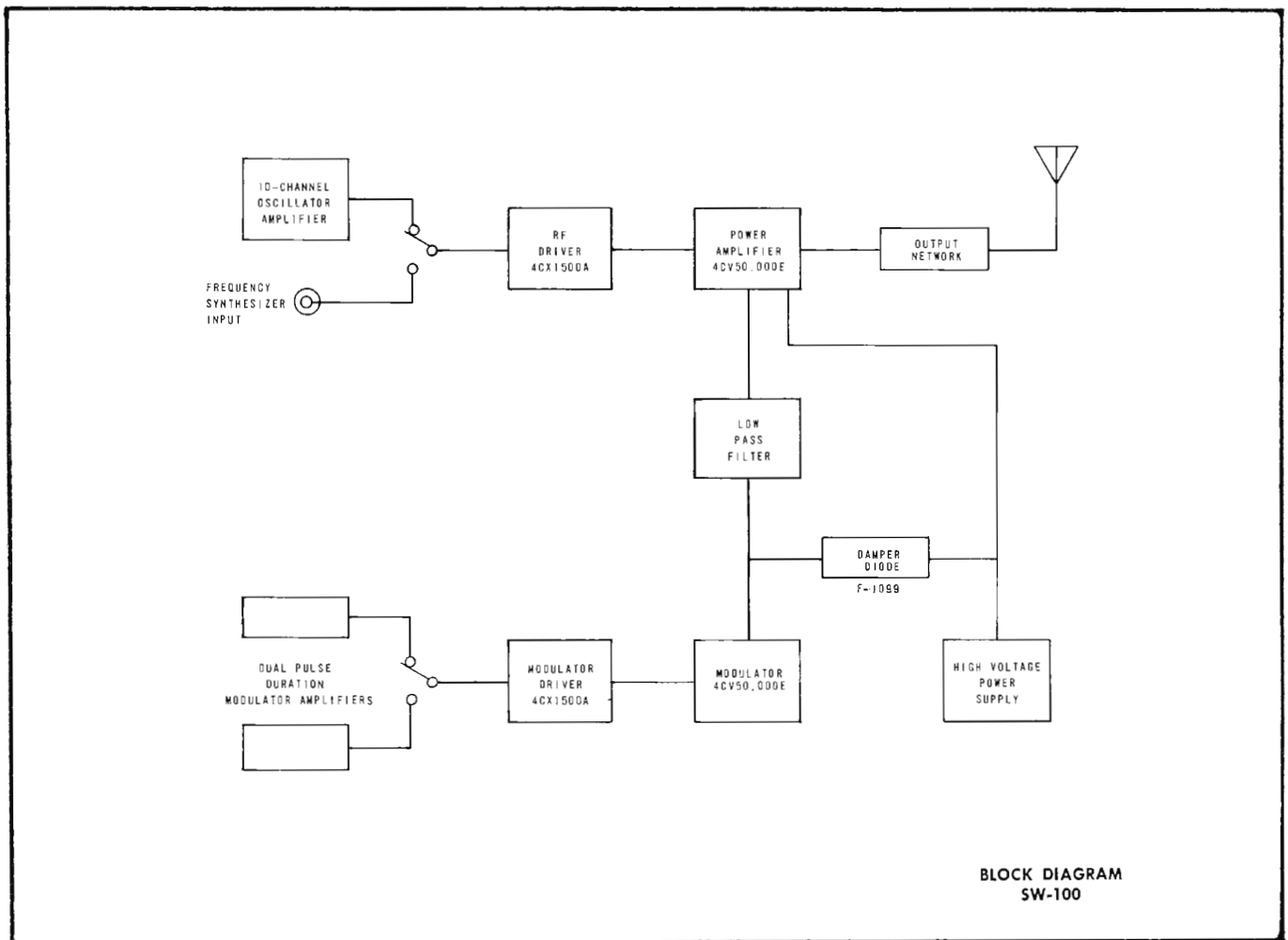

100 kW Short Wave Broadcast Transmitter

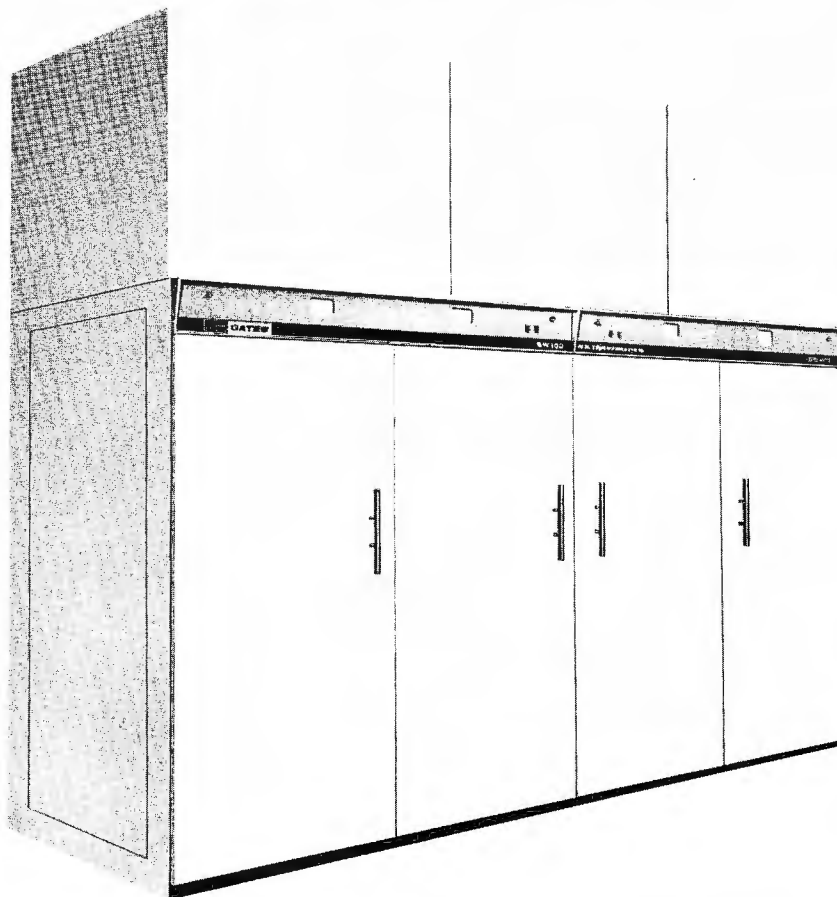

SW-100, with heat exchanger

SPECIFICATIONS

POWER OUTPUT: 100,000 watts nominal unmodulated; capable 110,000 watts.

RF FREQUENCY RANGE: 3.2 to 22.0 MHz. Optional 3.95 to 26.5 MHz.

METHOD OF TUNING: Manual, or selection of 10 pre-set channels.

RF OUTPUT IMPEDANCE: 300/600 ohms, balanced.

RF FREQUENCY STABILITY: $\pm 1 \times 10^{-6}$ (± 22 Hz at 22 MHz).

SPURIOUS AND HARMONIC EMISSION: Less than 50 mW.

CARRIER SHIFT: Less than 2% at 95% modulation. Less than 5% at 100% modulation.

AUDIO FREQUENCY RESPONSE: ± 1.5 dB from 50 to 10,000 Hz referenced to 1,000 Hz at 95% modulation.

AUDIO FREQUENCY DISTORTION: Less than 3% from 50 to 10,000 Hz at 95% modulation.

NOISE: 55 dB below 1,000 Hz, 100% modulated level.

AUDIO INPUT LEVEL: 0 dBm ± 2 dB for 100% modulation.

AUDIO INPUT IMPEDANCE: 600/150 ohms, balanced or unbalanced.

MODULATION LEVEL: 100% sinusoidal, continuous, 50-5000 Hz.

TRAPEZOIDAL MODULATION: Less than 5% tilt or overshoot, 100 Hz to 2000 Hz.

POWER INPUT: Any specified voltage 380 V to 480 V, 3 phase, 50 or 60 Hz.

POWER CONSUMPTION: 165 kW—no modulation; 170 kW—30% modulation; 250 kW—100% modulation.

POWER FACTOR: Greater than 95%.

VOLTAGE REGULATOR: Electronic voltage regulation for all power supplies other than high voltage.

CROWBAR RESPONSE: Less than 5 microsecond operate time.

OVERALL EFFICIENCY: 60% @ average modulation.

TUBES: Two—4CV50,000E; two—4CX1500A; one—F-1099.

TEMPERATURE RANGE: 0 to $+50^{\circ}\text{C}$ ambient air temperature.

HUMIDITY: 95% relative humidity, maximum.

STORAGE TEMPERATURE: -35°C to $+60^{\circ}\text{C}$.

ALTITUDE: Up to 1829 meters (6000 feet) above sea level.

CABINET DATA: Each of two cabinets measures 1.83 meters (6 feet) wide, 1.37 meters (4.5 feet) deep, and 1.98 meters (6.5 feet) high. The heat exchanger adds another 1.06 meters (3.5 feet) in height.

ORDERING INFORMATION

SW-100, 100,000 watt short wave broadcast transmitter.....994-6734

50 kW Short Wave Broadcast Transmitter

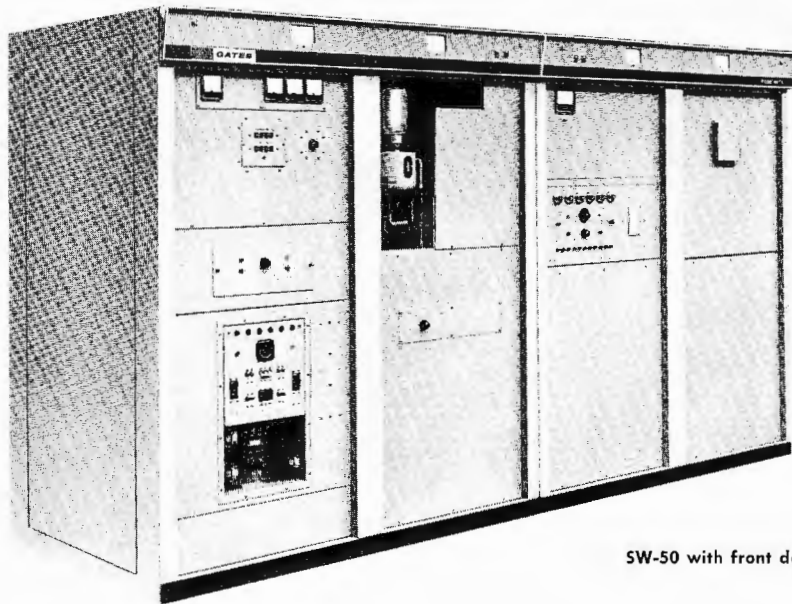

SW-50 with front doors removed.

The SW-50 is the 50 kW version of the SW-100, and includes: the Pulse Duration Modulator, which allows an unusually high overall efficiency of more than 60%; five tube design—only five tubes in the entire transmitter for highest reliability; continuous 100% modulation rating; quiet Vapor

Phase cooling; pre-set tuning; and reduced floor space, due to the elimination of large iron core components.

The SW-50 layout is identical to that of the SW-100 (two cabinets, heat exchanger and external high-voltage power transformer).

SPECIFICATIONS

POWER OUTPUT: 50,000 watts nominal unmodulated; capable 55,000 watts.
RF FREQUENCY RANGE: 3.2 to 22.0 MHz. Optional 3.95 to 26.5 MHz.
METHOD OF TUNING: Manual, or selection of 10 pre-set channels.
RF OUTPUT IMPEDANCE: 300/600 ohms, balanced.
RF FREQUENCY STABILITY: $\pm 1 \times 10^{-6}$ (± 22 Hz at 22 MHz).
SPURIOUS AND HARMONIC EMISSION: Less than 50 mW.
CARRIER SHIFT: Less than 2% at 95% modulation. Less than 5% at 100% modulation.
AUDIO FREQUENCY RESPONSE: ± 1.5 dB from 50 to 10,000 Hz referenced to 1,000 Hz at 95% modulation.
AUDIO FREQUENCY DISTORTION: Less than 3% from 50 to 10,000 Hz at 95% modulation.
NOISE: 55 dB below 1,000 Hz, 100% modulated level.
AUDIO INPUT LEVEL: 0 dBm ± 2 dB for 100% modulation.
AUDIO INPUT IMPEDANCE: 600/150 ohms, balanced or unbalanced.
MODULATION LEVEL: 100% sinusoidal, continuous, 50-5000 Hz.
TRAPEZOIDAL MODULATION: Less than 5% tilt or overshoot, 100 Hz to 2000 Hz.

POWER INPUT: Any specified voltage 380 V to 480 V, 3 phase, 50 or 60 Hz.
POWER CONSUMPTION: 90 kW—no modulation; 93 kW—30% modulation; 135 kW—100% modulation.
POWER FACTOR: Greater than 95%.
VOLTAGE REGULATOR: Electronic voltage regulation for all power supplies other than high voltage.
CROWBAR RESPONSE: Less than 5 microsecond operate time.
OVERALL EFFICIENCY: 60% @ average modulation.
TUBES: Two—4CV50,000E; two—4CX1500A; one—F-1099.
TEMPERATURE RANGE: 0 to +50°C ambient air temperature.
HUMIDITY: 95% relative humidity, maximum.
STORAGE TEMPERATURE: -35°C to +60°C.
ALTITUDE: Up to 1829 meters (6000 feet) above sea level.
CABINET DATA: Each of two cabinets measures 1.83 meters (6 feet) wide, 1.37 meters (4.5 feet) deep, and 1.98 meters (6.5 feet) high. The heat exchanger adds another 1.06 meters (3.5 feet) in height.

ORDERING INFORMATION

SW-50, 50,000 watt short wave broadcast transmitter-----994-6808

20,000 Watt HF Broadcast Transmitter

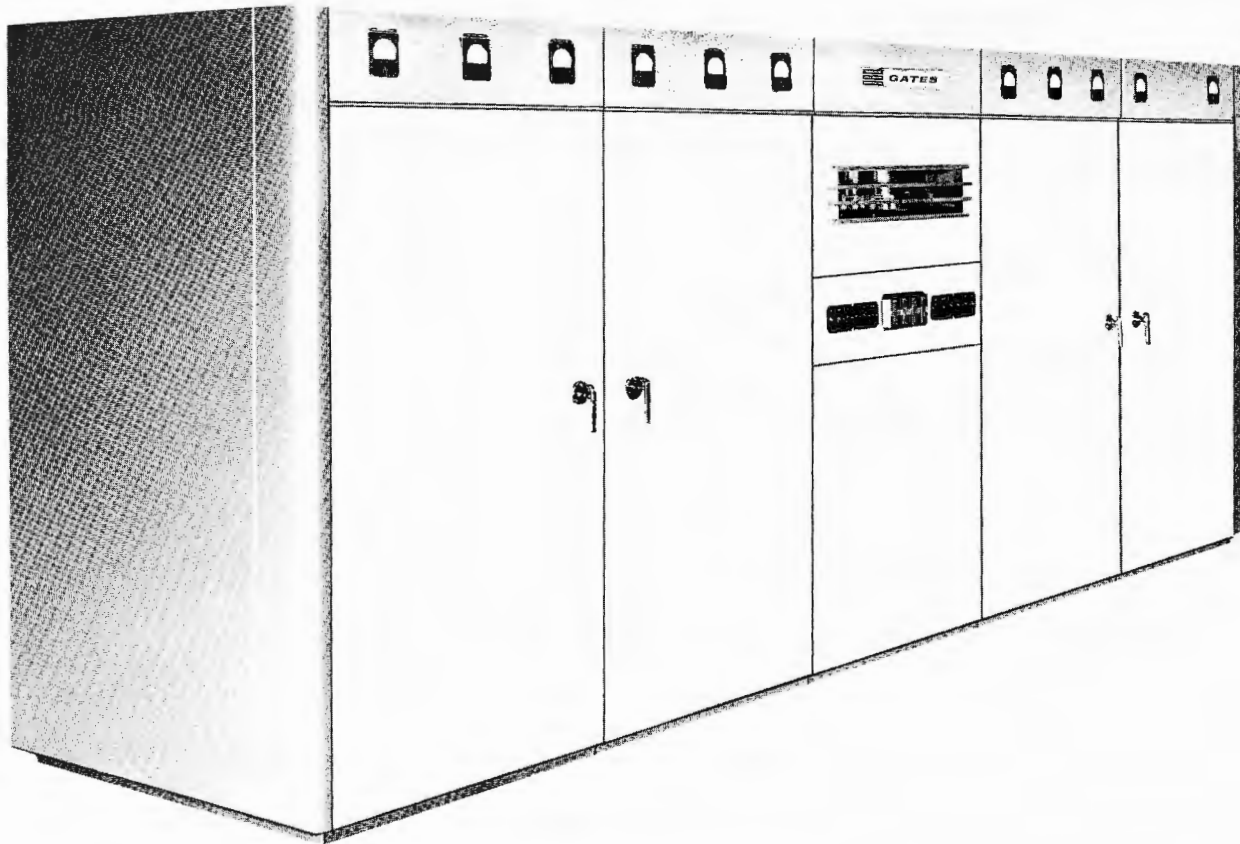

MODEL HF-20B

This remarkable transmitter, field proven in over 16 different countries, represents the ultimate in 20 kW high frequency transmitter performance. It is designed for continuous 24-hour-a-day operation in all parts of the world, including areas with tropical climates.

Air cooled and employing high level plate modulation, the HF-20B is tunable over the entire frequency spectrum between 4 and 22 MHz.

FAST TUNING: Once the frequency band is selected, transmitter tune-up can be made within one minute from front panel controls. Except for the final tank coil, all circuits are continuously variable and front panel tuned between 4 MHz and 22 MHz. Changing of the final tank coil, which sets on a sliding carriage in the PA tank frame assembly, is speedily accomplished. Five coils are supplied for full 4-22 MHz coverage. Counter type controls read to 1/10 turn to permit accurate logging of all tuned circuits and quick return to any previously employed frequency.

RADIO FREQUENCY AND AUDIO SECTIONS: A two-stage radio frequency exciter unit incorporates switching positions for four crystals and input provisions for an external VFO or frequency shift keyer. The 6146 straight amplifier or doubler stage is followed by two type 4-250A tubes which provide an abundance of RF drive to the final amplifier. Four 3X2500F3 triodes operate push-pull parallel in the power output stage. A superb audio system consisting of four stages, all push-pull, is employed in the HF-20B. Four type 3X3000F1 triodes operating push-pull are used as Class B modulators.

OUTPUT COUPLING: To accommodate a wide variety of transmission lines, a balanced matching output network is incorporated, using series variable coils and parallel variable vacuum capacitors designed to match 300 to 800 ohm resistive balanced lines (500 ohms, with VSWR 1.7 to 1). Both variable coils and capacitors have counter type tuning controls for accurate logging. (A 50 ohm unbalanced output is also available on special order).

20,000 Watt HF Broadcast Transmitter—HF-20B

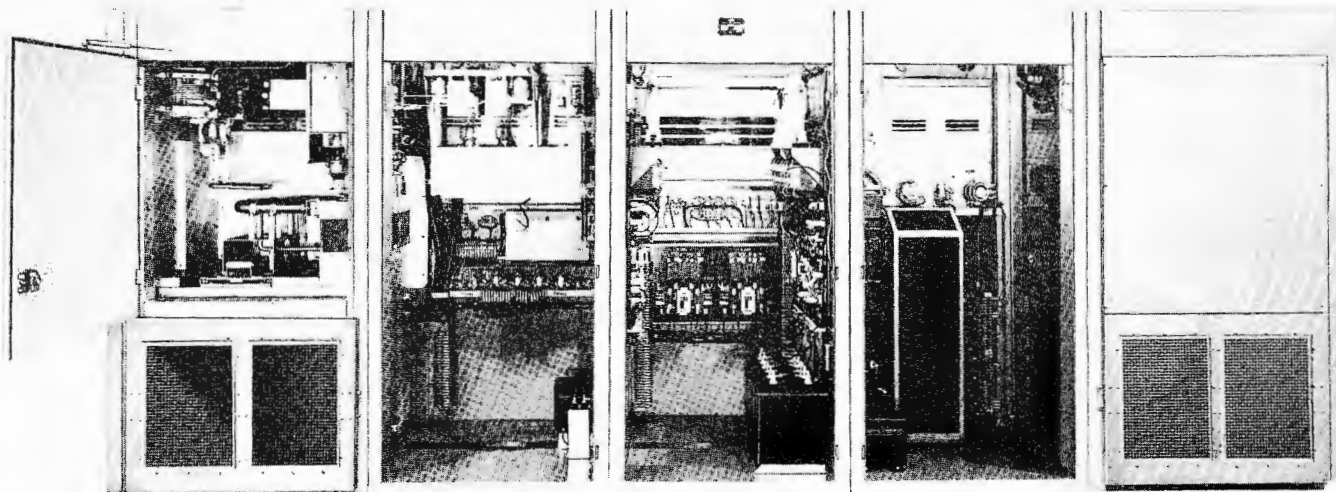

Rear view of the HF-20B.

POWER SUPPLIES: Five major power supplies deliver plate and bias voltages to the HF-20B transmitter. To assure greater reliability and better regulation, separate high voltage supplies are used for the modulator and power amplifier.

RELAYS AND PROTECTION: Magnetic AC contactors are inserted in all main primary lines. All major tubes are protected by individual supervisory overload relays. Protection devices included for door interlock and air failure.

MODEL HF-20BX: Identical to the HF-20B transmitter described herein, but has 400 word per minute keyer added. This model may be used for broadcasting, voice communications, telegraph, or with optional frequency shift keyer.

MODEL HF-20CX: The audio frequency response is for voice only in this model; otherwise it is the same as the HF-20BX, including keyer and provision for FSK. Audio response is rated 200-3,500 Hz \pm 3 dB.

SPECIFICATIONS

CARRIER POWER OUTPUT: 4-18 MHz, 20,000 watts. 18-22 MHz, 16,000 watts modulated (A3). Full 20 kW output 4-22 MHz telegraph.

FREQUENCY RANGE: 4-22 MHz.

RF STABILITY: .003% or better, with JK-09C oven.

OUTPUT IMPEDANCE: 300-800 ohms resistive balanced. (500 ohms, with VSWR 1.7 to 1.) (50 ohms unbalanced, optional).

POWER LINE REQUIREMENTS: 230 volts, 3 phase, 50/60 Hz. Other primary voltages or line frequencies available on special order.

POWER FACTOR: 90% or better.

POWER CONSUMPTION: 0% modulation, 37 kW. Average modulation, 43 kW. 100% modulation (sine wave), 55 kW.

POWER REDUCTION: Low power tune-up switch provided.

AUDIO RESPONSE: \pm 1.5 dB, 50-10,000 Hz.

DISTORTION: 3% or less, 100-5000 Hz. 4% or less 50-7500 Hz.

NOISE: 55 dB or better below 100% modulation.

CRYSTAL POSITIONS: Four; input for external VFO or FSK provided.

KEYING: 400 wpm with essential square top wave form, on-off keying. Keyer supplied on Models HF-20BX and HF-20CX only.

TUBES: (RF section) 6AG7 oscillator, 6AG7 buffer, 6146 buffer/doubler, (2) 4-250A RF driver, (4) 3X2500F3 power amplifiers. (Audio section) (2) 6J7 first audio, (2) 807 second audio, (2) 845 audio driver, (4) 3X3000F1 modulators. (Power supplies) (12) 673 HV rectifiers, (4) 8008 LV rectifiers, (2) 866A LV rectifiers. (Keyer) (1) 812 keyer tube.

SIZE: HF-20B and HF-20BX, 205" wide, 48½" deep, 78" high. Door swing, 40" front and rear. Floor space for external transformers: 10' x 9'. Largest cabinet size uncrated: 45" wide, 50" deep, 78" high. HF-20CX, 175" wide, 48½" deep, 78" high. Door swing, 40" front and rear. Floor space for external transformers: 5' x 6'.

WEIGHT: (Packed) domestic, 11,000 lbs.; export, 13,900 lbs. Cubage: 1050 cubic feet.

ORDERING INFORMATION

| | |
|---|-----------|
| HF-20B, 20 kW broadcast transmitter, 4-22 MHz, with one set of coils, tubes, less crystals | 994-4748 |
| HF-20BX, 20 kW broadcast transmitter, with tubes and with keyer added, 4-22 MHz, less crystals | 994-4778A |
| HF-20CX, 20 kW telephone and telegraph transmitter, with tubes and keyer, 4-22 MHz, less crystals | 994-4778B |
| Spare 100% tube kit for HF-20B | 990-0139 |
| Spare 100% tube kit for HF-20BX | 990-0140 |
| Crystal and holder, .02% accuracy (specify operating frequency) | CR27A/U |
| Temperature controlled crystal oven holds two CR27A/U crystals for 0.003% accuracy | JK-09C |

HARRIS
GATES DIVISION
Harris-Interpre Corporation

10,000 Watt High Frequency Broadcast Transmitter

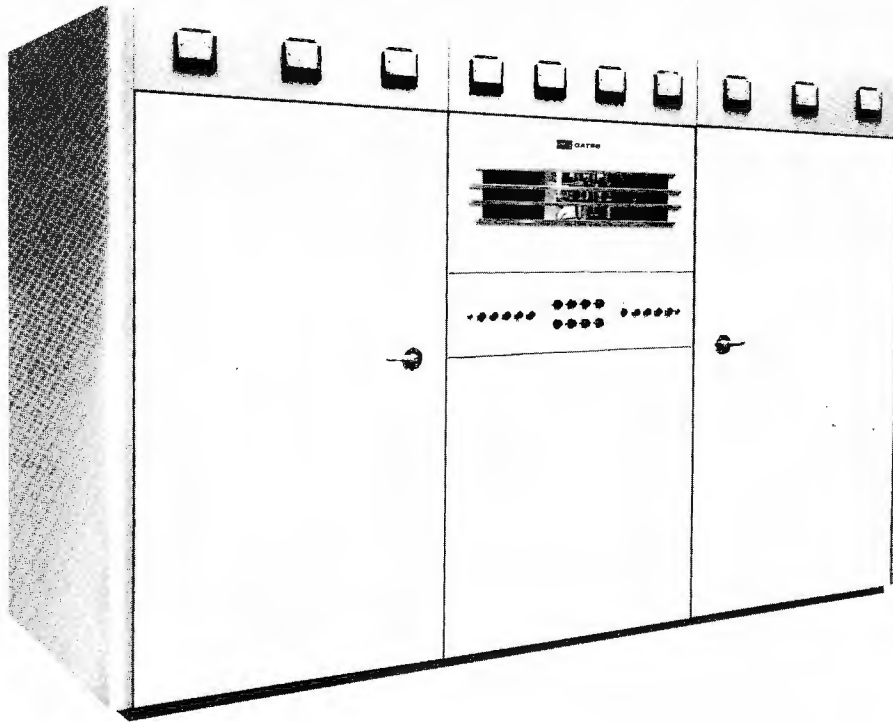

MODEL HF-10B

POWER OUTPUT: 10,000 watts.

FREQUENCY RANGE: 2-22 MHz. (4-30 MHz on special order).

TYPE OF EMISSION: (Model HF-10B) A3. (Models HF-10BX, HF-10CX) A1, A2, A3 and F1 with external frequency shift keyer.

FREQUENCY STABILITY: .003%, with oven.

CARRIER SHIFT: 5% or less at 100% modulation.

RF HARMONICS: Suppression of harmonics meets or exceeds CCIR requirements.

OUTPUT IMPEDANCE: 300 to 800 ohms resistive balanced. (500 ohms with VSWR 1.7 to 1). (50 ohms unbalanced on special order).

POWER LINE REQUIREMENTS: 230 volts, 3 phase, 50 or 60 Hz (as ordered). (Other voltages or line frequencies available on special order.)

POWER FACTOR: 90% or better.

POWER CONSUMPTION: 0% modulation, 21 kW. Average modulation, 23 kW. 100% modulation, 30 kW.

FREQUENCY RESPONSE: (Model HF-10B) ± 1.5 dB, 30-10,000 Hz. (Model HF-10CX) ± 3 dB, 150-4000 Hz.

DISTORTION: (Model HF-10B) 3% or less 50 to 7500 Hz. (Model HF-10CX) 10% or less 150-4000 Hz.

AUDIO INPUT: +15 dBm ± 2 dB.

NOISE: (Model HF-10B) 60 dB or better below 100% modulation. (Model HF-10CX) 45 dB or better below 100% modulation.

CRYSTAL POSITIONS: 4, front panel selected.

TUBES: (2) 6AG7, (2) 4-250A, (2) 6J7, (4) 845, (4) 3X2500F3, (4) 8008, (6) 673, (3) 807, (Keyer is type 812A).

SIZE: 125" wide, 78" high, 48½" deep. Front door swing, 19"; back door swing 40". Size of largest cubicle uncrated: 45" wide, 50" deep, 78" high. (Space required to accommodate optional external oil-filled magnetic components 8' x 3').

WEIGHT AND CUBAGE:

MODEL DRY COMPONENTS

| | |
|---------|---|
| HF-10B | 6600 lbs. domestic packed 6815 lbs. export packed 533 cu. ft. |
| HF-10CX | 6150 lbs. domestic packed 6360 lbs. export packed 523 cu. ft. |

ALTITUDE: 6000 feet. (Higher on special order.)

OIL-FILLED COMPONENTS

(Optional)

| |
|---|
| 8000 lbs. domestic packed 10,174 lbs. export packed 566 cu. ft. |
| 6950 lbs. domestic packed 9125 lbs. export packed 533 cu. ft. |

ORDERING INFORMATION

| | |
|--|----------|
| HF-10B, 10 kW broadcast transmitter, with tubes, less crystals | 994-3787 |
| HF-10BX, 10 kW broadcast transmitter, with tubes, electronic keyer, less crystals | 994-3789 |
| HF-10CX, 10 kW communications telephone and telegraph transmitter, with tubes, less crystals | 994-3793 |
| HF-10TX, 10 kW communications telegraph transmitter, with tubes, less crystals | 994-3795 |
| Spare 100% tube kit for all models | 990-0253 |
| Crystal and holder (.02% accuracy) (specify operating frequency) | CR27A/U |
| Temperature controlled oven, holds two CR27A/U crystals, (.003% accuracy) | JK-09C |

NOTES: (1) State line frequency as 50 or 60 Hz. (2) Above models are for 2-22 MHz and with self-contained dry type power components. (3) All models available for 4-30 MHz at slight extra cost. (4) All models available with external oil-filled plate transformer, modulation transformer, and modulation reactor at extra cost. (5) Be sure and state carrier frequency/s, primary voltage and frequency when ordering.

HARRIS
GATES DIVISION
Harris-InterType Corporation

SINGLE SIDEBAND AND COMMUNICATIONS TRANSMITTERS

HARRIS
 **GATES DIVISION**
Harris-Intertype Corporation

SG-75A Synthesized ISB High Frequency Exciter

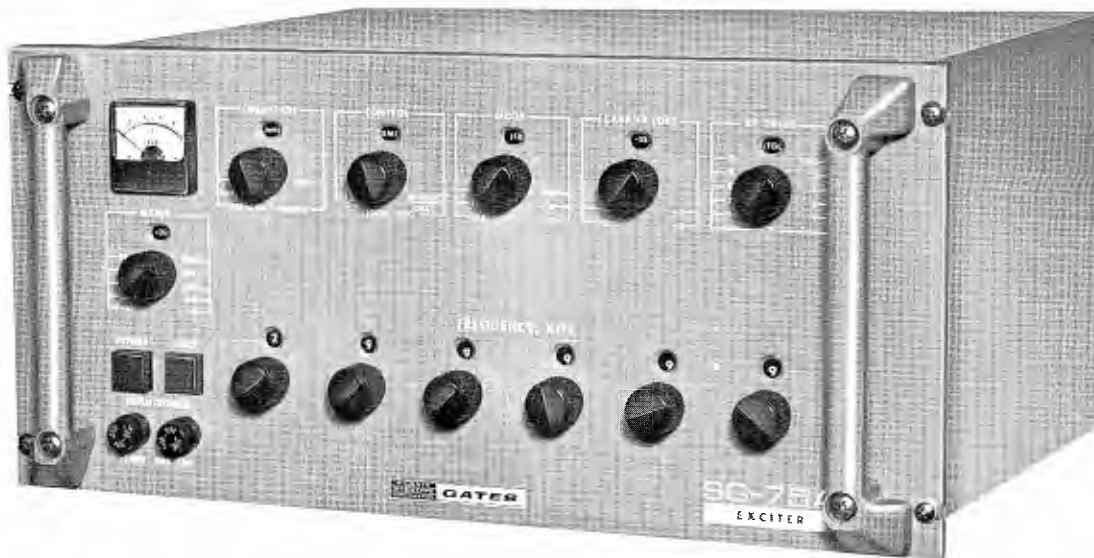

Gates SG-75 frequency synthesized independent sideband exciter features total solid state design plus extensive use of integrated circuits. It provides a power output of 100 milliwatts over the 2 to 30 MHz range, and has six separate operating modes. Direct digital frequency adjustments on the front panel permit selection of 280,000 frequencies in 100 Hz increments.

A self-contained wideband frequency shift keyer provides a full carrier shifted in frequency ± 400 to 425 Hz about the center frequency. This eliminates the need for an external

keyer or tone oscillator and provides the advantages of direct reading of center frequency.

Automatic gain control is used to control the inputs to balanced modulator stages. Controlled carrier level is provided in the lower, upper and independent sideband modes. This carrier level control is automatically turned off in the FSK mode. Carrier level control is on the front panel along with all normal operating controls. The FSK inputs allow polar, neutral and dry contact keying.

SPECIFICATIONS

FREQUENCY RANGE: 2 to 29.9999 MHz in 100 Hz steps (280,000 channels).

OPERATING MODES: CW (A0, A1), FSK (F1); AME (A3h); USB, LSB (A3a, j); ISB (A3b).

RATED POWER OUTPUT: 100 mW PEP/CW.

FREQUENCY CONTROL: Digital control of stabilized VFO, synthesized.

OUTPUT IMPEDANCE: 50 ohms nominal.

GAIN CONTROL: Automatic with manual override.

TUNING TIME: 10 seconds.

METHOD OF TUNING: Automatic.

SIGNAL TO NOISE RATIO: In band 50 dB. Out of band 60 dB, exclusive of harmonics.

SIGNAL TO DISTORTION RATIO: 50 dB at rated output. (Distortion products: At rated output, 3rd and higher order products are at least 50 dB below either tone of a standard two-tone test signal).

CARRIER LEVEL: Selectable: SG-75A, 0, -6, -20, -55 dB.

STABILITY: 1×10^{-7} per day (optional 5×10^{-9} per day).

UNWANTED SIDEBAND REJECTION: 60 dB at 500 Hz.

AUDIO INPUT: Two independent 600 ohm channels balanced or unbalanced, -20 to +10 dBm for full RF output with independent AGC amplifiers.

AUDIO FREQUENCY RESPONSE: 250 to 3000 Hz or 250 to 6000 Hz with 3 dB maximum ripple.

FSK CAPABILITY: Wideband FSK built in, adjustable from ± 400 to ± 425 Hz (other shifts optional).

POWER INPUT: 115/230 volts, $\pm 10\%$, 47 to 400 Hz, 50 watts maximum, 2 wire, single phase. All power supplies regulated.

TEMPERATURE: 0° to $+50^\circ\text{C}$.

HUMIDITY: 0 to 95%.

ALTITUDE: Sea level to 10,000 feet.

OUTPUT CONNECTOR: Type BNC.

SIZE: 8 $\frac{3}{4}$ " high, 19" wide, 17" deep.

WEIGHT: 56 lbs. net; domestic pack 75 lbs.; export pack 110 lbs.; Cubage: 6 cubic feet.

OPTIONAL REMOTE CONTROL: Electronic with adapter.

COMPONENTS: All components meet MIL specifications where practicable.

NOTE: The SG-75A exciter operates with Gates ATL-10 automatically tuned 10 kW ISB transmitter.

ORDERING INFORMATION

SG-75A synthesized HF ISB exciter.....994-6562

SG-70 ISB High Frequency Exciter



Gates Model SG-70 ISB exciter is equipped to transmit single sideband, independent sideband, compatible AM, CW, MCW, or FSK with adapter. Provisions are incorporated for carrier suppression from -50 dB to 0 dB. A versatile and compact unit designed for accurate and rapid channel change and tune-up, the SG-70 has a self-contained silicon rectifier power supply, and requires only 8 3/4 inches in a standard 19-inch rack for mounting.

The input circuits of the SG-70 include two independent 600 ohm balanced or unbalanced input channels and one high impedance microphone channel. The 600 ohm channels will operate the exciter to full power with a minimum input audio level of -12 dB.

Mode selector switches are provided to switch all inputs to either upper sideband or lower sideband operation.

For the accurate and rapid tuning changes required in HF communications, Gates has designed the SG-70 sideband generator to provide increased utilization through simplified operation. Any one of ten crystal controlled channels may be selected immediately by the turn of a knob. A second selector switch chooses one of 15 frequency bands within the 2-32 MHz range.

Then two final adjustments remain, RF tune and injection tune and the exciter is operational. Exceptional frequency stability is achieved through the use of an oven containing the master solid state transistorized frequency oscillator. The absolute drift never exceeds 8 Hz at any point in the spectrum. The solid state power supply is self-contained. The three generator modules—IF frequency generator, RF section, and Injection generator—are of the plug-in type.

SPECIFICATIONS

FREQUENCY RANGE: 2-32 MHz continuous, band switched.

POWER OUTPUT: 100 milliwatts PEP.

OUTPUT IMPEDANCE: 50 ohms nominal.

OPERATING MODES: USB, LSB, ISB, AME, CW, MCW, FSK with external adapter.

FREQUENCY CONTROL: Temperature controlled crystals, or optional external VFO or synthesizer.

CRYSTAL POSITIONS: 10. Selectable from front panel, with independent trimmer, or synthesizer.

STABILITY: Better than 1 PPM per day.

CARRIER SUPPRESSION: 0 to -50 dB.

SIGNAL TO DISTORTION RATIO: 45 dB @ rated output. (Distortion products: At rated output, 3rd and higher order products are at least 45 dB below either tone of a standard two-tone test signal.)

SIGNAL TO NOISE RATIO: 55 dB.

UNWANTED SIDEBAND REJECTION: 60 dB at 500 Hz.

AUDIO INPUT: Two independent 600 ohm channels balanced or unbalanced. -12 dBm for full RF output. One high impedance microphone channel requiring 1 mV for full PEP.

AUDIO RESPONSE: 250 to 6350 Hz with a 3 dB maximum ripple. Other bandwidths available.

ENVIRONMENTAL: 0° to +50°C operating, or -50° to +70°C non-operating.

POWER CONSUMPTION: 140 watts.

POWER INPUT: 115/230 volts, ±5%, 50/60 Hz, 2 wire, single phase.

SIZE: 19" wide, 8 3/4" high, 17" deep.

WEIGHT: 56 lbs. net; 90 lbs. export packed. Cubage: 7.5 cubic feet.

NOTE: The SG-70 exciter operates with Gates 1, 3, or 10 kW linear power amplifiers.

ORDERING INFORMATION

SG-70 ISB HF exciter.....994-6411
 Complete set of spare tubes.....990-0517



10 kW Automatically Tuned ISB HF Power Amplifier

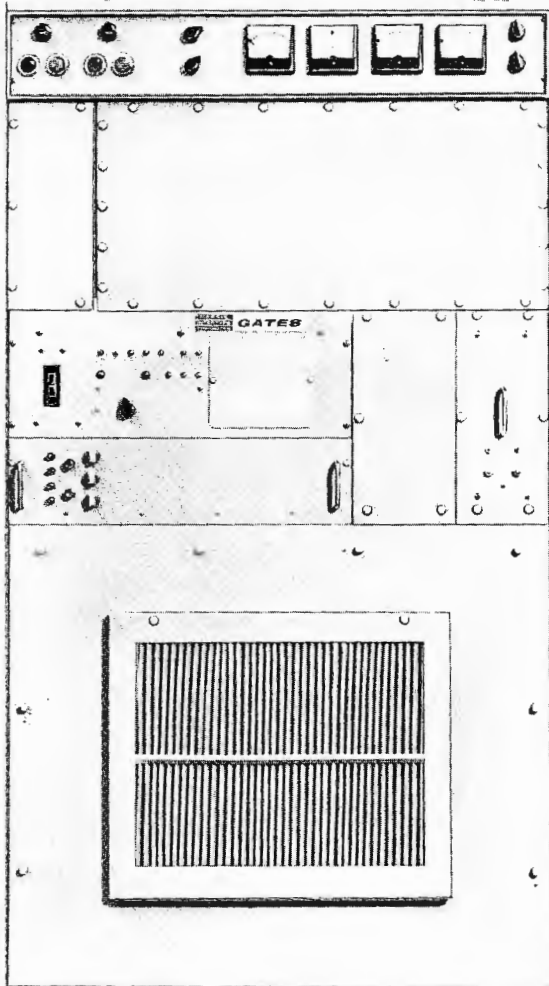

MODEL ATL-10

Designed for operation in high performance SSB transmitting systems, the Gates ATL-10 linear amplifier requires only 0.1 watt RF drive power to tune automatically from 2-30 MHz in 20 seconds or less. Power output is 10 kW peak envelope or average into an antenna load in any mode requiring linear amplification in a 16 kHz bandwidth. A reliable, simplified tune sequence control governs the automatic tuning circuits with a minimum of control information from the exciter. No band information is required. Prepositioning of the tuning elements is achieved directly from information taken from the input RF frequency, thus making the power amplifier suitable for use with any exciter capable of delivering 100 mW of drive power.

A unique feature of the ATL-10 is the use of DC torque motors to position the tuning elements. These are direct-drive motors

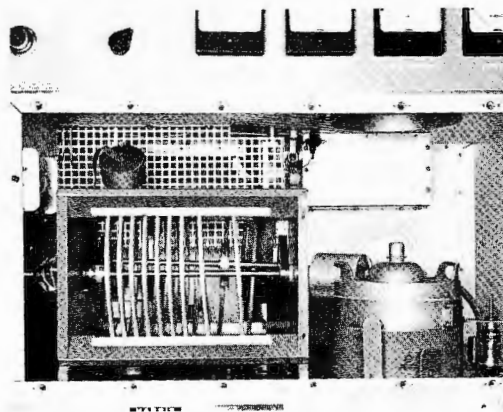

A single 8171/4CX10,000D ceramic tetrode, operating Class AB₁ in a grounded screen configuration, produces the full 10 kW PEP or CW output with maximum stability.

that eliminate much of the mechanical complexity heretofore inherent in automatically tuned equipment. As DC motors are insensitive to power line frequency, the Gates ATL-10 amplifier may be operated from various sources without the need for an optional frequency inverter.

The ATL-10 amplifier, when combined with the Gates SG-75A Exciter, offers full remote control capability. This optional remote control equipment is available to operate both units in a variety of configurations. Combining the SG-75A and ATL-10 produces the advanced STAR-10 sideband transmitter.

RF INPUT: A single type 8233 tube operating Class A in the broad-band input amplifier assures high gain with stability, while maintaining low distortion characteristics. A single type 8321/4CX350A second Class A amplifier also operates completely broad-band. The interstage networks up to and including the input to the driver amplifier are broad-banded and do not require servo tuning.

DRIVER AMPLIFIER: A pair of 8321/4CX350A tubes are operated Class AB₁ to develop satisfactory reserve drive power for the final amplifier grid. Efficiency of this stage is maximized by the use of a parallel tuned matching network to couple into the final amplifier. Approximately 8 dB of RF feedback is applied to the cathode of the driver from the plate circuit of the final amplifier to improve the linearity of these stages.

POWER AMPLIFIER: The final amplifier employs an 8171/4CX10,000D ceramic tetrode operating Class AB₁ in a grounded screen configuration for maximum stability. The grid drive network and plate tank circuits are automatically tuned to resonance by DC control amplifiers and torque motors. The output tuning and loading network is a pi-L filter designed for optimum harmonic rejection and load matching ability. This circuit is capable of matching into a 3:1 VSWR at a full rated power, with optimum loading obtained by the third DC motor and servo system.

10 kW Automatically Tuned ISB HF Power Amplifier-ATL-10

SPECIFICATIONS

FREQUENCY RANGE: 2 to 30 MHz.

OPERATING MODES: Dependent on type of exciter.

RATED POWER OUTPUT: 10 kW PEP or average.

OUTPUT IMPEDANCE: 50 ohms with VSWR up to 3:1.

GAIN CONTROL: Capable of automatic with proper exciter interface.

GAIN VARIATION: 4 dB maximum, 2-30 MHz.

TUNING TIME: 20 seconds maximum.

METHOD OF TUNING: Automatic, remote.

HARMONIC OUTPUT: 2nd, -56 dB below full output, all others 60 dB.

SIGNAL TO NOISE RATIO: 50 dB.

SIGNAL TO DISTORTION RATIO: Capable of 40 dB, 2 to 27.5 MHz; 38 dB, 27.5 to 30 MHz. Distortion products: At rated output, third and higher order distortion products are at least 40 dB below either tone of a standard two-tone test signal 2 to 26 MHz, and at least 36 dB 26 to 30 MHz.)

BANDWIDTH: 25 kHz; 1.5 dB ripple 2 to 4 MHz, 1.0 dB ripple 4 to 30 MHz.

INPUT IMPEDANCE: 50 ohms, 1.5:1 VSWR (maximum).

INPUT CONNECTOR: Type BNC.

RF INPUT POWER: 100 mW maximum for both tune and operate.

POWER INPUT: 200, 210, 220, 230, 240 and 250 volts, $\pm 10\%$, 3 phase, 47-63 Hz, 24 kVA at 0.95 power factor, at 10 kW CW.

TEMPERATURE: 0° to 50°C.

HUMIDITY: 0 to 95%.

ALTITUDE: Sea level to 10,000 feet.

OUTPUT CONNECTOR: 1 5/8" EIA flange.

REMOTE CONTROL: Optional.

COMPONENTS: All components meet MIL specifications where practicable.

SIZE: 69" high, 40" wide, 27" deep.

WEIGHT: 1300 lbs. net. Domestic pack, 1545 lbs. Export pack, 1700 lbs. Cube: 88.7 cubic feet.

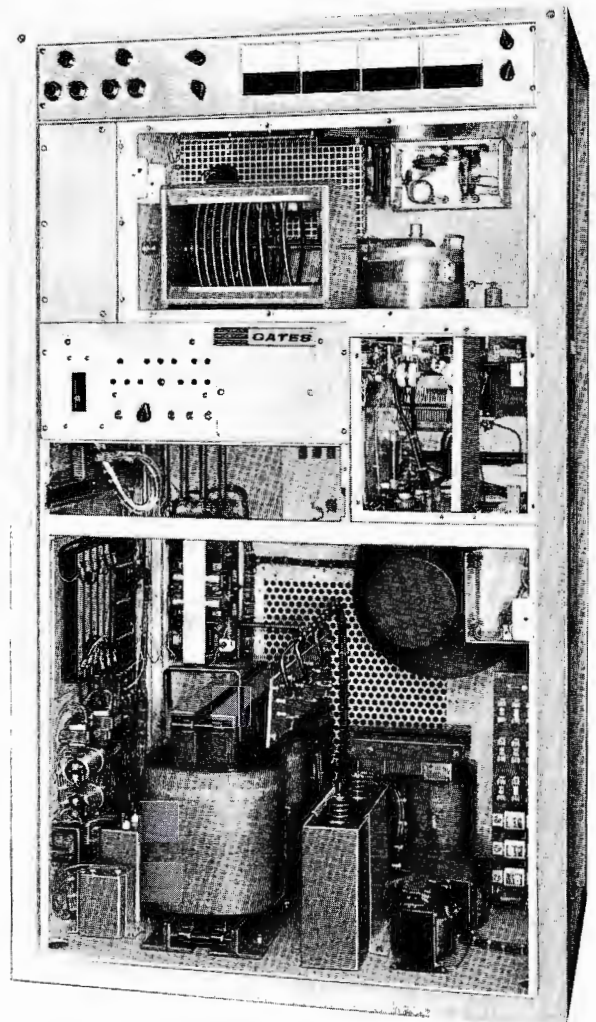

ORDERING INFORMATION

ATL-10 10,000 watt automatically tuned ISB HF power amplifier, complete with cabinet.....994-6506
 100% spare tube kit.....990-0574

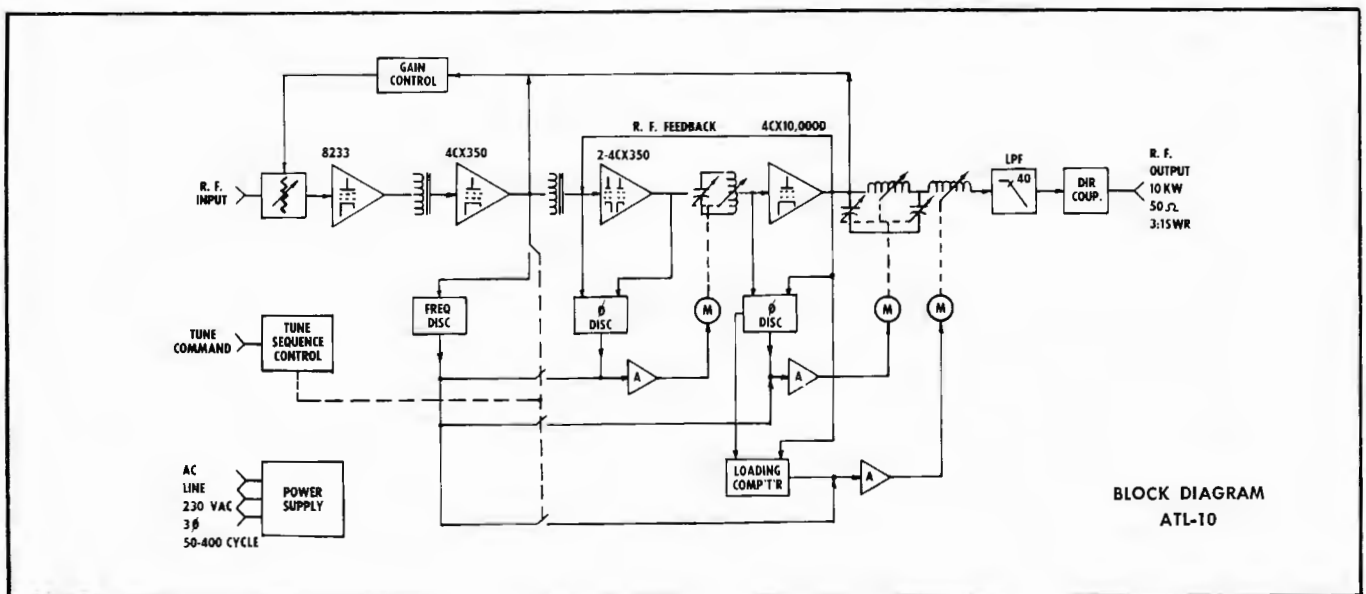

BLOCK DIAGRAM
ATL-10

HARRIS
GATES DIVISION
 Harris-Intertype Corporation

10 kW Automatically Tuned ISB HF Transmitter

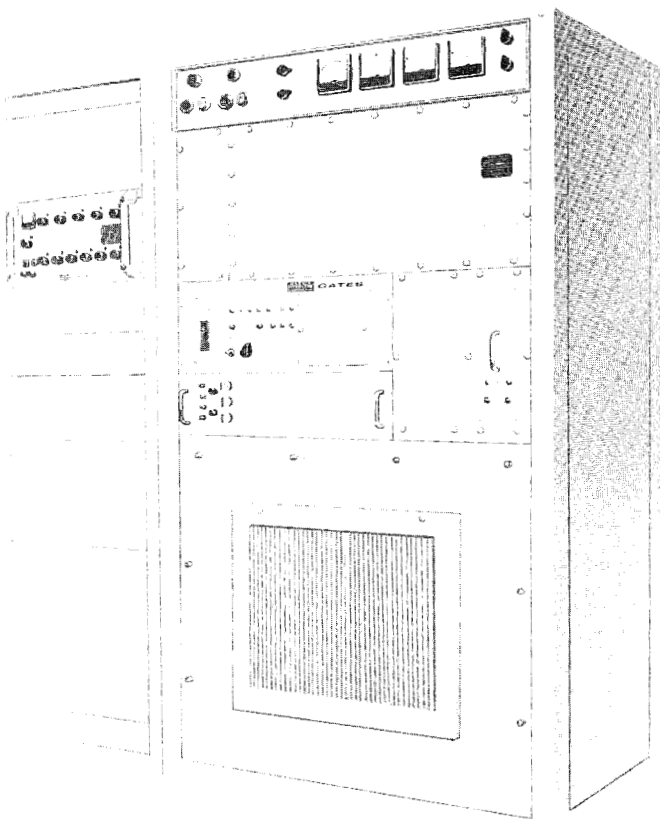

MODEL STAR-10

Totally modern in design, the STAR-10 is a complete 10 kW transmitter for HF communication service. It incorporates a synthesized exciter that generates a total of 280,000 discrete frequencies, spaced every 100 Hz in the 2-30 MHz band; and a linear power amplifier (ATL-10) which provides a full 10 kW on single tone, as well as 10 kW PEP.

The STAR-10 can be retuned, and mode or power level changed in less than 25 seconds, from the time the remote control is actuated to the time the final loads.

All components are solid state except LPA tubes. Integrated circuits are used to control digital tuning of the synthesizer. Signal circuits of the exciter, plus the servo control circuit of the LPA, are discrete components.

LOW DISTORTION: Third order distortion products are at least 40 dB below either tone of a two-tone test at rated power output up to 27.5 MHz.

HARRIS
GATES DIVISION
Harris-Intertype Corporation

TUNING: Automatic frequency change is accomplished through a sequential control which is activated by a specific "Tune" command and a new reference frequency. The three DC servo motors are operated in closed loop proportional control servo systems to accomplish the actual adjustment. Tuning time is normally 20 seconds or less.

SENSORS AND DETECTORS: The change in frequency is sensed by a frequency discriminator which is coupled to the output of the second broad-band amplifier. This develops an analog signal from which coarse positioning of the tuning and loading components is accomplished. The output of both the driver and the final are sampled by phase detectors and compared with their input signals for a precise determination of resonance. This provides fine tuning adjustments for the plate tank circuit of the driver and final. Final amplifier loading is controlled by sensing the voltage gain of the output stage.

DC SERVO SYSTEMS: The input to the servo system is an operational amplifier with a feedback loop to shape the system response to an error signal. This method of response shaping reduces the system cost and complexity by replacing the tachometer generator with minor electrical components. The servo power amplifier is a direct coupled solid state DC proportional amplifier with a transistor bridge output which provides high efficiency and dynamic braking.

Use of direct-drive DC torque motors provide system stability due to the high torque to inertia ratio (Ta/Ja). Because the motors are directly coupled to the shafts there is no dead zone caused by gear backlash. Since there are no gears involved, and the motors turn at a relatively slow speed, no slip clutch is required.

RF INPUT: A unique light sensitive resistor and DC amplifier circuit in the input stage provides superior gain control while minimizing effects of distortion normally associated with less well isolated control circuits. A single type 8321/4CX350A, a second Class A amplifier, also operates completely broad-band. The interstage networks up to and including the input to the driver amplifier are broad-banded and therefore do not require servo tuning.

DRIVER AND FINAL AMPLIFIER: A pair of 8321/4CX350A's, followed by an 8171/4CX10,000D are operated Class AB₁ in a grounded screen configuration for maximum stability. The grid drive network and plate tank circuits are automatically tuned to resonance by DC control amplifiers and torque motors. The output tuning and loading network is a pi-L filter designed for optimum harmonic rejection and load matching ability. This circuit is capable of matching into a 3:1 VSWR at a full rated power, with optimum loading obtained by the third DC motor and servo system.

RF PROTECTIVE DEVICES: All stages of the amplifier are protected against overloading and/or overdriving. The driver input is protected by grid leak biasing. An anode dissipation limiter is utilized to protect the PA from excessive dissipation.

10 kW Automatically Tuned ISB HF Transmitter—Star-10

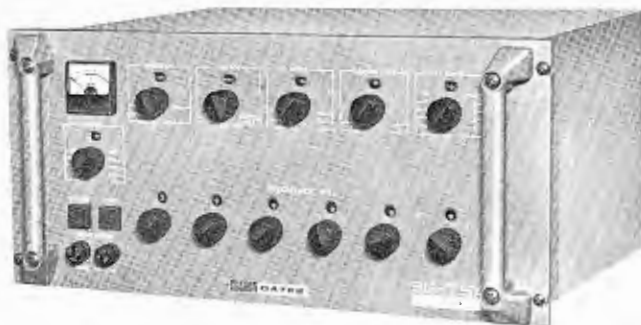

The SG-75A solid state synthesized exciter features front panel selection of 280,000 frequencies in the 2 to 30 MHz range. It operates in the ISB, LSB, USB, AME, CW and FSK modes.

The PA tube and plate supply are protected from current overload by a fast acting relay. A reflected power detector is used to unkey the amplifier and trigger an "excessive SWR" alarm. This protects the final stage against the effects of an SWR which exceeds 3:1.

ENCLOSURE: The entire ATL-10 linear amplifier is contained in a single enclosure measuring 40" wide, 69" high and 27" deep. The power supply is designed for immediate access from the front to all components. The servo control drawer is removable from the front panel and can be serviced while the amplifier is operating. The driver amplifier is also removable as a module for bench servicing. The final grid compartment as well as the final amplifier compartment are enclosed in air tight, RF tight enclosures, in which the cover panels may be removed for direct access.

COOLING: The air for cooling the ATL-10 amplifier is normally brought in through a filtered intake at the front or back of the cabinet. A blower forces the air up through the driver plenum, and into the power amplifier compartment. The majority of the air flows directly through the 8171/4CX-10,000D. The remainder of the air is used to circulate through the PA compartment. All air is exhausted horizontally at the top rear of the cabinet. The ATL-10A has a front air intake, and the ATL-10B has a rear air intake—otherwise the two amplifiers are identical.

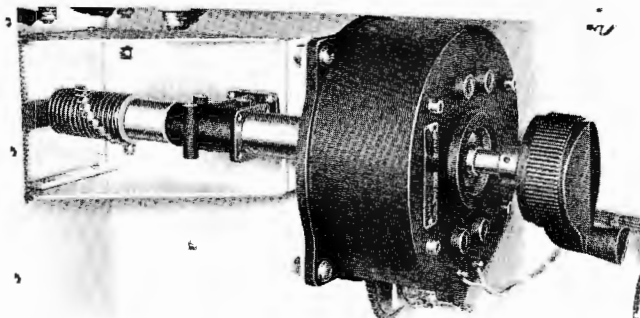

High torque DC servo motors direct coupled to PA circuits assure tuning accuracy. Reliability is enhanced through Gates design using fewer components.

SPECIFICATIONS

FREQUENCY RANGE: 29.9999 MHz in 100 Hz steps (280,000 frequencies).

OPERATING MODES AND RATED POWER OUTPUT:

| | |
|--------------------------|-------------|
| CW (A ₀ , A1) | 10 kW (av.) |
| FSK (F1) | 10 kW (av.) |
| AME (A3h) | 10 kW PEP |
| USB, LSB (A3a, j) | 10 kW PEP |
| ISB (A3b) | 10 kW PEP |

FREQUENCY CONTROL: Digital control of stabilized VFO, synthesized.

OUTPUT IMPEDANCE: 50 ohms with VSWR up to 3:1.

GAIN CONTROL: Automatic with manual override.

LOAD CONTROL: Peak power control.

TUNING TIME: 25 seconds maximum.

METHOD OF TUNING: Automatic, remote.

HARMONIC OUTPUT: 2nd, 56 dB below full output. All others, 60 dB.

SIGNAL TO NOISE RATIO: 50 dB.

SIGNAL TO DISTORTION RATIO: 40 dB. (Distortion products: At rated output at least 40 dB below either tone of a standard two-tone test signal up to 26 MHz and 36 dB 26 to 30 MHz).

CARRIER LEVEL: Selectable: 0, -6, -20, -55 dB, or 0, -6, -16, -26, -55 dB.

CARRIER COMPRESSION: 1 dB maximum.

STABILITY: 1×10^{-7} per day (optional 5×10^{-9} per day).

UNWANTED SIDEBAND REJECTION: 60 dB at 500 Hz.

AUDIO INPUT: Two independent 600 ohm channels balanced or unbalanced, with independent AGC, -20 to +10 dBm for full RF output.

AUDIO FREQUENCY RESPONSE: 250 to 3000 Hz or 250 to 6000 Hz, with 3 dB maximum ripple.

FSK CAPABILITY: Wideband FSK built in, adjustable from ± 400 to ± 425 Hz (other shifts optional).

POWER INPUT: 200, 210, 220, 230, 240, 250 volts, $\pm 10\%$, 3 phase, 47-63 Hz, 24 kVA at 0.95 power factor at 10 kW CW.

TEMPERATURE: 0° to +50°C.

HUMIDITY: 0 to 95%.

ALTITUDE: Sea level to 10,000 feet.

OUTPUT CONNECTOR: 1 1/2" EIA flange.

OPTIONAL REMOTE CONTROL: Available.

COMPONENTS: All components meet MIL specifications where practicable.

SIZE: Amplifier, 69" high, 40" wide, 27" deep. Exciter, 8 3/4" high, 19" wide, 17" deep. (Exciter rack optional.)

WEIGHT: Amplifier; net 1300 lbs., domestic pack 1545 lbs., export pack 1700 lbs. Cubage: 88.7 cubic feet. Exciter: net 56 lbs., domestic pack 75 lbs., export pack 110 lbs. Cubage: 6 cubic feet.

ORDERING INFORMATION

STAR-10 ISB HF Transmitter, with tubes and silicon rectifiers.....994-6566
100% tube kit.....990-0574

HARRIS
GATES DIVISION
Harris-Intertec Corporation

1000 Watt ISB HF Transmitter



MODEL ST-1A

A continuous duty sideband transmitter, the ST-1A is conservatively rated at 1000 watts CW as well as PEP. Powers up to 1500 watts (50% overload) may be handled on an intermittent basis without damage to the equipment. The ST-1A is continuously tunable over the entire 2 to 32 MHz range. All tuning can be accomplished in less than two minutes by means of convenient front panel controls.

Designed for operation on any one of 10 crystal controlled channels, with all tuning accomplished by only seven front panel controls and one band switch. The ST-1A will transmit USB, LSB, ISB, AME, CW, MCW and FSK with adapter. Third order distortion products are at least 35 dB below the level one tone of a two-tone test. At maximum power, each of the two independent sidebands has a full 6 kHz capability.

Easy access to all components is assured with modular and tilt-over slide out construction used in the compact ST-1A. Maximum attention has been given to efficient cooling for the entire transmitter.

Exceptional frequency stability has been achieved by using a crystal oven containing a transistorized master frequency oscillator. Generator stability of two parts in 10^{-7} is approached at 32 MHz. Data and teletype tone transmission is possible since absolute drift never exceeds 8 Hz at any point in the operating spectrum.

A directional coupler and meter are provided in the ST-1A as standard equipment for power indications. Gates directional watt meter uses two separate circuits to measure forward and reflected RF power in the 50 ohm transmission line.

SPECIFICATIONS

FREQUENCY RANGE: 2-32 MHz continuous, band switched.

POWER OUTPUT: 1000 watts PEP, 1000 watts CW, continuous.

OUTPUT IMPEDANCE: 50 ohms; will match a VSWR up to 2:1.

OPERATING MODES: USB, LSB, ISB, AME, CW, MCW, FSK with external adapter.

FREQUENCY CONTROL: Temperature controlled crystals, or optional external VFO or synthesizer.

CRYSTAL POSITIONS: 10. Selectable from front panel, with independent trimmer, or synthesizer.

STABILITY: Better than 1 PPM per day.

CARRIER SUPPRESSION: 0 to -50 dB.

SIGNAL TO DISTORTION RATIO: 35 dB. (Distortion products: At rated output, 3rd and higher order products are at least 35 dB below either tone of a standard two-tone test signal.)

SIGNAL TO NOISE RATIO: 50 dB.

UNWANTED SIDEBAND REJECTION: 60 dB at 500 Hz.

HARMONICS: Second harmonic, at least 40 dB down; all higher order harmonics, at least 50 dB down.

AUDIO INPUT: Two independent 600 ohm channels balanced or unbalanced. -12 dBm for full RF output. One high impedance mic channel requiring 1 mV for full PEP.

AUDIO RESPONSE: 250 to 6350 Hz with 3 dB maximum ripple. Other bandwidths available.

AUTOMATIC LOAD CONTROL: Provided to limit distortion during high-drive peaks or load changes.

ENVIRONMENTAL: 0° to +50°C operating, or -50° to +70° C non-operating.

POWER CONSUMPTION: Key down CW 3.45 kw, @ approximately 90% power factor.

POWER INPUT: 115/230 volts, single phase, 3 wire, 50/60 Hz.

SIZE: Over-all with optional cabinet: 21" wide, 33½" high, 23½" deep. Amplifier: 12¾" high, standard 19" rack mount. Power supply: 8¾" high, standard 19" rack mount. Exciter: 8¾" high, standard 19" rack mount.

WEIGHT: 375 lbs. net. Domestic packed: 500 lbs. Export packed: 600 lbs. Cubage: 14 cubic feet.

ORDERING INFORMATION

ST-1A ISB HF communications transmitter with tubes and silicon rectifiers, less cabinet.....994-6418
Complete set of spare tubes.....990-0519
Optional ST-1A transmitter cabinet.....952-5967

HARRIS
GATES DIVISION
Harris-InterType Corporation

3000 Watt ISB HF Transmitter



MODEL ST-3A

Gates offers an ISB transmitter with unexcelled performance for high frequency communications service in either fixed station or transportable operation. Conservatively rated at 3000 watts average as well as 3000 watts PEP, the ST-3A transmitter provides SSB, ISB, AME, CW, MCW, and FSK modes of operation.

The ST-3A is a complete transmitter consisting of the SG-70 ISB Exciter, power amplifier and solid state power supply, all in one extremely accessible cabinet.

Designed for operation on any one of 10 crystal controlled frequencies, all tuning is accomplished by only six front panel controls and one channel selector covering the 2 to 30 MHz frequency range.

Mode switches select operation on upper, lower or both sidebands. At maximum power, each of the two independent sidebands has a full 6 kHz capability. Flat crystal filter response provides the capability of effectively multiplexing four 3 kHz channels for voice and teletype communications. Third order distortion products are at least 40 dB below the level of one tone of a two tone test.

The ST-3A transmitter has been designed to provide accurate and rapid tuning. A compact and efficient turret tuner is used to switch each of the 10 crystal controlled positions into one of the 15 frequency bands. This permits tuning the transmitter to a pre-logged frequency, usually within one minute, and at widest extremes, no more than two minutes.

SPECIFICATIONS

FREQUENCY RANGE: 2-30 MHz continuous, band switched.
POWER OUTPUT: 3000 watts PEP, 3000 watts CW, continuous.
OUTPUT IMPEDANCE: 50 ohms; will match a VSWR up to 3:1.
OPERATING MODES: USB, LSB, ISB, AME, CW, MCW, and FSK with external adapter.
FREQUENCY CONTROL: Temperature controlled crystals or optional external VFO or synthesizer.
CRYSTAL POSITIONS: 10; selectable from front panel, with independent trimmer, or synthesizer.
STABILITY: Better than 1 PPM per day.
CARRIER SUPPRESSION: 0 to -50 dB.
SIGNAL TO DISTORTION RATIO: 40 dB. (Distortion Products: At rated output, 3rd and higher order distortion products are at least 40 dB below either tone of a standard two-tone test signal.)
SIGNAL TO NOISE RATIO: 50 dB.
UNWANTED SIDEBAND REJECTION: 60 dB at 500 Hz.

HARMONICS: Second harmonic, at least 50 dB down; all higher order harmonics, at least 60 dB down. Optional filter available.
AUDIO INPUT: Two independent 600 ohm channels balanced or unbalanced. -12 dBm for full RF output. One high impedance mic channel requiring 1 mV for full PEP.
AUDIO RESPONSE: 250 to 6350 Hz with 3 dB maximum ripple. Other bandwidths available.
AUTOMATIC LOAD CONTROL: Provided to limit distortion during high drive peaks or load changes.
ENVIRONMENTAL: 0° to +50°C operating, or -50° to +70°C non-operating.
POWER CONSUMPTION: Key down CW 7.5 kW, @ approx. 90% Power Factor.
POWER INPUT: 208/230/240 volts ±5% 50/60 Hz, 3-phase 3 or 4 wire, plus 115/230 volts, 2 wire.
SIZE: 22" Wide, 72" High, 24" Deep.
WEIGHT: 800 lbs. net. Domestic packed: 925 lbs. Export packed: 975 lbs. Cubage: 41 cubic feet.

ORDERING INFORMATION

| | |
|---|-----------|
| ST-3A 3 kW ISB Transmitter with tubes, silicon rectifiers, less crystals..... | 994-6492 |
| ST-3A (same as above) with 78 dB factory installed harmonic filter..... | 994-6492B |
| Spare tube kit for above..... | 990-0520 |
| HFT-5K 5 kW balun to match 50 ohms to 600 ohms..... | 478-0246 |
| Roll out base for ST-3A transmitter..... | 994-6477 |

HARRIS
GATES DIVISION
Harris-Intertype Corporation

1000 Watt HF Linear Amplifier

MODEL HFL-1000

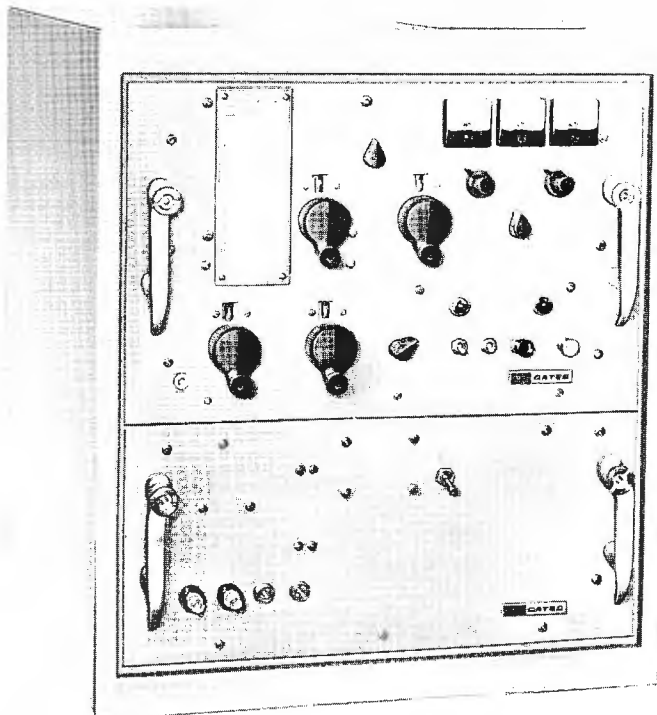

Gates HFL-1000 Linear Amplifier at 1000 watts PEP or 1000 watts CW is the smallest, completely self-contained amplifier in its power class. It features 90° tilt type slide mounting for the amplifier and a slide-out power supply which provides complete front panel servicing. Air intake is at the rear of the unit. The amplifier exhaust is on top, and the power supply exhaust is in the rear. The amplifier is designed to operate between 2.0 and 32 MHz and is capable of any type emission not exceeding its power and bandwidth capabilities. The final amplifier is operated class AB₁ at all times.

Ample metering is employed in the HFL-1000 linear amplifier to facilitate tuning and maintenance. A directional coupler with meter is provided as standard equipment for measuring forward or reflected power. The amplifier can be tuned and loaded to full rated output on any operating frequency, using only front panel controls. Tuning is continuous over the entire range without changing components. No air capacitors are used for tuning or loading. Loading is accomplished with band switched ceramic capacitors and a variable vacuum capacitor. Silicon rectifiers are used in all power supplies.

The amplifier and power supply may be mounted in any standard 19" relay rack, or in an optional cabinet.

The amplifier and power supply are manufactured for a wide range of temperature and humidity conditions and can be operated at altitudes up to 10,000 feet above sea level on a continuous basis.

SPECIFICATIONS

FREQUENCY RANGE: 2-32 MHz.

POWER OUTPUT: 1000 watts PEP, 1000 watts CW, continuous.

OUTPUT IMPEDANCE: 50 ohms; will match a VSWR up to 2:1.

OUTPUT CONNECTOR: Type UHF.

RF INPUT POWER: Less than 100 milliwatts driving power to obtain full rated output.

INPUT IMPEDANCE: 50 ohms, nominal.

INPUT CONNECTOR: Type BNC.

BANDWIDTH: 16 kHz or more to the 1 dB point.

HARMONICS: Second harmonic, at least 40 dB down; all higher order harmonics, at least 50 dB down.

SIGNAL TO DISTORTION RATIO: Capable of 35 dB. (Distortion products: At rated output, 3rd and higher order distortion products are at least 35 dB below either tone of a standard two-tone test signal.)

TUNING: Only four tuning controls, all on front panel and 1 band switch.

TUNING TIME: Maximum time required to change frequency between any two previously logged operating frequencies—two minutes.

AUTOMATIC LOAD CONTROL: Provided to limit distortion during high drive peaks or load changes.

POWER SUPPLY: Solid state.

DUTY CYCLE: Continuous at full rated output throughout the full environmental range specified.

ENVIRONMENTAL: 0° to +50°C; 0 to 95% humidity from sea level to 10,000 feet.

POWER INPUT: 115/230 volts, single phase, 3 wire, 50/60 Hz.

POWER CONSUMPTION: Key down CW 3.31 kW @ approximately 90% power factor.

SIZE: Amplifier, 12¼" high x 19" wide. Power supply, 8¾" high x 19" wide.

WEIGHT: 280 lbs. net; 350 lbs. export packed. Cubage: 8 cubic feet.

ORDERING INFORMATION

HFL-1000 1 kW linear amplifier with tubes and silicon rectifiers, less cabinet.....994-6161
Cabinet for HFL-1000.....952-5894
100% spare tube kit.....990-0447

HARRIS
GATES DIVISION
Harris-InterType Corporation

3000 Watt HF Linear Amplifier

MODEL HFL-3000

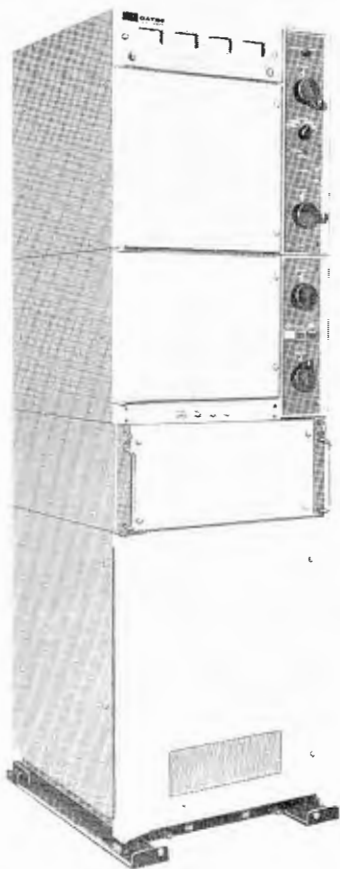

HFL-3000A

The Gates HFL-3000 linear amplifier is rated at 3000 watts CW/PEP, and is designed to operate between 2 and 30 MHz. It features continuously variable tuning over the entire range and may be excited by any suitable generating equipment delivering 100 mW of power into 50 ohms. Any type of emission not exceeding the amplifier power output or bandwidth ratings is possible.

Important where compactness is desired, such as in multi-transmitter operations or portable installation, the total size of the 3000 watt unit, including self-contained power supply, is only 72" high, 22" wide, and 24" deep. Designed for operation at altitudes up to 10,000 feet on a continuous basis.

The power amplifier operates class AB₁ for all modes of emission. A 4CX3000A power tetrode is used as the final amplifier of the HFL-3000. The amplifier may be quickly tuned and loaded to full rated output at any operating frequency between 2-30 MHz by front panel controls. RF feedback is employed. A directional coupler and meter are provided as standard equipment for measuring either forward or reflected power.

The Gates HFL-3000 RF linear amplifier may be remote controlled through its normal start-stop functions up to nominal distances of several hundred feet.

SPECIFICATIONS

FREQUENCY RANGE: 2-30 MHz.

POWER OUTPUT: 3000 watts PEP, 3000 watts CW, continuous.

OUTPUT IMPEDANCE: 50 ohms; will match a VSWR up to 3:1.

OUTPUT CONNECTOR: Type LC.

RF INPUT POWER: Less than 100 milliwatts driving power to obtain full rated output.

INPUT IMPEDANCE: 50 ohms, nominal.

INPUT CONNECTOR: Type BNC.

BANDWIDTH: 16 kHz or more to the 1 dB point.

HARMONICS: Second harmonic, at least 50 dB down; all higher order harmonics, at least 60 dB down. Optional 78 dB filter available.

SIGNAL TO DISTORTION RATIO: Capable of 40 dB. (Distortion products: At rated output, 3rd and higher order distortion products are at least 40 dB below either tone of a standard two-tone test signal.)

SIGNAL TO NOISE RATIO: 50 dB.

TUNING: Only four tuning controls, all on front panel.

TUNING TIME: Maximum time required to change frequency between any two previously logged operating frequencies—two minutes.

AUTOMATIC LOAD CONTROL: Provided to limit distortion during high drive peaks or load changes.

DUTY CYCLE: Continuous at full rated output throughout the full environmental range specified.

ENVIRONMENTAL: 0° to +50°C; 0 to 95% humidity from sea level to 10,000 feet.

POWER INPUT: 208/230/240 volts $\pm 5\%$, 50/60 Hz, 3-phase, 3 or 4 wire, plus 115/230 volts, 2 wire.

POWER CONSUMPTION: Key down CW 7.45 kW @ approximately 90% power factor.

SIZE: 22" wide, 24" deep, 72" high.

WEIGHT: 660 lbs. net; 930 lbs. export packed. Cubage: 61.4 cubic feet.

ORDERING INFORMATION

| | |
|--|-----------|
| HFL-3000A 3 kW linear amplifier complete with tubes, silicon rectifiers, less roll out base... | 994-6466A |
| HFL-3000B with optional filter... | 994-6466B |
| Roll out base for HFL-3000... | 994-6477 |
| Spare tube kit | 990-0531 |

Transmitter Control

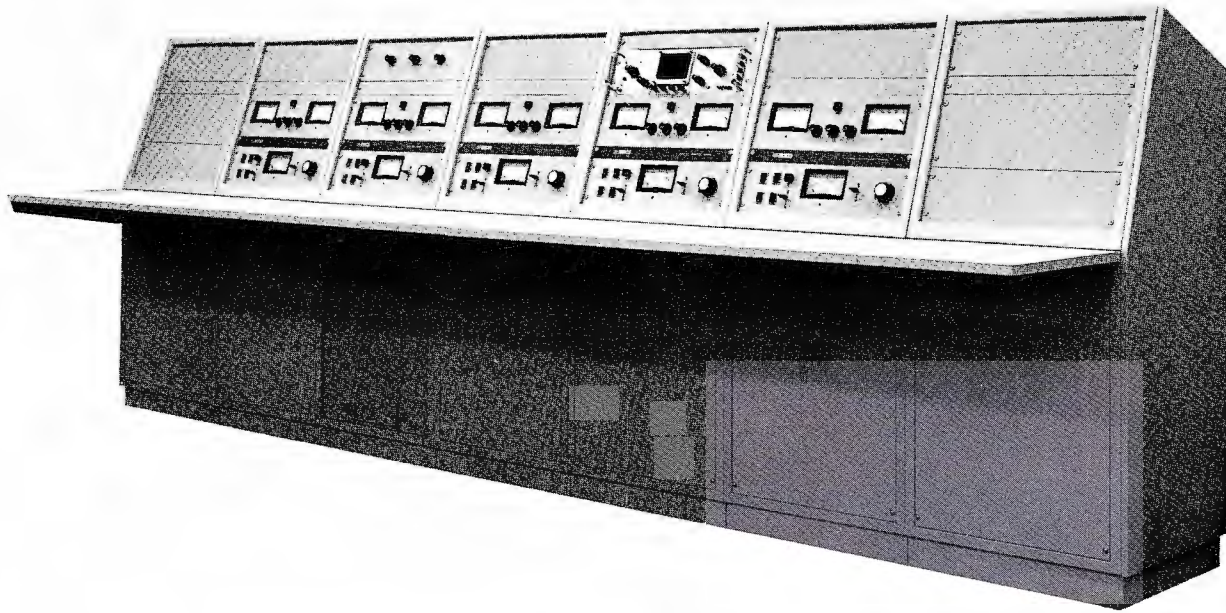

**MULTI-TRANSMITTER
CONTROL CONSOLE**

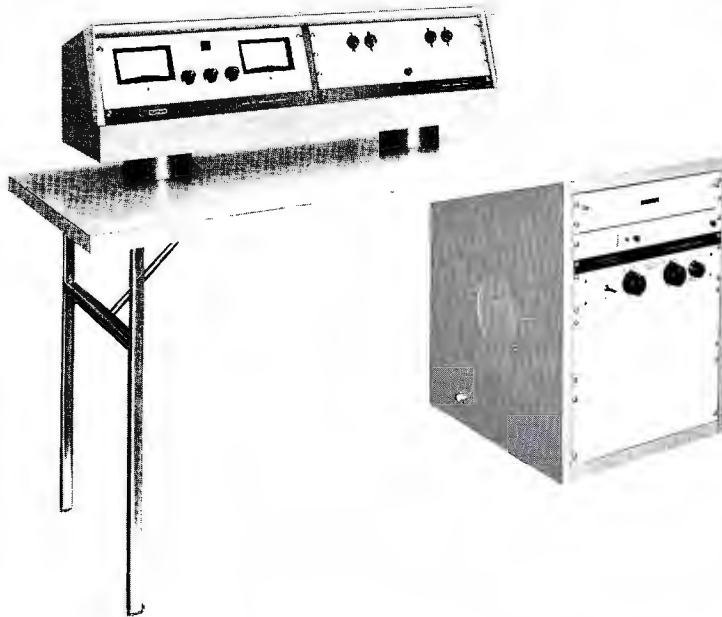

**SINGLE TRANSMITTER
CONTROL CONSOLE**

Transmitter control consoles are designed for use with any medium wave or short wave transmitter(s) to provide a convenient and centralized "control center" to operate the transmitter(s). Gates can build consoles for high powered 50 kW or 100 kW transmitters, or for any special application. Also, Gates' transmitter control consoles can be designed to handle a single transmitter, or for multi-transmitter control. For instance, the console at the top of the page was specially built to control seven 100 kW short wave transmitters. Specifications at right are for a typical single transmitter control console.

TYPICAL SPECIFICATIONS

AUDIO INPUTS: Three 600 ohm channels provided with line isolation transformers.

OUTPUT: 600 ohms.

MASTER GAIN: Balanced 30 steps, 1.5 dB per step.

VU METER: 4" square case with range control.

MODULATION METER: 4" square case illuminated.

PUSHBUTTONS: Four pairs provided for transmitter start-stop functions.

PILOT LIGHTS: Indicate transmitter filament and plate on.

FINISH: Medium hand rubbed gloss gray with escutcheons in black.

**REMOTE
CONTROL
EQUIPMENT**

HARRIS
 **GATES DIVISION**
Harris Intertype Corporation

Remote Control System

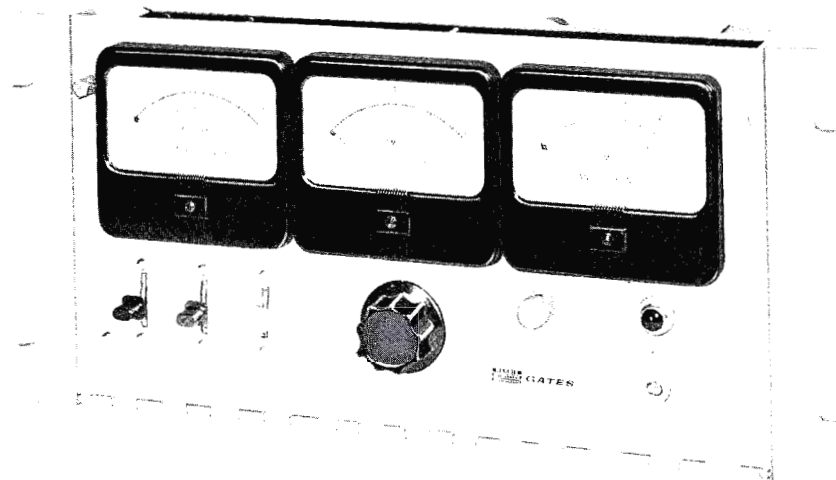

Fig. A. Studio unit provides complete metering and selection/operation of up to 23 control functions. Power supply is self-contained.

MODEL RDC-10AC

This Gates remote control equipment is a direct current system without tubes or transistors and has only one major moving part—the rugged gold contact stepper. Facilities are provided for as many as ten metering positions and 23 control functions. Capacity of the RDC-10AC equipment ranges from the one transmitter, one tower installation to a multi-tower directional system, as well as combination AM-FM separate transmitters with only one RDC-10AC system.

Standard equipment includes: (a) the studio control unit, Fig. A, (b) the transmitter control unit, Fig. B, (c) plate current and (d) plate voltage metering kits, plus (e) the tower light indicator unit. Studio and transmitter units are also available separately. Items (c), (d) and (e) are described on Page 187.

The studio control unit (Fig. A) has three large, easy-to-read meters that indicate plate voltage, plate current and AM antenna current or FM output. The meters may be switched

to several circuits on one or two transmitters, coupling units, etc. As an example, the tower light function can be indicated on the plate current meter. Many combinations are possible with the selection of the proper accessories as listed on Page 187. Relays are of highest quality to assure freedom from malfunction. A switch is provided on the transmitter control unit to transfer operation back to manual during transmitter maintenance or servicing.

Only two metallic telephone pairs are required. Usually the order phone between studio and transmitter is connected to one of the remote functions to eliminate the need for a third order phone line. The RDC-10AC system will operate on telephone lines up to 30 miles in length, or with 3000 ohms loop resistance, whichever is greater. Both studio and transmitter units are 19" wide, 8¾" high and 10" deep. Front panels drop down for easier servicing. Shipping weight: domestic, 50 lbs.; export, 85 lbs. Cubage: 4 cubic feet.

ORDERING INFORMATION

- (A) Complete RDC-10AC system includes studio and transmitter units and items I, J and K below..... 994-5862-001
- (B) Studio and transmitter units only..... 994-5862-002
- (C) Antenna diode to remote control antenna meter..... 994-6112
- (D) Motor driven rheostat for power control of 250 watt transmitter..... 994-4703-001
- (E) Motor driven rheostat for power control of 500 watt transmitter..... 994-4703-002
- (F) Motor driven rheostat for power control of 1000 watt transmitter..... 994-4703-003
- (G) Motor assembly to drive variable coil for load power adjustment such as for 5 kW or 10 kW transmitters. (Relay below necessary)..... 994-5066
- (H) Relay assembly to operate 994-5066 motor..... 994-4806
- (I) Plate current unit to extend plate current readings..... 994-4720
- (J) Plate voltage unit to extend plate voltage readings..... 994-4719
- (K) Tower light indicator..... 994-5145

IMPORTANT: When ordering, give as much transmitter detail as possible: (a) make and type number, (b) plate rheostat in ohms and watts. If not a Gates transmitter, state method of power output control such as rheostat, variable loading, etc. If you are in doubt, please contact us. Gates will gladly assist.

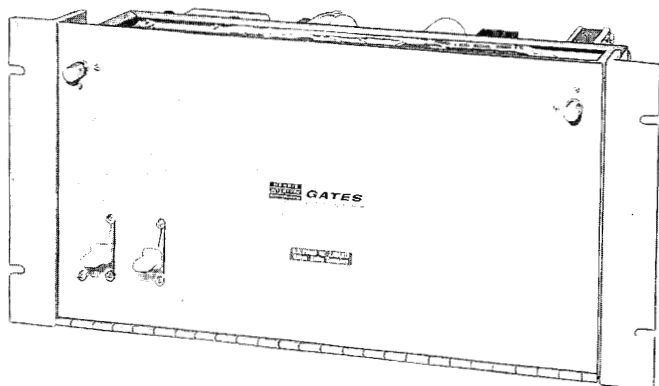

Fig. B. Transmitter unit may mount in a rack, or directly in most transmitters. Power supply is self-contained.

Remote Control System Accessories

*Chain
454-0019-000*

FREQUENCY MONITOR EXTENSION METER



For M-6698, M-6865 and M-4990 AM Frequency Monitors. For extending frequency indication to studios.

- Meter for M-6698 ----- 994-6863
- Meter for M-6865 ----- 994-6864
- Meter for M-4990 ----- 994-5631

MODULATION MONITOR EXTENSION METERS



Several types available as listed below for extending modulation monitors. Mounted on standard 19" rack panel.

- Remote meter for M-6659 modulation monitor ----- 994-6687
- Remote meter for M-5774 modulation monitor ----- 994-5836B
- Remote meter for M-5693 modulation monitor ----- 994-5837

AUXILIARY RELAY ASSEMBLY



Auxiliary relay assembly provides one on-off momentary switching facility. These relays provide two sets of double pole double throw contacts rated at 8 amperes, 115 volts AC.

- Auxiliary relay assembly ----- 994-5249
- Same as above but latching (holding) type with 10 ampere contacts ----- 994-5248

OUTPUT LOADING CONTROL KITS

Complete kits to control output loading of Gates' BC-5P-2 and BC-5H 5 kW transmitters. Kits include motor, relay and all necessary mounting hardware.

- Kit for BC-5P-2 ----- 994-4848B
- Kit for BC-5H ----- 994-6548

MOTOR OPERATED RHEOSTAT

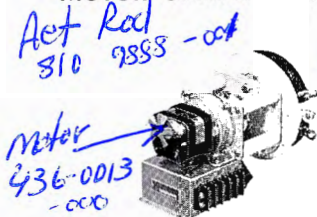

Act Rod 310 9888-001
Meter 436-0013-000
Rheostat 552-8411-000
U Joints 914-3468-006 914-3465-007

Recommended for regulating the plate voltage in transmitters of 1 kW and less. Available in three sizes for 250, 500 and 1000 watt transmitters. Motor is one rpm and operates from 115 volts, 60 Hz.

- Motor Rheostat for 250 watts ----- 994-4703A
- Motor Rheostat for 500 watts ----- 994-4703B
- Motor Rheostat for 1 kW ----- 994-4703C
- Motor Control for Rheostat in BC-500G and BC-IG ----- 994-6326

TUNING MOTOR

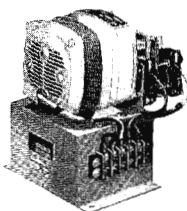

This unit for tuning variable inductor, capacitor or other controls, has built-in limit switches. Five wire reversible motor 1 rpm. Requires M-4806 relay assembly for control. 115 volt, 50/60 Hz.

- Tuning Motor ----- 994-5066

TUNING MOTOR ASSEMBLY

For operating rheostat, variable condenser, or any variable control. Three wire reversible motor 1 rpm. Torque 15 lb.-inches. 115 volts, 50/60 Hz.

- Tuning Motor ----- 994-4800

AC RECTIFIER

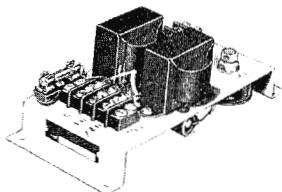

Rectifies the AC voltage, either line or filament, at the transmitter, and feeds back DC to studio unit for measuring AC by remote control.

- AC Voltage Unit ----- 994-4825

PLATE CURRENT UNIT

Included with the Gates remote control system. Furnishes a sample of plate current which is returned to the studio unit and measured on the directly calibrated plate current meter. The unit is provided with a high voltage protective fuse, and can be used for current ranges of 0-0.8 and 0-3 amperes. Units can be used in parallel if higher current range is required.

- Plate Current Unit ----- 994-4720A

TOWER LIGHT UNIT

This unit is used to provide a DC voltage for indication of proper tower light operation. Includes current transformer.

- Tower Light Metering Kit ----- 994-5145

RF DIODE UNIT

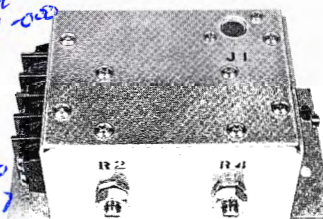

The M-6112 RF diode unit is designed for use as a remote RF indicating device in standard broadcast installations for sampling base currents or common point currents. It is not a directly calibrated RF ammeter, but is adjustable to indicate current linearity with the RF meter. It is not necessary to break the lead to the antenna to install the unit. The M-6112 RF diode consists of an inductive loop which is attached to a rectifier assembly, and is also clamped to the antenna lead. The M-6112 is a solid state device and requires no AC power.

- POWER RANGE: 250 to 50,000 watts.
- FREQUENCY RANGE: 540 to 1600 kHz.
- RF Diode Unit ----- 994-6112

OVERLOAD RELAY

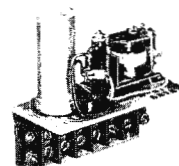

Replaces circuit breakers in current or older models, as circuit breakers are usually undependable for remote control. Tripping current adjustable. Inserted in cathode circuit of RF power amplifier. Some engineers prefer an additional unit in modulator circuit.

- Overload Relay ----- 994-5129

FM OUTPUT INDICATOR

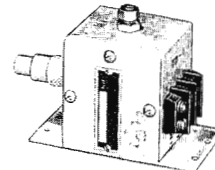

Designed to sample the 50 ohm transmission line of an FM transmitter for measuring transmitter output as required by FCC. Provides a DC voltage which is measured on the studio unit meter system. Solid state. Requires no AC power.

- FM Output Indicator ----- 994-4845

PLATE VOLTAGE UNIT

Supplied with Gates remote control systems. One unit is used with voltages up to and including 6000 volts. For higher voltages, additional units may be connected in series. Also available as an accessory item for metering additional stages of transmitters.

- Plate Voltage Unit ----- 994-4719A



Studio-Transmitter Link—890-960 MHz



The Models PCL-303 and PCL-303/C Studio-Transmitter Links (STL) provide high-quality audio between a broadcast studio and a remote transmitting site.

They have been developed specifically for application in broadcast service. Designed for continuous service, they operate in accordance with Subpart E, Part 74, of the FCC Rules and Regulations and are available for all STL bands—domestic and foreign.

Monaural programming may be relayed by the Model PCL-303. For stereo program applications (2) STL configurations are available. First, using the PCL-303, separate systems may be used for left and right audio feeds. This is typically referred to as the dual configuration. Second, the Model PCL-303 Stroke C Composite Studio-Transmitter Link makes possible a single system application to studio program feeds. With the stereo generator physically located at the studio, this link relays the full composite wave form to the wide band input of a direct exciter.

From the operational maintenance standpoint, multicircuit metering has been provided. Utilizing front panel meters, all significant circuits can be measured at the turn of a knob. The equipment is furnished with rack-mounted slides for easy inspection. Interstage shielding is used where required, with

equipment covers—top and bottom—being provided for each unit.

TRANSMITTER: The true, direct FM principle of modulation is employed in these STL transmitters. To insure the required output frequency stability, a thoughtfully-engineered automatic frequency control (AFC) system is utilized. Here's how it works:

An extremely stable basic oscillator is modulated with a pair of variable capacitance (varicap) diodes. The frequency of this basic FM oscillator (approximately 78 MHz) is divided by 1024 using a binary divider chain which employs high-speed, integrated circuit (IC) elements.

This divided output is phase compared to the output of a reference crystal (oven-controlled) oscillator, and the resultant error voltage is used to phase lock the basic oscillator to the crystal. Low-frequency modulation components have negligible effect on the AFC lock as a result of the high-frequency division ratio (1024) employed in the basic oscillator. The phase-locked output of the direct FM basic oscillator is multiplied and power amplified; in the PCL-303 it is further tripled to the output frequency with a parametric multiplying diode. An RF cavity filter at the transmitter output attenuates spurious signals to at least 60 dB below rated power output, and

Studio-Transmitter Link—890-960 MHz

an integral sampling probe feeds a panel meter to continuously monitor relative output power.

An input audio filter removes unwanted program components above 17 kHz in the PCL-303. This effectively reduces the crosstalk (in all multiplex channels) which may be caused by spurious high-frequency noise in the program line. Due to the wide band characteristics of the PCL-303 Stroke C, the transmitter does not contain a low pass filter.

For the Model PCL-303 Transmitter standard, 75 microseconds pre-emphasis is incorporated in the program audio input. The PCL-303 Stroke C Composite Transmitter does not employ pre-emphasis, as these networks are located in the stereo generator. (2) BNC connectors mounted on the rear panel are available for the insertion of remote control and SCA sub-carriers. Provisions are also available for remote control operation of the STL transmitter.

RECEIVER: This is a conventional double-conversion, crystal-controlled, superheterodyne receiver with a self-contained, regulated power supply. Signals from the antenna input are passed through a five-cavity RF pre-selector which is used ahead of a low-noise, input mixer diode (Schottky barrier type).

The first IF (72 MHz) section consists of a three-stage FET amplifier employing AGC and designed for low noise and medium bandwidth characteristics. The second IF section (10.7 MHz) is an amplifier exhibiting exceptionally sharp skirts and linear phase characteristics. These characteristics are achieved by a ten-pole, active filter slightly overcoupled to give the desired response. Less distortion to high-frequency modulation components are insured by this design. The ratio detector affords better rejection of impulse noise and adjacent channel interference.

A low-noise, low-distortion, operational amplifier is employed in the audio section. All signal outputs are squelched by a carrier-operated relay. Contacts for external carrier alarm use from this relay are located on the rear of the chassis, as are the (2) BNC connectors providing the sub-carrier outputs. The Model PCL-303 Receiver utilizes a 17 kHz low-pass elliptical filter and 75 microsecond de-emphasis network in the audio section. A phase linear low-pass filter is used in the Model PCL-303 Stroke C Composite Receiver and prevents the control subcarriers from being rebroadcast. The filter does, however, allow for conveyance of a 67 kHz SCA signal as well as the full composite stereo wave form for direct rebroadcast without noticeable degradation.

MODEL PCL-303 SYSTEM SPECIFICATIONS

FREQUENCY RESPONSE: $\pm\frac{1}{2}$ dB from 30 Hz to 15,000 Hz.

DISTORTION: Less than 0.5% from 50 Hz to 15,000 Hz.

SIGNAL-TO-NOISE RATIO: Better than 68 dB (–65 dB for PCL-202) below 100% modulation.

MODULATION CAPABILITY: One program and two subcarrier channels.

PRIMARY POWER SOURCE: 120/240 VAC, $\pm 10\%$ 50-60 Hz.

PANEL SPACE REQUIRED: 5¼" x 19"—transmitter or receiver.

OPERATING SPECIFICATIONS

MODEL PCL-303 TRANSMITTER

TYPE: Direct FM.

RF OUTPUT: 7 watts minimum; 8 watts maximum into nominal 50 ohm load—Type N female connector.

FREQUENCY STABILITY: Better than 0.001% (0° to 55°C); Crystal mounted in temperature controlled oven.

MULTIPLICATION: 12 times basic oscillator frequency.

AM NOISE: Better than 75 dB below carrier reference.

DEVIATION: ± 40 kHz for 100% modulation.

SPURIOUS EMISSIONS: More than 60 dB below carrier.

AUDIO INPUT: 600 ohms balanced; +10 dBm for 100% modulation.

MULTIPLEX INPUTS: Two BNC connectors provided for subcarrier channels in 25-100 kHz spectrum; approximately 1.0 volt rms for 20% deviation.

SOLID-STATE DEVICES: All silicon: 15 transistors (JEDEC), 14 diodes, 5 varicaps, 11 IC's, 1 varactor.

POWER SUPPLY: Fully regulated, self-contained.

COOLING: Convection and forced.

DIMENSIONS: 5¼" x 19" x 16".

MODEL PCL-303 RECEIVER

TYPE: Superheterodyne—double conversion and crystal controlled.

ANTENNA INPUT: Nominal 50 ohms impedance—Type N female connector.

SENSITIVITY: Less than 3 microvolts for 20 dB quieting. Requires only 35 microvolt signal for 60 dB quieting.

SELECTIVITY: 200 kHz.

AUDIO OUTPUT: 600 ohms balanced; +10 dBm.

MULTIPLEX OUTPUTS: Two BNC connectors; 1.0 volt peak-to-peak per subcarrier for 20% subcarrier injection at transmitter.

SOLID-STATE DEVICES: All silicon; 19 diodes, 21 JEDEC registered transistors (18 bi-polar, 3 field effect), 1 IC.

POWER SUPPLY: Zener regulated—self-contained.

DIMENSIONS: 5¼" x 19" x 14".

Studio-Transmitter Link—942-960-MHZ

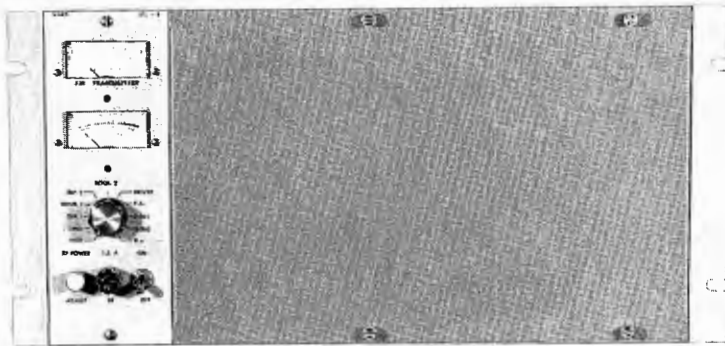

FM
TRANSMITTER

FM
RECEIVER

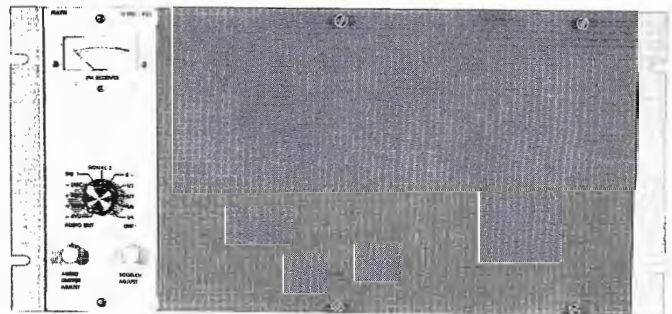

The STL and Remote Control equipment currently being manufactured is the most reliable and maintenance-free equipment ever produced. Use is made of the latest technology when clear advantages are realized, but unproven or marginal concepts and components are never used. Exhaustive time and testing is devoted to all products to insure that each design represents the simplest and most reliable answer to providing the necessary performance.

Due to the advancements made in the present day "state of the art" techniques relating to printed circuits, integrated circuits, solid-state components, and improved manufacturing methods, there is no reason whatever that this equipment could not be depended upon to operate reliably and satisfactorily for many years.

A close inspection of the many features of the solid-state STL system will reveal a Direct FM Modulator for extremely low Noise and Distortion characteristics and RF Sensing for Automatic Changeover to a "hot standby" system. Plug-in or bolt-in Modular construction allows fast and accurate diagnosis of circuit or component failure and is a means of quick replacement of the defective module from a limited number of spares.

High performance, maximum reliability and sensible cost are reflected in our "Dual" or "Split" channel approach to FM Stereo, whereby two transmitters and two receivers are used, each being combined into a common antenna system. This method assures two identical FM Broadcast-quality channels

with 65 dB Separation, maximum Signal-to-Noise Ratio, Phase Linearity, extremely Low Distortion and Flat Frequency Response.

These outstanding performance characteristics of the Stereo STL System, when coupled with the REDUNDANCY factor presented by the "Dual" channel system, make this the logical approach to STL. Program transmission and Control Circuits can be maintained, even though in a Mono mode of operation, and precious "lost air" time is no longer a consideration. The "Dual" channel concept allows the Stereo Generator to remain at the FM transmitter site, preventing continual adjustment from unauthorized and uninstructed personnel and eliminates the need for expensive interface equipment between the STL System and the FM Broadcast Transmitter. In addition, such problems as Separation can be more easily diagnosed when the Stereo Generator is not combined with the STL system.

We welcome your particular problem. For those of you who have clear un-obstructed microwave paths, you have only to purchase the necessary equipment for your particular application to immediately realize the benefits of STL. To those who have a path problem, we have the capability to help you work it out so that you too can reap the profits by using STL.

Present day economic factors make STL, Remote Control and Telemetry well worth looking at, particularly for the AM or FM Broadcaster who looks toward Broadcasting as an interesting and profitable future.

Studio-Transmitter Link—942-960-MHZ

Features . . .

- ★ Direct FM Modulator
- ★ All Solid-State
- ★ Field Proven Varactor Final
- ★ Plug-in Modular Construction
- ★ Solid-State Ovens and Hi-Accuracy Crystals
- ★ Automatic Change-over to Standby Transmitter
- ★ RF Sensing for "Out of Status" Alarm Indication
- ★ Current Limiting in Regulated Power Supply

System Specifications for AM Application:

FREQUENCY RESPONSE: ± 1.0 dB from 50 Hz to 12,500 Hz.
DISTORTION: 1% or less, 50 Hz to 12,500 Hz.
SIGNAL-TO-NOISE: -60 dB or better. Ref. 400 Hz, Mod. 100%.
CARRIER FREQUENCY STABILITY: $\pm .0005\%$.
TEMPERATURE RANGE: -30°C to $+60^{\circ}\text{C}$.

System Specifications for FM Application:

FREQUENCY RESPONSE: $\pm .5$ dB from 40 Hz to 15,000 Hz.
DISTORTION: 0.6% or less, 50 Hz to 15,000 Hz.
SIGNAL-TO-NOISE: -65 dB or better. Ref. 400 Hz, Mod. 100%.
CARRIER FREQUENCY STABILITY: $\pm .0005\%$.
TEMPERATURE RANGE: -30°C to $+60^{\circ}\text{C}$.

STL-8A SOLID STATE TRANSMITTER SPECIFICATIONS

For AM Broadcast Application

APPLICATION: Studio-Transmitter Link (AM) and Inter City Relay
CARRIER FREQUENCY RANGE: 942-960 MHz.
RF POWER OUTPUT: Maximum Licensed power 8 watts, nominal 6 watts. Set at factory.
OUTPUT IMPEDANCE: Nominal 50 ohms.
RF CARRIER CONNECTOR: UG-58A/U (Type N Female).
CARRIER FREQUENCY STABILITY: $\pm .0005\%$, -30°C $+60^{\circ}\text{C}$ ($+25^{\circ}\text{C}$ Ref.).
TYPE OF MODULATION: Direct FM 200F3. (200 F9 with remote control and/or Sub Carrier).
DEVIATION: ± 52.5 kHz (at 400 Hz).
AUDIO INPUT: Balanced 600 ohms, $+10$ dBm (± 2 dB) for 100% modulation.
MULTIPLEX INPUTS: Two BNC Connectors, for Remote Control and Sub-Carrier inputs. .5V RMS for 20% Carrier Deviation. 50 to 600 ohms max. unbalanced.
AUDIO RESPONSE: ± 1 dB, 50 Hz to 12,500 Hz.
DISTORTION: Less than 1% THD, 50 Hz to 12,500 Hz.
FM NOISE: Better than -60 dB below 100% Modulation (400 Hz Ref.).
AM NOISE: Better than -55 dB below carrier reference.
POWER REQUIREMENTS: 115/230 Volts 50-60 Hz. 110 watts.
AC POWER SUPPLY: Precision electronically regulated integrated circuit power supply with current limiting. Regulator circuitry contained in plug-in module.
SPURIOUS EMISSIONS: More than 60 dB below carrier.
OUTPUT FAILURE ALARM: Adjustable RF output sensing provides fail-safe contact closure for alarm or automatic switching as standard equipment.
REMOTE LOCATION: Terminals provide for simple remote off-on control of transmitter. Built-in RF sensing relay provides remote indication of transmitter status.
METERING: Precision taut-band meters for RF power and circuit testing.
COOLING: Advanced thermal design provides conduction, convection and forced air cooling from high quality fan.
SOLID-STATE DEVICES: 38 Solid-state silicon devices; 11 transistors, 3 varactor diodes, 21 diodes, 2 IC, 1 solid-state proportional temperature control oven.
DIMENSIONS: (Vertical) Panel 7" high x 8½" wide (half rack) x 15" deep. (Horizontal) 8¾" x 19" x 8¼".
WEIGHT: (Vertical) Transmitter 15.5 lbs. plus 10 lbs. for rack shelf adapter. Rack shelf adapter is 7" x 19". (Horizontal) 20 lbs.

STL-8F SOLID STATE TRANSMITTER SPECIFICATIONS

For FM Broadcast Application

APPLICATION: Studio-Transmitter Link, (FM)
CARRIER FREQUENCY RANGE: 942-960 MHz.
RF POWER OUTPUT: Maximum Licensed power 8 watts, nominal 6 watts. Set at factory.
OUTPUT IMPEDANCE: Nominal 50 ohms.
RF CARRIER CONNECTOR: UG-58A/U (Type N Female).
CARRIER FREQUENCY STABILITY: $\pm .0005\%$, -30°C $+60^{\circ}\text{C}$ ($+25^{\circ}\text{C}$ Ref.).
TYPE OF MODULATION: Direct FM 200F3. (200 F9 with remote control and/or Sub Carrier).
DEVIATION: ± 52.5 kHz.
AUDIO INPUT: Balanced 600 ohms, $+10$ dBm (± 2 dB) for 100% modulation.
MULTIPLEX INPUTS: Two BNC Connectors, for Remote Control and Sub-Carrier inputs. .5V RMS for 20% Carrier Deviation. 50 to 600 ohms unbalanced.
AUDIO RESPONSE: ± 0.5 dB, 40 Hz to 15,000 Hz.
DISTORTION: Less than 0.6% THD, 50 Hz to 15,000 Hz.
FM NOISE: Better than -65 dB below 100% Modulation (400 Hz Ref.).
AM NOISE: Better than -55 dB below carrier reference.
POWER REQUIREMENTS: 115/230 Volts 50-60 Hz. 110 watts.
AC POWER SUPPLY: Precision electronically regulated integrated circuit power supply with current limiting. Regulator circuitry contained in plug-in module.
SPURIOUS EMISSIONS: More than 60 dB below carrier.
OUTPUT FAILURE ALARM: Adjustable RF output sensing provides fail-safe contact closure for alarm or automatic switching as standard equipment.
REMOTE LOCATION: Terminals provide for simple remote off-on control of transmitter. Built-in RF sensing relay provides remote indication of transmitter status.
METERING: Precision taut-band meters for RF power and circuit testing.
COOLING: Advanced thermal design provides conduction, convection and forced air cooling from high quality fan.
SOLID-STATE DEVICES: 38 Solid-state silicon devices; 11 transistors, 3 varactor diodes, 21 diodes, 2 IC, 1 solid-state proportional temperature control oven.
DIMENSIONS: (Vertical) Panel 7" high x 8½" wide (half rack) x 15" deep. (Horizontal) 8¾" x 19" x 8¼".
WEIGHT: (Vertical) Transmitter 15.5 lbs. plus 10 lbs. for rack shelf adapter. Rack shelf adapter is 7" x 19". (Horizontal) 20 lbs.

Remote Pickup Equipment—150-450 MHz

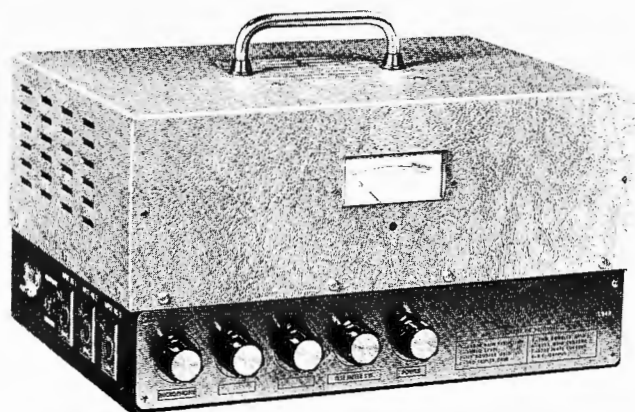

M-30BT

NOTE: The M-30BT/TPS and M-20BT/TPS are available with choice of inputs of either 3 microphones, (1 push-to-talk), or 2 microphones (1 push-to talk) and one 600 ohm line level input. Please specify choice of input configuration.

AVERAGE COVERAGE OVER FLAT TERRAIN OF M-30BT TRANSMITTER

| RECEIVING ANTENNA HEIGHT | ANTENNA COMBINATIONS | | EXPECTED COVERAGE IN MILES |
|--------------------------|--------------------------|----------------|----------------------------|
| | Receiving | Transmitting | |
| * 75 ft. | 5 Element Yagi | Single Ring | 9 |
| ** 150 ft. | 5 Element Yagi | Single Ring | 13 |
| * 75 ft. | Stacked 5 Element Yagi's | Single Ring | 11 |
| ** 150 ft. | Stacked 5 Element Yagi's | Single Ring | 15 |
| * 75 ft. | 5 Element Yagi | 5 Element Yagi | 14 |
| ** 150 ft. | 5 Element Yagi | 5 Element Yagi | 18 |
| * 75 ft. | Stacked 5 Element Yagi's | 5 Element Yagi | 16 |
| ** 150 ft. | Stacked 5 Element Yagi's | 5 Element Yagi | 20 |
| ** 150 ft. | RA-4 Antenna | Single Ring | 10 |
| *** 300 ft. | RA-4 Antenna | Single Ring | 14 |
| ** 150 ft. | RA-4 Antenna | 5 Element Yagi | 16 |
| *** 300 ft. | RA-4 Antenna | 5 Element Yagi | 20 |

The above measurements are based on a transmitting antenna height of 6 feet above surrounding objects.

CODE:

- * Measurement based on length of RG-8U Transmission Line not to exceed 80 ft.
- ** Measurement based on length of FHJ4 Transmission Line not to exceed 200 ft.
- *** Measurement based on length of 7/8" Heliac Line not to exceed 350 ft.

M-20BT SERIES TRANSMITTER

450-460 MHz

RF OUTPUT: 20 watts, continuous.
 FREQUENCY RANGE: 450-460 MHz.
 CRYSTAL MULTIPLICATION: 108.
 SPURIOUS EMISSION: Spurious radiation attenuated at least 60 dB below carrier level. Harmonics suppressed at least 60 dB.
 FREQUENCY STABILITY: $\pm 0.0005\%$.
 TEMPERATURE RANGE: -30°C to $+60^{\circ}\text{C}$.
 MODULATION: 100F3 Maximum. (Normally adjusted for ± 20 kHz swing.)
 AUDIO INPUTS: Three. One for push-to-talk mike. Two for 50-150 ohm mike inputs or 600 ohm line input.
 AUDIO INPUT LEVEL: -70 dB.
 AUDIO CONNECTORS: (2) XLR-3-31 and (1) XLR-4-31.
 POWER REQUIREMENTS: 120 VAC and 12.6 VDC. (DC Transistorized Power Supply.)
 MODULATION CONTROL: Solid State Compressor/Limiter.
 NOISE LEVEL OF TRANSMITTER: Better than -45 dB.
 OVERALL RESPONSE WITH MATCHED RECEIVER: ± 2 dB from 60 to 12,500 Hz.
 DISTORTION: Less than 3%.
 FREQUENCIES POSSIBLE: Two: Max. Spacing 500 kHz.
 NET WEIGHT: 17 pounds.
 DIMENSIONS: Portable: 14" wide, 10" long, 7" high. Rack Mounted: 19" wide, 10" long, 10 1/2" high.
 TUBE COMPLEMENT: 16 Transistors, 6 Diodes, 1 Varactor, 6 tubes.

M-30BT SERIES TRANSMITTER

152-172 MHz

RF OUTPUT: 30 watts, continuous.
 FREQUENCY: 152-172 MHz.
 CRYSTAL MULTIPLICATION: 36.
 SPURIOUS EMISSION: Spurious Radiation attenuated at least 70 dB below carrier level. Harmonics suppressed at least 60 dB.
 FREQUENCY STABILITY: $\pm 0.0005\%$.
 TEMPERATURE RANGE: -30°C to $+60^{\circ}\text{C}$.
 MODULATION: 30 F3 Maximum. (Normally adjusted for ± 7.5 kHz swing.)
 AUDIO INPUTS: Three. One for push-to-talk mike. Two for 50-150 ohm mike inputs or 600 ohm line input.
 AUDIO INPUT LEVEL: -70 dB.
 AUDIO CONNECTORS: (2) Cannon XLR-3-31 and (1) XLR-4-31.
 POWER REQUIREMENTS: 120 Volts AC or 12.6 Volts DC. (Transistorized)
 MODULATION CONTROL: Solid State Compressor/Limiter.
 NOISE LEVEL OF TRANSMITTER: Better than -45 dB.
 OVERALL RESPONSE WITH MATCHED RECEIVER: ± 2 dB from 60 to 7500 Hz.
 DISTORTION IN TRANSMITTER: Less than 3%.
 FREQUENCIES POSSIBLE: Two: Max. Spacing 120 kHz.
 NET WEIGHT: 16 pounds.
 DIMENSIONS: 14" wide, 10" long, and 7" high.
 TUBE COMPLEMENT: 16 Transistors, 6 Diodes, 6 Tubes.

Remote Pickup Equipment—150-450 MHz

R-30/150 RECEIVER

Mates with RPT-40 transmitter.*

CARRIER FREQUENCY RANGE: 150-172 MHz.
SENSITIVITY: 0.5 microvolt for 20 dB quieting.
INPUT IMPEDANCE: 50 ohms.
FREQUENCY STABILITY: $\pm 0.0005\%$, -30°C to $+60^{\circ}\text{C}$.
SELECTIVITY: 10.7/F30 filter module band width: 6 dB at ± 17.5 kHz, 60 dB at ± 22.0 kHz, 90 dB at ± 23.5 kHz, 100 dB + ultimate. (Optional filters available.)
SPURIOUS RESPONSE: At least -95 dB.
AUDIO OUTPUT: Balanced 600 ohms ± 10 dBm.
FREQUENCY RESPONSE: ± 1 dB, 50 Hz to 8000 Hz, when used with RPT-40 transmitter.
SQUELCH: Adjustable squelch provides audio muting, plus auxiliary contacts for external signal circuit.
POWER REQUIREMENTS: 115/230 VAC, 50/60 Hz, 30 watts.
METERING: Precision taut-band meter with front panel test selector switch.
 Tests signal strength, discriminator zero, power supply audio level.
DIMENSIONS: 8 $\frac{3}{4}$ " high x 19" wide x 8 $\frac{1}{4}$ " deep.
WEIGHT: Net 16 lbs., gross 20 lbs.
 *NOTE: With optional switchable equalizer unit this receiver will also mate with M-30/BT tube type transmitter.

R-50/450 RECEIVER

Mates with RPT-25 transmitter.*

CARRIER FREQUENCY RANGE: 450-470 MHz.
SENSITIVITY: 0.5 microvolt for 20 dB quieting.
INPUT IMPEDANCE: 50 ohms.
FREQUENCY STABILITY: $\pm 0.0005\%$, -30°C to $+60^{\circ}\text{C}$.
SELECTIVITY: 10.7/F50 filter module band width: 6 dB at ± 21 kHz, 60 dB at ± 28 kHz, 80 dB at ± 32 kHz, 100 dB + ultimate. (Optional filters available.)
SPURIOUS RESPONSE: At least -95 dB. (Better than -100 dB with optional pre-selector.)
AUDIO OUTPUT: Balanced 600 ohms ± 10 dBm.
FREQUENCY RESPONSE: ± 1 dB, 50 Hz to 10,500 Hz when used with RPT-25 transmitter.
SQUELCH: Adjustable squelch provides audio muting, plus auxiliary contacts for external signal circuit.
POWER REQUIREMENTS: 115/230 VAC, 50/60 Hz, 30 watts.
METERING: Precision taut-band meter with front panel test selector switch.
 Tests signal strength, discriminator zero, power supply, audio level.
DIMENSIONS: 8 $\frac{3}{4}$ " high x 19" wide x 8 $\frac{1}{4}$ " deep.
WEIGHT: Net 16 lbs., gross 20 lbs.
 *NOTE: With optional switchable equalizer unit this receiver will also mate with M-20BT tube type transmitter.

TYPICAL ONE-WAY PACKAGES

ORDERING INFORMATION

150 MHz

| | |
|---|----------|
| 1 — RPT-40 Transmitter, 40-watt, complete with crystal and tuned to frequency. 120 VAC & 12 VDC. 4 audio inputs (one push to talk)..... | 731-0369 |
| Alternate | |
| 1 — M-30BT/TPS Transmitter Portable-mobile, 30 watt, broadcast-quality with c/w tubes, crystal and tuned. 120 VAC and 12.6 VDC..... | 731-0045 |
| 1 — TPS-TC mobile control for M-30BT/TPS transmitter..... | 731-0047 |
| 1 — ASP-143 bumper mount for MA-1 antenna..... | 710-0087 |
| 1 — MA-1 Mobile Single Ring Antenna..... | 710-0089 |
| 1 — PA-1 Portable Single Ring Antenna..... | 710-0088 |
| 1 — R-30/150 Receiver, Rack Mount, broadcast-quality continuous-duty, with crystal and tuned. 120 VAC. 600 ohm output..... | 731-0046 |
| 1 — RA-4 4-bay Base Antenna..... | 710-0086 |
| 150 — Feet FHJ4-50B Heliax foam filled, $\frac{1}{2}$ ", jacketed transmission line..... | 618-0171 |
| 2 — 44AU UHF jack, for use with FHJ4-50B..... | 620-0301 |
| 1 — PG-4A pigtail, 4' RG-8A/U cable with plugs..... | 731-0218 |
| 1 — PG-4B pigtail, 4' RG-8A/U cable with connectors..... | 731-0182 |

450 MHz

| | |
|--|----------|
| 1 — RPT-25 Transmitter, 25-watt, complete with crystal and tuned to frequency. 120 VAC and 12 VDC. 4 audio inputs (one push to talk)..... | 731-0370 |
| Alternate | |
| 1 — M-20BT/TPS Transmitter, Portable-mobile, 20 watt, broadcast-quality, continuous-duty, with c/w tubes, crystal and tuned. 120 VAC and 12.6 VDC..... | 731-0254 |
| 1 — TPS-TC mobile control for M-20BT/TPS transmitter..... | 731-0047 |
| 1 — ASP-406 Rooftop antenna, mobile, vertically polarized..... | 710-0111 |
| 1 — R-50/450 Receiver, Rack Mount, broadcast-quality, 120 VAC, 600 ohm output..... | 731-0187 |
| 1 — ASP-313 Base Antenna, colinear, 6 dB gain..... | 710-0112 |
| 2 — ASP-320 Mounting Clamps for ASP-298 and ASP-313..... | 710-0113 |
| 150 — Feet FHJ5-50A heliax, $\frac{7}{8}$ ", 50 ohm jacketed..... | 618-0172 |
| 2 — 45AU UHF jack, for use with FHJ5-50A..... | 620-0317 |
| 1 — PG-4B pigtail, 4' RG-8A/U cable with connectors..... | 731-0182 |
| 1 — PG-4C pigtail, 4' RG-8U with UG-21C/U and UG-23B/U connectors..... | 731-0257 |

ACCESSORIES

| | |
|--|----------|
| SR-90R Turner microphone, carbon, for local control of M-25C..... | 720-0187 |
| RMC-1C remote control console, solid state, complete with transistors, power supply..... | 731-0199 |
| DFT Dual frequency kit for M-30BT, M-30BT/TPS and M-30BT/CD, less crystal..... | 731-0162 |
| DFR Dual Frequency kit for MR-30BT/150-170 and M-25/150-170C, less crystal..... | 731-0163 |
| XT-1A Hi-Accuracy Crystal for M-30BT/TPS, M-30BT/CD and M-25C..... | 731-0165 |
| XR-1A Hi-Accuracy Crystal for MR-30BT/150-170 and M-25/150-170C..... | 731-0166 |

HARRIS
 GATES DIVISION
 Harris-Intertype Corporation

Transmitting Tubes

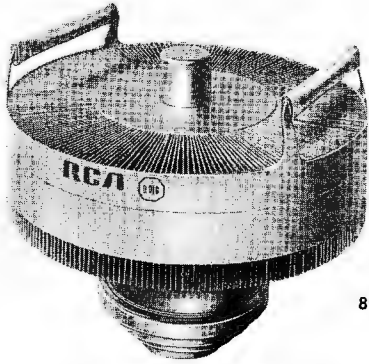

8916

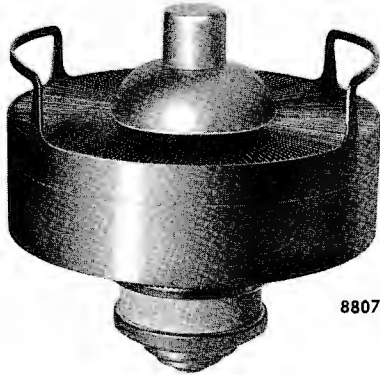

8807



4CX5000A



833-A

FAST-MOVING INVENTORY

Gates carries thousands of tubes in inventory—which, because of fast turnover, are always fresh. This is of vital importance, particularly for large transmitting tubes, where long shelf periods can make tubes gaseous. Listed below are a few of the popular tube types in stock—many others are also on hand. All tubes carry manufacturer's warranty.

HOW TO ORDER

Tubes may be ordered from Quincy, Houston, or New York. Shipment will be made as you direct—air freight, rail express, etc. Prices are no more at Gates—and you have the assurance of tube freshness. Please place your order by tube type and IBM number. Example: Type 3CV30,000H3_____374-0108.

TRANSMITTING TUBES

| Type | Number | Type | Number |
|-------------|----------|--------|----------|
| 3CV30,000H3 | 374-0108 | 810 | 374-0031 |
| 3CX2,500F3 | 374-0093 | 813 | 374-0034 |
| 4-125 | 374-0008 | 833A | 374-0039 |
| 4-250A | 374-0009 | 845 | 374-0040 |
| 4-400A | 374-0010 | 866A | 374-0042 |
| 4-400C | 374-0127 | | |
| 4CX250B | 374-0081 | 6076A | 374-0114 |
| 4CX300A | 374-0014 | 6076 | 374-0050 |
| 4CX1,000A | 374-0015 | 6146A | 374-0051 |
| 4CX1,500B | 374-0109 | 6360A | 374-0054 |
| 4CX3,000A | 374-0074 | | |
| 4CX5,000A | 374-0016 | 8008XE | 374-0059 |
| 4CX10,000D | 374-0077 | 8008 | 374-0058 |
| 4CX15,000A | 374-0097 | 8806 | 374-0118 |
| 4CX35,000 | 374-0099 | 8807 | 374-0119 |
| 5CX1,500A | 374-0120 | 8916 | 374-0124 |
| | | 8122 | 374-0096 |
| 575A | 374-0026 | 8792 | 374-0117 |
| 673 | 374-0027 | 7289 | 374-0115 |
| 807 | 374-0030 | WL5891 | 374-0067 |

FCC AND FAA SPECIFICATIONS

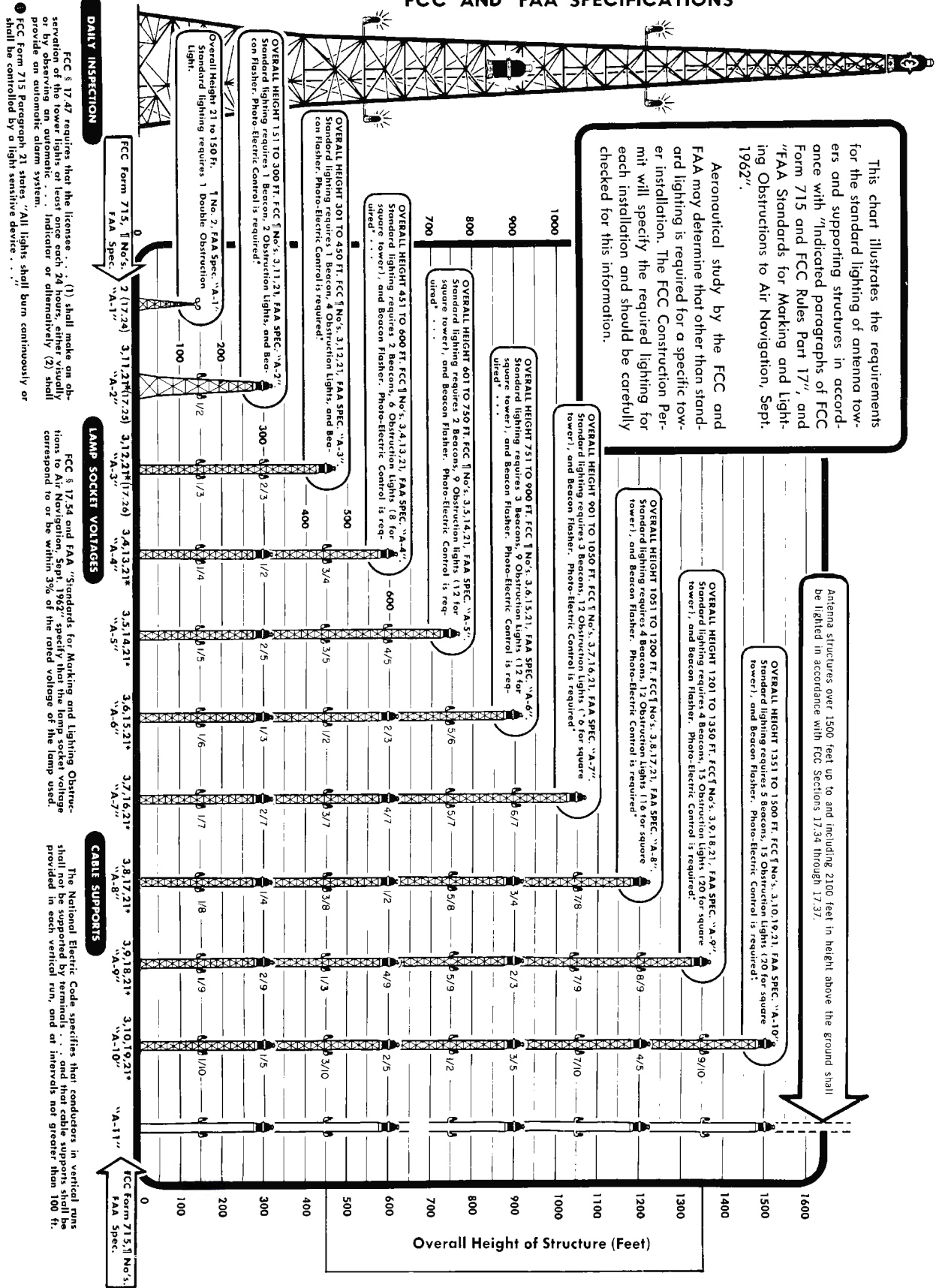

INDEX

| Item | Page | Item | Page |
|---|-------------------------|--|--------------|
| AM Antenna Couplers, Accessories | 28, 29 | Cabinets, Transcription | 146 |
| AM Broadcast Accessories | 33 | Cable, Audio | 140 |
| AM Frequency Monitor | 32, 33 | Cable, Coaxial | 70 |
| AM Limiting Amplifier | 132, 133 | Capacitors, Mica | 76 |
| AM Modulation Monitor | 30, 31 | Cartridge Recorder/Reproducer Equipment | 120 thru 124 |
| AM Transmitters | 6 thru 23 | Cartridges, Pickup | 128 |
| Air Dielectric Coaxial Cable | 70 | Cartridges, Tape | 125 |
| Ampex Tape Recording Equipment | 161, 162 | Chokes, Tower | 29 |
| Amplifiers, Audio Plug-In | 138 thru 140 | Circularly Polarized FM Antennas | 54 thru 59 |
| Amplifiers, Cueing | 144 | Coaxial Cable and Accessories | 70 thru 73 |
| Amplifiers, High Frequency Linear | 176, 177, 182, 183 | Coils, RF | 76 |
| Amplifiers, Limiting | 132 thru 137 | Coils, Isolation | 28 |
| Amplifiers, Monitor | 142, 143 | Common Point Impedance Bridge | 26 |
| Amplifiers, Program or Line | 142 | Communications Equipment | 166 thru 184 |
| Amplifiers, Remote Broadcast | 152 thru 154 | Connectors, Audio | 146 |
| Amplifier, RF FM | 65 | Consoles, Audio Control | 78 thru 105 |
| Amplifiers, Transistorized-System Time | 138 thru 140 | Consoles, Portable Audio | 131 |
| Amplifier, Utility (single channel) | 143 | Consoles, Speech Input | 78 thru 105 |
| Antenna Couplers | 28 | Consoles, Transmitter Control | 184 |
| Antenna Diode Units for Remote Control | 187 | Console Desks | 156 thru 159 |
| Antenna Meter, Remote | 28 | Control, Remote | 186, 187 |
| Antenna Phasing Equipment | 24, 25 | Couplers, Antenna | 28 |
| Antenna Towers, AM, FM | 68 | Criterion Compact Tape Cartridge Equipment | 122, 123 |
| Antenna Tower Accessories | 69 | Criterion 80 Tape Cartridge Equipment | 120, 121 |
| Antenna Tuning Equipment | 28, 29 | Cueing Amplifier | 144 |
| Antennas, Cycloid | 60 | Cue-Intercom Speaker | 145 |
| Antennas, Dual-Cycloid | 54 thru 59 | | |
| Antennas, Dummy | 34 | Desks, for Audio Control Consoles | 156 thru 159 |
| Antennas, FM Circular | 54 thru 59 | Demagnetizer, Tape Head | 147 |
| Antennas, FM Directional | 56, 57 | Desk Stands, Microphone | 147 |
| Antennas, FM Horizontal | 60 | Diode and Pickup Coil | 28, 187 |
| Antennas, FM Vertical | 60 | Diplomat Audio Control Console | 97 thru 99 |
| Arms, Pickup | 128 | Directional Antenna, FM | 56, 57 |
| Audio Accessories | 144 thru 151 | Directional Antenna Phasing Equipment | 24, 25 |
| Audio Amplifiers, System Type | 138 thru 140 | Distortion Meter | 155 |
| Audio Consoles | 78 thru 105 | Dual-Cycloid FM Antenna | 54, 55 |
| Audio Oscillator | 155 | Dual-Cycloid II FM Antenna | 58 |
| Audio Terminal Blocks | 146 | Dual-Cycloid III FM Antenna | 59 |
| Automatic Gain Control Amplifier, Audio | 136, 137 | Dualux 80 Audio Control Console | 80 thru 82 |
| Automation, Program Systems | 108 thru 117 | Dummy Antennas | 34 |
| | | Dynamote 70, 4-Channel Remote Amplifier | 152, 153 |
| Baffles and Speakers | 148, 149 | | |
| Base Station, Remote Pickup | 192, 193 | Eraser, Bulk-Type Tape | 147 |
| Base, Turntable | 156 thru 159 | Exciter, FM | 36, 37 |
| Beacon Flashers | 69 | Exciters, HF | 174, 175 |
| Boom Stands | 147 | Executive Audio Control Console | 94 thru 96 |
| Broadcast Modulation Monitors | 30, 31, 62 thru 64 | | |
| Bowls, Feed-Thru | 75 | FM Antenna Towers | 68 |
| Broadcast Transmitters—AM, FM | 6 thru 23 38 thru 52 | FM Antennas | 53 thru 60 |
| | | FM Antenna Accessories | 61 |
| Cabinets, Console | 156 thru 159 | FM Exciter, DCFM | 36, 37 |
| Cabinets, Compact Disc for LP Albums | 146 | FM Frequency Comparator, Pilot-SCA | 65 |
| Cabinets, Rack | 141 | FM Frequency Monitor | 65 |
| Cabinets, Tape | 146 | FM Isolation Transformers | 61 |
| | | FM Limiting Amplifier | 134, 135 |
| | | FM Link and Relay Systems | 53 |

INDEX

| Item | Page | Item | Page |
|--|--------------------|---|----------------------------|
| FM Monitors..... | 62 thru 65 | Meter Shorting Switch..... | 29 |
| FM RF Amplifier..... | 65 | Mica Capacitors..... | 76 |
| FM Relay Receiver..... | 53 | Microphone Accessories..... | 147 |
| FM SCA Generator..... | 37 | Microphones..... | 150, 151 |
| FM Stereo Generator..... | 37 | Modular Audio Equipment Cabinets..... | 156 thru 159 |
| FM Transmitters..... | 38 thru 52 | Modulation Monitor, AM..... | 30, 31 |
| Feed-Thru Bowls..... | 75 | Modulation Monitors, FM..... | 62 thru 64 |
| Field Intensity Meter..... | 33 | Monitor Amplifiers..... | 142, 143 |
| Flexible Coaxial Cable..... | 70 | Monitor, Frequency, AM..... | 32, 33 |
| Floor Stands, Microphone..... | 147 | Monitor, Frequency, FM..... | 65 |
| Foam Dielectric Coaxial Cable..... | 70 | Monitor, Modulation, AM..... | 30, 31 |
| Frequency Comparator, FM Pilot-SCA..... | 65 | Monitors, Modulation, FM..... | 62 thru 64 |
| Frequency Monitor, AM..... | 32, 33 | Monitor, Phase..... | 33 |
| Frequency Monitor Extension Meters..... | 187 | Multiplex Generator, SCA..... | 37 |
| Frequency Monitor, FM..... | 65 | Music Tapes, Pre-recorded..... | 117 |
| Furniture, Control Room..... | 156 thru 159 | MW-50, 50 kW Medium Wave Transmitter..... | 9 thru 11 |
| Gain Measuring Set..... | 155 | Open Wire Transmission Line..... | 75 |
| GateSound Tapes..... | 117 | Operating Impedance Bridge..... | 27 |
| Gatesway 80 Audio Control Console..... | 84 thru 86 | Oscillator, Audio..... | 155 |
| Generator, Stereo..... | 37 | Panel and Shelf Assemblies..... | 140 |
| Generator, Sub-Carrier..... | 37 | Patch Panels and Patch Cords..... | 145 |
| High Frequency Exciters..... | 174, 175 | Peak Limiting Amplifier..... | 132, 133 |
| HF Transmitters, Broadcast..... | 166 thru 172 | Phasing Equipment..... | 24, 25 |
| HF Transmitters, Communications..... | 174 thru 183 | Phase Monitor..... | 33 |
| Headphones..... | 147 | Pickup Arms..... | 128 |
| Helix Coaxial Cable..... | 70 | Pickup Cartridges..... | 128 |
| High Frequency Linear Amplifiers..... | 176, 177, 182, 183 | Pickup Coil and Rectifier..... | 155 |
| Inductors..... | 76 | Pilot-SCA Frequency Comparator..... | 65 |
| Intercom, Studio Sub-Station..... | 145 | Portable Turntable/Audio Console..... | 131 |
| Isolation Coil..... | 28 | Power Control Panel..... | 144 |
| Isolation Transformers, FM..... | 61 | Power Supply, Plug-In Audio Amplifiers..... | 138 |
| Jack Strips and Accessories..... | 145 | Preamplifiers, Turntable..... | 129 |
| KD-20B Portable Console..... | 131 | Pressurization Equipment..... | 73, 74 |
| Lights, Studio Warning..... | 144 | Pre-Wired Jack Panel..... | 145 |
| Lights, Tower Accessories, etc..... | 69 | Producer, Audio Recording Mixer..... | 104, 105 |
| Limiting Amplifiers..... | 132 thru 137 | Program Amplifiers, Rack Mount..... | 138 thru 143 |
| Linear Amplifiers, High Frequency..... | 176, 177, 182, 183 | Program Automation Systems..... | 108 thru 117 |
| Load, Dummy Antenna..... | 34 | Program Logging, Automatic..... | 116 |
| Loudspeakers & Enclosures..... | 148, 149 | Program Tapes, Pre-Recorded..... | 117 |
| Meter, Field Intensity..... | 33 | Programmers, Automation System..... | 109, 110 |
| Meter, RF..... | 28 | Proof of Performance Equipment..... | 155 |
| Meter, Remote Antenna..... | 28 | RF Amplifier, FM..... | 65 |
| Meter, VU, Desk or Console Top Mounting..... | 145 | RF Contactor..... | 29 |
| Meter, VU Panel..... | 144 | RF Meter..... | 28 |
| | | RF Meter Jack..... | 29 |
| | | Rack Cabinets..... | 141 |
| | | Random Access Programmers..... | 112 |
| | | Recorders, Audio..... | 120 thru 123, 160 thru 164 |
| | | Recorders, Audio Cartridge..... | 120 thru 123 |
| | | Recorders, Reel-to-Reel..... | 160 thru 164 |
| | | Relay System, FM..... | 188 thru 193 |

INDEX

| Item | Page | Item | Page |
|--|------------------|---|--------------|
| Remote Amplifiers, Audio..... | 152 thru 154 | Transcription Tone Arms and Pickups..... | 128 |
| Remote Antenna Meter..... | 28, 187 | Transcription Storage Cabinets..... | 146 |
| Remote Control Accessories..... | 187 | Transfer Switch, RF..... | 73 |
| Remote Control Systems..... | 186, 187 | Transformers, FM Isolation..... | 61 |
| Remote Monitoring Meters..... | 187 | Transformer, Speaker Matching..... | 145 |
| Remote Pickup Equipment..... | 53, 188 thru 193 | Transistors..... | 195 |
| Revox Tape Recording Equipment..... | 164 | Transmission Line, Coaxial..... | 70 |
| Rigid Transmission Line..... | 70 | Transmission Line, Open Wire..... | 75 |
| | | | |
| Sampling Loops..... | 29 | Transmitters (Broadcast/AM) | |
| SCA Modulation Monitor..... | 64 | 100,000 Watt Model VP-100 Transmitter..... | 6 thru 8 |
| SCA Multiplex Generator..... | 37 | 50,000 Watt Model MW-50 Transmitter..... | 9 thru 11 |
| SCA Multiplex Monitor..... | 64 | 20,000 Watt Model BC-20H Transmitter..... | 12, 13 |
| Scully Tape Recording Equipment..... | 163 | 10,000 Watt Model BC-10H Transmitter..... | 14 thru 16 |
| Semiconductor Directory..... | 195 | 5,000 Watt Model BC-5H Transmitter..... | 17 thru 19 |
| Sideband Generators..... | 174, 175 | 1,000/250 Watt Model BC-1H Transmitter..... | 20, 21 |
| Side Cabinet, Four Channel..... | 83 | 500 Watt Model BC-500H Transmitter..... | 22 |
| Single Sideband Generator, SG-70..... | 175 | 250 Watt Model BC-250GY Transmitter..... | 23 |
| Single Sideband Generator, SG-75A..... | 174 | Transmitters (Broadcast/FM) | |
| Single Sideband Transmitters..... | 176 thru 183 | 40,000 Watt Model FM-40H3 Transmitter..... | 38, 39 |
| Solid Statesman Peak Limiting Amplifier..... | 132, 133 | 20,000 Watt Model FM-20H3 Transmitter..... | 40, 41 |
| Speech Input Systems..... | 78 thru 105 | 10,000 Watt Model FM-10H3 Transmitter..... | 42, 43 |
| Speakers and Baffles..... | 148, 149 | 3,000-5,000-7,500 Watt Models | |
| Speaker Matching Transformer..... | 145 | FM-3H3/5H3/7.5H3 Transmitters..... | 44, 45 |
| Splicers, Tape..... | 147 | 2,500 Watt Model 2.5H3 Transmitter..... | 46, 47 |
| Stands, Microphone..... | 147 | 1,000 Watt Model FM-1H3 Transmitter..... | 48, 49 |
| Stereo 80 Audio Console..... | 90, 91 | 250 Watt Model FM-250H3 Transmitter..... | 50 |
| Stereo Generator..... | 37 | 50 Watt Model BFE-50C Transmitter..... | 52 |
| Stereo Modulation Monitor..... | 62 | 50 Watt Model BFE-50G3 Transmitter..... | 51 |
| Stereo Producer Audio Recording Mixer..... | 102, 103 | 10 Watt Model BFE-10G3 Transmitter..... | 51 |
| Stereo Statesman Audio Control Console..... | 92, 93 | 10 Watt Model BFE-10C Transmitter..... | 52 |
| STL Systems, FM..... | 53, 188, 189 | 50 Watt FM Relay System..... | 53 |
| Studio Cue/Intercom Speaker..... | 145 | 50 Watt STL System..... | 53 |
| Studioette 80 Audio Control Console..... | 100, 101 | Transmitters (Communications) | |
| Studio Warning Lights..... | 144 | 20,000 Watt Model HF-20CX Transmitter..... | 171 |
| Sub-Carrier Generator..... | 37 | 10,000 Watt Model HF-10CX Transmitter..... | 172 |
| Switch, Meter Shorting..... | 29 | Transmitters (Single Sideband) | |
| SW-100 HF Transmitter..... | 166 thru 168 | 10,000 Watt Model ATL-10 Transmitter..... | 176, 177 |
| SW-50 HF Transmitter..... | 169 | 10,000 Watt Model STAR-10 Amplifier..... | 178, 179 |
| | | | |
| Tape Cartridge Equipment..... | 120 thru 125 | 3,000 Watt Model ST-3A Transmitter..... | 181 |
| Tape Cartridges..... | 125 | 3,000 Watt Model HFL-3000 Amplifier..... | 183 |
| Tape Cartridge Storage Units..... | 125 | 1,000 Watt Model ST-1A Transmitter..... | 180 |
| Tape Eraser, Bulk-Type..... | 147 | 1,000 Watt Model HFL-1000 Amplifier..... | 182 |
| Tape Head Demagnetizer..... | 147 | Transmitters (High Frequency Broadcast) | |
| Tape Recorders..... | 160 thru 164 | 100,000 Watt Model SW-100 Transmitter..... | 166 thru 168 |
| Tape Splicer..... | 147 | 50,000 Watt Model SW-50 Transmitter..... | 169 |
| Terminal Blocks, Audio..... | 146 | 20,000 Watt Model HF-20B Transmitter..... | 170, 171 |
| Test Equipment, Audio..... | 155 | 10,000 Watt Model HF-10B Transmitter..... | 172 |
| Tone Arms..... | 128 | | |
| Tower Chokes..... | 29 | | |
| Tower Lighting..... | 196 | | |
| Tower Lights and Accessories..... | 69 | | |
| Towers, Antenna, AM, FM..... | 68 | | |
| Transcription Turntables, | | | |
| Amplifiers and Accessories..... | 126 thru 130 | | |

INDEX

| Item | Page | Item | Page |
|--|------------------|---|------------|
| Transmitter, Remote Pickup..... | 192, 193 | Vertically Polarized FM Antenna..... | 60 |
| Transmitter, STL..... | 53, 188 thru 191 | VP-100, 100,000 Watt AM Transmitter..... | 6 thru 8 |
| Transmitting Tubes..... | 194 | VU Meter, Desk or Console Top..... | 145 |
| Tubes, Transmitting..... | 194 | VU Meter Panel..... | 144 |
| Tuning Units, Antenna..... | 28, 29 | Wall Baffles..... | 149 |
| Turntable, Portable Audio Console..... | 131 | Warning Lights, Studio..... | 144 |
| Turntable Preamplifiers..... | 129 | Yagi Antennas, Remote Pickup Equipment..... | 192, 193 |
| Turntables and Accessories..... | 126 thru 131 | Yard 80 Audio Control Console..... | 87 thru 89 |
| TV-15 Audio Console..... | 78, 79 | | |
| Utility Audio Amplifier..... | 143 | | |

The mechanical and electrical design of the equipment described herein is subject to change without notice as deemed necessary by Gates Division of Harris-Intertype Corporation or its suppliers in the interest of advancing industry requirements or the state of the art.

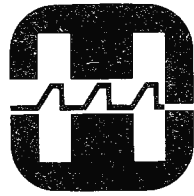

HARRIS
BROADCAST EQUIPMENT

PRICE LIST

Radio Catalog #100

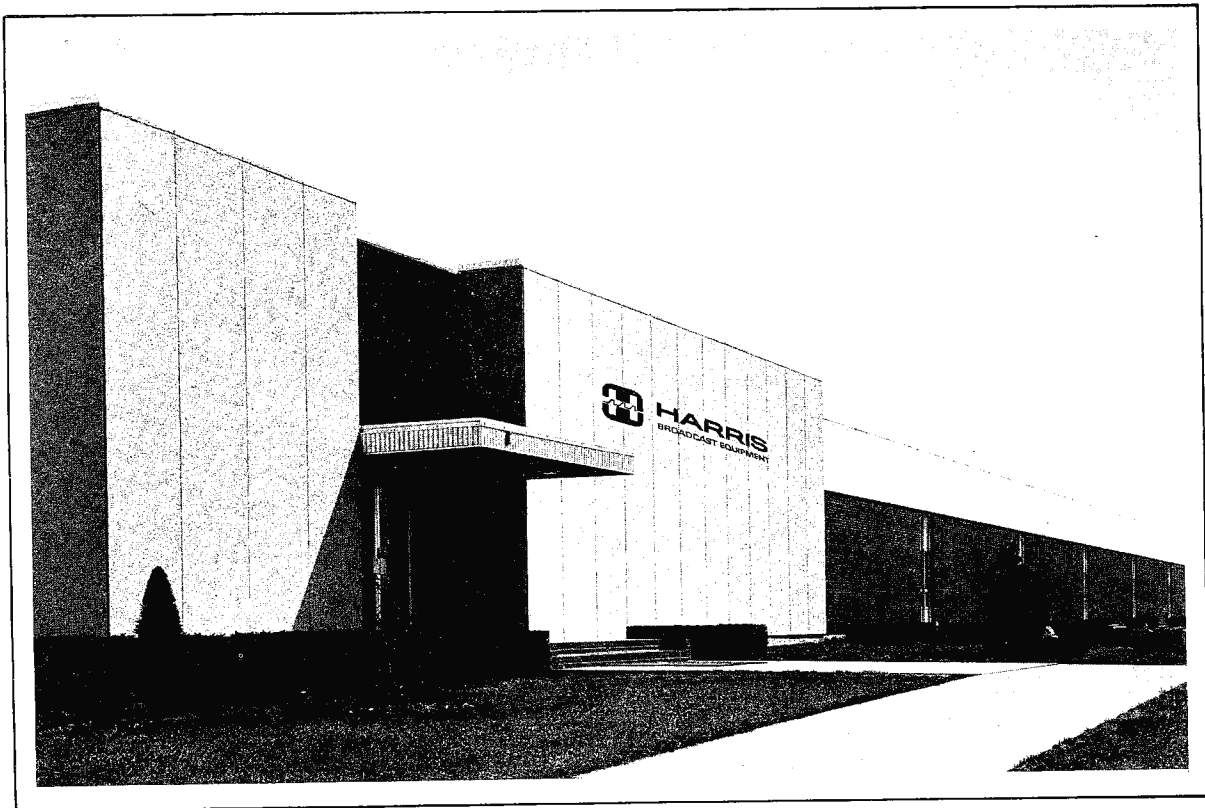

HOW TO ORDER

ORDERING PROCEDURE: All sales are made in accordance with the standard Harris Terms and Conditions of Sale. No order shall be binding upon Harris until accepted by the company in writing at its home office in Quincy, Illinois.

PRICES: Catalog prices are net, f.o.b. Quincy, Illinois, or point of shipment. Our prices are based on cash transactions and all applicable discounts have been deducted. Prices are subject to change without notice. Orders are filled at prices in effect at time of shipment. You will be billed for any price increase and credited for any price reduction. We reserve the right to add any federal, state, or local taxes required by law. If you have a tax exemption number, please include it with your order. These prices and terms apply only to the U.S. For prices and terms in other countries, please contact International Sales Department, 123 Hampshire Street, Quincy, Illinois 62301.

PAYMENT: There are four ways to pay for your equipment purchases:

- (1) CASH—This means full payment with order.
- (2) C.O.D.—A 25% down payment is required on C.O.D. orders.
- (3) OPEN ACCOUNT—A 25% down payment is recommended. The balance is payable upon receipt of invoice. If you do not have an established account, please provide a current financial statement, plus trade and bank references with your order. Allow at least two weeks for processing.
- (4) HARRIS FINANCE PLAN—On major purchases, by domestic customers, a portion of the cost may be financed through a monthly payment plan. Since Harris financing plans are subject to change from time to time, contact our Credit Manager or your nearest Harris District Manager for full information. The Harris finance plan applies only to the United States.

RETURNS AND EXCHANGES: Do not return any merchandise without our written approval and Return

Authorization. We will provide special shipping instructions and a code number that will assure proper handling and prompt issuance of credit. Please furnish complete details as to circumstances and reasons when requesting return of merchandise. Custom built equipment or merchandise specially ordered for you is not returnable. Where return is at the request of, or for the convenience of the customer, a restocking fee of 15% will be charged. All returned merchandise must be sent freight prepaid and properly insured by the customer. When writing to Harris about your order, it will be helpful if you specify the Harris factory order number or invoice number.

SHIPPING: Please specify method of shipment on your order. Shipping charges, insurance, and C.O.D. fees (when applicable) will be collected at time of delivery when shipment is made by air, rail or motor freight, or express. If you request parcel post shipment, postage and insurance fees will be billed to your account. Purchaser assumes all responsibility for and risk of loss of, or damage to equipment upon shipment from Harris shipping point(s). Should you receive merchandise damaged in shipment, it is your responsibility to file a damage claim immediately with the delivering carrier. Export packing for overseas shipment is available at slight extra charge.

WARRANTY ADJUSTMENTS: In the event of equipment failure during the warranty period, replacement or repair parts may be provided in accordance with the provisions of the Harris Warranty. In most cases you will be required to return the defective merchandise or part to Harris Corp., f.o.b. Quincy, Illinois, for replacement or repair. Repairs, within the warranty period will be done on a no charge basis. Warranty replacements of defective merchandise will be billed to your account. This billing will be cleared by a credit issued upon return of the defective item.

MODIFICATIONS: Harris reserves the right to modify the design and specifications of the equipment shown in this catalog without notice or to withdraw any item from sale, provided, however, that any modification shall not adversely affect the performance of the equipment so modified.



PRICE LIST

[Applies to Harris Radio Catalog #100 Effective December 31, 1974]

This is your price list for items listed in your Harris Radio catalog. Each price has been carefully checked for accuracy. Rapidly changing conditions as well as the human element will necessitate price changes or corrections from time to time. Therefore, the prices herein are subject to change without notice.—All prices are F.O.B. Quincy, Illinois or point of manufacture.

| CAT. PAGE | TYPE NUMBER | PRODUCT DESCRIPTION | UNIT PRICE | CAT. PAGE | TYPE NUMBER | PRODUCT DESCRIPTION | UNIT PRICE |
|-----------|--------------|--|------------|----------------------------|-------------|--|------------|
| 8 | 994-7651 | Model VP-100A, 100 kw Medium wave transmitter-- On Request | | 990-0719 | | Spare 100% tube complement for BC-1H transmitter | 316.00 |
| 11 | 994-6994-003 | Model MW-50 with one set of tubes and two crystals -- | 105,500.00 | 22 | 994-6872 | Model BC-500H transmitter, with solid state audio driver, 500/250/100 watts-- | 7,475.00 |
| | 990-0711 | 100% set of spare tubes for MW-50 transmitter ----- | 5,996.00 | 990-0721 | | Spare 100% tube complement for BC-500H ----- | 240.00 |
| | 990-0712 | Recommended minimum spare tubes for MW-50 transmitter ----- | 3,376.00 | 990-0720 | | Recommended minimum spare tube complement for BC-500H ----- | 158.00 |
| 13 | 994-6669 | Model BC-20H transmitter, consisting of two standard BC-10H 10 kW transmitters, a 20 kW combiner and a common drive unit ----- | 60,500.00 | 23 | 994-3760 | BC-250GY transmitter, 250 watts, complete with one set of tubes and one vacuum crystal ----- | 5,500.00 |
| 16 | 994-6522 | Model BC-10H transmitter with one set of tubes and two crystals ----- | 26,950.00 | 990-0507 | | Spare 100% set of tubes --- | 234.00 |
| | 990-0539 | 100% set spare tubes for BC-10H transmitter ----- | 983.00 | 990-0508 | | Recommended minimum set of spare tubes ----- | 134.00 |
| | 990-0540 | Set of spare transistors for BC-10H (diodes not included) ----- | 208.00 | 26 | 700-0055 | CPB-1 Common Point Impedance Bridge, 5 kW --- | 875.00 |
| | 994-6548 | Kit for remote control of power output ----- | 445.00 | 700-0056 | | CPB-1A Common Point Impedance Bridge, 50 kW -- | 975.00 |
| 19 | 994-6521 | Model BC-5H transmitter with one set of tubes and two crystals ----- | NLA | 27 | 700-0063 | Model OIB-1 Operating Impedance Bridge. Specify whether 12" or 18" leads are desired ----- | 845.00 |
| | 990-0535 | 100% set spare tubes for BC-5H transmitter ----- | 753.00 | 700-0064 | | D. C. Amplifier. Used to increase sensitivity of Bridge for use with power sources as low as 25 watts ----- | 80.00 |
| | 990-0540 | 100% set spare transistors for BC-5H (diodes not included) ----- | 208.00 | 700-0065 | | TC-1 Transport Case. For OIB-1 ----- | 95.00 |
| | 994-6548 | Kit for remote control of power output ----- | 445.00 | ANTENNA COUPLER 1250 WATTS | | | |
| 21 | 994-6813 | Model BC-1H transmitter with solid-state audio driver, 1000/500/250 watts----- | 7,915.00 | 28 | 994-3494 | Antenna coupling unit for 1000 watts or less. Note: does not include tower chokes, diode or line current meter ----- | 765.00 |

| CAT. PAGE | TYPE NUMBER | PRODUCT DESCRIPTION | UNIT PRICE | CAT. PAGE | TYPE NUMBER | PRODUCT DESCRIPTION | UNIT PRICE |
|-----------------------------------|--------------|--|------------|-----------|---|---|------------|
| SERIES AND SHUNT FED COUPLERS | | | | | | | |
| 28 | 994-5178 | Antenna coupler for direct feed to series fed antenna. Note: for 250, 500 and 1000 watt transmitters, metering not included. Non-weather-proof ----- | 402.00 | | 632-0419 | Same as above, 0-5 amp scale face ----- | 55.54 |
| | 994-5179 | Antenna coupler for direct feed to shunt fed antenna. Note: for 250, 500 and 1000 watt transmitters, metering not included. Non-weather-proof ----- | 402.00 | | 632-0420 | Same as above, 0-8 amp scale face ----- | 52.90 |
| ISOLATION COIL | | | | | | | |
| | 994-3073-003 | Uses 1/2", 50 ohm foam heliax FH4, coil only on mfg. plate. In weather-proof housing ----- | 436.00 | | 632-0421 | Same as above, 0-10 amp scale face ----- | 58.19 |
| | 994-4561-003 | Uses 1/2", 50 ohm foam heliax FH4, coil only on mfg. plate. Less cabinet --- | 313.00 | | 632-0424 | Meter 0-1MA DC RX-371 Westinghouse with 0-3 amp scale face ----- | 65.20 |
| 5-10 KW ANTENNA COUPLING UNITS | | | | | | | |
| | 994-5309A | Special antenna coupling unit for 5000 watts AM. Note: does not include tower chokes, diode or line current meter ----- | 1,413.00 | | 632-0426 | Same as above, 0-8 amp scale face ----- | 65.20 |
| | 994-5309B | Special antenna coupler for 10,000 watts AM. Note: does not include tower chokes, diode or line current meter ----- | 1,914.00 | | 632-0361 | Same as above, 0-10 amp scale face ----- | 55.54 |
| R. F. ANTENNA METERS | | | | | | | |
| 28 | 634-0206 | 308 Weston 0-3 RF Int. Thermo Std. Scale ----- | 75.02 | | 632-0428 | Same as above, 0-15 amp scale face ----- | 65.20 |
| | 634-0238 | 308 Weston 0-6 RF Int. Thermo Std. Scale ----- | 117.34 | 29 | SOLENOID TOWER CHOKES | | |
| | 634-0209 | 308 Weston 0-8 RF Int. Thermo Std. Scale ----- | 75.02 | | 994-3937 | Tower choke, 2 section, weatherproof ----- | 192.00 |
| | 634-0210 | 308 Weston 0-10 RF Int. Thermo Std. Scale ----- | 75.02 | | 994-3938 | Tower choke, 3 section, weatherproof ----- | 220.00 |
| DIODE TYPE REMOTE METER EQUIPMENT | | | | | | | |
| | 994-6112 | Solid state diode assembly. For all powers 250 watts through 50 kW. Meter not included ----- | 112.00 | | 994-3935 | Tower choke, 2 section, unboxed ----- | 107.00 |
| | 632-0418 | Meter 0-1 MA DC. Westinghouse RX351. With 0-3 amps RF scale face. 3" case ----- | 63.25 | | 994-3936 | Tower choke, 3 section, unboxed ----- | 135.00 |
| | | | | | RADIO FREQUENCY CONTACTOR | | |
| | | | | | 570-0001 | 145-101-13, SPDT 17,000 peak voltage, 25 amps current ----- | NLA |
| | | | | | 570-0002 | 145-102-13, DPDT 17,000 peak voltage, 25 amps current ----- | NLA |
| | | | | | 570-0003 | 145-201-13, SPDT 22,000 peak voltage, 25 amps current ----- | NLA |
| | | | | | 570-0004 | 145-202-13, DPDT 22,000 peak voltage, 25 amps current ----- | NLA |
| | | | | | HEAVY DUTY SAMPLING LOOP | | |
| | | | | | 994-6126 | Fixed, non-shielded sampling loop ----- | 248.00 |
| | | | | | ROTATING PHASE SAMPLING LOOP | | |
| | | | | | 994-3283-002 | Sampling loop, shielded, insulated and adjustable 83-1S PN UHF type connector ----- | NLA |
| | | | | | METER JACK AND SHORTING BAR-MOUNTING PLUG | | |
| | | | | | 994-3280 | Meter jack and shorting bar | 22.00 |

| CAT. PAGE | TYPE NUMBER | PRODUCT DESCRIPTION | UNIT PRICE | CAT. PAGE | TYPE NUMBER | PRODUCT DESCRIPTION | UNIT PRICE |
|-----------|---------------------------|---|------------|-----------|--------------|--|------------|
| | 994-3281 | Meter mounting plug ----- | 17.00 | | 994-6876 | Automatic Exciter/I.P.A. Switching Kit for dual FM system ----- | 6,500.00 |
| | 994-6527 | Meter shorting switch, rating 40 amperes ----- | 85.00 | | 994-6877 | RF Output Switching for dual FM system ----- | 8,950.00 |
| | 994-3493 | Meter shorting switch, rating 15 amperes ----- | 48.00 | | 994-6746-001 | FM-40H3, consisting of two FM-20H3 transmitters. Includes TE-3 exciter, couplers, reject loads ----- | 69,000.00 |
| 31 | 994-6659 | Solid-state AM Modulation Monitor ----- | NLA | | 994-6745 | FM-20H3, 20,000 watt FM broadcast transmitter, with TE-3 exciter ----- | 32,000.00 |
| | 994-6687 | Remote meter panel for above ----- | 138.00 | 41 | 990-0552 | 100% spare tube kit ----- | 763.00 |
| 33 | 994-6698 | Medium wave frequency monitor, digital read-out --- | 1,075.00 | | 994-6533 | Stereo generator (add for stereo operation) ----- | 1495.00 |
| | 994-6865 | Medium wave frequency monitor, analog (meter) display ----- | 1,075.00 | | 994-6507-001 | SCA sub-carrier generator (add for SCA operation) --- | 695.00 |
| | 994-6863 | Remote (analog) meter panel for Model 994-6698 above ----- | 230.00 | 43 | 994-6744 | FM-10H3, 10,000 watt FM broadcast transmitter, with TE-3 exciter ----- | 22,995.00 |
| | 994-6864 | Remote (analog) meter panel for Model 994-6865 above ----- | 67.00 | | 990-0551 | 100% spare tube kit ----- | 591.00 |
| | PHASE MONITOR | | | | 994-6533 | Stereo generator (add for stereo operation) ----- | 1,495.00 |
| | 731-0239 | Model AM-19 Phase Monitor (state number of towers) ----- | On Request | | 994-6507-001 | SCA sub-carrier generator (add for SCA operation) --- | 695.00 |
| | FIELD INTENSITY METER | | | 45 | 994-6736-001 | FM-5H3, 5,000 watt FM broadcast transmitter with TE-3 exciter ----- | 17,995.00 |
| | 700-0077 | Model FIM-21 Field Intensity Meter (less batteries) --- | 1,150.00 | | 994-6743-001 | FM-7.5H3, 7,500 watt FM broadcast transmitter with TE-3 exciter ----- | 19,995.00 |
| | DUMMY ANTENNAS | | | | 994-6742 | FM-3H3, 3,000 watts ----- | 15,995.00 |
| 34 | 994-3968-001 | DU-551 5 kW Dummy Antenna, air cooled, 50 ohm -- | 615.00 | | 990-0549 | 100% spare tube kit for 3, 5, 7.5 kW transmitters --- | 514.00 |
| | 994-3968-002 | DU-570 as above, 70 ohm -- | 615.00 | | 994-6533 | Stereo generator (add for stereo operation) ----- | 1,495.00 |
| | 994-6107 | 10 kW Dummy Antenna, air cooled, 50 ohm ----- | 830.00 | | 994-6507-001 | SCA sub-carrier generator (add for SCA operation) --- | 695.00 |
| | 994-5497-001 | 50 kW Dummy Antenna, water cooled ----- | On Request | 47 | 994-6871 | FM-2.5H3, 2,500 watt FM broadcast transmitter with TE-3 exciter ----- | 13,500.00 |
| | 994-5497-002 | As above, 2-25 MHz ----- | On Request | | 900-0587 | 100% spare tube kit ----- | 247.00 |
| | | 75 kW Dummy Antenna, air cooled ----- | On Request | | 994-6533 | Stereo generator (add for stereo operation) ----- | 1,495.00 |
| | 994-4354 | DU-151 1 kW Dummy Antenna, air cooled, 50 ohms - | 198.00 | | 994-6507-001 | SCA sub-carrier generator (add for SCA operation) --- | 695.00 |
| | 994-3483 | DU-170 Dummy Antenna, 1 kW, 70 ohms ----- | 198.00 | 49 | 994-6740 | FM-1H3, 1,000 watt FM broadcast transmitter with TE-3 exciter ----- | 8,995.00 |
| | FM BROADCAST TRANSMITTERS | | | | 990-0550 | 100% spare tube kit ----- | 223.00 |
| 39 | 994-6875 | Basic Dual FM System (does not include transmitters) ----- | On Request | | | | |

| CAT. PAGE | TYPE NUMBER | PRODUCT DESCRIPTION | UNIT PRICE | CAT. PAGE | TYPE NUMBER | PRODUCT DESCRIPTION | UNIT PRICE |
|-----------|-------------------------------------|---|------------------------|-----------|----------------------------|--|------------------------|
| | FMS-8 | 8-Bay 3-1/8" line ----- Same as above, with 300 watt heaters ----- | 9,465.00 11,523.00 | | FMC-8DA | 8-Bay ----- Same as above, with heaters ----- | 13,500.00 16,600.00 |
| | FMS-9 | 9-Bay 3-1/8" line ----- Same as above, with 300 watt heaters ----- | 10,540.00 12,832.00 | | DUAL CYCLOID II FM ANTENNA | | |
| | FMS-10 | 10-Bay 3-1/8" line ----- Same as above, with 300 watt heaters ----- | 11,592.00 14,112.00 | 58 | FMC-4B | 4-Bay ----- Same as above, with heaters ----- | 3,368.00 4,313.00 |
| | FMS-11 | 11-Bay 3-1/8" line ----- Same as above, with 300 watt heaters ----- | 12,617.00 15,361.00 | | FMC-5B | 5-Bay ----- Same as above, with heaters ----- | 4,068.00 5,250.00 |
| | FMS-12 | 12-Bay 3-1/8" line ----- Same as above, with 300 watt heaters ----- | 13,620.00 16,581.00 | | FMC-6B | 6-Bay ----- Same as above, with heaters ----- | 4,768.00 6,186.00 |
| | FMS-13 | 13-Bay 3-1/8" line ----- Same as above, with 300 watt heaters ----- | 14,598.00 17,771.00 | | FMC-7B | 7-Bay ----- Same as above, with heaters ----- | 5,468.00 7,122.00 |
| | FMS-14 | 14-Bay 3-1/8" line ----- Same as above, with 300 watt heaters ----- | 15,552.00 18,933.00 | | FMC-8B | 8-Bay ----- Same as above, with heaters ----- | 6,168.00 8,058.00 |
| | FMS-15 | 15-Bay 3-1/8" line ----- Same as above, with 300 watt heaters ----- | 16,481.00 20,065.00 | | FMC-9B | 9-Bay ----- Same as above, with heaters ----- | 6,868.00 8,995.00 |
| | FMS-16 | 16-Bay 3-1/8" line ----- Same as above, with 300 watt heaters ----- | 17,388.00 21,166.00 | | FMC-10B | 10-Bay ----- Same as above, with heaters ----- | 7,568.00 9,931.00 |
| | DUAL CYCLOID DIRECTIONAL FM ANTENNA | | | | FMC-11B | 11-Bay ----- Same as above, with heaters ----- | 8,268.00 10,867.00 |
| | FMC-1DA | 1-Bay ----- Same as above, with heaters ----- | 3,800.00 4,200.00 | | FMC-12B | 12-Bay ----- Same as above, with heaters ----- | 8,968.00 11,803.00 |
| | FMC-2DA | 2-Bay ----- Same as above, with heaters ----- | 5,200.00 6,000.00 | | DUAL CYCLOID III ANTENNA | | |
| | FMC-3DA | 3-Bay ----- Same as above, with heaters ----- | 6,600.00 7,800.00 | 59 | FMC-1A | 1-Bay ----- Same as above, with heaters ----- | 700.00 936.00 |
| | FMC-4DA | 4-Bay ----- Same as above, with heaters ----- | 8,000.00 9,500.00 | | FMC-2A | 2-Bay ----- Same as above, with heaters ----- | 1,400.00 1,872.00 |
| | FMC-5DA | 5-Bay ----- Same as above, with heaters ----- | 9,300.00 11,300.00 | | FMC-3A | 3-Bay ----- Same as above, with heaters ----- | 2,100.00 2,808.00 |
| | FMC-6DA | 6-Bay ----- Same as above, with heaters ----- | 10,700.00 13,100.00 | | FMC-4A | 4-Bay ----- Same as above, with heaters ----- | 2,800.00 3,744.00 |
| | FMC-7DA | 7-Bay ----- Same as above, with heaters ----- | 12,100.00 14,900.00 | | FMC-5A | 5-Bay ----- Same as above, with heaters ----- | 3,500.00 4,681.00 |
| | | | | | FMC-6A | 6-Bay ----- Same as above, with heaters ----- | 4,200.00 5,617.00 |

| CAT. PAGE | TYPE NUMBER | PRODUCT DESCRIPTION | UNIT PRICE | CAT. PAGE | TYPE NUMBER | PRODUCT DESCRIPTION | UNI. PRICE |
|-----------|-------------|---|----------------------|-----------|-------------|---|-----------------------|
| | FMC-7A | 7-Bay ----- Same as above, with heaters ----- | 4,900.00 6,553.00 | | 300G-8 | Eight bay—1-5/8" ----- 3-1/8" ----- | 6,440.00 6,930.00 |
| | FMC-8A | 8-Bay ----- Same as above, with heaters ----- | 5,600.00 7,490.00 | | 300G-10 | Ten bay—1-5/8" ----- 3-1/8" ----- | 8,050.00 8,662.00 |
| | | CYCLOID FM RING ANTENNA | | | 300G-12 | Twelve bay—1-5/8" ----- 3-1/8" ----- | 9,660.00 10,395.00 |
| 60 | FMA-1A | One ring, 1-5/8" ----- | 805.00 | | | FM ISOLATION TRANSFORMERS | |
| | FMA-2A | Two ring, 1-5/8" ----- | 1,610.00 | 61 | 620-0397 | Isolation transformer, Type 402, standard EIA 1-5/8" adjusted to customer's operating frequency at factory, for use with a maximum transmitter power of 7.5 kW ----- | * |
| | FMA-2B | Two ring, 3-1/8" ----- | 1,732.00 | | 620-0415 | Isolation transformer, Type 402, with standard 3-1/8" flanges, adjusted to customer's operating frequency, for use with a transmitter power up to and including 10kW ----- | * |
| | FMA-3A | Three ring, 1-5/8" ----- | 2,415.00 | | 620-0444 | 25 kW Isolation transformer, Type 425, standard 3-1/8" flanges, adjusted to customer's operating frequency, for use with a transmitter up to and including 25 kW ----- | 3,381.00 |
| | FMA-3B | Three ring, 3-1/8" ----- | 2,598.00 | | | FM ANTENNA ACCESSORIES | |
| | FMA-4A | Four ring, 1-5/8" ----- | 3,220.00 | | 710-0139 | Antenna heater control system ----- | 1,050.00 |
| | FMA-4B | Four ring, 3-1/8" ----- | 3,465.00 | | 710-0136 | Dual-Cycloid replacement antenna heater elements (2 elements per bay) ----- | 80.00 |
| | FMA-5A | Five ring, 1-5/8" ----- | 4,025.00 | | 710-0137 | Dual-Cycloid II replacement antenna heater elements (2 elements per bay) ----- | 80.00 |
| | FMA-5B | Five ring, 3-1/8" ----- | 4,331.00 | | 710-0138 | Cycloid replacement antenna heater elements (2 elements per bay) ----- | 37.00 |
| | FMA-6A | Six ring, 1-5/8" ----- | 4,830.00 | | | FM MODULATION MONITORS | |
| | FMA-6B | Six ring, 3-1/8" ----- | 5,197.00 | 62 | 994-6569 | Gates' GTM-88S Stereo Modulation Monitor, tuned to customer's operating frequency ----- | * |
| | FMA-7A | Seven ring, 1-5/8" ----- | 5,635.00 | | 994-6581 | Gates' GTM-88M FM Mon- aural Modulation Monitor, tuned to customer's operat- ing frequency ----- | * |
| | FMA-7B | Seven ring, 3-1/8" ----- | 6,063.00 | 63 | 994-6591 | GTA-6741 SCA Modulation Monitor Adapter ----- | * |
| | FMA-8A | Eight ring, 1-5/8" ----- | 6,440.00 | | | | |
| | FMA-8B | Eight ring, 3-1/8" ----- | 6,930.00 | | | | |
| | FMA-10A | Ten ring, 1-5/8" ----- | 8,050.00 | | | | |
| | FMA-10B | Ten ring, 3-1/8" ----- | 8,662.00 | | | | |
| | FMA-12A | Twelve ring, 1-5/8" ----- | 9,660.00 | | | | |
| | FMA-12B | Twelve ring, 3-1/8" ----- | 10,395.00 | | | | |
| | | CYCLOID ANTENNA HEATERS | | | | | |
| | FMH-300 | 300 Watt heaters (per bay) - | 236.00 | | | | |
| | FMH-600 | 600 Watt heaters (per bay) - | 236.00 | | | | |
| | | TYPE 300G FM ANTENNAS (no heaters required) | | | | | |
| | 300G-1 | Single bay—1-5/8" ----- 3-1/8" ----- | 805.00 866.00 | | | | |
| | 300G-2 | Two bay—1-5/8" ----- 3-1/8" ----- | 1,610.00 1,732.00 | | | | |
| | 300G-3 | Three bay—1-5/8" ----- 3-1/8" ----- | 2,415.00 2,598.00 | | | | |
| | 300G-4 | Four bay—1-5/8" ----- 3-1/8" ----- | 3,220.00 3,465.00 | | | | |
| | 300G-5 | Five bay—1-5/8" ----- 3-1/8" ----- | 4,025.00 4,331.00 | | | | |
| | 300G-6 | Six bay—1-5/8" ----- 3-1/8" ----- | 4,830.00 5,197.00 | | | | |
| | 300G-7 | Seven bay—1-5/8" ----- 3-1/8" ----- | 5,635.00 6,063.00 | | | | |

*Write for information on current product.

| AT. PAGE | TYPE NUMBER | PRODUCT DESCRIPTION | UNIT PRICE | CAT. PAGE | TYPE NUMBER | PRODUCT DESCRIPTION | UNIT PRICE |
|------------------------------|-----------------------|---|------------|--------------|---|--|------------|
| FM ACCESSORIES | | | | | | | |
| 65 | 994-6588 | Gates' GTM-88F FM Frequency Monitor, specify operating frequency ----- | * | 994-5281 | M-5281 feed-through bowl. Single bowl, hollow stud, for walls to 1" thick ----- | 26.00 | |
| | 994-6603 | Gates' GTA-88F, 19 kHz pilot and SCA 67 kHz and 41 kHz frequency comparator. Used in conjunction with Gates' stereo and monaural modulation monitor ----- | * | 994-3322 | M-3322 horn gap ----- | 135.00 | |
| | 994-6614 | GTM-88R FM RF Amplifier, complete with antenna, less interconnecting cable - | 650.00 | 994-3864 | M-3864 center post assembly ----- | 55.00 | |
| TOWER LIGHTS AND ACCESSORIES | | | | | | | |
| 69 | 710-0012 | OB-20-3 single obstruction light ----- | 22.00 | 76 | 931-6138-010 | 87FA4634 87 UH, 12-1/6" l., 87RA4634 fixed 1/4" edgewise, 10 amp. rating ----- | 92.00 |
| | 710-0013 | OB-21-4 single obstruction light ----- | 22.00 | 931-6138-039 | 6FC0854 6UH, 6-1/2" l., fixed 1/2" edgewise, 20 amp rating ----- | 63.00 | |
| | 710-0014 | OB-22-4 double obstruction light, medium screw -- | 43.00 | 931-6138-040 | 10FC0855 10 UH, 6-1/4" l., 5" d., fixed 1/2" edgewise, 10 amp rating ----- | 46.00 | |
| | 396-0141 | 107A21-TS traffic signal lamp, 115 volts ----- | .86 | 931-6138-041 | 13FC0856 13 UH, 6-1/4" l., 6" d., fixed 1/2" edgewise, 20 amp rating ----- | 46.00 | |
| | 710-0063 | KG-114-3G code beacon 300 MM. 1" conduit top, 3 wire Grn. Ground ----- | 400.00 | 931-6138-025 | 17FC1654 17 UH, 8-3/4" l., 4" d., fixed 1/2" edgewise, 20 amp rating ----- | 55.00 | |
| | 710-0075 | KG-114-4G code beacon 300 MM. 1" conduit top, 4 wire Grn. Ground ----- | 400.00 | 931-6138-026 | 24FC1655 24 UH, 8-3/4" l., 5" d., fixed 1/2" edgewise, 20 amp rating ----- | 63.00 | |
| | 396-0129 | 620 PS40 Beacon lamp, 620 watt ----- | 5.69 | 931-6138-027 | 32FC1656 32 UH, 8-3/4" l., 6" d., fixed 1/2" edgewise, 20 amp rating ----- | 63.00 | |
| | 710-0058 | LC-700A-2 photo-cell and beacon flasher. Single circuit for one tower ----- | 152.00 | 931-6138-036 | 42FC2266 42 UH, 12-5/8" l., 6" d., fixed 1/2" edgewise, 20 amp rating ----- | 69.00 | |
| | 670-0007 | 63305DA Fisher-Pierce light control (110VAC) ----- | 95.00 | 931-6138-030 | 67FC2856 67 UH, 13-1/16" l., 6" d., fixed 1/2" edgewise, 20 amp rating ----- | 94.00 | |
| 70-73 | See Andrew Price List | | | 931-6337-007 | 10FBT1066 10 UH, 21-1/2" l., 6" d., fixed 3/8" copper tubing, 30 amp rating ----- | 126.00 | |
| OPEN WIRE TRANSMISSION LINE | | | | 931-6337-002 | 20FBT1656 20 UH, 15" l., 6" d., fixed 3/8" copper tubing, 30 amp rating ----- | 120.00 | |
| 75 | 994-3327 | M-3327 transmission line bracket ----- | 82.50 | 931-6337-003 | 32FBT1658 32 UH, 15" l., 8" d., fixed 3/8" copper tubing, 30 amp rating ----- | 189.00 | |
| | 994-3328 | M-3328 end plate ----- | 88.50 | 931-6337-004 | 45FBT2158 45 UH, 18-1/2" l., 8" d., fixed 3/8" copper tubing, 30 amp rating ----- | 215.00 | |
| | 994-2870-004 | M-2870 feed-through bowl. 2 bowls, solid stud, for walls to 10-1/2" thick ----- | On Request | 931-6372-002 | 65FBT2559 65 UH, 24-1/2" l., 9" d., fixed 3/8" copper tubing, 30 amp rating ----- | 158.00 | |
| | 994-3254 | M-3254 feed-through bowl. 2 bowls, hollow stud, for walls to 10-1/2" thick ----- | 34.00 | 931-6337-001 | 17FCT1178 17 UH, 14" l., 8" d., fixed 1/2" copper tubing, 40 amp rating ----- | 149.00 | |
| | 994-5280 | M-5280 feed-through bowl. Single bowl, solid stud, for walls to 1" thick ----- | 24.00 | | | | |

*Write for information on current product.

| CAT. PAGE | TYPE NUMBER | PRODUCT DESCRIPTION | UNIT PRICE | CAT. PAGE | TYPE NUMBER | PRODUCT DESCRIPTION | UNI. PRICE |
|-----------|-----------------|---|--|------------|-------------|---|------------|
| | 931-6372-001 | 35FCT1769 35 UH, 24-1/2" l., 9" d., fixed 1/2" copper tubing, 40 amp rating ----- | 207.00 | | | .01 mfd. ----- On Request | |
| | 931-6583-008 | 6VCO854 6 UH, 8" l., 4" d., variable 1/2" edgewise, 20 amp rating ----- | 97.00 | | G4 | .02 mfd. ----- On Request | |
| | 931-6583-001 | 15VC1444 15 UH, 10-3/4" l., 4" d., variable 1/2" edgewise, 20 amp rating ----- | 97.00 | | | .00025 mfd. thru .0008 mfd. On Request | |
| | 931-6583-002 | 26VC2144 26 UH, 10-3/4" l., 4" d., variable 1/2" edgewise, 20 amp rating ----- | 97.00 | | | .001 mfd. thru .003 mfd. --- On Request | |
| | 931-6583-003 | 42VC2145 42 UH, 10-3/4" l., 5" d., variable 1/2" edgewise, 20 amp rating ----- | 126.00 | | | .004 mfd. ----- On Request | |
| | 931-6583-004 | 62VC2845 62 UH, 11" l., 5" d., variable 1/2" edgewise, 20 amp rating ----- | 108.00 | | | .005 mfd. ----- On Request | |
| | 402-0029 | LC4 for 1/2" edgewise FA coils ----- | .69 | | | .006 mfd. ----- On Request | |
| | 402-0031 | LC8 for 1/2" edgewise FC coils ----- | 2.25 | | | .008 mfd. ----- On Request | |
| | 402-0033 | RC6 for 3/8" tubing FBT coils ----- | 5.69 | | | .01 mfd. ----- On Request | |
| | 402-0034 | RC8 for 1/2" tubing TCT coils ----- | 6.72 | | | | |
| | 926-5509-003 | M-5521 veeder counter geared type, reads to 1/10 turn, 3/8" shaft diameter. With non-removable crank handle ----- | 46.00 | | | | |
| | 994-6233-001 | Same as above except with removable crank handle ---- | 50.00 | | | | |
| | MICA CAPACITORS | | | | | | |
| G1 | | .0002 mfd. ----- | On Request | | | | |
| | | .0004 mfd. ----- | On Request | | | | |
| | | .0005 mfd. and .001 mfd. --- | On Request | | | | |
| | | .0015 mfd. and .002 mfd. --- | On Request | | | | |
| | | .003 mfd. thru .005 mfd. ---- | On Request | | | | |
| | | .006 mfd. and .01 mfd. ----- | On Request | | | | |
| | | .02 mfd. ----- | On Request | | | | |
| G2 | | .0002 mfd. thru .0005 mfd. - | On Request | | | | |
| | | .001 mfd. thru .006 mfd. ---- | On Request | | | | |
| | | .01 mfd. ----- | On Request | | | | |
| G3 | | .0002 mfd. ----- | On Request | | | | |
| | | .0003 mfd. ----- | On Request | | | | |
| | | .0004 mfd. thru .0008 mfd. - | On Request | | | | |
| | | .001 mfd. thru .008 mfd. ---- | On Request | | | | |
| | | | | | | AUDIO CONTROL CONSOLES | |
| | 79 | 994-6610 | TV-15 Audio Control Console. Complete with housing, 7 mic preamplifiers, 4 booster amplifiers, 2 program amplifiers, 2 monitor amplifiers, 1 cue amplifier, 1 power supply 30 V, 1 power supply 33 V, 1 power supply 24 V, shelf assembly, and 25 feet of inter-connecting cable ----- | On Request | | | |
| | 81 | 994-6866 | Dualux 80, dual programming 8-channel console, complete with three preamplifiers, three boosters, four program A/program B/monitor/cue output modules (interchangeable) and two power supplies ---- | 3,850.00 | | | |
| | | 478-0291 | Speaker matching transformer ----- | 6.03 | | | |
| | 83 | 994-6868 | Four channel side cabinet for Gates' Consoles ----- | On Request | | | |
| | | 994-7052 | Low-level transformer card- | On Request | | | |
| | | 994-6911 | Microphone preamplifier card ----- | 95.00 | | | |
| | 85 | 994-6699 | Gatesway 80, 8-channel console, complete with three preamplifiers, three boosters, three program/monitor/cue output modules (interchangeable) and two power supplies ---- | 3,200.00 | | | |
| | | 478-0291 | Speaker matching transformer ----- | 6.03 | | | |
| | 88 | 994-6996 | Yard 80 console complete with separate power transformer ----- | 2,095.00 | | | |

| CAT. PAGE | TYPE NUMBER | PRODUCT DESCRIPTION | UNIT PRICE | CAT. PAGE | TYPE NUMBER | PRODUCT DESCRIPTION | UNIT PRICE |
|-----------|--------------|--|------------|--------------------|--------------|---|------------|
| 91 | 994-6867-001 | Stereo 80 8-channel stereo console, complete with six preamplifiers, five boosters five program/monitor/cue output modules (interchangeable) and one power supply panel ----- | 4,595.00 | 103 | 994-6642 | Stereo Producer recording mixer, 4 channels complete with preamplifiers, program amplifiers, monitor amplifiers and self-contained power supplies ----- | 1,495.00 |
| | 478-0291 | Speaker matching transformer ----- | 6.03 | | 990-0583 | 100% spare semiconductor kit for the Steren Producer ----- | 57.00 |
| 93 | 994-6540-004 | Stereo Statesman, 5-channel stereophonic audio console, complete with two preamplifiers, five program/monitor/cue modules, three power supply modules, and one transformer panel ----- | 2,795.00 | | 478-0291 | Speaker matching transformer for using external 8-ohm speakers, 48/8 ohms (two required for stereo) ---- | 6.03 |
| 95 | 994-6158-002 | Executive Audio Console (includes 4 speaker matching transformers) ----- | 5,795.00 | 105 | 994-6407-002 | The Producer Recording Mixer ----- | 895.00 |
| | 994-6034 | Optional preamplifier ----- | 112.00 | | 990-0512 | 100% spare semi-conductor kit ----- | 21.10 |
| | 994-5700-003 | Optional program amplifier | 278.00 | | 478-0291 | Speaker matching transformer ----- | 6.03 |
| | 478-0291 | Speaker matching transformer ----- | 6.03 | PROGRAM AUTOMATION | | | |
| | 994-6208 | Optional 3rd VU meter ----- | 96.00 | 109 | 994-6970-001 | KSP-10 Digital System Programmer (60 Hz) ----- | 2,200.00 |
| | 994-6424 | Intercom sub-station ----- | 80.00 | | 994-6970-002 | KSP-10 Digital System Programmer (50 Hz) ----- | 2,210.00 |
| 3 | 994-6377 | Diplomat Audio Console complete with four speaker matching transformers ---- | NLA | | 994-7031-001 | SSC Digital System Switching Center (with 10 channel modules) ----- | 2,475.00 |
| | 994-5700-003 | Optional program amplifier | 278.00 | | 994-6881-001 | Nine Source Extender (less channel modules) ---- | 475.00 |
| | 994-6034 | Optional preamplifier ----- | 112.00 | | 994-6882-001 | Source Channel Module ---- | 70.00 |
| | 478-0291 | Speaker matching transformer ----- | 6.03 | | 994-6883-001 | Booster Amplifier (order one for stereo) ----- | 95.00 |
| | 990-0505 | Spare 100% semiconductor kit ----- | 97.00 | 110 | 900-0225-001 | SC-48 Program Control System, 9 source, 60 Hz. Includes SC-48 control panel and TPG-2 time pulse generator ----- | 2,725.00 |
| | 994-6424 | Studio cue/intercom speaker ----- | 80.00 | | 900-0225-002 | As above, except 50 Hz ---- | 2,735.00 |
| 101 | 994-6769 | Studioette 80 audio console ----- | 1,595.00 | | 900-0146-001 | OPC-3 Overlap program control accessory for SC-48. Provides audio overlap in automation system ----- | 455.00 |
| | 994-6905 | Recommended spare parts kit (100% semi-conductors, fuses, pilot lights) ----- | 62.00 | | 900-0089-002 | RC-48A Remote Control Unit ----- | 160.00 |
| | 478-0291 | Monitor speaker transformer ----- | 6.03 | 111 | 900-0028-003 | Criterion 855-M Multiple Cartridge Unit, monaural -On Request | |
| | 478-0290 | Three monitor speaker transformers ----- | 13.80 | | 900-0029-003 | Criterion 855-S Multiple Cartridge Unit, stereo ----On Request | |
| | 994-5377 | Cueing amplifier with built-in speaker ----- | NLA | | 994-7036-001 | G-824 Multiple Cartridge Unit, monaural ----- | 1,900.00 |

| CAT. PAGE | TYPE NUMBER | PRODUCT DESCRIPTION | UNIT PRICE | CAT. PAGE | TYPE NUMBER | PRODUCT DESCRIPTION | UNI. PRICE |
|-----------|--------------|---|---------------|-----------|--|---|------------|
| | 994-7037-001 | G-824 Multiple Cartridge Unit, stereo ----- | 2,070.00 | | 900-0255-005 | F1-M Fade-In Unit, monophonic. (Requires Criterion 80 audio source) ----- | 710.00 |
| 112 | 994-6969-001 | RA-10 Digital Touch-Control Random Access Programmer ----- | 3,660.00 | | 900-0255-006 | F1-S Fade-In Unit, as above except stereo ----- | 825.00 |
| | 992-3443-001 | Plug-in Dual-Source Interface Card (each card controls two G-824M/S Multiple Cartridge Reproducers - | 150.00 | 115 | 994-7032-001 | APL-G Automatic Program Logging System for use with KSP-10 or SC-48 systems. Includes logging encoder, logging decoder, logging printer, and solid state clock interface card. (A Digital Clock must be used with this system.) | 2,945.00 |
| | 900-0191-002 | RA-1 Random Access Programmer for use with single G-824M/S Multiple Cartridge Reproducer ----- | 1,885.00 | | 994-7032-002 | As above, except 50 Hz ----- | 2,955.00 |
| 113 | 900-0273 | ACC-1 Audio Control Center, monaural. Includes program amplifier. Less monitor amplifier, 25 Hz filter (order separately) ---- | 685.00 | | 900-0040-001 | CG-8 Special Code Generator (optional). Provides 8 different five digit logging codes to identify non-cartridge automation sources such as network, live studio, etc. ----- | 700.00 |
| | 900-0274 | ACC-2 Audio Control Center, stereophonic. Includes two program amplifiers and power supply. Monitor amplifiers and 25 Hz filters must be ordered separately | 920.00 | | 994-6759-001 | Digital Clock (60 Hz line frequency) ----- | 800.00 |
| | 900-0276 | ACC/MON Monitor Amplifier Module. Order 2 for stereo ----- | NLA | | 994-6759-002 | Digital Clock (50 Hz line frequency) ----- | 800.00 |
| | 484-0066 | ACC-F 25 Hz High-Pass Filter. For systems with reel-to-reel music sources. Two required for stereo ---- | 80.00 | | 994-6828-001 | 60 Hz Clock Frequency Standard (optional) ----- | 187.00 |
| | 900-0277 | ACC/SCN Sum Channel Output Package. For ACC-2 units if L + R output desired. Includes 3rd program amplifier module - | 185.00 | | 994-6828-002 | 50 Hz Clock Frequency Standard (optional) ----- | 187.00 |
| 114 | 900-0056-001 | TA-1 Control Panel (also requires 2 Criterion 80 cartridge playback units and either DC-10 Clock or Time Pulse Module) ----- | Not Available | 117 | GATESOUND PRELUDE SERIES TAPES | | |
| | 900-0056-002 | TA-2 Control Panel (also requires 2 Criterion 80 cartridge playback units and Digital Clock)----- | 405.00 | | To order an entire "Prelude" series (200, 300, etc.) simply specify: Series number, reel size, mono or stereo, track configuration, and single or bi-directional. One series furnishes 24 hours of music. To order less than an entire series, you will find it more convenient to use the special order form available on request from Gates. ----- | | NLA |
| | 900-0192-001 | TPM Time Pulse Module --- | 165.00 | | CRITERION 80 TAPE CARTRIDGE SYSTEMS | | |
| | 994-6909-001 | TS-4 Time Selector ----- | 1,160.00 | 121 | 994-6729-001 | MPD-11 Matched Playback and Record Amplifier, monaural, 1000 Hz cue, desk mount, 60 Hz ----- | 1,310.00 |
| | 994-6759-001 | Digital Clock (60 Hz) ----- | 800.00 | | 994-6733-001 | As above, except 50 Hz ----- | 1,320.00 |
| | 994-6759-002 | Digital Clock (50 Hz) ----- | 800.00 | | | | |
| | 900-0044-001 | MDF-M Motor-Driven Fader, monaural ----- | NLA | | | | |
| | 900-0067-001 | MDF-S Motor-Driven Fader, stereo ----- | 590.00 | | | | |

| AT. PAGE | TYPE NUMBER | PRODUCT DESCRIPTION | UNIT PRICE | CAT. PAGE | TYPE NUMBER | PRODUCT DESCRIPTION | UNIT PRICE |
|----------|--------------|---|------------|-----------|-------------|-----------------------------------|------------|
| 121 | 994-6731-001 | MPD-821 Matched Playback and Record Amplifier, stereo, 1000 Hz cue, desk mount, 60 Hz ----- | 1,685.00 | | | | |
| | 994-6701-002 | CPD-811 Playback Unit only, monaural, 1000 Hz cue, desk mount, 60 Hz ---- | 825.00 | | | | |
| | 994-6703-002 | As above, except 50 Hz ---- | 835.00 | | | | |
| | 994-6702-002 | CPD-821 Playback Unit only, stereo, 1000 Hz cue, desk mount, 60 Hz ----- | 1,025.00 | | | | |
| | 994-6704-002 | As above, except 50 Hz ---- | 1,035.00 | | | | |
| | 900-0154-001 | QS-150 150 Hz cue sensor assembly, plugs into basic playback unit for conversion to two tone ----- | 40.00 | | | | |
| | 900-0155-001 | QS-8 8000 Hz cue sensor assembly, plugs into basic playback unit for addition of third tone ----- | 50.00 | | | | |
| | 900-0165-001 | TO-23 150 Hz and 8000 Hz cue oscillator assembly, plugs into record amplifier for conversion to three tone ----- | 130.00 | | | | |
| | 994-6790-001 | Rack Adapter-Playback, adapts any Criterion 80 desk mount playback unit for 19" rack mounting ----- | 10.00 | | | | |
| | 994-6791-001 | Rack Adapter-Record Amplifier, adapts any Criterion 80 desk mount record amplifier for 19" rack mounting ----- | 7.00 | | | | |
| | 900-0024-001 | AMS-4A Automatic Switcher, mono (2 for stereo), four inputs to one output ----- | 160.00 | | | | |
| | 900-0266-001 | RC-T-8 Remote Control with elapsed time indicator. May be used with all Criterion models. Complete record control, 60 Hz ----- | 150.00 | | | | |
| | 900-0266-002 | RC-T-8 as above, except 50 Hz ----- | 160.00 | | | | |
| | 900-0267-001 | RC-RA-8 Remote Control box, may be used with all Criterion models. Complete record control of one unit ----- | 65.00 | | | | |
| | 900-0268-001 | RC-P4-8 Remote Control box, may be used with all Criterion models. For playback control (START only) of up to four units ----- | 65.00 | | | | |
| | | | | | | CRITERION COMPACT | |
| 123 | 994-6794 | Criterion Compact Playback, monaural, desk mount ----- | 700.00 | | | | |
| | 994-6815 | Criterion Compact Playback, stereo, desk mount ----- | 895.00 | | | | |
| | 994-6812 | Rack Mounting Kit, for mounting two Criterion Compact playbacks in a single 19-inch rack ----- | 18.00 | | | | |
| | 994-6816 | Quick-Cue Kit for conversion of Criterion Compact to high-speed cueing ---- On Request | | | | | |
| | 574-0162 | 2nd and 3rd Cue Tone Relay. Add one for each tone desired ----- | 9.20 | | | | |
| | | | | | | CRITERION COMPACT-II | |
| | 994-6901-001 | Record/Playback Unit, mono, 60 Hz ----- | 1,175.00 | | | | |
| | 994-6901-002 | As above, except 50 Hz ---- | 1,185.00 | | | | |
| | 994-6900-001 | Record/Playback Unit, stereo, 60 Hz ----- | 1,400.00 | | | | |
| | 994-6900-002 | As above, except 50 Hz ---- | 1,410.00 | | | | |
| | 994-7067-001 | Rack Mounting Kit for Record/Playback Unit ----- | 18.00 | | | | |
| | 994-6895-001 | Playback Unit only, mono, 60 Hz ----- | 750.00 | | | | |
| | 994-6895-002 | As above, except 50 Hz ---- | 760.00 | | | | |
| | 994-6896-001 | Playback Unit only, stereo, 60 Hz ----- | 850.00 | | | | |
| | 994-6896-002 | As above, except 50 Hz ---- | 860.00 | | | | |
| | 574-0162-000 | 2nd and 3rd cue tone relay for playbacks. Add one for each tone desired ----- | 9.20 | | | | |
| | 994-7068-001 | Rack mounting kit for playback units only ----- | 18.00 | | | | |
| | | | | | | TAPE CARTRIDGE SYSTEM ACCESSORIES | |
| 124 | 900-0266-001 | Remote Control/Timer. Remotely controls most functions of the Criterion 80 Record/Playback System. Has elapsed time indicator ----- | 150.00 | | | | |
| | 900-0267 | Record/Playback Remote Control. Remotely controls all control functions of the Criterion 80 Record/Playback ----- | 65.00 | | | | |

| CAT. PAGE | TYPE NUMBER | PRODUCT DESCRIPTION | UNIT PRICE | CAT. PAGE | TYPE NUMBER | PRODUCT DESCRIPTION | UNI. PRICE |
|-----------|---------------------------------|--|------------|-----------------------------------|---|--|------------|
| 124 | 900-0268 | Playback Remote Control. For remotely operating up to four Criterion 80 Playback units ----- | 65.00 | | | | |
| | 994-6817 | Playback Remote Control. For remotely operating up to four Criterion Compact Playback units ----- | 70.00 | | | | |
| | 900-0024 | AMS-4A Automatic Master Switcher. Up to four Criterion 80 units can be switched into one console input through this panel ---- | 160.00 | | | | |
| | 732-0223 | TD-1A Tape Eraser ----- | 55.00 | | | | |
| | 732-0272 | TD-2 Tape Degausser ----- | 495.00 | | | | |
| | TAPE CARTRIDGES AND ACCESSORIES | | | | | | |
| 125 | 900-0077 | A-300, 40 second cartridge- | 2.35 | | | | |
| | 900-0078 | A-300, 70 second cartridge- | 2.50 | | | | |
| | 900-0079 | A-300, 100 second cartridge | 2.55 | | | | |
| | 900-0080 | A-300, 2½ minute cartridge | 2.75 | | | | |
| | 900-0081 | A-300, 3½ minute cartridge | 2.85 | | | | |
| | 900-0082 | A-300, 5½ minute cartridge | 3.15 | | | | |
| | 900-0083 | A-300, 10½ minute cartridge ----- | 4.20 | | | | |
| | 900-0084 | B-600, 16 minute cartridge - | 6.95 | | | | |
| | 900-0085 | C-1200, 31 minute cartridge | 11.25 | | | | |
| | 900-0302 | A-300, Empty cartridge ---- | 1.80 | | | | |
| | 900-0303 | B-600, Empty cartridge ---- | 3.00 | | | | |
| | 900-0304 | C-1200, Empty cartridge --- | 4.45 | | | | |
| | 994-6430 | Cartridge pressure pads ---- | 10.00 | | | | |
| | 646-0764 | Cartridge labels, white, 250 | 2.30 | | | | |
| | 646-0765 | Cartridge labels, red, 250 -- | 2.30 | | | | |
| | 646-0766 | Cartridge labels, green, 250 | 2.30 | | | | |
| | 646-0767 | Cartridge labels, yellow, 250 | 2.30 | | | | |
| | 900-0090 | FAL-1A test cartridge. Full track, for mono or stereo systems. Includes tones for Azimuth alignment, frequency response and standard level reference ----- | 32.00 | | | | |
| | TAPE CARTRIDGE STORAGE UNITS | | | | | | |
| | 994-6887 | Gates' wall mount cartridge rack provides for storage of 100 Series 300 cartridges --- | 52.00 | | | | |
| | 994-5986 | Gates' storage rack mounts in only 10½" of standard rack space. Holds 40 A-300 cartridges ----- | 59.00 | | | | |
| | | | | 730-1189 | SECR-72 cartridge storage cabinet. For 72 A-300 cartridges. Rotates on ball bearings. 22" H x 11" W x 11" D ----- | 79.00 | |
| | | | | 730-1190 | SECR-200 storage cabinet. Stores 200 A-300 cartridges. Rotates on ball bearings. 29½" H x 15¾" W x 15¾" D ----- | 116.00 | |
| | | | | 730-1492 | Wire cartridge rack. Holds 50 cartridges. 60" H x 5" W x 7" D ----- | 35.00 | |
| | | | | 730-1493 | Lazy Susan Cartridge Rack Base. Holds up to 10 wire cartridge racks ----- | 52.50 | |
| | | | | 12" TRANSCRIPTION TURNTABLES | | | |
| | | | | 126 | 994-6604-001 | CB-1200 12-inch transcription turntable, chassis only, 60 Hz ----- | 225.00 |
| | | | | | 994-6604-002 | CB-1200 12-inch transcription turntable, chassis only, 50 Hz ----- | 235.00 |
| | | | | 16" MONOPHONIC SYSTEM COMPONENTS | | | |
| | | | | 127 | 994-5739-003 | CB-500 16" turntable chassis only, 60 Hz (50 Hz available) ----- | 500.00 |
| | | | | | 723-0269 | Gray 306 16" Micro-Trak tone arm ----- | 87. |
| | | | | | 723-0236 | Shure M-44-7 stereo dynetic cartridge with .0007" diamond stylus ----- | 19.95 |
| | | | | | 994-6690 | IC turntable preamplifier --- | 150.00 |
| | | | | 16" STEREPHONIC SYSTEM COMPONENTS | | | |
| | | | | | 994-5739-003 | CB-500 turntable chassis only, 60 Hz (50 Hz available) | 500.00 |
| | | | | | 723-0269 | Gray 306 16" Micro-Trak tone arm ----- | 87.50 |
| | | | | | 723-0236 | Shure M-44-7 stereo dynetic cartridge with .0007" diamond stylus ----- | 19.95 |
| | | | | | 994-6977 | IC turntable preamplifier --- | 275.00 |
| | | | | 12" MONOPHONIC SYSTEM COMPONENTS | | | |
| | | | | | 994-6604-001 | CB-1200 turntable, chassis only, 60 Hz (50 Hz available) | 225.00 |
| | | | | | 723-0317 | TA-12 12" tone arm ----- | 69.50 |
| | | | | | 723-0236 | Shure M-44-7 stereo dynetic cartridge with .0007" diamond stylus ----- | 19.95 |

| AT. PAGE | TYPE NUMBER | PRODUCT DESCRIPTION | UNIT PRICE | CAT. PAGE | TYPE NUMBER | PRODUCT DESCRIPTION | UNIT PRICE |
|---------------------------------------|--------------|--|------------|-----------------------------|---|---|------------|
| | 994-6690 | IC turntable preamplifier --- | 150.00 | 137 | 994-6629-004 | Solid Statesman Automatic Gain Control Amplifier ----- | 825.00 |
| 12" STEREPHONIC SYSTEM COMPONENTS | | | | | | | |
| 127 | 994-6604-001 | CB-1200 turntable, chassis only, 60 Hz (50 Hz available) | 225.00 | | 994-6629-006 | Matched pair AGC Amplifiers (for stereo) ----- | 1,600.00 |
| | 723-0317 | TA-12 12" tone arm ----- | 69.50 | 138 | 994-6313-002 | M-6313A Preamplifier ---- On Request | |
| | 723-0236 | Shure M-44-7 stereo dynetic cartridge with .0007" diamond stylus ----- | 19.95 | | 994-6314-002 | M-6314A Program/AGC Amplifier ----- | 425.00 |
| | 994-6977 | IC turntable preamplifier --- | 275.00 | | 994-6338 | M-6338 48-volt power supply, 1.5 amp capacity ----- | 350.00 |
| | 994-6449 | Dual turntable pedestal ----- | 340.00 | | 994-6321 | M-6321 Program Amplifier - | 335.00 |
| | 994-6448 | Single turntable pedestal -- | 195.00 | | 994-6421 | M-6421 48-volt power supply, 300 mA capacity ----- On Request | |
| TONE ARMS, PICKUP CARTRIDGES, PREAMPS | | | | | | | |
| 128 | 723-0317 | Gates' TA-12 12-inch transcription tone arm ----- | 69.50 | 139 | 994-6028 | Transistor plug-in preamplifier ----- | NLA |
| | 723-0268 | Gray 303 Micro-Trak 12" tone arm ----- | 79.50 | | 994-6030 | Mounting tray for M-6028 -- | 12.00 |
| | 723-0269 | Gray 306 Micro-Trak 16" tone arm ----- | 87.50 | | 994-5700-003 | Transistor plug-in program amplifier ----- | 278.00 |
| | 723-0236 | Shure M-44-7 stereo dynetic cartridge with .0007" diamond stylus ----- | 19.95 | | 994-6031 | Mounting tray for M-5700 -- | 13.00 |
| | 723-0237 | N-44-7 replacement stylus .0007" diamond ----- | 9.75 | AUDIO AMPLIFIER ACCESSORIES | | | |
| | 723-0306 | M93E Hi-Track Elliptical Cartridge 1½ to 3 grams tracking ----- | 39.95 | 140 | 994-6341 | Mounting tray for M-6313A program amplifier ----- | 12.00 |
| | 723-0307 | N-93E Elliptical replacement stylus ----- | 19.50 | | 994-6426 | Mounting tray for M-6321A program amplifier ----- | 12.00 |
| 129 | 994-6690-001 | IC turntable preamplifier (mono) ----- | 150.00 | | 994-6342 | Mounting tray for M-6314A program/AGC amplifier ---- | 14.00 |
| | 994-6977 | IC turntable preamplifier (stereo) ----- | 275.00 | | 994-6422 | Mounting tray for M-6421 power supply ----- | 12.00 |
| 16" TRANSCRIPTION TURNTABLES | | | | | | | |
| 130 | 994-5739-003 | CB-500 16" turntable, chassis only, 60 Hz ----- | 500.00 | | 994-6344 | Mounting tray for M-6338 power supply ----- | 12.00 |
| | 994-5739-004 | CB-500A 16" turntable, chassis only, 50 Hz ----- | 510.00 | | 994-6689 | Panel and shelf assembly -- | 97.00 |
| PORTABLE AUDIO TURNTABLE-CONSOLE | | | | | | | |
| 131 | 740-0032 | KD-20B turntable/console - | 1,250.00 | AUDIO WIRE | | | |
| AMPLIFIERS | | | | | | | |
| 133 | 994-6543 | Solid Statesman AM Limiting Amplifier ----- | 850.00 | 250-0059 | 8410 Belden single conductor shielded, black rubber jacket ----- per ft. | | .24 |
| 135 | 994-6631-005 | Solid Statesman FM Limiter ----- | 950.00 | 250-0036 | 8412 Belden 2 conductor stranded 20 AWG Braided shield cotton wrap heavy rubber jacket -----per ft. | | .35 |
| | 994-6631-006 | Matched pair of FM Limiters (for stereo) ----- | 1,725.00 | 253-0024 | 8428 Belden neoprene jacketed heavy duty mic cable. 2 conductor 18 AWG braided shield ----- per ft. | | .33 |
| | | | | 253-0018 | SH-2-20-2 conductor stranded 20 AWG, w/push back braided shield not insulated ----- per ft. | | .06 |
| | | | | 253-0001 | 1261 2 conductor stranded 24 AWG, braided shield, not insulated -----per ft. | | .16 |

| CAT. PAGE | TYPE NUMBER | PRODUCT DESCRIPTION | UNIT PRICE | CAT. PAGE | TYPE NUMBER | PRODUCT DESCRIPTION | UNIT PRICE |
|-----------|--------------|---|------------|-----------|--------------|---|------------|
| | 253-0062 | 8437 Belden 2 conductor 22 AWG solid, w/drain wire and braid shield, black vinyl jacket ----- per ft. | .11 | | 994-6716-001 | Rear panel mounting angles (2) for RAK-70A ----- | 15.00 |
| | 253-0054 | 8450 Belden miniature audio cable 2 conductor, 22 AWG solid, drain wire, foil shield, vinyl jacket -----per ft. | .09 | | 992-2539-001 | Panel mounting hardware for RAK-70A ----- | 3.00 |
| | 253-0059 | 8451 Belden miniature audio cable, 2 conductor 22 AWG stranded, drain wire, foil shield, vinyl jacket ----- per ft. | .09 | | 994-6761-001 | RAK-80 basic cabinet assembly ----- | 280.00 |
| | 250-0081 | Cable 6 conductor, 3 pair, wire size 22 AWG -----per ft. | .25 | | 994-6762-001 | Side panel for RAK-80 ----- | 32.00 |
| | 252-0247 | Wire 18 AWG stranded, yellow -----per ft. | .27 | | 994-6892-001 | Louvered top for RAK-80 --- | 6.50 |
| | 255-0006 | High voltage wire 8 AWG 40kV -----per ft. | 5.17 | | 994-6715-001 | Door with louvers for RAK-80 ----- | 53.00 |
| | | RACK CABINETS | | | 994-6715-002 | Door without louvers for RAK-80 ----- | 53.00 |
| 141 | 994-6643-002 | RAK-70 basic cabinet assembly ----- | 235.00 | | 448-0320-000 | Key-type lock for doors for RAK-80 ----- | 4.95 |
| | 994-6664-001 | Side panel for RAK-70 ----- | 35.00 | | 994-6763-001 | Fan kit for RAK-80 ----- | 68.00 |
| | 994-6665-001 | Louvered top for RAK-70 --- | 6.50 | | 448-0288-000 | Air filter (replacement) ----- | 2.00 |
| | 994-6671-001 | Door with louvers for RAK-70 ----- | 57.00 | | 994-6716-001 | Rear panel mounting angles (2) for RAK-80 ----- | 15.00 |
| | 994-6671-002 | Door without louvers for RAK-70 ----- | 57.00 | | 992-2539-001 | Panel mounting hardware -- | 3.00 |
| | 448-0320-000 | Key-type lock for doors for RAK-70 ----- | 4.95 | | 994-5527-003 | RAK-7 rack cabinet ----- | 210.00 |
| | 994-6666-001 | Fan kit for RAK-70 ----- | 73.00 | | 994-5577-001 | Joiner strip for RAK-7 ----- | 20.00 |
| | 994-6668-001 | Air filter kit for RAK-70 ---- | 7.50 | | 994-6582-001 | Extra panel mounting hardware kit for RAK-7 ----- | 5.00 |
| | 994-7035-001 | Rear panel mounting angles (2) for RAK-70 ----- | 15.00 | | | PROGRAM AND MONITORING AMPLIFIERS | |
| | 992-2539-001 | Panel mounting hardware for RAK-70 ----- | 3.00 | 142 | 994-5576-003 | Program amplifier with tubes ----- | 422.00 |
| | 994-6713-001 | RAK-70A basic cabinet assembly ----- | 280.00 | | 990-0450 | 100% spare tube kit ----- | 12.00 |
| | 994-6714-001 | Side panel for RAK-70A ---- | 32.00 | | 994-5575 | Ultra linear monitoring amplifier with tubes ----- | NLA |
| | 994-6665-001 | Louvered top for RAK-70A - | 6.50 | | 990-0303 | 100% spare tube kit ----- | NLA |
| | 994-6715-001 | Door with louvers for RAK-70A ----- | 53.00 | | 478-0291 | Speaker matching transformer ----- | 6.03 |
| | 994-6715-002 | Door without louvers for RAK-70A ----- | 53.00 | 143 | 994-6108 | Eight-watt transistorized monitor amplifier ----- | 225.00 |
| | 448-0320-000 | Key-type lock for doors for RAK-70A ----- | 4.95 | | 994-5530 | Single channel utility amplifier with tubes ----- | 187.00 |
| | 994-6717-001 | Fan kit for RAK-70A ----- | 68.00 | | 612-0194 | Chassis connector (female) | 3.50 |
| | 448-0288-001 | Air filter (replacement) for RAK-70A ----- | 2.00 | | 610-0182 | Microphone connector (male) ----- | 2.18 |
| | | | | | 990-0280 | 100% spare tube kit ----- | 10.00 |
| | | | | | | AUDIO ACCESSORIES | |
| | | | | 144 | 994-5377 | Cueing amplifier with tubes | NLA |
| | | | | | 990-0305 | 100% spare tube kit ----- | NLA |
| | | | | | 994-7001 | Power control panel ----- | 145.00 |
| | | | | | 994-6973 | VU meter panel ----- | 300.00 |
| | | | | | 406-0269 | On Air (in red) ----- | 24.00 |
| | | | | | 406-0278 | Special lettering up to 12 characters (specify) ----- | 34.50 |

| CAT. PAGE | TYPE NUMBER | PRODUCT DESCRIPTION | UNIT PRICE | CAT. PAGE | TYPE NUMBER | PRODUCT DESCRIPTION | UNIT PRICE |
|-----------|-------------|---|------------|-----------|----------------------|---|------------|
| | 406-0285 | On The Air (QF-15 Rollins) - | 51.75 | | 610-0182 | Cable plug, 3 prong, male, (XLR3-12C) ----- | 2.18 |
| | 406-0280 | Studio A (QF-15 Rollins) --- | 51.75 | | 612-0182 | Cable receptacle, female, 3-prong (XLR3-11C) ----- | 2.47 |
| | 406-0281 | Studio B (QF-15 Rollins) --- | 51.75 | | 612-0194 | Chassis receptacle, female, 3-prong (XLR3-13) ----- | 3.50 |
| 145 | 250-0002 | Double patch cord with 2' cord (PJ-12) ----- | 16.00 | | 610-0194 | Chassis receptacle, male, 3-prong (XLR3-14) ----- | 1.61 |
| | 250-0003 | Double patch cord with 3' cord (PJ-13) ----- | 21.50 | | 614-0339 | Audio terminal block for inter-rack or jack field wiring ----- | 20.70 |
| | 250-0004 | Double patch cord with 4' cord (PJ-14) ----- | 22.00 | | 720-0061 | Boom stand without casters | 73.85 |
| | 250-0005 | Double patch cord with 5' cord (PJ-15) ----- | NLA | 147 | 720-0062 | Boom stand with casters --- | 84.55 |
| | 994-6424 | Studio cue/intercom speaker ----- | 80.00 | | 720-0040 | Flexo Mikester ----- | 24.95 |
| | 994-6208 | VU meter for desk or console top ----- | 96.00 | | 721-0003 | BA-200 Brush dual headset | 28.15 |
| | 478-0291 | Speaker matching transformer ----- | 6.03 | | 721-0004 | BA-201 Brush single headset ----- | 23.15 |
| | 612-0307 | Jack strip only (PJ-343), 24 jacks or 12 pairs (no jack mat required) ----- | 58.07 | | 721-0006 | TRIM dual headset ----- | 9.90 |
| | 612-0306 | Jack strip only (PJ-341), 48 jacks or 24 pairs (less mat) - | 96.02 | | 721-0009 | BA-206B stereo headset --- | 39.00 |
| | 994-4399 | Jack mat for one PJ-341 jack strip (PD-1) ----- | 13.25 | | 610-0273 | 511 TRIM headphone plug - | .92 |
| | 994-4400 | Jack mat for two PJ-341 jack strips (PD-2) ----- | 20.00 | | 720-0028 | Model 419 desk stand ---Not Available | |
| | 994-4401 | Jack mat for three PJ-341 jack strips (PD-3) ----- | 27.50 | | 720-0029 | Model 420 desk stand ----- | 19.80 |
| | 994-6891 | Pre-wired jack panel and terminal board ----- | 265.00 | | 720-0248 | Model 421 desk stand ----- | 14.10 |
| 146 | 448-0134 | C-540 disc cabinet holds 540 12" LP's ----- | 411.00 | | 720-0076 | DS-7 desk stand ----- | 6.05 |
| | 448-0230 | LP album cabinet, holds sixty albums ----- | 57.00 | | 720-0035 | DS-5 desk stand ----- | 3.95 |
| | 448-0231 | As above, with snap catch door ----- | 66.90 | | 720-0150 | TS-8 banquet stand ----- | 11.35 |
| | 448-0130 | Double-door reel storage cabinet for up to 288 7" reel boxes ----- | 207.00 | | 732-0099 | "Stereo 4" tape splicer ----- | 9.97 |
| | 448-0178 | Double-door reel storage cabinet for up to 192 10 1/2" reel boxes ----- | 216.00 | | 732-0167 | Edit-all splicing kit ----- | 10.00 |
| | 448-0043 | Sectional tape storage cabinet ----- | 24.75 | | 720-0048 | MS-25 professional floor stand ----- | 31.15 |
| | 448-0074 | Sectional tape storage cabinet ----- | 19.50 | | 720-0047 | MS-10C utility floor stand - | 11.00 |
| | 612-0188 | Single 3-prong connector, female, 1 wall plate (XLR3-35) ----- | 6.21 | | 720-0059 | BB-1 "Baby Boom" stand -- | 8.35 |
| | | | | | 732-0096 | HE-11M Bulk tape eraser --- | 31.00 |
| | | | | | 732-0043 | Adaptor hub for 10 1/2" reels for above ----- | 3.15 |
| | | | | | 730-0102 | Jiffy tape eraser ----- | 28.75 |
| | | | | | 730-0180 | Model 400 tape head demagnetizer ----- | NLA |
| | | | | | SPEAKERS AND BAFFLES | | |
| | | | | 148 | 722-0051 | Studio loudspeaker monitoring system (Electro-Voice Sentry IIA) ----- | 231.55 |
| | | | | | 722-0044 | Studio loudspeaker monitoring system (Electro-Voice Sentry IA) ----- | 231.55 |

| CAT. PAGE | TYPE NUMBER | PRODUCT DESCRIPTION | UNIT PRICE | CAT. PAGE | TYPE NUMBER | PRODUCT DESCRIPTION | UNI. PRICE |
|-------------|-------------|--|------------|-------------------|-------------|---|------------|
| 148 | 722-1200 | GRS-1200 12" 8 ohms, 4.64 oz. magnet, 13 watts, 45-18,000 Hz ----- | 11.25 | 720-0268 | | Gates G-700 microphone, dynamic omnidirectional, response 50-15,000 Hz ----- | 57.50 |
| | 722-0800 | GRS-800 8" 8 ohms, 2.64 oz. magnet, 11 watts, 50-12,000 Hz. ----- | 10.25 | 720-0269 | | Gates G-800 microphone, dynamic cardioid, response 90-13,000 Hz ----- | 84.50 |
| | 478-0250 | TR-15 speaker matching transformer ----- | 8.51 | 720-0197 | | Gates G-500 microphone, miniature lavalier, dynamic, response 50-12,000 Hz ----- | 49.50 |
| | 478-0291 | Speaker matching transformer for all Gates consoles, 45 to 50 ohms primary; 8 ohms secondary - | 6.03 | 250-0036 | | 8412 Belden 2 conductor stranded 20 AWG braided shield cotton wrap heavy rubber jacket ----- per ft. | .35 |
| | 554-0227 | T-8 Mallory 8 ohm speaker control (T-pad) ----- | 9.36 | 253-0018 | | SH-2-20 2 conductor stranded 20 AWG w/push back braided shield not insulated -----per ft. | .06 |
| | 554-0180 | T-4 Mallory 4 ohm speaker control (T-pad) ----- | 9.36 | 253-0054 | | 8450 Belden miniature audio cable, 2 conductor, 22 AWG. Drain wire, foil shield, vinyl jacket ---per ft. | .09 |
| 149 | 725-0012 | DWB-8A 8" wood wall baffle (blond) ----- | 9.00 | 253-0059 | | 8451 Belden miniature audio cable. As above, except solid conductor per ft. | .09 |
| | 725-0011 | DWB-8A 8" wood wall baffle (walnut) ----- | 9.00 | 151 720-0285 | | DL42 microphone ----- | 349.20 |
| | 725-0009 | DWB-12A 12" wood wall baffle (blond) ----- | 13.75 | 720-0271 | | Model RE51 microphone with two microphone tubes and battery-powered transistor amplifier ----- | 90. |
| | 725-0028 | DWB-12A 12" wood wall baffle (walnut) ----- | 13.75 | 720-0272 | | Model SM53 microphone, dynamic cardioid ----- | 153.00 |
| | WB-4/5D | For 6" speaker, maximum speaker depth 2 3/4". Shpg. wt. for 2, 3 lbs -----ea. | 4.65 | 720-0240 | | Model RE-15 microphone, complete with 18-foot cable XLR3-11 connector, metal carrying case, and clamp -- | 180.00 |
| | WB-6D | For 6" speaker, maximum speaker depth 3 3/8". Shpg. wt. for 2, 4 lbs. ----- ea. | 5.20 | 720-0228 | | Model SM58 microphone, dynamic cardioid, with built-in windscreen, cable, connector and stand adapter ----- | 107.40 |
| | WB-8D | For 8" speaker, maximum speaker depth 4 3/8". Shpg. wt. for 2, 6 lbs. ----- ea. | 5.95 | REMOTE AMPLIFIERS | | | |
| | WB-10D | For 10" speaker, maximum speaker depth 5 1/4". Shpg. wt. for 2, 8 lbs. ----- ea. | 8.50 | 153 994-6434 | | Dynamote "70" 4-channel remote, transistor, less batteries ----- | NLA |
| | WB-12D | For 12" speaker, maximum speaker depth 6 3/8". Shpg. wt. for 2, 11 lbs. -----ea. | 9.00 | 610-0182 | | Microphone plugs, male (four required) ----- | 2.18 |
| 149 | 725-0087 | SCB-8D 8" slanting corner baffle (walnut) ----- | 13.75 | 660-0020 | | Battery complement for Dynamote "70", consisting of 12 batteries -----ea. | .38 |
| | 725-0088 | SCB-8D 8" slanting corner baffle (blond) ----- | 13.75 | 660-0021 | | Battery complement for Dynamote "70", consisting of 2 batteries -----ea. | .38 |
| | 725-0105 | SCB-12D 12" slanting corner baffle (blond) ----- | 18.25 | | | | |
| | 725-0104 | SCB-12D 12" slanting corner baffle (walnut) ----- | 18.25 | | | | |
| MICROPHONES | | | | | | | |
| 150 | 720-0267 | Gates G-600 microphone, dynamic omnidirectional, response 80-13,000 Hz ----- | 48.50 | | | | |

| CAT. PAGE | TYPE NUMBER | PRODUCT DESCRIPTION | UNIT PRICE | CAT. PAGE | TYPE NUMBER | PRODUCT DESCRIPTION | UNIT PRICE |
|--------------------------|--------------|---|------------|-----------|--|---|------------|
| | 725-0128 | Vinyl cover for Dynamote "70" ----- | 18.50 | 730-1168 | AG-440B-1 (4010131-09) half track, console mounted, 7.5/15 IPS, 60 Hz ----- | * | |
| | 994-6435 | In-line power supply for 117 volt operation ----- | 75.00 | 730-1170 | AG-440B-2 (4010132-01) two track stereo, unmounted, 7.5/15 IPS, 60 Hz ----- | * | |
| 154 | 994-6600 | M-6600 single channel remote amplifier, less batteries ----- | 125.00 | 730-1171 | AG-440B-2 (4010132-03) as above, console mounted ----- | * | |
| | 660-0022 | Battery for M-6600 (2 required) ----- | 2.64 | 730-1172 | AG-440B-2 (4010132-13) two track stereo, plus quarter track playback, unmounted, 7.5/15 IPS, 60 Hz ----- | * | |
| 155 | 994-3663 | SA-131 proof of performance package, consists of one each Model 210, M-3625 and Model 410 ----- | * | 730-1173 | AG-440B-2 (4010132-15) as above, console mounted ----- | * | |
| | 700-0045 | Model 210 audio oscillator ----- | 330.00 | 730-1174 | AG-440B-2 (4010132-07) two track stereo, unmounted, 3.75/7.5 IPS, 60 Hz ----- | * | |
| | 994-3625 | Model 3625 gain set ----- | * | 730-1175 | AG-440B-2 (4010132-09) as above, console mounted ----- | * | |
| | 700-0040 | Model 410 distortion meter ----- | 370.00 | 730-1181 | AG-445B-1 (4010141-19) half track, unmounted, 3.75/7.5 IPS, 60 Hz ----- | * | |
| | 994-3626-002 | Pickup coil and rectifier (optional for AM only) ----- | 210.00 | 162 | 730-0963 | AG-500-1, (4010048-02) full track, unmounted, 7.5/15 IPS, 60 Hz ----- | 1,645.00 |
| AUDIO EQUIPMENT CABINETS | | | | | 730-0964 | AG-500-1, (4010048-04) as above, except half-track heads ----- | 1,645.00 |
| 156 | 994-6454 | "Combo" desk system, complete with two double pedestals and top section. (Note: Combo systems shipped less cutouts) ----- | 810.00 | 730-0965 | AG-500-1 (4010048-06) full track, unmounted, 3.75/7.5 IPS, 60 Hz ----- | 1,645.00 | |
| 159 | 994-6448-001 | Single pedestal less cutouts ----- | 195.00 | 730-0966 | AG-500-1 (4010048-08) as above, except half-track heads ----- | 1,645.00 | |
| | 994-6449-001 | Double pedestal less cutouts ----- | 340.00 | 730-0967 | AG-500-2 (4010049-02) stereo. Two-track stereo, unmounted. 7.5/15 IPS, 60 Hz ----- | 1,925.00 | |
| | 994-6453-002 | 10½" metal grill. 90-day delivery ----- | 8.50 | 730-0968 | AG-500-2 (4010049-06) stereo, as above, except 3.75/7.5 IPS speed ----- | 1,925.00 | |
| | 994-6453-003 | 5¼" metal grill. 90-day delivery ----- | 8.00 | 730-0970 | 4150161-01 portable case for AG-500 single channel recorders ----- | 110.00 | |
| | 994-6453-004 | 3½" metal grill. 90-day delivery ----- | 8.00 | 730-0971 | 415023-01 portable case for AG-500-2, two channel recorders ----- | 140.00 | |
| | 994-6450 | Uniform top section, complete with mounting angles and cable trough ----- | 150.00 | 730-1018 | AG-600-B NAB equalization, full track, unmounted, 60 Hz, 117 volt. 4010063-01 ----- | 840.00 | |
| | 994-6456 | Double leg assembly ----- | 26.00 | | | | |
| | 994-6455 | Single leg assembly ----- | 14.00 | | | | |
| TAPE RECORDERS | | | | | | | |
| 160 | | GBR-10/GBR-15 ordering information and prices available on request. | | | | | |
| 161 | 730-1164 | AG-440B-1 (4010131-01) full track, unmounted, 7.5/15 IPS, 60 Hz ----- | * | | | | |
| | 730-1165 | AG-440B-1 (4010131-03) as above, console mounted ----- | * | | | | |

*Write for information on current product.

| CAT. PAGE | TYPE NUMBER | PRODUCT DESCRIPTION | UNIT PRICE | CAT. PAGE | TYPE NUMBER | PRODUCT DESCRIPTION | UNI. PRICE |
|-----------|-------------|---|------------|-----------|--------------|---|------------|
| | 730-1019 | AG-600-B NAB equalization, full track, portable, 60 Hz, 117 volt. 4010063-02 ----- | 960.00 | | 730-0924 | 280-2 as 730-0923 except stereo ----- | On Request |
| | 730-1020 | AG-600-B NAB equalization, half track, unmounted, 60 Hz, 117 volt. 4010063-03 ----- | 840.00 | | 730-0925 | 280-1 (SP-14) rack mount record/reproduce, mono, with 1/2 track mono head assembly, solid state, 14" reel capability ----- | On Request |
| | 730-1021 | AG-600-B NAB equalization, half track, portable, 60 Hz, 117 volt. 4010063-04 ----- | 960.00 | 164 | 730-1459-000 | Revox A77 MK3, Model 1102SSP Recorder/Reproducer. 2-track stereo, 3 3/4 and 7 1/2 ips. Deck with wood cabinet and stainless steel faceplate ----- | 969.00 |
| | 730-1022 | AG-600-B 2 channel, two track, one half track stereo. NAB equalization, unmounted, 60 Hz, 117 volt. 4010064-01 ----- | 1,200.00 | | 730-1460-000 | Same as above, Model 1104SSP, 1/4 track, 2 channel, stereo ----- | 969.00 |
| | 730-1023 | AG-600-B two channel, two track, one half track stereo, NAB equalization, portable, 60 Hz, 117 volt. 4010064-02 ----- | 1,320.00 | | 730-1448-000 | Revox A77 MK3, Model 1302SSP Recorder/Reproducer Deck with metal case for custom mounting or rack mounting with adapter. 2-track stereo with stainless steel faceplate, 3 3/4 and 7 1/2 ips ----- | 969.00 |
| | 730-1026 | AG-600-B, two channel, four track, one quarter track stereo. NAB equalization. Unmounted. 60 Hz 117 volt. 4010064-03 ----- | 1,200.00 | | 730-1483-000 | Operator's manual (included with each machine) ----- | 4.65 |
| | 730-1027 | AG-600-B, two channel, four track, one quarter track stereo. NAB equalization. Portable, 60 Hz, 117 volt. 4010064-04 ----- | 1,320.00 | | 730-1451-000 | Service Manual, complete schematics, parts lists, service information ----- | 15.00 |
| 163 | 730-0927 | 270-1 rack mount reproducer, mono, with 1/2 track head assembly. Solid state with 14" reel capability standard. Includes foil sensing and automatic reversing ----- | 2,150.00 | | 730-1453-000 | 19" rack mount (for 1300 type) ----- | 19.00 |
| | 730-0928 | 270-2 rack mount reproducer, stereo, for 14" reel -- | 2,250.00 | | 730-1570-000 | NAB locking reel adapter for 3" center reel (order 2 per reproducer) ----- | 10.00 |
| | 730-0923 | 280-1 rack mount record/reproduce, mono, with 1/2 track head assembly, solid state, 10 1/2" reel capability ----- | On Request | | 730-1484-000 | 10 1/2" Revox reels (empty, standard center) ----- | 4.75 |
| | | | | | 730-1456-000 | Model 1610 Remote control, 30-ft. cord ----- | 41.50 |
| | | | | 168 | 994-6734-001 | SW-100, 100,000-watt short wave broadcast transmitter ----- | On Request |
| | | | | 169 | 994-6808-001 | SW-50, 50,000 watt short wave broadcast transmitter ----- | On Request |
| | | | | 171 | 994-4748 | HF-20B short wave broadcast transmitter, 4-22 MHz. For operation from 230 V, 3 phase, 50 Hz. Complete with one set coils, one set tubes, less crystals ----- | NLA |

| CAT. PAGE | TYPE NUMBER | PRODUCT DESCRIPTION | UNIT PRICE | CAT. PAGE | TYPE NUMBER | PRODUCT DESCRIPTION | UNIT PRICE |
|-----------|-------------|--|------------|-----------|-------------|--|-------------------|
| | 994-4778A | HF-20BX short wave broadcast transmitter, 4-22 MHz. For operation from 230 V, 3 phase, 50 Hz. Complete with one set coils, one set tubes, less crystals. With keyer added ----- | NLA | | 990-0253 | 100% spare tube kit for all models ----- | NLA |
| | 994-4778B | HF-20CX, 20 kW telephone and telegraph transmitter, with tubes and keyer, 4-22 MHz, less crystals ----- | NLA | | CR27A/U | Crystal and holder (.02% accuracy). Specify operating frequency ----- | NLA |
| | 990-0139 | 100% spare tube kit for HF-20B ----- | NLA | | JK-09C | Temperature controlled oven, holds two CR27A/U crystals (.003% accuracy) - | NLA |
| | 990-0140 | 100% spare tube kit for HF-20BX ----- | NLA | | | | |
| | CR27A/U | Crystal and holder, .02% accuracy (specify operating frequency) ----- | NLA | | | | |
| | JK-09C | Temperature controlled crystal oven holds two CR27A/U crystals for 0.003% accuracy ----- | NLA | | | | |
| | | | | | | SINGLE SIDEBAND AND COMMUNICATIONS TRANSMITTERS | |
| 172 | 994-3787 | HF-10B complete broadcast transmitter, 2-22 MHz. 10 kW. for operation from 230 V, 3 phase, 60 Hz. Complete with coils, one set tubes, less crystals. With oil filled external components ----- | NLA | 174 | 994-6562 | SG-75A synthesized communications exciter, output 100 MW, frequency 2 to 30 MHz in 100 Hz steps, rack mounting Qty. 1-4 -----ea. Qty. 5-9 -----ea. Qty. 10-25 -----ea. | NLA NLA NLA |
| | 994-3789 | HF-10BX complete broadcast transmitter, with electronic keyer added. 2-22 MHz. For operation from 230 V, 3 phase, 60 Hz. Complete with coil set, one set tubes, less crystals ----- | NLA | 175 | 994-6411 | SG-70 ISB high frequency exciter Qty. 1-4 -----ea. Qty. 5-9 -----ea. Qty. 10-25 -----ea. | NLA NLA NLA |
| | 994-3793 | HF-10CX 10 kW communications telephone and telegraph transmitter, 2-22 MHz. For operation from 230 V, 3 phase, 60 Hz. Complete with coil set, one set tubes, less crystals ----- | NLA | | 990-0517 | Complete set of spare tubes ----- | NLA |
| | 994-3795 | HF-10TX 10 kW telegraph transmitter, 4-30 MHz. For operation from 230 V, 3 phase, 60 Hz. Complete with one coil set, tubes, less crystals ----- | NLA | 177 | 994-6506 | ATL-10, 10,000-watt automatically tuned ISB, HF power amplifier Qty. 5-9 -----ea. Qty. 10-25 -----ea. | NLA NLA |
| | | | | | 990-0574 | 100% spare tube kit ----- | NLA |
| | | | | 179 | 994-6566 | STAR-10, 10,000-watt automatically tuned ISB HF transmitter Qty. 5-9 -----ea. Qty. 10-25 -----ea. | NLA NLA |
| | | | | | 990-0574 | 100% tube kit ----- | NLA |
| | | | | 180 | 994-6418 | ST-1A sideband transmitter. 1000 watts, with tubes, less crystals and cabinet. Equipped with slides for 19" rack mounting Qty. 1-4 -----ea. Qty. 5-9 -----ea. Qty. 10-25 -----ea. | NLA NLA NLA |

| CAT. PAGE | TYPE NUMBER | PRODUCT DESCRIPTION | UNIT PRICE | CAT. PAGE | TYPE NUMBER | PRODUCT DESCRIPTION | UNI. PRICE |
|-----------|-------------|--|------------|-----------|--------------|--|------------|
| | 990-0519 | Complete set of spare tubes | On Request | | | | |
| | 952-5967 | Cabinet for ST-1A Qty. 1-4 -----ea. NLA Qty. 5-9 -----ea. NLA Qty. 10-25 -----ea. NLA | | | | | |
| 181 | 994-6492 | ST-3A sideband transmitter. 3000 watts, with tubes, less crystals for 3 phase power source, without roll out base Qty. 1-4 -----ea. NLA Qty. 5-9 -----ea. NLA Qty. 10-25 -----ea. NLA | | | | | |
| | 994-6492B | ST-3A (same as above) with 78 dB factory installed harmonic filter ----- NLA | | | | | |
| | 990-0520 | Spare 100% tube kit ----- NLA | | | | | |
| | 478-0246 | HFT-5K, 5 kW transformers, 10 kW PEP, matching 50 ohms to 600 ohms --- NLA | | | | | |
| | 994-6477 | Roll out base for HFL-3000 or ST-3A transmitter Qty. 1-4 ----- NLA Qty. 5-9 ----- NLA Qty. 10-25 ----- NLA | | | | | |
| 182 | 994-6161 | HFL-1000, 1kW linear amplifier, complete with tubes, less cabinet. Equipped with slides for 19" rack mounting Qty. 1-4 -----ea. NLA Qty. 5-9 -----ea. NLA Qty. 10-25 -----ea. NLA | | | | | |
| | 952-5894 | Cabinet for HFL-1000 transmitter Qty. 1-4 -----ea. NLA Qty. 5-9 -----ea. NLA Qty. 10-25 -----ea. NLA | | | | | |
| | 990-0447 | 100% spare tube kit ----- NLA | | | | | |
| 183 | 994-6466A | HFL-3000, 3 kW linear amplifier, complete with tubes, less roll out base. With 3 phase power sources Qty. 1-4 -----ea. NLA Qty. 5-9 -----ea. NLA Qty. 10-25 -----ea. NLA | | | | | |
| | 994-6466B | HFL-3000 with optional filter ----- NLA | | | | | |
| | 994-6477 | Roll out base for HFL-3000 or ST-3A transmitter Qty. 1-4 -----ea. NLA Qty. 5-9 -----ea. NLA Qty. 10-25 -----ea. NLA | | | | | |
| | 990-0531 | 100% spare tube kit ----- NLA | | | | | |
| | | | | | | REMOTE CONTROL SYSTEM AND ACCESSORIES | |
| | | | | 186 | 994-5862-001 | RDC-10AC, remote control system including studio unit, transmitter unit, plate current and voltage kits and one tower light metering unit. Unit provides total of 23 control functions. Ten metering positions are available. Four are permanently used for the fundamental readings ----- | 1,550.00 |
| | | | | | 994-5862-002 | RDC-10AC remote control system including studio unit and transmitter unit only ----- | 1,400.00 |
| | | | | | 994-6112 | M-6112 AM antenna diode for all powers. (Inductive coupled unit) ----- | 112.00 |
| | | | | | 994-4703-001 | M-4703 motor and rheostat assembly for most 250 watt transmitters ----- | 205.00 |
| | | | | | 994-4703-002 | M-4703 motor and rheostat assembly for most 500 watt transmitters ----- | 215.00 |
| | | | | | 994-4703-003 | M-4703 motor and rheostat assembly for most 1000 watt transmitters ----- | 225.00 |
| | | | | | 994-5066 | M-5066 tuning motor, 7 RPM, 5 wire (generally used for coupling to an existing variable capacitor or inductor, to control transmitter output or loading) ----- | 285.00 |
| | | | | | 994-4806 | M-4806 relay assembly to control one 5 wire motor --- | 107.00 |
| | | | | | 994-4720 | M-4720A plate current metering kit ----- | 85.00 |
| | | | | | 994-4719 | M-4719A plate voltage metering kit ----- | 90.00 |
| | | | | | 994-5145 | M-5145 tower light metering kit ----- | 90.00 |
| | | | | 187 | 994-6863 | Frequency monitor extension meter for M-6698 ----- | 230.00 |
| | | | | | 994-6864 | Frequency monitor extension meter for M-6865 ----- | 67.00 |
| | | | | | 994-5631 | Frequency monitor extension meter for M-4990 ----- | 140.00 |
| | | | | | 994-6687 | Remote meter for M-6659 modulation monitor ----- | 138.00 |
| | | | | | 994-5836B | Remote meter for M-5774 modulation monitor ----- | 150.00 |

| CAT. PAGE | TYPE NUMBER | PRODUCT DESCRIPTION | UNIT PRICE | CAT. PAGE | TYPE NUMBER | PRODUCT DESCRIPTION | UNIT PRICE |
|-----------|--------------|--|------------|-----------|-------------|---|---------------|
| | 994-5837 | Remote meter for M-5693 modulation monitor ----- | 225.00 | | | REMOTE PICKUP EQUIPMENT | |
| | 994-5249 | Auxiliary relay assembly --- | 107.00 | | | 150 MHz | |
| | 994-5248 | As above, but latching (holding) type with 10 ampere contacts ----- | 107.00 | 193 | 731-0369 | RPT-40 Transmitter, 40-watt, complete with crystal and tuned to frequency. 120 VAC and 12 VDC ----- | 975.00 |
| | 994-4848B | Output loading control kit for BC-5P-2 ----- | 465.00 | | 731-0045 | M30BT/TPS Transmitter Portable mobile, 30 watt, broadcast-quality with c/w tubes, crystal and tuned. 120VAC and 12.6 VDC ----- | 795.00 |
| | 994-6548 | Output loading control kit for BC-5H ----- | 445.00 | | 731-0047 | TPS-TC mobile control for M-30BT/TPS transmitter --- | Not Available |
| | 994-4703-001 | M-4703A motor and rheostat assembly for most 250 watt transmitters ----- | 205.00 | | 710-0087 | ASP-143 bumper mount for MA-1 antenna ----- | 9.95 |
| | 994-4703-002 | M-4703B motor and rheostat assembly for most 500 watt transmitters ----- | 215.00 | | 710-0089 | MA-1 Mobile Single Ring Antenna ----- | 26.00 |
| | 994-4703-003 | M-4703C motor and rheostat assembly for most 1000 watt transmitters ----- | 225.00 | | 710-0088 | PA-1 Portable Single Ring Antenna ----- | 26.00 |
| | 994-6326 | M-6326 motor assembly for output control of BC-1G --- | 225.00 | | 731-0046 | MR-30/150-170 Receiver, Rack Mount, broadcast-quality continuous-duty, with tubes, crystal and tuned. 120 VAC, 600 ohm output ----- | NLA |
| | 994-5066 | M-5066 tuning motor, 7 RPM, 5 wire (generally used for coupling to an existing variable capacitor or inductor, to control transmitter output or loading) ----- | 285.00 | | 710-0086 | RA-4 4-bay Base Antenna -- | 170.00 |
| | 994-4800 | M-4800 tuning motor assembly, 3 wire motor, 1 RPM for a rheostat and other control (similar to that used on above motor and rheostat assemblies) -- | 140.00 | | 618-0171 | FHJ4-50B Heliac foam filled, 1/2", jacketed transmission line ----- per ft. | .97 |
| | 994-4825 | M-4825 AC voltage metering kit ----- | 90.00 | | 620-0301 | 44AU UHF jack, for use with FHJ4-50B ----- | 7.90 |
| | 994-4720-002 | M-4720A plate current metering kit ----- | 85.00 | | 731-0218 | PG-4A pigtail, 4' RG-8A/U cable with plugs ----- | 10.00 |
| | 994-5145 | Tower light metering kit --- | 90.00 | | 731-0182 | PG-4B pigtail, 4' RG-8A/U cable with connectors ----- | 10.00 |
| | 994-6112 | M-6112 AM antenna diode for all powers (Inductive coupled unit) ----- | 112.00 | | | 450 MHz | |
| | 994-5129 | M-5129 adjustable DC overload relay assembly --- | 50.00 | 193 | 731-0370 | RPT-25 Transmitter, 25-watt, complete with crystal and tuned to frequency. 120 VAC and 12 VDC ----- | 1,625.00 |
| | 994-4845 | M-4845 FM output indicator (diode) ----- | 37.00 | | 731-0254 | M-20BT-TPS Transmitter, Portable-mobile, 20 watt, broadcast-quality, continuous-duty, with c/w tubes, crystal and tuned. 120 VAC and 12.6 VDC ----- | Not Available |
| | 994-4719-002 | M-4719A plate voltage metering kit ----- | 90.00 | | 731-0047 | TPS-TC mobile control for M-20BT/TPS transmitter --- | Not Available |
| 188 | | Studio-Transmitter Link-890-960 MHz ----- | On Request | | 710-0111 | ASP-406 Rooftop antenna, mobile, vertically polarized | NLA |
| 189 | | | | | | | |
| 190 | | Studio-Transmitter Link-942-960 MHz ----- | On Request | | | | |
| 191 | | | | | | | |

| CAT. PAGE | TYPE NUMBER | PRODUCT DESCRIPTION | UNIT PRICE | CAT. PAGE | TYPE NUMBER | PRODUCT DESCRIPTION | UNIT PRICE |
|-----------|-------------|---|---------------|-----------|-------------|-----------------------|------------|
| | 731-0187 | MR-100/450-460 Receiver, Rack Mount, broadcast-quality, 120 VAC. 600 ohm output ----- | On Request | | 374-0109 | Type 4CX1500B ----- | 220.00 |
| | 710-0112 | ASP-313 Base Antenna, colinear, 6 dB gain ----- | 175.00 | | 374-0074 | Type 4CX3000A ----- | 445.00 |
| | 710-0113 | ASP-320 Mounting Clamps for ASP-298 and ASP-313 -- | 10.00 | | 374-0016 | Type 4CX5000A ----- | 530.00 |
| | 618-0172 | FHJ5-50A Heliac, 7/8", 50 ohm jacketed -----per ft. | 2.46 | | 374-0077 | Type 4CX10,000D ----- | 590.00 |
| | 620-0317 | 45AU UHF Jack, for use with FHJ5-50A ----- | 21.60 | | 374-0097 | Type 4CX15,000A ----- | 825.00 |
| | 731-0182 | PG-4B pigtail, 4' RG-8A/U cable with connectors ----- | 10.00 | | 374-0099 | Type 4CX35,000 ----- | 2,400.00 |
| | 731-0257 | PG-4C pigtail, 4' RG-8U UG-21C/U and UG-23B/U connectors ----- | 10.00 | | 374-0120 | Type 5CX1500A ----- | 250.00 |
| | | ACCESSORIES | | | 374-0026 | Type 575A ----- | 28.25 |
| | 720-0187 | SR-90R Turner microphone, carbon, for local control of M-25C ----- | Not Available | | 374-0027 | Type 673 ----- | 27.65 |
| | 731-0199 | RMC-1C remote control console, solid state, complete with transistors, power supply ----- | Not Available | | 374-0030 | Type 807 ----- | 6.05 |
| | 731-0162 | DFT Dual frequency kit for M-30BT, M-30BT/TPS and M-30BT/CD, less crystal ----- | 25.00 | | 374-0031 | Type 810 ----- | 40.00 |
| | 731-0163 | DFR Dual Frequency kit for MR-30BT/150-170 and M-25/150-170C, less crystal ----- | 25.00 | | 374-0034 | Type 813 ----- | 31.70 |
| | 731-0165 | XT-1A Hi-Accuracy Crystal for M-30BT/TPS, M-30BT/CD and M-25C ----- | 17.50 | | 374-0039 | Type 833A ----- | 75.90 |
| | 731-0166 | XR-1A Hi-Accuracy Crystal for MR-30BT/150-170 and M-25/150-170C ----- | 21.00 | | 374-0040 | Type 845 ----- | 38.70 |
| | | TRANSMITTING TUBES | | | 374-0042 | Type 866A ----- | 5.35 |
| 194 | 374-0108 | Type 3CV30,000H3 ----- | 740.00 | | 374-0114 | Type 6076A ----- | 325.00 |
| | 374-0093 | Type 3CX2,500F3 ----- | 225.00 | | 374-0050 | Type 6076 ----- | 350.00 |
| | 374-0008 | Type 4-125 ----- | 54.00 | | 374-0051 | Type 6146A ----- | 7.20 |
| | 374-0009 | Type 4-250A ----- | 57.00 | | 374-0054 | Type 6360A ----- | 7.65 |
| | 374-0010 | Type 4-400A ----- | 61.00 | | 374-0059 | Type 8008XE ----- | 16.50 |
| | 374-0127 | Type 4-400C ----- | 64.50 | | 374-0058 | Type 8008 ----- | 14.00 |
| | 374-0081 | Type 4CX250B ----- | 39.00 | | 374-0118 | Type 8806 ----- | 1,05F 00 |
| | 374-0014 | Type 4CX300A ----- | 70.00 | | 374-0119 | Type 8807 ----- | 1.25 |
| | 374-0015 | Type 4CX1000A ----- | 275.00 | | 374-0124 | Type 8916 ----- | 1,420.00 |
| | | | | | 374-0096 | Type 8122 ----- | 38.05 |
| | | | | | 374-0117 | Type 8792 ----- | 362.00 |
| | | | | | 374-0115 | Type 7289 ----- | 22.00 |
| | | | | | 374-0067 | Type WL5891 ----- | On Request |
| | | | | | | INTEGRATED CIRCUITS | |
| | | | | 195 | 382-0008 | MC836P ----- | 3.45 |
| | | | | | 382-0070 | SN7400N ----- | 1.15 |
| | | | | | 382-0071 | SN7402N ----- | 1.15 |
| | | | | | 382-0072 | SN7403N ----- | 1.15 |
| | | | | | 382-0073 | SN7410N ----- | 1.15 |
| | | | | | 382-0074 | SN7476N ----- | 1.72 |
| | | | | | 382-0075 | N8380B ----- | 5.42 |
| | | | | | 382-0076 | N8288B ----- | 5.17 |
| | | | | | 382-0077 | 8TO4 ----- | 12.07 |
| | | | | | 382-0079 | SN7404N ----- | 1.38 |
| | | | | | 382-0082 | SN7420N ----- | 2.15 |

| CAT. PAGE | TYPE NUMBER | PRODUCT DESCRIPTION | UNIT PRICE | CAT. PAGE | TYPE NUMBER | PRODUCT DESCRIPTION | UNIT PRICE |
|-----------|-------------|-------------------------|------------|-----------|---------------------------|--------------------------|------------|
| 195 | 382-0083 | SN7430N ----- | 1.15 | 195 | 380-0022-000 2N1183 ----- | NLA | |
| | 382-0086 | SN7442N ----- | 5.75 | | 380-0022 | 2N1183A ----- | 6.67 |
| | 382-0087 | SN74100N ----- | 16.06 | | 380-0021 | 2N1183B ----- | 8.34 |
| | 382-0088 | SN74121N ----- | 3.73 | | 380-0013 | 2N1225 ----- | NLA |
| | 382-0094 | SN7445N ----- | 4.14 | | 380-0033 | 2N1306 ----- | 1.56 |
| | 382-0096 | LM309K ----- | 10.77 | | 380-0018 | 2N1307 ----- | 1.46 |
| | 382-0098 | SN7408N ----- | 1.15 | | 380-0014 | 2N1414 ----- | 2.90 |
| | 382-0115 | N8291B ----- | 5.42 | | 380-0019 | 2N1483 ----- | 4.37 |
| | 382-0116 | N8242B ----- | 3.73 | | 380-0016 | 2N1539 ----- | 3.58 |
| | 382-0121 | SN7474N ----- | 2.01 | | 380-0025 | 2N2082 ----- | 6.07 |
| | 382-0123 | SN75451P ----- | 3.47 | | 380-0041 | 2N3054 ----- | 2.36 |
| | 382-0124 | SN75452P ----- | 3.47 | | 380-0043 | 2N3055 ----- | 3.58 |
| | 382-0125 | SN75453P ----- | 3.47 | | 380-0111 | 2N3417 ----- | 1.41 |
| | 382-0126 | SN75454P ----- | 3.47 | | 380-0058 | 2N3440 ----- | 2.24 |
| | 382-0127 | SN75301AP ----- | 4.31 | | 380-0035 | 2N3614 ----- | 3.54 |
| | 382-0128 | N8271B ----- | 6.80 | | 380-0066 | 2N3740 ----- | 4.87 |
| | 382-0129 | N8293B ----- | 12.61 | | 380-0065 | 2N3766 ----- | 4.09 |
| | 382-0130 | MCT-2 ----- | 16.81 | | 380-0045 | 2N4036 ----- | 2.24 |
| | 382-0132 | SN74194N ----- | 10.20 | | 380-0151 | 2N4356 ----- | 1.28 |
| | 382-0133 | SN7432N ----- | 3.39 | | 380-0107 | 2N4905 ----- | 6.83 |
| | 382-0134 | SN73143N ----- | 8.22 | | 380-0112 | 2N5087 ----- | 2.04 |
| | 382-0139 | SN7437N ----- | 3.64 | | 380-0115 | 2N5088 ----- | 1.89 |
| | 382-0140 | SN7440N ----- | .86 | | 380-0174 | 2N5954 ----- | 3.94 |
| | 382-0142 | SN7425N ----- | 3.39 | | 380-0062 | 40310 ----- | 2.30 |
| | 382-0143 | MIRV-42050 ----- | 41.02 | | 380-0100 | 40312 ----- | 2.34 |
| | 382-0145 | SN7427N ----- | 3.39 | | 380-0053 | 40314 ----- | 1.96 |
| | 382-0146 | SN7485N ----- | 20.06 | | 380-0050 | 40317 ----- | 1.54 |
| | 382-0148 | SN74123N ----- | 6.84 | | 380-0044 | 40319 ----- | 2.00 |
| | 382-0149 | N8263B ----- On Request | | | 380-0057 | 40322 ----- | 7.33 |
| | 382-0150 | N8285B ----- | 6.11 | | 380-0097 | 40360 ----- | 1.98 |
| | 382-0154 | MC1801P ----- | 3.73 | | | DIODES | |
| | 382-0156 | N8233B ----- | 6.67 | | 384-0001 | 1N21B ----- On Request | |
| | 382-0159 | SN7407N ----- | 10.06 | | 384-0267 | 1N276 ----- | 1.15 |
| | 382-0160 | SN7413N ----- | 6.98 | | 384-0205 | 1N914 ----- | .86 |
| | | TRANSISTORS | | | 384-0018 | 1N2069 ----- | 1.15 |
| | 380-0011 | 2N214 ----- | 1.64 | | 384-0020 | 1N2071 ----- | 1.15 |
| | 380-0092 | TN323 ----- | 3.16 | | 384-0258 | 1N3254 ----- | 1.01 |
| | 380-0015 | 2N553 ----- | 8.44 | | 384-0261 | 2N5061 ----- | 1.69 |
| | 380-0020 | 2N696 ----- | 1.31 | | 384-0062 | X5AZ ----- Not Available | |
| | 380-0042 | 2N697 ----- | 1.15 | | 384-0255 | T1D-40 ----- | .70 |
| | | | | | 384-0149 | 7030A ----- | 51.75 |

| CAT. PAGE | TYPE NUMBER | PRODUCT DESCRIPTION | UNIT PRICE | CAT. PAGE | TYPE NUMBER | PRODUCT DESCRIPTION | UNI. PRICE |
|-------------------------|-------------|---------------------|------------|-----------|-------------|---------------------|---------------|
| HIGH VOLTAGE RECTIFIERS | | | | 195 | 386-0058 | 1N3024B ----- | 8.09 |
| | 384-0156 | 67-6035 ----- | 85.67 | | 386-0034 | 1N3031B ----- | 8.34 |
| | 384-0154 | 67-6036 ----- | 33.35 | | 386-0089 | 1N3331A ----- | 10.12 |
| | 384-0155 | 67-6037 ----- | 39.67 | | 386-0174 | 1N4730 ----- | 3.18 |
| | 384-0159 | 67-6099 ----- | 69.00 | | 386-0057 | 1N4736 ----- | 3.18 |
| | 384-0167 | 67-6130 ----- | 23.00 | | 386-0106 | 1N4737 ----- | 3.18 |
| | 384-0199 | 67-6136 ----- | 9.77 | | 386-0053 | 1N4746 ----- | 3.16 |
| | 384-0098 | 67-7297 ----- | 708.40 | | 386-0100 | 1N4747A ----- | 4.80 |
| | 384-0184 | 67-7747 ----- | 202.40 | | 386-0055 | 1N4748 ----- | 3.16 |
| | 384-0185 | 67-7800 ----- | 283.36 | | 386-0077 | 1N4749A ----- | 4.87 |
| ZENER DIODES | | | | | 386-0109 | VR20 ----- | 1.23 |
| | 386-0019 | 1N754 ----- | 1.15 | | 386-0069 | 1.5R33A ----- | 6.07 |
| | 386-0016 | 1N2974 ----- | 2.02 | | 386-0075 | 1.5R43B ----- | Not Available |

Rapidly changing conditions may necessitate price corrections from time to time. Therefore, the prices herein are subject to change without notice. All prices are F.O.B. Quincy, Illinois or point of manufacture.

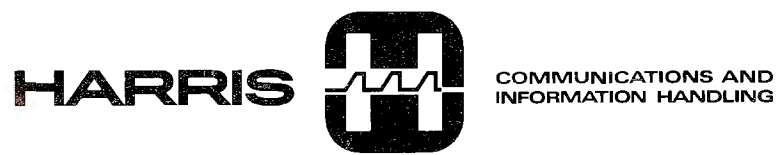



HARRIS CORPORATION Broadcast Equipment Division
123 Hampshire Street, Quincy, Illinois 62301

CP-7M-175

PTD. IN U.S.A.



PRICE LIST

Harris'
Radio and Television
Catalogs . . .
U.S. Prices Only
(Effective November 15, 1977)

Index

| | |
|--|---------|
| AM Transmitters | Page 1 |
| FM Transmitters | Page 3 |
| FM Antennas | Page 4 |
| FM Monitors | Page 6 |
| Audio Control Consoles | Page 7 |
| Tape Cartridge Units | Page 7 |
| Turntables, Processors, Limiters | Page 9 |
| Program Automation | Page 9 |
| H. F. Broadcast Transmitters | Page 11 |
| VHF-TV Transmitters | Page 11 |
| UHF-TV Transmitters | Page 14 |
| Television Antennas | Page 15 |
| Television Cameras | Page 16 |



HOW TO ORDER

This is your price list for equipment in your Harris' Broadcast Products radio and television catalogs. Prices and specifications are subject to change without notice. Firm quotations are available for specific time periods. All prices are F.O.B. Quincy, Illinois, or point of shipment.

ORDERING PROCEDURE: Orders may be placed using your formal purchase order or letterhead stationery. Orders may also be placed by telephone (217-222-8200), telex (404347) or Western Union Mailgram. Orders with a total price exceeding \$5,000.00 require written confirmation.

ACCEPTANCE: No order shall be binding upon Seller until Seller mails to Purchaser its standard form of acknowledgement. Seller reserves the right, in its acknowledgement, to change prices or specifications to Sellers prices and specifications in effect on date of shipment.

PRICES: All prices are net, F.O.B. Quincy, Illinois, or point of shipment. Our prices are based on cash transactions and all applicable discounts have been deducted. Prices are subject to change without notice. You will be invoiced at prices in effect at time of shipment. These prices and terms apply only to the U.S. For prices and terms in other countries please contact our International Sales Department, Quincy, Illinois.

TAXES: Purchaser shall pay, or upon receipt of invoice from Seller shall reimburse Seller, for all sales, use, occupation, gross income, excise and other taxes required to be collected by Seller by law. If you have a tax exemption number or certificate, please include it with your order.

PAYMENT: Your equipment purchase may be paid for as follows:

- (1) CASH—This means full payment with order.
- (2) OPEN ACCOUNT—A 25% downpayment is recommended. The balance is payable upon receipt of invoice. If you do not have an established account, please provide a current financial statement, plus trade or bank references with your order. Allow at least two weeks for processing.
- (3) FINANCING—On major purchases a portion of the cost may be financed through a monthly payment arrangement:
 - (a) 25% downpayment, balance in three installments due 30-60-90 days after shipment, no finance charge.
 - (b) 25% downpayment, balance in one payment due 90 days after shipment with 1% interest charge.

(c) When extended terms or leasing are desired, Harris will assist in securing third party financing or a leasing proposal.

- (4) C.O.D.—A 25% downpayment is required on C.O.D. orders.

The Harris Financing Department will be happy to give you further information or to discuss any questions you may have regarding method of payment.

RETURNS AND EXCHANGES: All sales are final and no merchandise should be returned without our written approval. A Return Authorization with special shipping instructions and an authorization number that will insure proper handling will be provided. Please furnish complete details as to circumstances and reasons when requesting return authorization. Custom built equipment or merchandise specially ordered for you is not returnable. Where return is at the request of, or for the convenience of the Purchaser, a special handling and restocking charge of 15% will be deducted from any credit issued. All merchandise returned must be sent freight prepaid and properly insured. When requesting return authorization it will be helpful if you reference the Harris invoice or order number.

SHIPPING: Please specify your preferred method of shipment on your order. Shipping charges, insurance, and C.O.D. fees (when applicable) will be collected at time of delivery when shipment is made via motor freight, air freight, electronics van, UPS or Parcel Post C.O.D. If you request open account and shipment is made via UPS or Parcel Post, shipping cost and insurance fees will be added to the invoice.

DAMAGES AND RISK OF LOSS: Purchaser assumes all responsibility for, and risk of loss of, or damage to, the equipment upon delivery to the carrier at Seller's shipping point notwithstanding the fact that the Seller may have selected the carrier.

WARRANTY ADJUSTMENTS: In the event of equipment failure during the warranty period, replacement or repair parts may be provided in accordance with the provisions of the Harris Warranty. In most cases you will be required to return the defective merchandise or part to Harris Corp., f.o.b. Quincy, Illinois, for replacement or repair. Repairs, within the warranty period will be done on a no charge basis. Warranty replacements of defective merchandise will be billed to your account. This billing will be cleared by a credit issued upon return of the defective item.

MODIFICATIONS: Harris reserves the right to modify the design and specifications of the equipment shown in this catalog without notice or to withdraw any item from sale, provided, however, that any modification shall not adversely affect the performance of the equipment so modified.



HARRIS
COMMUNICATIONS AND
INFORMATION HANDLING

| TYPE NUMBER | PRODUCT DESCRIPTION | UNIT PRICE | TYPE NUMBER | PRODUCT DESCRIPTION | UNIT PRICE |
|----------------------------------|--|------------|--------------|--|------------|
| <u>AM BROADCAST TRANSMITTERS</u> | | | | | |
| 994-7651-001 | VP-100A, 100,000 Watt medium wave transmitter. Complete with tubes, crystals and silicon rectifiers. On operation from 380 to 480 volt, 3 phase, 50 or 60 Hz.----- | On Request | 994-6522-007 | BC-10H, same as 994-6522-006 except with power reduction to 5kW----- | 30,095.00 |
| 990-0761-000 | 100% set of spare tubes for VP-100A----- | On Request | 994-6522-008 | BC-10H, same as above except with power reduction to 1kW---- | 30,295.00 |
| 992-4355-001 | 100% semi-conductor kit for VP-100A----- | On Request | 990-0539-001 | 100% set of spare tubes for BC-10H transmitter, rectifiers not included----- | 1,021.00 |
| 994-7964-001 | MW-50A, 50,000 watt AM transmitter with PDM. Complete with tubes, crystals, and silicon rectifiers, with dry supply, 460V, 3 phase, 60 Hz. For 50 ohm output only----- | 125,320.00 | 990-0760-001 | 100% set of spare transistors for BC-10H/BC-5H transmitter, Diodes not included----- | 400.00 |
| 994-7964-003 | MW-50A, 50,000 watt AM transmitter with PDM. Complete with tubes, crystals and silicon rectifiers, with oil filled transformer/air-cooled rectifiers, 460V, 3 phase, 60 Hz----- | 127,050.00 | 994-7965-001 | MW-5A, 5kW AM transmitter with PDM, complete with tubes, crystals, and silicon rectifiers, dry supply, 208/230 volts, 3 phase, 60 Hz----- | 31,605.00 |
| 994-7964-004 | MW-50A, 50,000 watt AM transmitter with PDM. Complete with tubes, crystals, and silicon rectifiers, with dry supply, 380V, 3 phase, 50 Hz.- | 125,895.00 | 994-7965-003 | MW-5A, 5kW AM transmitter with PDM, complete with tubes, crystals, and silicon rectifiers, dry supply, 208/230/380 volts, 3 phase, 50 Hz----- | 31,605.00 |
| 994-7964-005 | MW-50A, 50,000 watt AM transmitter with PDM. Complete with tubes, crystals and silicon rectifiers, with oil-filled transformer/air cooled rectifiers, 380V, 3 phase, 50 Hz----- | 128,700.00 | 990-0764-001 | 100% set of spare tubes for MW-5A----- | 720.00 |
| 990-0826-001 | 100% set of spare tubes for MW-50A, silicon rectifiers not included----- | 7,970.00 | 990-0765-001 | 100% set of spare transistors for MW-5A, diodes not included- | 472.00 |
| 990-0827-001 | Recommended minimum spare tubes for MW-50A----- | 3,985.00 | 990-0767-001 | 100% set of spare diodes for MW-5A, includes HV rectifiers, but no transistors----- | 2,510.00 |
| 990-0828-001 | 100% semi-conductor kit for MW-50A----- | 3,065.00 | 994-7966-001 | MW-1A, 1kW solid-state medium wave AM transmitter with PSM, one crystal, single phase, 208/230 volts, 60 Hz or 50 Hz operation (specify if 208 or 230 volt primary service), 50 ohm output only----- | 12,495.00 |
| 994-6669-002 | BC-20H, 20kW medium wave transmitter, consisting of two standard BC-10H, 10kW transmitters, including 20kW combiner and a common drive unit----- | 90,175.00 | 994-7831-001 | MW-1A Impedance matching network, for impedance above 50 ohm thru 75 ohm output----- | 551.00 |
| 994-6522-006 | BC-10H, 10,000 watt transmitter with one set of operating tubes and two crystals, for operation from 208/240 VAC, 3 phase, 50/60 Hz power, 50 ohm output impedance. Power reduction to 2.5 kW 100% silicon rectifiers----- | 29,995.00 | 994-7831-002 | MW-1A Impedance matching network, for impedance above 75 ohm thru 230 ohm output----- | 667.00 |
| | | | 992-4201-001 | Spare power amplifier module for MW-1A----- | 484.00 |
| | | | 992-4202-001 | Spare plug-in intermediate power amplifier module for MW-1A----- | 362.00 |
| | | | 992-4207-001 | Spare plug-in oscillator module for MW-1A----- | 378.00 |
| | | | 992-4206-001 | Spare plug-in audio driver module for MW-1A----- | 368.00 |
| | | | 992-4205-001 | Spare plug-in audio input/overload module for MW-1A----- | 333.00 |
| | | | 990-0810-001 | 100% spare rectifier kit for MW-1A----- | 665.00 |

| TYPE NUMBER | PRODUCT DESCRIPTION | UNIT PRICE | TYPE NUMBER | PRODUCT DESCRIPTION | UNIT PRICE |
|--------------|---|------------|--------------|--|------------|
| 990-0811-001 | 100% spare transistor kit for MW-1A----- | 1,542.00 | 634-0238-000 | 308 Weston 0-6 RF Int. Thermo Std. Scale----- | 141.00 |
| | <u>MW TRANSPORTABLE</u> | | 634-0209-000 | 308 Weston 0-8 RF Int. Thermo Std. Scale----- | 90.00 |
| | Completely assembled, easy-to-ship medium wave transmitting stations. One, five, ten and twenty kilowatts.----- | On Request | 634-0210-000 | 308 Weston 0-10 RF Int. Thermo Std. Scale----- | 94.50 |
| | <u>HIGH POWER AM ANTENNA COUPLERS</u> | | | <u>METER JACK AND SHORTING BAR-MOUNTING PLUG</u> | |
| | Antenna Coupler for 100,000 watts AM----- | On Request | 994-3280-002 | Meter jack and shorting bar--- | 42.00 |
| | Antenna Coupler for 50,000 watts AM----- | On Request | 994-3281-001 | Meter mounting plug----- | 37.00 |
| | Antenna Coupler for 20,000 watts AM----- | On Request | | <u>METER SHORTING SWITCH</u> | |
| | <u>AM ANTENNA COUPLERS</u> | | 994-3493-001 | Meter Shorting Switch rating 15 amperes----- | 121.00 |
| 994-5309-xxx | (Special) antenna coupler for 10,000 watts AM, 70 to 100 D. towers. Includes antenna meter, "T" network, antenna meter switch and weatherproof housing----- | On Request | 994-6527-001 | Meter Shorting Switch, rating 40 amperes----- | 194.00 |
| 994-5309-xxx | (Special) antenna coupler for 5,000 watts AM and 70 to 100 D. antennas. Includes antenna meter, shorting switch, "T" network and weatherproof housing----- | On Request | | <u>SOLENOID TOWER CHOKES</u> | |
| 994-3494-001 | 44A, antenna coupling unit for 1,000 watts or less AM power and 70 to 100 D. antennas. Includes antenna meter, shorting switch, "T" network and weatherproof housing----- | 1,117.00 | 994-3937-001 | Tower choke, 2 section, weatherproof----- | 410.00 |
| | <u>TEST EQUIPMENT</u> | | 994-3938-001 | Tower choke, 3 section, weatherproof----- | 467.00 |
| 700-0055-000 | CPB-1 Common Point Impedance Bridge, 5 kW----- | 975.00 | 994-3935-001 | Tower choke, 2 section, unhused----- | 198.00 |
| 700-0056-000 | CPB-1 Common Point Impedance Bridge, 50 kW----- | 1,050.00 | 994-3936-001 | Tower choke, 3 section, unhused----- | 241.00 |
| 700-0063-000 | Model OIB-1 Operating Impedance Bridge, with 12 inch leads----- | 895.00 | | <u>ISOLATION COIL</u> | |
| 700-0146-000 | Model OIB-1 Operating Impedance Bridge, with 18 inch leads----- | 895.00 | 994-3073-006 | Uses 1/2", 50 ohm foam heliax FH4, coil only on mfg. plate. In weatherproof housing----- | 551.00 |
| 700-0064-000 | D.C. Amplifier. Used to increase sensitivity of Bridge for use with power sources as low as 25 watts----- | 100.00 | 994-4561-007 | Uses 1/2", 50 ohm foam heliax FH4, coil only on mfg. plate. Less cabinet----- | 415.00 |
| 700-0065-000 | TC-1 Transport Case. For OIB-1----- | 135.00 | | <u>DIODE TYPE REMOTE METER EQUIPMENT</u> | |
| | <u>R. F. ANTENNA METERS</u> | | 994-6112-001 | Solid state diode assembly. For all powers 250 watts through 50kW. Meter not included----- | 136.00 |
| 634-0206-000 | 308 Weston 0-3 RF Int. Thermo Std. Scale----- | 103.00 | 632-0418-000 | Meter 0-1 MA DC. Westinghouse RX351. With 0-3 amps RF scale face. 3" case----- | On Request |
| | | | 632-0420-000 | Same as above, 0-8 amp scale face----- | On Request |
| | | | 632-0421-000 | Same as above, 0-10 amp scale face----- | On Request |
| | | | 632-0424-000 | Meter 0-1MA DC RX-371 Westinghouse with 0-3 amp scale face-- | On Request |
| | | | 632-0426-000 | Same as above, 0-8 amp scale face----- | On Request |

| TYPE NUMBER | PRODUCT DESCRIPTION | UNIT PRICE | TYPE NUMBER | PRODUCT DESCRIPTION | UNIT PRICE | |
|--------------|--|------------|--------------|--|--|-----------|
| 632-0361-000 | Same as 632-0424-000, 0-10 amp scale face----- | On Request | | 1 each - Isolation amplifier with power supply | | |
| 632-0428-000 | Same as above, 0-15 amp scale face----- | On Request | | 1 each - Center Cabinet | | |
| | <u>HEAVY DUTY SAMPLING LOOP</u> | | | 1 each - High-power Hybrid coupler (combiner) with plumbing to interconnect to transmitters | | |
| 994-6126-001 | Fixed, non-shielded sampling Loop----- | 340.00 | | 1 each - Low-power Hybrid coupler | | |
| | <u>FEED THRU BOWLS</u> | | | 1 each - 10kW reject load | | |
| 994-2870-001 | Solid stud, 2 bowls, for walls to 10 1/2" thick----- | On Request | | 1 each - 50-watt reject load | | |
| 994-3254-001 | Same as above but hollow stud----- | 126.00 | | For 60 Hz operation, 50 ohm, 3 1/8" EIA RF Output flange, equipped with wide band operation for S.T.L.----- | 79,960.00 | |
| 994-5280-001 | Solid stud, single bowl, for walls 1" thick----- | 83.00 | | NOTE: For exciter redundancy, the following additional equipment is required: | | |
| 994-5281-001 | Same as above but hollow stud----- | 83.00 | 994-6876-001 | Switching Kit, Automatic Exciter/I.P.A.----- | On request | |
| | <u>MEDIUM WAVE MODULATION MONITOR</u> | | | NOTE: For redundancy of the high-power output amplifiers, the following should be added: | | |
| 994-7084-001 | AM-80 Solid state AM Modulation Monitor----- | 1,103.00 | 994-6877-001 | RF output switching of high-power output amplifier----- | On request | |
| 994-7097-001 | AM-80 Remote Meter Panel----- | 258.00 | 994-8052-001 | FM-20K, 20,000 watt FM transmitter with one set of tubes and crystal, for 60 Hz operation, 50 ohms 3 1/8" EIA RF output flange, equipped with wide band operation for S.T.L.----- | 36,910.00 | |
| 994-7180-001 | 100% Spare Fuse, Diode, Lamp & Transistor Kit for AM-80----- | 98.00 | | 994-8052-002 | Same as above, except for 50 Hz operation----- | 37,590.00 |
| | <u>MEDIUM WAVE FREQUENCY MONITOR</u> | | 990-0552-001 | 100% spare tube kit----- | 966.00 | |
| 994-6698-001 | AF-80 Medium wave frequency monitor, digital readout----- | 1,310.00 | 994-8051-001 | FM-10K, 10,000 watt transmitter with one set of tubes and crystal, for 60 Hz operation, silicon rectifiers, 50 ohm, 3 1/8" EIA RF output flange, equipped with wide band operation for S.T.L.----- | 27,460.00 | |
| 94-6863-001 | Remote (analog) meter panel for Model 994-6698 above----- | 323.00 | | 994-8051-002 | Same as above except for 50 Hz operation----- | 27,985.00 |
| | <u>FM EXCITER & EXCITER OPTIONS</u> | | 990-0551-001 | 100% spare tube kit----- | 661.00 | |
| 994-7950-002 | MS-15, 100% solid state, 10 watt FM exciter, 88-108MHz, complete rack mount unit for operation on 117/235V, 50 or 60 Hz, equipped with wide band operation for STL. For Monaural, Stereo, SCA operation, see MS-15 exciter options listed below. Please indicate whether mounting in Harris transmitter (give model) or standard 19" rack----- | 4,990.00 | 994-8049-001 | FM-5K, 5,000 watt FM transmitter with one set of tubes and crystal, silicon rectifiers, for 60 Hz operation, 50 ohms, 3 1/8" EIA output flange, equipped with wide band operation for S.T.L.----- | 21,160.00 | |
| 994-8020-001 | Stereo Generator Modules with D.T.R. for MS-15----- | 2,890.00 | 994-8049-002 | Same as above except for 50 Hz operation----- | 21,685.00 | |
| 994-7992-001 | SCA Generator Module for MS-15----- | 940.00 | 990-0549-001 | 100% spare tube kit----- | 642.00 | |
| 994-8019-001 | Monaural Module for MS-15----- | 940.00 | | | | |
| | <u>FM BROADCAST TRANSMITTERS</u> | | | | | |
| 994-8053-001 | FM-40K, 40,000 watt FM Transmitter, consisting of: 2 each - FM-20K transmitter less exciters 1 each - MS-15 exciter | | | | | |

| TYPE NUMBER | PRODUCT DESCRIPTION | UNIT PRICE | TYPE NUMBER | PRODUCT DESCRIPTION | UNIT PRICE |
|--------------|---|------------|-------------|--|------------|
| 994-8047-001 | FM-2.5K, 2500 watt FM transmitter with one set of tubes, silicon rectifiers, for 60 Hz operation 50 ohms, 1 5/8" EIA output flange, equipped with wide band operation for S.T.L.----- | 15,435.00 | FMH-6AC | 6-bay 3-1/8" line, center feed- | 11,660.00 |
| 994-8047-003 | Same as above except for 50 Hz operation----- | 15,435.00 | FMH-6AC6 | 6-bay 6-1/8" line, center feed- | 13,090.00 |
| 990-0587-001 | 100% spare tube kit----- | 477.00 | FMH-7AE | 7-bay 3-1/8" line, end feed--- | 12,832.00 |
| 994-8046-001 | FM-1K, 1,000 watt FM transmitter complete with one set of tubes, one crystal, silicon rectifiers, for 50/60 Hz operation, 50 ohms, 1 5/8" EIA flange, equipped with wide band operation for S.T.L.----- | 12,075.00 | FMH-8AE | 8-bay 3-1/8" line, end feed--- | 14,666.00 |
| 990-0550-001 | 100% spare tube kit----- | 254.00 | FMH-8AC | 8-bay 3-1/8" line, center feed- | 15,326.00 |
| 994-6738-001 | 8FE-50G3, 50 watt FM transmitter utilizing TE-3 solid-state exciter with type N female output connector----- | 5,015.00 | FMH-8AC6 | 8-bay 6-1/8" line, center feed- | 16,758.00 |
| 990-0726-001 | 100% set spare rectifiers, tubes, and transistors, for 8FE-50G3----- | 374.00 | FMH-10AC | 10-bay 3-1/8" line, center feed----- | 18,991.00 |
| 994-6737-001 | 8FE-10G3, 10 watt FM transmitter utilizing TE-3 solid-state exciter with type N female output connector----- | 4,720.00 | FMH-10AC6 | 10-bay 6-1/8" line, center feed----- | 20,421.00 |
| 990-0649-001 | 100% spare transistor kit----- | 210.00 | FMH-12AC | 12-bay 3-1/8" line, center feed----- | 22,660.00 |
| 994-6533-001 | Stereo generator for TE-3 exciter (8FE-50G3, 8FE-10G3)-- | 1,570.00 | FMH-12AC6 | 12-bay 6-1/8" line, center feed----- | 24,090.00 |
| 994-6507-002 | SCA generator for TE-3 exciter (8FE-50G3, 8FE-10G3)---- | 772.00 | FMH-1BE | 1-bay 6-1/8" line, end feed--- | 2,568.00 |
| | <u>FMH SUPER POWER CIRCULARLY POLARIZED FM ANTENNA</u> | | FMH-2BE | 2-bay 6-1/8" line, end feed--- | 5,131.00 |
| FMH-1AE | 1-bay 3-1/8" line, end feed--- | 1,831.00 | FMH-2BC | 2-bay 6-1/8" line, center feed- | 6,506.00 |
| FMH-2AE | 2-bay 3-1/8" line, end feed--- | 3,668.00 | FMH-3BE | 3-bay 6-1/8" line, end feed--- | 7,700.00 |
| FMH-2AC | 2-bay 3-1/8" line, center feed----- | 4,328.00 | FMH-4BE | 4-bay 6-1/8" line, end feed--- | 10,268.00 |
| FMH-2AC6 | 2-bay 6-1/8" line, center feed----- | 5,758.00 | FMH-4BC | 4-bay 6-1/8" line, center feed- | 11,643.00 |
| FMH-3AE | 3-bay 3-1/8" line, end feed--- | 5,500.00 | FMH-5BE | 5-bay 6-1/8" line, center feed- | 12,831.00 |
| FMH-4AE | 4-bay 3-1/8" line, end feed--- | 7,331.00 | FMH-6BE | 6-bay 6-1/8" line, end feed--- | 15,400. |
| FMH-4AC | 4-bay 3-1/8" line, center feed----- | 7,992.00 | FMH-6BC | 6-bay 6-1/8" line, center feed- | 16,786.00 |
| FMH-4AC6 | 4-bay 6-1/8" line, center feed----- | 9,422.00 | FMH-7BE | 7-bay 6-1/8" line, end feed--- | 17,968.00 |
| FMH-5AE | 5-bay 3-1/8" line, end feed--- | 9,168.00 | FMH-8BE | 8-bay 6-1/8" line, end feed--- | 20,531.00 |
| FMH-6AE | 6-bay 3-1/8" line, end feed--- | 11,000.00 | FMH-8BC | 8-bay 6-1/8" line, center feed- | 21,906.00 |
| | | | FMH-10BC | 10-bay 6-1/8" line, center feed----- | 27,041.00 |
| | | | FMH-12BC | 12-bay 6-1/8" line, center feed----- | 32,175.00 |
| | | | FMH-1CE | 1-bay 6-1/8" line, end feed--- | 2,931.00 |
| | | | FMH-2CE | 2-bay 6-1/8" line, end feed--- | 5,637.00 |
| | | | FMH-3CE | 3-bay 6-1/8" line, end feed--- | 8,569.00 |
| | | | FMH-4CE | 4-bay 6-1/8" line, end feed--- | 11,506.00 |
| | | | FMH-5CE | 5-bay 6-1/8" line, end feed--- | 14,437.00 |
| | | | FMH-6CE | 6-bay 6-1/8" line, end feed--- | 17,369.00 |
| | | | | <u>FMP SELF-SUPPORTING CIRCULARLY POLARIZED FM ANTENNA</u> | |
| | | | FMP-1E3 | 1-bay, 3-1/8" input, end feed-- | 3,135.00 |
| | | | FMP-2E3 | 2-bay, 3-1/8" input, end feed-- | 6,270.00 |

| TYPE NUMBER | PRODUCT DESCRIPTION | UNIT PRICE | TYPE NUMBER | PRODUCT DESCRIPTION | UNIT PRICE |
|-------------|--|------------|-------------|--|------------------------|
| FMP-3E3 | 3-bay 3-1/8" input, end feed-- | 9,405.00 | FML-10C | 10-bay, 3-1/8" input, center feed----- | 12,144.00 |
| FMP-4E3 | 4-bay, 3-1/8" input, end feed- | 12,540.00 | FML-11C | 11-bay, 3-1/8" input, center feed----- | 13,299.00 |
| FMP-5E3 | 5-bay, 3-1/8" input, end feed- | 15,675.00 | FML-12C | 12-bay, 3-1/8" input, center feed----- | 14,454.00 |
| FMP-6E3 | 6-bay, 3-1/8" input, end feed- | 18,810.00 | | NOTE: If an odd number of bays are center fed, the feed is normally six feet below center. | |
| FMP-7C3 | 7-bay, 3-1/8" input, center feed----- | 23,100.00 | | <u>FMS DUAL CYCLOID CIRCULARLY POLARIZED FM ANTENNA</u> | |
| FMP-8C3 | 8-bay, 3-1/8" input, center feed----- | 26,235.00 | FMS-1 | 1-bay 3-1/8" line----- Same as above with 300 or 500 watt heaters----- | 1,397.00 1,672.00 |
| FMP-9C3 | 9-bay, 3-1/8" input, center feed----- | 29,370.00 | FMS-2 | 2-bay 3-1/8" line----- Same as above with 300 or 500 watt heaters----- | 2,788.00 3,338.00 |
| FMP-10C3 | 10-bay, 3-1/8" input, center feed----- | 32,505.00 | FMS-3 | 3-bay 3-1/8" line----- Same as above with 300 or 500 watt heaters----- | 4,180.00 5,005.00 |
| FMP-11C3 | 11-bay, 3-1/8" input, center feed----- | 35,640.00 | FMS-4 | 4-bay 3-1/8" line----- Same as above with 300 or 500 watt heaters----- | 5,577.00 6,677.00 |
| FMP-12C3 | 12-bay, 3-1/8" input, center feed----- | 38,775.00 | FMS-5 | 5-bay 3-1/8" line----- Same as above with 300 or 500 watt heaters----- | 6,968.00 8,343.00 |
| | NOTE: Additional cost for either 4-1/8" or 6-1/8" input is \$1,881.00. If an odd number of bays are center fed, the feed is normally 1/2-bay below center. | | FMS-6 | 6-bay 3-1/8" line----- Same as above with 300 or 500 watt heaters----- | 8,360.00 10,010.00 |
| | <u>FML MEDIUM POWER CIRCULARLY POLARIZED FM ANTENNA</u> | | FMS-7 | 7-bay 3-1/8" line----- Same as above with 300 or 500 watt heaters----- | 9,658.00 11,583.00 |
| FML-1E | 1-bay, 1-5/8" input, end feed- | 1,155.00 | FMS-8 | 8-bay 3-1/8" line----- Same as above with 300 or 500 watt heaters----- | 10,923.00 13,123.00 |
| -2E | 2-bay, 1-5/8" input, end feed- | 2,310.00 | FMS-9 | 9-bay 3-1/8" line----- Same as above with 300 or 500 watt heaters----- | 12,166.00 14,641.00 |
| FML-3E | 3-bay, 1-5/8" input, end feed- | 3,465.00 | FMS-10 | 10-bay 3-1/8" line----- Same as above with 300 or 500 watt heaters----- | 13,376.00 16,126.00 |
| FML-4E | 4-bay, 1-5/8" input, end feed- | 4,620.00 | FMS-11 | 11-bay 3-1/8" line----- Same as above with 300 or 500 watt heaters----- | 14,564.00 17,589.00 |
| FML-5E | 5-bay, 1-5/8" input, end feed- | 5,775.00 | FMS-12 | 12-bay 3-1/8" line----- Same as above with 300 or 500 watt heaters----- | 15,719.00 19,019.00 |
| FML-6E | 6-bay, 1-5/8" input, end feed- | 6,930.00 | FMS-13 | 13-bay 3-1/8" line----- Same as above with 300 or 500 watt heaters----- | 16,846.00 20,421.00 |
| FML-2C | 2-bay, 3-1/8" input, center feed----- | 2,904.00 | FMS-14 | 14-bay 3-1/8" line----- Same as above with 300 or 500 watt heaters----- | 17,946.00 21,796.00 |
| FML-3C | 3-bay, 3-1/8" input, center feed----- | 4,059.00 | | | |
| FML-4C | 4-bay, 3-1/8" input, center feed----- | 5,214.00 | | | |
| FML-5C | 5-bay, 3-1/8" input, center feed----- | 6,369.00 | | | |
| FML-6C | 6-bay, 3-1/8" input, center feed----- | 7,524.00 | | | |
| FML-7C | 7-bay, 3-1/8" input, center feed----- | 8,679.00 | | | |
| FML-8C | 8-bay, 3-1/8" input, center feed----- | 9,834.00 | | | |
| FML-9C | 9-bay, 3-1/8" input, center feed----- | 10,989.00 | | | |

| TYPE NUMBER | PRODUCT DESCRIPTION | UNIT PRICE | TYPE NUMBER | PRODUCT DESCRIPTION | UNI PRICE |
|--------------|---|------------------------|--------------|--|-----------|
| FMS-15 | 15-bay 3-1/8" line----- Same as above with 300 or 500 watt heaters----- | 19,019.00 23,144.00 | 710-0201-000 | FM-33A 3-ring antenna----- | 1,028.00 |
| FMS-16 | 16-bay 3-1/8" line----- Same as above with 300 or 500 watt heaters----- | 20,064.00 24,464.00 | 710-0202-000 | FM-44A 4-ring antenna----- | 1,276.00 |
| | <u>DUAL CYCLOID II CIRCULARLY POLARIZED FM ANTENNA</u> | | | <u>FM ISOLATION TRANSFORMERS</u> | |
| FMC-4B | 4-bay----- Same as above with heaters---- | 3,377.00 4,367.00 | 620-1027-000 | 10 kW FM Isolation Trans- former, standard 1-5/8" EIA flanges, adjusted to customer's operating fre- quency at the factory. For use with a max. transmitter power of 10kW----- | 1,250.00 |
| FMC-5B | 5-bay----- Same as above with heaters---- | 4,218.00 5,456.00 | 620-1028-000 | 10 kW FM Isolation Trans- former, same as above ex- cept supplied with 1-5/8" - 3-1/8" adapters. Input and output 3-1/8" EIA 50 ohm female----- | 1,375.00 |
| FMC-6B | 6-bay----- Same as above with heaters---- | 5,060.00 6,545.00 | 620-0444-000 | 25 kW FM Isolation Trans- former, standard 3-1/8" EIA flanges, adjusted to customer's operating frequency at the factory. For use with a max. transmitter power of 25 kW---- | 3,000.00 |
| FMC-7B | 7-bay----- Same as above with heaters---- | 5,907.00 7,639.00 | | <u>FM MODULATION MONITORS</u> | |
| FMC-8B | 8-bay----- Same as above with heaters---- | 6,748.00 8,728.00 | 994-7070-001 | FT-80 Monaural Modulation Monitor, complete with crys- tal, calibrated to specified operating frequency----- | 1,444.00 |
| FMC-9B | 9-bay----- Same as above with heaters---- | 7,590.00 9,817.00 | 994-7071-001 | Remote FM Monaural Modulation Monitor Panel----- | 510.00 |
| FMC-10B | 10-bay----- Same as above with heaters---- | 8,437.00 10,912.00 | 990-0792-001 | 100% Transistor/IC Kit for FT-80----- | 98 |
| FMC-11B | 11-bay----- Same as above with heaters---- | 9,278.00 12,001.00 | | <u>FM STEREO MONITORS</u> | |
| FMC-12B | 12-bay----- Same as above with heaters---- | 10,120.00 13,090.00 | 994-7072-001 | FS-80 FM Stereo Modulation Monitor----- | 2,295.00 |
| | <u>DUAL CYCLOID III CIRCULARLY POLARIZED FM ANTENNA</u> | | 994-7073-001 | Remote FM Stereo Monitor Panel----- | 447.00 |
| FMC-1A | 1-bay----- Same as above with heaters---- | 847.00 1,094.00 | 990-0795-001 | 100% transistor and IC kit for FS-80----- | 136.00 |
| FMC-2A | 2-bay----- Same as above with heaters---- | 1,688.00 2,183.00 | | <u>FM SCA MONITORS</u> | |
| FMC-3A | 3-bay----- Same as above with heaters---- | 2,530.00 3,272.00 | 994-7074-001 | FC-80 FM SCA Modulation Monitor----- | 2,305.00 |
| FMC-4A | 4-bay----- Same as above with heaters---- | 3,377.00 4,367.00 | 994-7075-001 | Remote panel for FC-80----- | 436.00 |
| FMC-5A | 5-bay----- Same as above with heaters---- | 4,218.00 5,453.00 | 990-0796-001 | 100% transistor/IC kit for FC-80----- | 162.00 |
| FMC-6A | 6-bay----- Same as above with heaters---- | 5,060.00 6,545.00 | | <u>FM FREQUENCY MONITOR</u> | |
| FMC-7A | 7-bay----- Same as above with heaters---- | 5,907.00 7,639.00 | 994-6998-001 | FF-80 FM Frequency Monitor, calibrated to specified oper- ating frequency----- | 1,292.00 |
| FMC-8A | 8-bay----- Same as above with heaters---- | 6,748.00 8,728.00 | 994-6999-001 | Remote FM Frequency Monitor (Remote Panel)----- | 347.00 |
| | <u>FMD-X DIRECTIONAL FM ANTENNAS</u> | On Request | 990-0797-001 | 100% Transistor/IC Kit----- | 248.00 |
| | <u>EDUCATIONAL FM ANTENNAS</u> | | | | |
| 710-0102-000 | FM-11A Single ring antenna---- | 297.00 | | | |
| 710-0103-000 | FM-22A 2-ring antenna----- | 489.00 | | | |

| TYPE NUMBER | PRODUCT DESCRIPTION | UNIT PRICE | TYPE NUMBER | PRODUCT DESCRIPTION | UNIT PRICE |
|--------------|--|------------|--------------|---|------------|
| | <u>FM RF AMPLIFIER</u> | | 994-7812-001 | 100% spare transistor, diodes and IC kit for Mono 5 Console-- | 138.00 |
| 994-6614-003 | GTM-88R FM RF amplifier, includes coax cable connector 75 ohm input. Specify operating frequency----- | 840.00 | 994-7691-001 | Stereo 5, five channel stereophonic audio console, complete with preamplifier, program amplifiers, cue amplifier, monitor amplifiers, and self-contained power supply.----- | 2,095.00 |
| 710-0246-000 | CH-6065 FM Antenna----- | 55.00 | 994-7811-001 | 100% spare transistor, diodes and IC kit for Stereo 5 Console----- | 226.00 |
| 710-0124-000 | CH-6060 FM Antenna----- | 32.00 | | <u>EXTRA MODULES FOR GATESWAY 80, DUALUX 80 & STEREO 80 CONSOLES</u> | |
| 710-0127-000 | T-28 M Matching Transformer, 300 ohms to 75 ohms----- | 4.00 | 994-6753-002 | Power supply regulator plug-in for Gatesway 80 and Dualux 80-- | 220.00 |
| | <u>AUDIO CONTROL CONSOLES</u> | | 994-6754-002 | Program/monitor/cue amplifier plug-in for Gatesway 80, Dualux 80, Stereo 80----- | 258.00 |
| | M-90 Modular console, up to 56 inputs, 8 outputs----- | On Request | 994-6755-002 | Booster amplifier plug-in for Gatesway 80, Dualux 80, Stereo 80----- | 209.00 |
| 994-6699-001 | Gatesway 80, 8-channel console, complete with three preamplifiers, three booster amplifiers, three program/monitor/cue output modules (interchangeable) and two power supplies----- | 3,932.00 | 994-6911-001 | Preamplifier plug-in for Gatesway 80, Dualux 80, Stereo 80--- | 120.00 |
| 990-0722-001 | 100% semi-conductor kit for Gatesway 80----- | 359.00 | | <u>AUDIO CONSOLE ACCESSORIES</u> | |
| 994-6866-001 | Dualux 80 dual programming eight-channel console, complete with three preamplifiers; three boosters; four program A/program B/monitor/cue output modules (interchangeable) and two power supplies----- | 4,331.00 | 994-6208-001 | External VU meter and housing-- | 294.00 |
| | | | 994-6424-001 | Intercom sub-station----- | 126.00 |
| J-0723-001 | 100% semi-conductor kit for Dualux 80----- | 422.00 | 478-0291-000 | Speaker matching transformer, all consoles----- | 7.25 |
| | | | | <u>MODULAR SOLID-STATE AMPLIFIER</u> | |
| 994-6867-001 | Stereo 80 eight-channel stereo console, complete with six preamplifiers; five boosters; five program/monitor/cue output modules (interchangeable); and one power supply panel--- | 5,171.00 | 994-7681-001 | Basic Utility Amplifier less rack mounting panel. Input 150 ohm matching or 600 ohm bridging (24k ohm). Output 150/600 ohms. Gain 84 db from 150 ohm unterminated source, 40 db from 600 ohm terminated source. Maximum output + 20 dBm (+8VU with 12 db headroom)----- | 368.00 |
| 478-0291-000 | Speaker matching transformer for Stereo 80----- | 7.25 | | <u>CRITERION TAPE CARTRIDGE UNITS</u> | |
| 990-0724-001 | 100% Semi-conductor kit, for 994-6867-001 Stereo 80----- | 613.00 | 994-7993-001 | Criterion 90-1 Playback, mono with 1000/150 Hz Cue Tones, 60 Hz----- | 640.00 |
| 994-6158-002 | Executive, 10 channel stereo console----- | 7,114.00 | 994-7993-002 | As above, except 50 Hz----- | 650.00 |
| 990-0501-001 | 100% spare semi-conductor kit for Executive----- | 314.00 | 994-7993-003 | Criterion 90-1 Playback, mono with 1000/150/8000 Hz Cue Tones, 60 Hz----- | 695.00 |
| 994-5700-003 | Optional third program amplifier for Executive----- | 350.00 | 994-7993-004 | As above, except 50 Hz----- | 705.00 |
| 722-0009-000 | Replacement speaker for Executive Console, 3"----- | 7.50 | 994-7994-001 | Criterion 90-1 Playback, Stereo, with 1000/150 Hz Cue Tones, 60 Hz----- | 725.00 |
| 994-7699-001 | Mono 5, five channel monaural audio console, complete with preamplifiers, program amplifiers, cue amplifiers, monitor amplifiers, and self-contained power supply----- | 1,575.00 | 994-7994-002 | As above, except 50 Hz----- | 735.00 |

| TYPE NUMBER | PRODUCT DESCRIPTION | UNIT PRICE | TYPE NUMBER | PRODUCT DESCRIPTION | UNIT PRICE |
|--------------|---|------------|--------------|--|------------|
| 994-7994-003 | Criterion 90-1 Playback, Stereo, with 1000/150/8000 Hz Cue Tones, 60 Hz----- | 780.00 | 900-0077-001 | 65-140-25, 40 second cartridge, packed 6/box, each----- | 2.97 |
| 994-7994-004 | As above, except 50 Hz----- | 790.00 | 900-0078-001 | 65-140-44, 70 second cartridge, packed 6/box, each----- | 3.08 |
| 994-7995-001 | Criterion 90-2 Playback, mono, with 1000/150 Cue Tones, 60 Hz | 700.00 | 900-0079-001 | 65-140-63, 100 second cartridge, packed 6/box, each---- | 3.23 |
| 994-7995-002 | As above, except 50 Hz----- | 710.00 | 900-0080-001 | 65-140-94, 2½ minute cartridge, packed 6/box, each---- | 3.43 |
| 994-7995-003 | Criterion 90-2 Playback, mono, with 1000/150/8000 Hz Cue Tones, 60 Hz----- | 755.00 | 900-0081-001 | 65-140-132, 3½ minute cartridge, packed 6/box, each---- | 3.65 |
| 994-7995-004 | As above, except 50 Hz----- | 765.00 | 900-0082-001 | 65-140-207, 51/2 minute cartridge, packed 6/box, each---- | 4.11 |
| 994-7996-001 | Criterion 90-2 Playback, Stereo, with 1000/150 Hz Cue Tones, 60 Hz----- | 795.00 | 900-0083-001 | 65-140-394, 10½ minute cartridge, packed 6/box, each---- | 4.95 |
| 994-7996-002 | As above, except 50 Hz----- | 805.00 | 900-0303-001 | 65-149-E empty cartridge, assembled, packed 2/box, each- | 4.12 |
| 994-7996-003 | Criterion 90-2 Playback, Stereo, with 1000/150/8000 Hz Cue Tones, 60 Hz----- | 850.00 | 900-0084-001 | 65-149-600, 16 minute cartridge, packed 2/box, each---- | 8.76 |
| 994-7996-004 | As above, except 50 Hz----- | 860.00 | 900-0304-001 | 65-150-E, empty cartridge, assembled, packed 2/box, each- | 5.71 |
| 994-7997-001 | Criterion 90-2 Record/Playback, mono, with 1000/150 Hz Cue Tones, 60 Hz----- | 1,135.00 | 900-0085-001 | 65-150-1163, 31 minute cartridge, packed 6/box, each---- | 14.50 |
| 994-7997-002 | As above, except 50 Hz----- | 1,145.00 | | <u>TAPE CARTRIDGE STORAGE RACKS</u> | |
| 994-7997-003 | Criterion 90-2 Record/Playback, mono, with 1000/150/8000 Hz Cue Tones, 60 Hz----- | 1,215.00 | 994-5986-001 | Harris storage rack. Mounts in 10½" (6 rack units) vertical rack space. Holds 40, A-300 size cartridges----- | 160.00 |
| 994-7997-004 | As above, except 50 Hz----- | 1,225.00 | 730-1189-000 | SECR-72, cartridge storage cabinet-walnut formica trim for 72 series 300 cartridges. Rotates on ball bearings. Dimensions: 22" h. x 11" d.--- | 79.00 |
| 994-7998-001 | Criterion 90-2 Record/Playback, Stereo with 1000/150 Hz Cue Tones, 60 Hz----- | 1,355.00 | 994-6887-001 | Harris wall mount cartridge rack, stores 100 series A-300 cartridges. Size 2' x 2' x 4 3/8". Walnut formica----- | 80.00 |
| 994-7998-002 | As above, except 50 Hz----- | 1,365.00 | 730-1190-000 | SECR-200, storage cabinet-walnut formica trim. Capable of storing 200 series 300 cartridges. Rotates on ball bearings. Dimensions 29½" h. x 15 3/5" w. x 15 3/4" d.----- | 116.00 |
| 994-7998-003 | Criterion 90-2 Record/Playback, Stereo with 1000/150/8000 Hz Cue Tones, 60 Hz----- | 1,435.00 | 730-1492-000 | Abco Wire cartridge rack. Holds (50) cartridges. 5" w. x 60" h. x 7" d. Weighs approximately 4 pounds. Includes tape mounting brackets-- | 35.00 |
| 994-7998-004 | As above, except 50 Hz----- | 1,445.00 | 730-1493-000 | Abco Wire lazy susan cartridge rack base. Holds up to (10) Abco Wire cartridge racks. No. 730-1492-000----- | 62.00 |
| 994-8161-001 | Rack mounting kit for Criterion 90-1 playback----- | 20.00 | | | |
| 994-8160-001 | Rack mounting kit for Criterion 90-2 playback----- | 20.00 | | | |
| 994-8162-001 | Rack mounting kit for Criterion 90-2 record/playback unit or two Criterion 90-1 playback units----- | 20.00 | | | |
| | <u>TAPE CARTRIDGES</u> | | | | |
| 900-0302-001 | 65-140-E, empty cartridge, assembled, packed 6/box, each- | 2.53 | | | |
| 900-0125-001 | 65-140-13, 20 second cartridge, packed 6/box, each----- | 2.89 | | | |

| TYPE NUMBER | PRODUCT DESCRIPTION | UNIT PRICE | TYPE NUMBER | PRODUCT DESCRIPTION | UNIT PRICE |
|--------------|--|---------------|--------------|--|------------|
| | <u>TURNABLES AND ACCESSORIES</u> | | | | |
| 994-7866-001 | CB-1201, 12" transcription turntable, 115V, 60 Hz, chassis only----- | 285.00 | 994-8148-001 | MSP-100 monaural AM audio processor consisting of main frame and power supply, and one each input/AGC, control, limiter, AM protection and output modules----- | 5,245.00 |
| 994-7866-002 | CB-1201, 12" transcription turntable, 115V, 50 Hz, chassis only----- | 297.00 | 994-7059-001 | Solid-state AM Peak Limiter--- | 1,045.00 |
| | Drilling of Harris turntable for tone arm, per turntable (specify arm)----- | 18.00 | 994-6631-005 | Solid-state FM Limiter----- | 1,045.00 |
| 994-6690-001 | IC Equalized turntable pre-amplifier, monaural----- | 184.00 | 994-6631-006 | Matched pair of FM Limiters--- | 1,905.00 |
| 994-6977-001 | IC Equalized turntable pre-amplifier, stereo----- | 341.00 | 994-6629-004 | Solid-state AGC Amplifier---- | 1,008.00 |
| 723-0259-000 | 206-S, Micro-Trak, 12" tone arm----- | 85.00 | 994-6629-006 | Matched pair of AGC Amplifiers----- | 1,979.00 |
| 723-0268-000 | 303 gray, Micro-Trak, 12" tone arm----- | 89.50 | | <u>STANDARD SYSTEM 90 PROGRAM AUTOMATION SYSTEMS</u> | |
| 723-0236-000 | Shure M44-7 stereo dynetic cartridge w/.0007 diamond stylus----- | 30.00 | 994-8149-001 | System 90 program automation system with microprocessor controller, four reel-reel reproducers, one NTI 48 PB mono instacart, two tape cartridge reproducers, clear text logging package, and associated wiring and racks. Includes checkout----- | 41,895.00 |
| 723-0237-000 | N-44-7 replacement stylus .0007 diamond----- | 11.20 | 994-8149-002 | System 90 program automation system with microprocessor controller, four reel-reel reproducers, one NTI 48 PB mono instacart, two tape cartridge reproducers, numeric logging package, and associated wiring and racks. Includes checkout----- | 41,895.00 |
| 723-0306-000 | M-93-E Hi-track elliptical cartridge 1½ to 3 grams tracking----- | 50.00 | 994-8150-001 | System 90 program automation system with microprocessor controller, four reel-reel reproducers, two NTI 42 tray go carts, two tape cartridge reproducers, clear text logging package and associated wiring and racks. Includes checkout----- | 42,425.00 |
| 723-0307-000 | N-93-E Elliptical replacement stylus----- | 21.40 | 994-8150-002 | System 90 program automation system with microprocessor controller, four reel-reel reproducers, two NTI 42 tray go carts, two tape cartridge reproducers, numeric logging package, and associated wiring and racks. Includes checkout-- | 42,425.00 |
| 723-0308-000 | M-75-6 Hi-track spherical stylus cartridge for 1½ to 3 grams tracking----- | 37.50 | 994-8151-001 | System 90 program automation system with microprocessor controller, four reel-reel reproducers, one NTI 48 PB mono instacart, two NTI 42 tray go carts, two tape cartridge reproducers, clear text logging package, and associated wiring and racks. Includes checkout-- | 53,235.00 |
| 723-0309-000 | N-75-6 replacement stylus----- | 12.80 | | | |
| | <u>AUDIO PROCESSORS, LIMITERS, AGC AMPLIFIERS</u> | | | | |
| 994-7967-001 | MSP-100 stereo FM/TV audio processor consisting of main frame and power supply, and two each input/AGC, control, limiter, protection and output modules----- | 6,295.00 | | | |
| 994-7968-001 | MSP-100 monaural FM/TV audio processor consisting of main frame and power supply, and one each input/AGC, control, limiter, protection and output modules----- | 5,245.00 | | | |
| 994-8147-001 | MSP-100 stereo AM audio processor consisting of main frame and power supply, and two each input/AGC, control, limiter, AM protection and output modules----- | Not Available | | | |

| TYPE NUMBER | PRODUCT DESCRIPTION | UNIT PRICE | TYPE NUMBER | PRODUCT DESCRIPTION | UNIT PRICE |
|--------------|---|------------|--------------|--|------------|
| 994-8151-002 | System 90 program automation system with microprocessor controller, four reel-reel reproducers, one NTI 48 PB mono instacart, two NTI 42 tray go carts, two tape cartridge reproducers, numeric logging package, and associated wiring and racks. Includes checkout----- | 53,235.00 | | <u>MEMORY EXPANSION FOR 994-7153-002 SYSTEM 90 CONTROLLER</u> | |
| | <u>SYSTEM 90 PROGRAM CONTROL EQUIPMENT</u> | | | Expansion can be made in 512 event increments up to a total of 3700 events. | |
| | | | | To add 512 events order quantity of 8 each 382-0308-000 @ \$3.28 each----- | 26.00 |
| 994-7153-002 | System 90 Micro-computer control. 50/60 Hz, 117/234 VAC. Includes digital clock with crystal frequency standard, solid-state compare time memory, jump table memory, 1200 event program memory, 16 source capability, network join with solid-state fade-out and back time control, VU meter and monitor facilities with null and stereo phase checking and single channel monitor amplifier, emergency operation panel, two silence sensors for monitoring system and off-air, time announce control, portable console with remote control facilities for random select and memory use, random access shelf driver, and computer grade power supply. Specify cable length between system and console up to 150 feet. Computer housing with switcher requires 8 rack units. Power supply requires 5 rack units. Includes checkout US 48 states- | 16,620.00 | 994-7749-002 | To add 1,000 events (total 2,200 events)----- | 1,045.00 |
| | NOTE: Battery back-up not supplied. Requires 12V storage battery and charger. | | 994-7749-005 | To add 2,500 events (total 3,700 events)----- | 1,675.00 |
| | <u>SYSTEM 90 OPTIONS</u> | | | <u>SYSTEM 90 MEMORY LOAD DUMP</u> | |
| 994-7899-001 | Additional console (standard system can accommodate one additional console). Two or more consoles may be added on special order. Desk mount----- | 3,145.00 | 994-7750-001 | Memory Load/Dump electronics. (See 8 Port I/O below when adding to earlier SC-90's). Does not include terminal. If system includes Clear Text logging then its encoding terminal can be used (if it is an ASR-33 Teletype or T1 Silent 700 with cassettes). Mounts in computer housing---- | 420.00 |
| 994-8152-001 | Monitor 8" speaker assembly--- | 36.00 | 992-4663-001 | 8 Port I/O. This board is required when adding memory board/dump to System 90's shipped prior to July 1, 1976. Customer can return his older 3 port I/O on an RGR for \$200.00 credit.----- | 556.00 |
| 994-7755-001 | Source expansion. Expands system capability from 16 to 32 sources. Order at time of system purchase or install in field by Harris automation representative (at field rates). Does not include any source cards. Requires 3 rack units----- | 1,722.00 | | <u>SYSTEM 90 SOURCE CARDS</u> | |
| | | | | (Each System 90 source requires one of the following source cards) | |
| | | | 994-7647-001 | Reel-to-reel source card (with fade-under). Includes 25 Hz detector with adjustable stop delay----- | 289.00 |
| | | | 994-7648-001 | Cartridge source card (with fade-under)----- | 247.00 |
| | | | 994-7760-001 | Dead Roll/Back Time source card. May be used with either a cartridge or reel-to-reel source----- | 262.00 |
| | | | 994-7821-001 | Network Source Card----- | 205.00 |
| | | | 994-7867-001 | System 90 source interface for Ampex 350 having 110 VDC control circuit----- | 84.00 |

| TYPE NUMBER | PRODUCT DESCRIPTION | UNIT PRICE | TYPE NUMBER | PRODUCT DESCRIPTION | UNIT PRICE |
|--------------|--|------------|--------------|---|------------|
| 994-7946-001 | SC-90 System universal source cable including 1B of typical cable drawings----- | 52.00 | | | |
| | <u>HIGH FREQUENCY BROADCAST TRANSMITTERS</u> | | | | |
| 994-6734-001 | SW-100, 100,000 watt short-wave broadcast transmitter. Complete with one set of operating tubes for operation from any specified voltage, 380 volts to 480 volts, 3 phase, 50 or 60 Hz, with remote heat exchanger----- | On request | 990-0905-001 | 100% spare tube kit for BT-36L2----- | 7,970.00 |
| 994-6734-005 | SW-100, same as above except with top-mounted integral heat exchanger----- | On request | 990-0907-001 | 100% spare Semi-conductor kit for BT-36L2----- | 7,378.00 |
| 994-6808-001 | SW-50, 50,000 watt short-wave broadcast transmitter, complete with one set of operating tubes for operation from any specified voltage, 380 volts to 480 volts, 3 phase 50 or 60 Hz with remote heat exchanger----- | On request | | BTD-10L2 dual television transmitter, 10 kW visual, 2.0 kW aural. For operation on channels 2-6. Supplied with one set operating tubes, semi-conductors, crystals, VSB filter, color notch filter, harmonic filters, input and output switchers. For operation from 208/240 volts, 3 phase, 50/60 Hz. Specify channel and offset----- | 378,000.00 |
| 994-6808-005 | SW-50, same as above except with top-mounted integral heat exchanger----- | On request | | <u>VHF TELEVISION TRANSMITTERS, LOW BAND</u> | |
| 990-0692-001 | 100% tube kit for SW-100 / SW-50----- | On request | 994-8032-001 | BT-35L2 television transmitter, 35kW visual, 7.5kW aural. For operation on channels 2-6. Supplied with one set operating tubes, semi-conductors, crystals, VSB filter, color notch filter and harmonic filters. For operation from 208/230/380 volts, 3 phase, 50/60 Hz. Specify channel and offset----- | 252,525.00 |
| 990-0740-001 | 100% spare IC's for SW-100 / SW-50----- | On request | 990-0842-001 | 100% spare tube kit for BT-35L2----- | 7,139.00 |
| 9-0800-001 | 100% spare semiconductors for SW-100 / SW-50----- | On request | 990-0867-001 | 100% spare semi-conductor kit for BT-35L2----- | 5,799.00 |
| | <u>DUAL VHF TELEVISION TRANSMITTERS, LOW BAND</u> | | 994-8030-001 | BT-25L2 television transmitter, 25kW visual, 5 kW aural. For operation on channels 2-6. Supplied with one set operating tubes, semi-conductors, crystals, VSB filter, color notch filter and harmonic filters. For operation from 208/240 volts, 3 phase 50/60 Hz. Specify channel and offset----- | 198,450.00 |
| 994-8039-001 | BTD-50L2 dual television transmitter, 50kW visual, 10kW aural. For operation on channels 2-6. Supplied with one set of operating tubes, semi-conductors, crystals, VSB filter, color notch filter, harmonic filters, input and output switchers. For operation from 208/240 volt, 3 phase, 50/60 Hz. Specify channel and offset----- | 446,250.00 | 990-8030-003 | Same as 994-8030-001 except for CCIR system B, 20 kW visual, 380 volts, 50 Hz----- | On Request |
| 990-0913-001 | 100% spare tube kit for BTD-50L2----- | 9,432.00 | | | |
| 990-0915-001 | 100% spare semi-conductor kit for BTD-50L2----- | 7,638.00 | | | |
| 994-8037-001 | BTD-36L2 dual television transmitter, 36 kW visual, 7.5 kW aural. For operation on | | | | |

| TYPE NUMBER | PRODUCT DESCRIPTION | UNIT PRICE | TYPE NUMBER | PRODUCT DESCRIPTION | UNIT PRICE |
|--------------|---|------------|--------------|---|------------|
| 990-0838-001 | 100% spare tube kit for BT-25L2----- | 4,716.00 | | <u>DUAL VHF TELEVISION TRANSMITTERS, HIGH BAND</u> | |
| 990-0863-001 | 100% spare semi-conductor kit for BT-25L2----- | 3,765.00 | 994-8038-001 | BTD-50H2 dual television transmitter, 50 kW visual, 10 kW aural. For operation on Channels 7-13. Supplied with one set operating tubes, semi-conductors, crystals, VSB filter, color notch filter, harmonic filters, input and output switchers. For operation from 208/240 volt, 3 phase, 50/60 Hz. Specify channel and offset----- | 456,750.00 |
| 994-8028-001 | BT-18L2 television transmitter, 18 kW visual, 3.6 kW aural. For operation on channels 2-6. Supplied with one set operating tubes, semi-conductors, crystals, VSB filter, color notch filter and harmonic filters. For operation from 208/240 Volts, 3 phase, 50/60 Hz. Specify channel and offset---- | 178,500.00 | 990-0909-001 | 100% spare tube kit for BTD-50H2----- | 9,200.00 |
| 994-8028-003 | Same as above except for CCIR system B, 13 kW visual, 380 volts, 50 Hz----- | 178,500.00 | 990-0911-001 | 100% spare semi-conductor kit for BTD-50H2----- | 7,074.00 |
| 990-0836-001 | 100% spare tube kit for BT-18L2----- | 3,985.00 | 994-8036-001 | BTD-36H2 dual television transmitter, 36 kW visual, 7.5 kW aural. For operation on channels 7-13. Supplied with one set operating tubes, semi-conductors, crystals, VSB filter, color notch filter, harmonic filters, input and output switchers. For operation from 208/240 volt, 3 phase, 50/60 Hz. Specify channel and offset----- | 413,700.00 |
| 990-0859-001 | 100% spare semi-conductor kit for BT-18L2----- | 3,635.00 | 990-0905-001 | 100% spare tube kit for BTD-36H2----- | 7,970.00 |
| 994-8026-001 | BT-5L2 television transmitter, 5 kW visual, 1 kW aural. For operation on Channels 2-6. Supplied with one set operating tubes, semi-conductors, crystals, VSB filter, color notch filter and harmonic filters. For operation from 208/240 Volts, 3 phase, 50/60 Hz. Specify channel and offset---- | 141,131.00 | 990-0903-001 | 100% spare semi-conductor kit for BTD-36H2----- | 7,158.00 |
| 994-8026-005 | Same as above except for CCIR system B, 220 volts, 50 Hz---- | 141,131.00 | 994-8034-001 | BTD-10H2 dual television transmitter, 10 kW visual, 2.0 kW aural for operation on channels 7-13. Supplied with one set operating tubes, semi-conductors, crystals, VSB filter, color notch filter, harmonic filters, input and output switchers. For operation from 208/240 volt, 3 phase, 50/60 Hz. Specify channel and offset----- | 317,625.00 |
| 990-0834-001 | 100% spare tube kit for BT-5L2----- | 2,284.00 | 994-8035-001 | Same as above except for CCIR system B, 380 volts, 50 Hz---- | On Request |
| 990-0855-001 | 100% spare semi-conductor kit for BT-5L2----- | 2,542.00 | 990-0897-001 | 100% spare tube kits for BTD-10H2----- | 4,568.00 |
| 994-8024-001 | BT-1300L2 television transmitter, 1.3 kW visual, .26 kW aural. For operation on Channels 2-6. Supplied with one set operating tubes, semi-conductors, crystals, VSB filter, color notch filter and harmonic filters. For operation from 208/240 volts, three-phase, 50/60 Hz. Specify channel and offset----- | 63,750.00 | 990-0899-001 | 100% spare semi-conductor kit for BTD-10H2----- | 4,466.00 |
| 994-8024-003 | Same as above except for CCIR system B, 1.0 kW visual 50 Hz-- | On Request | | <u>VHF TELEVISION TRANSMITTERS, HIGH BAND</u> | |
| 990-0832-001 | 100% spare tube kit for BT-1300L2----- | 600.00 | 994-8033-001 | BTD-50H2 television transmitter, 50 kW visual, 10 kW aural. For operation on Channels 7-13. Supplied with | |
| 990-0851-001 | 100% spare semi-conductor kit for BT-1300L2----- | 1,871.00 | | | |

| TYPE NUMBER | PRODUCT DESCRIPTION | UNIT PRICE | TYPE NUMBER | PRODUCT DESCRIPTION | UNIT PRICE |
|--------------|--|------------|--------------------------------------|--|------------|
| | one set operating tubes, semi-conductors, crystals, VSB filter, color notch filter, and harmonic filters. For operation from 460/480 volt, 3 phase, 50/60 Hz. Specify channel and offset----- | 340,725.00 | 990-0861-001 | 100% spare semi-conductor kit for BT-18H2----- | 3,525.00 |
| 990-0845-001 | 100% spare tube kit for BT-50H2----- | 8,367.00 | 994-8025-001 | BT-5H2 television transmitter, 5 kW visual, 1 kW aural. For operation on Channels 7-13. Supplied with one set operating tubes, semi-conductors, crystals, VSB filter, color notch filter and harmonic filters. For operation from 208/240 volt, 3 phase, 50/60 Hz. Specify channel and offset---- | 141,131.00 |
| 990-0871-001 | 100% spare semi-conductor kit for BT-50H2----- | 4,129.00 | 994-8025-003 | SSame as above except for CCIR system B, 380 volts, 50 Hz---- | 141,131.00 |
| 994-8031-001 | BT-35H2 television transmitter, 35 kW visual, 7.5 kW aural. For operation on Channels 7-13. Supplied with one set operating tubes, semi-conductors, crystals, VSB filter, color notch filter and harmonic filters. For operation from 208/230/380 volt, 3 phase, 50/60 Hz. Specify channel and offset----- | 252,525.00 | 990-0834-001 | 100% spare tube kit for BT-5H2----- | 2,284.00 |
| 990-0844-001 | 100% spare tube kit for BT-35H2----- | 7,370.00 | 990-0857-001 | 100% spare semi-conductor kit for BT-5H2----- | 2,179.00 |
| 990-0869-001 | 100% spare semi-conductor kit for BT-35H2----- | 5,349.00 | 994-8023-001 | BT-1300H2 television transmitter, 1.3 kW visual, .26 kW aural. For operation on Channels 7-13. Supplied with one set operating tubes, semi-conductors, VSB filter, color notch filter and harmonic filters. For operation from 208/240 volt, single phase, 50/60 Hz. Specify channel and offset----- | 63,750.00 |
| 994-8029-001 | BT-25H2 television transmitter, 25 kW visual, 5 kW aural, for operation on Channels 7-13. Supplied with one set operating tubes, semi-conductors, crystals, VSB filter, color notch filter and harmonic filters. For operation from 208/240 volt, 3 phase, 50/60 Hz. Specify channel and offset----- | 219,450.00 | 994-8023-003 | Same as above except for CCIR system B, 1.0 kW visual, 50 Hz----- | On Request |
| 994-8029-003 | Same as above except for CCIR system B, 20 kW visual, 380 volts, 50 Hz----- | On Request | 990-0832-001 | 100% spare tube kit for BT-1300H2----- | 600.00 |
| 990-0840-001 | 100% spare tube kit for BT-25H2----- | 4,600.00 | 900-0853-001 | 100% spare semi-conductor kit for BT-1300H2----- | 1,702.00 |
| 990-0865-001 | 100% spare semi-conductor kit for BT-25H2----- | 3,483.00 | <u>VHF VISUAL EXCITER/MODULATORS</u> | | |
| 994-8027-001 | BT-18H2 television transmitter, 18 kW visual, 3.6 kW aural, for operation on Channels 7-13. Supplied with one set operating tubes, semi-conductors, VSB filter, color notch filter and harmonic filters. For operation from 208/240 volt, 3 phase, 50/60 Hz. Specify channel and offset----- | 204,750.00 | 994-7861-002 | MCP-1V VHF spare visual exciter, Channels 2-6 (specify)--- | 22,444.00 |
| 994-8027-003 | Same as above except for CCIR system B, 15 kW visual, 380 volts, 50 Hz----- | On Request | 994-8136-001 | MCP-1V VHF visual replacement exciter, Channels 2-6 (specify), includes mounting hardware----- | 22,944.00 |
| 990-0836-001 | 100% spare tube kit for BT-18H2----- | 3,985.00 | 994-7861-003 | MCP-1V VHF spare visual exciter, Channels 7-13 (specify)--- | 22,444.00 |
| | | | 994-8135-001 | MCP-1V VHF visual replacement exciter, Channels 7-13 (specify), includes mounting hardware----- | 22,944.00 |
| | | | 994-7861-005 | MCP-1V VHF spare visual exciter for CCIR System B service, Band I (54-68 MHz)----- | On Request |
| | | | 994-7861-006 | MCP-1V VHF spare visual exciter for CCIR System B service, Band III (174-223 MHz)-- | On Request |

| TYPE NUMBER | PRODUCT DESCRIPTION | UNIT PRICE | TYPE NUMBER | PRODUCT DESCRIPTION | UNIT PRICE |
|--------------|--|------------|--------------|--|------------|
| 994-6760-003 | Precise frequency control for VHF visual exciter----- | 2,890.00 | | BT-220U1 equipped for operation on channels 52-69----- | On Request |
| 992-4717-001 | Phase corrector PC board----- | On Request | | NOTE: Custom designed RF system for BT-220U1 (Not included in 994-8010-001)----- | On Request |
| 992-4718-001 | Gain corrector PC board----- | On Request | | Recommended spare Klystron tube for BT-220U1----- | On Request |
| 994-7016-001 | VHF automatic exciter/modulator switcher----- | 4,305.00 | 990-0883-001 | 100% spare semi-conductor kit for BT-220U1----- | 4,052.00 |
| 448-0636-000 | RAK-96 basic rack (24") for mounting backup VHF exciter, automatic exciter switcher----- | 365.00 | 994-8008-001 | BT-110U1 Television transmitter, 110 kW visual, 22 kW aural, for operation on Channels 14-51, 110 kW visual, 11 kW aural for operation on channels 52-69. Supplied with one set operating Klystrons, semi-conductors, crystals, VSB filter, color notch filter, notch diplexer, and harmonic filters. For operation from 460/480 volt, 3 phase, 50/60 Hz. Specify channel and offset---- | 553,090.00 |
| 448-0589-000 | Side panel kit for RAK-96. Includes two panels in Harris' white finish----- | 114.00 | | BT-110U1 equipped for 22 kW aural operation, channels 52-69----- | On Request |
| 448-0637-000 | Front trim kit for single RAK-96 cabinet----- | 65.00 | | Recommended spare klystron tube for BT-110U1----- | On Request |
| 448-0559-000 | Door handle with lock for rear door of RAK-96----- | 7.00 | 990-0881-001 | 100% spare semi-conductor kit for BT-110U1----- | 5,456.00 |
| | <u>VHF NOTCH DIPLEXERS</u> | | 994-8006-001 | BT-55U1 television transmitter, 55 kW visual, 11 kW aural. For operation on Channels 14-69. Supplied with one set of operating klystrons, semi-conductors, crystals, VSB filter, color notch filter, notch diplexer, and harmonic filters. For operation from 460/480 volt, 3 phase, 50/60 Hz. Specify channel and offset----- | 353,325.00 |
| 994-7020-00X | TD30L VHF low band notch diplexer, 30 kW visual, 6 kW aural. Channels 2-6. Specify channel in last digit of order number----- | 19,660.00 | | Recommended spare Klystron tube for BT-55U1----- | On Request |
| 994-7021-00X | TD40H VHF high band notch diplexer, 40 kW visual, 20 kW aural. Channels 7-13. Specify channel in last digit(s) of order number----- | 19,660.00 | 990-0877-001 | 100% spare semi-conductor kit for BT-55U1----- | 3,129.00 |
| | <u>VHF RF OUTPUT SWITCHERS</u> | | 994-8005-001 | BT-40U1 television transmitter, 40 kW visual, 8 kW aural. For CCIR System G, 470-790 MHz (Bands IV/V). Supplied with one set of operating Klystrons, semi-conductors, crystals, VSB filter, color notch filter, notch diplexer, and harmonic filters. For operation from 460/480 volt, 3 phase, 50/60 Hz. Specify operating frequency----- | 356,425.00 |
| 994-7671-00X | Dualtran RF output switcher for use with low band notch diplexer----- | On Request | | | |
| 994-7673-00X | Dualtran RF output switcher for use with high band notch diplexer----- | On Request | | | |
| 994-7672-00X | Dualtran RF output switcher for use with low band hybrid diplexer----- | On Request | | | |
| 994-7674-00X | Dualtran RF output switcher for use with high band hybrid diplexer----- | On Request | | | |
| | <u>UHF TELEVISION TRANSMITTERS</u> | | | | |
| 994-8010-001 | BT-220U1 television transmitter, 220 kW visual, 22 kW aural. For operation on Channels 14-51. Supplied with one set of operating Klystrons, semi-conductors, crystals, and VSB filter. For operation from 460/480 volt, 3 phase, 50/60 Hz. Specify channel and offset. (Does not include RF System)----- | On Request | | | |

| TYPE NUMBER | PRODUCT DESCRIPTION | UNIT PRICE | TYPE NUMBER | PRODUCT DESCRIPTION | UNIT PRICE |
|--------------|--|------------|--------------|--|------------|
| | Recommended spare klystron tube for BT-40U1----- | On Request | 994-7612-002 | Same as 994-7612-001 with deicing----- | On Request |
| 990-0875-001 | 100% spare semi-conductor kit for BT-40U1----- | 3,481.00 | | <u>HELICAL TELEVISION ANTENNAS-UHF-SINGLE INPUT ONLY</u> | |
| 994-8004-001 | BT-30U1 television transmitter, 30 kW visual, 6 kW aural. For operation on Channels 14-69. Supplied with one set operating klystrons, semi-conductors, crystals, VSB filter, color notch filter, notch diplexer, and harmonic filters. For operation from 460/480 volt, 3 phase 50/60 Hz.----- | 311,325.00 | 994-7613-001 | TAH-4U, single section UHF helical antenna less deicing----- | 14,700.00 |
| | Recommended spare Klystron tube for BT-30U1----- | On Request | 994-7613-002 | Same as above with deicing---- | 15,676.00 |
| 990-0873-001 | 100% spare semi-conductor kit for BT-30U1----- | 3,198.00 | 994-7614-001 | TAH-8U, two section UHF helical antenna less deicing----- | 27,405.00 |
| | <u>UHF VISUAL EXCITER/MODULATORS</u> | | 994-7614-002 | Same as above with deicing---- | 28,392.00 |
| 994-8003-001 | MCP-1U UHF spare visual exciter for Channels 14-69 (specify)--- | 22,444.00 | 994-7615-001 | TAH-12U, three section UHF helical antenna less deicing-- | 33,464.00 |
| 994-8137-001 | MCP-1U UHF replacement visual exciter for Channels 14-69 (specify). Includes mounting hardware----- | 22,944.00 | 994-7615-002 | Same as above with deicing---- | 34,445.00 |
| 994-8003-002 | MCP-1U UHF spare visual exciter for CCIR System G service, Bands IV & V (E21-E6B)----- | On Request | 994-7616-001 | TAH-16U, four section UHF helical antenna less deicing-- | 39,380.00 |
| 994-7076-001 | UHF automatic exciter/modulator switcher----- | On Request | 994-7616-002 | Same as above with deicing---- | 40,362.00 |
| | NOTE: See RAK-96 listings under "VHF VISUAL EXCITER/MODULATORS" for rack cabinet for mounting the MCP-1U replacement exciter and the UHF automatic exciter/modulator switcher. | | 994-7617-001 | TAH-20U, five section UHF helical antenna less deicing-- | 48,332.00 |
| | <u>CIRCULARLY POLARIZED TELEVISION ANTENNAS-----</u> | On Request | 994-7617-002 | Same as above with deicing---- | 49,266.00 |
| | <u>HELICAL TELEVISION ANTENNAS-VHF</u> | | 994-7618-001 | TAH-24U, six section UHF helical antenna less deicing-- | 51,780.00 |
| | When ordering VHF Helical antennas, specify the channel number and whether dual or single input is desired. | | 994-7618-002 | Same as above with deicing---- | 52,694.00 |
| 994-7610-001 | TAH-10H, two section helical VHF antenna less deicing----- | 90,111.00 | | <u>BATWING TELEVISION ANTENNAS-VHF</u> | |
| 994-7610-002 | Same as above with deicing---- | On Request | | When ordering batwing antennas, specify the channel number in the description and whether aluminum or copper feed lines are desired. | |
| 994-7611-001 | TAH-15H, three section helical VHF antenna less deicing----- | 113,956.00 | 994-7602-001 | TAB-1L, single bay batwing antenna for channels 2 and 3, less deicing----- | 14,248.00 |
| 994-7611-002 | Same as above with deicing---- | On Request | 994-7602-002 | Same as above with deicing---- | 15,398.00 |
| 994-7612-001 | TAH-20H, four section helical VHF antenna less deicing----- | 145,740.00 | 994-7602-003 | TAB-1L, single bay batwing antenna for channels 4, 5 and 6, less deicing----- | 14,248.00 |
| | | | 994-7602-004 | Same as above with deicing---- | 15,398.00 |
| | | | 994-7603-001 | TAB-2H, two bay batwing antenna for channels 7 thru 13, less deicing----- | 17,278.00 |
| | | | 994-7603-002 | Same as above with deicing---- | 19,283.00 |
| | | | 994-7604-001 | TAB-3L, three bay batwing antenna for channels 2 and 3, less deicing----- | 38,588.00 |

| TYPE NUMBER | PRODUCT DESCRIPTION | UNIT PRICE | TYPE NUMBER | PRODUCT DESCRIPTION | UNI. PRICE |
|--------------|---|------------|--------------|---|------------|
| 994-7604-002 | Same as 994-7604-001 with deicing----- | 41,864.00 | 994-7619-002 | Same as 994-7619-001, with deicing----- | On Request |
| 994-7604-003 | TAB-3L, three bay batwing antenna for channels 4, 5 and 6, less deicing----- | 32,676.00 | 994-7620-001 | TAZ-24H, three section VHF Zig-Zag antenna less deicing-- | 151,000.00 |
| 994-7604-004 | Same as above with deicing---- | 35,868.00 | 994-7620-002 | Same as above with deicing---- | On Request |
| 994-7605-001 | TAB-4L, four bay batwing antenna for channels 2 and 3, less deicing----- | 53,078.00 | | <u>ZIG-ZAG TELEVISION ANTENNAS-UHF</u> | |
| 994-7605-002 | Same as above with deicing---- | 57,157.00 | | When ordering UHF Zig-Zag antennas, please specify channel number. | |
| 994-7605-003 | TAB-4L, four bay batwing antenna for channels 4, 5 and 6, less deicing----- | 40,236.00 | 994-7621-001 | TAZ-8U, one section UHF Zig-Zag antenna less deicing----- | 35,458.00 |
| 994-7605-004 | Same as above with deicing---- | 45,602.00 | 994-7621-002 | Same as above with deicing---- | 36,981.00 |
| 994-7606-001 | TAB-5L, five bay batwing antenna for channels 2 and 3, less deicing----- | 59,902.00 | 994-7622-001 | TAZ-16U, three section UHF Zig-Zag antenna less deicing-- | 49,696.00 |
| 994-7606-002 | Same as above with deicing---- | 65,090.00 | 994-7622-002 | Same as above with deicing---- | 52,054.00 |
| 994-7606-003 | TAB-5L, five bay batwing antenna for channels 4, 5 and 6, less deicing----- | 51,130.00 | 994-7623-001 | TAZ-24U, three section UHF Zig-Zag antenna less deicing-- | 73,616.00 |
| 994-7606-004 | Same as above with deicing---- | 57,582.00 | 994-7623-002 | Same as above with deicing---- | On Request |
| 994-7607-001 | TAB-6L, six bay batwing antenna for channels 2 and 3 less deicing----- | 72,319.00 | 994-7624-001 | TAZ-31U, four section UHF Zig-Zag antenna less deicing-- | 91,208.00 |
| 994-7607-002 | Same as above with deicing---- | 77,831.00 | 994-7624-002 | Same as above with deicing---- | 95,140.00 |
| 994-7607-003 | TAB-6L, six bay batwing antenna for channels 4, 5 and 6, less deicing----- | 62,769.00 | 994-7625-001 | TAZ-38U, five section UHF Zig-Zag antenna less deicing-- | 111,846.00 |
| 994-7607-004 | Same as above with deicing---- | 68,497.00 | 994-7625-002 | Same as above with deicing---- | 116,60' |
| 994-7608-001 | TAB-6H, six bay batwing antenna for channels 7 thru 13, less deicing----- | 37,637.00 | 994-7626-001 | TAZ-45U, six section UHF Zig-Zag antenna less deicing-- | 135,082.00 |
| 994-7608-002 | Same as above with deicing---- | 44,394.00 | 994-7626-002 | Same as above with deicing---- | 140,621.00 |
| 994-7609-001 | TAB-12H, twelve bay batwing antenna for channels 7 thru 13, less deicing----- | 70,523.00 | | <u>TRANSMISSION LINE AND ACCESSORIES-----</u> | On Request |
| 994-7609-002 | Same as above with deicing---- | 80,902.00 | | <u>TC-80 LIVE COLOR TELEVISION CAMERA</u> | |
| | <u>ZIG-ZAG TELEVISION ANTENNAS-VHF</u> | | 994-7195-002 | TC-80 Live Color Camera including camera head (less lens), tiltable and removable viewfinder with two hoods, set up and operate panel, intercom panel, main power supply, processor frame with auto white and black balance, auto iris, inter connection panels and cables, XQ-1070G, XQ-1070B and XQ-1073 ext. red broadcast grade plumbicons for NTSC 525/60 operation----- | 57,225.00 |
| 994-7650-001 | TAZ-8H, one section VHF Zig-Zag antenna less deicing----- | On Request | 994-7195-004 | TC-80 Live Color Camera, same as above except for 625/50 PAL B operation----- | On Request |
| 994-7650-002 | Same as above with deicing---- | On Request | 994-7195-003 | TC-80 Live Color Camera including camera head (less | |
| 994-7619-001 | TAZ-16H, two section VHF Zig-Zag antenna less deicing----- | 114,597.00 | | | |

| TYPE NUMBER | PRODUCT DESCRIPTION | UNIT PRICE | TYPE NUMBER | PRODUCT DESCRIPTION | UNIT PRICE |
|--------------|--|------------|--------------|---|------------|
| | lens), tiltable and removable viewfinder with two hoods, set up and operate panel, intercom panel, main power supply, processor frame with auto white and black balance, auto iris, inter connection panels and cables, XQ-1090G, XQ-1090B and XQ-1093 ext. red anti-comet tail plumbicon for NTSC 525/60 operation----- | 58,469.00 | 727-1092-000 | Angenieux 42X12.5E11 zoom lens (studio) with remote iris, manual zoom (42:1) and focus, 12.5-525 mm, f1.5----- | 20,000.00 |
| 994-7195-005 | TC-80 Live Color Camera, same as above except for 625/50 PAL B operation----- | On Request | 727-0473-000 | Canon PV10X16B1 zoom lens, including 1.5 and 2.0 range extenders, with remote iris, manual zoom (10:1) and focus, 16-160 mm, f1.6----- | 12,800.00 |
| | <u>TRIAx SYSTEM FOR TC-80 CAMERA</u> | | 727-1039-000 | Canon PV18X12B2 zoom lens, including built-in 1.5 and 2.0 range extenders, with remote iris, manual zoom (18:1) and focus, 12-216 mm, f1.6----- | On Request |
| 994-7837-001 | TC-80 Triax System including TC-80 add on unit, rack mount CCU unit, Camera to triax add on unit cables, less Triax Camera Cable. (See below for Triax Camera Cable)----- | 15,225.00 | 727-1040-000 | Fujinon R14X16EWM-3 zoom lens, including built-in 1.5, 2.0 and 2.5 range extenders, with remote iris, manual zoom (14:1) and focus, 16-225 mm, f1.8----- | On Request |
| 939-2103-002 | Triax Cable - 100 ft. assembled with connectors----- | 373.00 | | Other 1-inch format lenses from Angenieux, Canon, Fujinon, Rank and Schneider--- | On Request |
| 939-2103-003 | Triax Cable - 250 ft. assembled with connectors----- | 494.00 | | <u>TC-50 LIVE COLOR TELEVISION CAMERA</u> | |
| 939-2103-004 | Triax Cable - 500 ft. assembled with connectors----- | 695.00 | 994-7943-004 | TC-50 Plumbicon Live Color Camera, including camera head with viewfinder w/outdoor & indoor hoods, set-up panel/control drawer, main power supply, interconnection panel & Harness, operate panel (m/pedestal, intercom, lens, iris), contours-from-green image enhancer, NTSC encoder, & broadcast grade Plumbicon tube set: (1) XQ1070G, (1) XQ1070B, (1) XQ1073R. Less lens and camera cable. (Utilizes both TV81 standard & TV81 mini cable)----- | 39,218.00 |
| 939-2103-005 | Triax Cable - 1000 ft. assembled with connectors----- | 1,097.00 | 994-7943-006 | TC-50 Plumbicon Live Color Camera, same as above but with mixed grade Plumbicon Tube set: (1) XQ1070G, (1) XQ1071B, (1) XQ1074R----- | 36,923.00 |
| 620-1479-000 | Jack, Male (King KP8020-740-400)----- | 94.00 | | <u>TC-50 CAMERA ACCESSORIES</u> | |
| 620-1476-000 | Plug, Female (King KP8010-740-400)----- | 105.00 | 994-7737-001 | Cable Compansation Module, for use with TC-50 camera. Required when using camera cable in lengths exceeding 300 feet with the TC-50 up to a maximum length of 1500 feet----- | 1,260.00 |
| 618-0457-000 | Cable, Triax 1000 ft. rolls only, Belden 9232----- | .76/ft. | 700-0352-000 | Color Sync Generator Module for use in the TC-50. Genlock/color lock or internal reference. One module capable of driving multiple cameras.----- | 950.00 |
| | <u>TC-80 CAMERA ACCESSORIES</u> | | | | |
| 992-4788-001 | NTSC Color Sync Generator Module for use in the TC-80 Camera. Color genlock or internal reference. One module capable of driving multiple cameras----- | 1,113.00 | | | |
| 992-4576-001 | Auto Centering Module----- | 2,226.00 | | | |
| 358-1978-000 | Vinyl rain cover for TC-80----- | 113.00 | | | |
| | <u>LENSES FOR TC-80 CAMERA</u> | | | | |
| 727-1038-000 | Angenieux 10X14E11 zoom lens, with remote iris, manual zoom (10:1) and focus, 14-140 mm, f1.6----- | 8,900.00 | | | |
| 727-0472-000 | Angenieux 15X14E61 zoom lens, including built-in 1.5, 2.0 and 2.5 range extenders, with remote iris, manual zoom (15:1) and focus, 14-210 mm, f1.6----- | 18,000.00 | | | |

| TYPE NUMBER | PRODUCT DESCRIPTION | UNIT PRICE | TYPE NUMBER | PRODUCT DESCRIPTION | UN. PRICE |
|--------------------|---|-------------------|--------------------|---|------------------|
| | <u>LENSES FOR TC-50 CAMERA</u> | | | <u>PICTURE AND WAVEFORM MONITORS</u> | |
| 727-1196-000 | Canon PV10X15B-IE zoom lens, including built-in 1.6 and 2.5 range extenders, with remote iris, manual zoom (10:1) and focus, 15-150 mm, f1.8----- | On request | 731-0151-000 | Conrac SNA9/C monochrome picture monitor, 9-inch unit in metal cabinet----- | 670.00 |
| 727-0530-000 | Schneider TV-38 zoom lens, with remote iris, manual zoom (10:1) and focus, 17-170 mm. f2.0----- | 4,500.00 | 731-0392-000 | 5522 C12 Conrac 12-inch color picture monitor in metal cabinet----- | 2,590.00 |
| | Other 1-inch format lenses from Angenieux, Canon, Fujinon, Rank and Schneider----- | On Request | 731-0402-000 | 528 Tektronix waveform monitor (525/60)----- | 1,360.00 |
| | <u>CAMERA CABLE, PEDESTALS, CAM HEADS-----</u> | On Request | 731-0478-000 | 1480C Tektronix waveform monitor (vertical format) NTSC only----- | 2,600.00 |

Rapidly changing conditions may necessitate price corrections from time to time. Therefore, the prices herein are subject to change without notice. All prices are F.O.B. Quincy, Illinois, or point of shipment.

HARRIS CORPORATION Broadcast Products Division
P. O. Box 290, Quincy, Illinois 62301 U.S.A.