

HARRIS
COMMUNICATION AND
INFORMATION PROCESSING

1980

FOREWORD

The Harris Corporation, Broadcast Products Division, proudly presents its catalog of television and radio transmitting and allied studio equipment. This fine product line underscores Harris' position as one of the world's leading manufacturers of broadcast equipment. The hardware featured on these pages meets virtually every requirement of the television or radio broadcaster.

Field sales and service facilities are extensive. Sales offices are located in New York City, Washington, D.C., Houston and Los Angeles. In Canada, sales are handled by Harris Systems Limited in Toronto and Montreal. International market activities are coordinated by the International Sales Department in Quincy, Illinois through representatives located throughout the world.

The Broadcast Products Division is one of 19 divisions of Harris Corporation, a world leader in communication and information processing, and one of the nation's 500 largest corporations. Harris' other electronics divisions include Controls Division, Electronic Systems Division, RF Communications Division, Harris Semiconductor Division, PRD Electronics Division and Composition Systems Division. Harris Video Systems Operation, a separate operating arm of Broadcast Products Division located in Sunnyvale, California, manufactures an extensive line of digital video products.

Several research centers within Harris' electronic group enable the Broadcast Products Division to draw from a large staff of scientists and engineers, as well as from the impressive engineering organization in Quincy. These resources assure our customers that Harris broadcasting and communications equipment is synonymous with product leadership.

Harris has built its reputation on quality craftsmanship, superior service, excellence of engineering design and pioneering of outstanding new products. We value your patronage; we'll justify your confidence.



PDM

Pulse Duration Modulator

Harris' patented Pulse Duration Modulation (PDM) is used in the Harris VP-100A, SW-100, SW-50, MW-50A, MW-10, and MW-5A broadcast transmitters. PDM produces conventional high level plate modulation...the difference is simply the manner in which the audio signal is amplified and applied in series with the RF amplifier plate supply. However, this one difference provides several distinct advantages...particularly a much higher efficiency, and the elimination of large iron core components.

The Pulse Duration Modulator operates as follows:

1. The audio input (A) is added to a 75 kHz sawtooth wave (B) to form (C).
2. A threshold level (Power control) is set and determines the point on the sawtooth wave at which the pulse amplifier will conduct. After clipping and amplification, squared pulses (D), which vary in duration with the input audio, are formed.
3. A low pass filter removes the 75 kHz pulse rate, leaving very high audio power to fully modulated the PA. No modulation transformer or reactor is required.

The duty cycle of the pulse determines the voltage at the plate of the PA. For instance, a 50% duty cycle will produce 13 kV at the PA or the 100 kW carrier; a 100% duty cycle will place the full supply voltage of about 28 kV on the PA which conforms to over 100% positive modulation peak; a 0% duty cycle will produce 0 voltage at the PA or the 100% negative modulation tip. The rate of variation of the pulse width is the audio signal...hence a Pulse Duration Modulator.

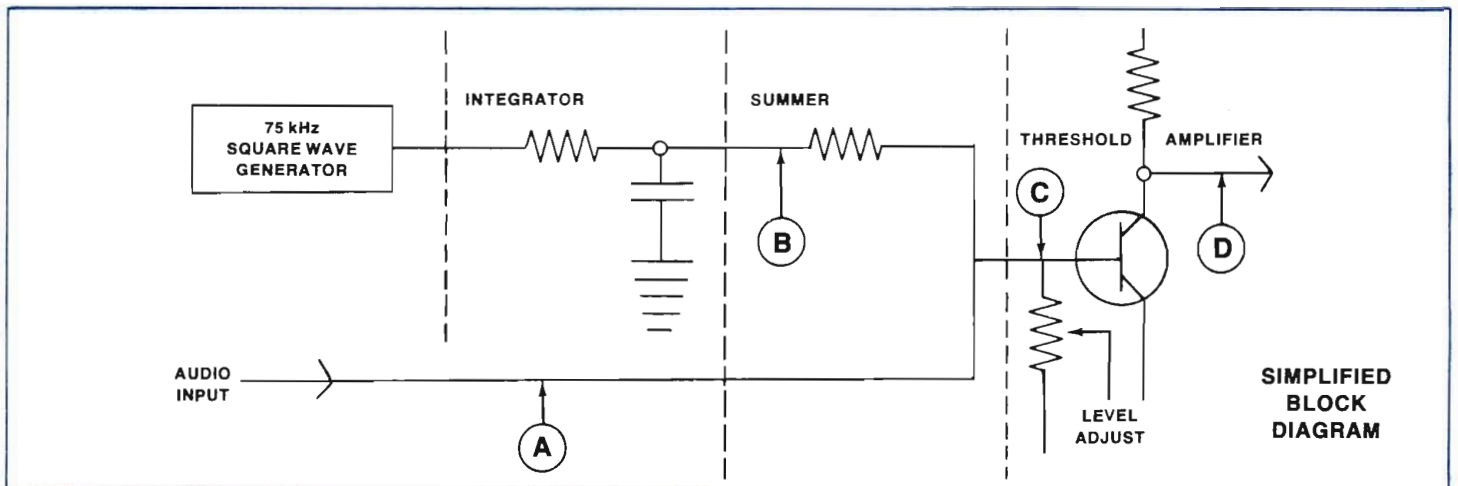
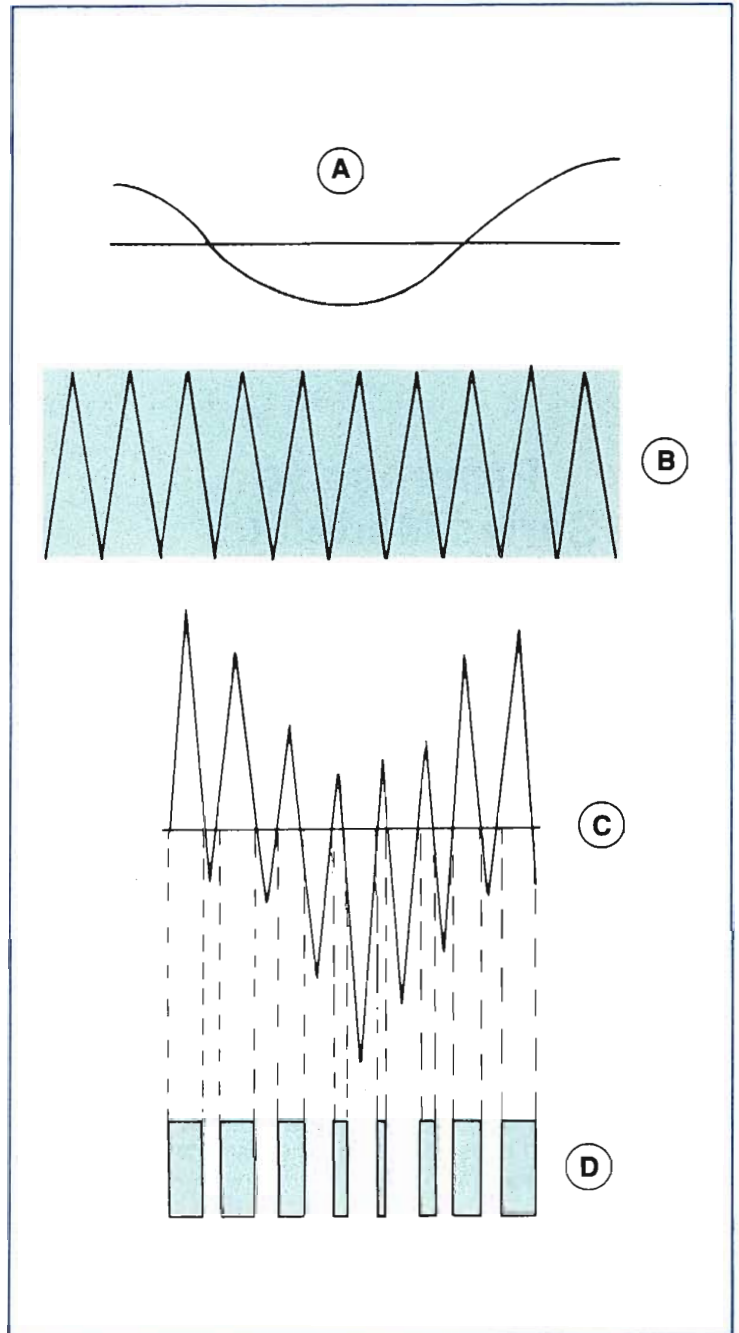



HARRIS
COMMUNICATION AND
INFORMATION PROCESSING

PSM

Progressive Series Modulator

Up to now, series modulators—which have the advantage of great operational simplicity—have been too inefficient to be used effectively. Now, with the introduction of Harris' Progressive Series Modulator, simplicity and high efficiency have been combined into one excellent high-level modulation method which is used in Harris' solid-state 1 kilowatt AM transmitter, the MW-1A.

A conventional series modulator is shown in Figure A. It has one active device, Q1 (modulator), which regulates the 100 volt power supply to provide the proper voltage at carrier and the modulation voltage to the PA. Its only drawback is its inefficiency. Under carrier conditions, only 50 volts is required at the PA. This means 50 volts is also across the modulator, Q1. Whatever current is required at the PA must flow through Q1.

Assume 24 amps and 50 volts is required at the PA to achieve the 1000-watt carrier. This means 24 amps is also flowing in Q1 and the power lost in Q1 is 1200 watts (all heat). This is much too inefficient, even for a one kilowatt transmitter. The PA and output network operate at about 85%, so the loss in the PA and output network is only 200 watts. (1200 watts input and 1000 watts rf output = 85% efficiency.)

If the advantages of a DC coupled series modulator are to be utilized, a more efficient method must be found—hence a Progressive Series Modulator (PSM). PSM is two series modulators, in series, as shown in Figure B. Two power supply voltages are now used. One is a little higher than that required to produce the proper PA voltage at carrier conditions, and the second is high enough to provide the positive peak required.

Now, during carrier, all the PA voltage comes from the 52-volt supply through CR1 and Q1. Only about 2 volts is lost across the modulators, so the required 50 volts, 24 amps is provided the PA. The loss across the modulator at carrier is now 2×24 , or 48 watts, and the power to the PA is 50×24 , or 1200 watts.

During the positive peak the PA voltage is supplied from the 104-volt supply through Q2 and Q1 (CR1 disconnects the 52-volt supply when Q2 turns on.) During the negative peak Q2 is open, and the voltage is supplied from the 52-volt supply through CR1 and Q1.

Thus PSM—a Progressive Series Modulator which is highly efficient, is DC coupled, has excellent transient response, and requires no modulation transformer or reactor or filter inductor.

NOTE: Voltages used in the MW-1A vary slightly from the example above, to provide 125% positive peak modulation capability.

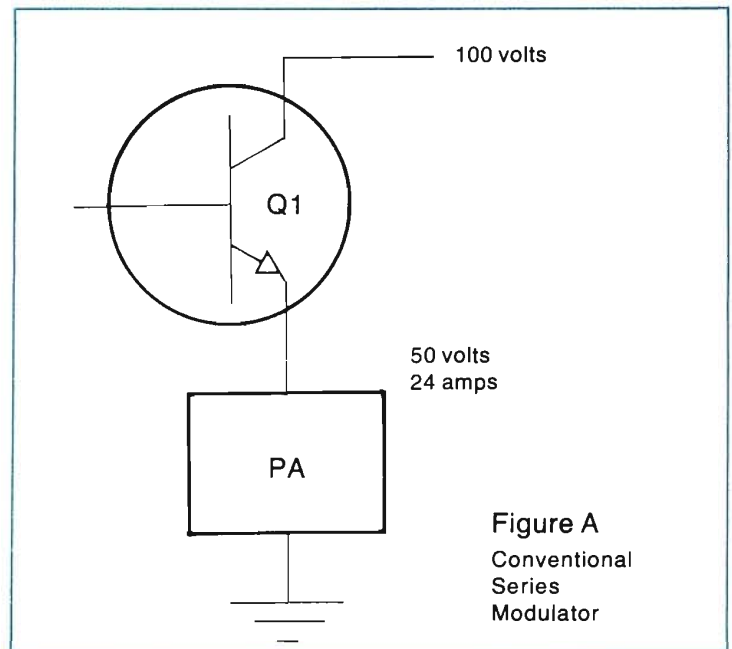

Figure A
Conventional
Series
Modulator

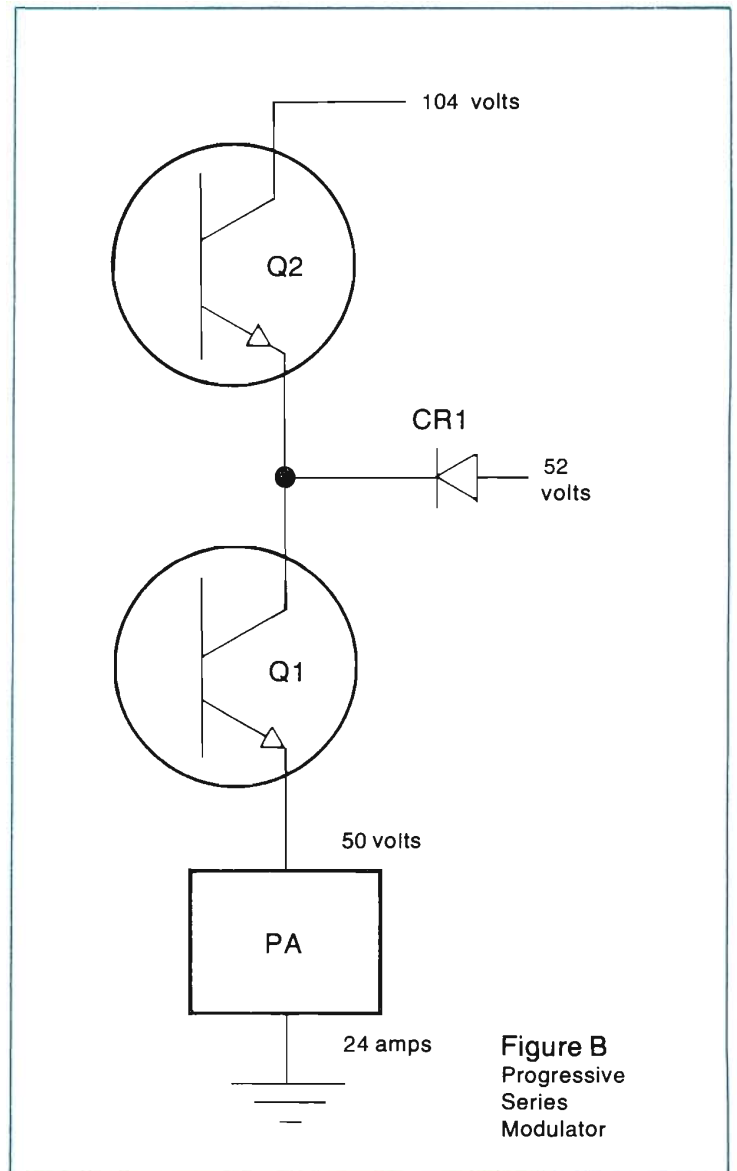

Figure B
Progressive
Series
Modulator



HARRIS
COMMUNICATION AND
INFORMATION PROCESSING

VP-100A

100,000 Watt Medium Wave Broadcast Transmitter

- Overall efficiency better than 65%
- Exclusive Pulse Duration Modulator [PDM]* for high level plate modulation
- Redundancy in solid state circuits
- Vapor phase cooling for quiet operation and extended tube life
- Only five tubes, with three tube types
- Designed for a wide climate range

*Patented

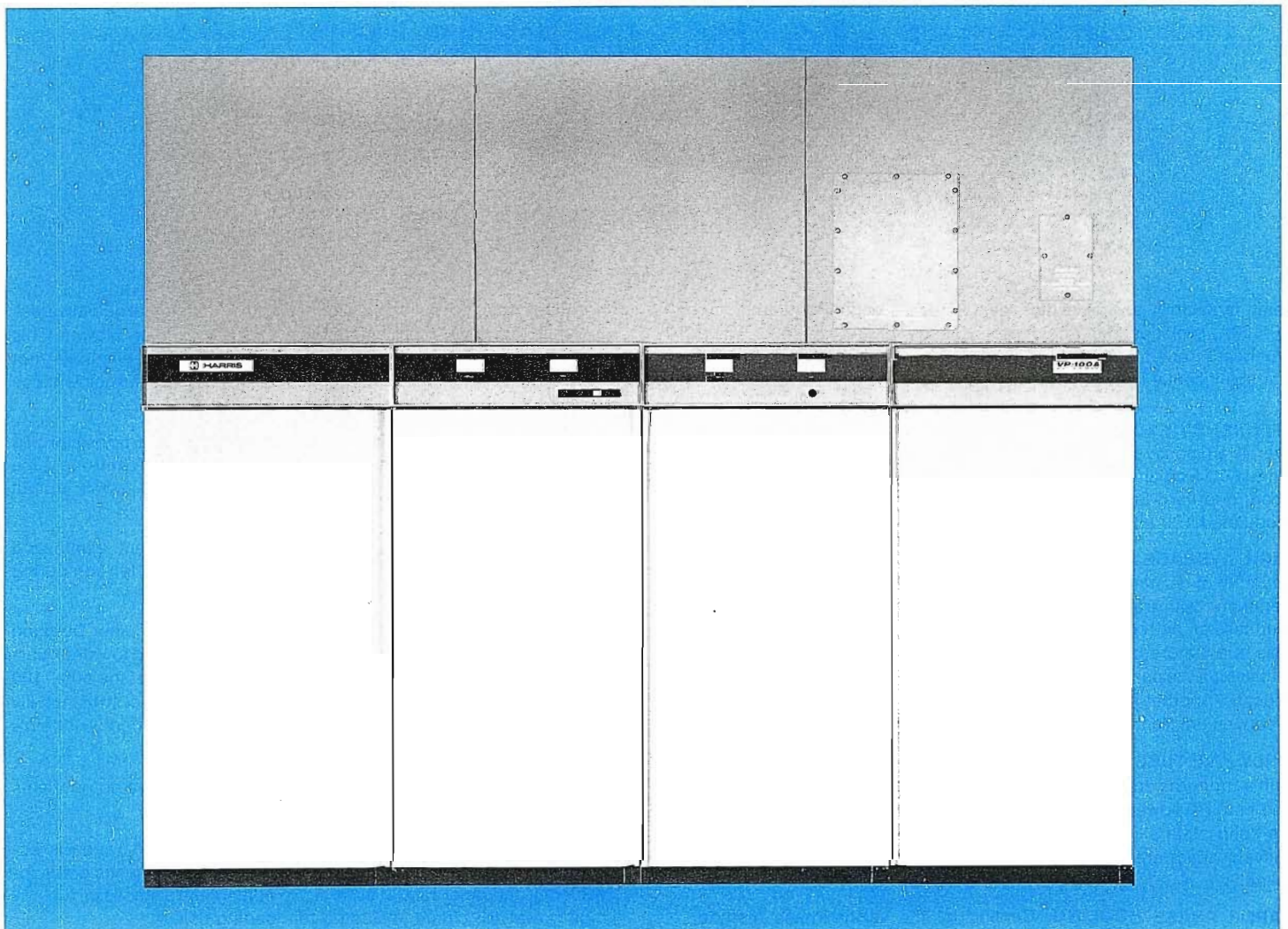

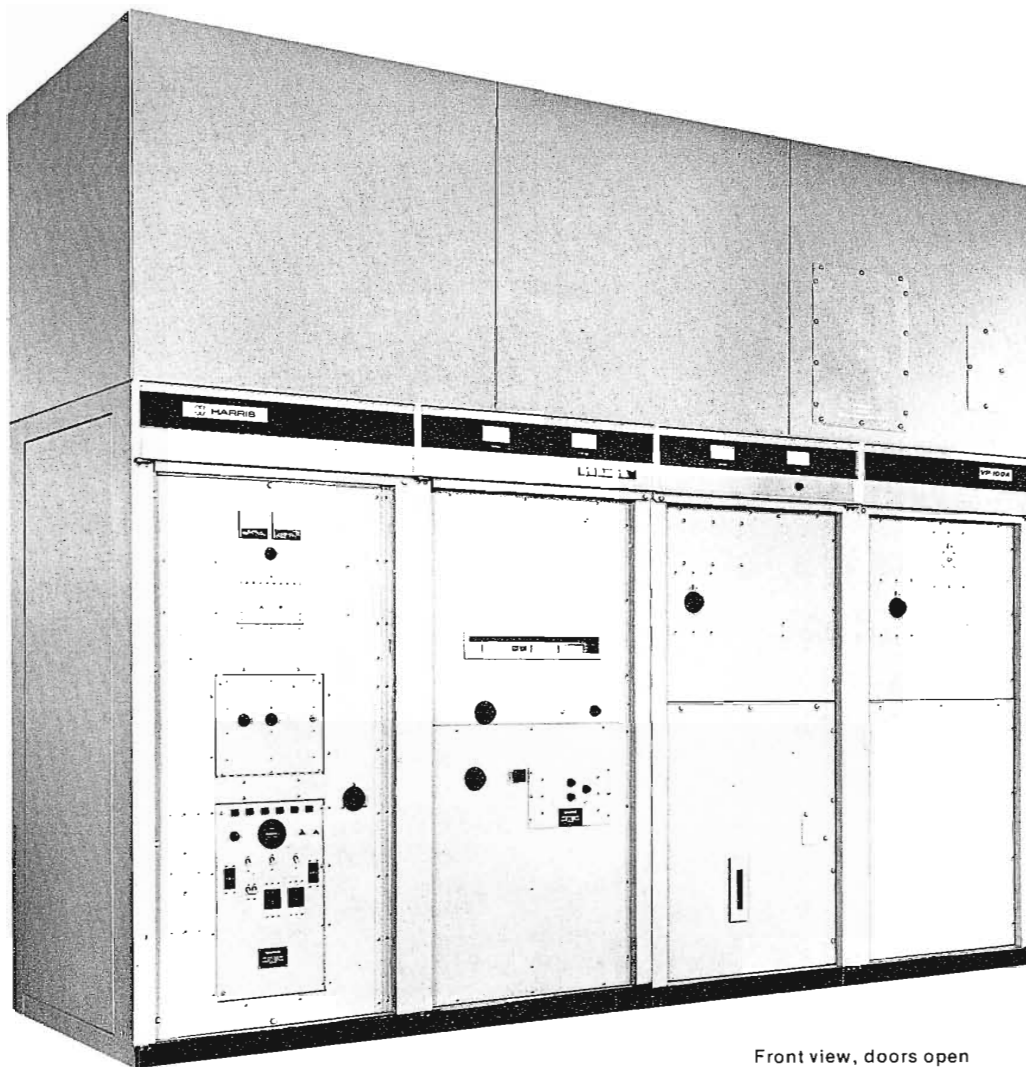

Front view, doors open

Featuring Harris' exclusive high level Pulse Duration Modulator*, the VP-100A provides the finest performance of any medium wave broadcast transmitter in the same power range on the market today ...at significantly lower operating costs.

EFFICIENCY EXCEEDS 65%. The VP-100A has an unusually high overall efficiency of more than 65%. This is made possible by the almost 90% efficiency of the Pulse Duration Modulator—and means about one-third less power consumption than other high level plate modulated 100 kilowatt transmitters.

HIGH AVERAGE MODULATION CAPABILITY. The transmitter is capable of sustained high average modulation such as that experienced with trapezoidal audio processing—which means greater loudness at the receiver without increased transmitter carrier power. This is a feature of the high efficiency, DC coupled PDM modulator that avoids the use of large, inefficient transformers in the modulation process. Another feature of this high efficiency series type modulator is convenient front panel carrier power adjustment over a wide range.

ONLY FIVE TUBES. The entire transmitter employs just five tubes—with a modern ceramic 4CV100,000C power tetrode in the modulator and final RF power amplifier sockets. All power supplies utilize long-life solid state silicon rectifiers. High quality components, conservatively rated, are used throughout the VP-100A to assure greatest reliability.

VAPOR PHASE COOLING. Cooling by the Vapor Phase method

produces quiet operation by eliminating the need for large blowers—the heat exchanger is cooled by a two horsepower blower. This method of cooling also extends tube life by helping to eliminate "hot spots" and by maintaining tube anode temperatures far below those attained by other methods.

RF SECTION. The RF chain is conventional, using a transistorized oscillator, buffer, emitter follower, and a 4CX1500A tetrode tube amplifier to drive a single 4CV100,000C tetrode Class C power output stage.

An automatic drive control limits the PA screen current, eliminating the usual problem of over dissipating the screen of a tetrode during tune-up.

THE MODULATION SYSTEM. Harris' exclusive Pulse Duration Modulator is characterized by low plate dissipation and low peak currents; peak cathode currents are about one-half that of the other 100 kilowatt transmitters. Average plate dissipation runs substantially below rated levels, and all peak voltages are maintained well below component ratings.

Wide frequency response is possible as large reactive components are not used in the modulation system.

Control of the transmitter power output over a wide range is accomplished in a low-level stage of the modulator by means of a convenient front panel vernier control. No adjustment is necessary in any high power RF circuit, including the loading coil.

*U.S. Patent No. 3440566

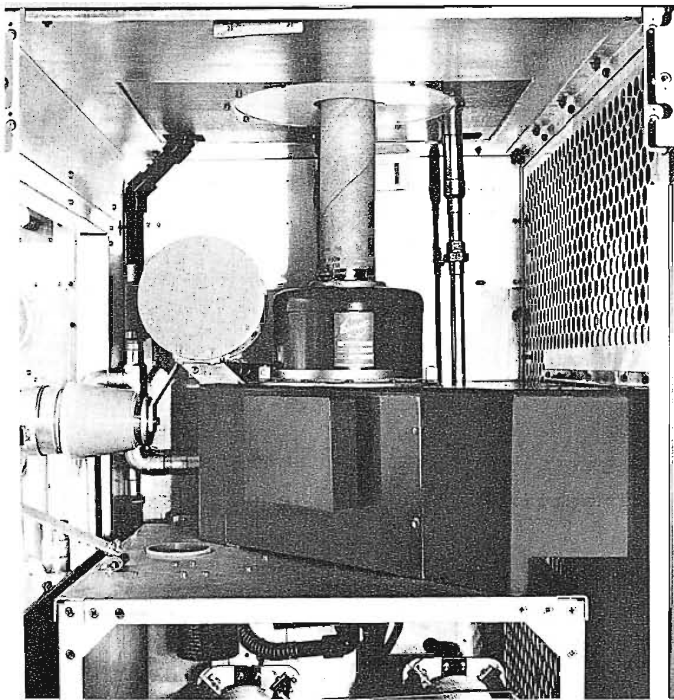

Power amplifier tube compartment, rear view.

PROTECTIVE CIRCUITS. All major components of the VP-100A are protected by circuit breakers. Tubes and transistors are protected by overload relays or current-limiting devices.

A quick-acting circuit protects against damage by high voltage arcs by limiting the energy in such arcs to less than 10 watt seconds.

Protection against voltage standing wave ratios of greater than 1.2:1 is provided. Both forward and reflected power are metered at the front panel.

In case of momentary RF overloads the VP-100A will recycle twice automatically. Should a third overload occur within a thirty second period, the transmitter will remain off until manually reset. However, if the time between overloads is greater than thirty seconds, continuous recycling will occur.

DUAL OSCILLATOR AND MODULATOR. Harris has provided redundancy in all transistor sections to relieve any concern over solid state circuitry in high-powered transmitters. Although the reliability of transistor circuitry has been proven in transmitters now operating under extreme conditions, this duplication is your double assurance of complete dependability.

DESIGNED FOR WIDE RANGE OF CLIMATES. The transmitter will give top performance in a wide range of climates—from hot and humid, to dry and dusty. With Vapor Phase cooling, ducting outside air into the transmitter is not necessary. All transformers and similar components are hermetically sealed, encased, or vacuum impregnated. All high power radio frequency networks contain silver-plated inductors and vacuum capacitors.

GREATLY REDUCED FLOOR SPACE. Due to the high efficiency of the transmitter and the elimination of large iron core components (no modulation transformer and reactor), the VP-100A requires only 7.0 square meters (76 square feet) of floor space. Careful cabinet design provides easy accessibility to all components.

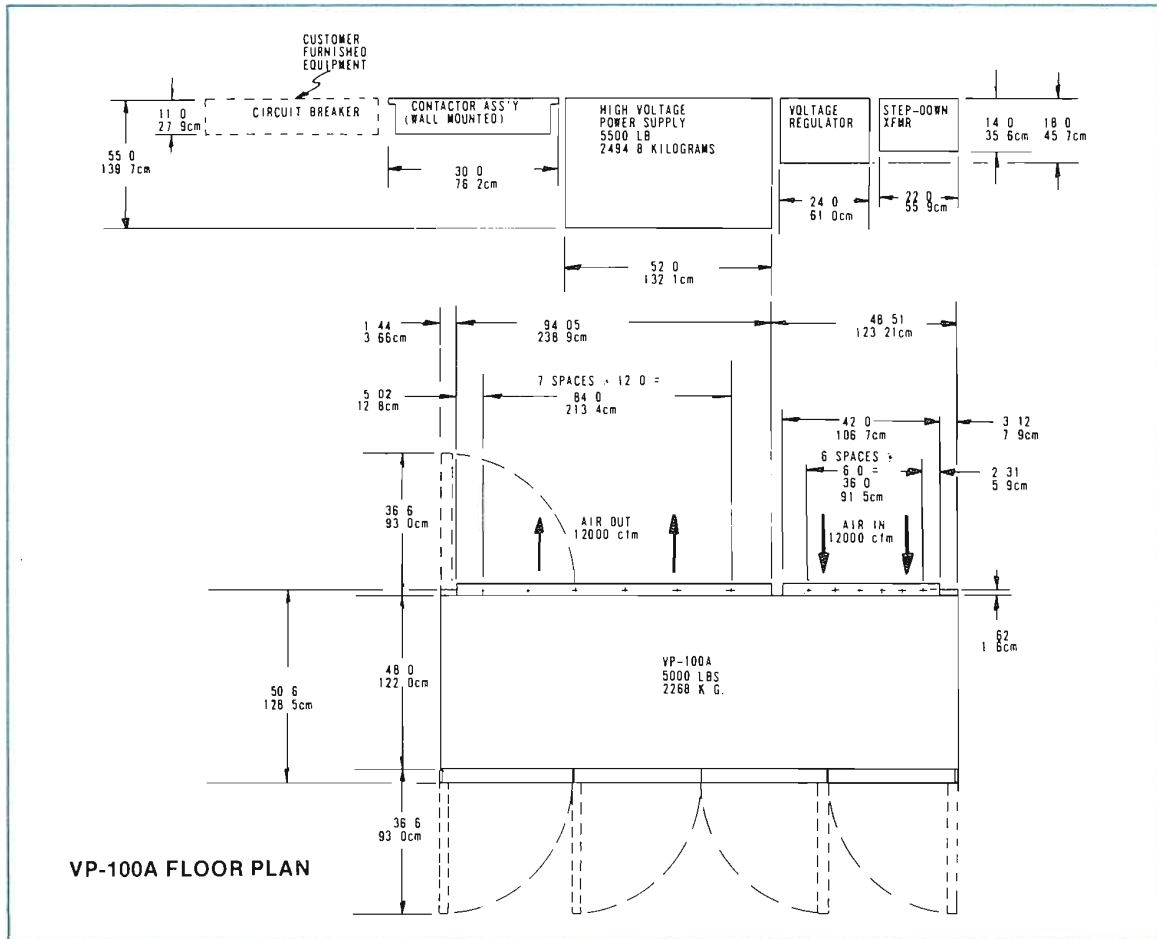

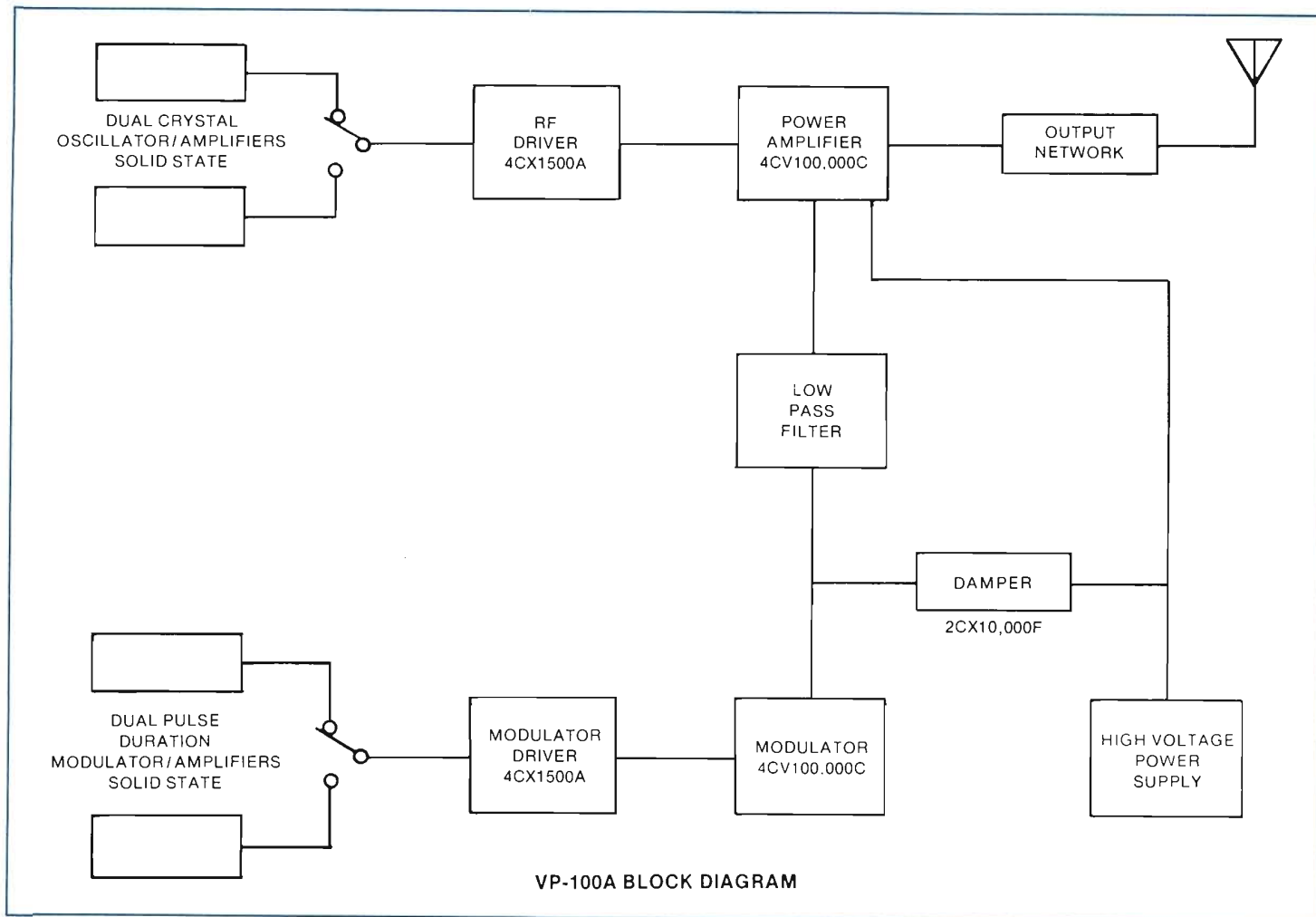

VP-100A SPECIFICATIONS

POWER OUTPUT: 100,000 watts nominal unmodulated, capable 110,000 watts.

RF FREQUENCY RANGE: 535 kHz to 1620 kHz.

RF OUTPUT IMPEDANCE: 230 ohms, unbalanced.

RF FREQUENCY STABILITY: ± 5 Hz.

SPURIOUS AND HARMONIC EMISSION: Less than 50 mW.

CARRIER SHIFT: Less than 5% at 100% modulation at 1,000 Hz.

AUDIO FREQUENCY RESPONSE: ± 1.5 dB from 40 to 10,000 Hz referenced to 1,000 Hz at 95% modulation.

AUDIO FREQUENCY DISTORTION: Less than 3% from 40 to 10,000 Hz at 95% modulation.

NOISE: 55 dB below 100% modulation at 1,000 Hz.

AUDIO INPUT LEVEL: 10 dBm ± 2 dB for 100% modulation.

AUDIO INPUT IMPEDANCE: 600/150 ohms, balanced or unbalanced.

MODULATION LEVEL: 100% sinusoidal, 10 minutes, 50 to 5,000 Hz.

TRAPEZOIDAL MODULATION: Less than 5% tilt or overshoot, 100 Hz to 2,000 Hz.

POWER INPUT: Any specified voltage 380V to 480V, 3 phase, 50 or 60 Hz.

POWER CONSUMPTION: 155 kW—No modulation
160 kW—30% modulation
215 kW—100% modulation

POWER FACTOR: 95%.

VOLTAGE REGULATOR: Electronic voltage regulation for all power supplies other than high voltage.

OVERALL EFFICIENCY: 65% at average modulation.

TUBES: Two 4CV100.000C; two 4CX1500A; one 2CX10.000F.

TEMPERATURE RANGE: 0-50°C ambient air temperature.

HUMIDITY: 95% relative humidity, maximum.

STORAGE TEMPERATURE: -35°C to +60°C (with no water in system).

ALTITUDE: Up to 1,829 meters (6,000 feet) above sea level.

CABINET DATA: Each of two cabinets measures 1.83 meters (6 feet) wide, 1.37 meters (4.5 feet) deep, and 1.98 meters (6.5 feet) high. The heat exchanger adds another 1.06 meters (3.5 feet) in height.

ORDERING INFORMATION

VP-100A, 100,000 watt medium wave transmitter with one set of

tubes, crystals and silicon rectifiers, for operation from

380 to 480 volts, 3 phase, 50 or 60 Hz 994-7651-001



HARRIS
COMMUNICATIONS AND
INFORMATION HANDLING

MW-50A

50,000 Watt
Medium Wave
Broadcast
Transmitter

- High level plate modulated, using a Pulse Duration Modulator (PDM)*—no modulation transformer or reactor
- Built-in audio processing circuit allows greater modulation density
- High overall efficiency . . . exceeds 60%
- Minimum power consumption . . . only 87 kW at 30% modulation
- Only four tubes, with two tube types; just one power amplifier tube and one modulator tube
- Quiet, air-cooled operation
- Compact design
- Power level is adjusted in low level PDM stage. No loading adjustment is required
- Switches smoothly from high to low power with carrier on
- Automatic return to operation after a power failure
- All remote control accessories built in

*Patented

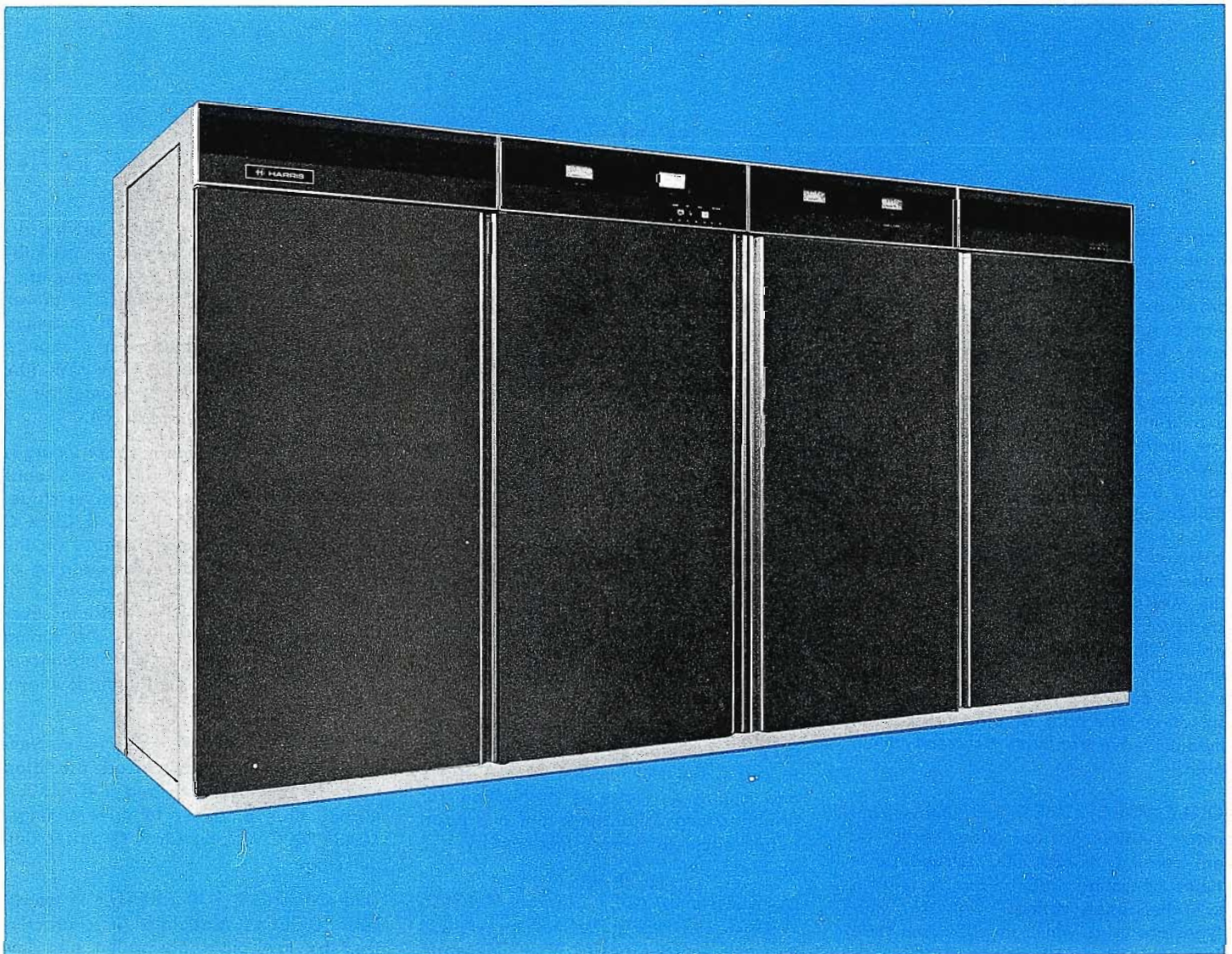

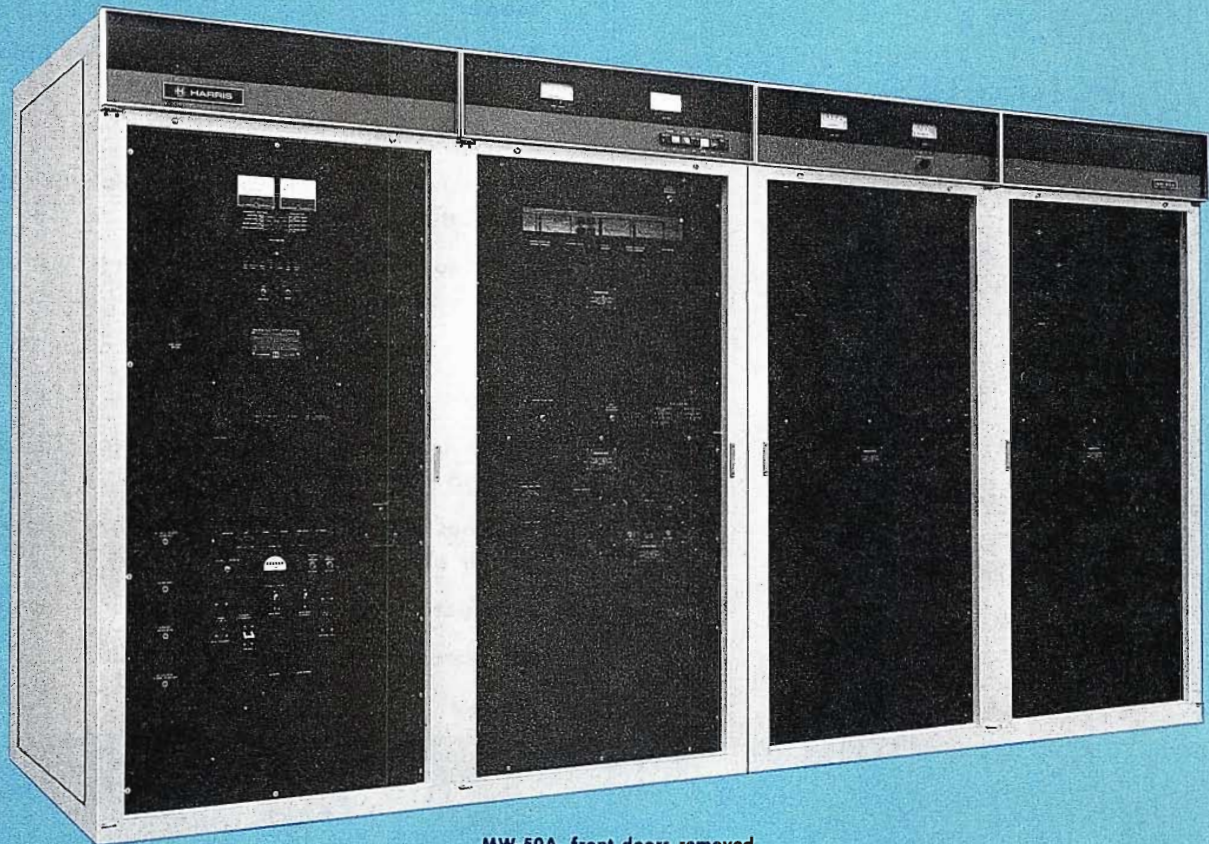

MW-50A, front doors removed.

Harris' MW-50A, 50-kilowatt medium wave transmitter, provides overall performance superior to that of any other broadcast transmitter in its power range—at a lower operating cost! The transmitter is high level plate modulated, using Harris' exclusive, highly efficient Pulse Duration Modulator (PDM)—and includes a built-in audio processing circuit to allow greater modulation density. With the MW-50A you get the loudest, clearest sound in town—and the most advanced 50-kilowatt AM transmitter in the world.

HIGH EFFICIENCY—EXCEEDS 60%. The Pulse Duration Modulator employed in the MW-50A is nearly 90% efficient (instead of the usual 50% or 60%), enabling the transmitter to achieve an unusually high overall efficiency of greater than 60%. This means less power consumption than that of other 50-kilowatt medium wave transmitters currently available.

ONLY FOUR TUBES. The entire transmitter employs just four tubes—with modern ceramic 4CX35,000C tetrode power tubes operating well below manufacturer's dissipation ratings. Only two tube types are used, which simplifies the stocking of spares. All power supplies use

long-life solid-state silicon rectifiers. Highest quality components, conservatively rated, are used throughout the MW-50A to assure a maximum degree of reliability.

CONTINUOUS 100% MODULATION RATING.

This continuous sine wave modulation capability permits a higher average modulation to boost signal strength without increasing transmitted carrier power. The MW-50A provides 125% positive peak capability when operating at a full 50-kilowatt RF power output.

AUDIO PROCESSING.

In the MW-50A, an adjustable audio processing circuit is built in. This circuit is designed to reduce the small modulation peaks, which have little power and are holding the average level down, and allow the larger and more powerful levels of the audio signal to modulate the transmitter at the maximum limit. Front panel controls include separate adjustments for both positive and negative peaks; a pushbutton for disabling and calibrating; and one pushbutton each to increase loudness by 1, 2 or 3 dB.

MAXIMUM CARRIER POWER 60 KILOWATTS.

The Harris MW-50A provides a maximum carrier power of 60 kilowatts,

which allows more reserve for driving directional arrays than any other 50 kilowatt medium wave broadcast transmitter. The MW-50A uses DC feedback for power output stability, which insures minimum RF power output change with a change of the power line voltage. The MW-50A can be switched smoothly from high to low power with the carrier on.

EASY TUNING.

Output network tuning is accomplished by PA plate tune and loading control of the power amplifier stage, which operates essentially as a Class C amplifier. Automatic gain control on the power amplifier screen allows tuning of the Type 4CX35,000C tetrode as if it were a triode, without any risk of over dissipating the screen. After PA tuning and loading controls are optimized, power output is controlled in the low level PDM stage.

RF SECTION.

The RF chain is conventional, using a transistorized oscillator, buffer, emitter follower, and a 4CX1500A tetrode tube amplifier to drive a single 4CX35,000C tetrode Class C power output stage.

THE MODULATION SYSTEM.

Harris' Pulse Duration Modulator is characterized by low plate dissipation and low

tube peak currents. Peak cathode currents are about one-half that of other 50-kilowatt transmitters. Average plate dissipation runs substantially below rated levels, and all peak voltages are maintained well below component ratings. In addition, the PDM design allows continuous 100% sine wave modulation.

The modulator efficiency is about 90%, and a wide frequency response is possible, as large reactive components are not used in the modulation system.

PROTECTIVE CIRCUITS. All major components of the MW-50A are protected by circuit breakers. Tubes and transistors are protected by overload relays or current limiting devices. Overloads are indicated by light-emitting diodes.

A quick-acting "crowbar" circuit protects against damage from high voltage arcs by limiting the energy in such arcs to less than 10 watt seconds.

Protection against voltage standing wave ratios of greater than 1.2 to 1.0 is provided. Both forward and reflected power are metered at the front panel.

In case of momentary RF overloads, the MW-50A will recycle automatically. Should a repeated overload occur within a thirty-second period, the transmitter will remain off until manually reset. However, if the time between overloads is greater than thirty seconds, continuous recycling will occur.

QUIET AIR COOLING. Cooling of the MW-50A is accomplished by a 3-horsepower blower, 2300 CFM at 2" water, located in the transmitter cabinet, which provides cooling for the power tubes at a very low noise level. The transmitter cabinet air is flushed with a low speed fan which also operates at a very low noise level. Provisions are made at the top of the transmitter for ducting the exhaust air to the outside of the transmitter building.

DESIGNED FOR A WIDE RANGE OF CLIMATES. The MW-50A provides top performance in all types of climates, from hot and humid to dry and dusty. All transformers and similar components are hermetically sealed, encased, or vacuum impregnated. Performance at 10,000 feet (3048 meters) is certified by a recognized testing organization.*

TRANSMITTER LAYOUT. The MW-50A consists of two cabinets and an external high voltage power transformer. External connections to the transmitter are made through either the top or the bottom of the unit, as desired, for great installation flexibility.

* Copy of certificate available on request.

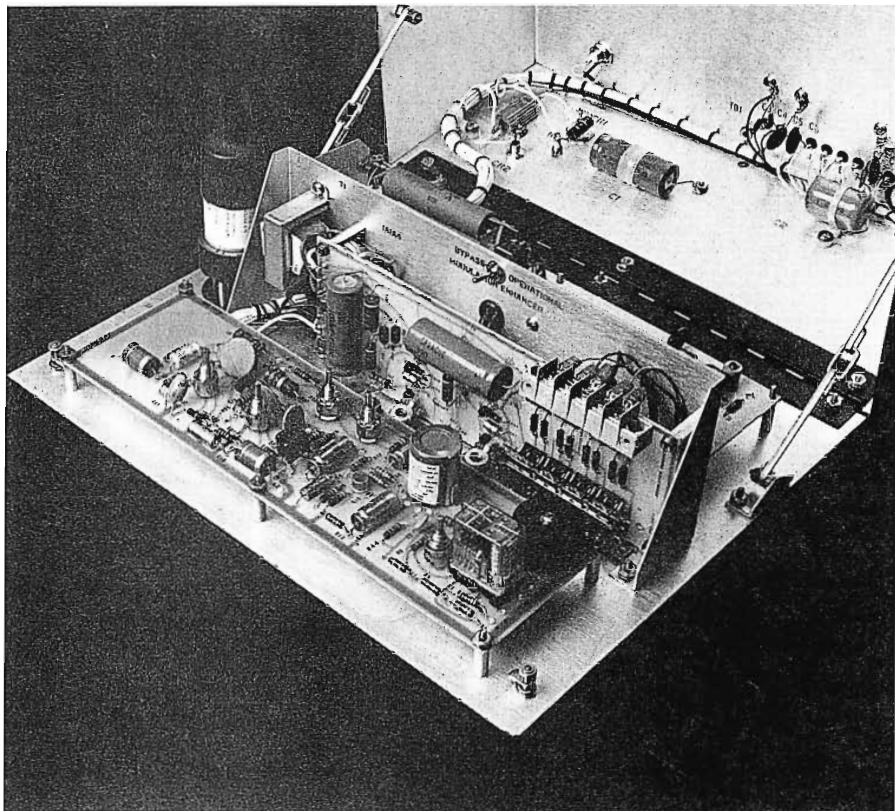

Low level Pulse Duration Modulator chassis, showing power control, low level Pulse Duration Modulator and audio input/control board.

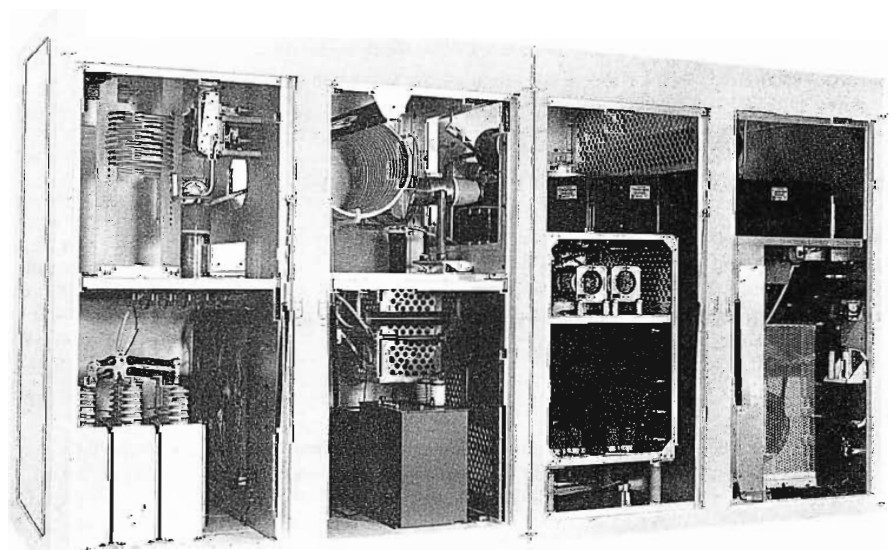

Rear view, doors removed, showing easy accessibility to components.

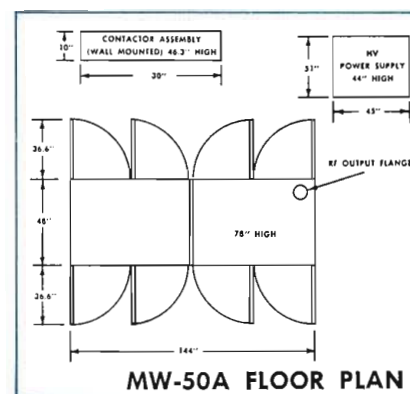
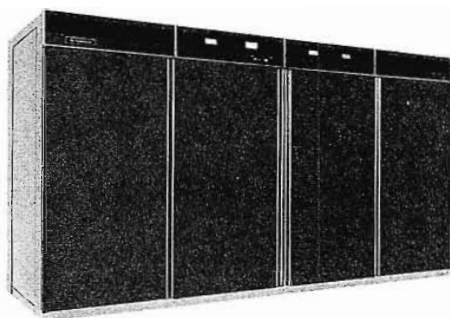
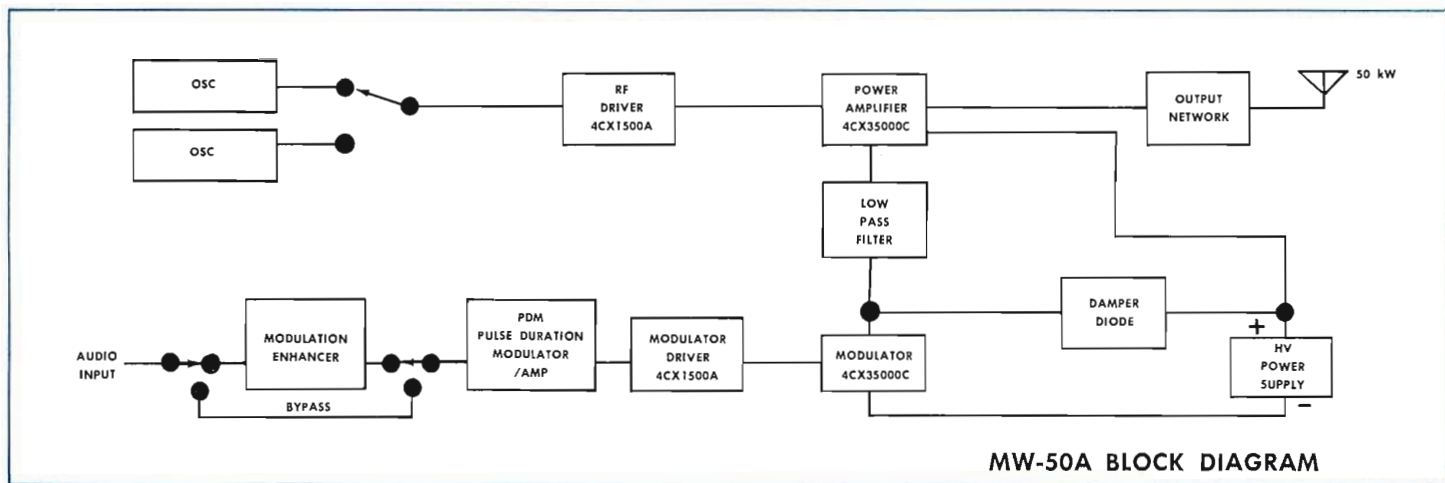

MW-50A SPECIFICATIONS

POWER OUTPUT: 50,000 watts (rated), 60,000 watts (capable). Convenient power reduction to 25,000 or 10,000 watts.

RF FREQUENCY RANGE: 535 kHz to 1620 kHz, supplied to frequency as ordered.

RF OUTPUT IMPEDANCE: 50 ohms unbalanced (higher on special order).

RF FREQUENCY STABILITY: ± 5 Hz.

RF HARMONICS: Exceeds FCC and CCIR specifications.

CARRIER AMPLITUDE REGULATION: Less than 2% at 100% modulation.

AUDIO FREQUENCY RESPONSE: ± 1.5 dB, from 20 to 10,000 Hz, referenced to 1,000 Hz, at 95% modulation.

AUDIO FREQUENCY DISTORTION (Unenhanced): Less than 3%, 20 to 10,000 Hz at 95% modulation.

COMPRESSION RATIO: 4/1 dB at 3 dB of enhancement; -95% , $+125\%$ modulation.

NOISE (Unweighted): -57 dB or better below 100% modulation.

AUDIO INPUT: 600 ohms at $+10$ dBm ± 2 dB, for 100% modulation, unenhanced; $+16$ dBm with enhancement activated.

POWER INPUT: 480 V $\pm 5\%$, 3 phase, 60 Hz. Available for 380 V $\pm 5\%$, 3 phase, 50 Hz.

POWER CONSUMPTION: 80 kW at 0% modulation
87 kW at 30% modulation
110 kW at 100% modulation

OVERALL EFFICIENCY: Better than 60% at average modulation.

POWER FACTOR: 95%.

TUBES USED: (2) 4CX35.000C; (2) 4CX1500A.

TEMPERATURE RANGE: -20°C to $+50^{\circ}\text{C}$.

HUMIDITY: 95%.

ALTITUDE: Up to 3,048 meters (10,000 feet) above sea level. (Higher on special order.)

SIZE: 78 inches (2.0 meters) high, 144 inches (3.7 meters) wide, 48 inches (1.2 meters) deep (transmitter cabinet). External components include high voltage power supply and wall mounted circuit breaker assembly.

FLOOR SPACE: Main transmitter assembly 48 square feet (4.5 sq. meters). Power supply 15 square feet (1.4 sq. meters).

WEIGHT (Approximate):

Main Transmitter Assembly		Power Supply	
Net unpacked	5,000 lbs. (2268 kg)	Net unpacked	1,370 lbs. (622 kg)
Domestic packed	6,000 lbs. (2722 kg)	Domestic packed	1,500 lbs. (681 kg)
Export packed	7,200 lbs. (3266 kg)	Export packed	1,800 lbs. (817 kg)

CUBAGE: Packed: 700 cubic feet. (19.8 cu. meters)

FINISH: White and blue.

ORDERING INFORMATION

Model MW-50A, with one set of tubes and two crystals, 60 Hz -----994-7964-003

Model MW-50A, with one set of tubes and two crystals, 50 Hz -----994-7964-005

100% set of spare tubes for MW-50A transmitter -----990-0826-001

Recommended minimum spare tubes for MW-50A transmitter -----990-0827-001



HARRIS
COMMUNICATION AND
INFORMATION PROCESSING

MW-10

10,000 Watt Medium Wave Broadcast Transmitter

- High level plate modulation, using a Pulse Duration Modulator (PDM)*
- 125% positive peak modulation capability at 11,000 watts
- No modulation transformer or reactor
- Built-in audio processing circuit allows greater modulation density
- Excellent accessibility to all components
- Automatic return to full power after power failure
- All remote control accessories built in
- Power level is adjusted in low level PDM stage. No PA loading adjustment required
- Full performance ratings at 10,000 feet (3048 meters)

*Patented

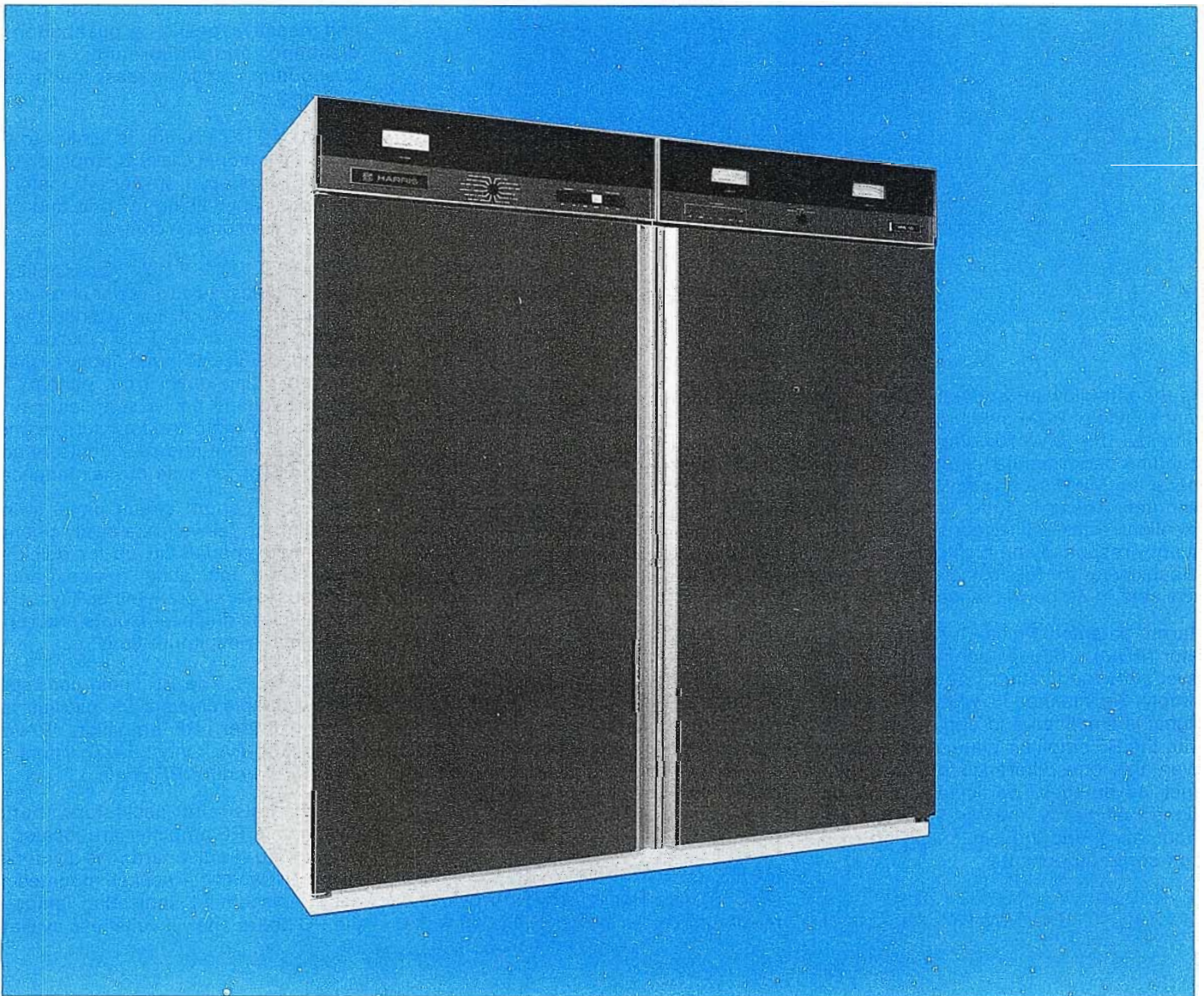

Harris' MW-10 ten kW medium wave PDM transmitter

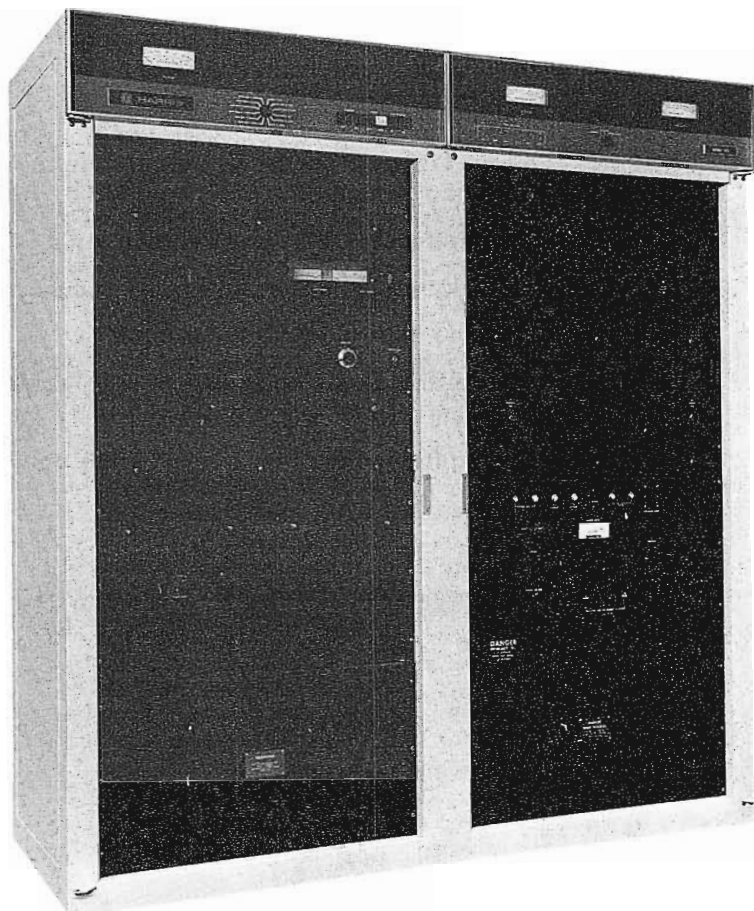

Front view, doors removed.

As the ten-kilowatt model in Harris' advanced line of PDM medium wave transmitters, the MW-10 offers the outstanding performance features that have made the MW-50A and MW-5A industry favorites. These include low distortion, excellent transient response, wide frequency response and high positive peak capability for the loudest, cleanest signal available in its power range.

Harris' patented Pulse Duration Modulator (PDM) produces conventional high level plate modulation...the difference is simply the manner in which the audio signal is amplified and applied in series with the RF amplifier plate supply. However, this one difference provides distinct advantages, particularly a much higher efficiency (nearly 90% for the modulator), and the elimination of large iron core components.

125% POSITIVE PEAK MODULATION CAPABILITY.

The MW-10 is capable of

providing the maximum positive modulation peaks allowed by the FCC and the Canadian D.O.C. (125%), with reserve for great reliability. This can mean higher average modulation levels for louder, clearer signals, with no increase in transmitter carrier power. A wide frequency range is possible, as large reactive components are not used in the modulation system.

ONLY TWO TUBES. The entire transmitter employs just two tubes—a 3CX15,000H3 PA and a 4CX15,000A modulator—both operating well below manufacturer's dissipation ratings. All power supplies use long-life solid-state silicon rectifiers. Highest quality components, conservatively rated, are used throughout the MW-10 to assure maximum reliability.

MAXIMUM CARRIER POWER 11,000

WATTS. The Harris MW-10 provides a maximum carrier power of 11,000 watts,

which allows more reserve for driving directional arrays. The transmitter uses DC feedback for power output stability, which insures a minimum of RF power output change with a change of the power line voltage. This is especially important where brownouts occur, and where transmitters are logged every three hours. The MW-10 is FCC type accepted for 10, 5 and 2.5 kilowatts, and power reduction from 10 to 2.5 kilowatts may be accomplished with carrier on. The PA utilizes 3rd harmonic wave shaping for improved efficiency.

AUDIO PROCESSING. In the MW-10, an adjustable audio processing circuit is built in. This circuit is designed to reduce the small modulation peaks, which have little power and are holding the average level down, and allow the larger and more powerful levels of the audio signal to modulate the transmitter at the maximum limit. Front panel controls include separate adjustments for both positive and negative peaks; a pushbutton for disabling and calibrating; and one pushbutton each to increase loudness by 1, 2 or 3 dB.

EASY TUNING. Tuning is similar to that of a conventional Class C amplifier. Just peak the "relative efficiency" meter on the front panel, using the grid and plate efficiency resonator controls.

EASY ACCESSIBILITY. Accessibility is quick and easy to all components—front, rear, inside and out. For instance, the oscillator, RF driver, PDM exciter and audio driver are all immediately available through swing down front panels. The two low voltage power supplies may be lifted out by removing four screws and a few wires. Front and rear doors remove in an instant for ease of maintenance.

The entire control circuit panel swings out, allowing relays to be easily cleaned. Also, meter panels lift up for quick access. Fault indicating devices and a spacious overall transmitter layout will also help the engineer isolate and repair problems in minimum time.

RF SECTION. The RF chain consists of two switchable crystals and oscillators, a buffer, divider, RF amplifier, IPA, RF driver, and PA. Only 15 transistors are used in the entire RF chain.

The crystals and oscillators, buffer, divider and RF amplifier are located on one printed circuit board. The divider is a single IC which is socket mounted for easy replacement. Indicating lamps on the PC board show if voltage is available

**. . . provides a louder, clearer signal than any
AM transmitter in its power range**

and if RF is being generated.

The IPA and RF driver are on a swing-down chassis, and consist of five identical Class D, push-pull amplifier modules. One module is used in the IPA and four modules are used in the RF driver. The four RF driver modules are connected so that if one should fail, the remaining three will provide adequate drive to keep the transmitter on the air at full power. Fault lamps indicate which one of the modules failed.

The PA is a Class C amplifier with third harmonic "efficiency" resonators, and the output network is a conventional Pi/L.

PROTECTIVE CIRCUITS. All major components of the MW-10 are protected by circuit breakers, which are easily resettable from the front panel.

Protection against voltage standing wave ratios of greater than 1.2 to 1 is provided. Both forward and reflected power are

metered at the front panel.

In case of momentary RF overloads, the MW-10 will recycle automatically. Should a repeated overload occur within a thirty-second period, the transmitter will remain off until manually reset. However, if the time between overloads is greater than thirty seconds, continuous recycling will occur.

Five resettable status/overload indicators are located on the meter panel. Remote readout and reset of these indicators are also provided to help the engineer determine if a trip to the transmitter site is required when the transmitter has recycled. For example, VSWR recycles (as determined at the remote control point) may be caused by lightning or icing of the transmission line. A switch to low power may be all that is necessary, and this can be accomplished by remote control.

QUIET AIR COOLING. A standard three-

quarter horsepower, single phase motor is used on a quiet, low-speed, belt-driven blower. Provisions are made on the top of the transmitter for ducting the exhaust air to the outside of the transmitter building.

GENERAL. An ovenless crystal oscillator is used in the MW-10. This allows all voltages to be removed from the transmitter during maintenance periods or power failures without having an off-frequency condition, due to a cold crystal, when the power is restored.

Lighted front panel pushbuttons indicate operation and power mode of the transmitter.

The MW-10 meets all performance specifications at altitudes up to 10,000 feet (3048 meters).

TRANSMITTER LAYOUT. The MW-10 is completely self-contained in one cabinet—there are no external components.

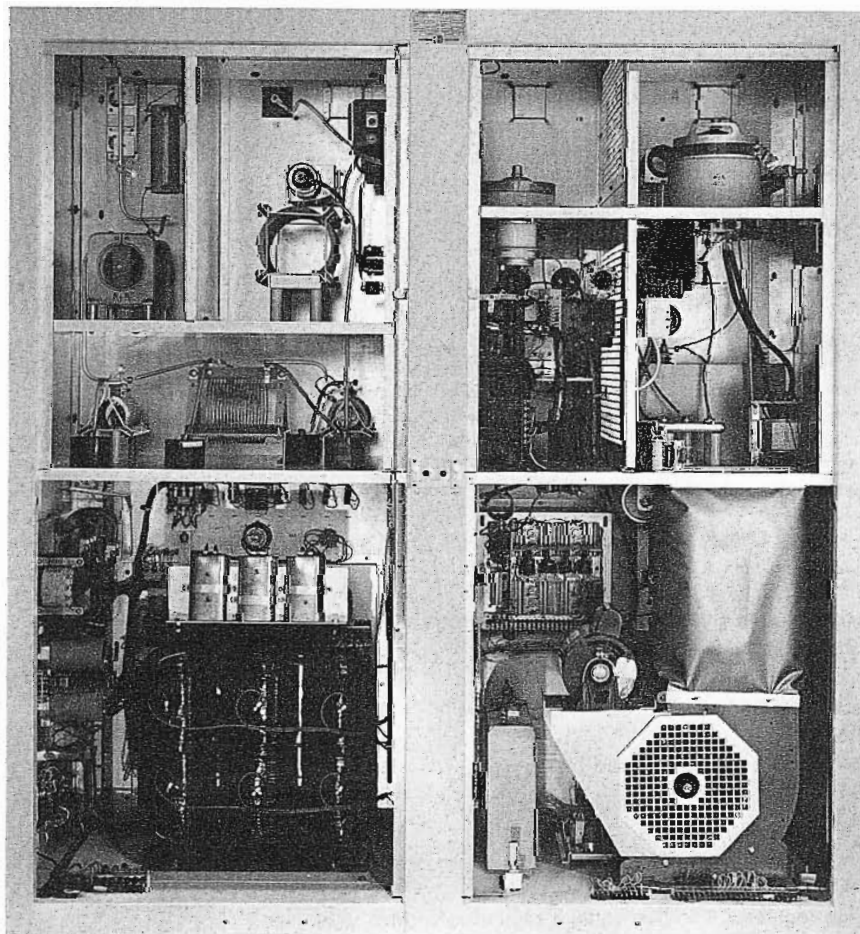

Rear view, doors removed—note clean layout and easy access to components.

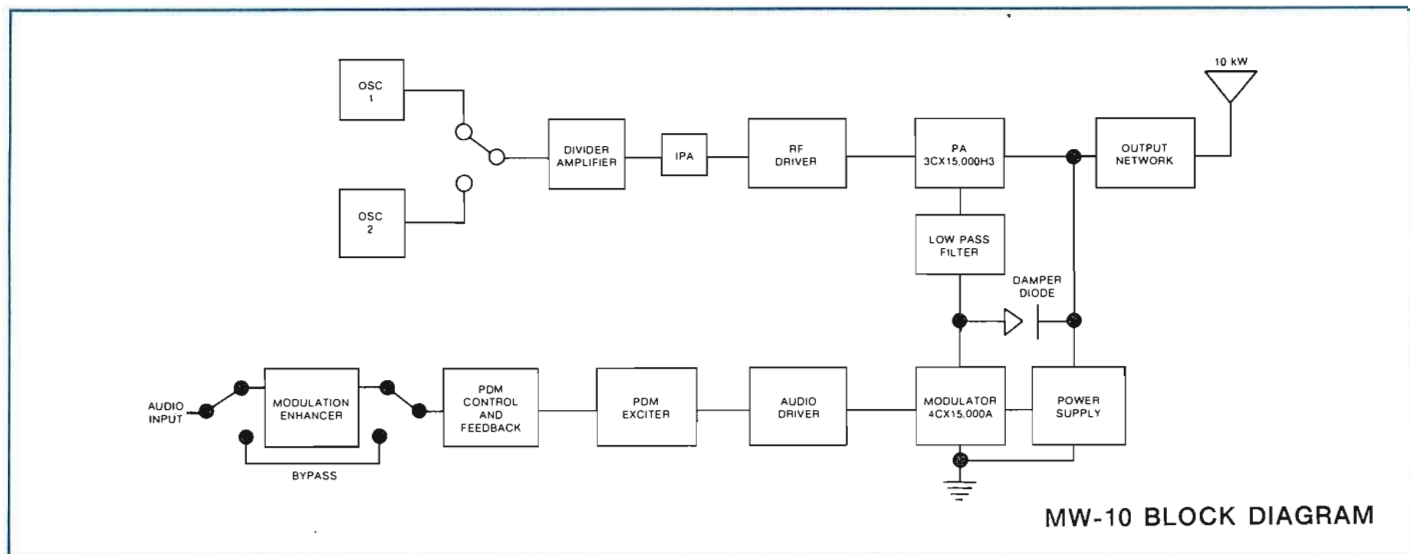

MW-10 BLOCK DIAGRAM

MW-10 SPECIFICATIONS

POWER OUTPUT: (Rated) 10,000 watts. (Capable) 11,000 watts. FCC type accepted at 10,000, 5000 and 2500 watts.

MODULATION METHOD: Pulse Duration Modulation.

CARRIER SHIFT: (@ 95% modulation with 400 Hz tone) 2% or less.

AUDIO INPUT: (For 95% modulation) +10 dBm, ± 2 dB, unenhanced. +16 dBm with enhancement activated.

AUDIO INPUT IMPEDANCE: 600 ohms balanced.

AUDIO FREQUENCY RESPONSE: ± 1 dB, 20 to 10,000 Hz. (Response referred to 1 kHz, 95% modulation, with modulations at other frequencies held to same percentage. Response may degrade at higher modulating frequencies if transmitter is operated into a bandwidth limited antenna system.)

THD DISTORTION: 2% or less @ 95% modulation, 20 to 10,000 Hz unenhanced.

RF HARMONICS: Meets or exceeds FCC and CCIR requirements.

SPURIOUS OUTPUT: -80 dB or better.

RF FREQUENCY RANGE: 535 to 1605 kHz. Supplied to one frequency as ordered.

RF OUTPUT IMPEDANCE: 50 ohms, unbalanced. Other output impedances available on special order.

RF OUTPUT CONNECTOR: 1 $\frac{1}{2}$ -inch male EIA flange. Other types of output connectors available on special order.

MAXIMUM VSWR: 1.3 to 1.

NOISE:² Unweighted, 60 dB below 100% modulation. Weighted (CCIR Rec. 468-1), 70 dB below 100% modulation.

POSITIVE PEAK CAPABILITY: 125% at 11 kW output, when modulated with processed program type material.

NEGATIVE PEAK CAPABILITY: 95%.

FREQUENCY STABILITY: ± 20 Hz or less over operating temperature range.

SUPPLY VOLTAGE: 200/500 volts, 3 phase, 60 Hz, closed delta or 350/430 volts, 3 phase, 50 Hz, 4 wire Wye.

LINE VOLTAGE REGULATION AND VARIATION: 5% maximum.

LINE VOLTAGE UNBALANCE:² 4% maximum.

POWER CONSUMPTION (10 kW Carrier):³ (Typical) 20.5 kW, 0% modulation; 22.1 kW, 50% tone modulation; 28.0 kW, 100% tone modulation. (Maximum) 22.1 kW, 0% modulation; 24.3 kW, 50% tone modulation; 30.8 kW, 100% tone modulation.

POWER FACTOR: 95% or better.

AMBIENT TEMPERATURE RANGE:⁴ -20° to $+50^{\circ}\text{C}$ (-4° to $+122^{\circ}\text{F}$) at sea level. Decreases 3.5° per 1,000 feet of altitude (84°F at 10,000 feet).

MAXIMUM RELATIVE HUMIDITY: 95%.

MAXIMUM ALTITUDE FOR FULL POWER RATING: 10,000 feet AMSL (3048 meters). Transmitters for operation above 10,000 feet AMSL require special order.

SIZE:⁵ 78" H \times 72" W \times 32" D (198 cm \times 183 cm \times 81.3 cm).

WEIGHT: Unpacked, 1500 lbs. (680.4 kg) - approximate. Domestic packed, 1900 lbs. (861.8 kg) - approximate. Export packed, 2150 lbs. (975.2 kg) - approximate.

CUBAGE: 120 cu. ft. (3.4 cu. meters) packed - approximate.

FINISH: Blue and white.

TUBES USED: (1) 3CX15,000H3 and (1) 4CX15,000A.

REMOTE CONTROL: Normal terminal board interface.

1. Distortion measured at 95% modulation, or less, down to 25%. If transmitter is operated into a bandwidth limited antenna system, distortion at the higher modulating frequencies may degrade.
2. Noise measured over the band 20 Hz to 20 kHz, with line to line voltages of the supply line balanced. Noise may degrade to 56 dB below 100% modulation with line voltage unbalance not exceeding 4%.
3. Typical power consumption figures are for 10 kilowatts output and for optimum transmitter adjustment. For higher output powers and/or transmitter misadjustments, power consumption may be higher.
4. Maximum operating temperature derates linearly to $+29^{\circ}\text{C}$ (84.2°F) at 10,000 feet AMSL (3048 meters).
5. Does not include height of output connector, which may be removed for transport.

SPECIFICATIONS SUBJECT TO CHANGE WITHOUT NOTICE.

ORDERING INFORMATION

MW-10 Transmitter with one set of operating tubes and two crystals, for 200-250 Volts or 350-430 Volts, 3 phase, 60 Hz operation 994-8301-001

MW-10 Transmitter with one set of operating tubes and two crystals, for 200-250 Volts or 350-430 Volts, 3 phase, 50 Hz operation 994-8301-003

Spare 3CX15,000H3 tube 374-0150-000

Spare 4CX15,000A tube 374-0097-000

Recommended spare semiconductor kit 990-0966-001

Low voltage and filament voltage regulator, and line voltage regulator for MW-10 available.



MW-5A

5000 Watt Medium Wave Broadcast Transmitter

- High level plate modulation, using a Pulse Duration Modulator (PDM)*
- Built-in audio processing circuit allows greater modulation density
- High overall efficiency—low power consumption
- 125% positive peak modulation capability at 5600 watts
- Excellent accessibility to all components
- Extremely quiet air-cooled operation, using a low-speed blower
- No modulation transformer or reactor
- Automatic return to full power after power failure
- All remote control accessories built in
- Power level is adjusted in low level PDM stage. No PA loading adjustment required

*Patented



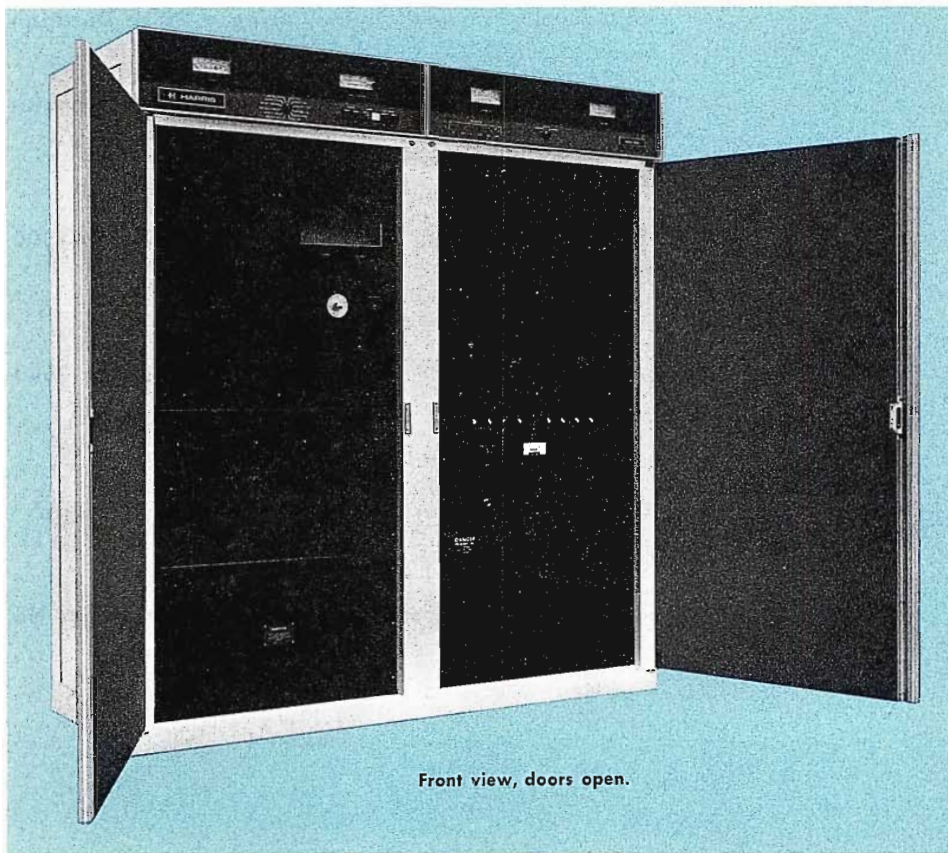

Front view, doors open.

Similar in design to its big brother, Harris' 50,000-watt MW-50A, the MW-5A provides an overall performance superior to other AM broadcast transmitters in the 5-kilowatt power range—at an unusually low operating cost. The MW-5A uses Harris' patented Pulse Duration Modulator (PDM) to obtain conventional high level plate modulation, and a built-in audio processing circuit to allow greater modulation density. Designed to handle the highly processed audio used in today's competitive market, the MW-5A provides low distortion, excellent transient response, wide frequency response, and high positive peak capability for the loudest, cleanest possible signal.

HIGH EFFICIENCY—EXCEEDS 52%. The Pulse Duration Modulator employed in the MW-5A is nearly 90% efficient (instead of the usual 50% or 60%), enabling the transmitter to achieve an unusually high overall efficiency of greater than 52%. This means less power consumption than other 5-kilowatt AM transmitters.

125% POSITIVE PEAK MODULATION CAPABILITY. The MW-5A is capable of providing the maximum positive modulation peaks allowed by the FCC (125%), with reserve for great reliability. This can mean higher average modulation levels for louder, clearer signals, with no increase in transmitter carrier power and no increase in distortion. A wide frequency range is possible, as large reactive components are not used in the modulation system.

AUDIO PROCESSING. In the MW-5A, an adjustable audio processing circuit is built in. This circuit is designed to reduce the small modulation peaks, which have little power and are holding the average level down, and allow the larger and more powerful levels of the audio signal to modulate the transmitter at the maximum limit. Front panel controls include separate adjustments for both positive and negative peaks; a pushbutton for disabling and calibrating; and one pushbutton each to increase loudness by 1, 2 or 3 dB.

ONLY TWO TUBES. The entire transmitter employs just two tubes—a 3CX2500F3 PA and a 4CX3000A modulator—both operating well below manufacturer's dissipation ratings. All power supplies use long-life solid-state silicon rectifiers. Highest quality components, conservatively rated, are used throughout the MW-5A to assure a maximum degree of reliability.

MAXIMUM CARRIER POWER 5600 WATTS. The Harris MW-5A provides a maximum carrier power of 5600 watts, which allows more reserve for driving directional arrays. The transmitter uses DC feedback for power output stability, which insures a minimum of RF power output change with a change of the power line voltage. This is especially important where brownouts occur, and where transmitters are only logged every three hours. The MW-5A provides for easy power reduction to one kilowatt—and power may be switched from high to low

with carrier on. The PA utilizes 3rd harmonic wave shaping for improved efficiency.

EASY TUNING. Tuning is similar to that for a conventional Class C amplifier. Just peak the "relative efficiency" meter on the front panel, using the grid and plate efficiency resonator controls, for proper tuning and maximum efficiency.

EASY ACCESSIBILITY. Accessibility is quick and easy to all components—front, rear, inside and out. For instance, the oscillator, RF driver, PDM exciter and audio driver are all immediately available through swing down front panels. The two low voltage power supplies may be lifted out by removing four screws and a few wires. Front and rear doors remove in an instant for ease of maintenance. The entire control circuit panel swings out, allowing relays to be easily cleaned. And meter panels lift up for quick access. Fault indicating devices and a spacious overall transmitter layout will also help the engineer isolate and repair problems in a minimum time.

RF SECTION. The RF chain consists of two switchable crystals and oscillators, a buffer, divider, RF amplifier, IPA, RF driver, and PA. Only 15 transistors are used in the entire RF chain.

The crystals and oscillators, buffer, divider and RF amplifier are located on one printed circuit board. The divider is a single IC which is socket mounted for easy replacement. Indicating lamps on the PC board show if voltage is available and if RF is being generated.

The IPA and RF driver are on a swing-down chassis, and consist of five identical Class D, push-pull amplifier modules. One module is used in the IPA and four modules are used in the RF driver. The four RF driver modules are connected so that if one should fail, the remaining three will provide adequate drive to keep the transmitter on the air at full power. Fault lamps indicate which one of the modules failed.

The PA is a standard Class C amplifier and the output network is a conventional Pi/L.

PROTECTIVE CIRCUITS. All major components of the MW-5A are protected by circuit breakers, which are easily resettable from the front panel.

Protection against voltage standing wave ratios of greater than 1.2 to 1.0 is provided. Both forward and reflected power are metered at the front panel.

In case of momentary RF overloads, the MW-5A will recycle automatically. Should a repeated overload occur within a thirty-second period, the transmitter will remain off until manually reset. However, if the time between overloads is greater than thirty seconds, continuous recycling will occur.

Five resettable status/overload indicators are located on the meter panel. Remote readout and reset of these indicators are also provided to help the engineer determine if a trip to the transmitter site is required when the transmitter has recycled. For example, VSWR recycles (as determined at the remote control point) may be caused by lightning or icing of the transmission line. A switch to low power may be all that is necessary, and can be accomplished by remote control.

QUIET AIR COOLING. A standard one-half horsepower, single phase motor is used on a quiet, low-speed, belt-driven blower. Provisions are made on the top of the transmitter for ducting the exhaust air to the outside of the transmitter building.

GENERAL. An ovenless crystal oscillator is used in the MW-5A, allowing all voltages to be removed from the transmitter during maintenance periods or power failures without having an off-frequency condition, due to a cold crystal, when the power is restored.

Lighted front panel pushbuttons indicate operation and power mode of the transmitter.

Operation of the MW-5A at 10,000 feet is certified by a recognized testing organization.

TRANSMITTER LAYOUT. The MW-5A is completely self-contained in one cabinet —there are no external components.

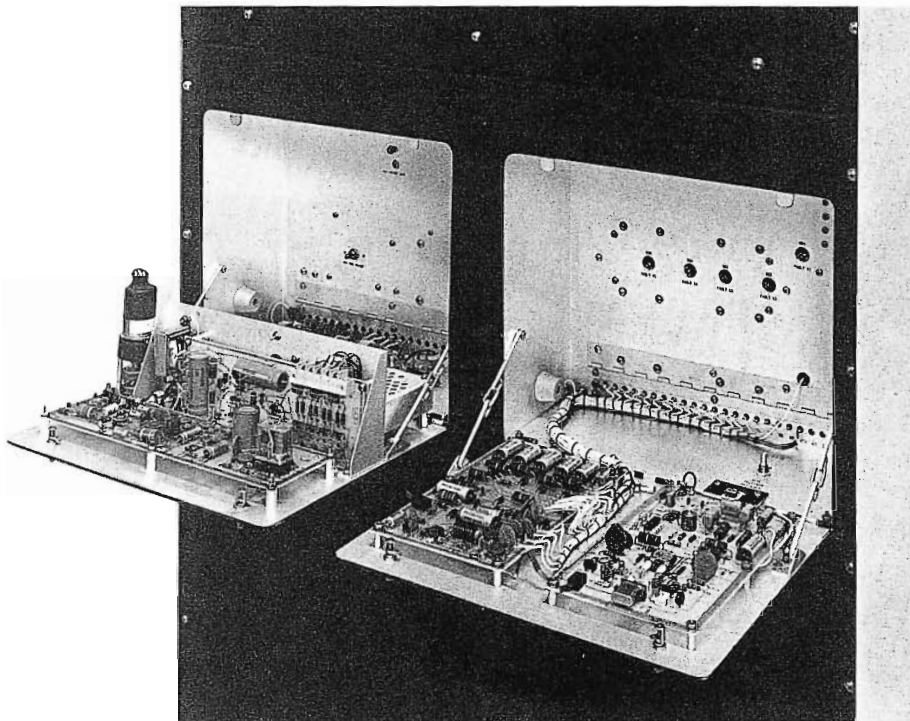

PDM and RF Driver Chassis swing down for easy access.

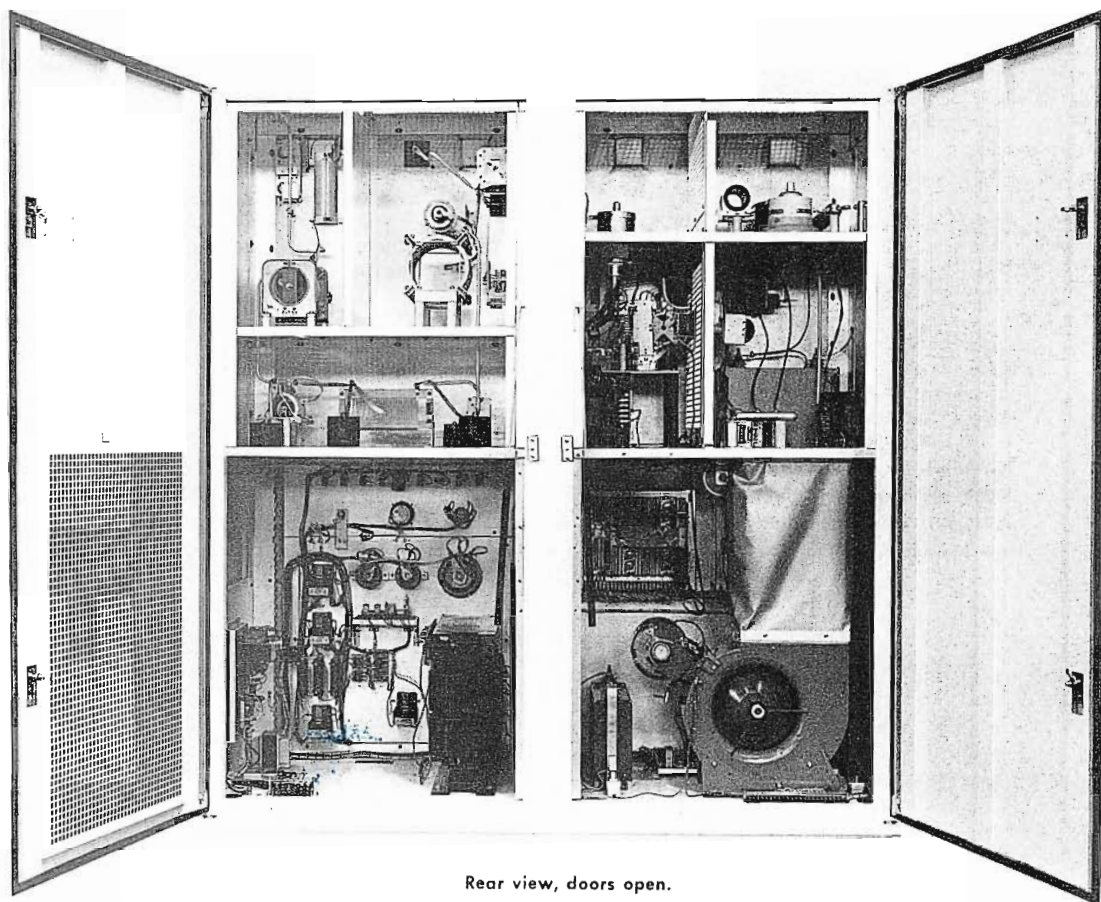

Rear view, doors open.

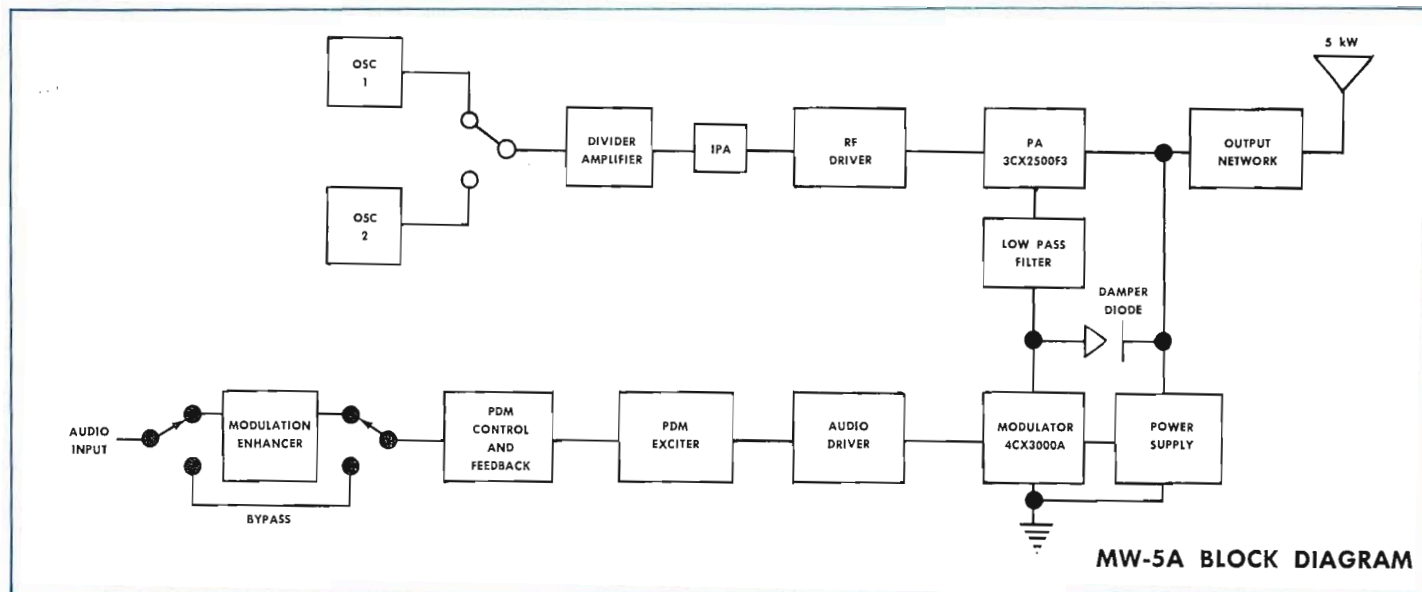

MW-5A BLOCK DIAGRAM

MW-5A SPECIFICATIONS

POWER OUTPUT: (Rated) 5000 watts. (Capable) 5600 watts. Type accepted at 5000, 2500, and 1000 watts. High and low power modes can be set between 1000 and 5600 watts.

RF FREQUENCY RANGE: 535 kHz to 1620 kHz. Supplied to one frequency as ordered.

RF OUTPUT IMPEDANCE: 50 ohms, unbalanced. 40 to 250 ohms available on special order.

CARRIER AMPLITUDE REGULATION: Less than 2% at 100% modulation.

AUDIO FREQUENCY RESPONSE: ± 1 dB, 20 to 10,000 Hz.

AUDIO FREQUENCY DISTORTION (Unenhanced): 2% or less 20 to 10,000 Hz at 95% modulation.

COMPRESSION RATIO: 4/1 dB at 3 dB of enhancement; -95%, +125% modulation.

NOISE (Unweighted): 60 dB or better below 100% modulation.

AUDIO INPUT: 600 ohms at +10 dBm, ± 2 dB, unenhanced; +16 dBm with enhancement activated.

POWER INPUT: 208/230 volts, 3 phase, 60 Hz and 208/230/380 volts, 3 phase, 50 Hz.

POWER CONSUMPTION: 9.5 kW at 0% modulation; 10.0 kW at 40% modulation; 13.0 kW at 100% modulation.

PLATE EFFICIENCY: 90% or better.

OVERALL EFFICIENCY: Better than 52%.

POWER FACTOR: 95%.

RF HARMONICS: Meets or exceeds FCC specifications.

SPIRIOUS OUTPUT: 80 dB or more below 5 kW output.

POSITIVE PEAK CAPABILITY: 125% positive peak modulation capability at 5 kW and at 5.6 kW output.

AMBIENT TEMPERATURE RANGE: -20°C to $+50^{\circ}\text{C}$.

ALTITUDE: Sea level to 3048 meters (10,000 feet).

SIZE: 78"H x 72"W x 32"D. (198.12cm x 182.88cm x 81.28cm.)

WEIGHT: Unpacked, 1200 lbs. (567 kg) — approximate. Domestic packed, 1600 lbs. (726 kg) — approximate. Export packed, 1850 lbs. (840 kg) — approximate.

CUBAGE: 120 cubic feet packed. (3.4 cubic meters.)

FINISH: Blue and white.

TUBES USED: (1) 3CX2500F3 and (1) 4CX3000A.

MONITOR PROVISIONS: 10 RF volts output at 50/70 ohms for frequency monitor. 10 RF volts output at 50/70 ohms for modulation monitor.

REMOTE CONTROL: Normal interface.

ORDERING INFORMATION

MW-5A Transmitter with one set of tubes and two crystals, for 208/230 volts, 3 phase, 60 Hz operation. [Specify high and low power desired]	994-7965-001
MW-5A Transmitter with one set of tubes and two crystals, for 208/230/380 volts, 3 phase, 50 Hz operation. [Specify high and low power desired]	994-7965-003
100% set spare tubes for MW-5A	990-0764-001
100% set spare transistors for MW-5A (diodes not included)	990-0765-001
100% set spare diodes (includes HV rectifiers, but no transistors)	990-7067-001
Low voltage and filament regulator, and line regulator for MW-5A available.	



HARRIS
COMMUNICATIONS AND
INFORMATION HANDLING

MW-1A

1000 Watt Medium Wave Broadcast Transmitter

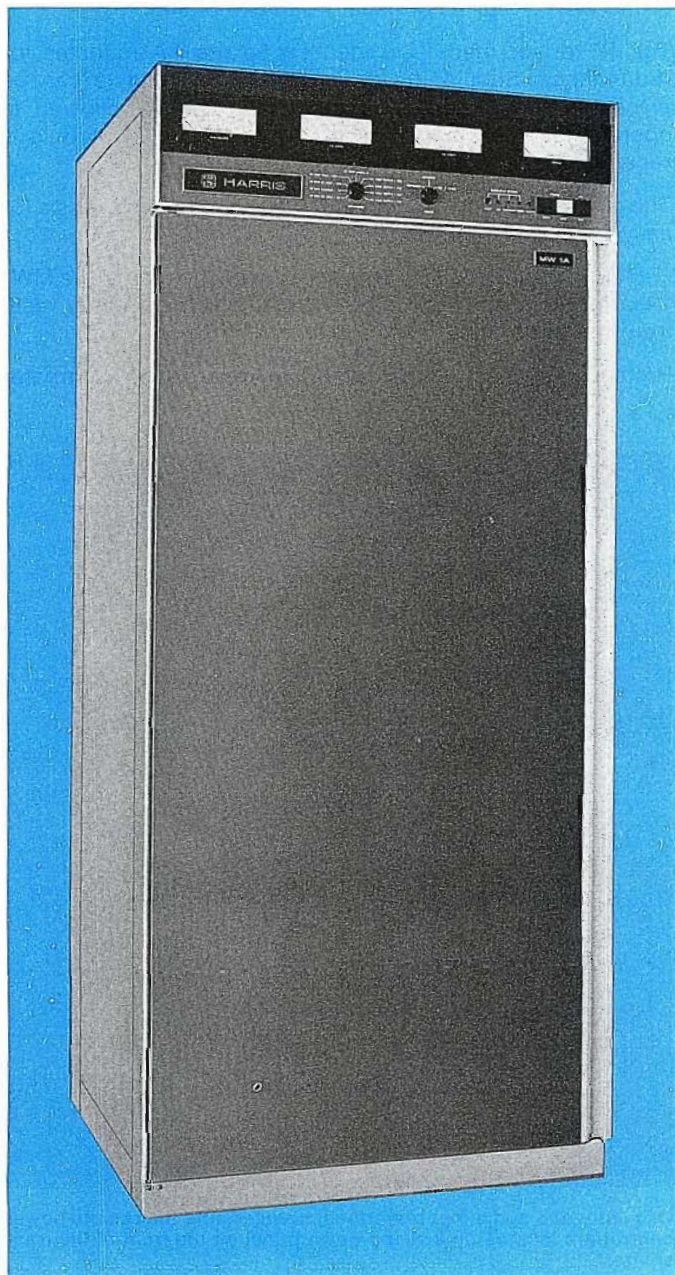

- 100% solid-state, including PA and modulator
- High level modulation, using a Progressive Series Modulator [PSM]*
- 125% positive peak modulation capability at 1100 watts
- Redundant power amplifier and modulator
- Automatic return to air after power failure
- DC feedback and voltage regulator are standard
- Carrier-on switching from high-to-low or low-to-high power, with no loss of programming
- No modulation transformer, modulation reactor or filter inductor
- Excellent transient response
- VSWR protection
- Extensive use of plug-in modules for easy maintenance
- High overall efficiency—low power consumption
- Status/overload indicators on front meter panel with remote readout and reset built in
- Instant "on"—no warmup time

*Patented

Harris' MW-1A is the most advanced one-kilowatt AM (medium wave) transmitter on the market today, offering such state-of-the-art features as total solid-state design, Progressive Series Modulator, and a built-in audio processing circuit to increase your modulation density. Designed to handle the highly processed audio used in today's competitive market, the MW-1A provides low distortion, excellent transient response, wide frequency response, and 125% positive peak capability for the loudest, cleanest signal available in this power range.

100% SOLID-STATE. Twelve transistorized power amplifier modules (which include modulators) are operated in parallel to provide 1100 watts output at 125% modulation. Failure of one module will not affect the transmitter's performance at the rated power output of 1000 watts. Even in the unlikely event that several modules should fail, the transmitter still stays on the air, although at a reduced power level. All other active devices in the MW-1A are also solid state.

POWER AMPLIFIER. The PA of each module consists of two transistors operating Class D push-pull (square wave switching mode). This method allows a typical efficiency of

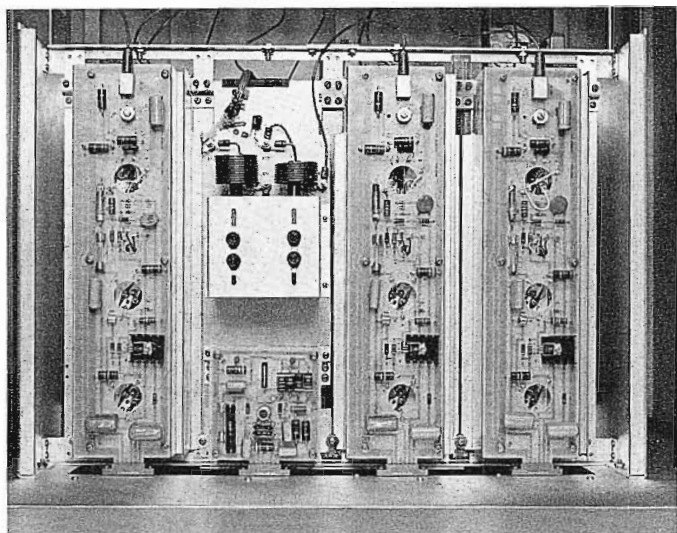

From left to right: one of the PA/Modulator modules, IPA module, RF Driver module, and another PA/Modulator module—all easily accessible from the front of the transmitter.

85% without the use of special shaping circuits used in tube designs. Each of the twelve PA modules is capable of at least 100 watts carrier and 500 watts peak, to provide full carrier power and modulation capability even with the failure of one modulator or PA.

PROGRESSIVE SERIES MODULATOR. The modulator used in the MW-1A is a simple series regulator, connected in such a way as to provide efficient high level modulation without the use of a modulation transformer, modulation reactor, power supply choke or 70 kHz filter. This eliminates components which have limited transmitter performance in the past. Control of the transmitter power over a wide range is accomplished in a low-level stage of the modulator by means of a convenient front panel vernier control. No adjustment is necessary in any high power RF circuit, including the loading coil.

125% POSITIVE PEAK MODULATION CAPABILITY. The MW-1A is capable of providing the maximum positive modulation peaks allowed by the FCC (125%). This can mean higher average modulation levels for louder, clearer signals, with no increase in transmitter carrier power...and an expansion of your listener coverage area!

AUDIO PROCESSING. In the MW-1A, an adjustable audio processing circuit is built-in. This circuit is designed to reduce the small modulation peaks, which have little power and are holding the average level down, and allow the larger and more powerful levels of the audio signal to modulate the transmitter at the maximum limit. Front panel controls include separate adjustments for both positive and negative peaks; a pushbutton for disabling and calibrating; and one pushbutton each to increase loudness by 1, 2 or 3 dB.

EASY TUNING. Tuning is as easy as that of a conventional Class C amplifier. Just dip the PA voltage, and load for the proper current. No grid or plate efficiency resonators are required for maximum efficiency.

MAXIMUM CARRIER POWER 1100 WATTS. The Harris MW-1A provides a maximum carrier power of 1100 watts, which allows more reserve for driving directional antenna arrays. The transmitter uses DC feedback and a power supply regulator for power output stability, which insures a minimum of RF power output change with a change of the power line voltage. This is especially important where brownouts occur, and where transmitters are only logged every three hours.

The MW-1A provides for easy power reduction to 500 or 250 watts—and power may be switched with carrier and program on!

EASY ACCESSIBILITY. Accessibility to all components is quick and easy through front and rear of transmitter. The following modules are plug-in design for easy maintenance: PA/modulator (12 modules), RF driver (identical to PA/modulator modules), IPA, oscillator, audio driver, and audio input and overload. The two low voltage power supplies may be lifted out by removing four screws and a few wires. Front and rear doors remove in an instant. The entire control circuit panel swings out allowing relays to be easily cleaned. And meter panels lift up for quick access.

Fault indicating devices and a spacious overall transmitter layout will also help the engineer isolate and repair problems in a minimum time.

RF SECTION. The RF chain consists of a crystal oscillator, divider, amplifier plug-in module, a plug-in IPA module, a plug-in RF driver module and 12 plug-in PA/modulator modules. Fault indicator lamps are located on the oscillator, IPA, and audio input and overload. Fault indicator lamps for the 12 PA modules are located at eye level on the front panel of the MW-1A for easy visual trouble-shooting.

The RF driver module is identical to the PA modules for redundancy. Should the driver fail, a PA module can be placed in the RF driver location, and the PA allowed to operate with one module short while the failed module is repaired at the engineer's convenience.

The oscillator module is located on a swing-down chassis for easy access.

PROTECTIVE CIRCUITS. The two power supplies of the MW-1A are protected by circuit breakers, which are easily reset from the front panel.

Protection against voltage standing wave ratios of greater

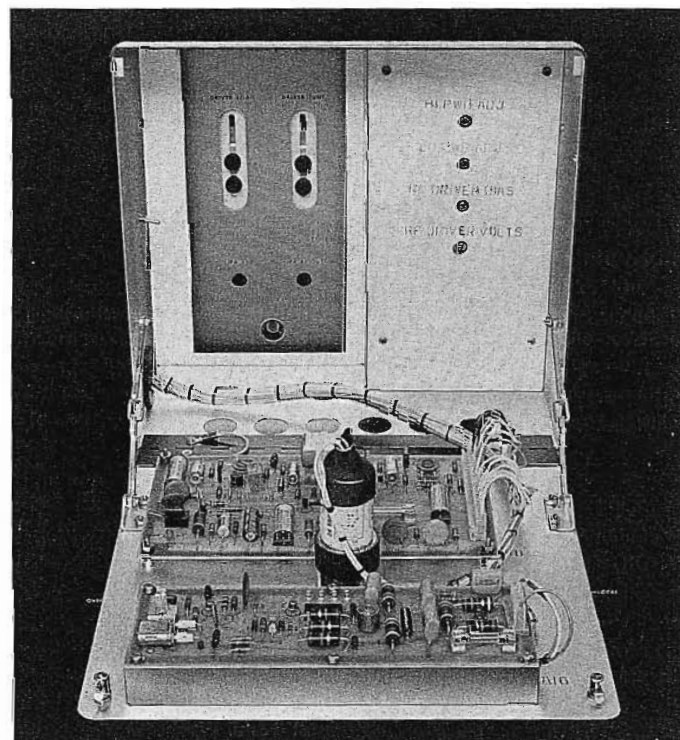

Oscillator and audio input/overload modules, and the remote power control are located on a swing-down panel on the front of the transmitter.

than 1.2 to 1.0 is provided. Both forward and reflected power are metered at the front panel.

In case of an overvoltage condition, the MW-1A will recycle automatically. Should a repeated overload occur within a thirty-second period, the transmitter will remain off until manually reset. However, if the time between overloads is greater than thirty seconds, continuous recycling will occur. VSWR overload will recycle continuously.

Resettable status/overload indicators are located on the meter panel. Remote readout and reset of these indicators are also provided to help the engineer determine if a trip to the transmitter site is required when the transmitter has recycled. For example, VSWR recycles (as determined at the remote control point) may be caused by lightning or icing of the transmission line. A switch to low power may be all that is necessary, and can be accomplished by remote control. Advanced circuit design provides lightning protection.

QUIET AIR COOLING. A single, small fan cools the entire transmitter. No noisy blower is required.

BUILT-IN DUMMY LOAD. The MW-1A may be tested at a full kilowatt output with 100% sine wave or full program modulation, using this built-in feature.

REMOTE CONTROL. All functions required for remote control are built in, including raise/lower power control, and PA voltage and current metering. A local/remote switch is provided on the control panel so the remote control point cannot turn the transmitter on while being operated locally. All electrical connections for remote control are brought out to a single terminal board.

GENERAL. Normally, no components are removed from the MW-1A for shipment—on delivery, just connect the main AC, audio input and the antenna to the transmitter, make a few adjustments and you are on the air!

An ovenless crystal oscillator is used in the MW-1A, allowing all voltages to be removed from the transmitter during maintenance periods or power failures without having an off-frequency condition, due to a cold crystal, when power is restored.

Lighted front panel pushbuttons indicate operation and power mode of the transmitter.

A large air filter at the rear of the MW-1A may be removed for cleaning while the transmitter is in operation.

The MW-1A is completely self-contained in one cabinet—there are no external components.

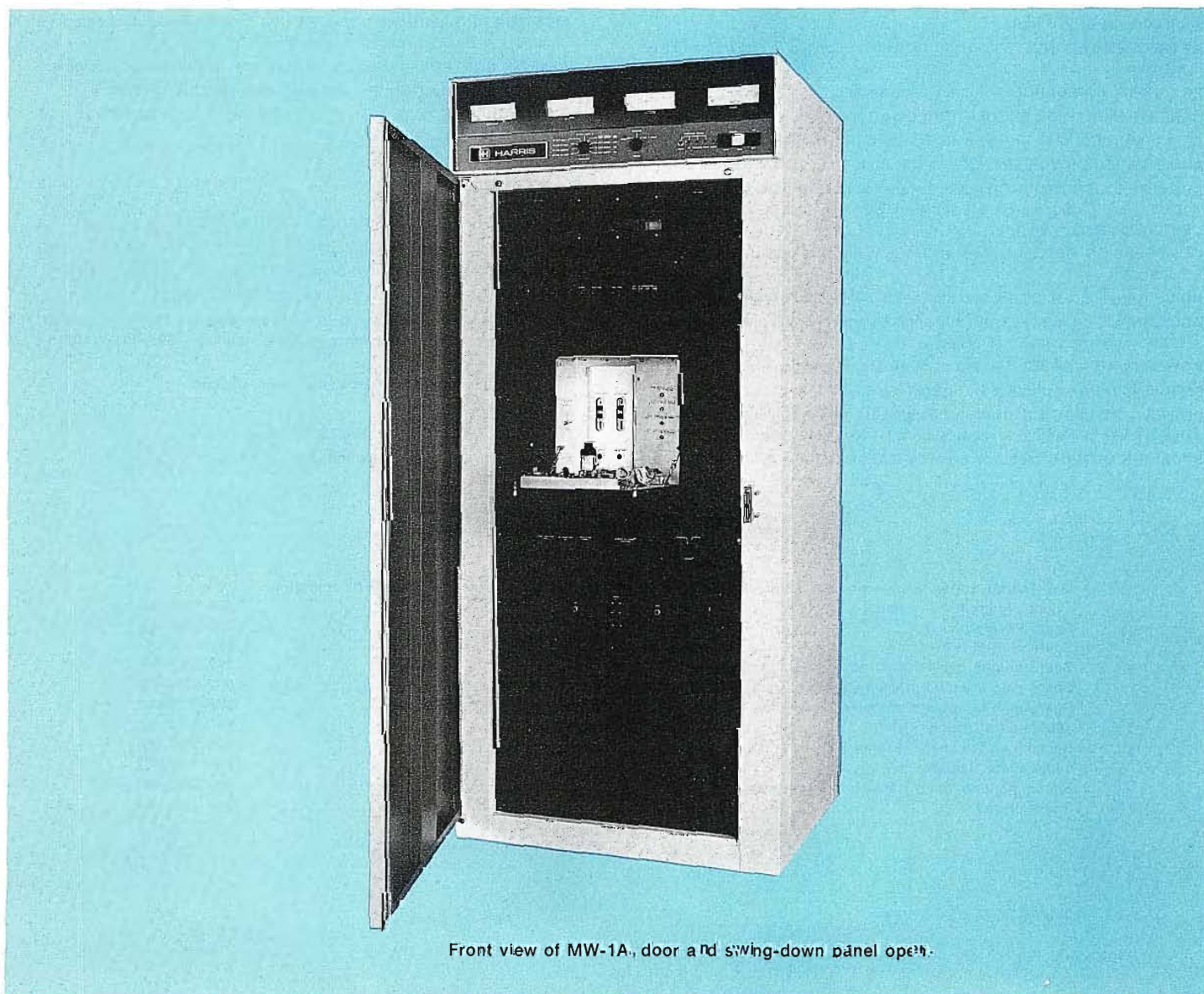

Front view of MW-1A, door and swing-down panel open.

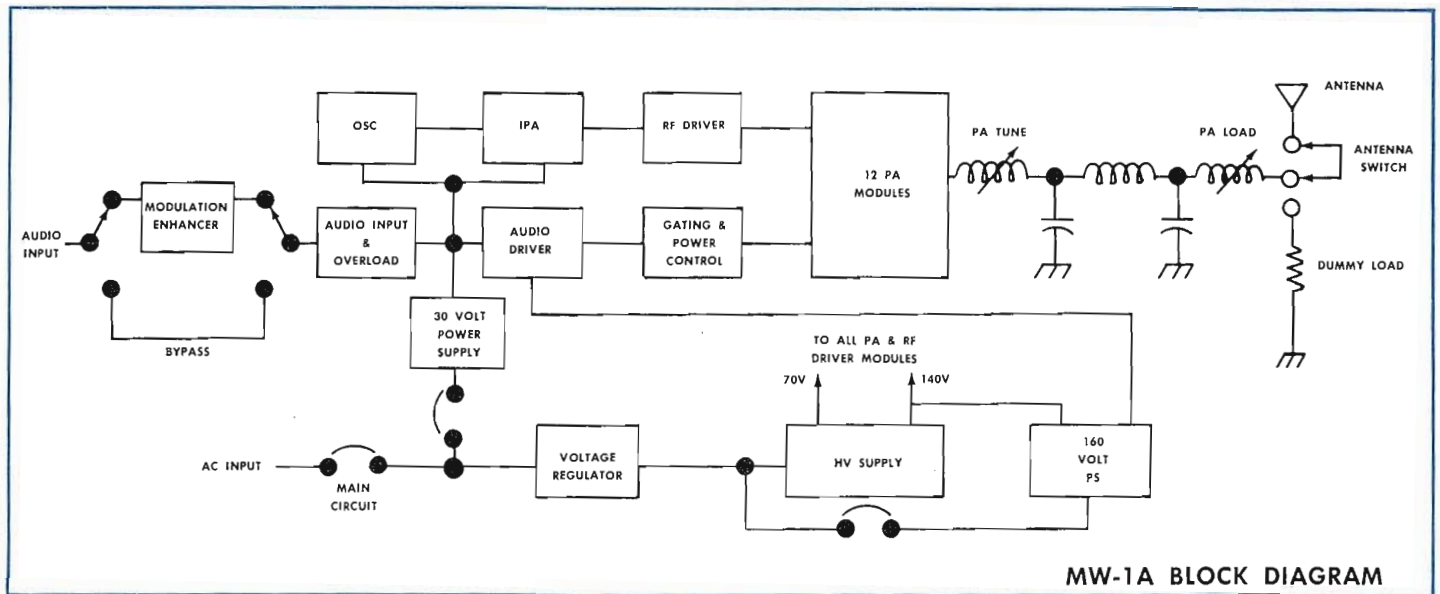

MW-1A BLOCK DIAGRAM

MW-1A SPECIFICATIONS

ELECTRICAL

POWER OUTPUT: (Rated) 1000 watts. (Capable) 1100 watts. Power reduction to 500 watts or 250 watts.

RF FREQUENCY RANGE: 535 kHz to 1620 kHz. Supplied to one frequency as ordered.

RF OUTPUT IMPEDANCE: 50 ohms, unbalanced.

CARRIER AMPLITUDE REGULATION: Less than 2% at 100% modulation.

RF HARMONICS: Meets or exceeds FCC and CCIR specifications.

AUDIO FREQUENCY RESPONSE: ± 1 dB, from 20 to 10,000 Hz.

AUDIO FREQUENCY DISTORTION (Unenhanced): 1.5% or less at 1 kW, 20 to 10,000 Hz, 95% modulation. 2% or less at 500 and 250 watts, 20 to 10,000 Hz, 95% modulation.

COMPRESSION RATIO: 4/1 dB at 3 dB of enhancement: -95%, +125% modulation.

NOISE (Unweighted): 60 dB or better below 100% modulation.

AUDIO INPUT: 10 dBm, ± 2 dB, 600 ohms balanced, unenhanced; +16 dBm, ± 2 dB with enhancement activated.

POWER INPUT: 208-260 VAC, 50 or 60 Hz, single phase.

EFFICIENCY: PA—typically 85%; overall transmitter—50% or greater.

POWER CONSUMPTION: (typical) 2.0 kW at 0% modulation at 1000 watts carrier. 3.0 kW at 100% tone modulation at 1000 watts carrier.

SPURIOUS OUTPUT: Meets or exceeds FCC and CCIR requirements.

POSITIVE PEAK CAPABILITY: 125% positive peak program modulation capability at 1.0 kW and at 1.1 kW.

MONITOR PROVISIONS: 10 volts RF (RMS) modulated output sample at 50 ohms and High/Low balance control.

REMOTE CONTROL: Self-contained interface for all standard systems.

TYPE OF MODULATION: Progressive Series Modulation (PSM).

IM DISTORTION: 2% or less 4/1 or 1/1, 60/2000 Hz or 60/7000 Hz.

MECHANICAL

AMBIENT TEMPERATURE RANGE: -20°C to +50°C.

AMBIENT HUMIDITY RANGE: 95%.

ALTITUDE: Sea level to 10,000 feet.

SIZE: 72"H x 31½"W x 31½"D. (183cm x 80cm x 80cm.)

WEIGHT: Unpacked, 595 lbs. (270 kg.)—approximate. Domestic packed, 785 lbs. (356 kg.)—approximate. Export packed, 895 lbs. (406 kg.)—approximate.

CUBAGE: 68.7 cubic feet (2 cubic meters), packed.

FINISH: Blue and white.

TYPE OF ACTIVE COMPONENTS: 100% solid state.

POWER SUPPLY: Self-contained, dry.

ORDERING INFORMATION

MW-1A transmitter, complete with all solid-state devices and one crystal, single phase, 60 Hz or 50 Hz operation [specify input AC voltage]	994-7966-001
Spare PA Module	992-4201-001
Spare plug-in IPA module	992-4202-001
Spare plug-in oscillator module	992-4207-001
Spare plug-in audio driver module	992-4206-001
Spare plug-in audio input/overload module	992-4205-001
100% spare rectifier kit	990-0810-001
Recommended spare rectifier kit	990-0807-001
100% spare transistor kit	990-0811-001
Recommended spare transistor kit	990-0812-001
Spare crystal	444-xxxx-000



HARRIS
COMMUNICATION AND
INFORMATION PROCESSING

MEDIUM WAVE ANTENNA PHASING EQUIPMENT AND ACCESSORIES

- Network design experience and capability that are recognized and accepted throughout the industry
- Highest construction standards in the industry
- Highest quality long-life components with conservative ratings to maximize reliability
- Wide network adjustment range for easy tune-up
- Modern control circuitry provides full transmitter and RF contactor protection, direct remote control interface
- Highest quality design and construction at affordable prices

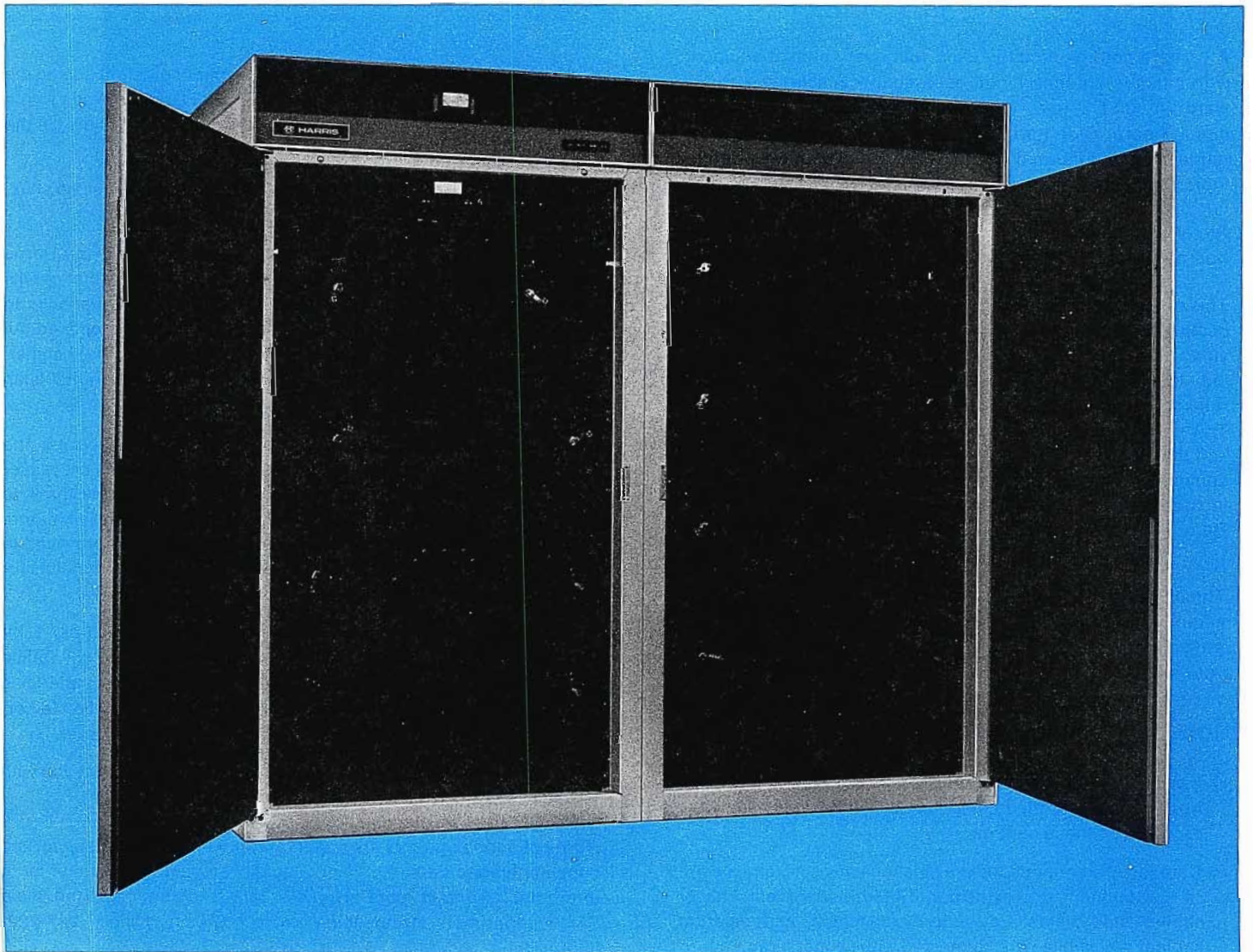

HARRIS' CUSTOMIZED MEDIUM WAVE PHASING AND

Harris phasors and medium wave antenna networks are custom built to the highest standards in the industry. Our network design experience is well known throughout the broadcast community. From 250 watts to 200 kilowatts, Harris phasors and medium wave antenna networks are in use around the world. Superior design and construction techniques, and the use of quality components are providing customers years of stable and reliable performance.

The key to our phasor capability is our highly experienced antenna design engineering staff, which is available to tailor networks for your specific requirements. Recognized as experts in the medium wave antenna field, Harris engineers' field experience gives them the perspective to understand the problems associated with installation and adjustment of medium wave antenna networks.

Innovative network designs for special requirements such as distortion reduction and broadband compensation can be provided. Computer design techniques aid in providing an optimum component configuration for your station. Experienced technicians assemble and test each phasor and antenna unit to assure a quality product. Many of the design and construction practices are unique to Harris and are not found in competitive units.

A modern control circuit is used with every phasor equipped with multiple antenna mode operation. A simple, straightforward 24-volt DC relay logic circuit is housed on one printed circuit board. Clean printed circuit board construction eliminates problems normally associated with hand wired control logic panels, thus improving reliability.

All relays, components, and terminal strips on the control logic board are permanently labeled for quick and easy reference.

This modern control circuit includes features not found in many competitive phasor designs. For example, a time delay is provided for RF to be completely removed before contactor switching - thus avoiding burned contacts. An automatic high voltage restart command is given to the transmitter after pattern switch. This eliminates a manual operator step and reduces annoying "off the air" pattern switch time to one second. Remote control commands are momentary, low current contact closures enabling direct connection to most remote control and ATS systems. Remote mode status indication is also provided for station use.

These Harris control circuit features will extend component life, minimize listener annoyance, and eliminate remote control and transmitter interface equipment. This means direct savings to your station.

COMPARE THESE CONSTRUCTION FEATURES

- Easily operated cyclometers with counter dials are used on front panel controlled components. Positive stop action is provided on these controls.
- Cabinet interconnections are mechanically solid and electrically continuous to provide a well integrated system. Phasor cabinet side plates are made of aluminum, and separate cabinet assemblies are connected with copper strap.

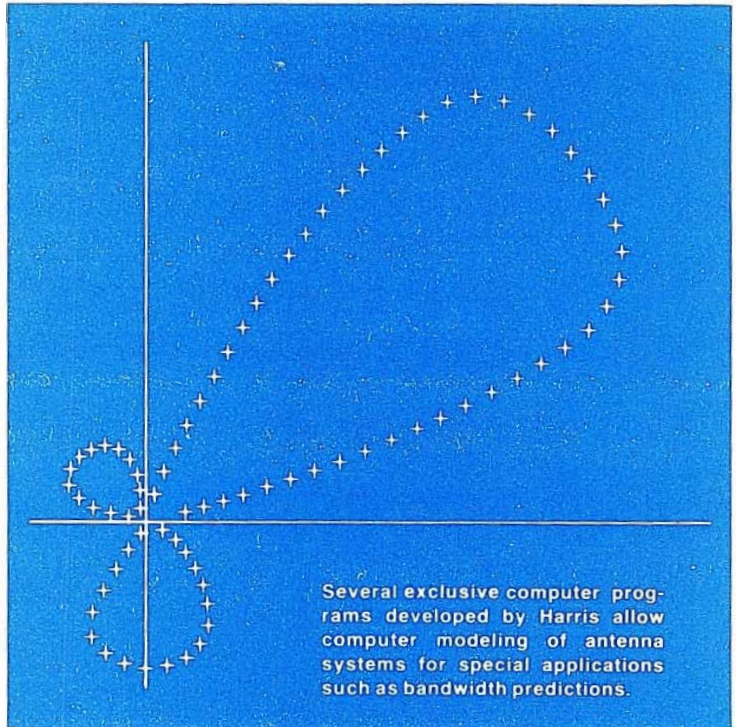

- All tubing coils are connected to other components with tubing the same size as that used in the coil. Parallel tapping straps with a minimum of excess length are used. These features minimize the risk of arcing or overheating.
- Permanent stencilling is used to identify components and no stick on labels are placed across capacitor insulation.
- The phasor cabinets can be matched to the styling of your Harris transmitter. Optional front and rear doors and hinged meter panels are available. All cabinet doors are equipped with interlocks to remove power from the equipment when the doors are opened. All phasor components are removable from inside the cabinet, facilitating quick servicing. Thus, cabinets may be mounted flush against a sidewall to conserve space.
- Test jacks are provided at all phasor input and output ports and ACU input locations. Thermocouple ammeter switches are make-before-break with a compensating loop and are double throw to completely remove the meter from the circuit. Toroidal ammeters are also available. Other switches are available with provision to accept plug-in meters and to provide "cold" attachment points for operating bridge measurements without loss of air time.
- All insulators are chosen to provide at least one inch per 5 kV separation to ground. All coils are spaced at least one coil radius from walls to minimize induced wall currents. Insulator material is selected on the basis of dielectric strength and dissipation factor, so that RF voltage gradients will not overstress the material.
- Harris maintains a 24-hour Service Department to assist you with your emergency parts requirements.

Harris phasor engineers are eager to work with station personnel and consulting engineers to provide a quality antenna system. For more information, contact your Harris sales representative or call the Radio Sales Department at our home office in Quincy, Illinois (217-222-8200).

ANTENNA NETWORKS...SUPERIOR DESIGN TECHNIQUES

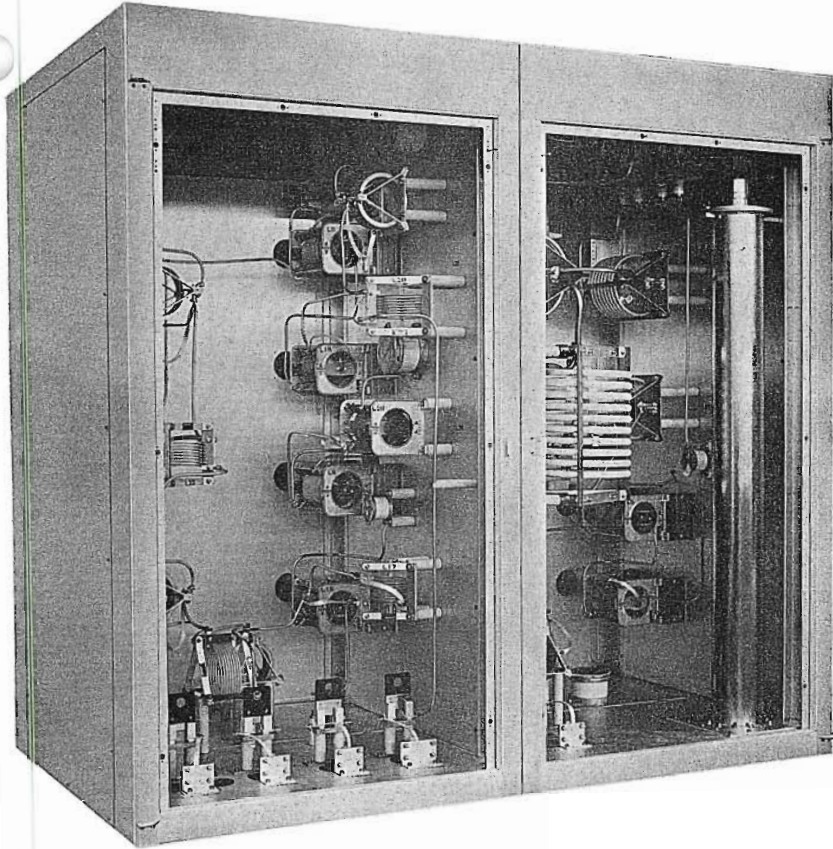

A close look at Harris' phasor construction reveals many important features that add not only to the reliability, but to the convenience of setup and maintenance.

Harris has been manufacturing custom medium wave antenna networks for over 25 years. This experience and outstanding craftsmanship guarantees many years of reliable service.

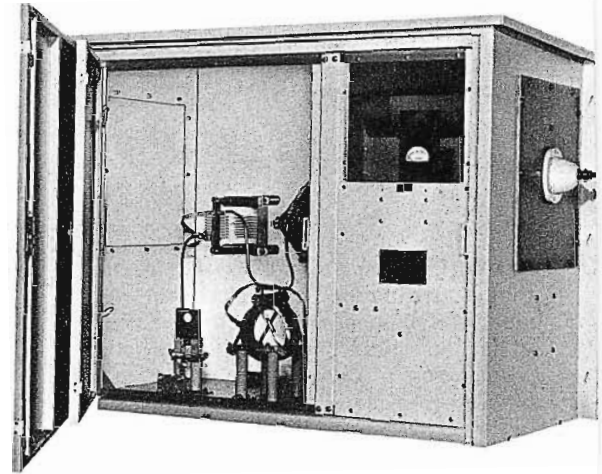

Antenna Coupling Unit networks can be housed in rugged all aluminum weatherproof enclosures as shown, or on flat aluminum panels for mounting in existing tower buildings.

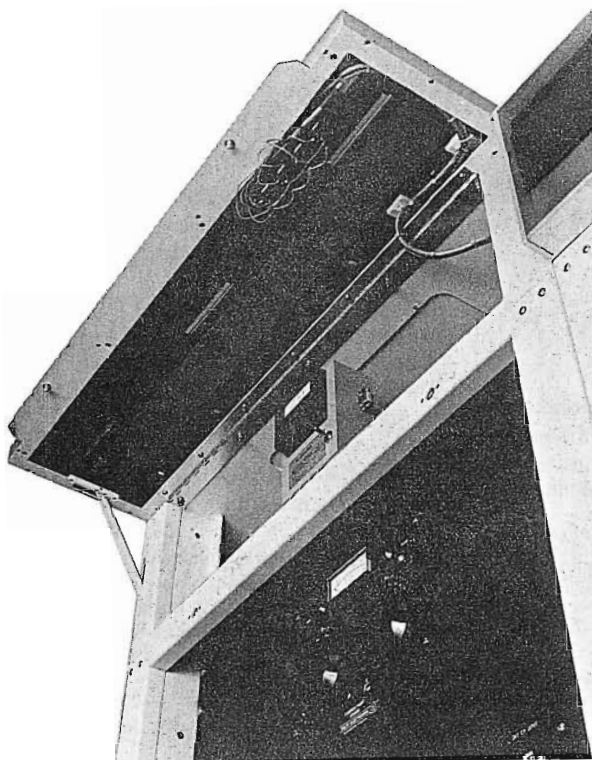

The optional custom phasor cabinet shown here includes hinged front panels for common point meter access.

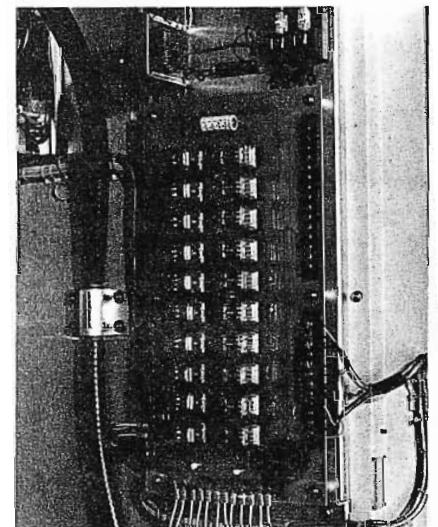

A simple, yet modern control logic board provides several key features for stations with multiple antenna modes.

AM ANTENNA COUPLERS AND ACCESSORIES

WEATHERPROOF 5-10 KW ANTENNA COUPLING UNITS

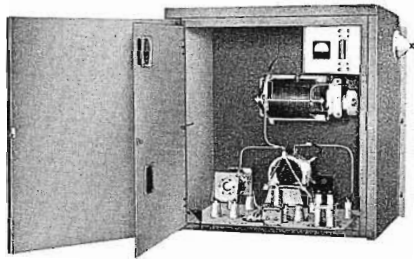

Housed in aluminum cabinet with double front doors. Large coils combined with capacitors of generous voltage and current ratings to assure a lifetime of service under extreme heat or cold. A large antenna lead in bowl is provided. Mounting is with metal flanges on the back of the tuning unit for attachment to wooden poles set in ground or for mounting on wall.

SPECIFICATIONS

CARRIER POWER: 5,000 watts or 10,000 watts AM, as ordered.

FREQUENCY: 525-1,700 kHz as ordered.

LINE IMPEDANCE: 50 ohms

TO MATCH: Series fed tower of from 70° to 100° electrical length.

CIRCUIT: Full Tee Network.

WEIGHT: Approximately 200 lbs.

SIZE: 38" high, 37" wide, 21½" deep.

ORDERING INFORMATION

Antenna Coupling Unit, 5 kW994-5309-001

Antenna Coupling Unit, 10 kW . . .994-5309-002

NOTE: When ordering, state carrier frequency, transmission line impedance, power, tower height and tower measurements, if known. Couplers to match unusual loads such as short or tall towers, shunt feed, etc., are available on special order, at extra cost.

RF ANTENNA METERS

Internal thermocouple standard scale. Weston Model 308, three-inch square case. Other ranges not listed below are available with many carried in stock. Also expanded scale meters in inventory.

ORDERING INFORMATION

Meter, 0-3 R.F. amperes634-0206-000

Meter, 0-6 R.F. amperes634-0238-000

Meter, 0-8 R.F. amperes634-0209-000

Meter, 0-10 R.F. amperes634-0210-000

TEST JACKS



Harris manufactures both a medium power and high power RF test jack for use in several medium wave antenna network applications. The medium power test jack (shown at left) is rated for 35 amperes while the high power version (shown at right) is rated for 100 amperes. These units are constructed to assure maintenance free operation.

ORDERING INFORMATION

Medium Power Test Jack994-3280-002

High Power Test Jack994-3280-003

METER SHORTING SWITCH

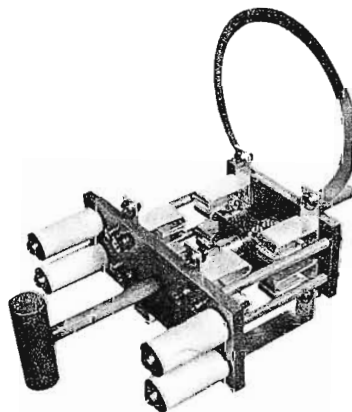

A heavy duty, make-before-break meter shorting switch of the plunger or push type. Heavy bronze tempered spring grips on both sides assure accuracy and durability.

ORDERING INFORMATION

Meter Shorting Switch, rating 15 amperes994-3493-001

Meter Shorting Switch, rating 40 amperes (shown above)994-6527-001

WEATHERPROOF SERIES—FED ANTENNA COUPLER, 1250 WATTS

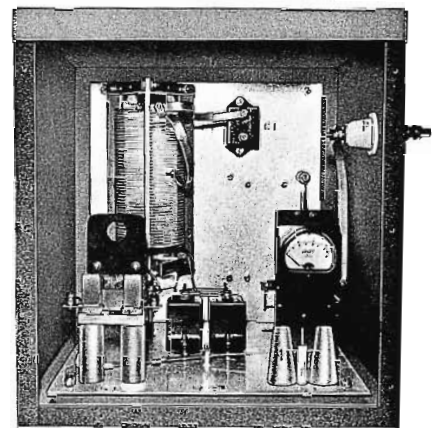

Recommended for broadcast transmitter powers of 1,000, 500 and 250 watts, 100% modulated. Heavy edgewound coil has generous inductance for a Tee network along with fixed mica capacitors supplied. Extra room is provided to install either diode or thermocouple remote metering equipment. Heavy duty meter shorting switch eliminates antenna meter from the circuit when not in use for lightning protection. Meter is observed through plexiglass porthole. Front door of cabinet has been removed for illustrative purposes.

SPECIFICATIONS

CARRIER POWER: Up to 1250 watts AM.

FREQUENCY: 525-1700 kHz as ordered.

LINE IMPEDANCE: 50 ohms.

TO MATCH: Series-fed tower of from 70° to 100° electrical length.

CIRCUIT: Full Tee Network.

WEIGHT: 98 lbs.

SIZE: 20" high, 20¼" wide, 18¾" deep.

ORDERING INFORMATION

Antenna Coupler with antenna meter994-3494-001

NOTE: When ordering, state transmission line impedance, frequency, tower height, and tower measurements, if known. Couplers to match unusual loads such as short or tall towers, shunt feed, etc., are available on special order at extra cost.

ADDITIONAL MEDIUM WAVE ANTENNA ACCESSORIES

TOWER LIGHT ISOLATION CHOKES

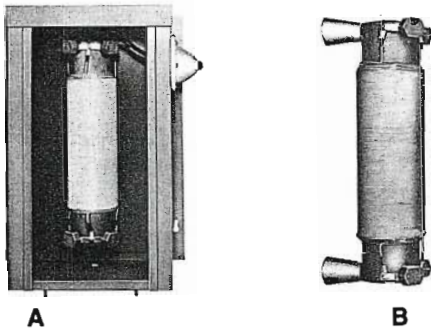

(20 AMP AC RATING)

Most popular of all tower light isolation chokes. Available in 2 or 3 wire models and in open type, or weatherproof as illustrated. Wound on heavy triple X tubing with mica-by-pass condensers on each circuit end. Inductance approximately 350 uH. 3" stand-off insulators are part of coil. (Weatherproof type), 24" high, 17 $\frac{3}{4}$ " wide, 10 $\frac{1}{4}$ " deep. Illustration on left shows weatherproof unit with front cover removed.

ORDERING INFORMATION

Tower Choke, 2 wire, weatherproof,
Fig. A994-3937-001
Tower Choke, 3 wire, weatherproof,
Fig. A994-3938-001
Tower Choke, 2 wire, open type,
Fig. B994-3935-001
Tower Choke, 3 wire, open type,
Fig. B994-3936-001

FEED-THRU BOWLS

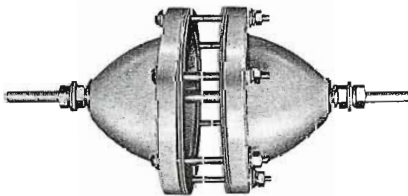

FEED-THRU BOWL ASSEMBLY

A large feed-thru bowl with 50 kW modulated rating. Available in single and double units and with solid or hollow studs as listed below. Bowls are Alsimag. Hardware, heavy brass. Velutex seals are provided for weathertight installation.

ORDERING INFORMATION

Solid stud, 2 bowls, for walls
to 10 $\frac{1}{2}$ " thick994-2870-001
Same as above but hollow stud ..994-3254-001
Solid stud, single bowl, for
walls 1" thick994-5280-001
Same as above but hollow stud ..994-5281-001

RF CONTACTORS

Harris offers a complete line of RF contactors of both the mechanical and vacuum variety.

The popular mechanical contactors, that handle a wide range of medium wave antenna applications, are available from stock.

DIODE TYPE REMOTE METER EQUIPMENT



For remote indication of RF current. Consists of a carefully constructed pickup loop attached through a short coaxial cable to a solid-state rectifier assembly. RF current is measured without breaking the main lead. No AC power is required. May be used with any good 1 MA DC meter. Power range: 250 watts to 50,000 watts. Frequency range: 540 kHz to 1600 kHz.

ORDERING INFORMATION

Diode remote meter unit,
less meter994-6112-001
0-1 MA METERS
Meter 3" sq. case,
scale 0-3 R.F. amperes632-0418-000
Meter 3" sq. case,
scale 0-6 R.F. amperes632-0405-000
Meter 3" sq. case,
scale 0-8 R.F. amperes632-0420-000
Meter 3" sq. case,
scale 0-10 R.F. amperes632-0421-000
Meter 4" sq. case,
scale 0-3 R.F. amperes632-0424-000
Meter 4" sq. case,
scale 0-8 R.F. amperes632-0426-000
Meter 4" sq. case,
scale 0-10 R.F. amperes632-0361-000
Meter 4" sq. case,
scale 0-15 R.F. amperes632-0428-000
NOTE: Other meter scale ranges available at extra cost. Above for use with diode remote unit, not thermocouple.

HEAVY DUTY SAMPLING LOOP

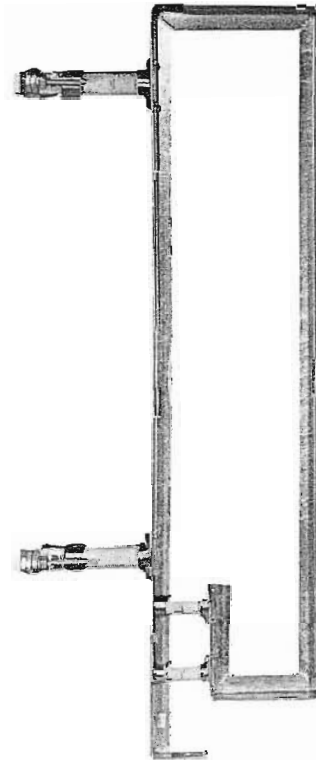

This is a very rugged fixed non-shielded RF sampling loop. It is heavily galvanized after welding, and is fitted with large steatite insulators and heavy duty tower leg clamps for easy and positive mounting. Complete with type female "N" jack. For 50 to 70 ohm sampling line.

ORDERING INFORMATION

Heavy duty sampling loop994-6126-001

ISOLATION COILS

Harris manufactures several types of sampling loop isolation coils to meet the needs of the directional array and associated monitoring system.

Standard units available use either $\frac{1}{2}$ inch or $\frac{3}{8}$ inch phase stabilized foam transmission line. The isolation coils are available with an optional resonating capacitor. The unit can be mounted on a flat aluminum wall panel or housed in a weatherproof enclosure.

OPEN WIRE TRANSMISSION LINE ACCESSORIES

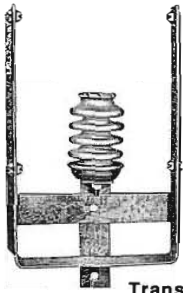

Transmission Line Bracket

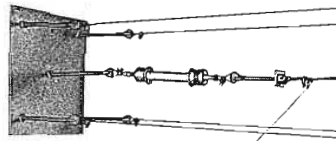

Line End Plate

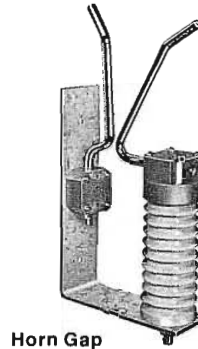

Horn Gap



Center Post Assembly

TRANSMISSION LINE BRACKET. For 5 or 6 wire transmission line. Rating up to 150 kW modulated. Made of 1/4" steel 3" wide with welded L section on each side to fully prevent twisting under ice or wind load. Supplied with 8 1/4" ribbed insulator, wire guides and all hardware. Galvanized throughout.

Line Bracket994-3327-001

LINE END PLATE. To terminate the open wire line at each end. Plate is 1/4" thick, 20" square. Fully galvanized. Includes turn-buckles, 25 1/2" strain insulator and all hardware. Rating up to 150 kW modulated.

End Plate994-3328-001

HORN GAP. A very desirable item where higher power is employed. Connects to hot side of line and ground to drain off lightning and heavy static discharges. Usually one is employed for each 200 feet of line. Insulator for 150 kW. Arc gaps heavy chrome plate. Galvanized throughout.

Horn Gap994-3322-001

CENTER POST ASSEMBLY. Has variety of uses such as end or corner angling of transmission line, support insulator for two wire line or rhombic antennas, and a guide insulator such as end of building or coupling unit. Rating 150 kW. Galvanized throughout.

Center Post Insulator994-3864-001

MODEL OIB-1 Operating Impedance Bridge



The Delta Model OIB-1 Operating Impedance Bridge measures the operating impedance of the individual radiators, networks, transmission line sections and common point of directional antennas while they are functioning under normal power. The OIB-1 has a frequency range of 500 kHz to 5 MHz, with a power rating up to 10 kW. Several optional accessories are available for the OIB-1.

Basic OIB-1700-0063-000

MODELS CPB-1/CPB-1A Common Point Impedance Bridges

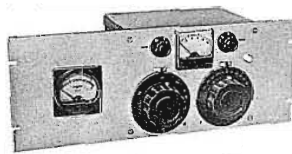

The Delta Models CPB-1 or CPB-1A Common Point Impedance Bridges can be custom installed in your Harris phasor or sold separately. The CPB-1 will handle common point powers up to 5 kW with 100% modulation on a continuous basis, while the CPB-1A is designed for 50 kW operation. Both instruments have two 4-inch dials calibrated directly in resistance and reactance. A front panel meter provides a null condition.

CPB-1700-0055-000

CPB-1A700-0056-000

MODELS TCA/TCA-XM RF Ammeter Systems

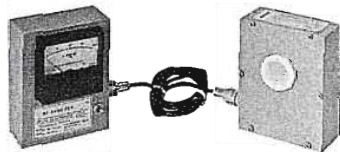

The Delta Models TCA and TCA-XM are radio frequency current measuring instruments designed for broadcast antenna systems. These instruments are intended for applications where conventional thermocouples have been used in the past. The units meet the FCC's requirement of 2% accuracy and are calibrated at RF frequencies to insure application accuracy. These units can be incorporated into your custom Harris antenna network or sold separately. Contact us for the various models and configurations available.

Specifications subject to change without notice.



AM-80

Medium Wave Modulation Monitor

Harris' AM-80 medium wave modulation monitor is an FCC type-accepted solid-state instrument designed to meet or exceed all requirements for measuring modulation percentages of broadcast stations in the frequency ranges 540 kHz to 1600 kHz. It will provide the accurate and dependable monitoring required by the FCC, and is suitable for proof-of-performance measurements.

METERS. There are two meters on the front of the AM-80. The Carrier Meter provides a continuous indication of the RF carrier amplitude. The % of Modulation Meter provides continuous indication of the modulation percentage on the RF carrier. Two Flasher Lamps are provided to indicate both positive and negative peaks when the percent of modulation exceeds the pre-set levels.

AUDIO OUTPUTS. Proof-of-performance measurements can be taken from the monitor's high-fidelity output with absolute assurance that readings of transmitter performance are accurate. A 600-ohm audio output is also provided to supply aural monitoring in the control rooms.

REMOTE OPERATION: Modulation readings by meter and flashers at a distant location are obtainable with a Harris optional remote meter panel. Three separate output circuits provide (1) a ballistically correct signal for a remote meter with a total loop resistance of 5,000 ohms or less, (2) a remote negative peak flasher and (3) a remote positive peak flasher.

TRANSIENT PROTECTION. A special limiter is provided for use on the RF input to clip transients which may damage the input diodes.

SPECIFICATIONS

FREQUENCY RANGE: 540 kHz to 1600 kHz.

Available to 30 MHz on special order.

RF INPUT: For 50-ohm line at 6 to 20 volts.

POWER SOURCE: 105-125/210-250 volts, 50/60 Hz, 10 watts.

MODULATION INDICATION

METER: 0% to 100% on negative peaks.

0% to 130% on positive peaks.

NEGATIVE FLASHER: 50% to 100% on negative peaks, continuously adjustable.

POSITIVE FLASHER: 50%, 90%, 95%, 100%, 105%, 110%, 115%, 120%, 125%, 130% and off.

ACCURACY: Meter is $\pm 2\%$ of full scale at 1,000 Hz. Flashers are $\pm 2\%$ at 1,000 Hz.

AUDIO MONITOR OUTPUT

FREQUENCY RESPONSE: ± 0.5 dB from 20 Hz to 20 kHz.

DISTORTION: Less than 0.3% with 600-ohm load at 100% modulation.

OUTPUT VOLTAGE: At 100% modulation, output is 0.55 volts into a 600-ohm load, approximately -10 dBm average.

OUTPUT IMPEDANCE: 600 ohms, unbalanced.

FIDELITY MEASURING OUTPUT

FREQUENCY RESPONSE: ± 0.5 dB, 20 Hz to 20 kHz.

DISTORTION: Less than 0.3%.

OUTPUT VOLTAGE: At 100% modulation, output is 4.4 volts with a load resistance greater than 100,000 ohms.

OUTPUT IMPEDANCE: 4,000 ohms, unbalanced.

NOISE: 70 dB below nominal outputs of both monitoring and fidelity outputs.

REMOTE OUTPUT: For meter and flasher indications at another location, use Harris' remote meter panel 994-7097-001.

GENERAL

SIZE: 19" long x 7" high x 7" deep. (48.26 cm x 17.78 cm x 17.78 cm.) Will mount in a standard relay rack.

WEIGHT: Domestic, 12 lbs. (5.44 kg). Export, 21 lbs. (9.53 kg). Cubage: 3 cubic feet.

AMBIENT TEMPERATURE RANGE: -4° to 125° F. (-20° to 52° C.)

AMBIENT HUMIDITY RANGE: 0% to 95% relative humidity.

ALTITUDE: Sea level to 7500 feet (2286 meters).

ORDERING INFORMATION

AM-80 Solid-state AM Modulation Monitor 994-7084-001

AM-80 Remote Meter Panel 994-7097-001

Recommended Semiconductor Kit for AM-80 994-7180-001





AF-80

Medium Wave Frequency Monitor

Harris' medium wave frequency monitor is an FCC type accepted instrument designed to meet or exceed all requirements for measuring carrier frequencies of standard AM broadcast transmitters.

Available in a digital read-out model, this frequency monitor employs solid-state integrated circuits throughout, and features light-emitting diode (LED) indicators.

The monitor will accept as input any standard AM frequency, and will indicate the deviation from assigned frequency. The input may be a modulated RF signal of 0.2 volts to 10 volts RMS. Unlike other designs, there is no loss of indication when the sample RF is modulated above 95%. A unique circuit "remembers" the last valid measurement until the modulation of the RF input is less than 95% for a normal one-second counting period.

A two-digit display indicates the magnitude of the frequency error, and a plus-minus indicator shows if the frequency is above or below the assigned frequency. Above ± 31 Hz error, the digits are blanked, but the sign indicator continues to operate.

An "alarm" indicator and relay contact closures warn of frequency errors greater than ± 20 Hz.



After A.C. power is applied the monitor stabilizes to reliable readings within 5 minutes. There are no delicate thermostats or heater controls. The reference oscillator is heated by a proportional oven which maintains the unit's accuracy at a constant level over a wide range of ambient temperatures.

Only one crystal is needed to cover the entire broadcast band. Setting up to the station frequency simply entails "programming" the counter. The procedure is so simple that it can easily be accomplished in the field should the station change frequencies.

A test button, when depressed, checks all LED's and read-out tubes.

A remote indicator may be operated over telephone lines of up to 5000 ohms loop resistance. The optional remote accessory may be factory installed or added later in the field. In either case the remote panel contains an analog meter display. One control adjusts calibration of the remote meter, and the test button confirms that the meter is polarized correctly.

SPECIFICATIONS

- FREQUENCY RANGE:** 540-1600 kHz as ordered.
- RF INPUT IMPEDANCE:** 50 ohms.
- RF INPUT CONNECTOR:** BNC.
- RF INPUT SENSITIVITY:** (Unmodulated) 10 mV to 10 V RMS carrier.
(Modulated) 0.2 V to 10 V RMS RF, 0-95% modulation.
- A.C. POWER INPUT:** 115/230 VAC, 50/60 Hz, 40 watts.
- REFERENCE OSCILLATOR:** Crystal-controlled in proportional oven.
- ACCURACY:** Better than 1.85 ppm (0.5 Hz @ 540 kHz).
- DEVIATION INDICATOR RANGE:** ± 31 Hz deviation.
- STATUS INDICATORS (LED):** Low input alarm; ± 20 Hz deviation alarm; Count period.
- ALARM RELAY:** 120VAC/28 VDC @ 5A N/O & N/C contacts at ± 20 Hz or greater deviation.
- REMOTE:** Maximum remote loop resistance...5000 ohms.
- AMBIENT TEMPERATURE RANGE:** 0 to 55°C.
- AMBIENT HUMIDITY RANGE:** 0 to 95% relative humidity.
- ALTITUDE:** 0 to 7500 feet above sea level.
- DIMENSIONS:** 19" wide, 3.5" high, 10.25" deep.
- WEIGHT:** (Domestic packed) 20 lbs. (Export packed) 45 lbs. (Cubage) 2.4 cu. ft.

ORDERING INFORMATION

- AF-80 medium wave frequency monitor, digital read-out . 994-6698-001
- Recommended spare IC's for AF-80 frequency monitor .. 990-0747-001
- Remote (digital) meter panel for AF-80 frequency monitor
above 994-6863-001



HARRIS
COMMUNICATIONS AND
INFORMATION HANDLING

MW TRANSPORTABLE

**A Completely Assembled,
Easy-To-Ship
Medium Wave
Transmitting Station**

- Basic system includes all necessary buildings and equipment for a complete medium wave transmitting station
- Available with a variety of options, including living quarters and generator units
- Buildings pre-assembled, equipment installed and tested prior to delivery
- Readily transportable to even the most difficult-to-reach site
- Minimum site preparation
- High-strength, minimum-maintenance fiberglass buildings
- Harris transmitting equipment for top performance, top reliability

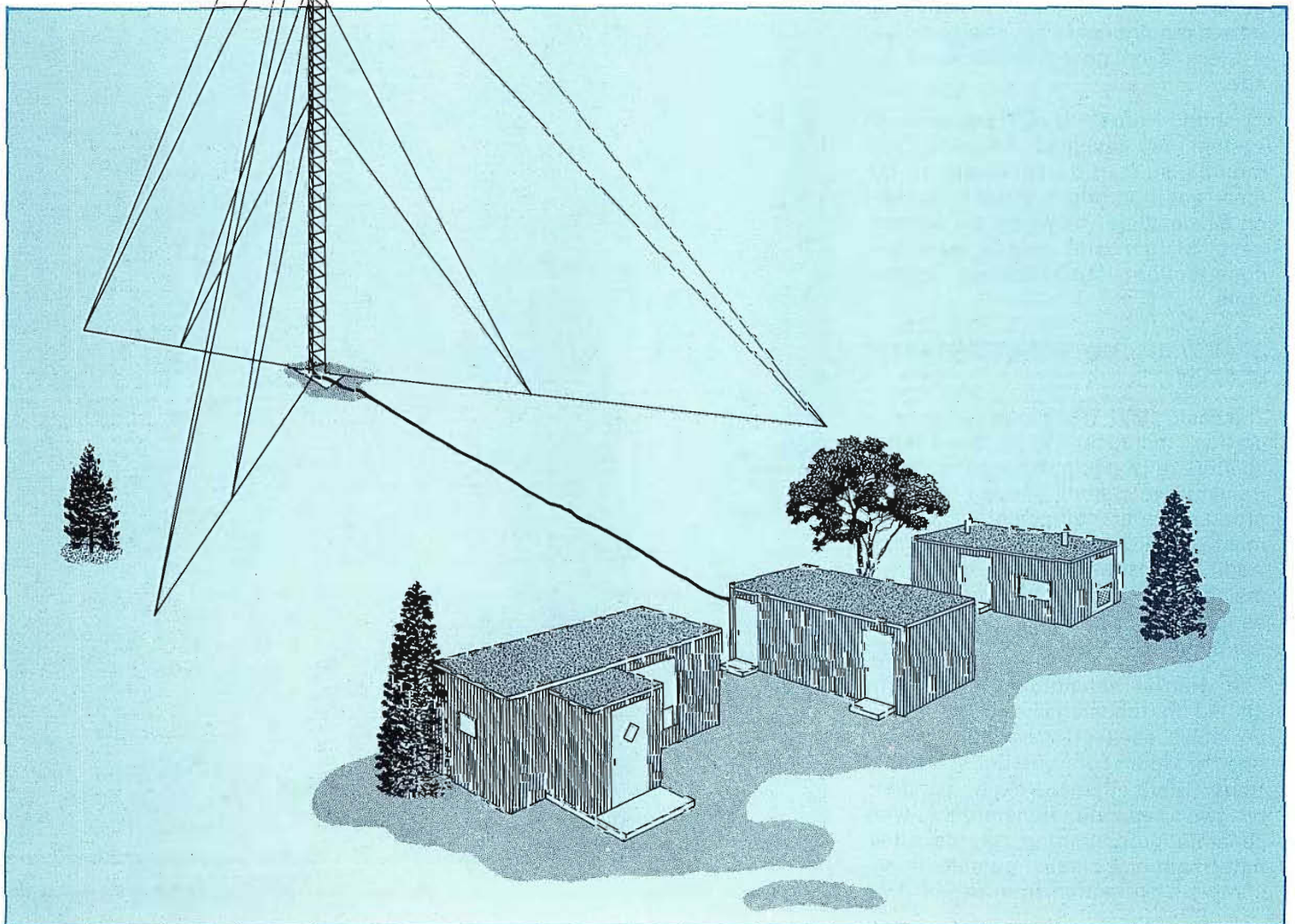

A Harris "MW Transportable" system provides the quickest, easiest way now available for going on-air with a complete medium wave transmitting station!

No matter what your requirements, Harris has the capability of delivering the required transmitting installation to almost any spot on earth, completely pre-packaged and ready for operation within seven to fourteen days after delivery.

The only thing required is a firm, level site on which to set the pre-assembled housing units and the quick-erect mast radiator--civil works are unnecessary. The lightweight, but extremely sturdy buildings are skid mounted, and need little or no foundation work. Transmitting and program input equipment is installed and tested prior to delivery--you need only hook it up to the power source. An optional housing unit for one or two persons can be delivered ready for occupancy. And finally, an optional generator unit is available to handle all power requirements for the complex, if there is no power available at the site.

In short, Harris' "MW Transportable" system is designed to save you months in start-up time--and is the ideal solution when there is a tight on-air deadline, or when the remoteness of the site makes extensive construction impractical--or impossible.

STANDARD "MW TRANSPORTABLE" SYSTEM

The basic "MW Transportable" configuration includes: 1) a transmitter shelter, fully equipped with a Harris transmitter system and all required program input equipment; and 2) a mast radiator and ground system. Additional shelters and equipment may be added to the standard system as options, depending on your requirements.

The Harris transmitter system installed in the standard "MW Transportable" shelter is available in any one of four configurations: single transmitter; alternate/main; parallel; or two separate transmitters with separate programming. In the alternate/main and parallel combinations, complete protection from off-air time

is provided. Automatic and instantaneous switching to the standby unit is provided with the alternate/main, and instant automatic switching to half-power occurs in the parallel combination, in the unlikely event of failure of one of the transmitters. "MW Transportable" systems are available incorporating Harris' one, five or ten kilowatt medium wave transmitters. The size of the shelter depends on what power and transmitter configuration you choose.

The standard program input equipment provides up to ten inputs, and may be duplicated as an option--with space and wiring provided in the standard rack for the duplicate equipment.

Program input to the system can be by "of-air" reception of a remote high

power station, by VHF/STL or by telephone line. Provision has been made for all of these types of input. In addition, a tape playback unit may be included to cover any breakdown in regular programming. Other program inputs can be supplied as options, up to a limit of nine.

A full set of monitoring and test equipment is also standard to allow regular checks on system performance.

The Harris "MW Transportable" transmitting station is supplied with a lightweight quarter wave mast radiator that can be assembled and erected at the site within seven days (including ground system).

"MW TRANSPORTABLE" OPTIONS

Numerous options are available to add to your standard system, including

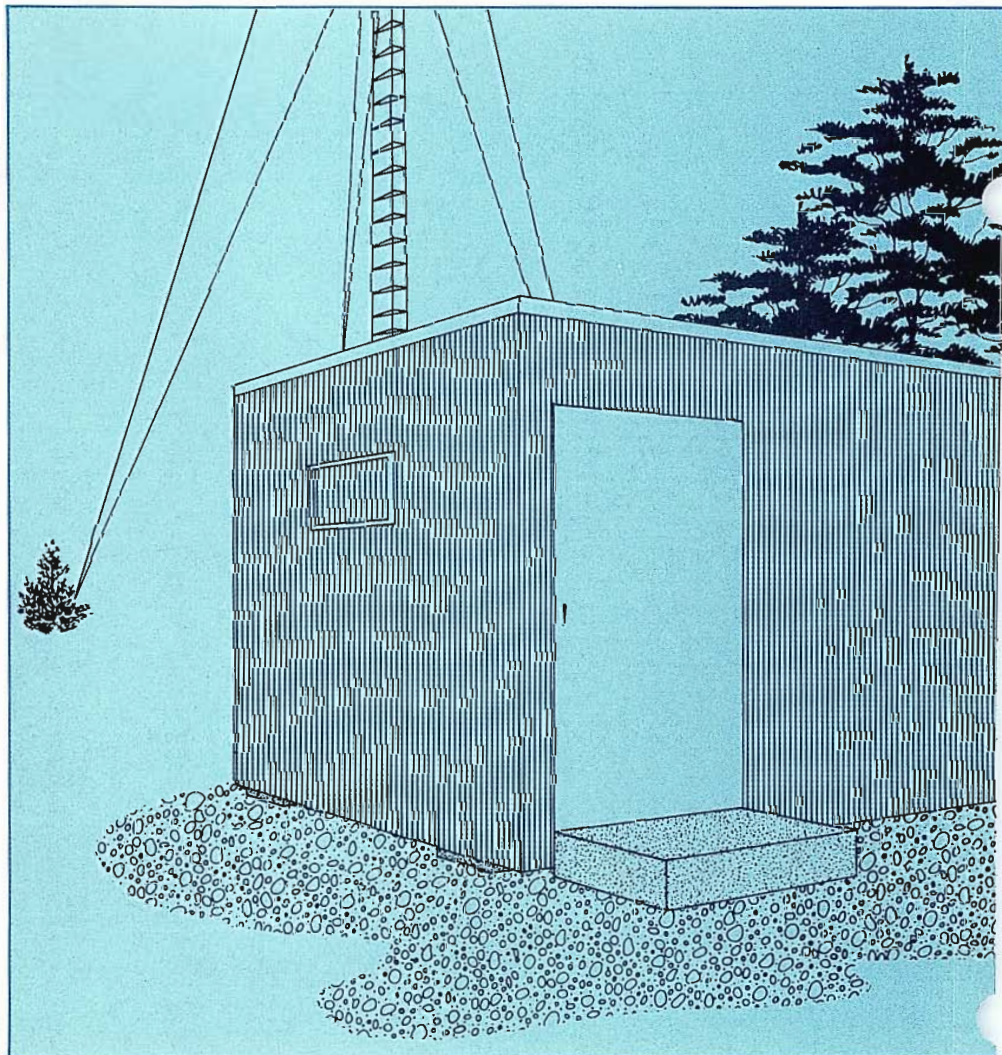

Each shelter is completely assembled prior to shipment, and built on a skid that can serve as the foundation.

such major items as a living quarters shelter for one or two persons, and a completely self-contained generator/shelter unit to serve either as a standby to the main power, or as the main power source at a remote site. In addition, such options as perimeter lighting, air conditioning, etc. may be included. This "options" concept allows you the flexibility of setting up exactly the type of station you need, without paying for unwanted extras.

The optional living quarters module is supplied complete with furnishings, equipment and storage areas. Facilities include bunk beds, desk, clothing lockers, table and chairs, storage cabinets, sink, electric cooker, toilet, shower, wash basin, hot water heater and exhaust. Air conditioning, a washer/dryer unit, and a refrigerator/freezer are optional.

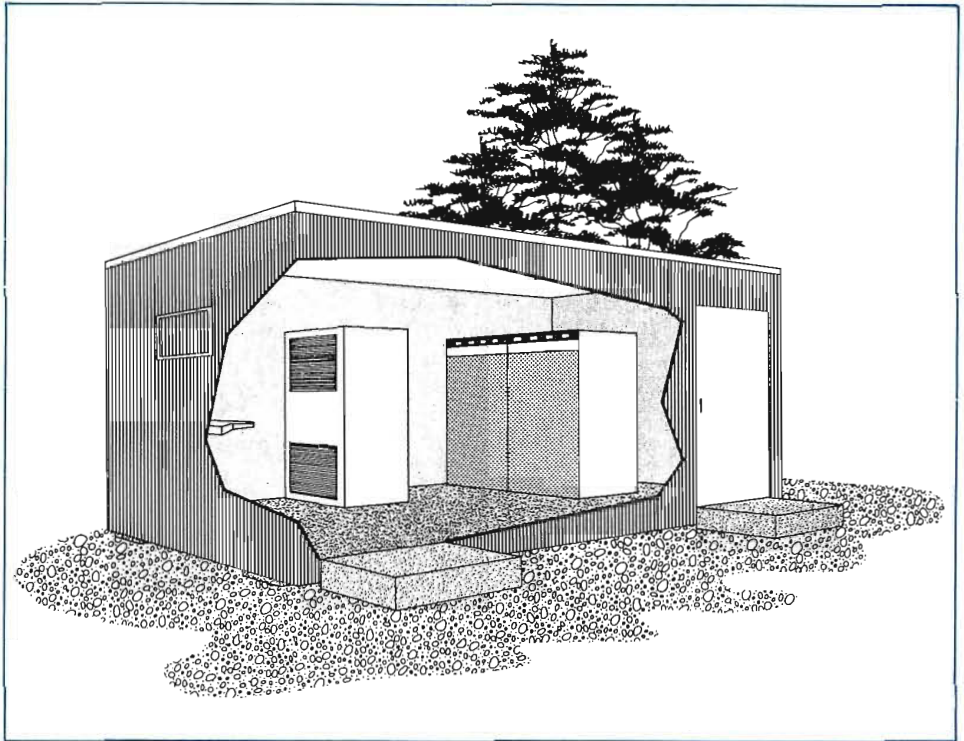

Cutaway drawing of a typical one-kilowatt transmitter shelter, showing equipment installation. Transmitter and program input equipment is factory installed and tested prior to shipment.

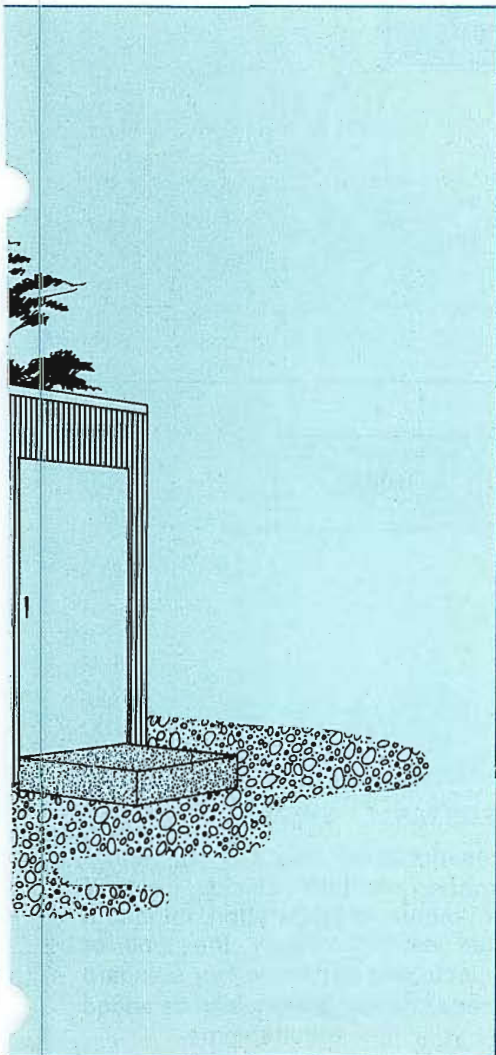

at site, so that little or no civil works are required.

The optional generator shelter is supplied with either a single AC generator, or with dual AC generators operated in a main/standby system. The size of the shelter and of the generators is dependent on the amount of power required by the complex (i.e.: power output of the transmitter system, inclusion of living quarters, air conditioning, perimeter lighting, etc.).

SHELTER CONSTRUCTION

Harris' "MW Transportable" shelters are constructed from top grade heavy-duty materials to stand up under the most difficult weather conditions and the most punishing use. Each shelter is built on a special heavy-duty skid, which prevents warping and floor sagging, and can serve as the foundation at the site. The skid also allows each shelter to be shipped easily, as the skid provides the lifting points for the module.

The shelter exteriors are of extra-tough, weatherproof fiberglass, which needs no routine maintenance, over 3/8-inch plywood and 1-5/8-inch styrofoam insulation. The interiors

include panelled side walls, and vinyl-asbestos tile flooring. The insulated doors are sealed on all four sides with air-tight, dust-out weather stripping.

These pre-assembled, no-seam shelters are specifically designed to keep electronic equipment in a safe, controlled environment, no matter where the station is located. Each unit--whether transmitter shelter, living quarters shelter or generator shelter--is delivered fully equipped.

READILY TRANSPORTABLE

Harris' "MW Transportable" shelters are designed for shipment by flat-bed truck, by rail, by sea and even by air to almost any spot in the world. The lightweight, yet extra-sturdy shelters serve as shipping containers for the rigidly-braced equipment inside en route to the site, and as the final housing at the site. This shelter concept eliminates time consuming and expensive unloading and installation of equipment at the station location, and assures that you will be ready to go on-air in minimum time after delivery.

BASIC MW-1A, ONE-KILOWATT DUAL MEDIUM WAVE

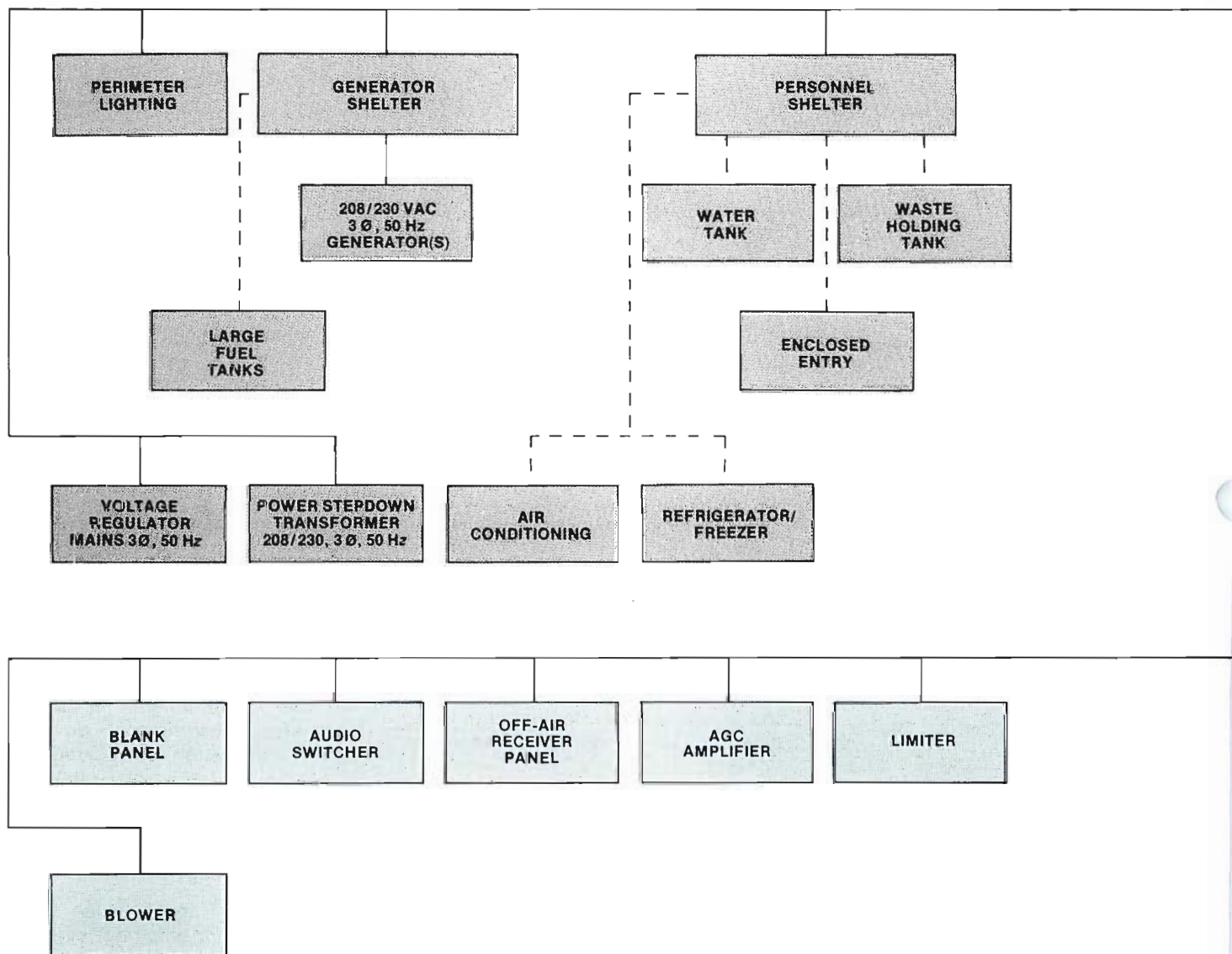

ABOUT "MW TRANSPORTABLE" SYSTEMS

With Harris' "MW Transportable" you can set up a medium wave transmitting station quickly, almost anywhere on earth, with minimum preparation, minimum difficulty. And you can set up exactly the type of operation you want, by including options with a standard system. Also, if your needs change, options can be added at a later date to meet your new requirements.

TRANSMITTING SYSTEM, AND AVAILABLE OPTIONS

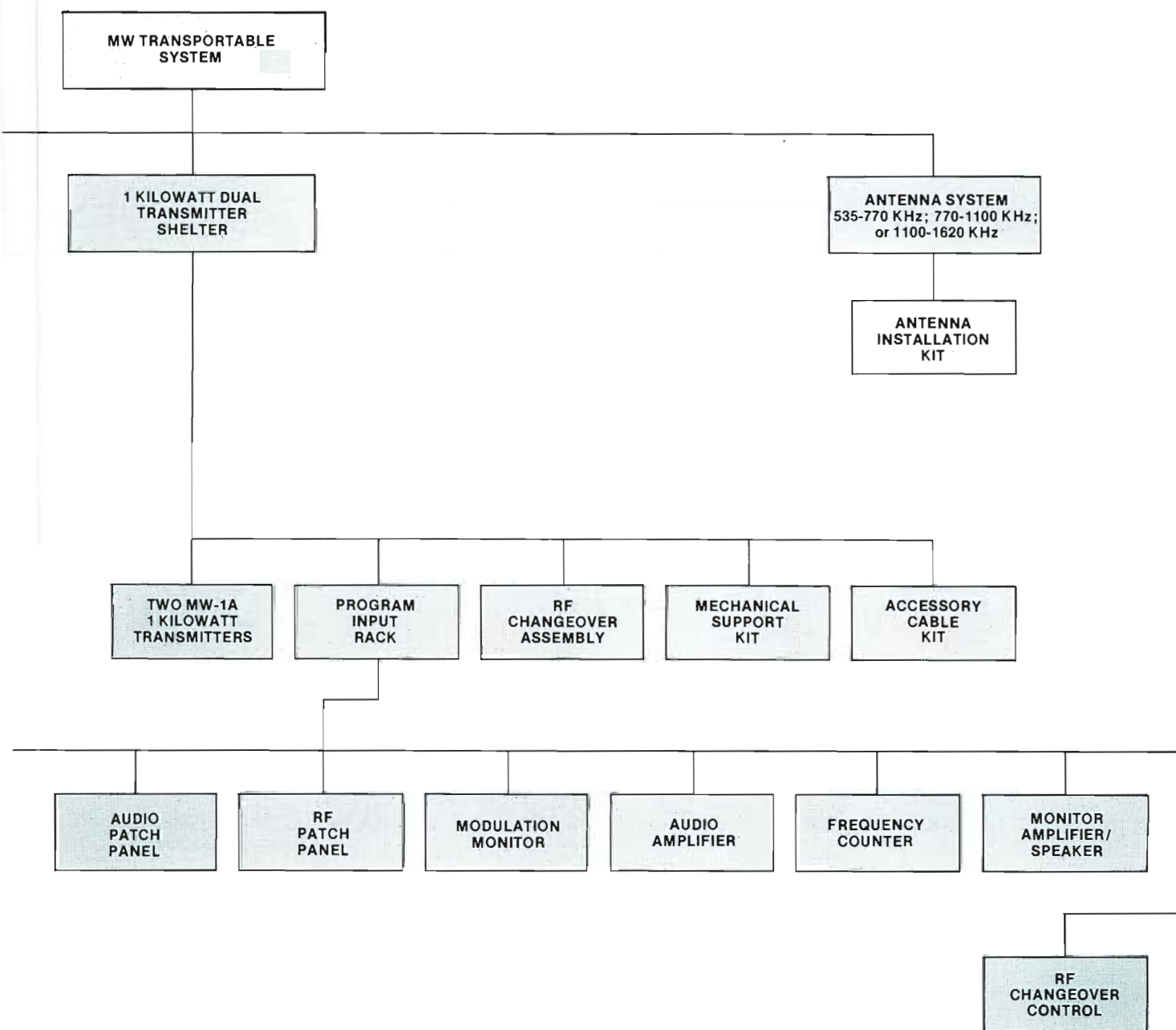

The chart above shows a one-kilowatt alternate/main transmitting system, and gives a quick indication of what is standard and what is optional. There are, of course, other transmitter configurations available in one-kilowatt systems, and other power ranges available (five, ten and twenty), but generally, most of the systems are similar to that shown.

KEY:

STANDARD EQUIPMENT SHOWN IN BLUE.

OPTIONS SHOWN IN GRAY.

- - - - SHOWS OPTIONAL EQUIPMENT WITH THE OPTIONS.

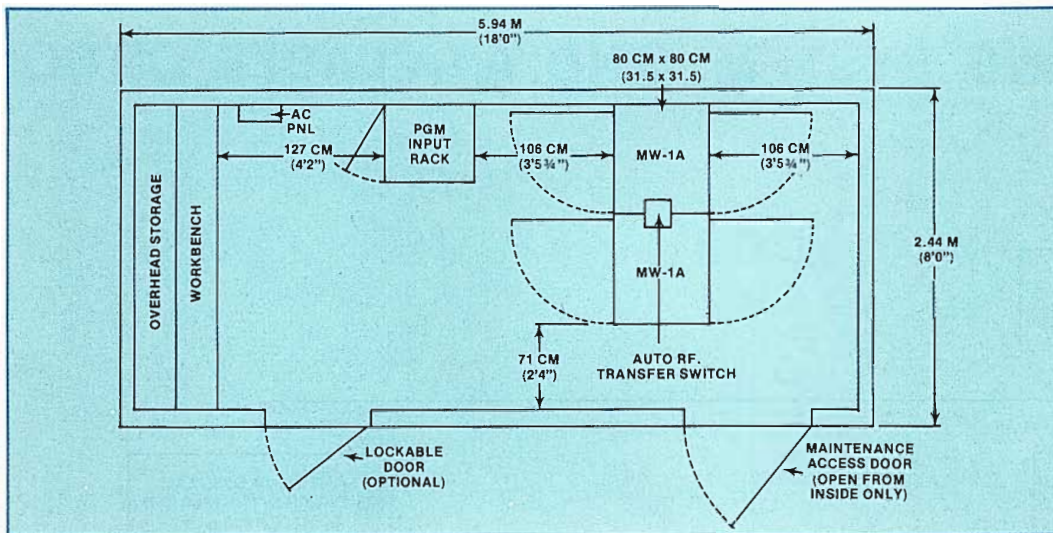

One-kilowatt transmitter shelter

TYPICAL SHELTER FLOOR PLANS...

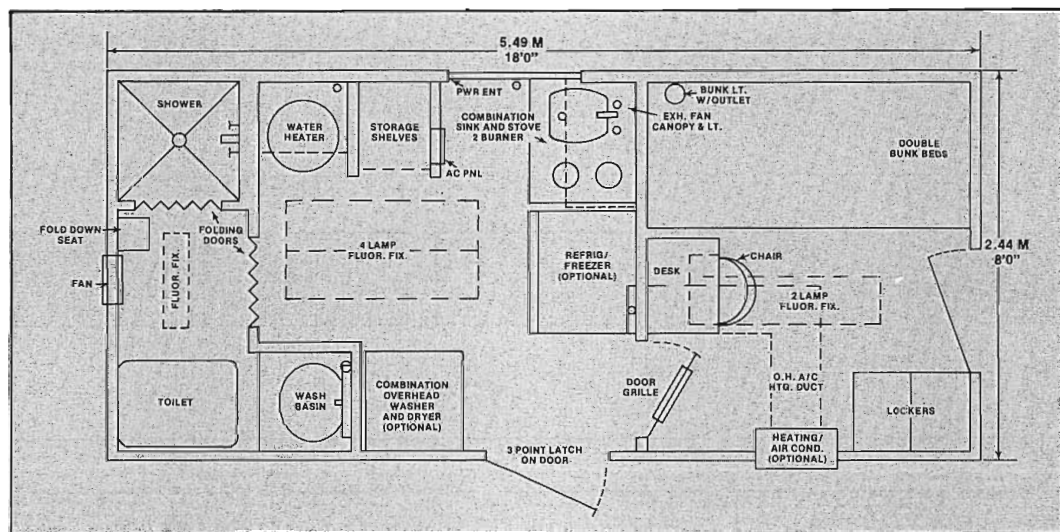

Living shelter (optional)

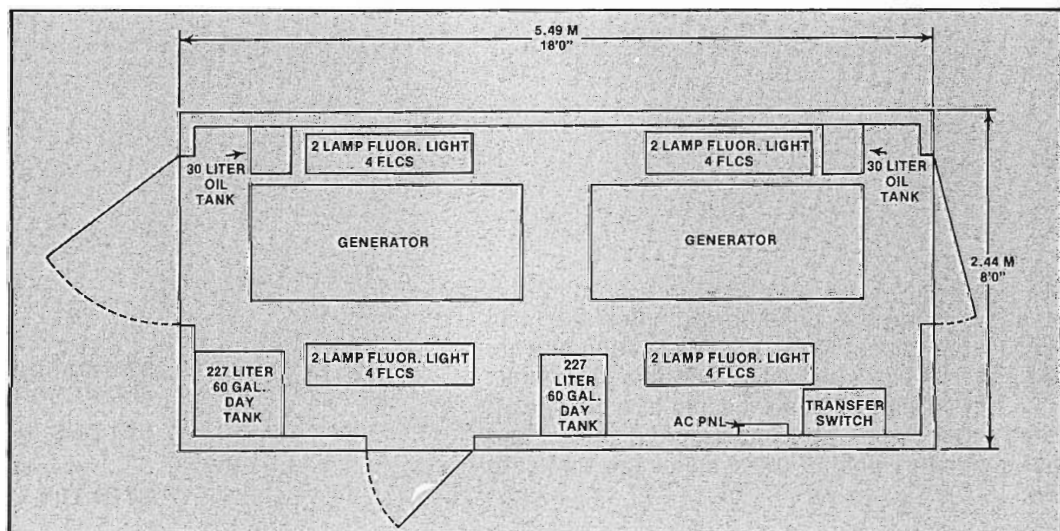

Generator shelter (optional)



QUICK-ERECT ANTENNA

The most practical antenna system for a station that has a tight on-air deadline is the quick-erect mast radiator. This quarter-wave system is designed so that the tower can be raised, and the ground system installed in a week or less. It includes a sturdy, easily assembled aluminum tower and matching unit; guys and screw anchors; all necessary hardware; a tool kit; and complete instructions.... everything you need to set up for operation quickly. The mast radiator is available in power ratings up to 20 kilowatts, in the following frequency ranges: 535-770 kHz; 770-1100 kHz; and 1100-1620 kHz.

ABOUT SHIPPING COSTS

The total cost of an "MW Transportable" pre-equipped, pre-assembled structure, delivered on site, ready for use, is lower than on "knock-down" construction...and is a much better product. Although it costs a little more to ship a pre-assembled building (shipping costs are based on cubage rather than weight), when you take into consideration the cost of a crew on site for assembly, expensive crating for the electronic equipment, etc., the pre-assembled building saves you money.

Also, with Harris' "MW Transportable", the electronic equipment is safely and properly installed in the building prior to shipment, so that the building itself serves as a shipping container to protect delicate equipment from rough handling, and from pilfering. On delivery the equipment is in place, and requires minimal expense to get it ready for use.

And finally, it is almost impossible to assemble and weatherproof a shelter on site and achieve the top quality results that are assured by factory assembly prior to shipment.

Overall, then, you receive a superior product, at less cost, by going with the pre-assembled "MW Transportable". And, of course, you save time in getting on the air.

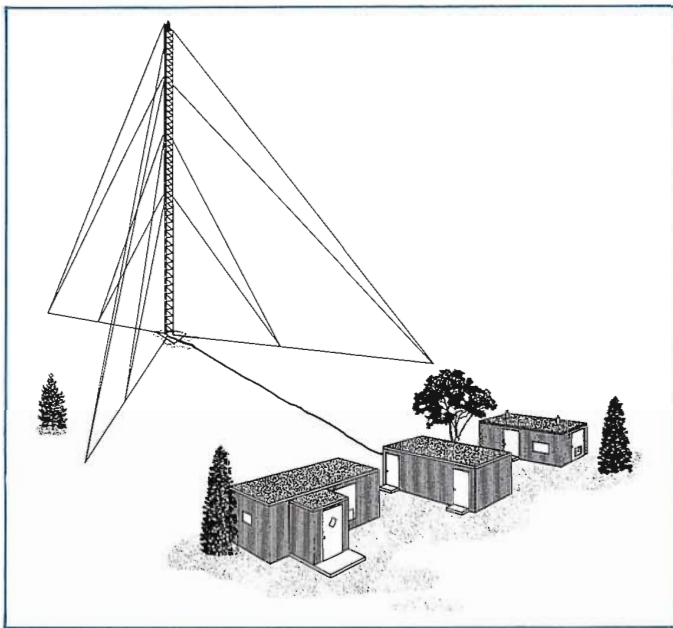

Typical "MW Transportable" complex, including transmitter shelter, quick-erect antenna and optional living quarters and generator shelters.

HARRIS' "MW TRANSPORTABLE" EQUIPMENT LIST

"MW Transportable" systems employ Harris' one, five or ten kilowatt medium wave transmitters--in single, parallel and alternate/main configurations, or employ two separate transmitters for separate programming. The listing below shows standard and optional equipment for

parallel or alternate/main operation--and the equipment for the other two configurations would be almost identical, except there would be no switcher or combiner. Also, in the case of two separate transmitters, duplicate program input equipment would be standard.

STANDARD EQUIPMENT

Transmitter Shelter: The size of the pre-assembled shelter depends on the power of the transmitter system. The transmitter system and the program input equipment are pre-installed in this shelter.

Transmitter System: Two Harris one, five or ten kilowatt medium wave transmitters with either a changeover switcher for alternate/main operation, or a combiner for parallel operation.

Program Input Equipment Rack: Includes an audio switcher with ten high level inputs, and program and monitor outputs; automatic gain control amplifier; modulation monitor; limiter; VU meter; monitor amplifier/speaker; audio patch panel; line amplifier; RF changeover control; RF patch panel.

Antenna System: Quarter-wave mast radiator, with antenna installation kit, including ground system. Specify frequency range (535-770 kHz; 770-1100 kHz; 1100-1620 kHz).

MAJOR OPTIONS

Personnel Shelter: Includes two bunk beds, desk and chair, two clothing lockers, table and chairs, storage cabinets, sink, electric cooker, toilet, shower, wash basin, hot water heater, exhaust, reserve water tank and a waste tank. Air conditioning, a washer/dryer unit, and a refrigerator/freezer are optional with the shelter.

Generator Shelter: Includes single AC generator, or dual AC generators operated in a main/standby system. The size of the generators and the shelter is dependent on your power requirements.

Perimeter Lighting: Perimeter or area lighting in a variety of configurations is available for security or safety purposes.

Optional Program Input Equipment: Space is provided in the transmitter shelter for additional racks of STL or automation equipment...and there is space and wiring included in the standard program input equipment rack for one additional AGC amplifier and an additional limiter.

NOTE: EQUIPMENT LISTS AND SPECIFICATIONS ARE SUBJECT TO CHANGE WITHOUT NOTICE.



HARRIS
COMMUNICATION AND
INFORMATION PROCESSING

SW-100

100,000 Watt Short Wave Broadcast Transmitter

- High level Pulse Duration Modulation
- Exceeds 55% overall efficiency
- 10-Channel pre-set tuning
- Low power consumption
- Only five tubes for 100 kW
- Vapor phase cooling
- Designed for trapezoidal programming
- Minimum floor space
- Full front and rear accessibility

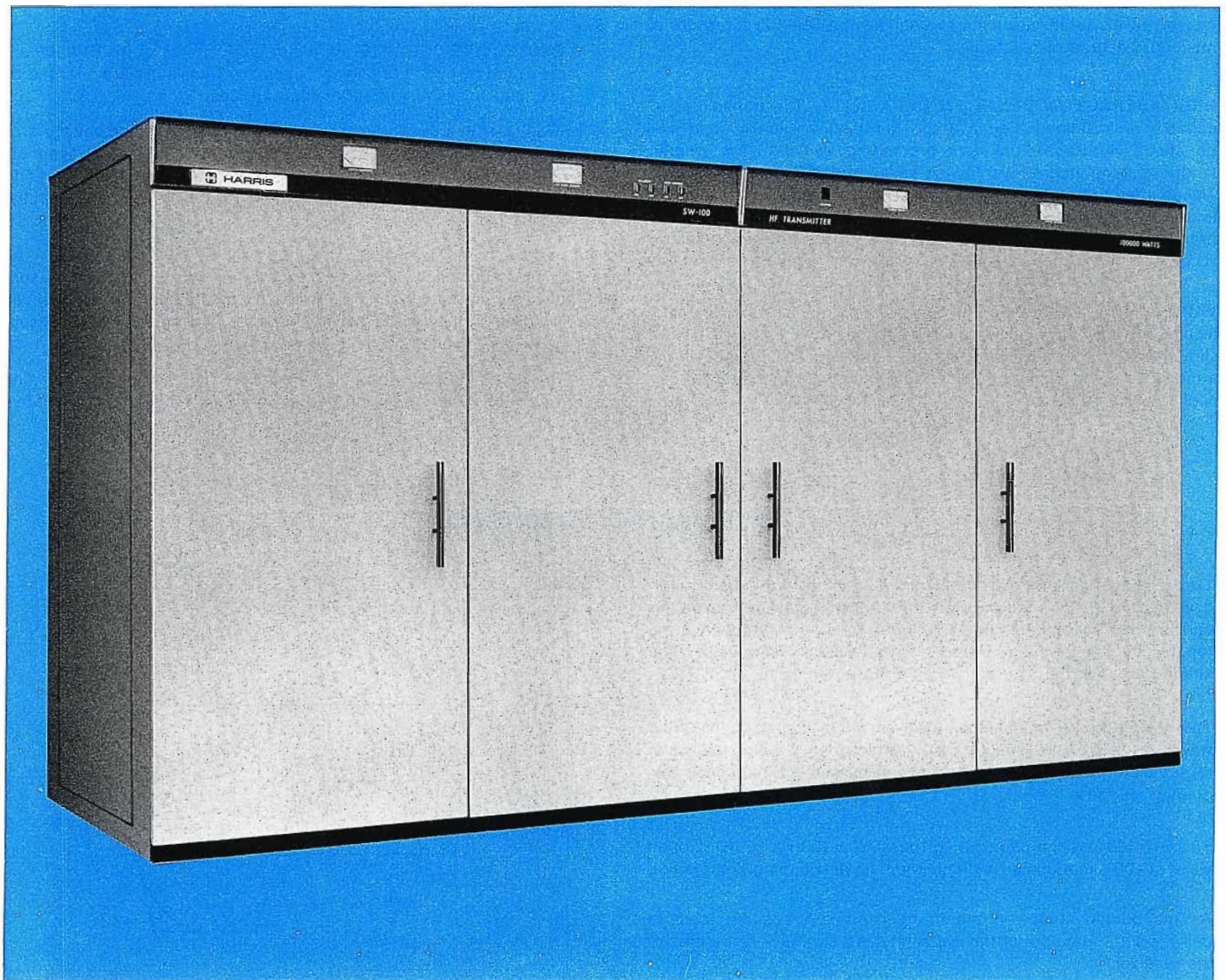

Harris' SW-100 is a high-level, plate modulated short wave broadcast transmitter, featuring automatic 10-channel pre-set tuning. Utilizing the exclusive Pulse Duration Modulator, the SW-100 provides higher efficiency, lower operating costs and overall performance superior to that of any other short wave transmitter in the 100 kilowatt power range. The transmitter is capable of operating at any frequency between 3.2 and 22 MHz.

HIGH EFFICIENCY.....EXCEEDS 55%. The Pulse Duration Modulator employed in the SW-100 is almost 90% efficient (instead of the usual 50% to 60%), enabling the transmitter to achieve an unusually high overall efficiency of greater than 55%. This means about one third less power consumption than that of other high level plate modulated 100 kW transmitters.

10-CHANNEL PRE-SET TUNING. Few controls and ample metering make the SW-100 the easiest tuning high power transmitter available. The servo system will automatically tune to any of ten pre-set channels in about 10 seconds. Auxiliary switching is possible for each channel for antenna switching, synthesizer programming, etc. Up to ten different frequencies from 3.2 to 22 MHz can be remembered, which allows pushbutton re-tuning to any pre-set frequency.

FIVE TUBE DESIGN. The entire transmitter employs just five tubes, with modern ceramic 4CV50,000E tetrode power tubes operating well below manufacturer's dissipation ratings. All power supplies utilize long-life solid-state silicon rectifiers. Highest quality components, conservatively rated, are used throughout the SW-100 to assure a maximum degree of reliability.

HIGH AVERAGE MODULATION CAPABILITY. The transmitter is capable of sustained high average modulation such as that experienced with trapezoidal audio processing—which means greater loudness at the receiver without increased transmitter carrier power. This is a feature of the high efficiency, DC coupled PDM modulator that avoids the use of large, inefficient transformers in the modulation process. Another feature of this high efficiency series type modulator is convenient front panel carrier power adjustment over a wide range.

VAPOR PHASE COOLING. The SW-100 employs the vapor cooling technique. This highly efficient method of heat transfer results in constant anode temperatures and extended tube life. This system allows a much smaller and more efficient heat exchanger than older water cooling systems.

MINIMUM FLOOR SPACE. Due to the elimination of large iron core components such as the modulation transformer and modulation reactor, the SW-100 requires only 7 square meters (76 square feet) of floor space. Advanced cabinet design provides easy accessibility to all components.

RF SECTION. The RF chain is conventional using a transistorized oscillator, buffer, emitter follower and a 4CX1500A tetrode tube amplifier to drive a single 4CV50,000E tetrode Class C power output stage.

An automatic drive control maintains the PA screen current at 1.75 amps, eliminating the usual problem of over-dissipating the screen of a tetrode during tune-up.

THE MODULATION SYSTEM. Harris' Pulse Duration Modulator is characterized by low plate dissipation and low peak tube currents; peak cathode currents are about one-half that of other 100 kW transmitters. Average plate dissipation runs substantially below rated levels, and all peak voltages are maintained well below component ratings.

Wide frequency response is possible as large reactive components are not used in the modulation system. Control of the transmitter power output over a wide range is accomplished in a low-level stage of the modulator by means of a convenient front panel vernier control. No adjustment is necessary in any high power RF circuit.

PROTECTIVE CIRCUITS. All major components of the SW-100 are protected by circuit breakers. Tubes and transistors are guarded by overload relays or current-limiting devices.

A quick-acting circuit protects against damage by high voltage arcs by limiting the energy in such arcs to less than 10 watt seconds. Protection against voltage standing wave ratios of greater than 1.5 to 1.0 is provided. Both forward and reflected power are metered at the front panel.

In case of momentary RF overloads the SW-100 will recycle three times automatically. Should a third overload occur within a thirty second period, the transmitter will remain off until manually reset. However, if the time between overloads is greater than thirty seconds, continuous recycling will occur.

The SW-100 employs a unique method of transmitter protection. The modulator tube may be turned off in a low level state in about five

TRAPEZOIDAL RESPONSE

Trapezoidal audio processing may be used to develop greater intelligence carrying sideband power without increasing the transmitter carrier power. To do this the audio input wave (A) is flattened at the top, by clipping, then reamplified to form a trapezoidal wave (B). The shaded areas in the diagram indicate the power gain.

The desired power gain is lost, however, if this clipped, or flattened wave tilts downward due to poor low frequency response, or is rounded out again to its original shape by sub-standard high frequency response.

The SW-100 has the capability of passing a 100 Hz 12 dB clipped wave at 100% modulation with minimum tilt or rounding of the wave.

All the additional power gained by clipping the audio input is delivered at the output of the transmitter, thus increasing volume at the receiver.

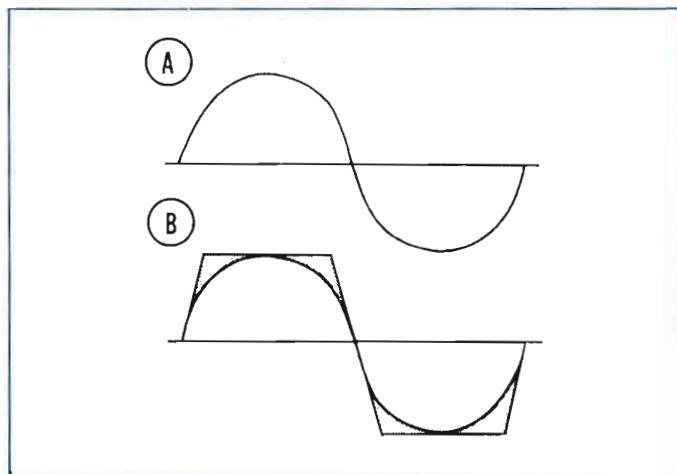

microseconds. This removes the HV from the plate of the tube, thus eliminating most faults which normally occur. The HV supply (diodes and transformer) is capable of withstanding repeated short circuits without harming the unit.

An automatic gain control monitors the PA screen. The PA may be operated with no HV but with screen voltage and under any condition of tuning with no damage being done to the PA tube.

Additional protection is provided by the HV circuit breaker. Tubes and transistors are also protected by current limiting impedances.

THE SERVO SYSTEM. The all solid-state servo system will automatically tune any of 10 pre-set channels in about ten seconds. Each channel is "remembered" on one plug-in card. Auxiliary switching also is provided on each pre-set channel card for antenna switching, synthesizer, programming, etc. The fast tuning time is made possible because the HV supply is not disabled during the tune cycle; the RF drive is turned off in a low level solid-state stage, and all tuning is done in parallel. When the tuning has been accomplished, the modulator is turned back on silently and smoothly.

TRANSMITTER LAYOUT. The standard SW-100 consists of two cabinets, a heat exchanger and an external high voltage power transformer and voltage regulator. Front and rear doors and meter panel are magnetically latched. The SW-100 can be supplied with the heat exchanger for roof top mounting.

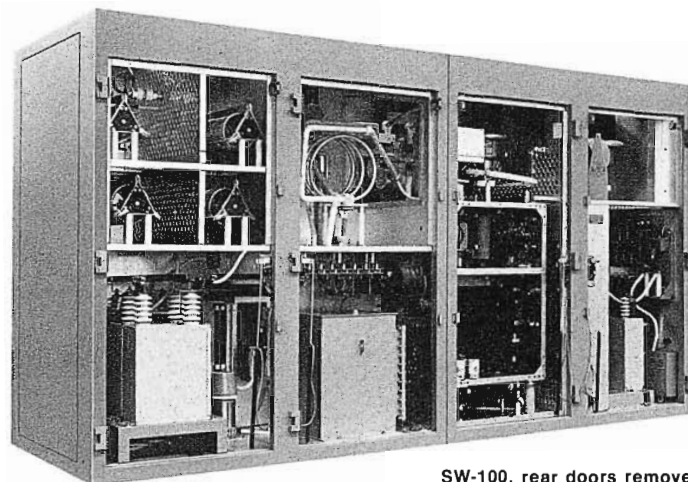

SW-100, rear doors removed
(Heat exchanger not shown)

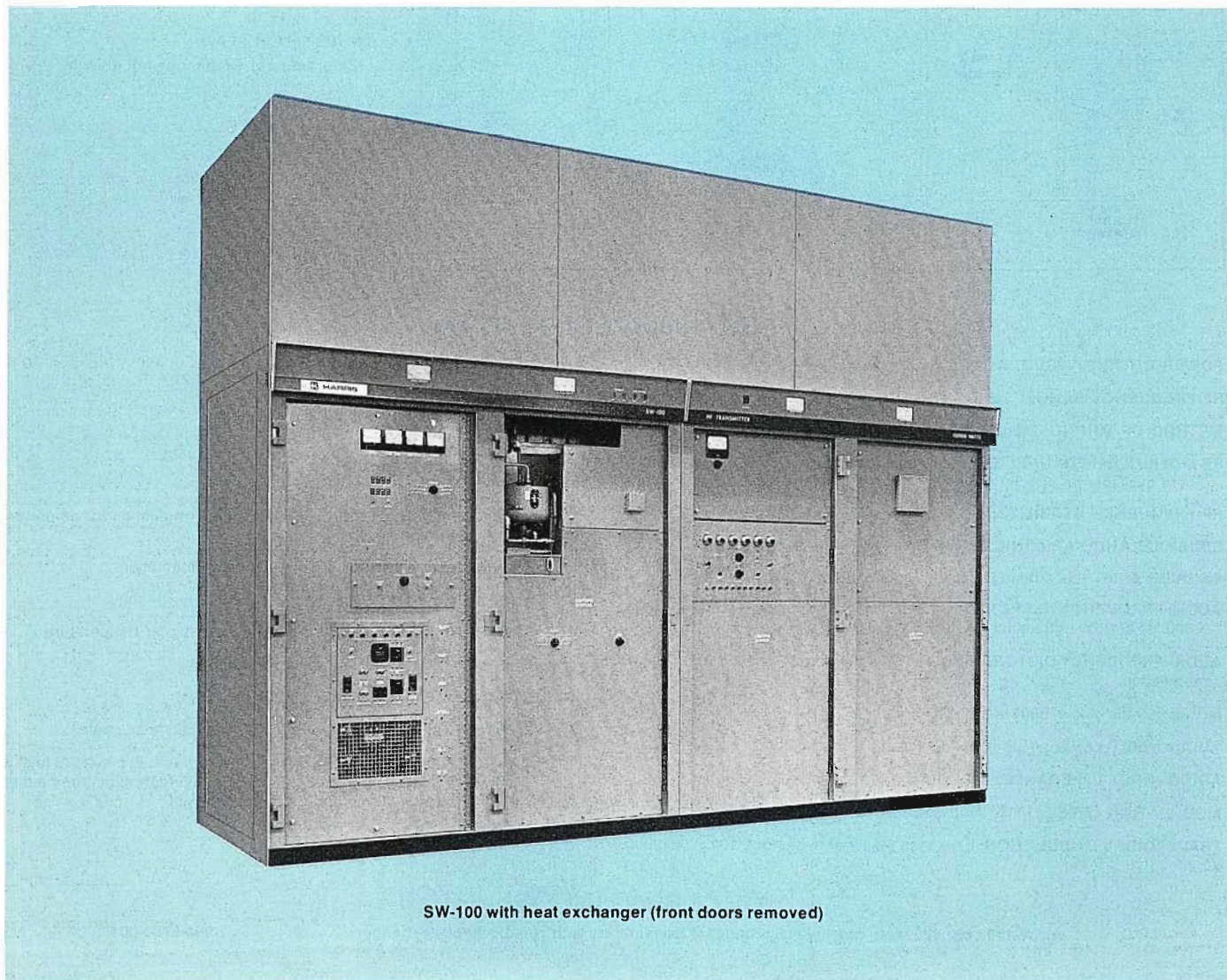

SW-100 with heat exchanger (front doors removed)

SW-100 BLOCK DIAGRAM

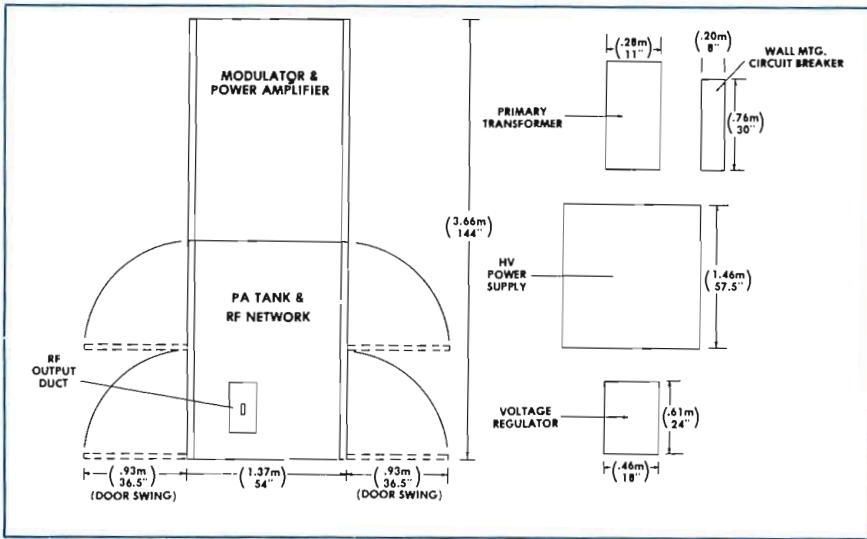
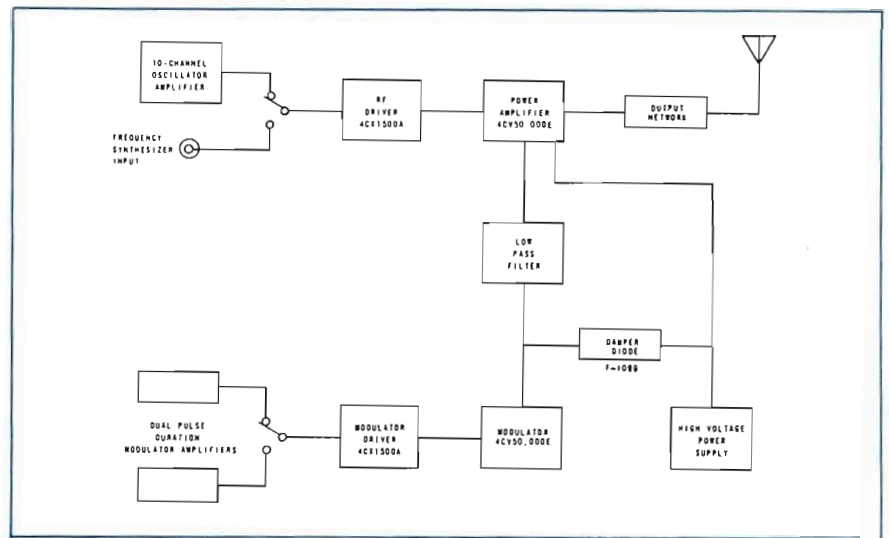

SW-100 FLOOR PLAN
(External heat exchanger not shown)

SW-100 SPECIFICATIONS

- POWER OUTPUT:** 100,000 watts nominal unmodulated.
- RF FREQUENCY RANGE:** 3.2 to 22.0 MHz.
- METHOD OF TUNING:** Manual, or selection of 10 pre-set channels.
- RF OUTPUT IMPEDANCE:** 300 ohms balanced, 1.6 to 1 maximum VSWR; others available on special order.
- RF FREQUENCY STABILITY:** $\pm 1 \times 10^{-6}$ (± 22 Hz at 22 MHz).
- SPURIOUS AND HARMONIC EMISSION:** Less than 50 mW.
- CARRIER SHIFT:** Less than 2% at 95% modulation.
- AUDIO FREQUENCY RESPONSE:** ± 1.5 dB from 50 to 10,000 Hz referenced to 1,000 Hz at 95% modulation.
- AUDIO FREQUENCY DISTORTION:** Less than 3% from 50 to 10,000 Hz at 95% modulation.
- NOISE:** 55 dB below 1,000 Hz, 100% modulated level.
- AUDIO INPUT LEVEL:** 0 dBm ± 2 dB for 100% modulation.
- AUDIO INPUT IMPEDANCE:** 600/150 ohms, balanced or unbalanced.
- MODULATION LEVEL:** 100% sinusoidal, 10 minutes, 50-5000 Hz.
- TRAPEZOIDAL MODULATION:** Less than 5% tilt or overshoot, 100 Hz to 2000 Hz.

- POWER INPUT:** Any specified voltage 380V to 480V, 3 phase, 50 or 60 Hz.
- POWER CONSUMPTION:**
 - No modulation 180 kW
 - 30% modulation 190 kW
 - 100% modulation 250 kW
- POWER FACTOR:** Greater than 95%.
- VOLTAGE REGULATOR:** Electronic voltage regulation for all power supplies other than high voltage.
- OVERALL EFFICIENCY:** 55% @ average modulation.
- TUBES:** Two-4CV50.000E; two-4CX1500A; one-F-1099.
- TEMPERATURE RANGE:** 0 to +50°C ambient air temperature.
- HUMIDITY:** 95% relative humidity, maximum.
- STORAGE TEMPERATURE:** -35°C to +60°C.
- ALTITUDE:** Up to 1829 meters (6000 feet) above sea level.
- CABINET DATA:** Each of two cabinets measures 1.83 meters (6 feet) wide, 1.37 meters (4.5 feet) deep, and 1.98 meters (6.5 feet) high. The heat exchanger adds another 1.06 meters (3.5 feet) in height.

ORDERING INFORMATION

SW-100, 100,000 watt short wave broadcast transmitter, with remote heat exchanger 994-6734-001



HARRIS
COMMUNICATION AND
INFORMATION PROCESSING

SW-50

50,000 Watt Short Wave Broadcast Transmitter

- High level Pulse Duration Modulation
- Low power consumption
- Vapor phase cooling
- 10-Channel pre-set tuning
- Only five tubes for 50 kW
- Full front and rear accessibility
- Minimum floor space
- Designed for trapezoidal programming

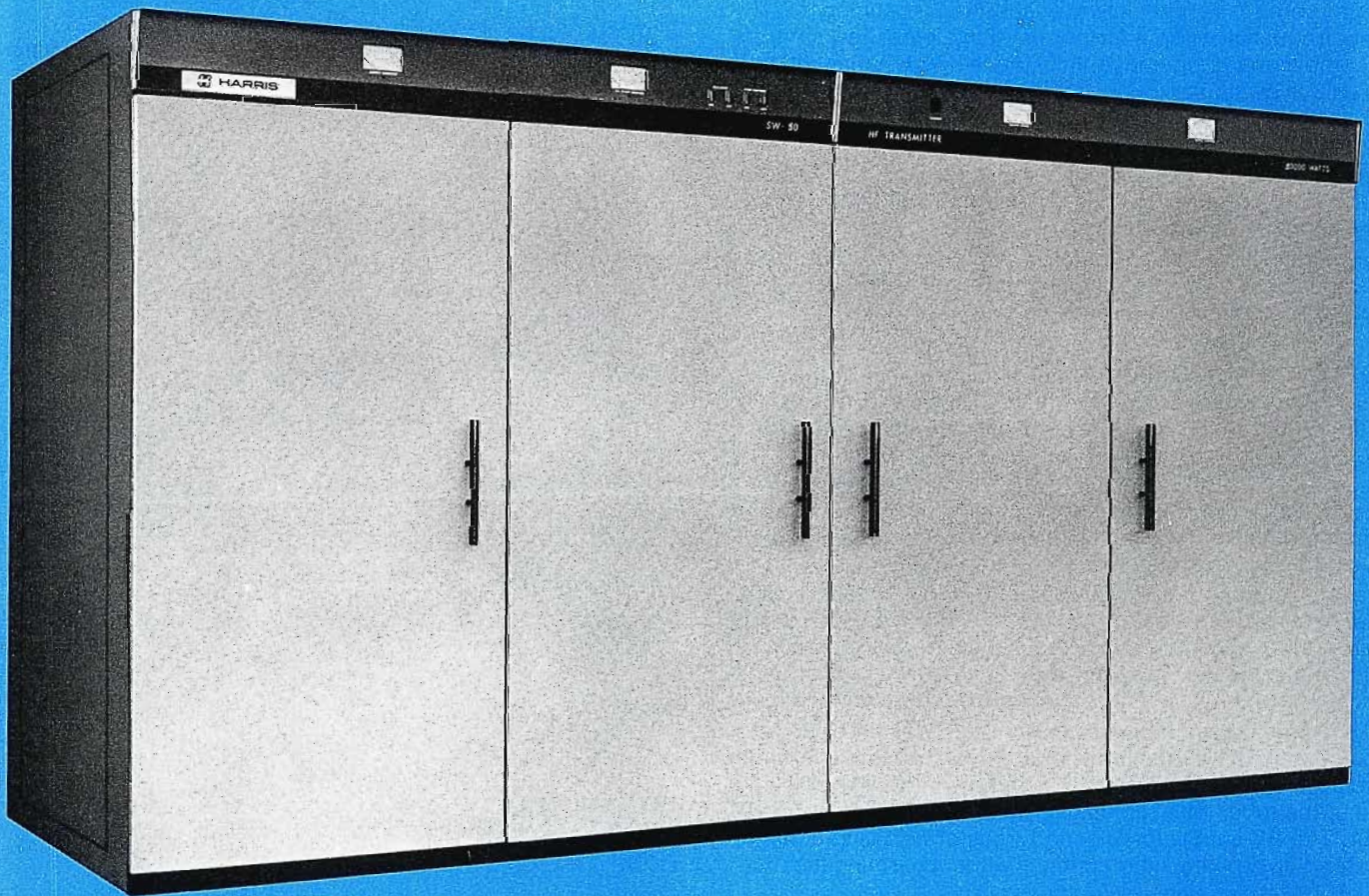

The Harris SW-50 is a rugged, reliable 50 kW short wave transmitter which uses the same design and engineering criteria as the popular Harris SW-100. The SW-50 provides overall performance superior to that of any other short wave broadcast transmitter in the same power range—and at significantly lower operating costs. This is made possible by Harris' exclusive high level Pulse Duration Modulator.

HIGH EFFICIENCY—EXCEEDS 46%. The Pulse Duration Modulator employed in the transmitter is almost 90% efficient (instead of the usual 50% or 60%), allowing an unusually high overall efficiency of more than 46%.

ONLY FIVE TUBES. The transmitter employs just five tubes—with a modern ceramic 4CV50,000E power tetrode in the modulator and final RF power amplifier sockets. All power supplies utilize long-life solid-state silicon rectifiers. Highest quality components, conservatively rated, are used throughout the SW-50 to assure greatest reliability.

100% MODULATION RATING. The high efficiency series type Pulse Duration Modulator permits 100% sine wave or trapezoidal modulation. Another feature of this high efficiency series type modulator is convenient front panel carrier adjustment over a wide range.

PRE-SET TUNING. After the SW-50 has been tuned to the desired frequency manually, the exact position of each variable tuning element is stored in a simple "memory". Up to ten different frequencies from 3.2 to 22 MHz can be "remembered", which allows pushbutton re-tuning to any preset frequency without further manual tuning. Few controls and ample metering make this the easiest tuning 50 kW transmitter available.

RF SECTION. The RF chain is conventional using a transistorized oscillator, buffer, emitter follower and a 4CX1500A tetrode tube amplifier to drive a single 4CV50,000E tetrode Class C power output stage.

An automatic drive control maintains the PA screen current at 1.75 amps, eliminating the usual problem of over-dissipating the screen of a tetrode during the tune-up.

PROTECTIVE CIRCUITS. All major components of the SW-50 are protected by circuit breakers. Tubes and transistors are guarded by overload relays or current-limiting devices.

A quick-acting circuit protects against damage by high voltage arcs by limiting the energy in such arcs to less than 10 watt seconds. Protection against voltage standing wave ratios of greater than 1.5 to 1.0 is provided. Both forward and reflected power are metered at the front panel.

In case of momentary RF overloads the SW-50 will recycle three times automatically. Should a third overload occur within a thirty second period, the transmitter will remain off until manually reset. However, if the time between overloads is greater than thirty seconds, continuous recycling will occur.

The SW-50 employs a unique method of transmitter protection. The modulator tube may be turned off in a low level state in about five microseconds. This removes the HV from the plate of the tube, thus eliminating most faults which normally occur. The HV supply (diodes and transformer) is capable of withstanding repeated short circuits without harming the unit.

THE SERVO SYSTEM. The all solid-state servo system will automatically tune any of 10 pre-set channels in about ten seconds. Each channel is "remembered" on one plug-in card. Auxiliary switching also is provided on each pre-set channel card for antenna switching, synthesizer, programming, etc. The fast tuning time is made possible because the HV supply

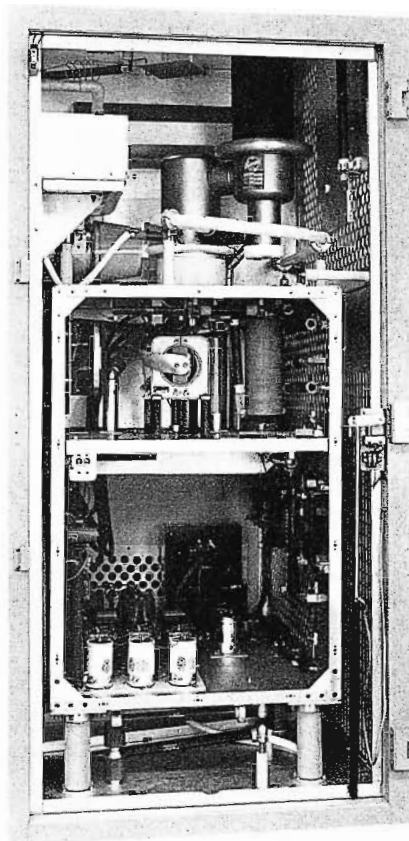

Rear view of RF isolation box showing power amplifier tube assembly and vapor phase cooling boiler.

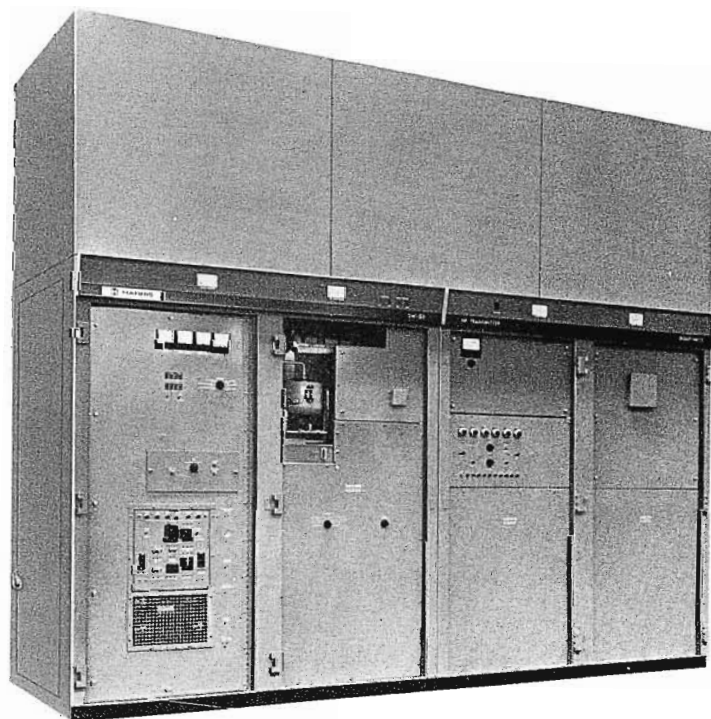

SW-50 with heat exchanger, front doors removed.

is not disabled during the tune cycle; the RF drive is turned off in a low level solid-state stage, and all tuning is done in parallel. When the tuning has been accomplished, the modulator is turned back on silently and smoothly.

VAPOR PHASE COOLING. Vapor phase cooling eliminates the need for large blowers moving high velocity air. Vapor phase cooling also extends tube life by helping to eliminate "hot spots" and maintaining anode temperatures far below those attained by other methods.

GREATLY REDUCED FLOOR SPACE. Due to the high efficiency of the transmitter and the elimination of large iron core components (no modulation transformer and reactor), the SW-50 requires only 7.0 square meters (76 square feet) of floor space. Careful cabinet design provides easy accessibility to all components.

TRANSMITTER LAYOUT. The standard layout of the transmitter consists of two cabinets, a heat exchanger designed for mounting on top of the cabinets, and an external high voltage power transformer. Front and rear doors, and meter panel are magnetically latched. External connections to the transmitter are made through the top so that floor ducts are not necessary.

Ideal for use in all types of climate, this transmitter greatly reduces the problems of cleaning and filtering of outside air. With vapor phase cooling, ducting outside air into the transmitter is not necessary. Also, the cooling system requires little attention other than maintaining the proper purity and water level in the reservoir tank.

TRAPEZOIDAL RESPONSE

Trapezoidal audio processing may be used to develop greater intelligence carrying sideband power without increasing transmitter carrier power. To do this the audio input wave (A) is flattened at the top, by clipping, then reamplified to form a trapezoidal wave (B). The shaded areas in the diagram indicate the power gain.

The desired power gain is lost, however, if this clipped, or flattened, wave tilts downward due to poor low frequency response, or is rounded out again to its original shape by sub-standard high frequency response.

The SW-50 has the capability of passing a 100 Hz 12 dB clipped wave at 100% modulation with minimum tilt or rounding of the wave.

All the additional power gained by clipping the audio input is delivered at the output of the transmitter, thus increasing volume at the receiver.

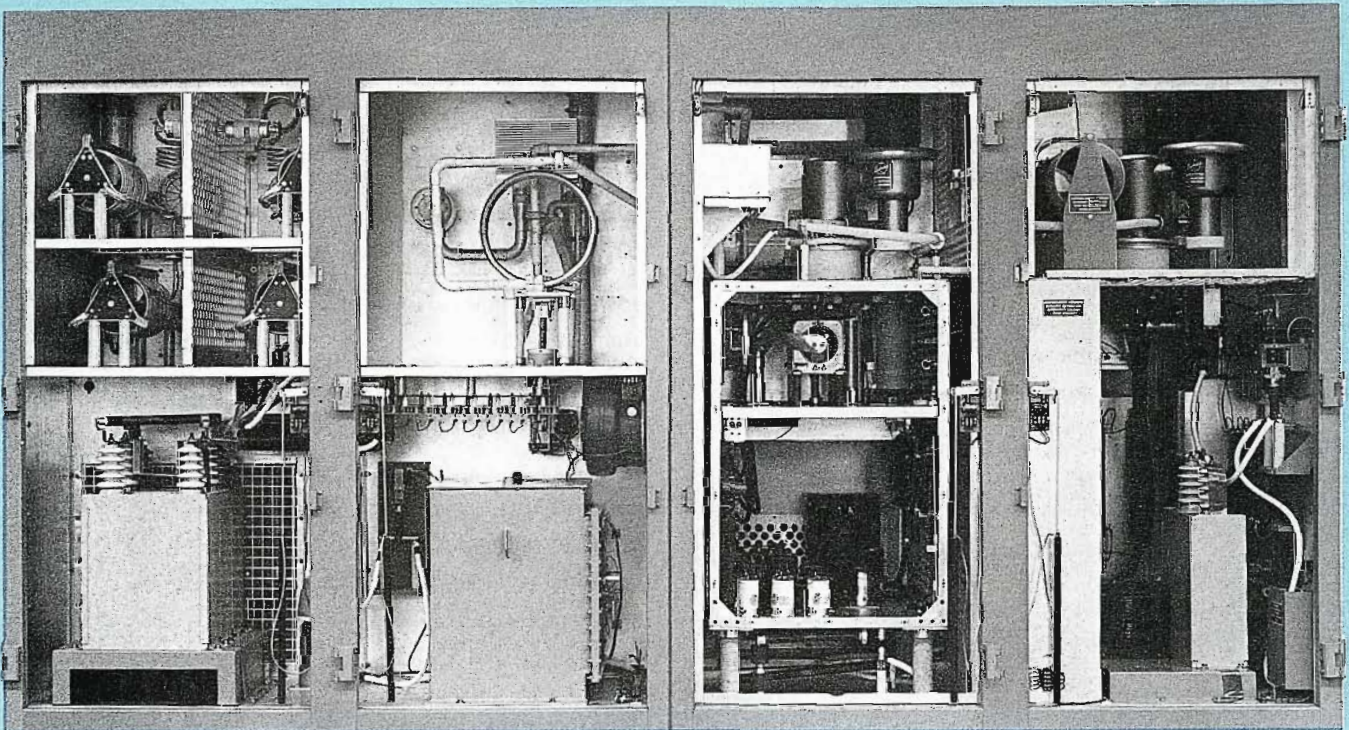
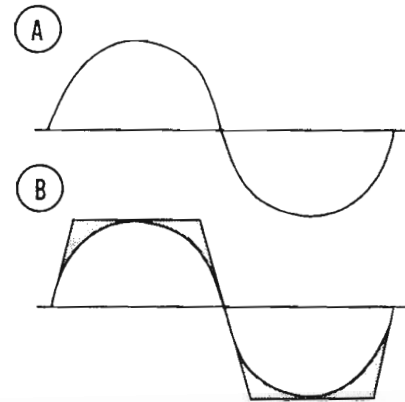

SW-50 rear view, doors off (heat exchanger not shown)

SW-50 FLOOR PLAN

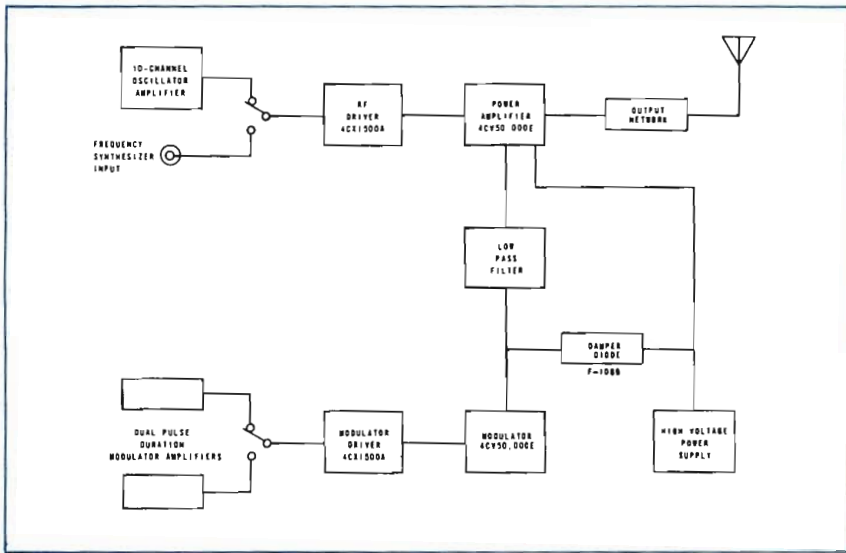
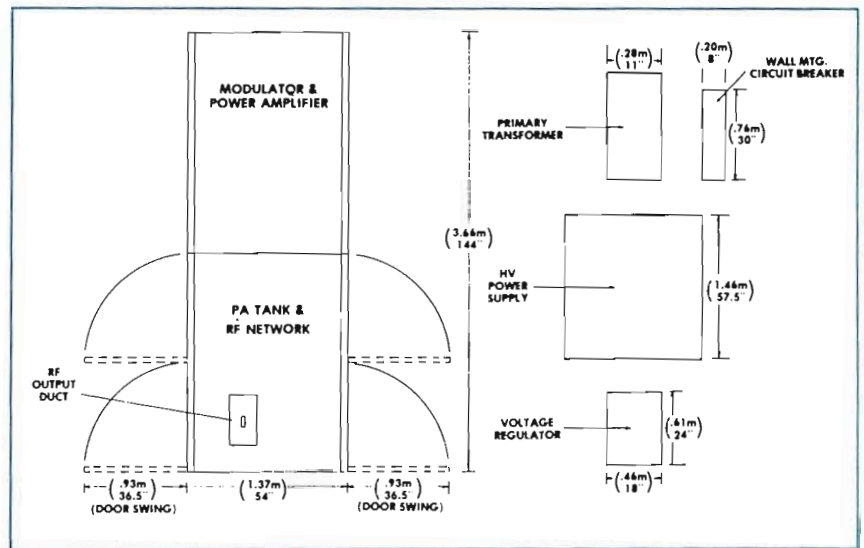

SW-50 BLOCK DIAGRAM

SW-50 SPECIFICATIONS

POWER OUTPUT: 50,000 watts nominal unmodulated; capable 55,000 watts.

RF FREQUENCY RANGE: 3.2 to 22.0 MHz.

METHOD OF TUNING: Manual, or selection of 10 pre-set channels.

RF OUTPUT IMPEDANCE: 300 ohms balanced, 1.6 to 1 maximum VSWR, others available on special order.

RF FREQUENCY STABILITY: $\pm 1 \times 10^{-6}$ (± 22 Hz at 22 MHz).

SPURIOUS AND HARMONIC EMISSION: Less than 50 mW.

CARRIER SHIFT: Less than 2% at 95% modulation, Less than 5% at 100% modulation.

AUDIO FREQUENCY RESPONSE: ± 1.5 dB from 50 to 10,000 Hz referenced to 1,000 Hz at 95% modulation.

AUDIO FREQUENCY DISTORTION: Less than 3% from 50 to 10,000 Hz at 95% modulation.

NOISE: 55 dB below 1,000 Hz, 100% modulated level.

AUDIO INPUT LEVEL: 0 dBm ± 2 dB for 100% modulation.

AUDIO INPUT IMPEDANCE: 600/150 ohms, balanced or unbalanced.

MODULATION LEVEL: 100% sinusoidal, one hour, 50-5000 Hz.

TRAPEZOIDAL MODULATION: Less than 5% tilt or overshoot, 100 Hz to 2000 Hz.

POWER INPUT: Any specified voltage 380 V to 480 V, 3 phase, 50 or 60 Hz.

POWER CONSUMPTION: 110 kW—no modulation; 114 kW—30% modulation; 145 kW—100% modulation.

POWER FACTOR: Greater than 95%.

VOLTAGE REGULATOR: Electronic voltage regulation for all power supplies other than high voltage.

OVERALL EFFICIENCY: 46% @ average modulation.

TUBES: Two—4CV50,000E; two—4CX1500A; one—F-1099.

TEMPERATURE RANGE: 0 to +50°C ambient air temperature.

HUMIDITY: 95% relative humidity, maximum.

STORAGE TEMPERATURE: -35°C to +60°C.

ALTITUDE: Up to 1829 meters (6000 feet) above sea level.

CABINET DATA: Each of two cabinets measures 1.83 meters (6 feet) wide, 1.37 meters (4.5 feet) deep, and 1.98 meters (6.5 feet) high. The heat exchanger adds another 1.06 meters (3.5 feet) in height.

ORDERING INFORMATION

SW-50,50,000 watt short wave broadcast transmitter, top-mounted heat exchanger 944-6808-005

As above, except with remote heat exchanger 944-6808-001



HARRIS
COMMUNICATION AND
INFORMATION PROCESSING

FMD-50K

50-Kilowatt
Dual FM
Broadcast
Transmitter

- Combines two 25-kilowatt amplifiers for highest reliability
- Only two tubes . . . solid-state, redundant IPAs
- High efficiency, low operating cost
- Wide RF bandwidth, minimum tunable components
- Driven by the most advanced FM exciter in the world—MS-15
- Patented DSM stereo generator . . . stereo separation 40 dB minimum, 50 dB typical
- DTR filter technique limits overshoot to 2% or less
- Solid-state control logic
- Automatic power control

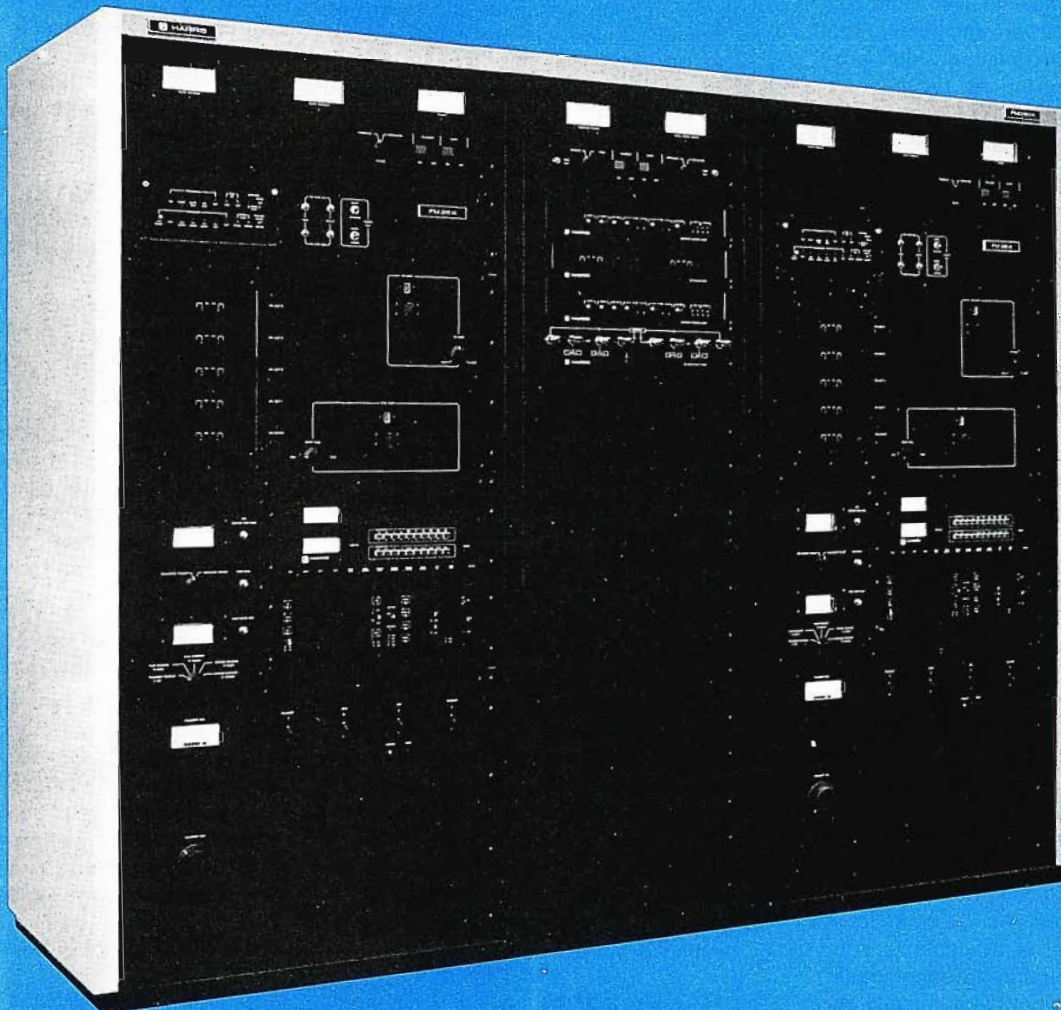

FMD-50K... dual configuration for complete redundancy

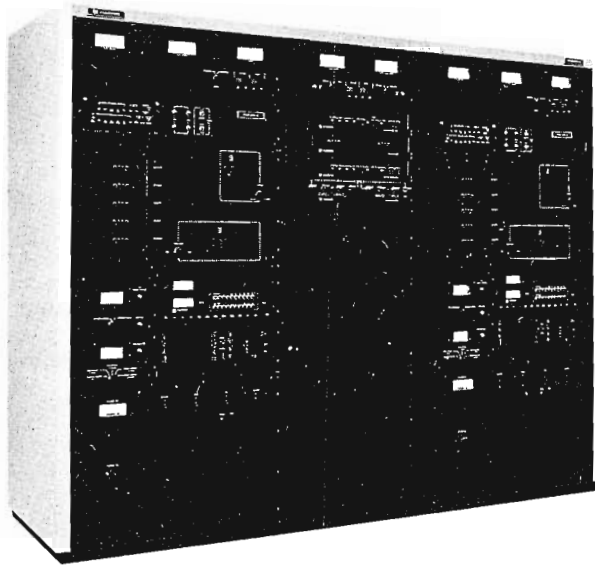

The FMD-50K dual 50-kilowatt transmitter offers real protection against off-air time through redundancy, and through extensive use of solid-state circuitry. Only two tubes are employed in the entire FMD-50K... high-gain, highly efficient 8990 tetrodes used as the final power amplifiers. The 8990 uses a wavy fin radiator which provides exceptional cooling at reduced air requirements, for quiet operation. The quarter-wave PA cavity design eliminates troublesome sliding contacts for tuning, and assures wide RF bandwidth. This results in a signal path that is transparent to the MS-15 exciter.

The **basic** FMD-50K transmitter consists of two 25-kilowatt amplifiers, and a center control cabinet. It provides redundancy in all areas except the exciters. In case emergency operation is required, you stay on the air at one-quarter normal power output. An even higher level of redundancy is achieved in the **complete** FMD-50K through an optional arrangement of switches, sensors and circuits that make the FMD-50K totally redundant from audio input to RF output.

The FMD-50K with the RF output switching option provides the capability of automatically switching either transmitter directly to the antenna, thus providing one-half normal operating power in the event of a transmitter malfunction.

With the addition of the automatic exciter switching option, automatic backup exciter protection is provided. Also, an optional RF input patch panel is available to connect either exciter directly to either transmitter by bypassing all of the automatic exciter switching equipment.

SOLID-STATE IPAs*

The redundancy of the dual FMD-50K is heightened when the IPA in each 25-kilowatt amplifier is considered. The IPA stages are multiple solid-state amplifiers combined in such a manner that failure of one amplifier stage will not cause a total loss of IPA RF power. The IPA solid-state modules in the PA are identical to those used in the booster amplifier for the MS-15. The wide use of solid-state RF power circuits means that the FMD-50K uses only two tubes!

LOW OPERATING COST

With today's mounting energy costs, transmitter efficiency must be a major consideration in any purchase. 77% efficiency in the final power amplifiers, high efficiency in all amplifier circuits, and conservatively rated components result in comparatively low power consumption and low operating stress on heat generating components in the FMD-50K. This adds up to very impressive savings in operating and maintenance costs.

FINEST STEREO PERFORMANCE

Featuring the advanced-design MS-15 exciter, Harris' FMD-50K provides the cleanest and the loudest stereo signal of any 50-kilowatt FM transmitter available today. The DSM (Digitally Synthesized Modulation) stereo generator allows the transmitter to provide stereo separation of 40 dB minimum (50 dB typical), 30-15,000 Hz—while the DTR (Dynamic Transient Response) filter permits a 2 to 6 dB increase in loudness, with no degradation of audio quality, by limiting overshoot to 2% or less.

The FMD-50K may be equipped for mono or stereo operation, with or without SCA.

... only two tubes

The design versatility of the MS-15 exciter allows you to order mono operation originally, then add stereo and/or SCA at a later date by plugging the appropriate module(s) into the exciter. The FMD-50K is equipped for wideband composite input in its standard configuration.

AUTOMATIC POWER CONTROL

The FMD-50K automatically monitors power output, and maintains the output at the desired level. This standard feature insures against out-of-tolerance power conditions. Furthermore, the power set point can be remotely adjusted independently of the limit points to allow operator control of power output. During maintenance periods, the automatic power control may be switched off.

VSWR PROTECTION

VSWR protection is mandatory in any high-power transmitter—therefore, Harris has incorporated this as a standard feature in the FMD-50K. A high VSWR condition will cause the transmitter to recycle... if three overloads occur within a given time period, the transmitter will shut down until manually restarted. The transmitter may also be programmed for single VSWR overload shutdown.

CONTROL CIRCUITRY

The FMD-50K is controlled by solid-state logic circuitry. The logic circuitry not only controls basic On/Off functions, but also monitors critical stages for overload conditions. Should an overload occur, the transmitter will recycle automatically.

The control logic used in the FMD-50K interfaces directly with most remote control systems, eliminating the need for an additional remote control interface. The control signals are momentary low current contacts. The transmitter output parameters are buffered, and all status indicators can be remoted.

METERING AND VISUAL AIDS

Major functions, including combined output power, VSWR and reject load power are displayed on easy-to-read 4-inch meters in the center cabinet. Complete monitoring of operating functions of the individual 25-kilowatt amplifiers are also displayed. Low-level parameters of each amplifier are displayed on a multimeter, and IPA RF output and reflected power are indicated on another meter. Filament voltage is measured by a true RMS circuit.

The FMD-50K provides a variety of indicators as troubleshooting aids and quick

references. These include illuminated On/Off pushbuttons and numerous LED status indicators.

HV POWER SUPPLIES

The two high voltage power supplies are housed in separate cabinets, and provide the plate and screen voltage. The conservatively-rated three-phase plate supplies use silicon rectifiers with AC line transient protection.

COMPACT SIZE

The trim FMD-50K cabinet configuration measures only 90.2" wide, 72" high and

30.5" deep. Additionally, the HV power supplies may be located in any convenient spots remote from the PA cabinets.

GENERAL

There are many other operational and convenience features incorporated into the FMD-50K. These include:

Line Loss Protection—Built-in protection against total AC failure and loss of phase is provided. The FMD-50K will restart automatically following a total power failure, while loss of a single phase will shut down the transmitter.

High Altitude Rating—High capacity, direct-drive blowers deliver sufficient air to cool the transmitter at altitudes up to 10,000 feet (3048 meters).

Additional Protection — Magnetic circuit breakers are utilized to protect the blower motors, the filament supplies, the IPA supplies and the bias supplies. A safety interlock system and a drop solenoid system discharge power supplies to safe levels.

Automatic Transmitter System Compatibility—The simple control logic interface and full metering in the FMD-50K permit ATS operation.

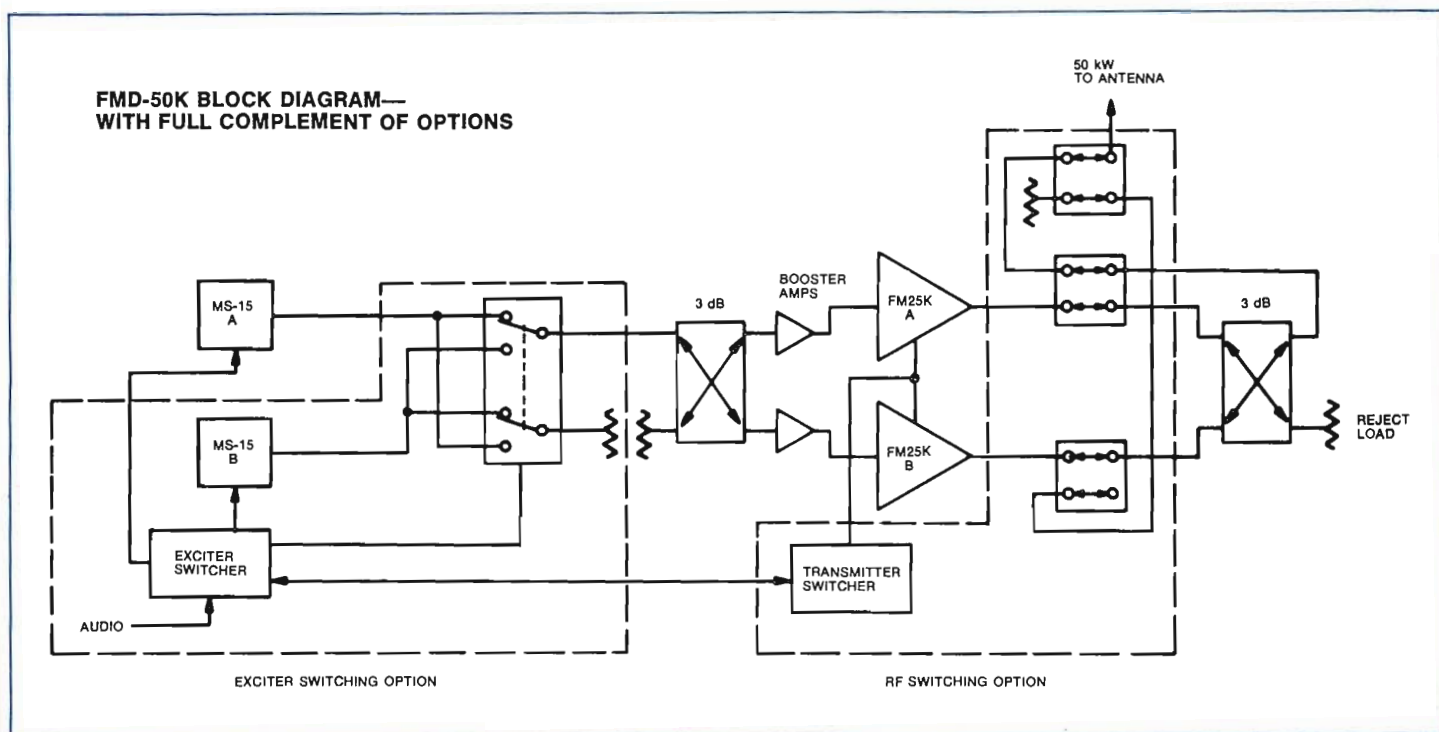

HARRIS' FMD-50K DUAL FM TRANSMITTER CONFIGURATIONS

BASIC FMD-50K DUAL SYSTEM

- Two FM-25K transmitters, less exciters.
- One MS-15 exciter.
- One dual RF booster amplifier with low power hybrid coupler and reject load.
- One 19-inch center cabinet with control and metering circuitry.
- One high power hybrid coupler with interconnecting transmission line components.
- One 12.5-kilowatt reject load.

FMD-50K WITH AUTOMATIC RF OUTPUT SWITCHING

- Two FM-25K transmitters, less exciters.

- One MS-15 exciter.
- One dual RF booster amplifier with low power hybrid coupler and reject load.
- One 19-inch center cabinet with control metering and RF control logic assembly.
- One floor-mounted frame assembly with three high power coaxial switches, one high power hybrid combiner, and one 12.5-kilowatt reject load.
- All necessary interconnecting transmission line components.

OPTIONAL AUTOMATIC EXCITER SWITCHING

- One automatic RF control logic assembly.

- One coaxial transfer switch.
- One test load for exciter.
- All necessary cabling for system interconnect.
- (Requires second exciter, which is not included in this option package).

ADDITIONAL OPTIONS FOR FMD-50K

- Mono generator(s).
- Stereo generator(s).
- SCA generator(s).
- RF input manual patch panel for use with exciter switching option.
- 80-kilowatt water-cooled test load.
- Heat exchanger for test load.

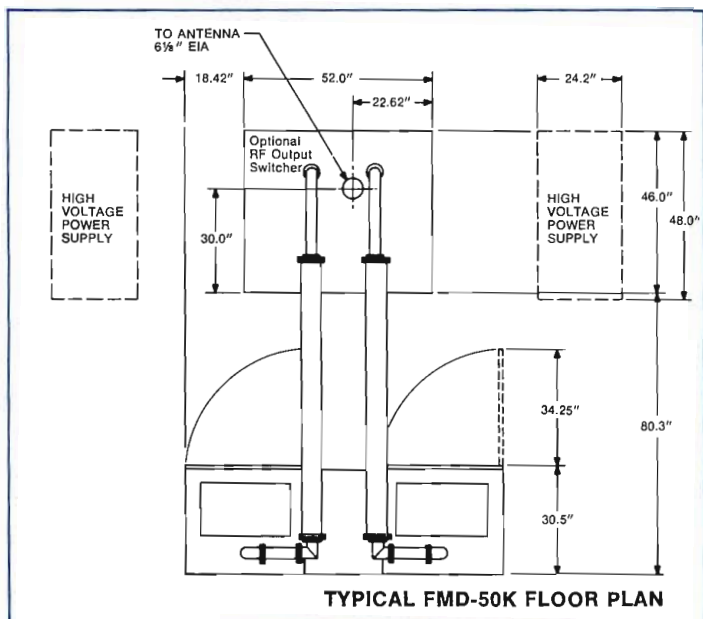

FMD-50K SPECIFICATIONS

GENERAL

POWER OUTPUT: 20 kW to 50 kW.
FREQUENCY RANGE: 87.5 to 108 MHz, tuned to specified operating frequency.
RF OUTPUT IMPEDANCE: 50 ohms.
OUTPUT TERMINATION: 6 1/2" EIA flange.
FREQUENCY STABILITY: ± 300 Hz 0° to 45° C TXCO.
TYPE OF MODULATION: Direct Carrier Frequency Modulation.
MODULATION CAPABILITY: ± 100 kHz.
AC INPUT POWER: 208/240 V, 3-phase, 50/60 Hz. 360/415 V, 3-phase, 50/60 Hz. Power consumption: 80,000 watts (approx.). 115 V as available.
RF HARMONICS: Suppression meets all FCC requirements.
ALTITUDE: 10,000 feet (3048 meters).
AMBIENT TEMPERATURE RANGE: -20° C to $+45^\circ$ C (-4° to $+113^\circ$ F).
MAXIMUM VSWR: 1.7 to 1.
SIZE: Transmitter: 90.2"W (229 cm) x 72"H (183 cm) x 30.5"D (77.5 cm). HV power supply cabinets: (each) 48"W (122 cm) x 60.2"H (153 cm) x 24.2"D (61.5 cm).
FINISH: White, blue and black.
WEIGHT AND CUBAGE (Approximate): Export: 7000 lbs. (3178 kg). Domestic: 6800 lbs. (3087 kg). Cubage: 400 cubic feet (11.3 cubic meters).

MONAURAL MODE

AUDIO INPUT IMPEDANCE: 600 ohms balanced, resistive, adaptable to other impedances.
INPUT FILTER: Controlled response LPF, defeatable.
AUDIO INPUT LEVEL: $+10$ dBm ± 1 dB for 100% modulation at 400 Hz.
AUDIO FREQUENCY RESPONSE: Standard 75 microsecond FCC pre-emphasis curve ± 0.5 dB, 30-15,000 Hz. Selectable: flat, 25 or 50 microsecond pre-emphasis.

HARMONIC DISTORTION: 0.2% or less, 30-15,000 Hz.
IMD: 0.2%, 60/7000 Hz, 4:1 ratio.
FM NOISE: 68 dB below 100% modulation (ref. 400 Hz @ ± 75 kHz deviation).
AM NOISE: 50 dB below reference carrier AM modulation 100%.
STEREOPHONIC MODE
TYPE OF MODULATION: Digitally Synthesized Modulation (DSM).
AUDIO INPUT IMPEDANCE: (left and right) 600 ohms balanced, resistive. Adaptable to other impedances.
AUDIO INPUT LEVEL: (left and right) $+10$ dBm ± 1 dB for 100% modulation at 400 Hz.
AUDIO FREQUENCY RESPONSE: (left and right) standard 75 microsecond, FCC pre-emphasis curve ± 0.5 dB 30-15,000 Hz. Selectable: flat, 25 or 50 microsecond pre-emphasis.
INPUT FILTERING: 15 kHz LPF, 45 dB rejection at 19 kHz.
OVERSHOOT PROTECTION: Dynamic transient response (DTR) filter.
AUDIO TRANSIENT RESPONSE: 2% maximum overshoot beyond steady state. Defeatable for test purposes.
HARMONIC DISTORTION: (left or right) 0.4% or less, 30-15,000 Hz.
IMD: 0.4%, 60/7000 Hz, 4:1 ratio.
FM NOISE: (left or right) 65 dB minimum below 100% modulation. Reference: 400 Hz, 75 microsecond de-emphasis, ± 75 kHz deviation.
PILOT OSCILLATOR: Crystal controlled.
PILOT STABILITY: 19 kHz ± 1 Hz, 0° to 45° C.
PILOT PHASE: Automatically controlled.
STEREO SEPARATION: 40 dB minimum 30-15,000 Hz.
CROSSTALK: (main to stereo sub-channel or stereo sub-to main channel) 45 dB below 90% modulation.
SUB CARRIER SUPPRESSION: 50 dB below 90% modulation.
76 kHz SUPPRESSION: 60 dB minimum below 100% modulation.
MODES: Stereo, mono (L + R), mono (L), mono (R). Remoteable.

SCA SPECIFICATIONS

MODULATION: Direct FM.
FREQUENCY: 41 or 67 kHz programable, any frequency between 25 and 75 kHz on special order.
FREQUENCY STABILITY: ± 500 Hz.
MODULATION CAPABILITY: ± 7.5 kHz.
AUDIO INPUT IMPEDANCE: 600 ohms balanced (AC coupled) and 2000 ohms unbalanced (DC coupled).
AUDIO INPUT LEVEL: $+10$ dBm, ± 1 dB for 100% modulation at 400 Hz.
AUDIO FREQUENCY RESPONSE: 41 kHz and 67 kHz, 150 microsecond pre-emphasis ± 1 dB, standard. Selectable: flat, 50 or 75 microsecond pre-emphasis.
INPUT FILTERING: Programable LPF, 4.5 kHz standard.
DISTORTION: Less than 1%, 30-5000 Hz. ± 5 kHz deviation.
FM NOISE: (main channel not modulated) 55 dB minimum (ref: 100% = ± 5 kHz deviation at 400 Hz).
CROSSTALK: (SCA to main or stereo sub-channel): -60 dB or better.
CROSSTALK: (main or stereo sub-channel to SCA): 50 dB below ± 5 kHz deviation of SCA, with mono or stereo channels modulated by frequencies 30-15,000 Hz, SCA demodulated with 150 microsecond de-emphasis.
CROSSTALK: SCA to SCA (41 kHz/67 kHz) 50 dB demodulated with 150 microsecond de-emphasis.
AUTOMATIC MUTE LEVEL: Variable from 0 to -30 dBm.
MUTE DELAY: Adjustable 0.5 to 20 seconds.
INJECTION LEVEL: 1% to 30% of composite. Adjustable.

WIDEBAND MODE

INPUT IMPEDANCE: Greater than 5000 ohms resistive, unbalanced.
INPUT LEVEL: 1.0 VRMS nominal for ± 75 kHz deviation.
AMPLITUDE RESPONSE: ± 0.25 dB, 30 Hz to 75 kHz.
PHASE LINEARITY: $\pm 2^\circ$, 30 Hz to 75 kHz.

SPECIFICATIONS SUBJECT TO CHANGE WITHOUT NOTICE.

ORDERING INFORMATION

FMD-50K, dual 50-kilowatt FM transmitter, with automatic RF output switching, for wideband operation	994-8455-001
FMD-50K, dual 50-kilowatt FM transmitter, basic system, for wideband operation	994-8455-002
Automatic exciter switching option (does not include second exciter)	994-8456-001
MS-15 exciter (does not include generator modules)	994-7950-002
Monaural generator (add for mono operation)	994-8019-001
DSM stereo generator with DTR (add for stereo operation)	994-8020-001
SCA generator (add for SCA operation, specify 41 or 67 kHz)	994-7992-001
RF input patch panel	994-8473-001
80-kilowatt water-cooled test load	700-0121-000
Heat exchanger for test load	432-0257-000



HARRIS
COMMUNICATION AND
INFORMATION PROCESSING

FM-40K

40-Kilowatt FM Broadcast Transmitter

- Combines two 20-kilowatt amplifiers for highest reliability
- Solid-state Maximum Signal Exciter—MS-15
- Patented DSM (Digitally Synthesized Modulation) stereo generator provides separation exceeding accurate measurement capability of most monitors
- DTR (Dynamic Transient Response) filter technique limits overshoot to 2% or less, permitting a 2 to 6 dB increase in loudness with no audio quality degradation
- Lowest operating cost
- Stable, easy output tuning
- Built-in connections for remote control
- Automatic recycling
- Full metering
- Plug-in mono, stereo and SCA generators



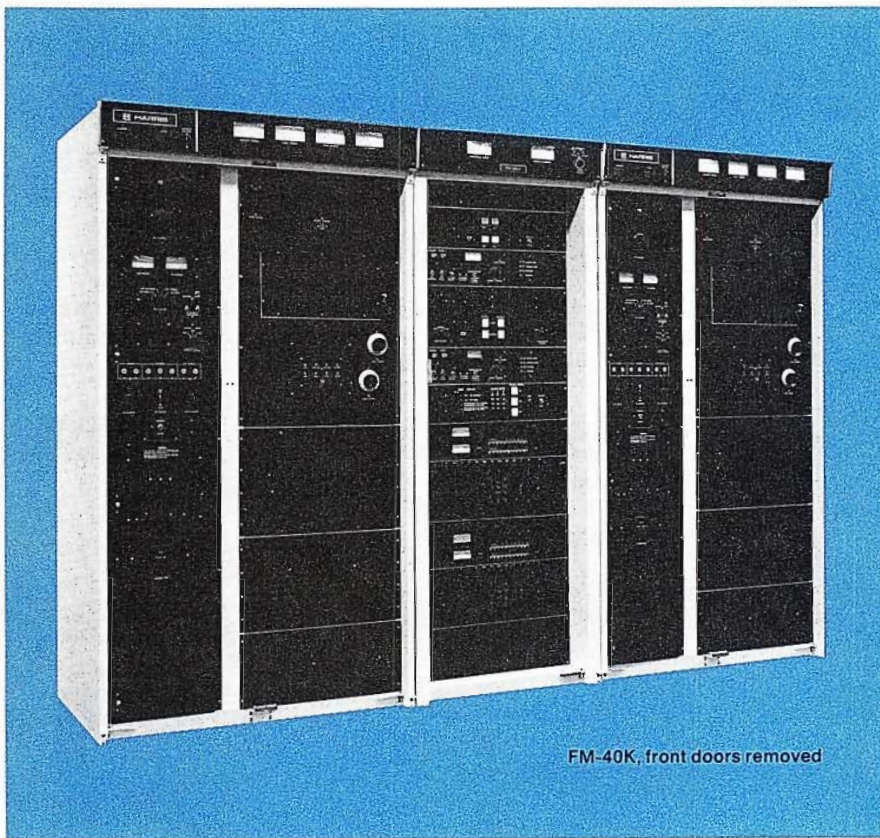

FM-40K, front doors removed

Reliability through redundancy—that's the story on Harris' FM-40K, 40-kilowatt transmitter.

The **basic** FM-40K transmitter system consists of two 20-kilowatt amplifiers, and a center control cabinet containing the MS-15 exciter—and provides redundancy in all areas except the exciter and isolation amplifier. In case emergency operation is required, you stay on the air at one-quarter normal power output.

The **complete** 40-kilowatt FM transmitter system includes an optional Automatic Exciter Switching Kit and RF Output Switching Kit—and provides total redundancy! Should a malfunction occur anywhere in the system, you are still on the air at one-half normal power!

In the basic system, outputs of each amplifier are coupled through harmonic filters to the output combining network. This hybrid network sums the two 20-kilowatt signals to produce a 40-kilowatt output to the transmission line. However, the two amplifiers remain isolated from each other.

With the addition of the Automatic Exciter Switching Kit, automatic backup exciter protection is provided. And with the further addition of the RF Output Switching System, power output becomes one-half the normal output during emergency operation. Either or both of these options may be included in the FM-40K at the time you order—or added later in the field.

FINEST STEREO PERFORMANCE

Featuring the advanced-design MS-15 exciter, Harris' FM-40K provides the cleanest and the loudest stereo signal of any 40-kilowatt FM transmitter available today. The DSM (Digitally Synthesized Modulation) stereo generator allows the transmitter to provide **stereo separation of 40 dB minimum (50 dB typical)**, 30-15,000 Hz—while the DTR (Dynamic Transient Response) filter permits a **2 to 6 dB increase in loudness**, with no degradation of audio quality, by limiting overshoot to 2% or less.

The FM-40K may be equipped for mono or stereo operation, with or without SCA. The design versatility of the MS-15 exciter allows you to order for mono operation originally, then add stereo and/or SCA at a later date by plugging the appropriate module(s) into the exciter.

LOWEST OPERATING COST

In the FM-40K, each of the 20-kilowatt amplifiers operates at **80% efficiency** or better. Add to this conservatively rated components and you have the lowest operating cost of any FM transmitter in the 40-kilowatt power range. The 4CX15,000A output tube in each 20-kilowatt amplifier assures excellent performance—and runs

at only one-third its dissipation rating for maximum service life.

VARI-LINE SILVER-PLATED TANK

Vari-Line is an advanced, Harris-developed method of tuning a single-ended FM amplifier for optimum output efficiency. A portion of a parallel tubular 2- $\frac{5}{8}$ -inch copper transmission line (silver plated for efficient RF service) is made variable in order to inductively tune the line to operating frequency. This reduces the complexity of sliding contacts and consequent maintenance problems.

With Vari-Line tuning, greater reliability is possible. Mica capacitors are not used in the tank circuit.

DUAL HV SILICON POWER SUPPLIES

Two separate three-phase HV power supplies are used for each 20-kilowatt amplifier. With each amplifier one HV supply—for PA plate voltage—is housed in a separate enclosure; the other supply, which powers the IPA plate and screen circuit, and the PA screen, is housed in the amplifier cabinet.

The FM-40K employs a special power supply protective circuit to assure that transient voltages or on-off power surges will not damage the power transformer and related components.

AUTOMATIC RECYCLING

In case of momentary overload, the transmitter recycles automatically. Should the overload reoccur in excess of the number of times preset in the transmitter, the FM-40K will then remain off the air until reset, either locally or by remote control.

TESTING

Environmental tests, in conditions surpassing those of any location a transmitter is likely to encounter, have been imposed on the FM-40K. The transmitter is capable of operating at altitudes up to 7500 feet (2286 meters), in an ambient temperature range of -20° to $+45^{\circ}$ C (-4° to $+113^{\circ}$ F).

In addition, your FM-40K is fully tuned and operationally tested on your frequency before shipment.

REMOTE CONTROL

All connections for remote control are built

in—just connect the FM-40K to a transmitter control unit, and you are ready for remote operation. No additional equipment is required.

GENERAL

There are many other operational and convenience features incorporated into the FM-40K. These include:

PUSHBUTTON OPERATION. Daily operation of the FM-40K is simple, with on-off

functions controlled by lighted pushbuttons, which are clearly marked "Filament On-Off" and "Plate On-Off".

HIGH CAPACITY BLOWERS. (one in each 20-kilowatt amplifier). Backed up by precision air-pressure switches, these blowers provide complete protection to the IPA and PA tubes.

EASE OF MAINTENANCE. The FM-40K is designed to allow quick accessibility to all

components for easier maintenance and troubleshooting.

HANDSOME STYLING. Transmitter cabinets are attractively yet functionally styled, with double front doors on each 20-kilowatt amplifier. The finish is white, blue and black.

TYPE ACCEPTANCE. Harris' FM-40K is FCC type accepted for mono, stereo and SCA broadcasting in the 87.5 to 108 MHz band.

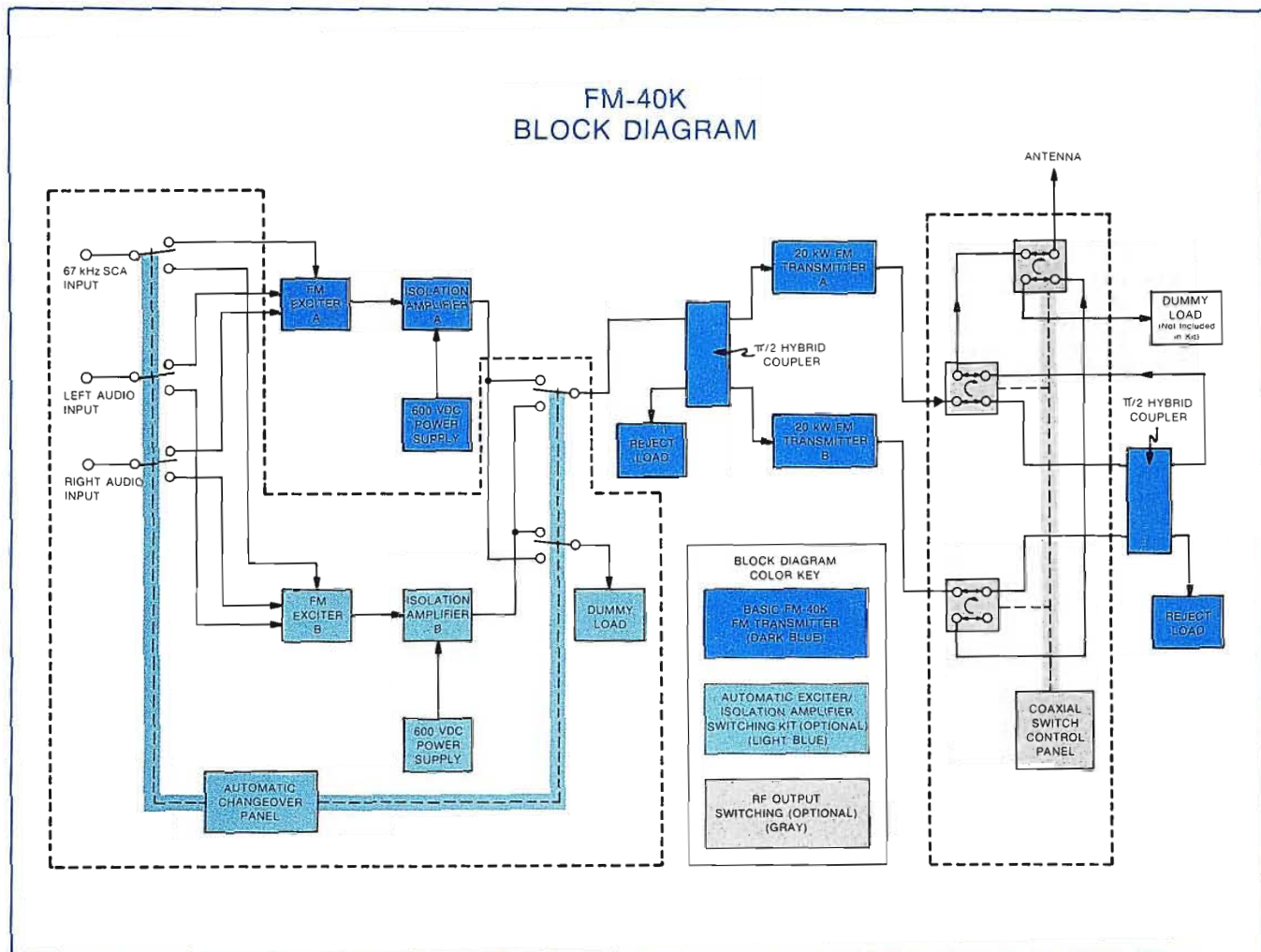

HARRIS' FM-40K FM TRANSMITTER CONFIGURATIONS

Basic Dual System

- Two FM-20K transmitters, less exciters
- One MS-15 exciter
- One isolation amplifier with power supply
- One center cabinet
- One high-power hybrid coupler (combiner) with plumbing to interconnect two transmitters
- One low-power hybrid coupler
- One 10-kilowatt reject load
- One 50-watt reject load

Automatic Exciter/Isolation Amplifier Switching Kit (Optional)

For exciter redundancy, the following ad-

ditional equipment (included in this kit) should be added to the basic system:

- One MS-15 exciter
- One isolation amplifier with power supply
- One test load for exciter
- One automatic changeover contact panel (mounts in center cabinet)

RF Output Switching (Optional)

For RF switching of the high-power output amplifiers, the following equipment (included in this kit) should be added to the basic system:

- One control panel (mounts in center cabinet)

- Three coaxial transfer switches
- One kit consisting of rigid coaxial line, elbows and flanges
- One 50-kilowatt test load required (not included in kit)

Optional Equipment For FM-40K

- Mono generator module
- Stereo generator module
- SCA generator module(s)
- VSWR overload protection for each 20-kilowatt amplifier
- Status light system for each 20-kilowatt amplifier
- 50-kilowatt air-cooled load
- 50-kilowatt water-cooled load

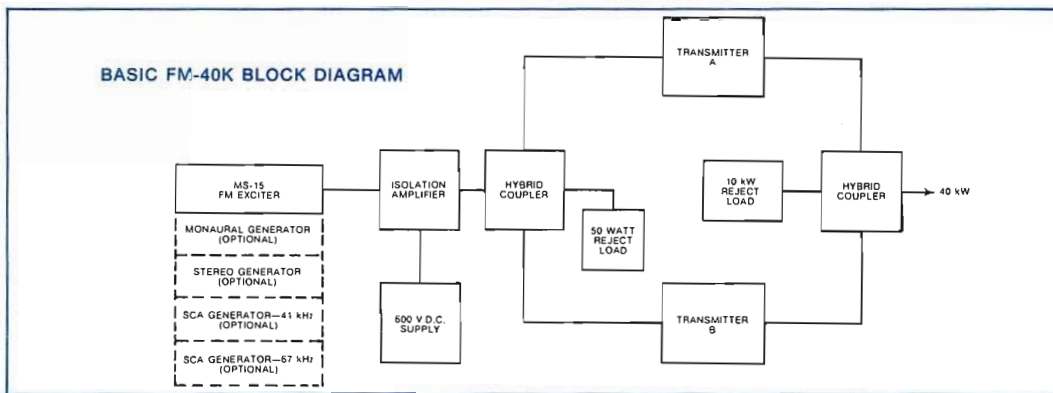

FM-40K SPECIFICATIONS

GENERAL

POWER OUTPUT: 20 kW to 40 kW.
FREQUENCY RANGE: 87.5 to 108 MHz, tuned to specified operating frequency.
RF OUTPUT IMPEDANCE: 50 ohms.
OUTPUT TERMINATION: 3/4" EIA flange.
FREQUENCY STABILITY: ± 300 Hz 0° to 45° C TCXO.
TYPE OF MODULATION: Direct Carrier Frequency Modulation.
MODULATION CAPABILITY: ± 100 kHz.
AC INPUT POWER: 208/240 V, 3-phase, 60 Hz. (50 Hz available on special order.) Power consumption: 60,000 watts (approx.). 115/230 V, 60 or 50 Hz, 150 watts for MS-15.
RF HARMONICS: Suppression meets all FCC requirements.
ALTITUDE: 7500 feet (2286 meters).
AMBIENT TEMPERATURE RANGE: -20° C to $+45^\circ$ C (-4° to $+113^\circ$ F).
MAXIMUM VSWR: 1.7 to 1.
SIZE: Transmitter: 113"W (287cm) x 78"H (198cm) x 33"D (84cm). HV power supply cabinets (2): each 30"W (76cm) x 49"H (125cm) x 30"D (76cm).
FRONT DOOR SWING: 21" (53cm).
FINISH: White, blue and black.
WEIGHT AND CUBAGE: Export: 6800 lbs. (3087 kg). Domestic: 6000 lbs. (2724 kg). 270 cubic feet (7.5 cubic meters).

MONAURAL MODE

AUDIO INPUT IMPEDANCE: 600 ohms balanced, resistive, adaptable to other impedances.
INPUT FILTER: Controlled response LPF, defeatable.
AUDIO INPUT LEVEL: $+10$ dBm ± 1 dB for 100% modulation at 400 Hz.
AUDIO FREQUENCY RESPONSE: Standard 75 microsecond FCC pre-emphasis curve ± 0.5 dB, 30-15,000 Hz. Selectable: flat, 25 or 50 microsecond pre-emphasis.
HARMONIC DISTORTION: 0.2% or less, 30-15,000 Hz.
IMD: 0.2%, 60/7000 Hz, 4:1 ratio.
FM NOISE: 68 dB below 100% modulation (ref. 400 Hz @ ± 75 kHz deviation).
AM NOISE: 50 dB below reference carrier AM modulation 100%.

STEREOPHONIC MODE

TYPE OF MODULATION: Digitally Synthesized Modulation (DSM).
AUDIO INPUT IMPEDANCE: (left and right) 600 ohms balanced, resistive. Adaptable to other impedances.
AUDIO INPUT LEVEL: (left and right) $+10$ dBm ± 1 dB for 100% modulation at 400 Hz.
AUDIO FREQUENCY RESPONSE: (left and right) Standard 75 microsecond, FCC pre-emphasis curve ± 0.5 dB 30-15,000 Hz. Selectable: flat, 25 or 50 microsecond pre-emphasis.
INPUT FILTERING: 15 kHz LPF, 45 dB rejection at 19 kHz.

OVERSHOOT PROTECTION: Dynamic transient response (DTR) filter.
AUDIO TRANSIENT RESPONSE: 2% maximum overshoot beyond steady state. Defeatable for test purposes.
HARMONIC DISTORTION: (left or right) 0.4% or less, 30-15,000 Hz.
IMD: 0.4%, 60/7000 Hz, 4:1 ratio.
FM NOISE: (left or right) 65 dB minimum below 100% modulation. Reference: 400 Hz, 75 microsecond de-emphasis, ± 75 kHz deviation.
PILOT OSCILLATOR: Crystal controlled.
PILOT STABILITY: 19 kHz ± 1 Hz, 0° to 45° C.
PILOT PHASE: Automatically controlled.
STEREO SEPARATION: 40 dB minimum 30-15,000 Hz.
CROSSTALK: (main to stereo sub-channel or stereo sub-to main channel) 45 dB below 90% modulation.
SUB CARRIER SUPPRESSION: 50 dB below 90% modulation.
76 kHz SUPPRESSION: 60 dB minimum below 100% modulation.
MODES: Stereo, mono (L + R), mono (L), mono (R). Remoteable.

SCA SPECIFICATIONS

MODULATION: Direct FM.
FREQUENCY: 41 or 67 kHz programable, any frequency between 25 and 75 kHz on special order.
FREQUENCY STABILITY: ± 500 Hz.
MODULATION CAPABILITY: ± 7.5 kHz.
AUDIO INPUT IMPEDANCE: 600 ohms balanced (AC coupled) and 2000 ohms unbalanced (DC coupled).
AUDIO INPUT LEVEL: $+10$ dBm ± 1 dB for 100% modulation at 400 Hz.
AUDIO FREQUENCY RESPONSE: 41 kHz and 67 kHz, 150 microsecond pre-emphasis ± 1 dB, standard. Selectable: flat, 50 or 75 microsecond pre-emphasis.
INPUT FILTERING: Programable LPF, 4.5 kHz standard.
DISTORTION: Less than 1%, 30-5000 Hz. ± 5 kHz deviation.
FM NOISE: (main channel not modulated) 55 dB minimum (ref: 100% = ± 5 kHz deviation at 400 Hz).
CROSSTALK: (SCA to main or stereo sub-channel): -60 dB or better.
CROSSTALK: (main or stereo sub-channel to SCA): 50 dB below ± 5 kHz deviation of SCA, with mono or stereo channels modulated by frequencies 30-15,000 Hz, SCA demodulated with 150 microsecond de-emphasis.
CROSSTALK: SCA to SCA (41 kHz/67 kHz) 50 dB demodulated with 150 microsecond de-emphasis.
AUTOMATIC MUTE LEVEL: Variable from 0 to -30 dBm.
MUTE DELAY: Adjustable 0.5 to 20 seconds.
INJECTION LEVEL: 1% to 30% of composite. Adjustable.

WIDEBAND MODE

INPUT IMPEDANCE: Greater than 5000 ohms resistive, unbalanced.
INPUT LEVEL: 1.0 VRMS nominal for ± 75 kHz deviation.
AMPLITUDE RESPONSE: ± 0.25 dB, 30 Hz to 75 kHz.
PHASE LINEARITY: $\pm 2^\circ$, 30 Hz to 75 kHz.

SPECIFICATIONS SUBJECT TO CHANGE WITHOUT NOTICE.

ORDERING INFORMATION

FM-40K, 40-kilowatt FM transmitter, basic system, for wideband operation, 60 Hz	994-8053-001
Automatic exciter/isolation amplifier switching kit	994-6876-001
RF output switching package	994-6877-001
Monaural generator (add for mono operation)	994-8019-001
DSM stereo generator with DTR (add for stereo operation)	994-8020-001
SCA generator (add for SCA operation, specify 41 or 67 kHz)	994-7992-001
VSWR interlock unit (two required for FM-40K)	994-7004-001
Status light system (two required for FM-40K)	994-7108-001
50-kilowatt air-cooled test load	700-0317-000
50-kilowatt water-cooled test load	700-0239-000



HARRIS
COMMUNICATION AND
INFORMATION PROCESSING

FM-25K

25-Kilowatt
FM Broadcast
Transmitter

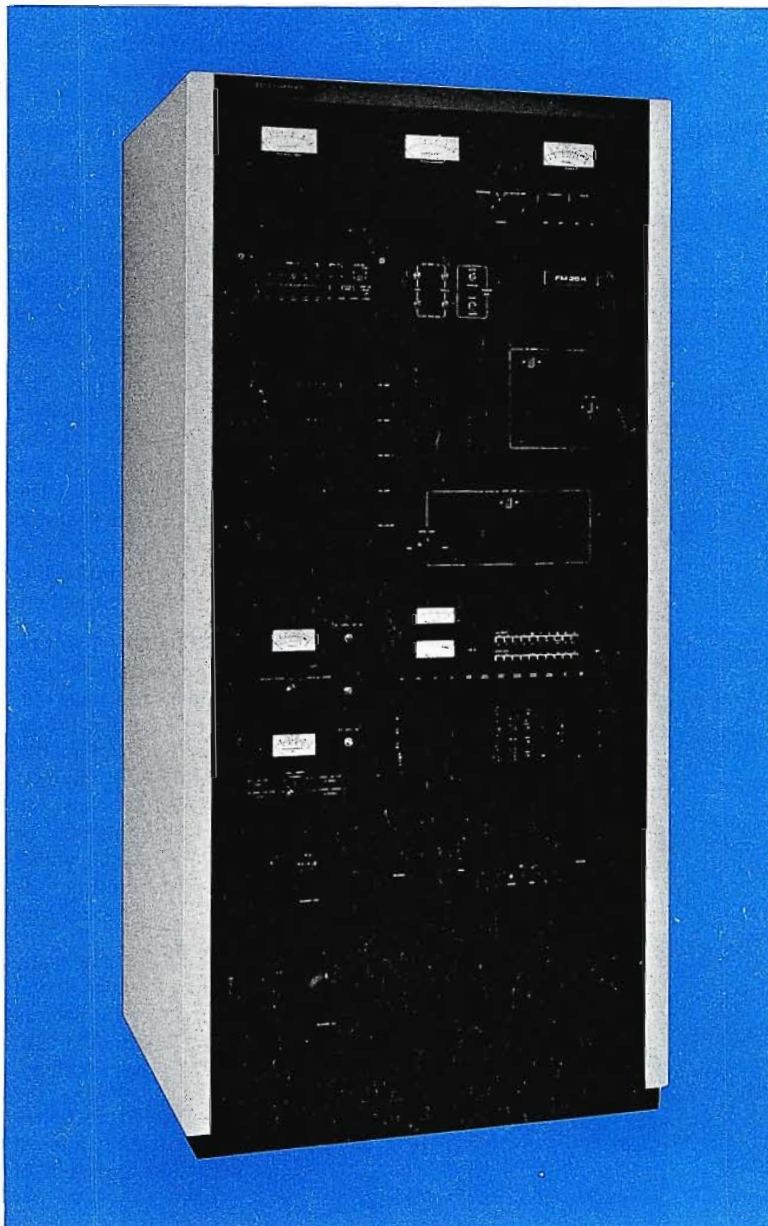

- First one-tube high-power FM transmitter
- High efficiency, low operating cost
- Solid-state, redundant IPA
- Wide RF bandwidth, minimum tunable components
- Driven by the most advanced FM exciter in the world—MS-15
- Patented DSM stereo generator . . . stereo separation 40 dB minimum, 50 dB typical
- DTR filter technique limits overshoot to 2% or less
- Solid-state control logic
- Automatic power control standard

Harris' technology has combined advances in both tube and transistor designs, to bring you a major step forward in high-power FM transmitters. Transistors are now available which provide 50 watts of RF power at reasonable gain and low junction temperatures. By combining several of these transistors in wideband RF circuits, enough power can be generated to drive an advanced high-gain Eimac tetrode tube, the 8990. This tube, when grid driven in a grounded cathode, quarter-wave cavity, can produce 25 kilowatts with 350 watts of drive at nearly 80% plate efficiency!

The FM-25K, twenty-five kilowatt FM transmitter reflects Harris' design philosophy that FM transmitters should deliver RF power efficiently, should not limit exciter performance, and should integrate dependable solid-state control logic. In the FM-25K, these features are teamed with efficient, single-tube design, and with the world's most advanced exciter—the MS-15.

The FM-25K was designed for applications with tower limitations or specific coverage requirements. The higher RF power output reduces the number of antenna bays required for a given ERP; and fewer bays mean a reduction in windloading and mounting area, so that tower size and/or height may be reduced. Also, fewer antenna bays, with less gain, can mean improved close-in coverage and the elimination of null fills.

SINGLE TUBE DESIGN. The FM-25K is the first high-power FM transmitter to utilize a single-tube design. A high-gain, highly efficient 8990 tetrode is the only tube in the entire transmitter, and is used as the final power amplifier. The tube uses a

Harris' FM-25K

wavy fin radiator which provides exceptional cooling at reduced air requirements, for quiet operation. The quarter-wave PA cavity design eliminates troublesome sliding contacts for tuning, and assures wide RF bandwidth. This results in a signal path that is transparent to the MS-15 exciter.

SOLID-STATE IPA. Five solid-state power amplifier modules (2 amplifiers per module) are combined to produce 350 watts of drive power, with plenty of reserve. One module functions as the IPA driver, and the other four as driver power amplifiers. All of these modules are identical, so that in case the IPA driver should fail, one of the power amplifier modules may be inserted in its place. Loss of one of the four driver amplifier modules will not result in an off-air condition, as these solid-state amplifiers are isolated from each other. All five solid-state amplifier modules are broadbanded, and require no individual tuning over the entire 88-108 MHz FM band. The solid-state, modular concept affords back-up capability for greatly improved reliability, and reduces overall transmitter tuning requirements.

LOW OPERATING COST. With today's mounting energy costs, transmitter efficiency must be a major consideration in any purchase. 77% efficiency in the final power amplifier, high efficiency in all amplifier circuits, and conservatively rated components result in comparatively low power consumption and low operating stress on heat generating components in the FM-25K. This adds up to very impressive savings in operating and maintenance costs.

AUTOMATIC POWER CONTROL. The FM-25K automatically monitors power output, and maintains the output at the desired level. This standard feature insures against out-of-tolerance power conditions. Furthermore, the power set point can be remotely adjusted independently of the limit points to allow operator control of power output. During maintenance periods, the automatic power control may be switched off.

VSWR PROTECTION. VSWR protection is mandatory in any high-power transmitter—therefore, Harris has incorporated this as a standard feature in the FM-25K. A high VSWR condition will cause the transmitter to recycle... if three overloads occur within a given time period, the

transmitter will shut down until manually restarted. The transmitter may also be programmed for single VSWR overload shutdown.

CONTROL CIRCUITRY. The FM-25K is controlled by solid-state logic circuitry. The logic circuitry not only controls basic On/Off functions, but also monitors critical stages for overload conditions. Should an overload occur, the transmitter will recycle automatically, according to the number of times pre-set (one or three).

The control logic used in the FM-25K interfaces directly with most remote control systems, eliminating the need for an additional remote control interface. The control signals are momentary low current contacts to ground. The transmitter output parameters are buffered, and all status indicators are remotod.

METERING AND VISUAL AIDS. Major functions, including RF output, VSWR and PA parameters are displayed on easy-to-read four-inch meters. Low-level parameters are displayed on a multimeter, and IPA RF output and reflected power are indicated on another meter. Filament voltage is measured by a true RMS circuit.

The FM-25K provides a variety of indicators as trouble shooting aids and quick references. These include four illuminated On/Off pushbuttons and 26 LED's not including those on the MS-15 exciter.

HV POWER SUPPLY. The high voltage power supply is housed in a separate cabinet, and provides the plate and screen supplies. The conservatively-rated three-phase plate supply uses silicon rectifiers with AC line transient protection.

COMPACT SIZE. The trim PA cabinet can fit as a replacement for all older 20- to 25-kilowatt FM transmitters. The cabinet is only 35 inches wide, 72 inches high and 31 inches deep. Additionally, the HV power supply may be located in any convenient spot remote from the PA cabinet.

GENERAL. There are many other operational and convenience features incorporated into the FM-25K. These include:

Line Loss Protection—
Built-in protection against total AC failure and loss of

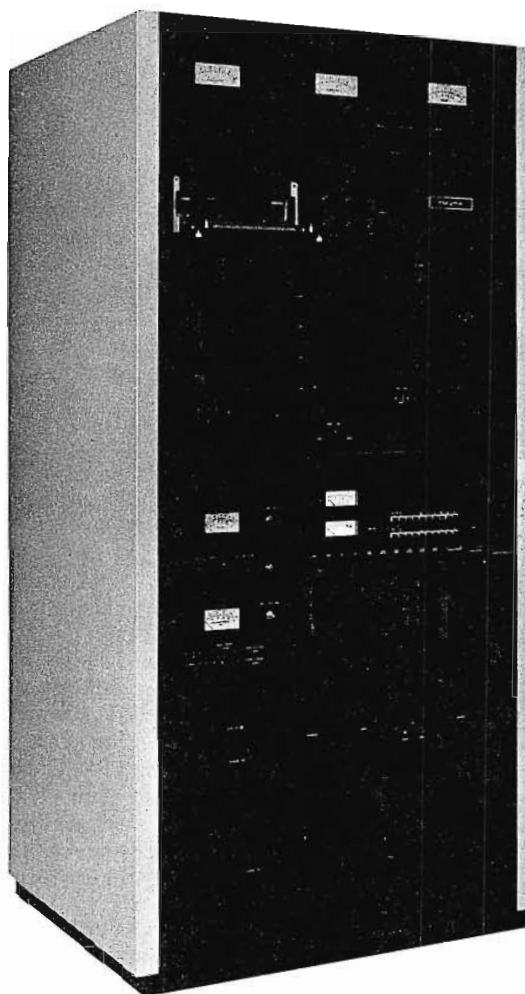

high efficiency . . . only one tube . . . wide RF bandwidth

phase is provided. The FM-25K will restart automatically following a total power failure, while loss of a single phase will shut down the transmitter.

High Altitude Rating—A high-capacity, direct-drive blower delivers sufficient air to cool the transmitter at altitudes up to 10,000 feet (3048 meters).

Additional Protection—Four magnetic circuit breakers are utilized to protect the blower motor, the filament supply, the IPA supply and the bias supply. A wide-ranging interlock system and a drop solenoid system quickly discharge power supplies to safe levels.

ATS Compatibility—The simple control logic interface and full metering in the FM-25K permit ATS operation.

MS-15 EXCITER. The solid-state MS-15 exciter employs Digitally Synthesized Modulation (DSM), overshoot compensation, and other Harris exclusive design techniques, to give you an FM sound that is noticeably cleaner, noticeably louder than any competitive signal.

The DSM stereo generator is a Harris development which eliminates the tradeoff that exists between switching type stereo generators (poor separation at high frequencies) and balanced modulator types of stereo generators (poor harmonic rejection and SCA crosstalk). The DSM stereo generator is capable of both 50 dB separation (typical) through 15 kHz and an exceptionally clean baseband, promoting minimal interaction between stereo and SCA service. Also, pilot phase is automatically controlled so that high separation can be maintained under varying operating conditions.

A Dynamic Transient Response (DTR) filter has been developed by Harris for FM stereo, which holds overshoot to 2% or less on any program material processed by any limiter. As a result, a 2 to 6 dB increase in loudness can be achieved without degradation of audio quality. Controlled

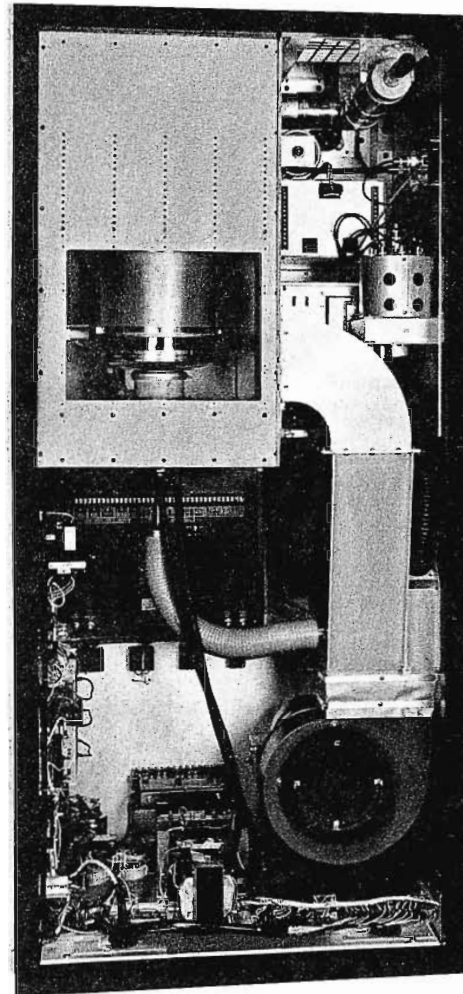

transient response, high stereo separation, low crosstalk and low intermodulation distortion are all maintained with increased loudness. For monaural stations wishing to protect 41 and/or 67 kHz SCA channels, a defeatable linear phase lowpass filter is provided for optimal linear control of overshoot.

The MS-15 is available for wideband, mono or stereo operation, with or without SCA. The modular construction of the MS-15 allows you to change the mode of operation or to add SCA at any time, by simply plugging in the appropriate module(s).

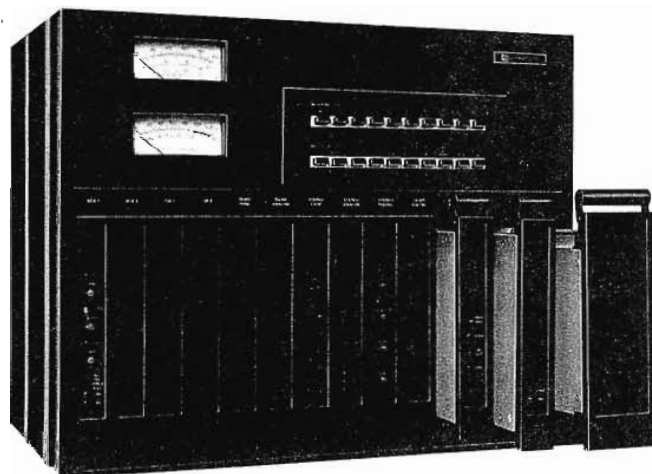

HARRIS
COMMUNICATION AND
INFORMATION PROCESSING

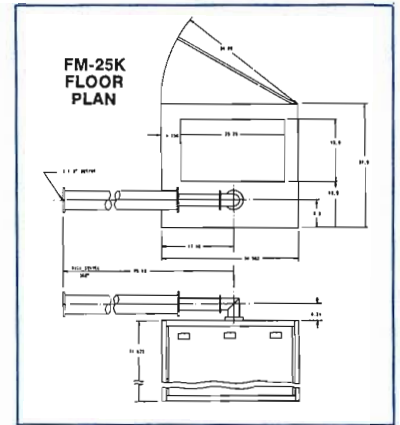
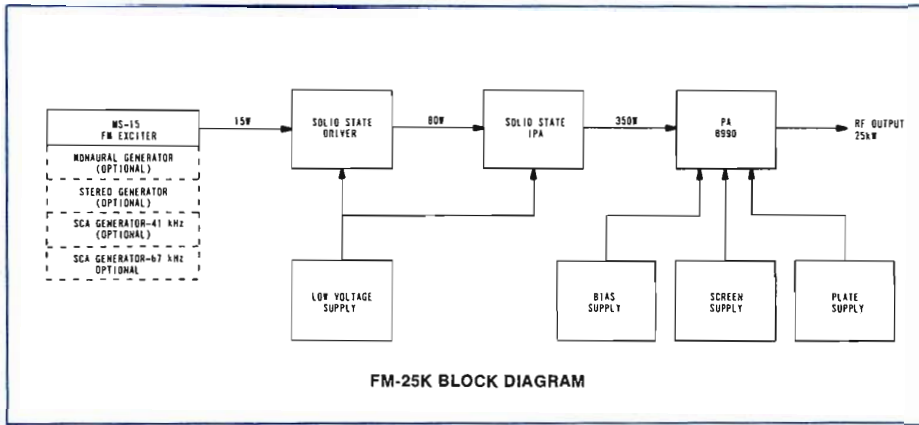

FM-25K SPECIFICATIONS

GENERAL

POWER OUTPUT: 10 kW to 25 kW.
FREQUENCY RANGE: 87.5 to 108 MHz, tuned to specified operating frequency. Exciter programmable in 50 kHz increments.
RF OUTPUT IMPEDANCE: 50 ohms.
OUTPUT TERMINATION: 3 1/2" EIA flange.
FREQUENCY STABILITY: ±300 Hz 0° to 45°C TCXO.
TYPE OF MODULATION: Direct Carrier Frequency Modulation.
MODULATION CAPABILITY: ±100 kHz.
AC INPUT POWER: 208/240 V, 3-phase, 50/60 Hz and 360/415 V, 3 phase, 50/60 Hz, 4-wire. Power consumption: 40kW typical.
RF HARMONICS: Suppression meets all FCC requirements.
ALTITUDE: 10,000 feet (3048 meters).
AMBIENT TEMPERATURE RANGE: -20°C to +50°C. Maximum temperature 50°C @ sea level, decreasing 2°C per 1000 feet (305 meters) to 30°C maximum at 10,000 feet (3048 meters).
MAXIMUM VSWR: 1.7 to 1.
SIZE: Transmitter cabinet, 34.6" W (87.8 cm) x 71.7" H (182.1 cm) x 31.0" D (78.7 cm). HV power supply cabinet: 48.0" W (121.9 cm) x 60.2" H (152.9 cm) x 24.2" D (61.5 cm).
FINISH: White, blue and black.
WEIGHT AND CUBAGE: (Estimated) Export: 3000 lbs. (1361 kg). Domestic: 2700 lbs. (1225 kg). Cubage: 150 cubic feet.

MONAURAL MODE

AUDIO INPUT IMPEDANCE: 600 ohms balanced, resistive, adaptable to other impedances.
INPUT FILTER: Controlled response LPF, defeatable.
AUDIO INPUT LEVEL: +10 dBm ±1 dB for 100% modulation at 400 Hz.
AUDIO FREQUENCY RESPONSE: Standard 75 microsecond FCC pre-emphasis curve ±0.5 dB, 30-15,000 Hz. Selectable: flat, 25 or 50 microsecond pre-emphasis.
HARMONIC DISTORTION: 0.2% or less, 30-15,000 Hz.
IMD: 0.2%, 60/7000 Hz, 4:1 ratio.
FM NOISE: 68 dB below 100% modulation (ref. 400 Hz @ ±75 kHz deviation).
AM NOISE: 55 dB below reference carrier AM modulation 100%.

STEREOPHONIC MODE

TYPE OF MODULATION: Digitally Synthesized Modulation (DSM).
AUDIO INPUT IMPEDANCE: (left and right) 600 ohms balanced, resistive. Adaptable to other impedances.
AUDIO INPUT LEVEL: (left and right) +10 dBm ±1 dB for 100% modulation at 400 Hz.
AUDIO FREQUENCY RESPONSE: (left and right) Standard 75 microsecond, FCC pre-emphasis curve ±0.5 dB 30-15,000 Hz. Selectable: flat, 25 or 50 microsecond pre-emphasis.
INPUT FILTERING: 15 kHz LPF, 45 dB rejection at 19 kHz.
OVERSHOOT PROTECTION: Dynamic transient response (DTR) filter.
AUDIO TRANSIENT RESPONSE: 2% maximum overshoot beyond steady state. Defeatable for test purposes.

HARMONIC DISTORTION: (left or right) 0.4% or less, 30-15,000 Hz.

IMD: 0.4%, 60/7000 Hz, 4:1 ratio.

FM NOISE: (left or right) 65 dB minimum below 100% modulation. Reference: 400 Hz, 75 microsecond de-emphasis, ±75 kHz deviation.

PILOT OSCILLATOR: Crystal controlled.

PILOT STABILITY: 19 kHz ±1 Hz, 0° to 45°C.

PILOT PHASE: Automatically controlled.

STEREO SEPARATION: 40 dB minimum 30-15,000 Hz, 50 dB typical.

CROSSTALK: (main to stereo sub-channel or stereo sub-to main channel) 45 dB below 90% modulation.

SUB CARRIER SUPPRESSION: 50 dB below 90% modulation.
76 kHz SUPPRESSION: 60 dB minimum below 100% modulation.

MODES: Stereo, mono (L + R), mono (L), mono (R). Remoteable.

SCA SPECIFICATIONS

MODULATION: Direct FM.

FREQUENCY: 41 or 67 kHz programmable, any frequency between 25 and 75 kHz on special order.

FREQUENCY STABILITY: ±500 Hz.

MODULATION CAPABILITY: ±7.5 kHz.

AUDIO INPUT IMPEDANCE: 600 ohms balanced (AC coupled) and 2000 ohms unbalanced (DC coupled).

AUDIO INPUT LEVEL: +10 dBm ±1 dB for 100% modulation at 400 Hz.

AUDIO FREQUENCY RESPONSE: 41 kHz and 67 kHz, 150 microsecond pre-emphasis ±1 dB, standard. Selectable: flat, 50 or 75 microsecond pre-emphasis.

INPUT FILTERING: Programmable LPF, 4.5 kHz standard.

DISTORTION: Less than 1%, 30-4500 Hz. ±5 kHz deviation.

FM NOISE: (main channel not modulated) 55 dB minimum (ref. 100% = ±5 kHz deviation at 400 Hz).

CROSSTALK: (SCA to main or stereo sub-channel): -60 dB or better.

CROSSTALK: (main or stereo sub-channel to SCA): 50 dB below ±5 kHz deviation of SCA, with mono or stereo channels modulated by frequencies 30-15,000 Hz, SCA demodulated with 150 microsecond de-emphasis.

CROSSTALK: SCA to SCA (41 kHz/67 kHz) 50 dB demodulated with 150 microsecond de-emphasis.

AUTOMATIC MUTE LEVEL: Variable from 0 to -30 dBm.

MUTE DELAY: Adjustable 0.5 to 20 seconds.

INJECTION LEVEL: 1% to 30% of composite. Adjustable.

WIDEBAND MODE

INPUT IMPEDANCE: Greater than 5000 ohms resistive, unbalanced.

INPUT LEVEL: 1.0 VRMS nominal for ±75 kHz deviation.

AMPLITUDE RESPONSE: ±0.25 dB, 30 Hz to 75 kHz.

PHASE LINEARITY: ±2°, 30 Hz to 75 kHz.

ORDERING INFORMATION

FM-25K, 25,000 watt FM broadcast transmitter with MS-15 exciter, for wideband operation, 50/60 Hz (specify 50 or 60 Hz).....	994-8258-001
Spare tube	374-0151-000
Mono generator (add for mono operation)	994-8019-001
DSM stereo generator with DTR (add for stereo operation)	994-8020-001
SCA generator (add for SCA operation, specify 41 or 67 kHz).....	994-7992-001



HARRIS
COMMUNICATION AND
INFORMATION PROCESSING

FM-20K

**20-Kilowatt
FM
Broadcast
Transmitter**

- Solid-state Maximum Signal Exciter—MS-15
- Digitally Synthesized Modulation for high stereo separation
- Overshoot compensation
- 80% efficiency in the final amplifier
- Dependable "Vari-Line" tuning
- All connections for remote control built in
- Automatic recycling
- Full metering
- Automatic output power control available
- Plug-in mono, stereo and SCA generators





FM-20K, front view, doors open.

The FM-20K employs Harris' exclusive, advanced-design MS-15 solid-state exciter, with Digitally Synthesized Modulation (DSM), to provide the very finest stereo signal available. Technical specifications are exceptional compared to other 20 kilowatt FM transmitters on the market. And DSM with overshoot compensation allows a 2 to 6 dB increase in loudness with no degradation of audio quality. With Harris' FM-20K you not only get the cleanest sound in town—you get the loudest!

LOW OPERATING COST. 80% efficiency in the final amplifier, plus high efficiency in all amplifier circuits, plus conservatively rated components combine to give the FM-20K the lowest operating cost of any transmitter in its power range. As amplifier tubes are operated at only a fraction of their actual rating, maximum service life is assured. You save both on power bills and on tube costs.

THREE TUBES. Only three tubes (two tube types) are used in the FM-20K. The MS-15 drives the intermediate power amplifier, consisting of two parallel 4CX250B's. The final single-ended power amplifier is a 4CX15000A ceramic tetrode, which provides excellent perform-

ance, and runs at only one-third its dissipation capability.

"VARI-LINE" SILVER PLATED TANK. Vari-Line is an advanced, Harris-developed method of tuning a single-ended FM amplifier for optimum output efficiency. A portion of a parallel tubular 2 $\frac{3}{8}$ -inch copper transmission line (silver plated for efficient RF service) is made variable in order to inductively tune the line to operating frequency.

With Vari-Line tuning, greater reliability is possible. Mica capacitors are not used in the tank circuit. This reduces the complexity of sliding contacts and consequent maintenance problems.

PLUG-IN MONO, STEREO AND SCA GENERATORS. The FM-20K may be equipped for mono or stereo operation, with or without SCA. The design versatility of the exciter allows you to order for mono operation originally, then add stereo and/or SCA at a later date by plugging the appropriate module(s) into the exciter. Since the SCA generators have spectrally pure filtered outputs, 41 and 67 kHz SCA channels may be operated simultaneously, while in the mono mode, without harmonic interference.

DUAL HV SILICON POWER SUPPLY. Two separate three-phase power sup-

plies are used for the FM-20K—both featuring "avalanche" silicon rectifiers for greatest reliability and protection against transient voltages or on-off power surges.

One HV power supply—for PA plate voltage—is housed in a separate enclosure, while the supply powering the IPA plate and screen circuit, and the PA screen, is housed in the main transmitter cabinet.

AUTOMATIC RECYCLING. In case of momentary overload, the transmitter recycles automatically. Should the overload reoccur in excess of the desired number of times preset in the transmitter, the FM-20K will then remain off the air until it is reset, either locally or by remote control.

TESTING. Environmental tests, in conditions surpassing those of any location a transmitter is likely to encounter, have been imposed on the FM-20K. The transmitter is capable of operating at altitudes to 7500 feet, in an ambient temperature range of -20° to $+45^{\circ}\text{C}$.

In addition, your FM-20K is fully tuned and operationally tested on your frequency before shipment.

REMOTE CONTROL. All connections for remote control are built in—just connect the FM-20K to a transmitter control unit, and you are ready for remote operation. No additional transmitter equipment is required.

FULL METERING. Eight easy-to-read meters, including a multimeter, provide full monitoring of the seventeen parameters of the operating tubes and exciter. There is also a directional coupler which measures forward power and VSWR, and an elapsed time meter.

GENERAL. There are many other operational and convenience features incorporated into the FM-20K. These include: Pushbutton Operation — On-off functions are controlled by lighted pushbuttons at the top left of the transmitter. These are clearly marked "Filament On-Off", "Plate On-Off".

High-Capacity Blower — backed up by a precision air-pressure switch gives complete protection to the IPA and PA tubes.

Straightforward Design — allows easy accessibility to all components.

Front Panel Test Points — permit fast checking of exciter circuit conditions.

Handsome Styling — the transmitter cabinet is attractively yet functionally styled, with double front doors. The finish is white and blue, with black meter panel.

FCC Type Acceptance — the FM-20K is FCC type accepted for mono or stereo broadcasting in the 87.5 to 108 MHz FM band.

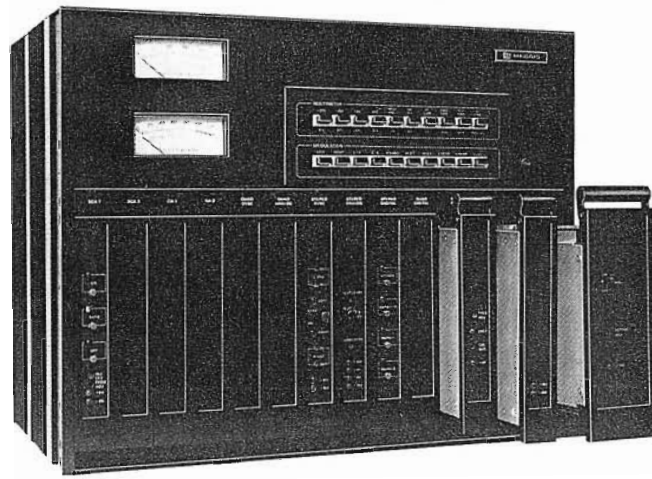

HARRIS' MS-15...THE MOST ADVANCED FM EXCITER IN THE INDUSTRY

The solid-state MS-15 exciter employs Digitally Synthesized Modulation, overshoot compensation, and other exclusive design techniques, to give you an FM sound that is noticeably cleaner, noticeably louder than any competitive signal. The exciter is available for mono or stereo operation, with or without SCA. The modular construction of the MS-15 allows you to change the mode of operation, or to add SCA, at any time, by simply plugging in the appropriate module(s).

FCC approval of a system for quadrasonic FM will not obsolete the MS-15. Module positions exist which are ready to accept a quad generator.

DIGITALLY SYNTHESIZED MODULATION. The DSM stereo generator is a new development which eliminates the tradeoff that exists between switching type and balanced modulator types of stereo generators—poor separation at high frequencies in the former or poor harmonic rejection and SCA crosstalk in the latter. The DSM stereo generator is capable of both 50 dB separation (typical) through 15 kHz and an exceptionally clean baseband, promoting minimal interaction between stereo and SCA service. Also, pilot phase is automatically controlled so that high separation can be maintained under varying operating conditions.

OVERSHOOT COMPENSATION. A Dynamic Transient Response (DTR) filter has been developed by Harris for FM stereo, with overshoot no greater than 2% on any program material processed by any limiter. As a result, from 2 to 6 dB increased loudness can be achieved without degradation of audio quality. Controlled transient response, high stereo separation, low crosstalk, and low intermodulation distortion are all maintained with increased loudness. For monaural

stations wishing to protect 41 and/or 67 kHz SCA channels, a defeatable linear phase lowpass filter is provided for optimal linear control of overshoot.

COMPATIBILITY. The MS-15 exciter is mechanically and electrically compatible with the Harris TE-3 exciter. Mountings are in the same location and use the same hardware.

RF output power is 15 watts into 50 ohms, continuously adjustable to 3 watts by one control. A directional coupler samples and meters forward and reflected power, with remote metering capability. A harmonic filter is placed at the RF module output, reducing harmonics to a low level. The balanced 600 ohm audio input is transformerless to give maximum common mode rejection and excellent response. Inputs will withstand high transients or steady state voltages above or below ground reference.

The basic exciter audio response is wide-band and flat, and can be used directly with a studio-transmitter link. The exciter is self-contained, including the power supply.

OTHER FEATURES. The Harris MS-15 exciter can be quickly and easily programmed to any carrier frequency in the 87.5 to 108 MHz band in 50 kHz increments. The RF output network is broadband and requires no tuning. Carrier frequencies are generated through a digital synthesizer which is locked to a 10 MHz TCXO high stability frequency standard. The TCXO has improved crystal aging characteristics and does not require an oven. The synthesizer also provides outputs at 2.5, 5, 10, 15, 20 and 25 MHz for easy frequency comparison to the National Bureau of Standards WWV transmissions.

Pre-emphasis is selectable to 75, 50, 25 or 0 microseconds in either monophonic or stereophonic operation.

Remote control capability includes switching between stereo and mono, and selection of left, right, or left-plus-right inputs for monophonic operation.

SCA OPERATION. SCA operation is added to the exciter through a plug-in module. It is available with either stereo or mono operation; up to two channels can be added to mono exciters, or a single SCA used with stereo. Any channel between 25 kHz and 75 kHz can be used, although 41 kHz and 67 kHz are normally provided. Either frequency is selectable on the SCA channel card.

Pre-emphasis is selectable to 150, 75, 50 or 0 microseconds. The input audio is applied to a programmable lowpass filter, and the output of the SCA generator filtered so that 150 microseconds pre-emphasis can be used with no degradation of SCA to main channel crosstalk.

Each SCA module has a pair of audio inputs, one AC coupled for audio, and the other DC coupled for data and video transmission.

The subcarrier level is adjustable to provide from 1% to 30% composite baseband SCA injection. When an SCA subcarrier is turned on or off, an automatic composite level switcher noiselessly compensates for the change in baseband injection level. 100% peak modulation is maintained independent of SCA status.

EASE OF MAINTENANCE. The entire exciter is modular for ease of troubleshooting and maintenance. An extender card is provided to allow easy servicing. Extensive metering is provided, and LED status lights on the modules indicate various performance features.

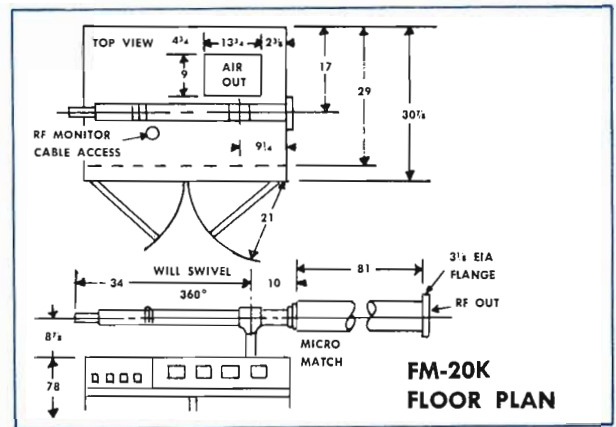
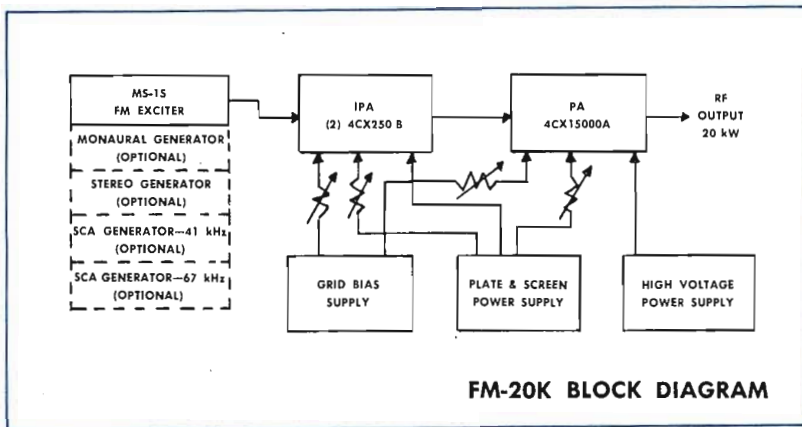

FM-20K SPECIFICATIONS

GENERAL

POWER OUTPUT: 10 kW to 20 kW.
FREQUENCY RANGE: 87.5 to 108 MHz, tuned to specified operating frequency.
RF OUTPUT IMPEDANCE: 50 ohms.
OUTPUT TERMINATION: 3/8" EIA flange.
FREQUENCY STABILITY: ± 300 Hz 0° to 45° C TCXO.
TYPE OF MODULATION: Direct Carrier Frequency Modulation.
MODULATION CAPABILITY: ± 100 kHz.
AC INPUT POWER: 208/240 V, 3-phase, 60 Hz. (50 Hz available on special order.) Power consumption: 30,000 watts (approx.). 115/230 V, 60 or 50 Hz, 150 watts for MS-15.
RF HARMONICS: Suppression meets all FCC requirements.
POWER SUPPLY RECTIFIERS: Silicon.
ALTITUDE: 7500 feet.
AMBIENT TEMPERATURE RANGE: -20° C to $+45^\circ$ C.
MAXIMUM VSWR: 1.7 to 1.
SIZE: Transmitter cabinet, 42"W (107cm) x 78"H (198cm) x 33"D (84cm). HV power supply cabinet, 30"W (76cm) x 49"H (125cm) x 30"D (76cm).
FRONT DOOR SWING: 21" (53cm).
FINISH: White, blue and black.
WEIGHT AND CUBAGE: Export: 2800 lbs. (1270 kg). Domestic: 2300 lbs. (1043 kg). 141 cubic feet.

MONAURAL MODE

AUDIO INPUT IMPEDANCE: 600 ohms balanced, resistive, adaptable to other impedances.
INPUT FILTER: Controlled response LPF, defeatable.
AUDIO INPUT LEVEL: $+10$ dBm ± 1 dB for 100% modulation at 400 Hz.
AUDIO FREQUENCY RESPONSE: Standard 75 microsecond FCC pre-emphasis curve ± 0.5 dB, 30-15,000 Hz. Selectable: flat, 25 or 50 microsecond pre-emphasis.
HARMONIC DISTORTION: 0.2% or less, 30-15,000 Hz.
IMD: 0.2%, 60/7000 Hz, 4:1 ratio.
FM NOISE: 68 dB below 100% modulation (ref. 400 Hz @ ± 75 kHz deviation).
AM NOISE: 50 dB below reference carrier AM modulation 100%.

STEREOPHONIC MODE

TYPE OF MODULATION: Digitally Synthesized Modulation (DSM).
AUDIO INPUT IMPEDANCE: (left and right) 600 ohms balanced, resistive. Adaptable to other impedances.
AUDIO INPUT LEVEL: (left and right) $+10$ dBm ± 1 dB for 100% modulation at 400 Hz.
AUDIO FREQUENCY RESPONSE: (left and right) Standard 75 microsecond, FCC pre-emphasis curve ± 0.5 dB 30-15,000 Hz. Selectable: flat, 25 or 50 microsecond pre-emphasis.
INPUT FILTERING: 15 kHz LPF, 45 dB rejection at 19 kHz.

OVERSHOOT PROTECTION: Dynamic transient response (DTR) filter.
AUDIO TRANSIENT RESPONSE: 2% maximum overshoot beyond steady state. Defeatable for test purposes.
HARMONIC DISTORTION: (left or right) 0.4% or less, 30-15,000 Hz.
IMD: 0.4%, 60/7000 Hz, 4:1 ratio.
FM NOISE: (left or right) 65 dB minimum below 100% modulation. Reference: 400 Hz, 75 microsecond de-emphasis, ± 75 kHz deviation.
PILOT OSCILLATOR: Crystal controlled.
PILOT STABILITY: 19 kHz ± 1 Hz, 0° to 45° C.
PILOT PHASE: Automatically controlled.
STEREO SEPARATION: 40 dB minimum 30-15,000 Hz.
CROSSTALK: (main to stereo sub-channel or stereo sub-to main channel) 45 dB below 90% modulation.
SUB CARRIER SUPPRESSION: 50 dB below 90% modulation.
76 kHz SUPPRESSION: 60 dB minimum below 100% modulation.
MODES: Stereo, mono (L + R), mono (L), mono (R). Remateable.

SCA SPECIFICATIONS

MODULATION: Direct FM.
FREQUENCY: 41 or 67 kHz programable, any frequency between 25 and 75 kHz on special order.
FREQUENCY STABILITY: ± 500 Hz.
MODULATION CAPABILITY: ± 7.5 kHz.
AUDIO INPUT IMPEDANCE: 600 ohms balanced (AC coupled) and 2000 ohms unbalanced (DC coupled).
AUDIO INPUT LEVEL: $+10$ dBm ± 1 dB for 100% modulation at 400 Hz.
AUDIO FREQUENCY RESPONSE: 41 kHz and 67 kHz, 150 microsecond pre-emphasis ± 1 dB, standard. Selectable: flat, 50 or 75 microsecond pre-emphasis.
INPUT FILTERING: Programable LPF, 4.5 kHz standard.
DISTORTION: Less than 1%, 30-5000 Hz. ± 5 kHz deviation.
FM NOISE: (main channel not modulated) 55 dB minimum (ref: 100% = ± 5 kHz deviation at 400 Hz).
CROSSTALK: (SCA to main or stereo sub-channel): -60 dB or better.
CROSSTALK: (main or stereo sub-channel to SCA): 50 dB below ± 5 kHz deviation of SCA, with mono or stereo channels modulated by frequencies 30-15,000 Hz, SCA demodulated with 150 microsecond de-emphasis.
CROSSTALK: SCA to SCA (41 kHz/67 kHz) 50 dB demodulated with 150 microsecond de-emphasis.
AUTOMATIC MUTE LEVEL: Variable from 0 to -30 dBm.
MUTE DELAY: Adjustable 0.5 to 20 seconds.
INJECTION LEVEL: 1% to 30% of composite. Adjustable.

WIDEBAND MODE

INPUT IMPEDANCE: Greater than 5000 ohms resistive, unbalanced.
INPUT LEVEL: 1.0 VRMS nominal for ± 75 kHz deviation.
AMPLITUDE RESPONSE: ± 0.25 dB, 30 Hz to 75 kHz.
PHASE LINEARITY: $\pm 2^\circ$, 30 Hz to 75 kHz.

ORDERING INFORMATION

FM-20K 20,000 watt FM broadcast transmitter with MS-15 exciter, for wideband operation, 60 Hz	994-8052-001
100% spare tube kit	990-0552-001
Mono generator (add for mono operation)	994-8019-001
DSM stereo generator with DTR (add for stereo operation)	994-8020-001
SCA generator (add for SCA operation, specify 41 or 67 kHz)	994-7992-001



HARRIS
COMMUNICATION AND
INFORMATION PROCESSING

FM-10K

10-Kilowatt FM Broadcast Transmitter

- Solid-state Maximum Signal Exciter—MS-15
- Patented DSM Stereo Generator provides separation exceeding accurate measurement capability of most monitors
- DTR filter technique limits overshoot to 2% or less, permitting a 2 to 6 dB increase in loudness with no audio quality degradation
- Low operating cost
- Stable, easy output tuning
- Built-in connections for remote control
- Automatic recycling
- Full metering
- Plug-in mono, stereo and SCA generators



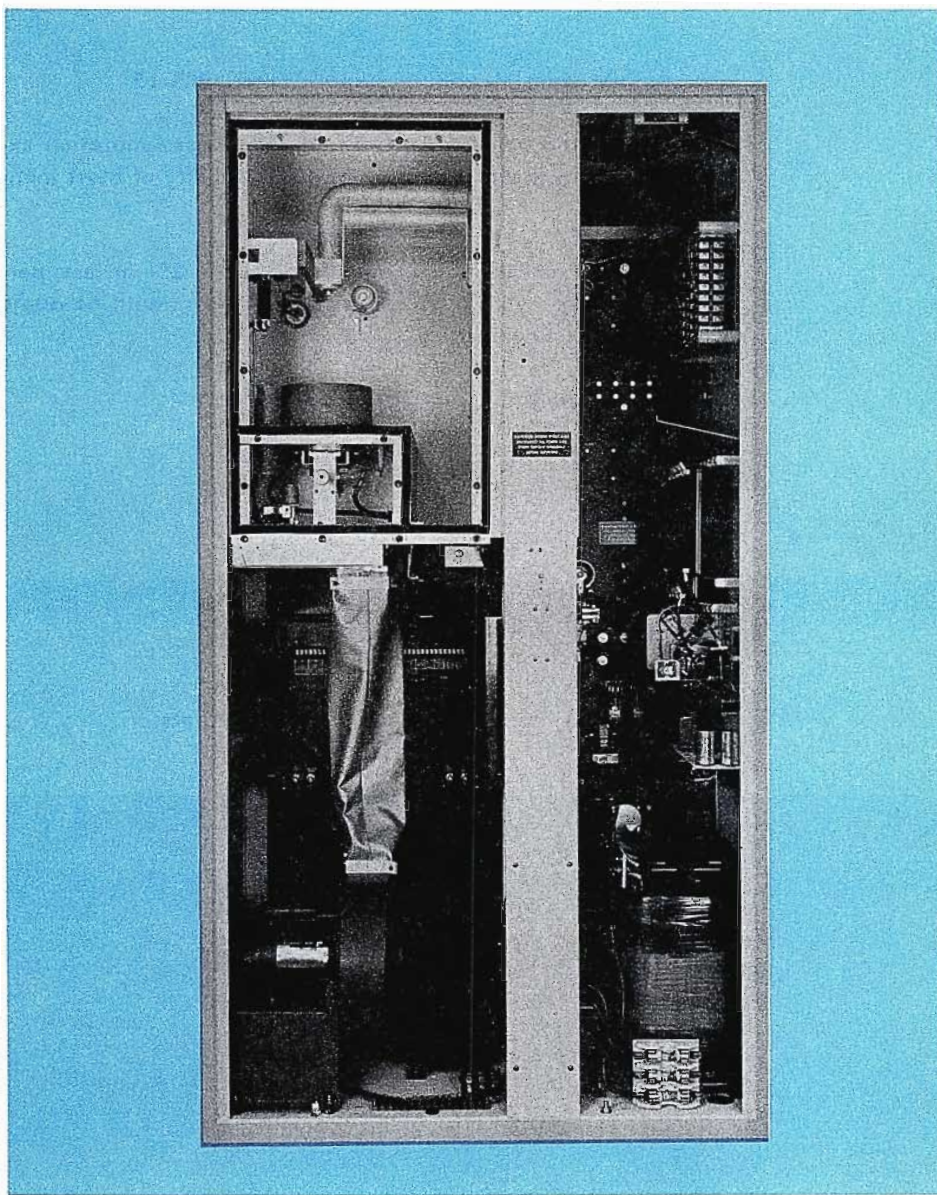

Featuring the advanced-design MS-15 exciter, Harris' FM-10K provides the cleanest and loudest stereo signal of any 10 kilowatt FM transmitter available today. The DSM (Digitally Synthesized Modulation) stereo generator allows the transmitter to provide stereo separation of 40 dB minimum, 30-15,000 Hz—while the DTR (Dynamic Transient Response) filter permits a 2 to 6 dB increase in loudness, with no degradation of audio quality, by limiting overshoot to 2% or less. Add to this high efficiency plus conservatively rated components and you have a really exceptional FM transmitter—the Harris FM-10K.

ONLY TWO TUBES. Just two tubes are employed in the FM-10K—a 4CX10,00D PA and a 4CX300A IPA. The ceramic-type 4CX10,00D is a high-gain tetrode that operates with a 2-to-1 dissipation safety margin, and was selected as the power amplifier because of its proven longer useful life.

"VARI-LINE" SILVER PLATED TANK. Vari-Line is a Harris-developed method of tuning a single-ended FM amplifier for optimum output efficiency. A portion of a parallel tubular 1½ inch copper transmission line (silver plated for efficient RF service) is made variable in order to inductively tune the line to operating frequency.

VSWR PROTECTION. To protect the transmitter PA, a VSWR overload circuit has been incorporated. The VSWR circuit monitors the reflected power from the output directional coupler and interrupts the high voltage power supply when the VSWR exceeds a pre-determined level. The transmitter will attempt to restart, and if the VSWR clears, return to air. Multiple VSWR trips within a given period will cause the transmitter to shut down.

AUTOMATIC RECYCLING. In case of momentary overload, the transmitter recycles automatically. Should the overload

reoccur in excess of the desired number of times preset in the transmitter, the FM-10K will then remain off the air until it is reset, either locally or by remote control.

HV SILICON POWER SUPPLY. One three-phase HV power supply is used in the FM-10K. It provides the PA plate voltage, PA screen voltage, and powers the IPA plate and screen circuits. The bias supply for the PA is a bridge circuit of four silicon rectifiers. The transmitter employs a special power supply protective circuit to assure maximum protection from transient voltages or on-off power surges.

BUILT-IN REMOTE CONTROL. Connect the transmitter control unit to the transmitter, tie in the telephone line to the studio control unit, and you are ready for complete remote control operation. All necessary functions can be controlled remotely—and no additional equipment is required for a Harris control system.

TESTING. Environmental tests, in conditions surpassing those of any location a transmitter is likely to encounter, have been imposed on the FM-10K. The transmitter is capable of operating at altitudes up to 10,000 feet (3000 meters), in an ambient temperature range of -20° to +45° C.

In addition, your FM-10K is fully tuned and operationally tested on your frequency before shipment.

METERING AND VISUAL AIDS. Six easy-to-read meters, including four multimeters, provide full monitoring of twenty-eight parameters in the transmitter and the exciter. To aid in fault location, a system of indicator lights provides status display of important transmitter parameters.

GENERAL. There are many other operational and convenience features incorporated into the FM-10K. These include:

Pushbutton Operation—On-off functions are controlled by lighted pushbuttons at the top left of the transmitter. These are clearly marked "Filament On-Off", "Plate On-Off".

High-Capacity Blower—backed up by a precision air-pressure switch gives complete protection to the IPA and PA tubes.

Straightforward Design—allows easy accessibility to all components.

AC Interruption Restart—this feature provides for automatically returning the transmitter "on air" after a temporary or indefinite outage of the AC power source. A front panel override switch is also provided.

FCC Type Acceptance—the FM-10K is FCC type accepted for mono or stereo broadcasting in the 87.5 to 108 MHz FM band.

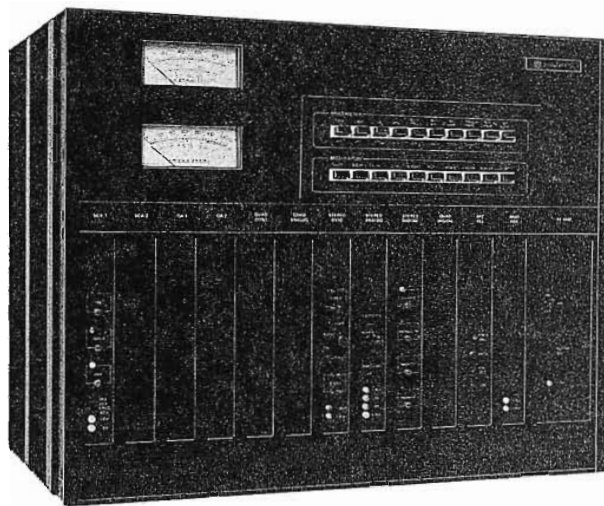

HARRIS' MS-15 . . . THE MOST ADVANCED FM EXCITER IN THE INDUSTRY

The solid-state MS-15 exciter employs Digitally Synthesized Modulation, overshoot compensation, and other exclusive design techniques, to give you an FM sound that is noticeably cleaner, noticeably louder than any competitive signal. The exciter is available for mono or stereo operation, with or without SCA. The modular construction of the MS-15 allows you to change the mode of operation, or to add SCA, at any time, by simply plugging in the appropriate module(s).

FCC approval of a system for quadrasonic FM will not obsolete the MS-15. Module positions exist which are ready to accept a quad generator.

DIGITALLY SYNTHESIZED MODULATION. The DSM stereo generator is a new development which eliminates the tradeoff that exists between switching type and balanced modulator types of stereo generators—poor separation at high frequencies in the former or poor harmonic rejection and SCA crosstalk in the latter. The DSM stereo generator is capable of both 50 dB separation (typical) through 15 kHz and an exceptionally clean baseband, promoting minimal interaction between stereo and SCA service. Also, pilot phase is automatically controlled so that high separation can be maintained under varying operating conditions.

OVERSHOOT COMPENSATION. A Dynamic Transient Response (DTR) filter has been developed by Harris for FM stereo, with overshoot no greater than 2% on any program material processed by any limiter. As a result, from 2 to 6 dB increased loudness can be achieved without degradation of audio quality. Controlled transient response, high stereo separation, low crosstalk, and low intermodulation distortion are all maintained with increased

loudness. For monaural stations wishing to protect 41 and/or 67 kHz SCA channels, a defeatable linear phase lowpass filter is provided for optimal linear control of overshoot.

COMPATIBILITY. The MS-15 exciter is mechanically and electrically compatible with the Harris TE-3 exciter. Mountings are in the same location and use the same hardware.

RF output power is 15 watts into 50 ohms, continuously adjustable to 3 watts by one control. A directional coupler samples and meters forward and reflected power, with remote metering capability. A harmonic filter is placed at the RF module output, reducing harmonics to a low level. The balanced 600 ohm audio input is transformerless to give maximum common mode rejection and excellent response. Inputs will withstand high transients or steady state voltages above or below ground reference.

The basic exciter audio response is wide-band and flat, and can be used directly with a studio-transmitter link. The exciter is self-contained, including the power supply.

OTHER FEATURES. The Harris MS-15 exciter can be quickly and easily programmed to any carrier frequency in the 87.5 to 108 MHz band in 50 kHz increments. The RF output network is broadband and requires no tuning. Carrier frequencies are generated through a digital synthesizer which is locked to a 10 MHz TCXO high stability frequency standard. The TCXO has improved crystal aging characteristics and does not require an oven. The synthesizer also provides outputs at 2.5, 5, 10, 15, 20 and 25 MHz for easy frequency comparison to the National Bureau of Standards WWV transmissions.

Pre-emphasis is selectable to 75, 50, 25 or 0 microseconds in either monophonic or stereophonic operation.

Remote control capability includes switching between stereo and mono, and selection of left, right, or left-plus-right inputs for monophonic operation.

SCA OPERATION. SCA operation is added to the exciter through a plug-in module. It is available with either stereo or mono operation; up to two channels can be added to mono exciters, or a single SCA used with stereo. Any channel between 25 kHz and 75 kHz can be used, although 41 kHz and 67 kHz are normally provided. Either frequency is selectable on the SCA channel card.

Pre-emphasis is selectable to 150, 75, 50 or 0 microseconds. The input audio is applied to a programmable lowpass filter, and the output of the SCA generator filtered so that 150 microseconds pre-emphasis can be used with no degradation of SCA to main channel crosstalk.

Each SCA module has a pair of audio inputs, one AC coupled for audio, and the other DC coupled for data and video transmission.

The subcarrier level is adjustable to provide, from 1% to 30% composite baseband SCA injection. When an SCA subcarrier is turned on or off, an automatic composite level switcher noiselessly compensates for the change in baseband injection level. 100% peak modulation is maintained independent of SCA status.

EASE OF MAINTENANCE. The entire exciter is modular for ease of troubleshooting and maintenance. An extender card is provided to allow easy servicing. Extensive metering is provided, and LED status lights on the modules indicate various performance features.

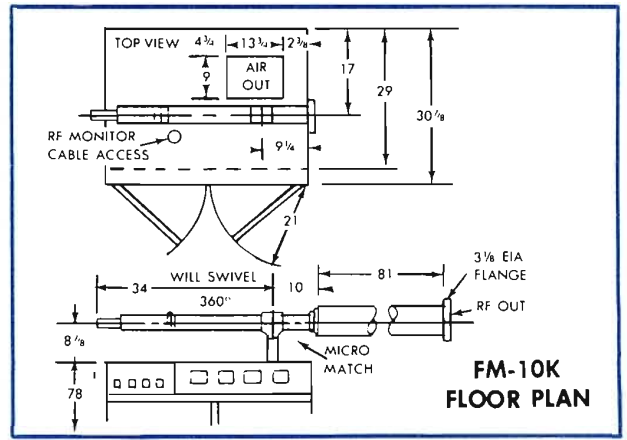
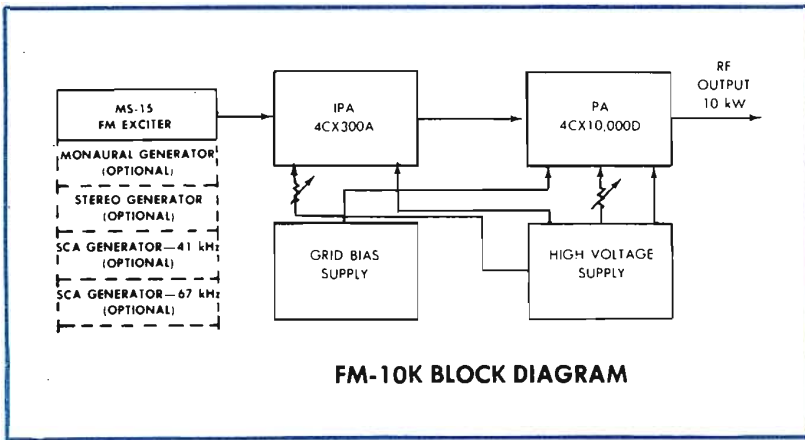

FM-10K SPECIFICATIONS

GENERAL

POWER OUTPUT: 10 kW.
FREQUENCY RANGE: 87.5 to 108 MHz, tuned to specified operating frequency.
RF OUTPUT IMPEDANCE: 50 ohms.
OUTPUT TERMINATION: 3/8" EIA flange.
FREQUENCY STABILITY: ±300 Hz 0° to 45°C TCXO.
TYPE OF MODULATION: Direct Carrier Frequency Modulation.
MODULATION CAPABILITY: ±100 kHz.
AC INPUT POWER: 208/240 V, 3-phase, 60 Hz (50 Hz available.) Power consumption: 17,000 watts (approx.). 115/230 V, 60 or 50 Hz, 150 watts for MS-15.
RF HARMONICS: Suppression meets all FCC requirements.
POWER SUPPLY RECTIFIERS: Silicon.
ALTITUDE: 10,000 feet (3000 meters).
AMBIENT TEMPERATURE RANGE: -20°C to +45°C.
MAXIMUM VSWR: 1.7 to 1.
SIZE: Transmitter cabinet, 42"W (107cm) x 78"H (198cm) x 33"D (84cm).
FRONT DOOR SWING: 21" (53cm).
FINISH: White, blue and black.
WEIGHT AND CUBAGE: Export: 2200 lbs. (998 kg). Domestic: 1800 lbs. (817 kg). 120 cubic feet.

MONAURAL MODE

AUDIO INPUT IMPEDANCE: 600 ohms balanced, resistive, adaptable to other impedances.
INPUT FILTER: Controlled response LPF, defeatable.
AUDIO INPUT LEVEL: +10 dBm ±1 dB for 100% modulation at 400 Hz.
AUDIO FREQUENCY RESPONSE: Standard 75 microsecond FCC pre-emphasis curve ±0.5 dB, 30-15,000 Hz. Selectable: flat, 25 or 50 microsecond pre-emphasis.
HARMONIC DISTORTION: 0.2% or less, 30-15,000 Hz.
IMD: 0.2%, 60/7000 Hz, 4:1 ratio.
FM NOISE: 68 dB below 100% modulation (ref. 400 Hz @ ±75 kHz deviation).
AM NOISE: 50 dB below reference carrier AM modulation 100%.

STEREOPHONIC MODE

TYPE OF MODULATION: Digitally Synthesized Modulation (DSM).
AUDIO INPUT IMPEDANCE: (left and right) 600 ohms balanced, resistive. Adaptable to other impedances.
AUDIO INPUT LEVEL: (left and right) +10 dBm ±1 dB for 100% modulation at 400 Hz.
AUDIO FREQUENCY RESPONSE: (left and right) Standard 75 microsecond, FCC pre-emphasis curve ±0.5 dB 30-15,000 Hz. Selectable: flat, 25 or 50 microsecond pre-emphasis.
INPUT FILTERING: 15 kHz LPF, 45 dB rejection at 19 kHz.
OVERSHOOT PROTECTION: Dynamic transient response (DTR) filter.
AUDIO TRANSIENT RESPONSE: 2% maximum overshoot beyond steady state. Defeatable for test purposes.

HARMONIC DISTORTION: (left or right) 0.4% or less, 30-15,000 Hz.
IMD: 0.4%, 60/7000 Hz, 4:1 ratio.
FM NOISE: (left or right) 65 dB minimum below 100% modulation. Reference: 400 Hz, 75 microsecond de-emphasis, ±75 kHz deviation.
PILOT OSCILLATOR: Crystal controlled.
PILOT STABILITY: 19 kHz ±1 Hz, 0° to 45°C.
PILOT PHASE: Automatically controlled.
STEREO SEPARATION: 40 dB minimum 30-15,000 Hz.
CROSSTALK: (main to stereo sub-channel or stereo sub-to main channel) 45 dB below 90% modulation.
SUB CARRIER SUPPRESSION: 50 dB below 90% modulation.
76 kHz SUPPRESSION: 60 dB minimum below 100% modulation.
MODES: Stereo, mono (L + R), mono (L), mono (R). Remoteable.

SCA SPECIFICATIONS

MODULATION: Direct FM.
FREQUENCY: 41 or 67 kHz programable, any frequency between 25 and 75 kHz on special order.
FREQUENCY STABILITY: ±500 Hz.
MODULATION CAPABILITY: ±7.5 kHz.
AUDIO INPUT IMPEDANCE: 600 ohms balanced (AC coupled) and 2000 ohms unbalanced (DC coupled).
AUDIO INPUT LEVEL: +10 dBm ±1 dB for 100% modulation at 400 Hz.
AUDIO FREQUENCY RESPONSE: 41 kHz and 67 kHz, 150 microsecond pre-emphasis ±1 dB, standard. Selectable: flat, 50 or 75 microsecond pre-emphasis.
INPUT FILTERING: Programable LPF, 4.5 kHz standard.
DISTORTION: Less than 1%, 30-5000 Hz. ±5 kHz deviation.
FM NOISE: (main channel not modulated) 55 dB minimum (ref: 100% = ±5 kHz deviation at 400 Hz).
CROSSTALK: (SCA to main or stereo sub-channel): -60 dB or better.
CROSSTALK: (main or stereo sub-channel to SCA): 50 dB below ±5 kHz deviation of SCA, with mono or stereo channels modulated by frequencies 30-15,000 Hz, SCA demodulated with 150 microsecond de-emphasis.
CROSSTALK: SCA to SCA (41 kHz/67 kHz) 50 dB demodulated with 150 microsecond de-emphasis.
AUTOMATIC MUTE LEVEL: Variable from 0 to -30 dBm.
MUTE DELAY: Adjustable 0.5 to 20 seconds.
INJECTION LEVEL: 1% to 30% of composite. Adjustable.

WIDEBAND MODE

INPUT IMPEDANCE: Greater than 5000 ohms resistive, unbalanced.
INPUT LEVEL: 1.0 VRMS nominal for ±75 kHz deviation.
AMPLITUDE RESPONSE: ±0.25 dB, 30 Hz to 75 kHz.
PHASE LINEARITY: ±2°, 30 Hz to 75 kHz.

Specifications subject to change without notice.

ORDERING INFORMATION

FM-10K, 10,000 watt FM transmitter with MS-15 exciter, for wideband operation, 60 Hz.	994-8051-001
As above, except for 50 Hz operation	994-8051-002
Mono generator (add for mono operation)	994-8019-001
DSM stereo generator with DTR (add for stereo operation)	994-8020-001
SCA generator (add for SCA operation, specify 41 or 67 kHz)	994-7992-001



HARRIS
COMMUNICATION AND
INFORMATION PROCESSING

FM-5K

**5-Kilowatt
FM Broadcast
Transmitter**

- Solid-state Maximum Signal Exciter—MS-15
- Patented DSM Stereo Generator provides separation exceeding accurate measurement capability of most monitors
- DTR filter technique limits overshoot to 2% or less, permitting a 2 to 6 dB increase in loudness with no audio quality degradation
- Low operating costs
- Stable, easy output tuning
- Built-in connections for remote control
- Automatic recycling
- Full metering
- Plug-in mono, stereo and SCA generators

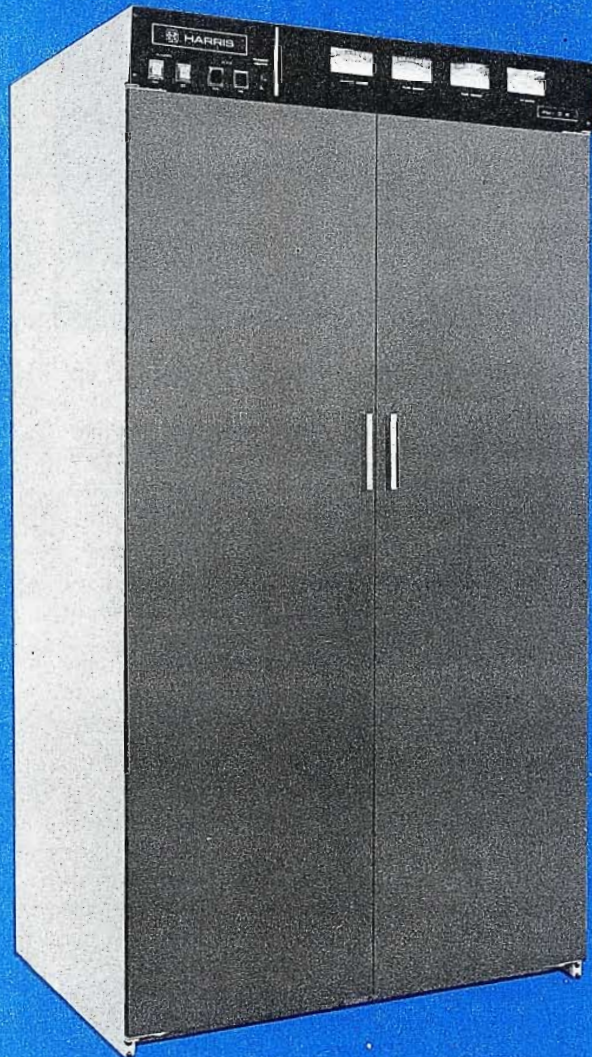

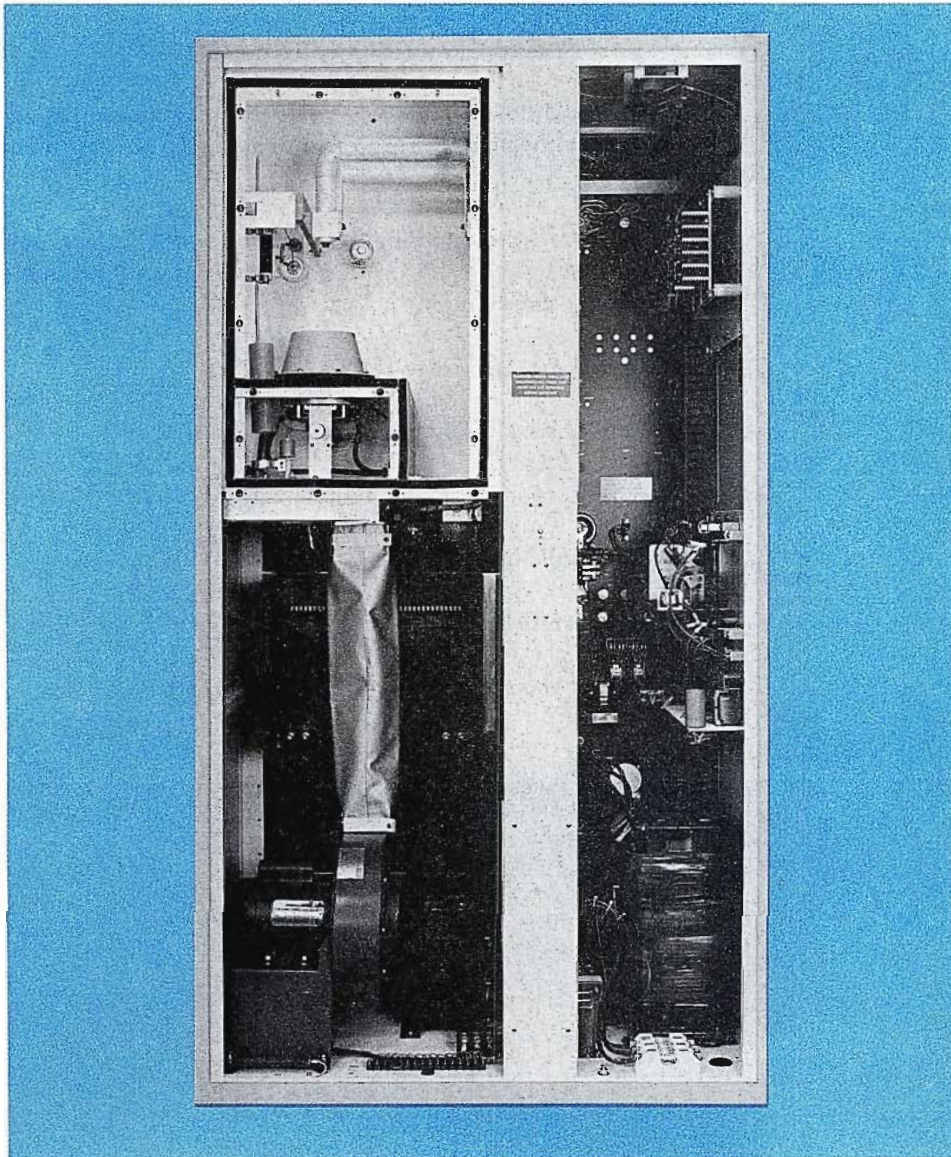

Featuring the advanced-design MS-15 exciter, the Harris 5 kW FM-5K provides the cleanest and the loudest stereo signal of any FM transmitter in its power range. The DSM (Digitally Synthesized Modulation) stereo generator allows the transmitter to provide stereo separation of 40 dB minimum, 30-15,000 Hz—while the DTR (Dynamic Transient Response) filter permits a 2 to 6 dB increase in loudness, with no degradation of audio quality, by limiting overshoot to 2% or less. Add to this high efficiency plus conservatively rated components and you have a truly exceptional FM transmitter.

ONLY TWO TUBES. Just two tubes are employed in the transmitter. A type 4CX-250B tube amplifies the solid-state exciter output and supplies a nominal 250 watts to drive the ceramic 4CX5000A final amplifier. This power tetrode operates as a single ended amplifier to produce 5 kilowatts of RF power.

"VARI-LINE" SILVER PLATED TANK. Vari-Line is a Harris-developed method of

tuning a single-ended FM amplifier for optimum output efficiency. A portion of a parallel tubular $1\frac{1}{8}$ inch copper transmission line (silver plated for efficient RF service) is made variable in order to inductively tune the line to operating frequency.

AUTOMATIC RECYCLING. In case of momentary overload, recycling takes place automatically. Should an overload reoccur in excess of the number of times preset, the transmitter will then remain off the air until it is reset, either locally or by remote control.

VSWR PROTECTION. To protect the transmitter PA, a VSWR overload circuit has been incorporated. The VSWR circuit monitors the reflected power from the output directional coupler and interrupts the high voltage power supply when the VSWR exceeds a pre-determined level. The transmitter will attempt to restart, and if the VSWR clears, return to air. Multiple VSWR trips within a given period will cause the transmitter to shut down.

HV SILICON POWER SUPPLY. All power supplies are housed inside the transmitter cabinet. One three-phase supply provides the PA plate voltage, and powers the IPA plate and screen circuits. The transmitter employs a special power supply protective circuit to assure maximum protection from transient voltages or on-off power surges.

BUILT-IN REMOTE CONTROL. Connect the transmitter control unit to the transmitter, tie in the telephone line to the studio control unit, and you are ready for complete remote control operation. All necessary functions can be controlled remotely—and no additional equipment is required for a Harris remote control system.

TESTING. Environmental tests, in conditions surpassing those of any location a transmitter is likely to encounter, have been imposed on the FM-5K. The transmitter is capable of operating at altitudes up to 7,500 feet (2250 meters), in an ambient temperature range of -20° to $+45^{\circ}$ C.

In addition, your transmitter is fully tuned and operationally tested on your frequency before shipment.

METERING AND VISUAL AIDS. Six meters, including four large, front-panel meters, provide full monitoring of the transmitter's operating parameters. Included is a power indicator that permits direct reading of both power output and standing wave ratio. To aid in fault location, a system of indicator lights provides status display of important transmitter parameters.

GENERAL. There are many other operational and convenience features incorporated into the FM-5K transmitter. These include:

Pushbutton Operation—On-off functions are controlled by lighted pushbuttons at the top left of the transmitter. These are clearly marked "Filament On-Off", "Plate On-Off".

High-Capacity Blower—backed up by a precision air-pressure switch gives complete protection to the IPA and PA tubes.

Straightforward Design—allows easy accessibility to all components.

AC Interruption Restart—this feature provides for automatically returning the transmitter "on air" after a temporary or indefinite outage of the AC power source. A front panel override switch is also provided.

FCC Type Acceptance—The transmitter is FCC type accepted for mono, stereo and SCA broadcasting in the 87.5 to 108 MHz FM band.

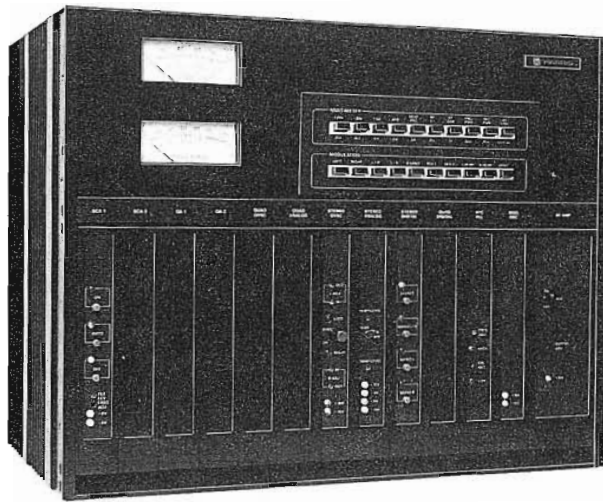

HARRIS' MS-15 . . . THE MOST ADVANCED FM EXCITER IN THE INDUSTRY

The solid-state MS-15 exciter employs Digitally Synthesized Modulation, overshoot compensation, and other exclusive design techniques, to give you an FM sound that is noticeably cleaner, noticeably louder than any competitive signal. The exciter is available for mono or stereo operation, with or without SCA. The modular construction of the MS-15 allows you to change the mode of operation, or to add SCA, at any time, by simply plugging in the appropriate module(s).

FCC approval of a system for quadraphonic FM will not obsolete the MS-15. Module positions exist which are ready to accept a quad generator.

DIGITALLY SYNTHESIZED MODULATION. The DSM stereo generator is a new development which eliminates the tradeoff that exists between switching type and balanced modulator types of stereo generators—poor separation at high frequencies in the former or poor harmonic rejection and SCA crosstalk in the latter. The DSM stereo generator is capable of both 50 dB separation (typical) through 15 kHz and an exceptionally clean baseband, promoting minimal interaction between stereo and SCA service. Also, pilot phase is automatically controlled so that high separation can be maintained under varying operating conditions.

OVERSHOOT COMPENSATION. A Dynamic Transient Response (DTR) filter has been developed by Harris for FM stereo, with overshoot no greater than 2% on any program material processed by any limiter. As a result, from 2 to 6 dB increased loudness can be achieved without degradation of audio quality. Controlled transient response, high stereo separation, low crosstalk, and low intermodulation distortion are all maintained with increased

loudness. For monaural stations wishing to protect 41 and/or 67 kHz SCA channels, a defeatable linear phase lowpass filter is provided for optimal linear control of overshoot.

COMPATIBILITY. The MS-15 exciter is mechanically and electrically compatible with the Harris TE-3 exciter. Mountings are in the same location and use the same hardware.

RF output power is 15 watts into 50 ohms, continuously adjustable to 3 watts by one control. A directional coupler samples and meters forward and reflected power, with remote metering capability. A harmonic filter is placed at the RF module output, reducing harmonics to a low level. The balanced 600 ohm audio input is transformerless to give maximum common mode rejection and excellent response. Inputs will withstand high transients or steady state voltages above or below ground reference.

The basic exciter audio response is wide-band and flat, and can be used directly with a studio-transmitter link. The exciter is self-contained, including the power supply.

OTHER FEATURES. The Harris MS-15 exciter can be quickly and easily programmed to any carrier frequency in the 87.5 to 108 MHz band in 50 kHz increments. The RF output network is broadband and requires no tuning. Carrier frequencies are generated through a digital synthesizer which is locked to a 10 MHz TCXO high stability frequency standard. The TCXO has improved crystal aging characteristics and does not require an oven. The synthesizer also provides outputs at 2.5, 5, 10, 15, 20 and 25 MHz for easy frequency comparison to the National Bureau of Standards WWV transmissions.

Pre-emphasis is selectable to 75, 50, 25 or 0 microseconds in either monophonic or stereophonic operation.

Remote control capability includes switching between stereo and mono, and selection of left, right, or left-plus-right inputs for monophonic operation.

SCA OPERATION. SCA operation is added to the exciter through a plug-in module. It is available with either stereo or mono operation; up to two channels can be added to mono exciters, or a single SCA used with stereo. Any channel between 25 kHz and 75 kHz can be used, although 41 kHz and 67 kHz are normally provided. Either frequency is selectable on the SCA channel card.

Pre-emphasis is selectable to 150, 75, 50 or 0 microseconds. The input audio is applied to a programmable lowpass filter, and the output of the SCA generator filtered so that 150 microseconds pre-emphasis can be used with no degradation of SCA to main channel crosstalk.

Each SCA module has a pair of audio inputs, one AC coupled for audio, and the other DC coupled for data and video transmission.

The subcarrier level is adjustable to provide from 1% to 30% composite baseband SCA injection. When an SCA subcarrier is turned on or off, an automatic composite level switcher noiselessly compensates for the change in baseband injection level. 100% peak modulation is maintained independent of SCA status.

EASE OF MAINTENANCE. The entire exciter is modular for ease of troubleshooting and maintenance. An extender card is provided to allow easy servicing. Extensive metering is provided, and LED status lights on the modules indicate various performance features.

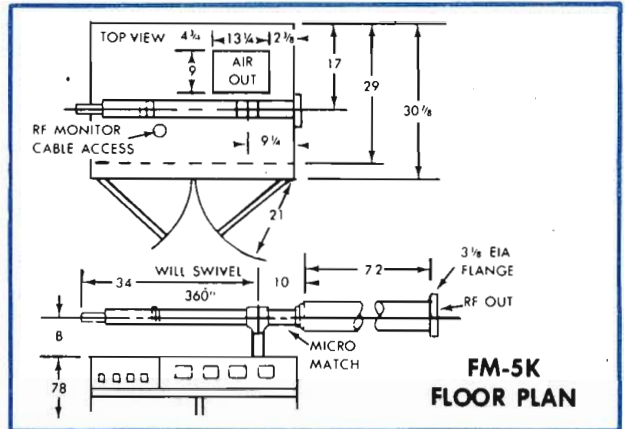
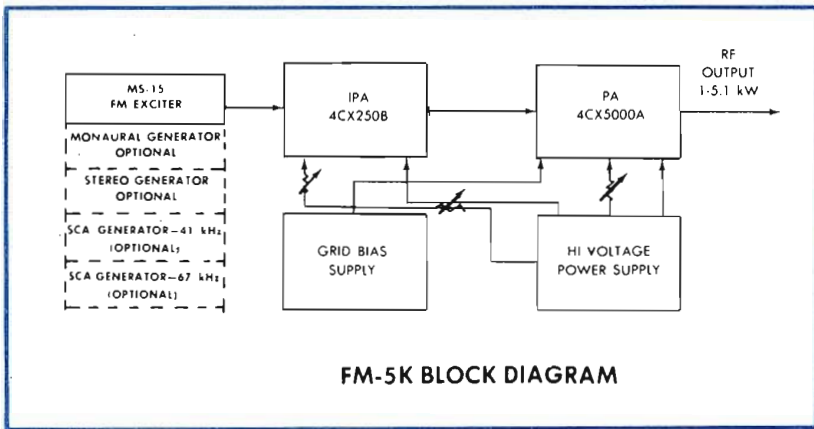

FM-5K SPECIFICATIONS

GENERAL

POWER OUTPUT: 1.0 to 5.1 kW.
FREQUENCY RANGE: 87.5 to 108 MHz, tuned to specified operating frequency.
RF OUTPUT IMPEDANCE: 50 ohms.
OUTPUT TERMINATION: 3/8" EIA flange.
FREQUENCY STABILITY: ± 300 Hz 0° to 45° C TCXO.
TYPE OF MODULATION: Direct Carrier Frequency Modulation.
MODULATION CAPABILITY: ± 100 kHz.
AC INPUT POWER: 208/240 V, 3-phase, 60 Hz (50 Hz available.) Power consumption (approx.): 10 kW consumption at 5 kW output. 115/230 V, 60 or 50 Hz, 150 watts for MS-15.
RF HARMONICS: Suppression meets all FCC requirements.
POWER SUPPLY RECTIFIERS: Silicon.
ALTITUDE: 7,500 feet (2250 meters).
AMBIENT TEMPERATURE RANGE: -20° C to $+45^\circ$ C.
MAXIMUM VSWR: 1.7 to 1.
SIZE: Transmitter cabinet, 42"W (107cm) x 78"H (198cm) x 33"D (84cm).
FRONT DOOR SWING: 21" (53cm).
FINISH: White, blue and black.
WEIGHT AND CUBAGE: Export: 2100 lbs. (953 kg). Domestic: 1700 lbs. (771 kg). 120 cubic feet.

MONAURAL MODE

AUDIO INPUT IMPEDANCE: 600 ohms balanced, resistive, adaptable to other impedances.
INPUT FILTER: Controlled response LPF, defeatable.
AUDIO INPUT LEVEL: $+10$ dBm ± 1 dB for 100% modulation at 400 Hz.
AUDIO FREQUENCY RESPONSE: Standard 75 microsecond FCC pre-emphasis curve ± 0.5 dB, 30-15,000 Hz. Selectable: flat, 25 or 50 microsecond pre-emphasis.
HARMONIC DISTORTION: 0.2% or less, 30-15,000 Hz.
IMD: 0.2%, 60/7000 Hz, 4:1 ratio.
FM NOISE: 68 dB below 100% modulation (ref. 400 Hz @ ± 75 kHz deviation).
AM NOISE: 50 dB below reference carrier AM modulation 100%.

STEREOPHONIC MODE

TYPE OF MODULATION: Digitally Synthesized Modulation (DSM).
AUDIO INPUT IMPEDANCE: (left and right) 600 ohms balanced, resistive. Adaptable to other impedances.
AUDIO INPUT LEVEL: (left and right) $+10$ dBm ± 1 dB for 100% modulation at 400 Hz.
AUDIO FREQUENCY RESPONSE: (left and right) Standard 75 microsecond, FCC pre-emphasis curve ± 0.5 dB 30-15,000 Hz. Selectable: flat, 25 or 50 microsecond pre-emphasis.
INPUT FILTERING: 15 kHz LPF, 45 dB rejection at 19 kHz.
OVERSHOOT PROTECTION: Dynamic transient response (DTR) filter.
AUDIO TRANSIENT RESPONSE: 2% maximum overshoot beyond steady state. Defeatable for test purposes.

HARMONIC DISTORTION: (left or right) 0.4% or less, 30-15,000 Hz.
IMD: 0.4%, 60/7000 Hz, 4:1 ratio.
FM NOISE: (left or right) 65 dB minimum below 100% modulation. Reference: 400 Hz, 75 microsecond de-emphasis, ± 75 kHz deviation.
PILOT OSCILLATOR: Crystal controlled.
PILOT STABILITY: 19 kHz ± 1 Hz, 0° to 45° C.
PILOT PHASE: Automatically controlled.
STEREO SEPARATION: 40 dB minimum 30-15,000 Hz.
CROSSTALK: (main to stereo sub-channel or stereo sub-to-main channel) 45 dB below 90% modulation.
SUB CARRIER SUPPRESSION: 50 dB below 90% modulation.
76 kHz SUPPRESSION: 60 dB minimum below 100% modulation.
MODES: Stereo, mono (L + R), mono (L), mono (R). Remoteable.

SCA SPECIFICATIONS

MODULATION: Direct FM.
FREQUENCY: 41 or 67 kHz programable, any frequency between 25 and 75 kHz on special order.
FREQUENCY STABILITY: ± 500 Hz.
MODULATION CAPABILITY: ± 7.5 kHz.
AUDIO INPUT IMPEDANCE: 600 ohms balanced (AC coupled) and 2000 ohms unbalanced (DC coupled).
AUDIO INPUT LEVEL: $+10$ dBm ± 1 dB for 100% modulation at 400 Hz.
AUDIO FREQUENCY RESPONSE: 41 kHz and 67 kHz, 150 microsecond pre-emphasis ± 1 dB, standard. Selectable: flat, 50 or 75 microsecond pre-emphasis.
INPUT FILTERING: Programable LPF, 4.5 kHz standard.
DISTORTION: Less than 1%, 30-5000 Hz. ± 5 kHz deviation.
FM NOISE: (main channel not modulated) 55 dB minimum (ref: 100% = ± 5 kHz deviation at 400 Hz).
CROSSTALK: (SCA to main or stereo sub-channel): -60 dB or better.
CROSSTALK: (main or stereo sub-channel to SCA): 50 dB below ± 5 kHz deviation of SCA, with mono or stereo channels modulated by frequencies 30-15,000 Hz, SCA demodulated with 150 microsecond de-emphasis.
CROSSTALK: SCA to SCA (41 kHz/67 kHz) 50 dB demodulated with 150 microsecond de-emphasis.
AUTOMATIC MUTE LEVEL: Variable from 0 to -30 dBm.
MUTE DELAY: Adjustable 0.5 to 20 seconds.
INJECTION LEVEL: 1% to 30% of composite. Adjustable.

WIDEBAND MODE

INPUT IMPEDANCE: Greater than 5000 ohms resistive, unbalanced.
INPUT LEVEL: 1.0 VRMS nominal for ± 75 kHz deviation.
AMPLITUDE RESPONSE: ± 0.25 dB, 30 Hz to 75 kHz.
PHASE LINEARITY: $\pm 2^\circ$, 30 Hz to 75 kHz.

Specifications subject to change without notice.

ORDERING INFORMATION

FM-5K, 5 kW FM transmitter with MS-15 exciter, for wideband operation, 60 Hz.....	994-8049-001
As above, except for 50 Hz operation	994-8049-002
Mono generator (add for mono operation)	994-8019-001
DSM stereo generator with DTR (add for stereo operation)	994-8020-001
SCA generator (add for SCA operation, specify 41 or 67 kHz)	994-7992-001



FM-2.5K

2.5-Kilowatt FM Broadcast Transmitter

- Solid-state Maximum Signal Exciter—MS-15
- Digitally Synthesized Modulation for high stereo separation
- Overshoot compensation
- Low power consumption
- Single phase power
- Stable, easy output tuning
- All connections for remote control built in
- Automatic recycling
- Full metering
- Plug in mono, stereo and SCA generators



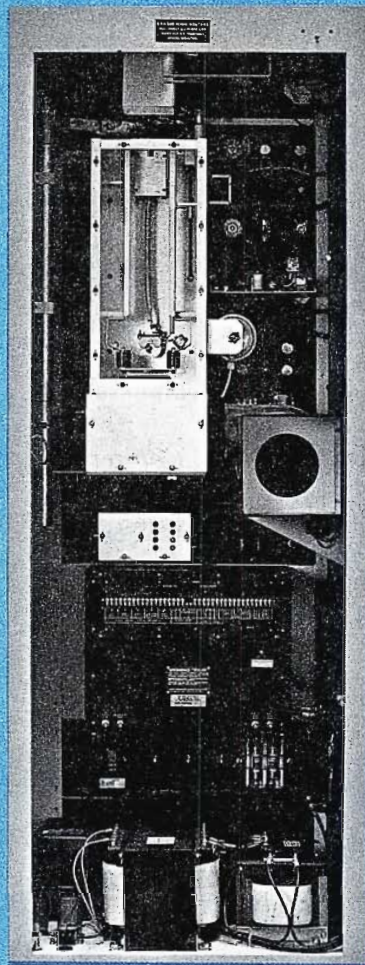

FM-2.5K, rear view, door off.

The FM-2.5K employs Harris' exclusive, advanced-design MS-15 solid state exciter, with Digitally Synthesized Modulation (DSM), to provide the very finest stereo signal available. Technical specifications are exceptional compared to other 2.5 kilowatt FM transmitters on the market. And DSM with overshoot compensation allows a 2 to 6 dB increase in loudness with no degradation of audio quality!

The transmitter consumes only 4.8 kilowatts at full output—and will provide 3000 watts effective radiated power in both horizontal and vertical planes when used with a Harris 3-bay FMC-3A Dual Cycloid III antenna. This assumes a coaxial cable efficiency of as low as 82%.

The FM-2.5K uses single phase power . . . in areas where this is the only type of power available, no additional lines are required.

Two tubes are employed in the FM-2.5K—the 4X150A intermediate power amplifier, and the 5CX1500A single-ended final power amplifier.

PLUG-IN MONO, STEREO AND SCA GENERATORS. The FM-2.5K may be

equipped for mono or stereo operation, with or without SCA. The design versatility of the exciter allows you to order for mono operation originally, then add stereo and/or SCA at a later date by plugging the appropriate module(s) into the exciter. Since the SCA generators have spectrally pure filtered outputs, 41 and 67 kHz SCA channels may be operated simultaneously while in the mono mode without harmonic interference.

STABLE, EASY OUTPUT TUNING. Plate tuning of the final amplifier is stable and easily adjusted. The plate circuit is a shorted, one-quarter wavelength configuration, with the plate line operated at DC ground potential. Coarse plate tuning is pre-set for the operating frequency on the plate line. Fine adjustment is made with the plate tuning knob on the front panel. Amplifier loading is changed by a variable output loading control.

AUTOMATIC RECYCLING. The recycle circuitry in the FM-2.5K is adjustable, self-clearing and uncomplicated. Should a momentary overload occur, the transmitter will recycle automatically. If the overload occurs in excess of the number of times pre-set, the transmitter will remain

off the air until it is reset, either manually or by remote control.

POWER OUTPUT CONTROL. The transmitter has a built-in motor-operated rheostat connected to the screen supply for adjusting the power output. A built-in reflectometer with a VSWR power meter makes adjustments of the power output easy and accurate.

REMOTE CONTROL. The FM-2.5K features built-in remote metering for the plate voltage, plate current and power output. No interface components are required to adapt a Harris remote control system to the transmitter. The transmitter's remote control circuitry can also be interfaced easily to other manufacturers' remote systems.

PUSHBUTTON OPERATION. Manual operation of the transmitter is simple. On-Off functions are controlled by lighted, dual pushbuttons at the top left of the cabinet. They are clearly marked Filament On and Off, Plate On and Off. After the filaments of the tubes are turned on, a time-delay relay allows the cathodes to reach operating temperatures before the plate power can be turned on.

COMPLETE TESTING. Environmental tests, in conditions surpassing those of any location a transmitter is likely to encounter, have been imposed on the FM-2.5K. The transmitter is capable of operating at altitudes to 7500 feet, in an ambient temperature range of -20° to $+45^{\circ}\text{C}$.

In addition, your FM-2.5K is fully tuned and operationally tested on your frequency before shipment.

HARMONIC FILTER STANDARD. Supplied with a Harris-designed harmonic filter, the transmitter fully meets FCC requirements for spurious radiation. All filtering is mounted inside the transmitter cabinet and provides rapid cut-off of second and higher order harmonics.

QUALITY COMPONENTS. Every transmitter component is conservatively operated and chosen to give optimum performance in continuous duty service. In Harris' MS-15 exciter, only performance-proven solid-state devices and precision temperature compensated components are used throughout.

STYLING. Handsomely yet functionally styled, the transmitter cabinet is finished in white and blue, with a black meter panel. The FM-2.5K is completely self-contained in one cabinet, and simplicity of design allows easy access to all components.

TYPE ACCEPTANCE. The FM-2.5K is FCC type accepted for mono or stereo broadcasting in the 87.5 to 108 MHz band.

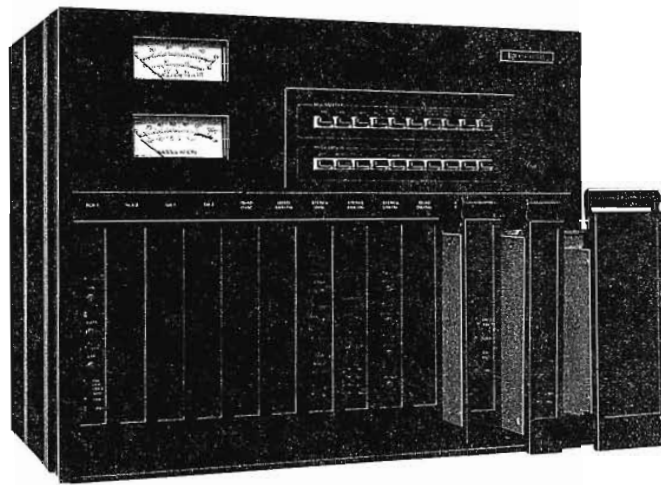

HARRIS' MS-15...THE MOST ADVANCED FM EXCITER IN THE INDUSTRY

The solid-state MS-15 exciter employs Digitally Synthesized Modulation, overshoot compensation, and other exclusive design techniques, to give you an FM sound that is noticeably cleaner, noticeably louder than any competitive signal. The exciter is available for mono or stereo operation, with or without SCA. The modular construction of the MS-15 allows you to change the mode of operation, or to add SCA, at any time, by simply plugging in the appropriate module(s).

FCC approval of a system for quadraphonic FM will not obsolete the MS-15. Module positions exist which are ready to accept a quad generator.

DIGITALLY SYNTHESIZED MODULATION. The DSM stereo generator is a new development which eliminates the tradeoff that exists between switching type and balanced modulator types of stereo generators—poor separation at high frequencies in the former or poor harmonic rejection and SCA crosstalk in the latter. The DSM stereo generator is capable of both 50 dB separation (typical) through 15 kHz and an exceptionally clean baseband, promoting minimal interaction between stereo and SCA service. Also, pilot phase is automatically controlled so that high separation can be maintained under varying operating conditions.

OVERSHOOT COMPENSATION. A Dynamic Transient Response (DTR) filter has been developed by Harris for FM stereo, with overshoot no greater than 2% on any program material processed by any limiter. As a result, from 2 to 6 dB increased loudness can be achieved without degradation of audio quality. Controlled transient response, high stereo separation, low crosstalk, and low intermodulation distortion are all maintained with increased loudness. For monaural

stations wishing to protect 41 and/or 67 kHz SCA channels, a defeatable linear phase lowpass filter is provided for optimal linear control of overshoot.

COMPATIBILITY. The MS-15 exciter is mechanically and electrically compatible with the Harris TE-3 exciter. Mountings are in the same location and use the same hardware.

RF output power is 15 watts into 50 ohms, continuously adjustable to 3 watts by one control. A directional coupler samples and meters forward and reflected power, with remote metering capability. A harmonic filter is placed at the RF module output, reducing harmonics to a low level. The balanced 600 ohm audio input is transformerless to give maximum common mode rejection and excellent response. Inputs will withstand high transients or steady state voltages above or below ground reference.

The basic exciter audio response is wide-band and flat, and can be used directly with a studio-transmitter link. The exciter is self-contained, including the power supply.

OTHER FEATURES. The Harris MS-15 exciter can be quickly and easily programmed to any carrier frequency in the 87.5 to 108 MHz band in 50 kHz increments. The RF output network is broadband and requires no tuning. Carrier frequencies are generated through a digital synthesizer which is locked to a 10 MHz TCXO high stability frequency standard. The TCXO has improved crystal aging characteristics and does not require an oven. The synthesizer also provides outputs at 2.5, 5, 10, 15, 20 and 25 MHz for easy frequency comparison to the National Bureau of Standards WWV transmissions.

Pre-emphasis is selectable to 75, 50, 25 or 0 microseconds in either monophonic or stereophonic operation.

Remote control capability includes switching between stereo and mono, and selection of left, right, or left-plus-right inputs for monophonic operation.

SCA OPERATION. SCA operation is added to the exciter through a plug-in module. It is available with either stereo or mono operation; up to two channels can be added to mono exciters, or a single SCA used with stereo. Any channel between 25 kHz and 75 kHz can be used, although 41 kHz and 67 kHz are normally provided. Either frequency is selectable on the SCA channel card.

Pre-emphasis is selectable to 150, 75, 50 or 0 microseconds. The input audio is applied to a programmable lowpass filter, and the output of the SCA generator filtered so that 150 microseconds pre-emphasis can be used with no degradation of SCA to main channel crosstalk.

Each SCA module has a pair of audio inputs, one AC coupled for audio, and the other DC coupled for data and video transmission.

The subcarrier level is adjustable to provide from 1% to 30% composite baseband SCA injection. When an SCA subcarrier is turned on or off, an automatic composite level switcher noiselessly compensates for the change in baseband injection level. 100% peak modulation is maintained independent of SCA status.

EASE OF MAINTENANCE. The entire exciter is modular for ease of troubleshooting and maintenance. An extender card is provided to allow easy servicing. Extensive metering is provided, and LED status lights on the modules indicate various performance features.

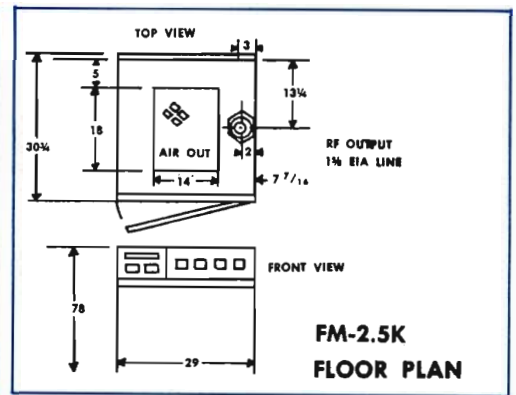
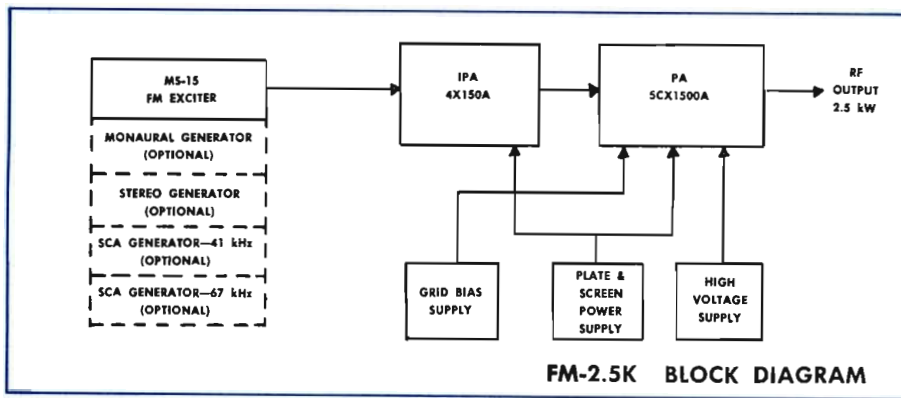

FM-2.5K SPECIFICATIONS

GENERAL

POWER OUTPUT: 800 W to 2.5 kW.
FREQUENCY RANGE: 87.5 to 108 MHz, tuned to specified operating frequency.
RF OUTPUT IMPEDANCE: 50 ohms.
OUTPUT TERMINATION: 1 1/2" EIA flange.
FREQUENCY STABILITY: ± 300 Hz 0° to 45° C TCXO.
TYPE OF MODULATION: Direct Carrier Frequency Modulation (DCFM).
MODULATION CAPABILITY: ± 100 kHz.
AC INPUT POWER: 197/250 V, 60 or 50 Hz, single phase, two wire.
 Power consumption: 4800 watts (approx.). 115/230 V, 60 or 50 Hz, 150 watts for MS-15.
RF HARMONICS: Suppression meets all FCC requirements.
POWER SUPPLY RECTIFIERS: Silicon.
ALTITUDE: 7500 feet.
AMBIENT TEMPERATURE RANGE: -20° C to $+45^\circ$ C.
MAXIMUM VSWR: 1.7 to 1.
OVERALL CABINET SIZE: 29"W (74cm) x 78"H (198cm) x 33"D (84cm).
FRONT DOOR SWING: 29" (74cm).
FINISH: White, blue and black.
WEIGHT & CUBAGE: Export: 1350 lbs. (612 kg). Domestic: 1100 lbs. (499 kg). 104 cu. ft. (2.9 cu. m).

MONAURAL MODE

AUDIO INPUT IMPEDANCE: 600 ohms balanced, resistive, adoptable to other impedances.
INPUT FILTER: Controlled response LPF, defeatable.
AUDIO INPUT LEVEL: $+10$ dBm ± 1 dB for 100% modulation at 400 Hz.
AUDIO FREQUENCY RESPONSE: Standard 75 microsecond FCC pre-emphasis curve ± 0.5 dB, 30-15,000 Hz. Selectable: flat, 25 or 50 microsecond pre-emphasis.
HARMONIC DISTORTION: 0.2% or less, 30-15,000 Hz.
IMD: 0.2%, 60/7000 Hz, 4:1 ratio.
FM NOISE: 68 dB below 100% modulation (ref. 400 Hz @ ± 75 kHz deviation).
AM NOISE: 50 dB below reference carrier AM modulation 100%.

STEREOPHONIC MODE

TYPE OF MODULATION: Digitally Synthesized Modulation (DSM).
AUDIO INPUT IMPEDANCE: (left and right) 600 ohms balanced, resistive. Adaptable to other impedances.
AUDIO INPUT LEVEL: (left and right) $+10$ dBm ± 1 dB for 100% modulation at 400 Hz.
AUDIO FREQUENCY RESPONSE: (left and right) Standard 75 microsecond, FCC pre-emphasis curve ± 0.5 dB 30-15,000 Hz. Selectable: flat, 25 or 50 microsecond pre-emphasis.
INPUT FILTERING: 15 kHz LPF, 45 dB rejection at 19 kHz.
OVERSHOOT PROTECTION: Dynamic transient response (DTR) filter.

AUDIO TRANSIENT RESPONSE: 2% maximum overshoot beyond steady state. Defeatable for test purposes.
HARMONIC DISTORTION: (left or right) 0.4% or less, 30-15,000 Hz.
IMD: 0.4%, 60/7000 Hz, 4:1 ratio.
FM NOISE: (left or right) 65 dB minimum below 100% modulation. Reference: 400 Hz, 75 microsecond de-emphasis, ± 75 kHz deviation.
PILOT OSCILLATOR: Crystal controlled.
PILOT STABILITY: 19 kHz ± 1 Hz, 0° to 45° C.
PILOT PHASE: Automatically controlled.
STEREO SEPARATION: 40 dB minimum 30-15,000 Hz.
CROSSTALK: (main to stereo sub-channel or stereo sub-to main channel) 45 dB below 90% modulation.
SUB CARRIER SUPPRESSION: 50 dB below 90% modulation.
76 kHz SUPPRESSION: 60 dB minimum below 100% modulation.
MODES: Stereo, mono (L + R), mono (L), mono (R). Remoteable.

SCA SPECIFICATIONS

MODULATION: Direct FM.
FREQUENCY: 41 or 67 kHz programable, any frequency between 25 and 75 kHz on special order.
FREQUENCY STABILITY: ± 500 Hz.
MODULATION CAPABILITY: ± 7.5 kHz.
AUDIO INPUT IMPEDANCE: 600 ohms balanced (AC coupled) and 2000 ohms unbalanced (DC coupled).
AUDIO INPUT LEVEL: $+10$ dBm ± 1 dB for 100% modulation at 400 Hz.
AUDIO FREQUENCY RESPONSE: 41 kHz and 67 kHz, 150 microsecond pre-emphasis ± 1 dB, standard. Selectable: flat, 50 or 75 microsecond pre-emphasis.
INPUT FILTERING: Programable LPF, 4.5 kHz standard.
DISTORTION: Less than 1%, 30-5000 Hz. ± 5 kHz deviation.
FM NOISE: (main channel not modulated) 55 dB minimum (ref: 100% = ± 5 kHz deviation at 400 Hz).
CROSSTALK: (SCA to main or stereo sub-channel): -60 dB or better.
CROSSTALK: (main or stereo sub-channel to SCA): 50 dB below ± 5 kHz deviation of SCA, with mono or stereo channels modulated by frequencies 30-15,000 Hz, SCA demodulated with 150 microsecond de-emphasis.
CROSSTALK: SCA to SCA (41 kHz/67 kHz) 50 dB demodulated with 150 microsecond de-emphasis.
AUTOMATIC MUTE LEVEL: Variable from 0 to -30 dBm.
MUTE DELAY: Adjustable 0.5 to 20 seconds.
INJECTION LEVEL: 1% to 30% of composite. Adjustable.

WIDEBAND MODE

INPUT IMPEDANCE: Greater than 5000 ohms resistive, unbalanced.
INPUT LEVEL: 1.0 VRMS nominal for ± 75 kHz deviation.
AMPLITUDE RESPONSE: ± 0.25 dB, 30 Hz to 75 kHz.
PHASE LINEARITY: $\pm 2^\circ$, 30 Hz to 75 kHz.

ORDERING INFORMATION

FM-2.5K 2500 watt FM broadcast transmitter with MS-15 exciter, for wideband operation, 60 Hz ..	994-8047-001
As above, except 50 Hz ..	994-8047-003
100% spare tube kit ..	990-0587-001
Mono generator (add for mono operation) ..	994-8019-001
DSM stereo generator with DTR (add for stereo operation) ..	994-8020-001
SCA generator (add for SCA operation, specify 41 or 67 kHz) ..	994-7992-001



HARRIS
COMMUNICATION AND
INFORMATION PROCESSING

FM-1K

1-Kilowatt FM Broadcast Transmitter

- Solid-state Maximum Signal Exciter—MS-15
- Patented DSM Stereo Generator provides separation exceeding accurate measurement capability of most monitors
- DTR filter technique limits overshoot to 2% or less, permitting a 2 to 6 dB increase in loudness with no audio quality degradation
- Low operating cost
- Stable, easy output tuning
- Built-in connections for remote control
- Automatic recycling
- Full metering
- Plug-in mono, stereo and SCA generators



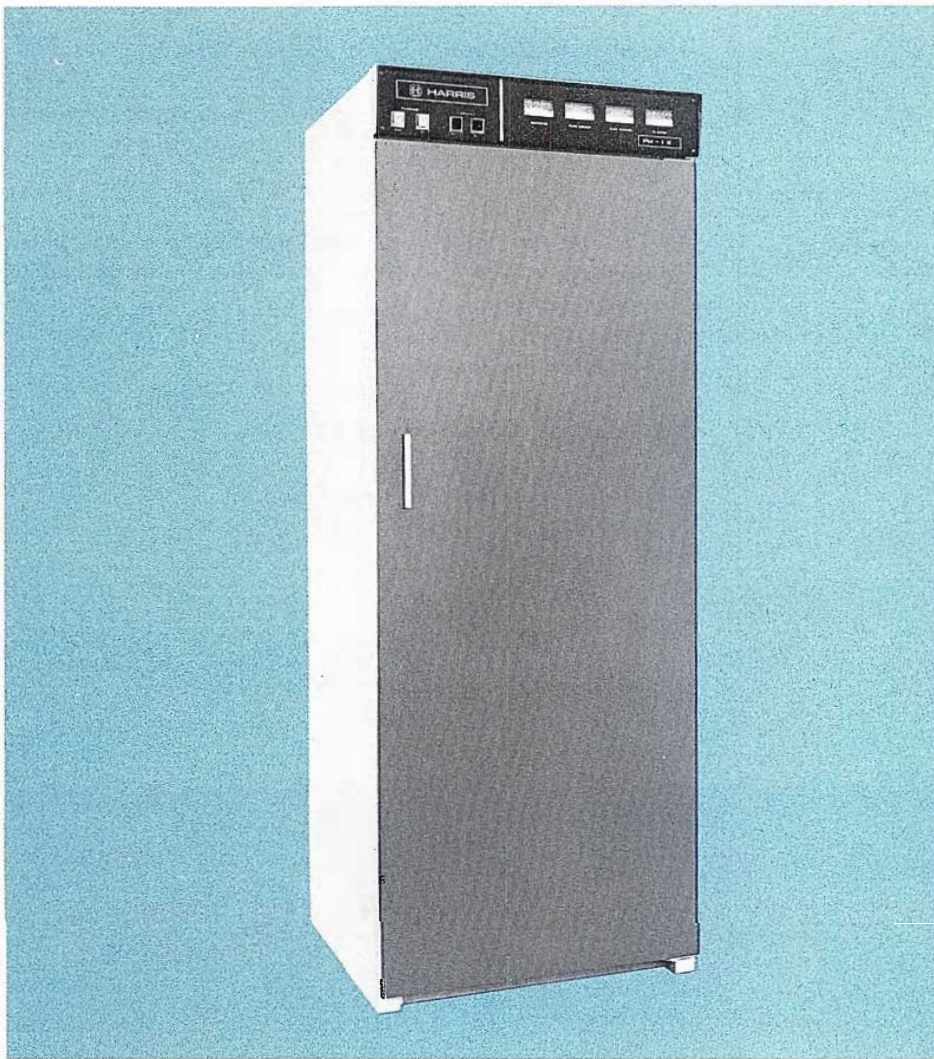

The FM-1K employs Harris' exclusive, advanced-design MS-15 solid-state exciter to provide the cleanest and the loudest FM signal of any one-kilowatt FM transmitter available today. The DSM (Digitally Synthesized Modulation) stereo generator allows the transmitter to provide stereo separation of 40 dB minimum, 30-15,000 Hz—while the DTR (Dynamic Transient Response) filter permits a 2 to 6 dB increase in loudness, with no degradation of audio quality, by limiting overshoot to 2% or less.

ONE TUBE DESIGN. Just one tube—a 4CX1000A tetrode—is all that is needed to supply 1000 watts output in the FM-1K. Driven directly by the MS-15 exciter, the 4CX1000A serves as the power amplifier and is operated well within its ratings for long tube life.

PLUG-IN MONO, STEREO AND SCA GENERATORS. The FM-1K may be equipped for mono or stereo operation, with or without SCA. The design versatility of the exciter allows you to order for mono

operation originally, then add stereo and/or SCA at a later date by plugging the appropriate module(s) into the exciter.

STABLE, EASY OUTPUT TUNING. Plate tuning of the final amplifier is stable and easily adjusted. The plate circuit is a shorted one-quarter wavelength configuration, with the plate-line operated at DC ground potential. Coarse plate tuning is preset for the operating frequency on the quarter-wave tank circuit. Fine adjustment is made with the plate tuning knob on the front panel. Amplifier loading is changed by a variable output loading capacitor.

POWER OUTPUT CONTROL. The transmitter's output loading control is motor-driven for smooth power adjustments, either locally or from a remote point. This feature allows the screen voltage of the 4CX1000A to be Zener-diode regulated for exceptional operating stability and tube life.

HARMONIC FILTERS STANDARD. Supplied with a Harris-designed multi-

section harmonic filter, the transmitter fully meets FCC requirements for spurious radiation. The second harmonic shorting stub is mounted inside the transmitter cabinet, leaving the easy-to-install low-pass in-line filter as the only external component.

AUTOMATIC RECYCLING. In case of momentary overload, the transmitter recycles automatically. Should the overload reoccur in excess of the desired number of times preset in the transmitter, the FM-1K will then remain off the air until it is reset, either locally or by remote control.

REMOTE CONTROL. All necessary operating functions can be remote controlled. No additional equipment is required to adapt a Harris remote control system to the transmitter. Connections are easily and simply made at a terminal strip in the cabinet.

TESTING. Environmental tests, in conditions surpassing those of any location a transmitter is likely to encounter, have been imposed on the FM-1K. The transmitter is capable of operating at altitudes up to 10,000 feet (3000 meters), in an ambient temperature range of -20° to $+45^{\circ}$ C.

In addition, your FM-1K is fully tuned and operationally tested on your frequency before shipment.

FULL METERING. Six meters, including four large, front-panel meters, provide full monitoring of the transmitter's operating parameters. Included is a power indicator that permits direct reading of both power output and standing wave ratio.

GENERAL. There are many other operational and convenience features incorporated into the FM-1K. These include:

Pushbutton Operation—On-off functions are controlled by lighted pushbuttons at the top left of the transmitter. These are clearly marked "Filament On-Off", "Plate On-Off".

High-Capacity Blower—backed up by a precision air-pressure switch, gives complete protection to the final amplifier tube.

Straightforward Design—allows easy accessibility to all components.

Handsome Styling—the transmitter cabinet is attractively yet functionally styled, and features a white and blue finish, with a black meter panel.

FCC Type Acceptance—the FM-1K is FCC type accepted for mono or stereo broadcasting in the 87.5 to 108 MHz FM band.

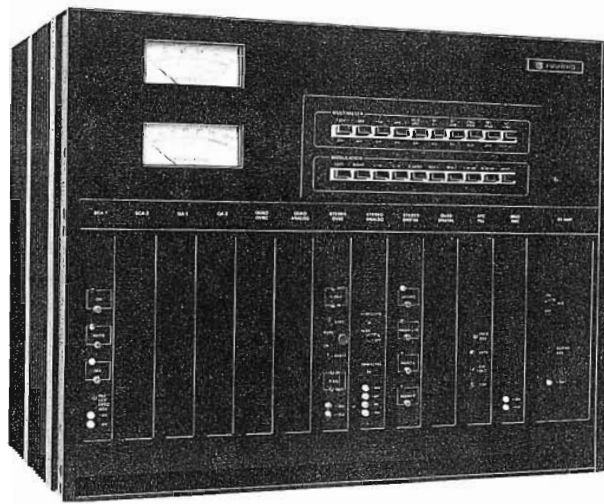

HARRIS' MS-15 . . . THE MOST ADVANCED FM EXCITER IN THE INDUSTRY

The solid-state MS-15 exciter employs Digitally Synthesized Modulation, overshoot compensation, and other exclusive design techniques, to give you an FM sound that is noticeably cleaner, noticeably louder than any competitive signal. The exciter is available for mono or stereo operation, with or without SCA. The modular construction of the MS-15 allows you to change the mode of operation, or to add SCA, at any time, by simply plugging in the appropriate module(s).

FCC approval of a system for quadraphonic FM will not obsolete the MS-15. Module positions exist which are ready to accept a quad generator.

DIGITALLY SYNTHESIZED MODULATION. The DSM stereo generator is a new development which eliminates the tradeoff that exists between switching type and balanced modulator types of stereo generators—poor separation at high frequencies in the former or poor harmonic rejection and SCA crosstalk in the latter. The DSM stereo generator is capable of both 50 dB separation (typical) through 15 kHz and an exceptionally clean baseband, promoting minimal interaction between stereo and SCA service. Also, pilot phase is automatically controlled so that high separation can be maintained under varying operating conditions.

OVERSHOOT COMPENSATION. A Dynamic Transient Response (DTR) filter has been developed by Harris for FM stereo, with overshoot no greater than 2% on any program material processed by any limiter. As a result, from 2 to 6 dB increased loudness can be achieved without degradation of audio quality. Controlled transient response, high stereo separation, low crosstalk, and low intermodulation distortion are all maintained with increased

loudness. For monaural stations wishing to protect 41 and/or 67 kHz SCA channels, a defeatable linear phase lowpass filter is provided for optimal linear control of overshoot.

COMPATIBILITY. The MS-15 exciter is mechanically and electrically compatible with the Harris TE-3 exciter. Mountings are in the same location and use the same hardware.

RF output power is 15 watts into 50 ohms, continuously adjustable to 3 watts by one control. A directional coupler samples and meters forward and reflected power, with remote metering capability. A harmonic filter is placed at the RF module output, reducing harmonics to a low level. The balanced 600 ohm audio input is transformerless to give maximum common mode rejection and excellent response. Inputs will withstand high transients or steady state voltages above or below ground reference.

The basic exciter audio response is wide-band and flat, and can be used directly with a studio-transmitter link. The exciter is self-contained, including the power supply.

OTHER FEATURES. The Harris MS-15 exciter can be quickly and easily programmed to any carrier frequency in the 87.5 to 108 MHz band in 50 kHz increments. The RF output network is broadband and requires no tuning. Carrier frequencies are generated through a digital synthesizer which is locked to a 10 MHz TCXO high stability frequency standard. The TCXO has improved crystal aging characteristics and does not require an oven. The synthesizer also provides outputs at 2.5, 5, 10, 15, 20 and 25 MHz for easy frequency comparison to the National Bureau of Standards WWV transmissions.

Pre-emphasis is selectable to 75, 50, 25 or 0 microseconds in either monophonic or stereophonic operation.

Remote control capability includes switching between stereo and mono, and selection of left, right, or left-plus-right inputs for monophonic operation.

SCA OPERATION. SCA operation is added to the exciter through a plug-in module. It is available with either stereo or mono operation; up to two channels can be added to mono exciters, or a single SCA used with stereo. Any channel between 25 kHz and 75 kHz can be used, although 41 kHz and 67 kHz are normally provided. Either frequency is selectable on the SCA channel card.

Pre-emphasis is selectable to 150, 75, 50 or 0 microseconds. The input audio is applied to a programmable lowpass filter, and the output of the SCA generator filtered so that 150 microseconds pre-emphasis can be used with no degradation of SCA to main channel crosstalk.

Each SCA module has a pair of audio inputs, one AC coupled for audio, and the other DC coupled for data and video transmission.

The subcarrier level is adjustable to provide from 1% to 30% composite baseband SCA injection. When an SCA subcarrier is turned on or off, an automatic composite level switcher noiselessly compensates for the change in baseband injection level. 100% peak modulation is maintained independent of SCA status.

EASE OF MAINTENANCE. The entire exciter is modular for ease of troubleshooting and maintenance. An extender card is provided to allow easy servicing. Extensive metering is provided, and LED status lights on the modules indicate various performance features.

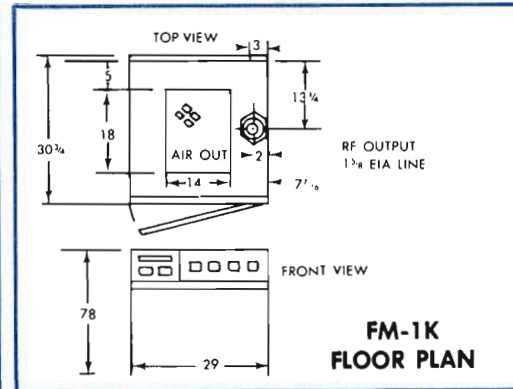
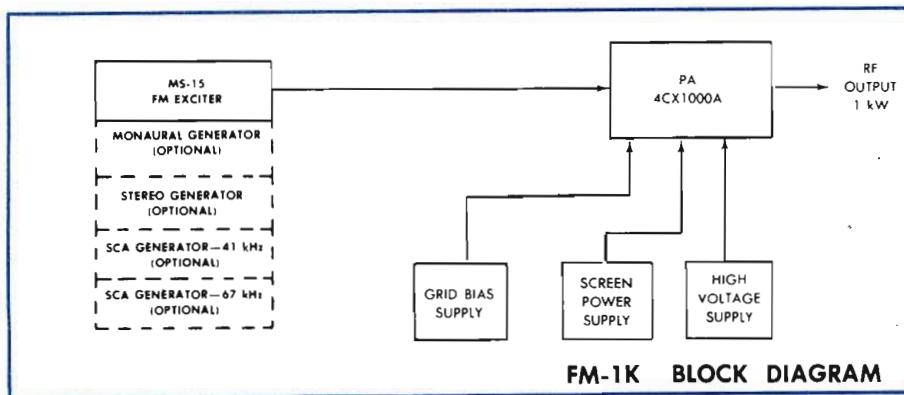

FM-1K SPECIFICATIONS

GENERAL

POWER OUTPUT: One kilowatt.
FREQUENCY RANGE: 87.5 to 108 MHz, tuned to specified operating frequency.
RF OUTPUT IMPEDANCE: 50 ohms.
OUTPUT TERMINATION: 1 1/2" EIA flange.
FREQUENCY STABILITY: ± 300 Hz 0° to 45° C TCXO.
TYPE OF MODULATION: Direct Carrier Frequency Modulation (DCFM).
MODULATION CAPABILITY: ± 100 kHz.
AC INPUT POWER: 208/240 V, 60 or 50 Hz, single phase, three wire. Power consumption: 2100 watts (approx.). 115/230 V, 60 or 50 Hz, 150 watts for MS-15.
RF HARMONICS: Suppression meets all FCC requirements.
POWER SUPPLY RECTIFIERS: Silicon.
ALTITUDE: 10,000 feet (3000 meters).
AMBIENT TEMPERATURE RANGE: -20° C to $+45^\circ$ C.
MAXIMUM VSWR: 1.7 to 1.
OVERALL CABINET SIZE: 29"W (74cm) x 78"H (198cm) x 33"D (84cm).
FRONT DOOR SWING: 29" (74cm).
FINISH: White, blue and black.
WEIGHT & CUBAGE: Export: 1300 lbs. (590 kg). Domestic: 1050 lbs. (476 kg). 104 cu. ft. (2.9 cu. m).

MONAURAL MODE

AUDIO INPUT IMPEDANCE: 600 ohms balanced, resistive, adaptable to other impedances.
INPUT FILTER: Controlled response LPF, defeatable.
AUDIO INPUT LEVEL: $+10$ dBm ± 1 dB for 100% modulation at 400 Hz.
AUDIO FREQUENCY RESPONSE: Standard 75 microsecond FCC pre-emphasis curve ± 0.5 dB, 30-15,000 Hz. Selectable: flat, 25 or 50 microsecond pre-emphasis.
HARMONIC DISTORTION: 0.2% or less, 30-15,000 Hz.
IMD: 0.2%, 60/7000 Hz, 4:1 ratio.
FM NOISE: 68 dB below 100% modulation (ref. 400 Hz @ ± 75 kHz deviation).
AM NOISE: 50 dB below reference carrier AM modulation 100%.

STEREOPHONIC MODE

TYPE OF MODULATION: Digitally Synthesized Modulation (DSM).
AUDIO INPUT IMPEDANCE: (left to right) 600 ohms balanced, resistive. Adaptable to other impedances.
AUDIO INPUT LEVEL: (left and right) $+10$ dBm ± 1 dB for 100% modulation at 400 Hz.
AUDIO FREQUENCY RESPONSE: (left and right) Standard 75 microsecond, FCC pre-emphasis curve ± 0.5 dB 30-15,000 Hz. Selectable: flat, 25 or 50 microsecond pre-emphasis.
INPUT FILTERING: 15 kHz LPF, 45 dB rejection at 19 kHz.
OVERSHOOT PROTECTION: Dynamic transient response (DTR) filter.
AUDIO TRANSIENT RESPONSE: 2% maximum overshoot beyond steady state. Defeatable for test purposes.

HARMONIC DISTORTION: (left or right) 0.4% or less, 30-15,000 Hz.
IMD: 0.4%, 60/7000 Hz, 4:1 ratio.
FM NOISE: (left or right) 65 dB minimum below 100% modulation. Reference: 400 Hz, 75 microsecond de-emphasis, ± 75 kHz deviation.
PILOT OSCILLATOR: Crystal controlled.
PILOT STABILITY: 19 kHz ± 1 Hz, 0° to 45° C.
PILOT PHASE: Automatically controlled.
STEREO SEPARATION: 40 dB minimum 30-15,000 Hz.
CROSSTALK: (main to stereo sub-channel or stereo sub-to-main channel) 45 dB below 90% modulation.
SUB CARRIER SUPPRESSION: 50 dB below 90% modulation.
76 kHz SUPPRESSION: 60 dB minimum below 100% modulation.
MODES: Stereo, mono (L + R), mono (L), mono (R). Remoteable.

SCA SPECIFICATIONS

MODULATION: Direct FM.
FREQUENCY: 41 or 67 kHz programable, any frequency between 25 and 75 kHz on special order.
FREQUENCY STABILITY: ± 500 Hz.
MODULATION CAPABILITY: ± 7.5 kHz.
AUDIO INPUT IMPEDANCE: 600 ohms balanced (AC coupled) and 2000 ohms unbalanced (DC coupled).
AUDIO INPUT LEVEL: $+10$ dBm ± 1 dB for 100% modulation at 400 Hz.
AUDIO FREQUENCY RESPONSE: 41 kHz and 67 kHz, 150 microsecond pre-emphasis ± 1 dB, standard. Selectable: flat, 50 or 75 microsecond pre-emphasis.
INPUT FILTERING: Programable LPF, 4.5 kHz standard.
DISTORTION: Less than 1%, 30-5000 Hz. ± 5 kHz deviation.
FM NOISE: (main channel not modulated) 55 dB minimum (ref: 100% = ± 5 kHz deviation at 400 Hz).
CROSSTALK: (SCA to main or stereo sub-channel): -60 dB or better.
CROSSTALK: (main or stereo sub-channel to SCA): 50 dB below ± 5 kHz deviation of SCA, with mono or stereo channels modulated by frequencies 30-15,000 Hz, SCA demodulated with 150 microsecond de-emphasis.
CROSSTALK: SCA to SCA (41 kHz/67 kHz) 50 dB demodulated with 150 microsecond de-emphasis.
AUTOMATIC MUTE LEVEL: Variable from 0 to -30 dBm.
MUTE DELAY: Adjustable 0.5 to 20 seconds.
INJECTION LEVEL: 1% to 30% of composite. Adjustable.

WIDEBAND MODE

INPUT IMPEDANCE: Greater than 5000 ohms resistive, unbalanced.
INPUT LEVEL: 1.0 VRMS nominal for ± 75 kHz deviation.
AMPLITUDE RESPONSE: ± 0.25 dB, 30 Hz to 75 kHz.
PHASE LINEARITY: $\pm 2^\circ$, 30 Hz to 75 kHz.

Specifications subject to change without notice.

ORDERING INFORMATION

FM-1K, 1 kW FM transmitter with MS-15 exciter, for wideband operation, 50/60 Hz. 994-8046-001
 Mono generator (add for mono operation) 994-8019-001
 DSM stereo generator with DTR (add for stereo operation) 994-8020-001
 SCA generator (add for SCA operation, specify 41 or 67 kHz) 994-7992-001



HARRIS
COMMUNICATION AND
INFORMATION PROCESSING

FM-300KD

**Solid-State Main/Alternate 300-Watt
FM Transmitter**

FM-300K

Solid-State 300-Watt FM Transmitter

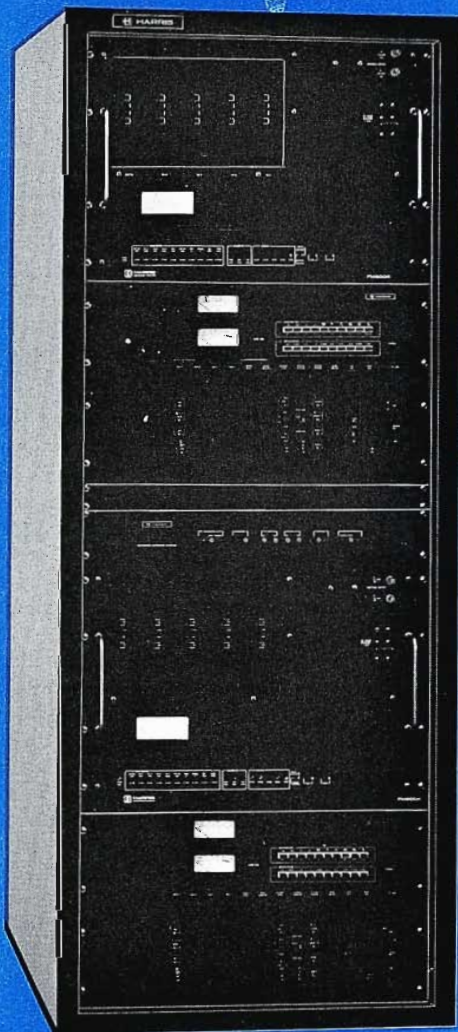

FM-300KD Main/Alternate Transmitter

- All solid state
- Complete backup with optional automatic changeover in FM-300KD
- DSM stereo generator* . . . stereo separation exceeding accurate monitor measurement capability
- DTR filter technique holds overshoot to 2% or less
- 2 to 6 dB increase in loudness
- Improved reliability
- Recycling overload circuit
- Remote control connections
- Full metering
- Plug-in mono, stereo and SCA generators
- No crystals required—field tuneable 87.5 to 108 MHz

* Patented

Harris' 300-watt FM transmitter is available in two configurations—the standard model (FM-300K) and the main/alternate version (FM-300KD) with optional automatic changeover.

The FM-300KD is a completely redundant transmitter designed to give you total protection against off-air time. Consisting of two 300-watt FM transmitters and an optional automatic changeover panel mounted in a single 24-inch wide cabinet, the FM-300KD will automatically switch to the alternate transmitter in case of RF loss from the main unit. This configuration also allows you to perform transmitter maintenance during broadcast hours with no down time.

The FM-300K single transmitter is mounted in the same size cabinet as the FM-300KD, and the extra cabinet space may be utilized for monitoring and test equipment.

Both transmitters are 100% solid state for top reliability, and represent two of the first all-solid-state 300-watt broadband transmitters ever developed. Harris was the first equipment manufacturer to introduce an all-solid-state radio broadcast transmitter—the MW-1, one-kilowatt AM transmitter—and has been delivering these transmitters since early 1975. This solid-state transmitter engineering experience and technology has now been applied to Harris' 300-watt FM transmitters to bring you the most advanced design available anywhere.

The transmitters also incorporate such Harris-developed features as Digitally Synthesized Modulation (DSM) for the very finest stereo signal available; and the Dynamic Transient Response (DTR) filter, which holds overshoot on any program material to 2% or less. Additional features include automatic recycling; an air cooling system with replaceable dust filter; availability of two SCA channels; a wideband input for use with microwave studio-transmitter links; and modular design for ease of maintenance.

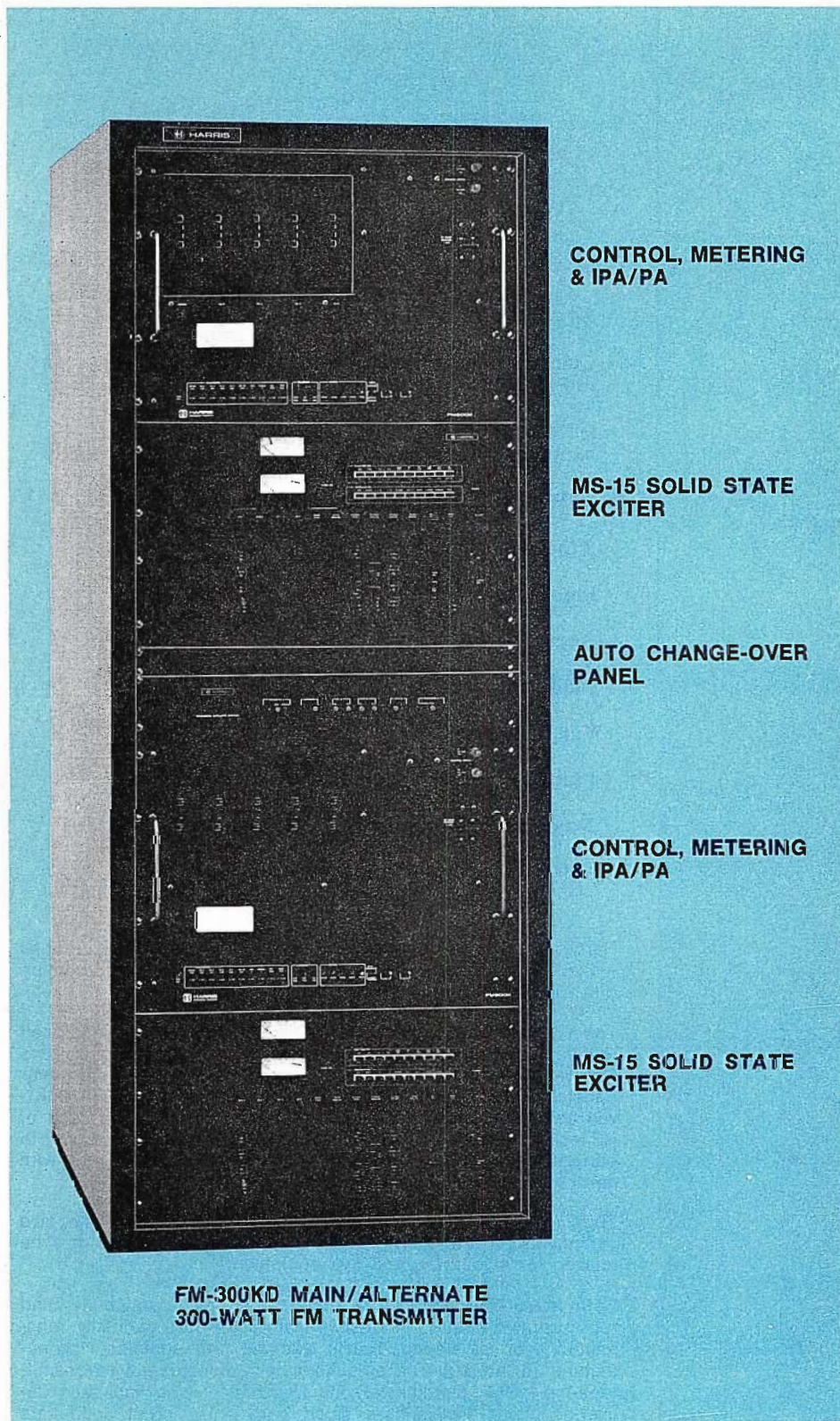

**FM-300KD MAIN/ALTERNATE
300-WATT FM TRANSMITTER**

**CONTROL, METERING
& IPA/PA**

**MS-15 SOLID STATE
EXCITER**

**AUTO CHANGE-OVER
PANEL**

**CONTROL, METERING
& IPA/PA**

**MS-15 SOLID STATE
EXCITER**

the event of an IPA failure for operation at reduced power. Optimum broadband matching of the input provides a low VSWR to the FM exciter over the entire FM band.

CONTROL CIRCUITS. Control function circuits are provided for transmitter turn on, AFC lock, RF mute, air flow, PA overload, and VSWR protection. Remote control interface is also provided. Status lights with memory are provided for VSWR and amplifier overloads. The transmitters are equipped for AC restart in case of a power failure while on the air.

AUTOMATIC RECYCLING. The recycle circuitry is self-clearing and uncomplicated. Should a momentary overload occur, the transmitter will recycle automatically. If the overload occurs in excess of the number of times pre-set, the transmitter will remain off the air until it is reset, either manually or by remote control.

HARMONIC FILTER. An internal (self-contained) harmonic filter is provided which assures compliance with RF harmonic output requirements. It allows coverage of the entire FM band.

DIRECTIONAL COUPLER. An internal directional coupler provides local and remote indication of both forward output power and reflected power. The reflected power section is connected to the control circuit for the purpose of initiating amplifier shutdown in the event of excessive VSWR. The forward power section initiates changeover to the spare amplifier after the output power drops to a pre-determined level (FM-300KD only).

POWER SUPPLY. The DC power supplies for the control circuits and amplifier modules are capable of operation from any conventional 200-260 VAC, 50/60 Hz single phase AC power supply. The PA RF amplifier modules are supplied by a feedback-type integrated circuit voltage regulator whose output is adjustable with a single front panel control. Each voltage regulator can operate with a continuous short on its output safely, without causing further damage, due to its current foldback capability. The IPA voltage regulator is also adjustable. Cooling is provided for regulator devices. Silicon power rectifiers are used throughout.

METERING. Ample transmitter metering is provided for functions including RF output, VSWR, PA DC input voltages and currents, IPA DC input voltage and current, and unregulated supply voltage. LED indicators on the IPA module and PA module front panels give indication of correct RF output for easy fault location.

POWER AMPLIFIER (PA). The power amplifier consists of four modules, each module containing two transistor amplifiers in a highly efficient broadband amplifier circuit. Each module has an individual current protection circuit and voltage regulator. LED status lights indicate the condition of each amplifier. A front panel test point allows a measurement of relative RF power output with a DC voltmeter. The PA RF

broadband output combiner network allows the failure of an amplifier module without causing an off-air condition. Each module is rated at 100 watts, with transmitter power output 300 watts nominal.

INTERMEDIATE POWER AMPLIFIER (IPA). The IPA is identical to the PA modules, and can be interchanged with a PA module in

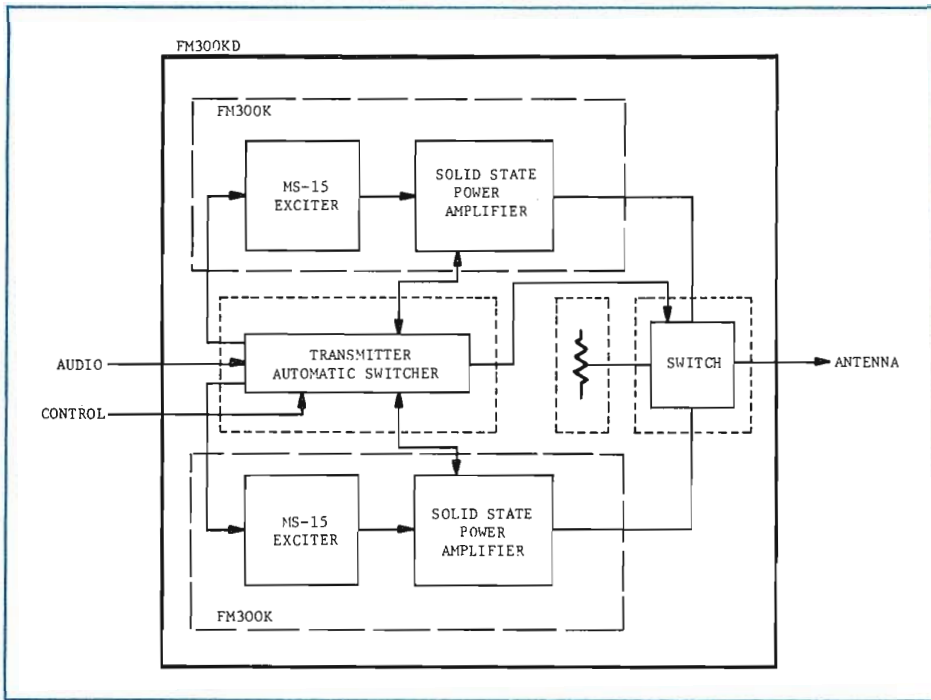
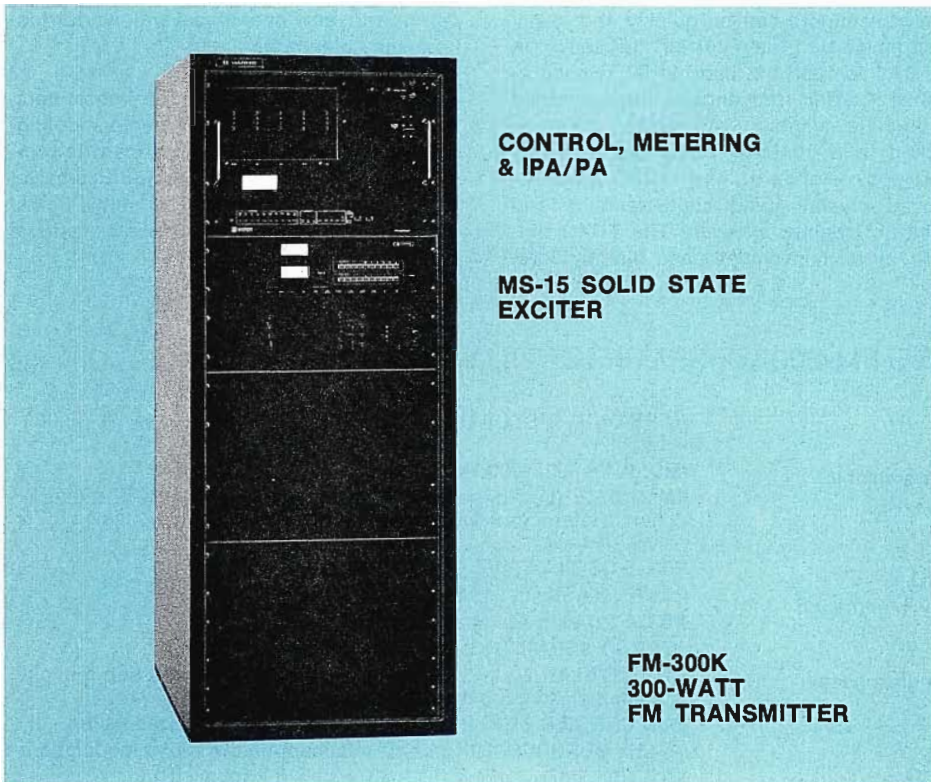

Block diagram of FM-300KD transmitter system, with optional equipment shown inside dotted lines.

QUALITY COMPONENTS. Every transmitter component is conservatively operated and chosen to give optimum performance in continuous duty service.

PLUG-IN MONO, STEREO AND SCA GENERATORS. The FM-300K and FM-300KD transmitters may be equipped for mono or stereo operation, with or without SCA. The design versatility allows you to order for mono operation originally, then add stereo

and/or SCA at a later date by plugging the appropriate module(s) into the exciter. Since the SCA generators have spectrally pure filtered outputs, 41 and 67 kHz SCA channels may be operated simultaneously while in the mono mode without harmonic interference.

DIGITALLY SYNTHESIZED MODULATION (DSM). The DSM stereo generator is an

advanced development which eliminates the tradeoff that exists between switching type and balanced modulator types of stereo generators—poor separation at high frequencies in the former or poor harmonic rejection and SCA crosstalk in the latter. The DSM stereo generator is capable of both 50 dB separation (typical) through 15 kHz and an exceptionally clean baseband, promoting minimal interaction between stereo and SCA service. Also, pilot phase is automatically controlled so that high separation can be maintained under varying operating conditions.

OVERSHOOT COMPENSATION. A Dynamic Transient Response (DTR) filter has been developed by Harris for FM stereo, with overshoot no greater than 2% on any program material processed by any limiter. As a result, from 2 to 6 dB increased loudness can be achieved without degradation of audio quality. Controlled transient response, high stereo separation, low crosstalk, and low intermodulation distortion are all maintained with increased loudness. For monaural stations wishing to protect 41 and/or 67 kHz SCA channels, a defeatable linear phase low pass filter is provided for optimal linear control of overshoot.

SCA OPERATION. Up to two SCA channels can be added to monaural transmitters, or a single SCA channel added to a stereo transmitter through module(s) plugged into the exciter. Any channel between 25 kHz and 75 kHz can be used, although 41 kHz and 67 kHz are normally provided. Either frequency is selectable on the SCA channel card.

Pre-emphasis is selectable to 150, 75, 50 or 0 microseconds. The input audio is applied to a programmable lowpass filter, and the output of the SCA generator filtered so that 150 microseconds pre-emphasis can be used with no degradation of SCA to main channel crosstalk.

Each SCA module has a pair of modulation inputs, one balanced and AC coupled for audio, and the other DC coupled for data and video transmission.

The subcarrier level is adjustable to provide from 1% to 30% composite baseband SCA injection. When an SCA subcarrier is turned on or off, an automatic composite level switcher noiselessly compensates for the change in baseband injection level. 100% peak modulation is maintained independent of SCA status.

GENERAL. The MS-15 exciter RF output power is 3 to 15 watts into 50 ohms, continuously adjustable by one control. A di-

rectional coupler samples and meters forward and reflected power, with remote metering capability. A harmonic filter is placed at the RF module output, reducing harmonics to a low level. The balanced 600 ohm audio input is transformerless to give maximum common mode rejection and excellent transient response. Inputs will withstand high transients or steady voltages above or below ground reference.

The transmitters can be quickly and easily programmed to any carrier frequency in the 87.5 to 108 MHz band in 50 kHz increments. Carrier frequencies are generated through a digital synthesizer which is locked to a 10 MHz TCXO high stability frequency standard. The TCXO has improved crystal aging characteristics and does not require an oven. The TCXO output may be conveniently and directly com-

pared with any one of several worldwide frequency standards.

EASE OF MAINTENANCE. The transmitters are modular for ease of trouble-shooting and maintenance. An extender card is provided to allow easy servicing. Extensive metering is provided, and LED status lights on the exciter modules indicate various performance features.

FM-300K/FM-300KD SPECIFICATIONS

GENERAL

POWER OUTPUT: 300 watts.

FREQUENCY RANGE: 87.5 to 108 MHz. Exciter programmable in 50 kHz increments. IPA and PA wideband.

RF OUTPUT IMPEDANCE: 50 ohms.

OUTPUT TERMINATION: Type N female.

FREQUENCY STABILITY: ± 300 Hz 0° to 45° C TCXO.

TYPE OF MODULATION: Direct Carrier Frequency Modulation (DCFM).

MODULATION CAPABILITY: ± 100 kHz.

AC INPUT POWER: 208 to 245 VAC, 50 or 60 Hz. Single phase, $\pm 5\%$ variation.

RF HARMONICS: 60 dB or better.

POWER SUPPLY RECTIFIERS: Silicon.

ALTITUDE: 12,000 ft. (3658 meters) maximum at rated ambient.

AMBIENT TEMPERATURE RANGE: 0° C to $+50^\circ$ C.

HUMIDITY: Up to 95% non-condensing.

MAXIMUM VSWR: 1.2 to 1.

OVERALL CABINET SIZE: Approx. $27\frac{3}{4}$ " W x $71\frac{3}{4}$ " H x $29\frac{3}{4}$ " D (70.5 cm x 182.3 cm x 75.6 cm).

FINISH: White, blue and black.

MONAURAL MODE

AUDIO INPUT IMPEDANCE: 600 ohms balanced, resistive, adaptable to other impedances.

INPUT FILTER: Controlled response LPF, defeatable.

AUDIO INPUT LEVEL: $+10$ dBm ± 1 dB for 100% modulation at 400 Hz.

AUDIO FREQUENCY RESPONSE: Standard 75 microsecond FCC pre-emphasis curve ± 0.5 dB, 30-15,000 Hz. Selectable: flat, 25 or 50 microsecond pre-emphasis.

HARMONIC DISTORTION: 0.2% or less, 30-15,000 Hz.

IMD: 0.2%, 60/7000 Hz, 4:1 ratio.

FM NOISE: 68 dB below 100% modulation (ref. 400 Hz @ ± 75 kHz deviation).

AM NOISE: 65 dB below reference carrier AM modulation 100%.

STEREOPHONIC MODE

TYPE OF MODULATION: Digitally Synthesized Modulation (DSM).

AUDIO INPUT IMPEDANCE: (Left to right) 600 ohms balanced, resistive. Adaptable to other impedances.

AUDIO INPUT LEVEL: (Left and right) $+10$ dBm ± 1 dB for 100% modulation at 400 Hz.

AUDIO FREQUENCY RESPONSE: (Left and right) Standard 75 microsecond, FCC pre-emphasis curve ± 0.5 dB 30-15,000 Hz. Selectable: flat, 25 or 50 microsecond pre-emphasis.

INPUT FILTERING: 15 kHz LPF, greater than 45 dB rejection at 19 kHz.

OVERSHOOT PROTECTION: Dynamic transient response (DTR) filter.

AUDIO TRANSIENT RESPONSE: 2% maximum overshoot beyond steady state. Defeatable for test purposes.

HARMONIC DISTORTION: (Left or right) 0.4% or less, 30-15,000 Hz.

IMD: 0.4%, 60/7000 Hz, 4:1 ratio.

FM NOISE: (Left or right) 65 dB minimum below 100% modulation. Reference: 400 Hz, 75 microsecond de-emphasis, ± 75 kHz deviation.

PILOT OSCILLATOR: Crystal controlled.

PILOT STABILITY: 19 kHz ± 1 Hz, 0° to 45° C.

PILOT PHASE: Automatically controlled.

STEREO SEPARATION: 40 dB minimum 30-15,000 Hz.

CROSSTALK: (Main to stereo sub-channel or stereo sub-to-main channel) 45 dB below 90% modulation.

SUB CARRIER SUPPRESSION: 60 dB below 90% modulation.

76 kHz SUPPRESSION: 60 dB minimum below 100% modulation.

MODES: Stereo, mono (L + R), mono (L), mono (R). Remoteable.

SCA SPECIFICATIONS

MODULATION: Direct FM.

FREQUENCY: 41 or 67 kHz programmable, any frequency between 25 and 75 kHz on special order.

FREQUENCY STABILITY: ± 500 Hz.

MODULATION CAPABILITY: ± 7.5 kHz.

AUDIO INPUT IMPEDANCE: 600 ohms balanced (AC coupled) and 2000 ohms unbalanced (DC coupled).

AUDIO INPUT LEVEL: $+10$ dBm ± 1 dB for 100% modulation at 400 Hz.

AUDIO FREQUENCY RESPONSE: 41 kHz and 67 kHz, 150 microsecond pre-emphasis ± 1 dB, standard. Selectable: flat, 50 or 75 microsecond pre-emphasis.

INPUT FILTERING: Programmable LPF, 4.5 kHz standard.

DISTORTION: Less than 1%, 30-4500 Hz. ± 5 kHz deviation.

FM NOISE: (Main channel not modulated) 55 dB minimum (Ref: 100% = ± 5 kHz deviation at 400 Hz).

CROSSTALK: (SCA to main or stereo sub-channel): -60 dB or better.

CROSSTALK: (Main or stereo sub-channel to SCA): 50 dB below ± 5 kHz deviation of SCA, with mono or stereo channels modulated by frequencies 30-15,000 Hz, SCA demodulated with 150 microsecond de-emphasis.

CROSSTALK: SCA to SCA (41 kHz/67 kHz) 50 dB demodulated with 150 microsecond de-emphasis.

AUTOMATIC MUTE LEVEL: Variable from 0 to -30 dBm.

MUTE DELAY: Adjustable 0.5 to 20 seconds.

INJECTION LEVEL: 1% to 30% of composite. Adjustable.

WIDEBAND MODE

INPUT IMPEDANCE: Greater than 5000 ohms resistive, unbalanced.

INPUT LEVEL: 1.0 VRMS nominal for ± 75 kHz deviation.

AMPLITUDE RESPONSE: ± 0.25 dB, 30 Hz to 75 kHz.

PHASE LINEARITY: $\pm 2^\circ$, 30 Hz to 75 kHz.



HARRIS
COMMUNICATION AND
INFORMATION PROCESSING

MS-15

Maximum Signal FM Exciter

- Patented DSM Stereo Generator provides separation exceeding accurate measurement capability of most monitors
- DTR filter technique permits 2 to 6 dB loudness increase by eliminating overshoot
- Ultra linear VCO for minimum distortion
- Ovenless TCXO provides maximum stability
- System design virtually eliminates crosstalk into L-R and SCA channels under dynamic and steady state conditions
- Automatic pilot phase control and digital circuitry give long-term high performance
- MS-15--the first significant advance in FM excitors in over a decade

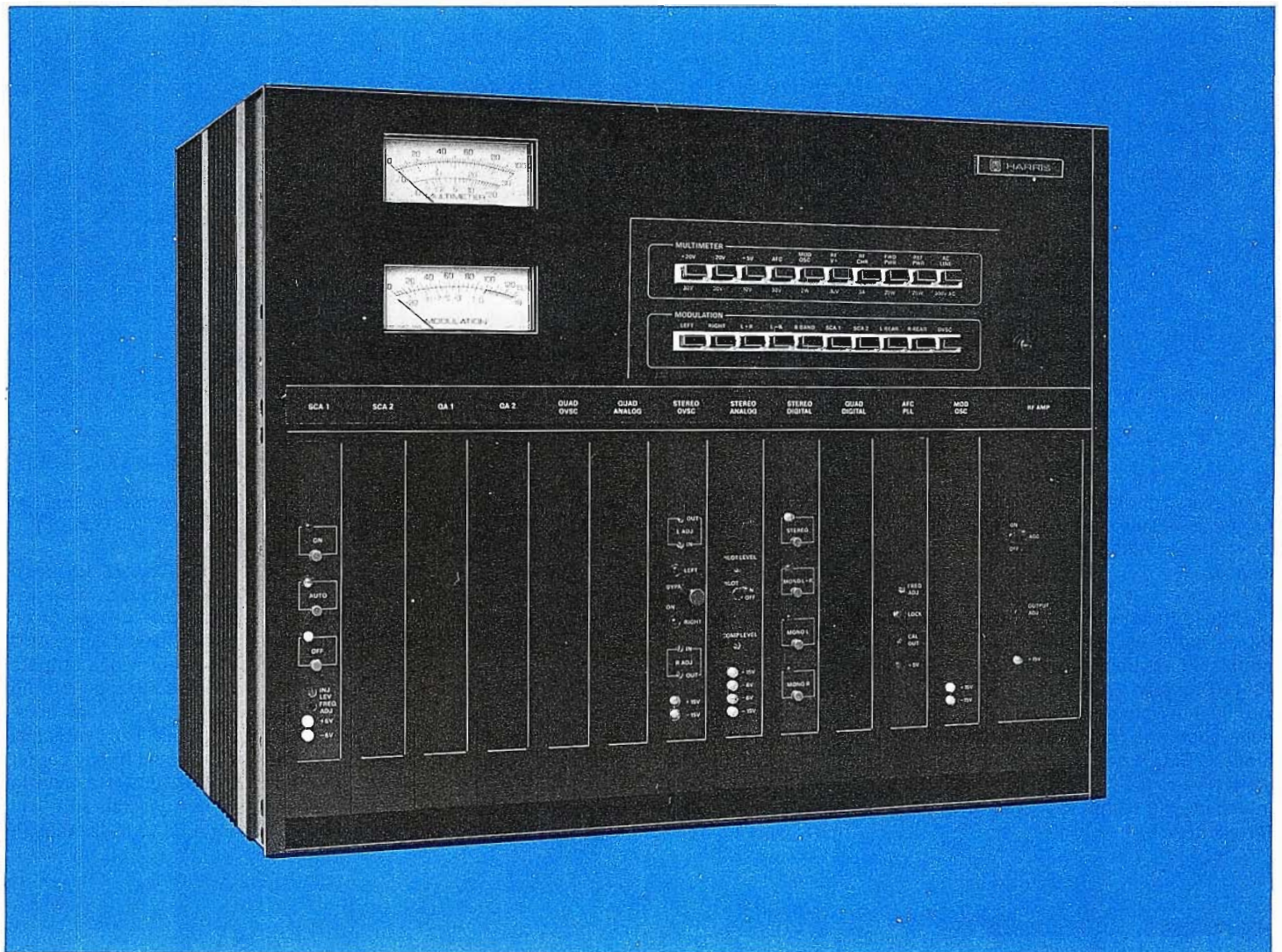

HARRIS' MS-15

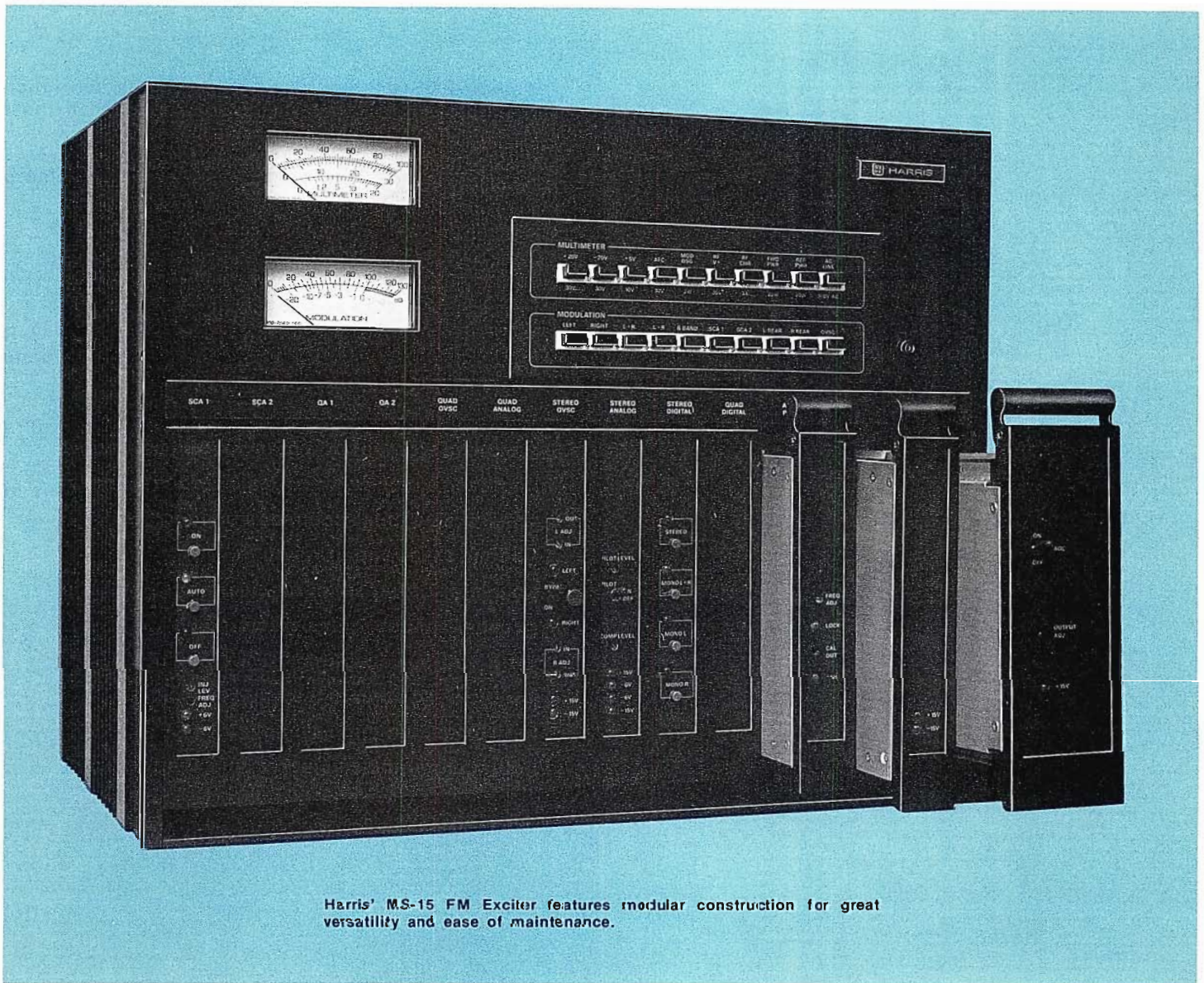

Harris' MS-15 FM Exciter features modular construction for great versatility and ease of maintenance.

A few years ago, Harris introduced PDM to the AM broadcaster and sent hundreds of conventional AM transmitters to standby service.

The MS-15 FM exciter now makes all other FM exciters as obsolete as the plate modulated AM transmitter. Using patented DSM (Digitally Synthesized Modulation) and DTR (Dynamic Transient Response) techniques, the MS-15 offers the quality-minded FM broadcaster the first real alternative to the "me-too" designs, based on decade-old technology, found in other FM exciters.

ULTRA-LINEAR VCO. The unique VCO of the MS-15 features superb linearity not found in conventional modulated oscillator designs. The 0.2% maximum monaural distortion specification is conservative, and typical readings below this limit are not unusual.

Since non-linearities in any direct FM modulated oscillator severely limit stereo performance, the importance of this ultra linearity can easily be seen. Performance is not compromised by complexity. There are no tuning adjustments required of any kind. Only a single jumper is used to select

either the lower or upper half of the FM band!

DIGITAL SYNTHESIZER. The MS-15 uses a 10 MHz TCXO high-stability reference oscillator and programmable divider chain in its dual-state phase locked loop AFC system. The synthesizer provides outputs at 2.5, 5, 10, 15, 20 and 25 MHz, permitting direct comparison against WWV transmissions on these frequencies. The synthesizer can be easily programmed to any carrier frequency in the 87.5 to 108 MHz band in 50 kHz increments. The dual state AFC will acquire the VCO over a ± 10 MHz range in

THE MOST ADVANCED FM EXCITER IN THE INDUSTRY

a maximum of 5 seconds, starting from an unlocked condition. Once locked, the AFC passband is narrowed, maximizing FM signal to noise.

DIGITALLY SYNTHESIZED MODULATION.

The DSM stereo generator is a new, patented development that obsoletes switching and balanced modulator forms of stereo generation. While these earlier types of stereo generation suffer from degraded separation at the lower and upper frequency limits (50 Hz and 15 kHz), and/or poor harmonic rejection resulting in degraded crosstalk, DSM has neither of these trade-offs. This results in the cleanest-sounding stereo performance of any FM exciter. Minimum separation is 45 dB from 30 to 15,000 Hz and typically separation will exceed 50 dB over this entire band. Since this exceeds guaranteed accuracy of most modulation monitors, only carefully calibrated test equipment will be able to accurately measure the actual performance of the MS-15.

The high performance characteristics of the DSM generator are easy to maintain year after year. The digital circuitry employed reduces user adjustments to a bare minimum, and these are relatively non-critical in nature. An automatic pilot phase control makes it virtually impossible to misadjust this critical parameter.

OVERSHOOT COMPENSATION. A Dynamic Transient Response (DTR) filter was developed by Harris for FM stereo which holds overshoot on any program material to 2% or less. As a result, from 2 to 6 dB increased loudness can be achieved with no degradation of audio quality. Controlled transient response, high stereo separation, low crosstalk and low intermodulation distortion are all maintained with the increased loudness.

SCA OPERATION. Up to 2 optional SCA generators may be plugged into the exciter mainframe. A balanced 600 ohm input is provided for normal SCA program audio, and a separate DC coupled wideband input to the generator's direct FM modulator is provided for telemetry or data transmission where DC coupling is required. Crosstalk under dynamic programming conditions, which plagues many SCA generation systems, is virtually inaudible in the MS-15 exciter system.

POWER AMPLIFIER. The power amplifier module is conservatively rated at 15 watts output, and requires no tuning across the entire FM band. A lowpass filter with one tuning adjustment keeps RF harmonics to less than -53 dB. The output is VSWR protected to prevent accidental damage to the PA.

GENERAL. The MS-15 mainframe is

ruggedly constructed from interlocking aluminum extrusions. A positive guidance system permits easy removal and reinsertion of all modules. All modules can be serviced from the front of the exciter using the extender card supplied with the exciter.

Audio inputs are transformerless and balanced to give maximum common mode rejection while maintaining excellent response. Inputs will withstand high transients or steady state voltages above or below ground reference.

The basic exciter audio response is wideband and flat, and can be used, without interface, directly with a studio-transmitter link.

The exciter is configured to accept a plug-in quadrasonic FM generator and provides metering of Left and Right rear audio inputs. All of the five competing quadrasonic systems currently under consideration by the FCC can be accommodated by the MS-15.

Status LED indicators are used throughout to aid in troubleshooting. Metering is provided to monitor 20 functions. A peak reading audio voltmeter aids in setting up the exciter on tones, and can serve as an accurate peak program indicator.

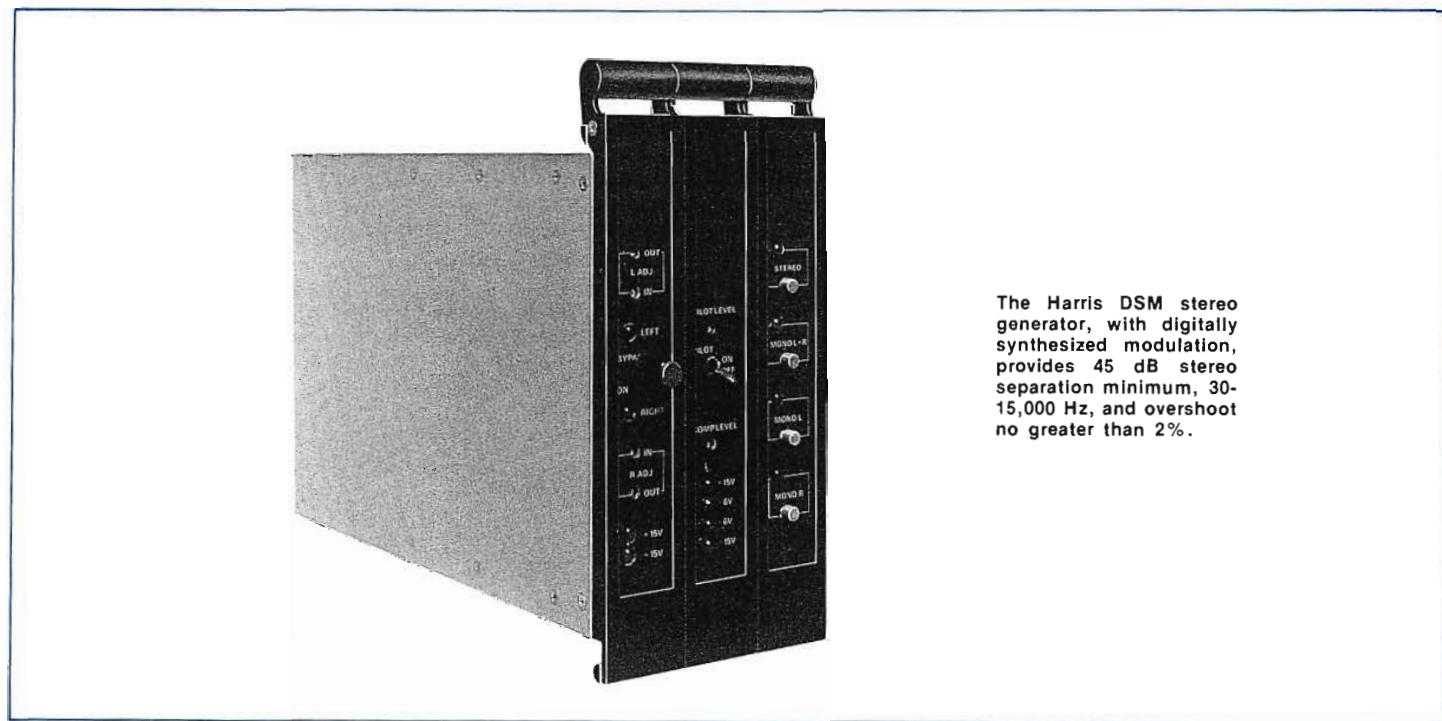

The Harris DSM stereo generator, with digitally synthesized modulation, provides 45 dB stereo separation minimum, 30-15,000 Hz, and overshoot no greater than 2%.

MS-15 SPECIFICATIONS

GENERAL

POWER OUTPUT: 3W to 15W, continuously variable.
FREQUENCY RANGE: 87.5 to 108 MHz, tuned to specified operating frequency (programmable, 50 kHz channel spacing).
RF OUTPUT IMPEDANCE: 50 ohms, open and short circuit proof.
OUTPUT CONNECTION: BNC.
FREQUENCY STABILITY: ± 300 Hz 0° to 50° C, TCXO.
TYPE OF MODULATION: Direct Carrier Frequency Modulation (DCFM).
MODULATION CAPABILITY: ± 100 kHz.
AC INPUT POWER: 100 to 130 VAC or 200 to 260 VAC, 60 or 50 Hz, 150 W.
RF HARMONICS: Suppression meets all FCC requirements for 10 watt educational (53 dB).
POWER SUPPLY RECTIFIERS: Silicon.
ALTITUDE: 15,000 ft.
AMBIENT TEMPERATURE RANGE: 0° C to 50° C (operational to -20° C).
OVERALL CABINET SIZE: 17.7" W (44 cm) x 14"H (35 cm) x 12"D (30 cm). (19" rack mounting standard)
FINISH: Black
AUDIO/CONTROL CONNECTIONS: 2 x 18 pin barrier strips paralleled by 36 pin and socket connector.
MODULATION METER: 10 position, fast rise A/C metering (adjustable to meet FCC ballistics).
MULTIMETER: 10 position, DC metering.

MONAURAL MODE

AUDIO INPUT IMPEDANCE: 600 ohms balanced, resistive, adaptable to other impedances.
INPUT FILTER: Controlled response LPF, defeatable.
AUDIO INPUT LEVEL: +10 dBm ± 1 dB for 100% modulation at 400 Hz.
AUDIO FREQUENCY RESPONSE: Standard 75 microsecond FCC pre-emphasis curve ± 0.5 dB, 30-15,000 Hz. Selectable: flat, 25 or 50 microsecond pre-emphasis.
HARMONIC DISTORTION: 0.2% or less, 30-15,000 Hz.
IMD: 0.2%, 60/7000 Hz, 4:1 ratio.
FM NOISE: 68 dB below 100% modulation (ref. 400 Hz @ ± 75 kHz deviation, measured 30 Hz to 15 kHz with 75 microsecond de-emphasis).
AM NOISE: 70 dB below reference carrier AM modulation 100%, P out = 15 W.

STEREOPHONIC MODE

TYPE OF MODULATION: Digitally synthesized modulation (DSM).
AUDIO INPUT IMPEDANCE: (left and right) 600 ohms balanced, resistive. Adaptable to other impedances.
AUDIO INPUT LEVEL: (left and right) +10 dBm ± 1 dB for 100% modulation at 400 Hz.
AUDIO FREQUENCY RESPONSE: (left and right). Standard 75 microsecond, FCC pre-emphasis curve ± 0.5 dB 30-15,000 Hz. Selectable: flat, 25 or 50 microsecond pre-emphasis.
INPUT FILTERING: 15 kHz LPF, 45 dB rejection at 19 kHz.
OVERSHOOT PROTECTION: Dynamic transient response (DTR) filter.

AUDIO TRANSIENT RESPONSE: 2% maximum overshoot beyond steady state. Defeatable for test purposes.
HARMONIC DISTORTION: (left or right). 0.4% or less, 30-15,000 Hz.
IMD: 0.4%, 60/7000 Hz, 4:1 ratio.
FM NOISE: (left or right) 65 dB minimum below 100% modulation. Reference: (400 Hz, 75 microsecond de-emphasis, ± 75 kHz deviation, measured 30 Hz to 15 kHz).
PILOT OSCILLATOR: Crystal controlled.
PILOT STABILITY: 19 kHz ± 1 Hz, 0° to 50° C.
PILOT PHASE: Automatically controlled.
STEREO SEPARATION: 45 dB minimum, 30-15,000 Hz.
DYNAMIC STEREO SEPARATION: 40 dB minimum under normal programming conditions.
CROSSTALK: (main to stereo sub-channel or stereo sub-to-main channel) 45 dB below 90% modulation.
SUB-CARRIER SUPPRESSION: 60 dB below 100% modulation.
76 kHz SUPPRESSION: 60 dB minimum below 100% modulation.
MODES: Stereo, mono (L + R) mono (L), mono (R). Remoteable.

SCA SPECIFICATIONS

MODULATION: Direct FM
FREQUENCY: 41 or 67 kHz programmable, any frequency between 25 and 75 kHz on special order.
FREQUENCY STABILITY: ± 500 Hz.
MODULATION CAPABILITY: ± 7.5 kHz.
AUDIO INPUT IMPEDANCE: 600 ohms balanced (AC coupled) and 2000 ohms unbalanced (DC coupled, BNC connections on rear panel).
AUDIO INPUT LEVEL: +10 dBm ± 1 dB for 100% modulation at 400 Hz.
AUDIO FREQUENCY RESPONSE: 41 kHz and 67 kHz, 150 microsecond pre-emphasis ± 1 dB, standard. Selectable: flat, 50 or 75 microsecond pre-emphasis.
INPUT FILTERING: Programmable LPF, 4.5 kHz standard.
DISTORTION: Less than 1%, 30-4,500 Hz. ± 5 kHz deviation.
FM NOISE: (Main channel not modulated) 55 dB minimum (ref: 100% = ± 5 kHz deviation at 400 Hz).
CROSSTALK: (SCA to main or stereo sub-channel); -60 dB or better.
CROSSTALK: (Main or stereo sub-channel to SCA); 50 dB below ± 5 kHz deviation of SCA, with mono or stereo channels modulated by frequencies 30-15,000 Hz, SCA demodulated with 150 microsecond de-emphasis.
CROSSTALK: SCA to SCA (41 kHz/67 kHz) 50 dB demodulated with 150 microsecond de-emphasis.
AUTOMATIC MUTE LEVEL: Variable from 0 to -30 dBm.
MUTE DELAY: Adjustable 0.5 to 20 seconds.
INJECTION LEVEL: 1% to 30% of composite. Adjustable.

WIDEBAND MODE

INPUT CONNECTOR: BNC.
INPUT IMPEDANCE: Greater than 5000 ohms resistive, unbalanced.
INPUT LEVEL: 1.0 VRMS nominal for ± 75 kHz deviation.
AMPLITUDE RESPONSE: ± 0.25 dB, 30 Hz to 75 kHz.
PHASE LINEARITY: $\pm 2^\circ$, 30 Hz to 75 kHz.

ORDERING INFORMATION:

MS-15 exciter, for wideband operation, 19 inch rack mounted	994-7950-002
Mono option (add for mono operation)	994-8019-001
DSM stereo generator with DTR (add for stereo operation)	994-8020-001
SCA generator (add for SCA operation, specify 41 or 67 kHz)	994-7992-001



HARRIS
COMMUNICATIONS AND
INFORMATION HANDLING

MS-15R

FM STEREO GENERATOR

- Drives composite Studio-Transmitter Links or wideband input of any FM exciter
- Uses the same Digitally Synthesized Modulation (DSM) and Dynamic Transient Response (DTR) plug-in modules as Harris' MS-15 FM exciter
- Output module features a true peak reading Light-Emitting Diode (LED) display of all stereo functions
- Active transformerless inputs for best transient response
- Low output impedance for driving lengths of coaxial cable
- Digital circuitry design reduces adjustments to a minimum
- Unique compensation circuit for use with STL's
- All operating controls are on the front panel
- Modular construction for ease of maintenance
- Standard 19-inch rack mounting

The MS-15R stereo generator is an exclusive Harris development that features Digitally Synthesized Modulation (DSM) and Dynamic Transient Response (DTR). This generator offers the quality-minded FM broadcaster the first real advancement in stereo generation in a decade—and obsoletes switching and balanced modulator forms of stereo generation.

While these earlier types of stereo generation suffer from degraded separation at the lower and upper frequency limits (30 Hz and 15 kHz), and/or poor harmonic rejection resulting in degraded crosstalk, DSM has neither of these trade-offs. This results in the cleanest-sounding stereo performance of any stereo generator. Minimum separation is 45 dB from 30 to 15,000 Hz and typical separation will exceed 50 dB over this entire band. Since this exceeds the guaranteed accuracy of most modulation monitors, carefully calibrated test equipment is required to measure the actual performance of the MS-15R.

The high performance characteristics of the DSM generator are easy to maintain year after year. The digital circuitry reduces user adjustments to a minimum, and these adjustments are relatively non-critical in nature. An "automatic" pilot phase control assures long-term stability of this critical parameter.

OVERSHOOT COMPENSATION. The Dynamic Transient Response filter, developed by Harris for FM stereo, holds overshoot on any program material to 2% or less, and can be used with any FM limiter. As a result, from 2 to 6 dB increased loudness can be achieved with no degradation of audio quality. Controlled transient response, high stereo separation, low crosstalk and low intermodulation distortion are all maintained with the increased loudness.

GENERAL. The modular MS-15R is ruggedly constructed and designed for rack mounting. A positive guidance system permits easy removal and reinsertion of modules, which can be serviced from the front of the generator.

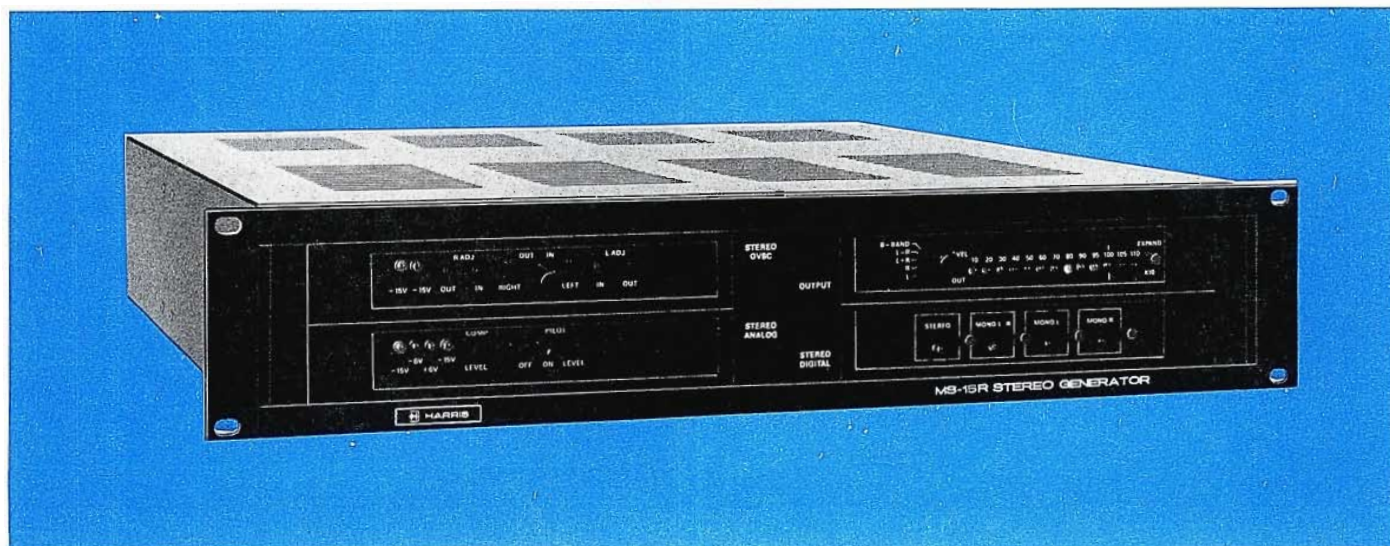

Audio inputs are transformerless and balanced to give maximum common mode rejection while maintaining excellent transient and frequency response. Inputs will withstand high transients or steady state voltages above or below ground level.

LED status indicators are used throughout to aid in troubleshooting. A peak-reading audio LED display aids in set-

ting up the stereo generator, and also serves as an accurate peak program indicator.

The MS-15R can be used with any FM exciter that will accept a wideband input, and is FCC type accepted for use with the Harris MS-15 exciter.

MS-15R SPECIFICATIONS

AC INPUT POWER: 100 to 130 VAC or 200 to 260 VAC, 60 Hz or 50 Hz, 25 W.

HUMIDITY RANGE: 0 to 95% relative humidity, non-condensing.

ALTITUDE: 15,000 feet A.M.S.L.

AMBIENT TEMPERATURE RANGE: 0° C to +50° C (operational to -20° C).

OVERALL CABINET SIZE: 17.6 in. wide (44.7 cm) x 3.5 in. high (8.9 cm) x 15.8 in. deep (40.1 cm). (19-inch rack mounting standard). Net weight: 18 pounds (8.2 kg).

FINISH: Black with white lettering.

AUDIO/CONTROL CONNECTIONS: 12-position barrier strip.

MODULATION METERING: Output module features a true peak reading LED display of Left, Right, L+R, L-R, Pilot Injection and Composite Levels.

COMPOSITE OUTPUT LEVEL: Adjustable from less than 1 V RMS to greater than 4.5 V RMS for 100% modulation.

COMPOSITE OUTPUT IMPEDANCE: 150 ohms unbalanced, resistive (BNC connector).

EXTERNAL COMPOSITE INPUT FOR ADDITIONAL SCA'S OR TELEMTRY: 10K resistive, unbalanced, BNC connector. Amplitude response ± 0.25 dB, 30 Hz to 75 kHz.

COMPOSITE BASEBAND COMPENSATION: Compensator provides separate amplitude and phase compensation for STL or modulated oscillator deficiencies. (Defeatable.)

RFI PROTECTION: All inputs filtered from 100 kHz through 1000 MHz.

TYPE OF MODULATION: Digitally synthesized modulation (DSM).

AUDIO INPUT IMPEDANCE: (left and right) 600 ohms balanced, resistive. Adoptable to other impedances.

AUDIO INPUT LEVEL: (left and right) +10 dBm ± 1 dB for 100% modulation at 400 Hz.

AUDIO FREQUENCY RESPONSE: (left and right) standard 75 microsecond, FCC pre-emphasis curve ± 0.5 dB, 30-15,000 Hz. Selectable: flat, 25 or 50 microsecond pre-emphasis.

INPUT FILTERING: 15 kHz LPF, 50 dB minimum rejection at 19 kHz and above.

OVERSHOOT PROTECTION: Dynamic transient response (DTR) filter.

AUDIO TRANSIENT RESPONSE: 2% maximum overshoot beyond steady state. Defeatable for test purposes.

HARMONIC DISTORTION: (left or right) 0.4% or less, 30-15,000 Hz.

IMD: 0.4%, 60/7000 Hz, 4:1 ratio.

NOISE: (left or right) 75 dB minimum below 100% modulation. Reference: (400 Hz, 75 microsecond de-emphasis, 1 V RMS output, measured 30 Hz to 15 kHz).

PILOT OSCILLATOR: Crystal controlled.

PILOT STABILITY: 19 kHz ± 1 Hz, 0° to 50° C.

PILOT PHASE: Automatically controlled.

STEREO SEPARATION: 45 dB minimum, 30-15,000 Hz.

DYNAMIC STEREO SEPARATION: 40 dB minimum under normal programming conditions.

CROSSTALK: (main to stereo sub-channel or stereo sub-to-main channel) 45 dB below 90% modulation.

SUB-CARRIER SUPPRESSION: 60 dB minimum below 100% modulation.

76 KHZ SUPPRESSION: 60 dB minimum below 100% modulation.

MODES: Stereo, mono (L+R), mono (L), mono (R). Remoteable.

ORDERING INFORMATION

MS-15R Stereo Generator 994-8140-001



HARRIS
COMMUNICATION AND
INFORMATION PROCESSING

FMH SUPER-POWER CIRCULARLY POLARIZED FM ANTENNA

- High power handling capability
- Internal feed point to radiating element
- Multi-station capability
- Excellent bandwidth characteristics
- Rugged brass construction
- Silver plated inner-conductor connectors
- Radiused element tips to avoid corona problems
- Stainless steel support brackets and hardware

The Harris super-power FMH circularly polarized FM antennas feature unusually high power handling capabilities, excellent bandwidth characteristics, and multi-station capability.

RADIATING ELEMENT. The radiating element is of brass construction, and has an outside diameter of 3- $\frac{1}{8}$ ". The feed point is completely internal, with a pressurized environment up to the feed point. Each element is rated at 40 kW, with the exceptions of the "A" series end fed 1 and 2 bay antennas and the center fed 2 bay, which are rated at 32, 35 and 39 kW respectively. Element ratings are limited only by the average power handling capability of the 3- $\frac{1}{8}$ " rigid coaxial line, which we have conservatively derated from 48 kW to 40 kW.

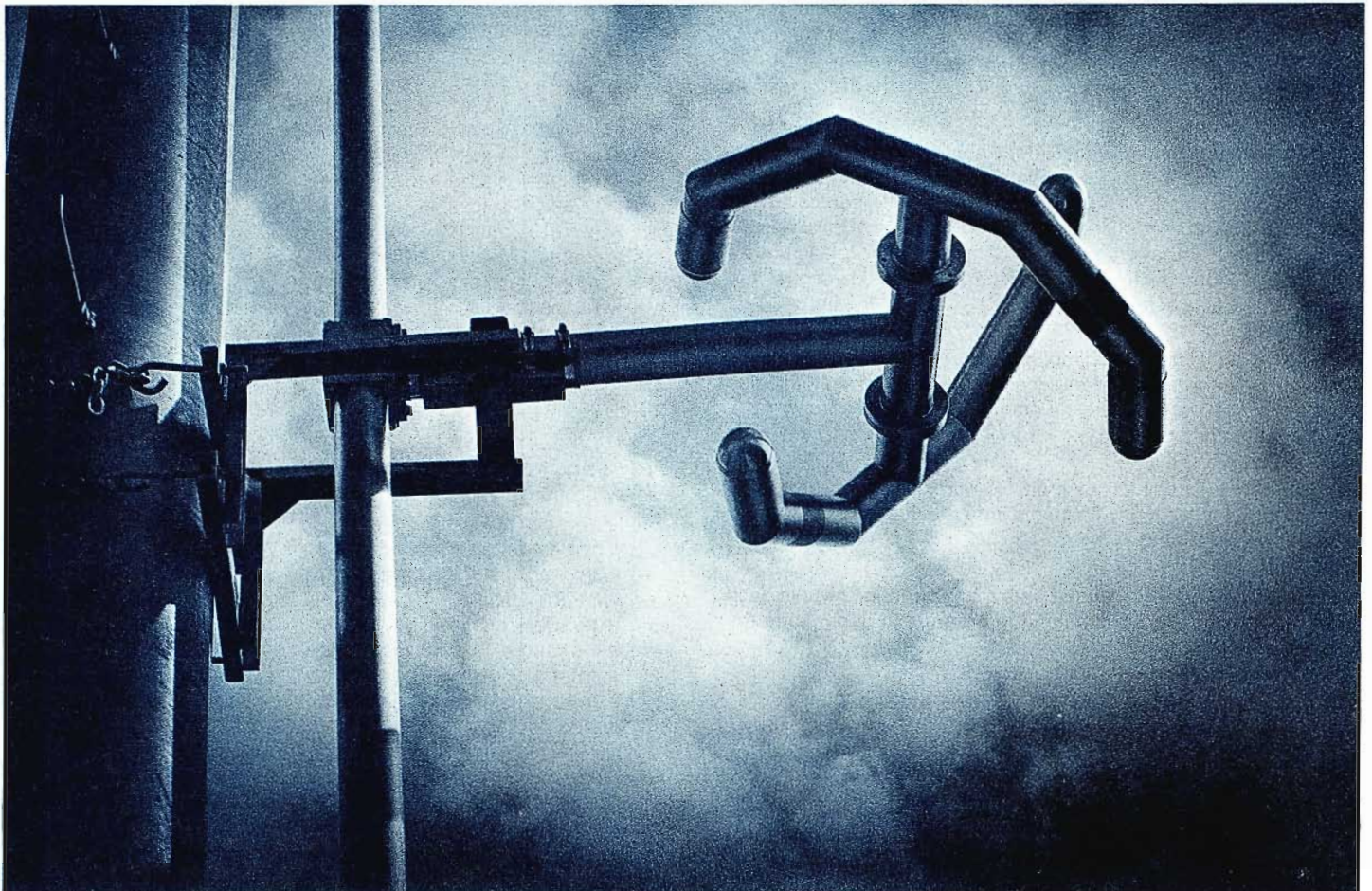

The rugged construction means these antennas will withstand the most severe weather extremes and wind velocities up to 150 miles per hour.

BANDWIDTH CAPABILITY. The FMH antenna has a low standing wave ratio of 1.07:1 or less, \pm 200 kHz per given channel with field trimming. VSWR at antenna input without field trimming is 1.1:1 for pole mounting atop a tower. VSWR at antenna input without field trimming is 1.5:1 or less when side mounted on a tower.

Due to the excellent bandwidth characteristics of the radiating element, multi-station operation is possible using a common antenna system. The necessary filtering components are available from Harris for such diplexing or multiplexing operations. Stations having a frequency separation of up to 4 MHz may be diplexed on a common antenna. However, in the case of 40 kW transmitters, a minimum frequency separation of 1.2 MHz is advisable to avoid excessive heating of filter components.

CIRCULARITY. The horizontally polarized radiation pattern is omni-directional when the antenna is pole mounted atop a tower, and circularity is typically \pm 2 dB when the antenna is mounted on a 14" diameter steel pole. When side mounted, the antenna pattern will be somewhat affected by the supporting structure.

DEICING. Deicers are not required in a normal environment, as the typical VSWR is 1.5:1 or less with 1/2-inch of radial ice. However, heaters for deicing are available.

ANTENNA MODELS. The Harris FMH super-power FM antenna is available in three versions. The "A" version uses a 3-1/8" element feed stem, and 3-1/8" rigid interbay line. It is available in 3-1/8" end fed, 3-1/8" center fed and 6-1/8" center fed models, in arrays of up to 12 bays.

The FMH "B" version uses a 4-1/8" element feed stem, and a 4-1/8" rigid interbay line. It is available in either 6-1/8" end fed or 6-1/8" center fed models in arrays of up to 12 bays.

The FMH "C" version uses a 4-1/8" element feed stem, and 6-1/8" rigid interbay line, with 6-1/8" end feed. It is available in arrays of up to 6 bays.

Each antenna is supplied with a 6-foot input transformer. The input is 50 ohm EIA with either a 3-1/8" flange or a 6-1/8" flange, depending on the model type. All antennas are completely assembled and tuned to the customer's frequency at the factory. Also, pressure testing is done at that time to assure the customer of a leak-free antenna, provided the antenna is properly installed by a qualified erector and is free of damage.

MOUNTING. Stainless steel mounting brackets and hardware are supplied for standard constant cross section towers or steel poles at no additional cost. Brackets for mounting on tapered towers are available at additional cost.

DIMENSIONS. Each FMH element is approximately 47-1/2 inches long, and 30 inches high. Weight is approximately 57 pounds per element with line block.

MODEL NUMBERS. Because of the many variations within each FMH model category, it is helpful in ordering to understand the Harris model numbers:

FMH-1BE	FMH-4AC6
1 = 1 bay	4 = 4 bay
B = "B" Model	A = "A" Model
E = End Fed	C = Center Fed
	6 = 6-1/8" input

"A" Model, 3-1/8" Interbay Line, 3-1/8" Element Stem

TYPE NO.	POWER GAIN ¹		FEMALE 50 OHM INPUT	POWER ² INPUT CAPABILITY	CALCULATED WT. [LBS]	CALCULATED WIND-LOAD [LBS]
	POWER	dB				
FMH-1AE	0.4611	-3.3623	3 1/8"	32kW	114	137
FMH-2AE	0.9971	-0.0128	3 1/8"	32kW	225	304
FMH-2AC	0.9971	-0.0128	3 1/8"	39kW	250	319
FMH-2AC6	0.9971	-0.0128	6 1/8"	64kW	301	421
FMH-3AE	1.5588	1.9278	3 1/8"	32kW	336	470
FMH-4AE	2.1332	3.2903	3 1/8"	32kW	447	637
FMH-4AC	2.1332	3.2903	3 1/8"	39kW	472	652
FMH-4AC6	2.1332	3.2903	6 1/8"	64kW	523	758
FMH-5AE	2.7154	4.3384	3 1/8"	32kW	558	804
FMH-6AE	3.3028	5.1888	3 1/8"	32kW	669	971
FMH-6AC	3.3028	5.1888	3 1/8"	39kW	694	986
FMH-6AC6	3.3028	5.1888	6 1/8"	64kW	745	1096
FMH-7AE	3.8935	5.9034	3 1/8"	32kW	780	1138
FMH-8AE	4.4872	6.5197	3 1/8"	32kW	891	1305
FMH-8AC	4.4872	6.5197	3 1/8"	39kW	916	1320
FMH-8AC6	4.4872	6.5197	6 1/8"	64kW	967	1433
FMH-10AC	5.6800	7.5435	3 1/8"	39kW	1138	1653
FMH-10AC6	5.6800	7.5435	6 1/8"	64kW	1189	1770
FMH-12AC	6.8781	8.3747	3 1/8"	39kW	1360	1987
FMH-12AC6	6.8781	8.3747	6 1/8"	64kW	1411	2108

"B" Model, 4-1/8" Interbay Line, 4-1/8" Element Stem

TYPE NO.	POWER GAIN ¹		FEMALE 50 OHM INPUT	POWER ² INPUT CAPABILITY	CALCULATED WT. [LBS]	CALCULATED WIND-LOAD [LBS]
	POWER	dB				
FMH-1BE	0.4611	-3.3623	6 1/8"	40kW	159	201
FMH-2BE	0.9971	-0.0128	6 1/8"	56kW	297	407
FMH-2BC	0.9971	-0.0128	6 1/8"	80kW	336	468
FMH-3BE	1.5888	1.9278	6 1/8"	56kW	435	613
FMH-4BE	2.1332	3.2903	6 1/8"	56kW	573	818
FMH-4BC	2.1332	3.2903	6 1/8"	112kW	612	879
FMH-5BE	2.7154	4.3384	6 1/8"	56kW	711	1024
FMH-6BE	3.3028	5.1888	6 1/8"	56kW	849	1229
FMH-6BC	3.3028	5.1888	6 1/8"	112kW	888	1290
FMH-7BE	3.8935	5.9034	6 1/8"	56kW	987	1435
FMH-8BE	4.4872	6.5197	6 1/8"	56kW	1125	1641
FMH-8BC	4.4872	6.5197	6 1/8"	112kW	1164	1702
FMH-10BC	5.6800	7.5435	6 1/8"	112kW	1440	2113
FMH-12BC	6.8781	8.3747	6 1/8"	112kW	1716	2524

"C" Model, 6-1/8" Interbay Line, 4-1/8" Element Stem

TYPE NO.	POWER GAIN ¹		FEMALE 50 OHM INPUT	POWER ² INPUT CAPABILITY	CALCULATED WT. [LBS]	CALCULATED WIND-LOAD [LBS]
	POWER	dB				
FMH-1CE	0.4611	-3.3623	6 1/8"	40kW	205	260
FMH-2CE	0.9971	-0.0128	6 1/8"	80kW	410	520
FMH-3CE	1.5888	1.9278	6 1/8"	120kW	615	780
FMH-4CE	2.1332	3.2903	6 1/8"	120kW	820	1040
FMH-5CE	2.7154	4.3384	6 1/8"	120kW	1025	1300
FMH-6CE	3.3028	5.1888	6 1/8"	120kW	1230	1560

FOOTNOTES-(Apply to all models)

1. Horizontal and vertical power gain and dB gain are the same. 2. Power input capability up to 2,000 ft. above mean sea level. Derating required above 2,000 ft. 3. Windload based on 50/33 PSF. 112 m.p.h. actual wind velocity NOTE: Brackets included in weight and windload calculations.

ADV. 462A PTD. IN U.S.A.



FML LOW POWER CIRCULARLY POLARIZED FM ANTENNA

- Power input handling capability of 9 kW end fed or 12 kW center fed
- Excellent bandwidth capability
- Internal feed point to radiating element
- Rugged brass construction
- Deicers not required
- Stainless steel support brackets and hardware
- Hemispherical element tips to avoid corona problems

The Harris low power FML circularly polarized FM antenna features excellent bandwidth characteristics and the same rugged construction as Harris' higher-power FM antennas.

RADIATING ELEMENT. The radiating element of the FML antenna is of brass tubular construction, with an outside diameter of 1-3/4 inches. The feed point is completely internal, with a pressurized environment up to the feed point.

ANTENNA MODELS. Two versions of the FML are available. The "E" version is an end fed model mounted on 1-5/8 inch, 50 ohm rigid line. The "C" version is center fed, and uses 3-1/8 inch, 50 ohm rigid line.



End fed models have a power input capability of 9 kW, limited by the average power capability of the 1-5/8 inch rigid coaxial line, which we have conservatively derated from 15 kW to 9 kW. The center fed versions have a power input capability of 12 kW with the 3-1/2 inch input feed. Each antenna comes with a 6 foot input transformer. The antenna system feed point is 6 feet below the bottom bay for end fed models, and approximately 6 feet below the center of the antenna for center feed antenna systems. The input is standard 1-5/8 inch EIA female flange for end fed models, and 3-1/2 inch EIA female flange for center fed models.

The element stem is of heavy wall brass tubing assuring that the element will withstand rugged environmental conditions.

RADIATION PATTERN. Complete antenna patterning facilities are available for measuring the antenna radiation patterns. An electrically equivalent full size tower section, approximately 20 feet long, is set up on the antenna range. The exact size and location of the ladder, coaxial transmission lines, conduits and cables are duplicated on this tower section, and an identical antenna element is mounted on the tower for such measurements.

Pattern optimization for the vertical polarization component, or both vertical and horizontal polarization components is available to improve the pattern circularity. Directionalizing this antenna is possible and requires compliance with FCC regulations pertaining to directional FM antennas. Antenna pattern measurement and optimization is at additional cost.

BANDWIDTH CAPABILITY. The FML antenna has a low standing wave ratio of 1.1:1 or less, \pm 200 kHz per given channel with field trimming. VSWR at antenna input, without field trimming is 1.1:1 for pole mounting atop a tower. VSWR at antenna input, without field trimming, is 1.5:1 or less, when side mounted on a tower.

CIRCULARITY. The horizontally polarized radiation pattern is omnidirectional when the antenna is pole mounted, and circularity is typically \pm 2 dB when the antenna is mounted on a 14 inch diameter steel pole. When side mounted, the antenna pattern will be affected by the structure.

DEICING NOT REQUIRED. The typical VSWR of the FML antenna with 1/2 inch of radial ice is 1.5:1, or less, thus almost totally eliminating the need for deicers. Only in extremely cold mountainous environments experiencing several inches of radial ice on antenna elements would the FML antenna encounter VSWR problems.

CONSTRUCTION. The radiating element and support stem are of brass tubular construction, using thick wall brass in the support stem. This provides a rugged construction capable of survival under severe weather extremes and with wind velocities up to 150 miles per hour (90 lbs. per square foot on flat members, 60 lbs. per square foot on cylindrical members).

Each antenna is completely assembled and tuned to the customer's frequency at the factory. The antenna is also pressure tested at that time in order to assure an antenna free of leaks.

The mounting brackets are supplied for uniform cross section towers or steel poles. Brackets for mounting on tapered towers are available at extra cost. All brackets and hardware are made of stainless steel.

MODEL NUMBERS. The Harris model numbers for the low power FML circularly polarized FM antenna are interpreted as follows:

FML-1E	FML-12C
1 = 1 bay	12 = 12 bay
E = end fed	C = center fed

FML LOW POWER CIRCULARLY POLARIZED FM ANTENNAS

TYPE NO.	POWER GAIN ¹		TYPE FEED	FEMALE 50 OHM INPUT	POWER ² INPUT CAPABILITY	CALCULATED WEIGHT [LBS.]	CALCULATED WIND LOAD [LBS.] ³
	POWER	dB					
FML-1E	0.4611	-3.3623	END	1-5/8"	9 kW	51	92
FML-2E	0.9971	-0.0128	END	1-5/8"	9 kW	102	192
FML-3E	1.5588	1.9278	END	1-5/8"	9 kW	155	295
FML-4E	2.1322	3.2903	END	1-5/8"	9 kW	209	397
FML-4C	2.1322	3.2903	CENTER	3-1/2"	12 kW	242	473
FML-5E	2.7154	4.3384	END	1-5/8"	9 kW	262	500
FML-5C	2.7154	4.3384	OFF CENTER	3-1/2"	12 kW	296	576
FML-6E	3.3028	5.1888	END	1-5/8"	9 kW	316	602
FML-6C	3.3028	5.1888	CENTER	3-1/2"	12 kW	349	679
FML-7E	3.8935	5.9034	END	1-5/8"	9 kW	369	705
FML-7C	3.8935	5.9034	OFF CENTER	3-1/2"	12 kW	403	781
FML-8E	4.4872	6.5197	END	1-5/8"	9 kW	423	808
FML-8C	4.4872	6.5197	CENTER	3-1/2"	12 kW	456	884
FML-9C	5.0826	7.0608	OFF CENTER	3-1/2"	12 kW	510	987
FML-10C	5.6800	7.5435	CENTER	3-1/2"	12 kW	563	1089
FML-11C	6.2783	7.9785	OFF CENTER	3-1/2"	12 kW	617	1192
FML-12C	6.8781	8.3747	CENTER	3-1/2"	12 kW	670	1294
FML-13C	7.4785	8.7381	OFF CENTER	3-1/2"	12 kW	724	1397
FML-14C	8.0800	9.0741	CENTER	3-1/2"	12 kW	777	1500

FOOTNOTES. 1. Horizontal and vertical power gain and dB gain are the same. 2. Power input capability up to 2,000 ft. above mean sea level. Derating required above 2,000 ft. 3. Wind load based on 112 mph wind velocity (50/30 psf) and the wind blowing normal to the side of the antenna. Weight and wind load calculations include brackets, interbay line and the transformer section. Calculations based on the frequency of 95 MHz.



FMP SELF-SUPPORTING CIRCULARLY POLARIZED FM ANTENNA

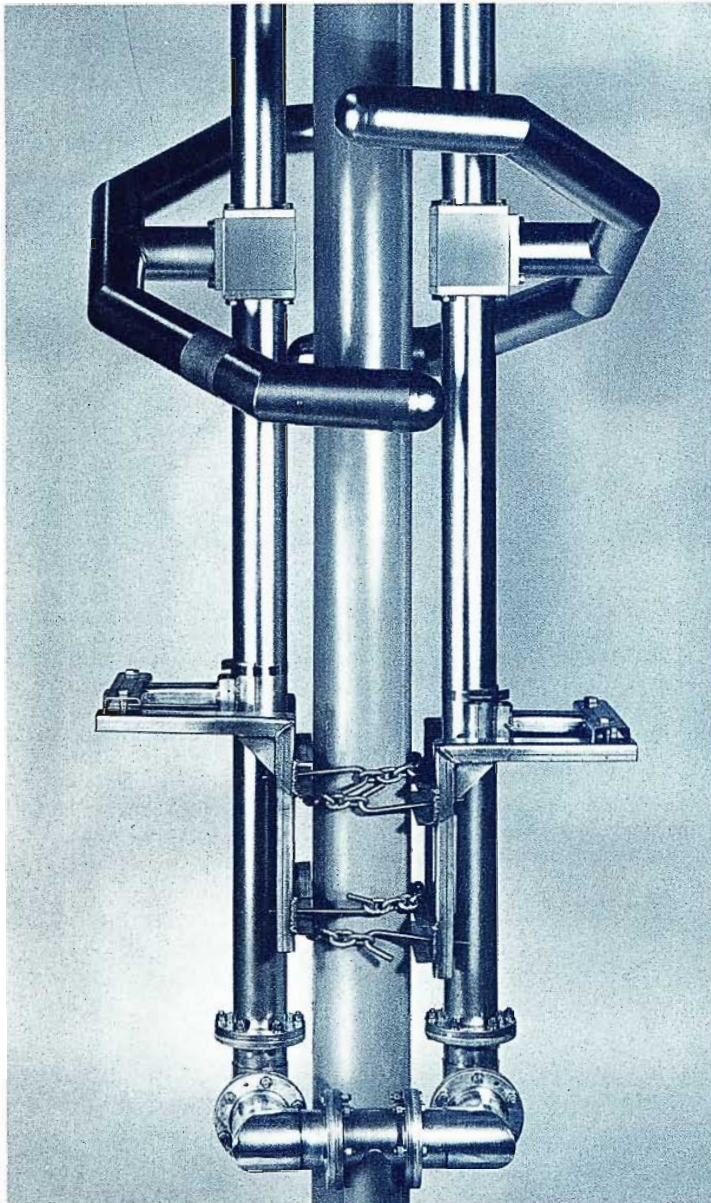

- Center mounting eliminates pole interference
- High power handling capability
- Internal feed point to radiating element
- Multi-station capability
- Excellent bandwidth characteristics
- No heaters, de-icers or radomes normally required
- Rugged brass construction
- Silver plated inner-conductor connectors
- Radiused element tips to avoid corona problems
- Stainless steel support brackets and hardware

The Harris FMP self-supporting circularly polarized FM antennas feature unusually high power handling capabilities, excellent bandwidth characteristics, and multi-station capability. Since the elements are center mounted, interference from the support pole is eliminated.

RADIATING ELEMENT. The radiating element is of brass construction, and has an outside diameter of 3- $\frac{1}{8}$ ". The feed point is completely internal, with a pressurized environment up to the feed point. Each element is rated at 40 kW, the ratings limited only by the average power handling capability of the 3- $\frac{1}{8}$ " rigid coaxial line, which we have conservatively derated from 48 kW to 39 kW.

The rugged construction means these antennas will withstand the most severe weather extremes and wind velocities up to 150 miles per hour.

BANDWIDTH CAPABILITY. The FMP antenna has a low standing wave ratio of 1.07:1 or less, \pm 200 kHz per given channel with field trimming. VSWR at antenna input without field trimming is 1.1:1 for pole mounting atop a tower.

Due to the excellent bandwidth characteristics of the radiating element, multi-station operation is possible under certain conditions, using a common antenna system. The necessary filtering components are available from Harris for such diplexing or multiplexing operations. Stations having a frequency separation of up to 4 MHz may be diplexed on a common antenna with some conditional limitations.

CIRCULARITY. The horizontal plane radiation pattern, for both horizontal and vertical polarization components, is omnidirectional when the antenna is pole mounted atop a tower. The pattern circularity for both polarization components is typically \pm 2 dB.

FMP ANTENNA DATA

DEICING. Deicers are not required in a normal environment. The VSWR is rated at 1.5:1 or less with 1/2-inch of radial ice; however, in field usage VSWR is typically 1.2:1 or less with 1/2-inch of radial ice.

ANTENNA MODELS. The Harris FMP self-supporting antenna is designed for pole mounting. The element feed stems are 3-1/8". Two 3-1/8" rigid interbay transmission lines are used, with one line on one side of the pole and the second line on the opposite side of the pole.

Normally, one to six bays are end fed, and antennas of over six bays are center fed if an even number of bays or fed at a point 1/2-bay below center if an odd number of bays.

Each antenna is supplied with a 6-foot transformer section on the input. The input flange is 50 ohm EIA with either 3-1/8" or 6-1/8" flange, or a 4-1/8" 50 ohm flange is also available. All antennas are completely assembled and tuned to the customer's frequency at the factory. Also, pressure testing is done at that time to assure the customer of a leak-free antenna, provided the antenna is properly installed by a qualified erector and is free of damage.

MOUNTING. Stainless steel mounting brackets and hardware are supplied for steel poles. (The pole is not supplied.) Maximum pole deflection must not exceed 3/4" per 10 feet of pole length.

DIMENSIONS. Each FMP half-element is approximately 35 inches long and 18 inches high. Weight is approximately 26 pounds per half-element with line block.

MODEL NUMBERS. Because of the many different models, it is helpful in ordering to understand the Harris type numbers. The first digit in the Harris type number following the prefix "FMP-" signifies the number of bays the antenna has. The letter "E" after that digit refers to an end fed version, and the letter "C" means the antenna is center fed. The final digit in the type number identifies the size of the female 50 ohm input, either 3-1/8", or 4-1/8" or 6-1/8". See the examples below.

FMP-1E3

FMP-7C6

1 = 1 bay

7 = 7 bays

E = End Fed

C = Center Fed

3 = 3-1/8" Input

6 = 6-1/8" Input

TYPE NO.	POWER GAIN ¹		FEMALE 50 OHM INPUT	POWER ² INPUT CAPABILITY	CALCULATED WEIGHT [LBS.]	CALCULATED WIND-LOAD [LBS.]
	POWER	dB				
FMP-1E3	0.4611	-3.3623	3-1/8"	39 kW	185	280
FMP-1E4	0.4611	-3.3623	4-1/8"	50 kW	245	325
FMP-1E6	0.4611	-3.3623	6-1/8"	64 kW	245	325
FMP-2E3	0.9971	-0.0128	3-1/8"	39 kW	335	518
FMP-2E4	0.9971	-0.0128	4-1/8"	50 kW	395	563
FMP-2E6	0.9971	-0.0128	6-1/8"	64 kW	395	563
FMP-3E3	1.5588	1.9278	3-1/8"	39 kW	485	756
FMP-3E4	1.5588	1.9278	4-1/8"	50 kW	545	801
FMP-3E6	1.5588	1.9278	6-1/8"	64 kW	545	801
FMP-4E3	2.1332	3.2903	3-1/8"	39 kW	635	994
FMP-4E4	2.1332	3.2903	4-1/8"	50 kW	695	1039
FMP-4E6	2.1332	3.2903	6-1/8"	64 kW	695	1039
FMP-5E3	2.7154	4.3384	3-1/8"	39 kW	785	1232
FMP-5E4	2.7154	4.3384	4-1/8"	50 kW	845	1277
FMP-5E6	2.7154	4.3384	6-1/8"	64 kW	845	1277
FMP-6E3	3.3028	5.1888	3-1/8"	39 kW	935	1470
FMP-6E4	3.3028	5.1888	4-1/8"	50 kW	995	1515
FMP-6E6	3.3028	5.1888	6-1/8"	64 kW	995	1515
FMP-7C3	3.8935	5.9034	3-1/8"	39 kW	1085	1691
FMP-7C4	3.8935	5.9034	4-1/8"	50 kW	1145	1736
FMP-7C6	3.8935	5.9034	6-1/8"	64 kW	1145	1736
FMP-8C3	4.4872	6.5197	3-1/8"	39 kW	1235	1929
FMP-8C4	4.4872	6.5197	4-1/8"	50 kW	1295	1974
FMP-8C6	4.4872	6.5197	6-1/8"	64 kW	1295	1974
FMP-9C3	5.0826	7.0608	3-1/8"	39 kW	1385	2167
FMP-9C4	5.0826	7.0608	4-1/8"	50 kW	1445	2212
FMP-9C6	5.0826	7.0608	6-1/8"	64 kW	1445	2212
FMP-10C3	5.6800	7.5435	3-1/8"	39 kW	1535	2405
FMP-10C4	5.6800	7.5435	4-1/8"	50 kW	1595	2450
FMP-10C6	5.6800	7.5435	6-1/8"	64 kW	1595	2450
FMP-11C3	6.2783	7.9785	3-1/8"	39 kW	1685	2643
FMP-11C4	6.2783	7.9785	4-1/8"	50 kW	1745	2688
FMP-11C6	6.2783	7.9785	6-1/8"	64 kW	1745	2688
FMP-12C3	6.8781	8.3747	3-1/8"	39 kW	1835	2880
FMP-12C4	6.8781	8.3747	4-1/8"	50 kW	1895	2925
FMP-12C6	6.8781	8.3747	6-1/8"	64 kW	1895	2925

FOOTNOTES

1. Horizontal and vertical power gain and dB gain are the same. 2. Power input capability up to 2,000 ft. above mean sea level. Derating required above 2,000 ft. 3. Windload based on 50/33 PSF. 112 m.p.h. actual wind velocity. NOTE: Brackets included in weight and windload calculations.



FMS DUAL-CYCLOID

CIRCULARLY POLARIZED FM ANTENNA

The Harris Dual-Cycloid Type FMS antenna transmits circular polarization as authorized by FCC rules and regulations. The station's effective radiated power will still be determined by the signal radiated in the horizontal plane. This is determined by the antenna gain (see table) in the horizontal plane multiplied by the power input to the antenna.

Any number of elements from one to sixteen may be utilized, providing maximum flexibility in the selection of power gain for a particular installation. Antennas with null fill, beam tilt, and special horizontal to vertical power splits (other than 50/50) are available. Radomes or deicers are available for climates that experience icing conditions.

The Dual-Cycloid consists of two basic parts: (1) the radiating element and, (2) interconnecting transmission line sections. The radiating elements in an array are all identical electrically and mechanically. Utilizing the effective ring design of the Cycloid as the basic unit, two vertical elements have replaced the fixed end plates; the rear terminal block is now a matching balun mating the antenna impedance to the interconnecting transmission line.

The vertical sections have adjustable caps for a fine adjustment of the horizontal/vertical radiation ratio which is set at the factory. Corona suppression balls are included as a standard item. Designed for rugged trouble-free operation, all antenna elements are fabricated of a durable weather resistant brass alloy with excellent electrical properties.

Antenna elements are normally spaced one wave length apart with interconnecting transmission line sections and feed through a common system input termination of 50 ohms, which is a standard 3/8" EIA female flange.

CIRCULARITY. Both the horizontal and vertical radiation pattern of the Dual-Cycloid antenna have been measured within ± 2 dB in free space. When side mounted, the antenna pattern will be somewhat affected by the supporting structure.

Supplied on a standard 3/8" EIA line, the antenna is complete with mounting brackets for standard AM and FM towers.

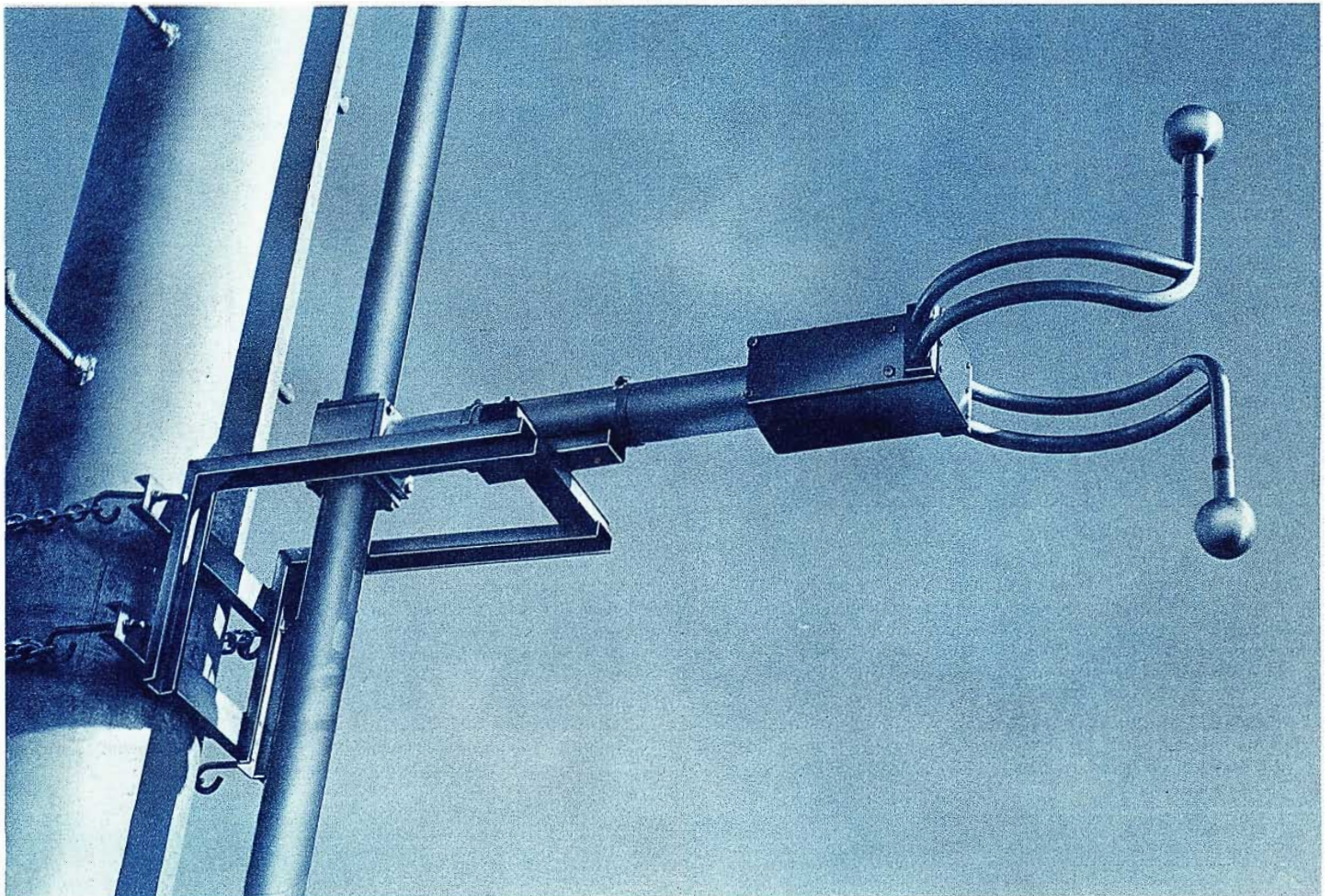

FEED POINT. Antennas of 8 bays or less are usually end fed; a 6 foot matching transformer is connected to the bottom bay. Antennas of 9 bays or more are center fed if an even number of bays, or at a point one-half way below the antenna center if an odd number of bays; a 10 foot matching transformer is connected to an elbow attached to the center feed tee.

MOUNTING. The antenna is mounted on a specially designed stainless steel supporting bracket, fabricated to mate with the tower in a mounting arrangement specified by the purchaser. Antennas are usually mounted on the leg or tower face of a guyed or self supporting tower. A special quotation will be made for brackets on TV towers and non-standard radiators and poles.

Order Type FMS-(X) (X indicates number of bays required)

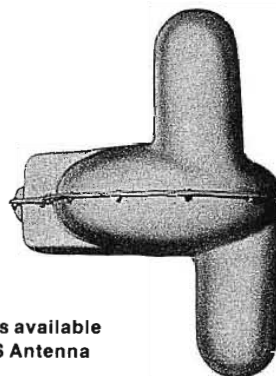

Radomes available for FMS Antenna

FMS DUAL-CYCLOID SPECIFICATIONS

FREQUENCY RANGE: Factory tuned to one frequency in the 88 to 108 MHz band.

POLARIZATION: Circular, clockwise.

POWER GAIN: See table below. Referred to a half-wave dipole in free space.

AZIMUTHAL PATTERN: Circular ± 2.0 dB in free space for horizontal polarization: same for vertical polarization.

VSWR AT INPUT (Without field trimming): Top mounting, 1.1:1 or better. Side mounting, 1.5:1 or better.

VSWR AT INPUT (With field trimming): Top or side mounting, 1.1:1 or better over ± 100 kHz.

INPUT IMPEDANCE: 50 ohms.

INPUT CONNECTION: 3/8 inch, 50 ohm EIA female flange.

POWER INPUT RATING: Approximately 10 kW per bay (see table).

WINDLOAD: 50 lbs. per square foot for flat surfaces; 33 lbs. per square foot for cylindrical surfaces. Figures available for other wind loading.

DIMENSIONS: (One bay) 30 in. high \times 35 1/2 in. typical.

FEED POINT: One to eight bays, end fed. Nine bays and over, center fed with even number of bays, or at a point 1/2 bay below center with odd number of bays.

FMS DUAL-CYCLOID ANTENNA

TYPE NO.	POWER GAIN [in each polarization]			INPUT POWER RATING KW	APPROX. LENGTH FT. ²	WEIGHT [INCL. BRACKETS] LBS. ³	WIND LOAD LBS. ⁴	WIND LOAD W/RADOMES LBS. ⁴
	POWER	dB	FIELD ¹					
FMS-1	0.4611	-3.3623	0.6790	10	—	80	133	259
FMS-2	0.9971	-0.0128	0.9985	20	10	176	296	547
FMS-3	1.5588	1.9278	1.2485	30	20	262	458	835
FMS-4	2.1332	3.2903	1.4605	40	30	348	620	1123
FMS-5	2.7154	4.3384	1.6478	40	40	434	783	1411
FMS-6	3.3028	5.1888	1.8174	40	50	520	945	1699
FMS-7	3.8935	5.9034	1.9732	40	60	606	1108	1987
FMS-8	4.4872	6.5197	2.1183	40	70	692	1270	2275
FMS-9	5.0826	7.0608	2.2545	40	80	779	1506	2636
FMS-10	5.6800	7.5435	2.3833	40	90	865	1668	2924
FMS-11	6.2783	7.9785	2.5057	40	100	951	1831	3212
FMS-12	6.8781	8.3747	2.6226	40	110	1037	1993	3500
FMS-13	7.4785	8.7381	2.7347	40	120	1123	2156	3788
FMS-14	8.0800	9.0741	2.8425	40	130	1209	2318	4076
FMS-15	8.6818	9.3861	2.9465	40	140	1295	2480	4364
FMS-16	9.2846	9.6776	3.0471	40	150	1381	2643	4652

FOOTNOTES

1. To obtain the effective free space field intensity at one mile in mv/m for one kilowatt antenna input power, multiply field gain by 137.6. 2. When determining coax line length on end feed antenna, add 10' to allow for matching stub. When determining coax line lengths on center feed antenna, termination will be 6' below center due to matching stub. 3. Radome weight is 20 lbs. additional per bay. Heaters are not included in weights given. Heater weight, including junction boxes and interbay cable is 7 lbs. additional per bay. Heater elements replaceable in the field. 4. Based on 50 psf wind pressure on flat surfaces, 33 psf on cylindrical surfaces (112 mph actual wind velocity). Antenna will withstand velocities up to 150 mph.

EQUIPMENT FURNISHED: Antenna elements as ordered; antenna mounting hardware (specify tower manufacturer and type); interconnecting rigid coax transmission line; standard 3/8 inch EIA female flange.

ACCESSORY EQUIPMENT: Deicer system, 300 watts or 500 watts per bay, 115 volts or 230 volts, 50/60 Hz...complete with conduit boxes and RF shielded interbay wiring harness.



DUAL-CYCLOID II

DUAL-CYCLOID III

Circularly Polarized FM Antennas

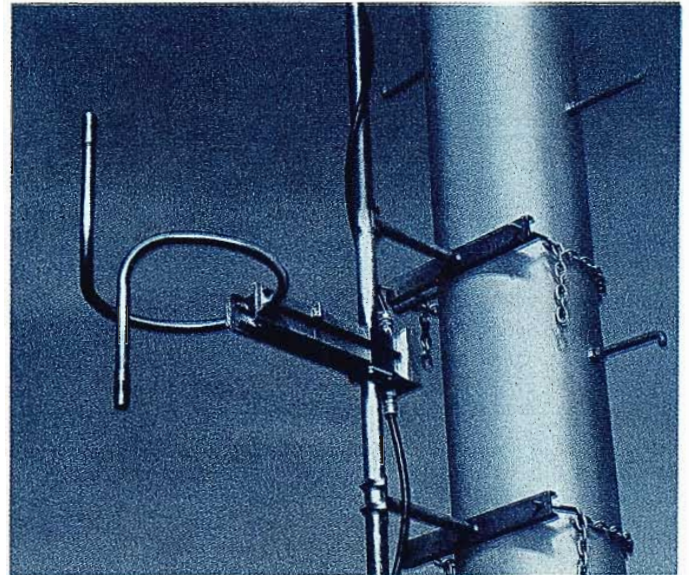

DUAL-CYCLOID II. Harris' Dual-Cycloid II circularly polarized FM antenna provides all of the electrical advantages of the Dual-Cycloid, in a lighter weight, low silhouette design for minimum windloading. The antenna features center feed for medium power handling capabilities—from four to twelve bays handle transmitter powers through 10 kilowatts. Antenna elements are normally spaced one wavelength apart with interconnecting transmission line sections and feed through a common antenna system input termination of 50 ohms, with a standard 3/8 inch EIA female flange.

All antenna elements are fabricated of a durable, weather-resistant brass alloy. Null fill and beam tilt are available. Standard stainless steel brackets for mounting the antenna on the tower leg are included with the antenna. Optional deicers are available, consisting of two 150-watt heating elements per bay, for either 115 volts or 230 volts, as specified. The heater elements are replaceable in the field. Junction boxes and shielded interbay wiring is included. Heater weight including junction boxes and interbay cable, is 6 lbs. additional per bay. Order type FMC-(X) B (X indicates number of bays).

FMC-[X] B SPECIFICATIONS

FREQUENCY RANGE: Factory tuned to one specific frequency in the 88 to 108 MHz band.

POLARIZATION: Circular, clockwise.

FREE SPACE PATTERN: Horizontal component circular ± 2 dB. Vertical component circular ± 2 dB.

VERTICAL TO HORIZONTAL POWER RATIO: Fixed at 50/50.

VSWR: 1.2 to 1 or better ± 200 kHz as tuned at the factory. VSWR when tower mounted 1.5 to 1 or better ± 200 kHz as tuned at the factory. VSWR when tower mounted 1.5 to 1 or better ± 200 kHz. Capable of adjustment 1.1 to 1 ± 100 kHz with field tuning.

POWER GAIN: Horizontal polarization: see table. Vertical polarization: see table. Referred to a half wave dipole in free space.

POWER INPUT RATING: Maximum of 12 kW.

INPUT CONNECTION: 3/8" EIA female flange, 50 ohm.

WINDLOAD: Designed for 50 psf for flat surfaces, 33 psf for cylindrical surfaces.

WEIGHT: Single bay 24 lbs., less brackets. 1 1/2" interbay coaxial line weighs approximately 13 lbs. per section.

DIMENSIONS: Single bay height approximately 30". Length approximately 27".

DUAL-CYCLOID III. Designed for lower power stations, Harris' Dual-Cycloid III circularly polarized FM antenna is an end-fed version of the Dual-Cycloid II—it is lighter in weight, and has less windloading. From one to eight bays handle transmitter powers through 7.5 kilowatts.

The antenna consists of 1 1/2-inch transmission line with individual bays separated by approximately one wavelength at the operating frequency. All antenna elements are fabricated of durable, weather-resistant brass alloy. Null fill and beam tilt are not available on the Dual-Cycloid III.

Deicers are available, they consist of two 150-watt or 300-watt heating elements per bay for either 115 volts or 230 volts, as specified. Junction boxes and shielded interbay wiring harness are included. These elements are factory installed, and are replaceable in the field. Heater weight, including junction boxes and interbay cable, is 6 lbs. Standard stainless steel brackets for mounting the antenna on the tower leg are included with the antenna. Order type FMC-(X)A (X indicates the number of bays required).

FMC-[X] A SPECIFICATIONS

FREQUENCY RANGE: Factory tuned to one specific frequency in the 88 - 108 MHz band.

POLARIZATION: Circular, clockwise.

FREE SPACE PATTERN: Horizontal component circular ± 2 dB. Vertical component circular ± 2 dB.

VERTICAL TO HORIZONTAL RATIO: Fixed at 50/50.

VSWR: 1.2 to 1 or better ± 200 kHz as tuned at the factory. VSWR when tower mounted 1.5 to 1 or better ± 200 kHz. Capable of adjustment to 1.1 to 1 ± 100 kHz with field tuning.

POWER GAIN: Horizontal polarization: see table. Vertical polarization: see table. Referred to a half wave dipole in free space.

POWER INPUT RATING: Maximum of 7.5 kW for three to eight bays. 3 kW for single bay, 6 kW for two bays.

INPUT CONNECTION: A six foot transformer section is attached to the bottom bay of each antenna system which has a 1 1/2" 50 ohm EIA female connector.

WINDLOAD: Designed for 50 psf for flat surfaces, 33 psf for cylindrical surfaces.

WEIGHT: Single bay 24 lbs., less brackets. 1 1/2" interbay coaxial line weighs approximately 13 lbs. per section.

DIMENSIONS: Single bay height approximately 30". Length approximately 27".

DUAL-CYCLOID II

TYPE NO.	POWER GAIN ¹			POWER INPUT [kW]	WT. ² [LBS.]	WIND- ³ LOAD [LBS.]	WIND- ³ W/RAD-OMES [LBS.]
	POWER	dB	FIELD				
FMC-4B	2.1332	3.2903	1.4605	12	181	365	764
FMC-5B	2.7154	4.3384	1.6478	12	218	442	941
FMC-6B	3.3028	5.1888	1.8174	12	255	520	1118
FMC-7B	3.8935	5.9034	1.9732	12	292	597	1296
FMC-8B	4.4872	6.5197	2.1183	12	329	675	1473
FMC-9B	5.0826	7.0608	2.2545	12	366	752	1650
FMC-10B	5.6800	7.5435	2.3833	12	403	830	1828
FMC-11B	6.2783	7.9785	2.5057	12	440	907	2005
FMC-12B	6.8781	8.3747	2.6226	12	447	985	2182

DUAL-CYCLOID III

TYPE NO.	POWER GAIN ¹			POWER INPUT [kW]	WT. ² [LBS.]	WIND- ³ LOAD [LBS.]	WIND- ³ W/RAD-OMES [LBS.]
	POWER	dB	FIELD				
FMC-1A	0.4661	-3.3623	0.6790	3	32	61	161
FMC-2A	0.9971	-0.0128	0.9985	6	69	139	338
FMC-3A	1.5588	1.9278	1.2485	7.5	106	216	515
FMC-4A	2.1332	3.2903	1.4605	7.5	143	294	693
FMC-5A	2.7154	4.3384	1.6478	7.5	180	371	870
FMC-6A	3.3028	5.1888	1.8174	7.5	217	449	1047
FMC-7A	3.8935	5.9034	1.9732	7.5	254	526	1224
FMC-8A	4.4872	6.5197	2.1183	7.5	291	604	1402

FOOTNOTES. 1. Power gain in each polarization. To obtain effective free space field intensity at one mile MV/M for one kilowatt antenna power, multiply field gain by 137.6. 2. Weights given include brackets, interbay transmission line and transformer section (center fed tee section and elbow weight also included in Dual-Cycloid III weight). Weight per radome is 18 lbs. for Dual-Cycloid II and 18 lbs. for Dual-Cycloid III (should be multiplied times the number of bays). 3. Windload based on 50 psf on flat surfaces and 33 psf for cylindrical surfaces (actual wind velocity 112 mph). Computed for 100 MHz antenna with mounting brackets but less heater junction boxes and heater cables.

DUAL-CYCLOID II-Length of 4 bay antenna is approximately 30 feet. To determine the length of other antennas, add 10 feet per additional bay. Dual-Cycloid II antennas fed at center if an even number of bays, or at a point 1/2-bay below antenna center if an odd number of bays. A 10-ft. matching transformer is attached to an elbow attached to the center feed tee.

DUAL-CYCLOID III-Length of 2 bay antenna is approximately 10 feet. To determine length of other antennas, add 10 feet per additional bay. When determining coax length, add six feet to antenna length.

EDUCATIONAL FM ANTENNAS

The Harris FM-11 series of FM antennas uses lightweight horizontally polarized ring type radiators having a horizontal plane radiation pattern that is essentially omni-directional. The FM-11 uses a single ring element; the FM-22 uses two ring elements; the FM-33 uses three elements; and, the FM-44 uses four ring elements. Antennas having more than one ring element use a vertical spacing of one wavelength between elements.

The antennas are designed for mounting on a pipe or pole having an outside diameter of 2 to 2 1/2 inches. Two "U" bolts are provided on each antenna element for mounting. The mounting pole is not supplied, but can be provided at additional cost, as can the proper coaxial cable.

FM-11 SERIES SPECIFICATIONS

FREQUENCY RANGE: Factory tuned to one specific frequency in the 88-108 MHz band.

POLARIZATION: Horizontal.

TYPICAL PATTERN WHEN MOUNTED ON SMALL STEEL POLE: Horizontal plane pattern circularity of approximately ± 3 dB.

TYPICAL VSWR: 1.5 to 1, or less, ± 1.2 MHz.

INPUT CONNECTOR: Type UHF female which mates with the type UHF male (PL-259 or 83-1SP).

WINDLOAD CALCULATION: Based on 50 lbs./sq. ft. for flat surfaces, 33 lbs./sq. ft. for cylindrical surfaces (wind velocity of 112 miles per hour).

DIMENSIONS: Single bay height approximately 9". Length approximately 23". Two bay antenna 11 ft. high; 3 bay is 22 ft.; 4 bay is 33 ft.

ORDERING INFORMATION

FM-11A Single ring antenna710-0102-000
FM-22A 2-ring antenna710-0103-000
FM-33A 3-ring antenna710-0201-000
FM-44A 4-ring antenna710-0202-000

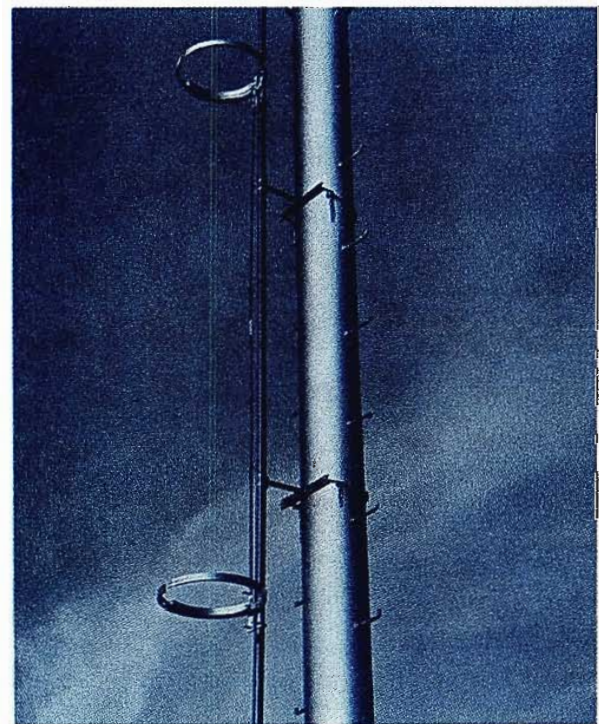

FM11 SERIES

TYPE NO.	POWER GAIN			POWER RATING [WATTS]	WT. [LBS.]	WIND-LOAD [LBS.]
	POWER	dB	FIELD			
FM-11	0.80	-0.969	0.894	500	7.5	52.5
FM-22	1.80	2.55	1.342	800	16.5	117
FM-33	2.75	4.39	1.658	800	27.5	196
FM-44	3.72	5.70	1.929	800	36	257



HARRIS
COMMUNICATIONS AND
INFORMATION HANDLING

DIRECTIONAL DUAL POLARIZED FM ANTENNA

- No de-icing required under normal environmental conditions
- Internal feed point to radiating element
- Pattern tested
- Field trimming normally not required
- High power handling capability
- Rugged brass construction
- Stainless steel support brackets
- Wide bandwidth characteristics



Harris' FMD-(X) is a directional dual polarized FM antenna designed for pole mounting. It is available with up to eight bays and with either 1- 5/8 inch or 3- 1/8 inch EIA 50 ohm female input. The "X" in the type number indicates the number of bays. The suffix "A" following the complete type number signifies 1- 5/8" input and the suffix "B" indicates 3- 1/8" input. (Example—FMD-4A is a 4-bay antenna with 1- 5/8" input).

UP TO 40 KW INPUT POWER. The maximum power input capability for the "A" series is 12 kilowatts. The maximum power input capability for the "B" series is 20 kilowatts for a single bay, and 40 kilowatts for two (2) through eight (8) bays.

The interbay lines use 3- 1/8 inch rigid, with three such lines used between bays, two for the horizontal element feeds and one for the vertical element feeds. A combiner, for combining the three transmission line feeds, is used below the bottom bay. A six foot transformer section is used immediately below this combiner.

BROADBAND DIPOLE ELEMENTS. The antenna uses broadband 3- 1/8" diameter dipole elements, and these will not require deicing under normal environmental conditions. Each bay level normally uses two driven horizontal elements, one horizontal parasitic reflector and one driven vertical element. In some cases, vertical parasitic elements may be used on each bay for the purpose of further shaping the vertical polarization component.

Heaters are not normally required for antenna deicing purposes due to the excellent bandwidth characteristics exhibited by the antenna. Typically, as measured between 1.5:1 VSWR points, the bandwidth is in the region of 5 to 7 MHz. As a result, the antenna could probably experience icing of up to 3/4 inch thickness without the VSWR going above 1.5:1.

ANTENNA SYSTEM PRESSURIZATION. The antenna system is designed to be pressurized, using dry air or dry nitrogen, and the system should be purged and then pressurized to a positive pressure of approximately 2 to 5 pounds per square inch (0.14 to 0.35 kilograms per square centimeter) immediately following installation.

CUSTOM MOUNTING POLE. The FMD antenna is supplied with a custom matching pole, thereby permitting the support pole to be drop shipped directly to the customer. The directional antenna may be purchased without the pole only on a special quotation basis, in which case there will be an added engineering charge made, and the cost of the Harris pole deducted from this total price. The pole is a hot dip galvanized pedestal mount, with removable step bolts. For poles 30 feet or more in length the minimum wall thickness is 0.500 inch. A plate is provided on the top of the pole as a support for a beacon. Should a buried pole support be desired, specific requirements will be needed for a special price quotation.

ANTENNAS PATTERNED AT FACTORY. Each Harris FMD directional antenna is patterned on a test range, not at the customer's site. A single bay of the antenna (in accordance with FCC pattern test requirements) is mounted on a pole identical (or electrically equivalent) to that on which the antenna is to be finally installed. If the customer supplies his own pole, then complete data on the pole must be submitted for final pattern testing.

The antenna is patterned with the test pole erected vertically on a turntable on the antenna range, and measurements made in the xy, or horizontal plane, for both the horizontal and vertical polarization components. Normally, the antenna bay being patterned is operated in the transmitting mode. A special dipole

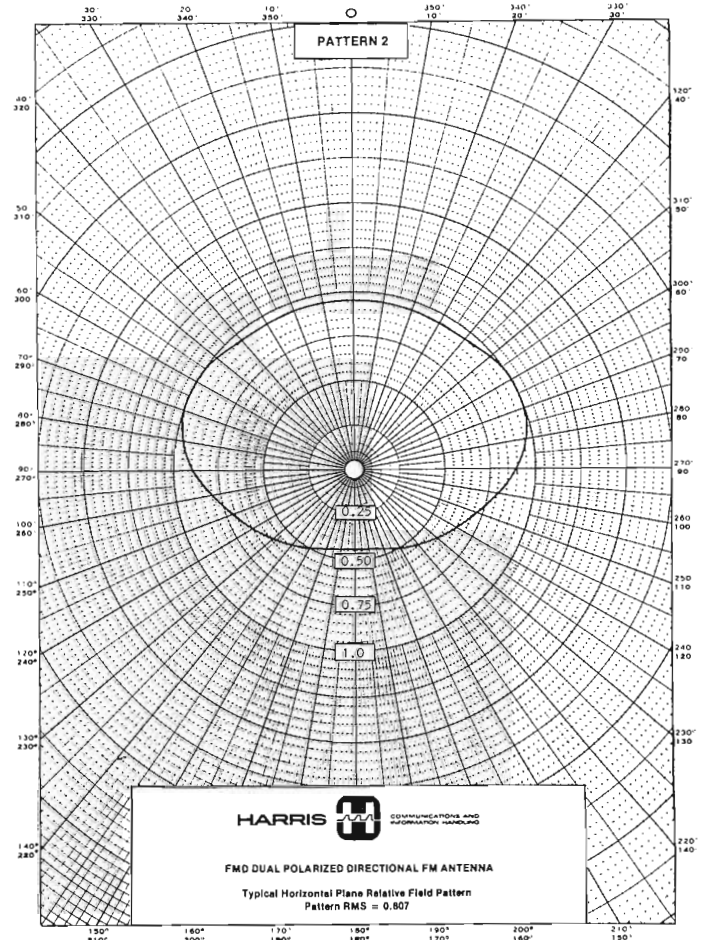
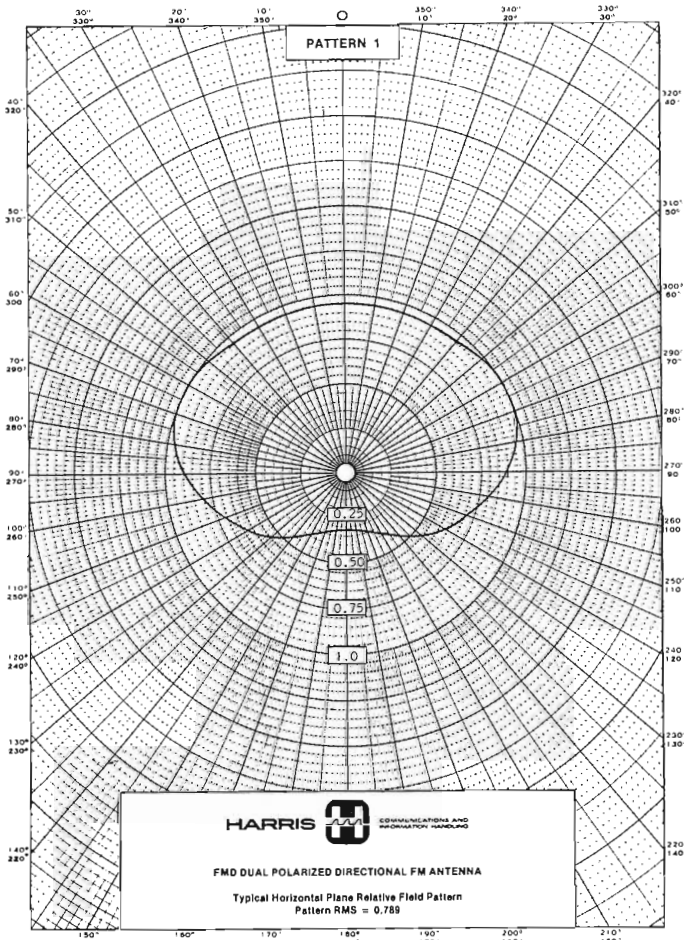

receiving antenna, located a sufficient distance away, is used with its output feeding an accurate field intensity meter, and the pattern of the antenna plotted as the test pole is rotated. Patterns for each of the two polarization components are plotted separately. Adjustments are made to the antenna bay in order to achieve a suitable antenna radiation pattern.

The complete antenna is assembled on a steel pole and carefully tuned at the factory. As a result, field trimming should normally not be required.

The final pattern achieved may be expected to differ slightly from the initial pattern proposed, so it may be necessary to file an application to modify the construction permit to comply with the exact measured pattern, which the customer will receive upon the completion of the antenna pattern tests.

Following the completion of the final patterning of the antenna, Harris will provide the station, and/or its consultant, with the final measured antenna radiation pattern, calculated gain data, and the details of the antenna pattern measurement procedure. This final data is then submitted by the station to the FCC or other broadcasting authority.

ORDERING INFORMATION. Orders for the Harris Dual Polarized Directional FM Antenna should specify the desired true azimuth orientation, maximum ERP permitted, radiated power limitations and their true orientation, transmission line efficiency (or specify the type of transmission line and its length), and the transmitter power output capability. Such antenna pattern requirements are normally specified by the stations's consultant. Ideally, a copy of the FCC construction permit should be supplied so that the manufacturer can assure full compliance with the requirements of such authorization relative to the antenna.

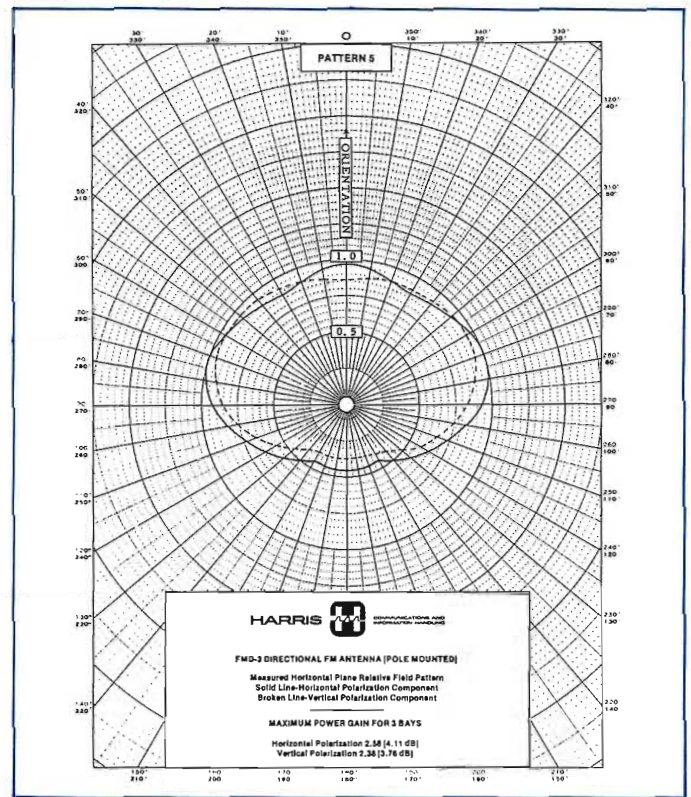

The pattern shown above is that of a three-bay Harris FMD-3 Dual Polarized Directional FM Antenna designed specifically for the 107.7 MHz frequency.

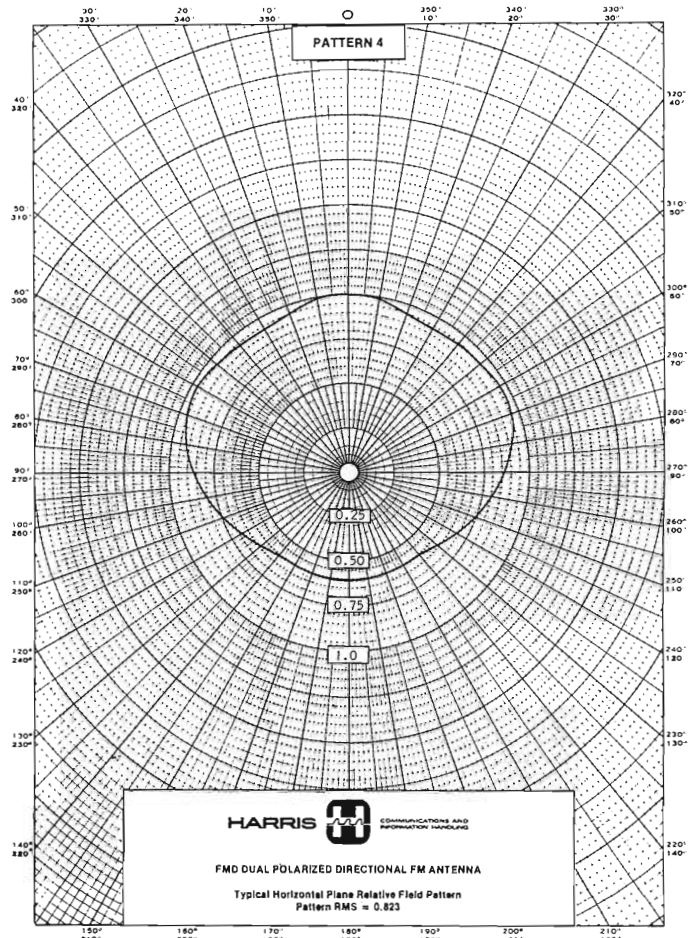
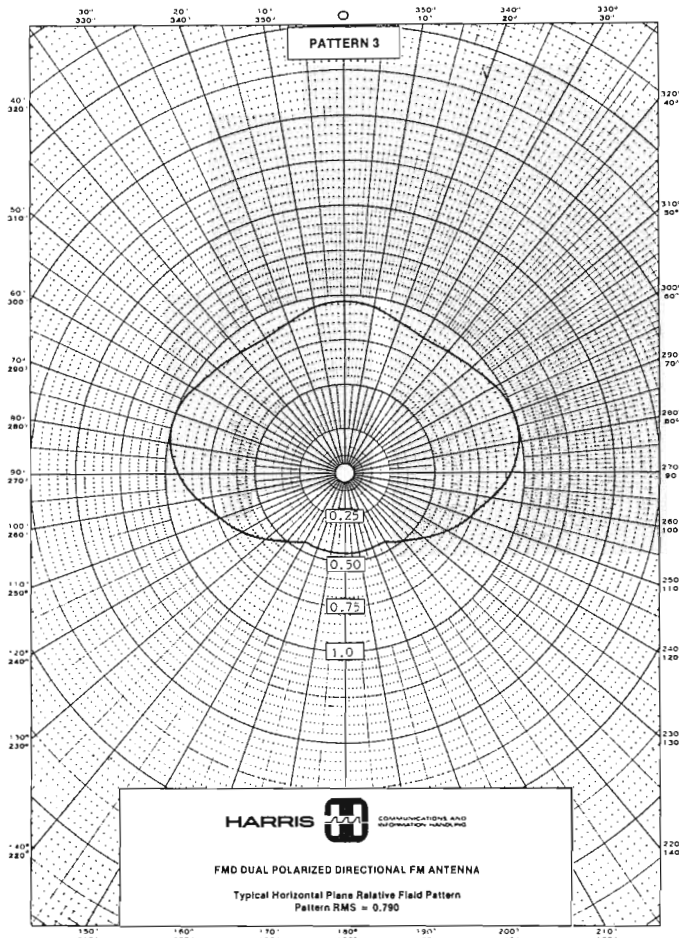

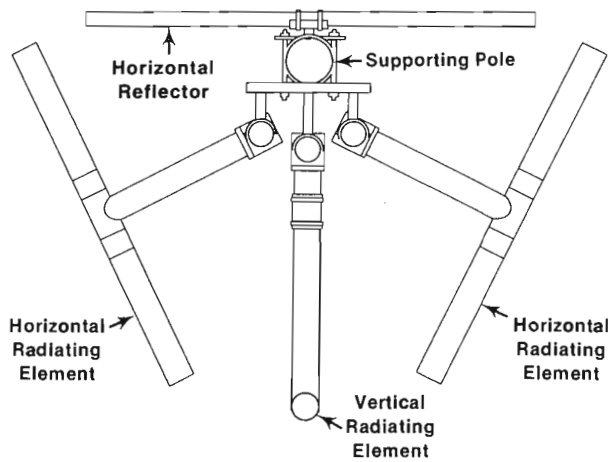

**HARRIS FMD DUAL POLARIZED
DIRECTIONAL FM ANTENNA-TOP VIEW**

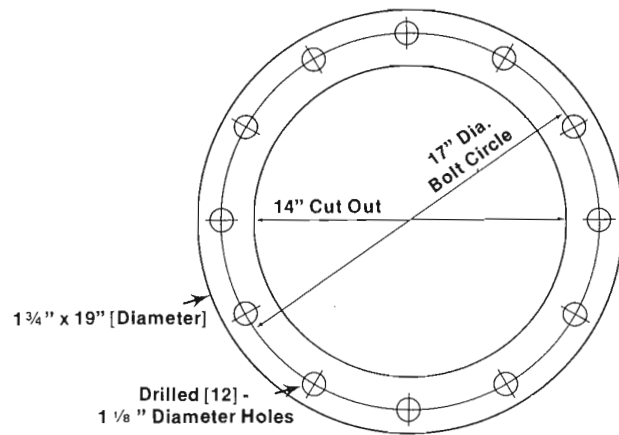

**POLE MOUNTING FLANGE
For Harris Dual Polarized
Directional FM Antenna
[Does not apply to FMD-1A or 1B]**

ELECTRICAL AND MECHANICAL DATA

HARRIS TYPE NO.	INPUT POWER RATING KW	FEMALE INPUT FLANGE	POLE LENGTH FT	WEIGHT POLE AND ANTENNA LBS	TOTAL WIND LOAD [BASED ON 50/33 PSF] LBS	OVER-TURNING MOMENT FT LBS	HEIGHT ELEC-TRICAL CENTER ABOVE TOWER TOP FT	BOLT CIRCLE DIAMETER INCHES
FMD-1A	12	1 5/8"	20	606	796	9595	16	9
FMD-1B	20	3 1/8"	20	626	832	10000	16	9
FMD-2A	12	1 5/8"	30	2240	1821	30024	21	17
FMD-2B	40	3 1/8"	30	2260	1856	30593	21	17
FMD-3A	12	1 5/8"	40	2994	2557	54917	26	17
FMD-3B	40	3 1/8"	40	3014	2593	55682	26	17
FMD-4A	12	1 5/8"	50	4245	3490	89308	31	17
FMD-4B	40	3 1/8"	50	4265	3526	90254	31	17
FMD-5A	12	1 5/8"	62	5901	4680	153210	38	17
FMD-5B	40	3 1/8"	62	5921	4716	154407	38	17
FMD-6A	12	1 5/8"	72	7956	5523	208204	43	17
FMD-6B	40	3 1/8"	72	7976	5559	209581	43	17
FMD-7A	12	1 5/8"	82	9250	6350	271315	48	17
FMD-7B	40	3 1/8"	82	9270	6386	272872	48	17
FMD-8A	12	1 5/8"	92	11305	7192	343159	53	17
FMD-8B	40	3 1/8"	92	11325	7227	344847	53	17

MAXIMUM POWER GAIN FOR TYPICAL PATTERNS 1-4 ON PREVIOUS PAGES

HARRIS TYPE NO.	PATTERN 1		PATTERN 2		PATTERN 3		PATTERN 4	
	HORIZ.	VERT.	HORIZ.	VERT.	HORIZ.	VERT.	HORIZ.	VERT.
FMD-(1A or 1B)	0.81	0.72	0.79	0.70	0.76	0.70	0.72	0.69
FMD-(2A or 2B)	1.74	1.53	1.70	1.49	1.63	1.50	1.54	1.47
FMD-(3A or 3B)	2.71	2.39	2.64	2.33	2.54	2.34	2.39	2.29
FMD-(4A or 4B)	3.70	3.26	3.61	3.18	3.47	3.19	3.26	3.13
FMD-(5A or 5B)	4.71	4.14	4.58	4.03	4.40	4.05	4.14	3.98
FMD-(6A or 6B)	5.71	5.03	5.56	4.90	5.35	4.92	5.03	4.83
FMD-(7A or 7B)	6.73	5.92	6.55	5.77	6.29	5.79	5.92	5.68
FMD-(8A or 8B)	7.75	6.82	7.55	6.64	7.25	6.67	6.82	6.54

NOTE: The above power gain figures are approximate only, but are useful as a guide in determining the number of bays required. The gain figures will vary with the pattern shape, and the exact gain figures are determined when the final antenna pattern is achieved.

The power gain for the vertical polarization component is less than the horizontal polarization component since it will differ a bit in shape, and in addition, the vertically polarized component can not exceed the horizontally polarized component at any azimuth.



HARRIS
COMMUNICATIONS AND
INFORMATION HANDLING

FM ANTENNA ACCESSORIES



AUTOMATIC ANTENNA HEATER CONTROL SYSTEM

Fully automated control of FM, TV and other types of electrically operated broadcast and communications antenna heater systems. Suitable alarms indicate visually and aurally existing weather conditions and register partial and total heater failure.

SPECIFICATIONS

- POWER INPUT:** 115 VAC, 60 Hz.
INPUTS: Temperature sensors; precipitation sensor; heater failure sensor.
INDICATORS: Rain, freeze, low temperature, heaters, heater fail. Selectable aural alarm for any or all of those listed.
MOUNTING: Standard 3½" x 19" rack panel. 8 inches deep.
OPTIONS: 12 VDC function outputs for telemetering status data. Model 2570-CA calibration box. Power contactors and enclosures.

ORDERING INFORMATION

Antenna Heater Control System 710-0139-000



REPLACEMENT ANTENNA HEATER ELEMENTS

ORDERING INFORMATION

- Dual-Cycloid Antennas [2 elements per bay] 710-0136-000
 Dual-Cycloid II [2 elements per bay] 710-0137-000
 Cycloid Antenna [2 elements per bay] 710-0138-000

CP-5M-776

FM ISOLATION TRANSFORMERS



10 kW MODEL

The FM isolation transformer is designed to couple the FM power across the base insulator of a transmitting tower used jointly as an AM and FM radiator without introducing objectionable mismatch into the FM antenna feed line. An isolation transformer is especially desirable for feeding high impedance AM radiators, or AM radiators which are part of an AM directional antenna system, which might be adversely affected by a "bazooka" type isolation system. Isolation transformers are available from Harris in 10 kW and 25 kW models (25 kW model not pictured).

SPECIFICATIONS

- FREQUENCY:** 88 to 108 MHz. Tuned to the station's FM carrier frequency at the factory.
VSWR: (10 kW unit) Less than 1.05 to 1 at the FM station frequency, ± 1.0 MHz when terminated in a matched 50 ohm load. (25 kW unit) Less than 1.05 to 1 at the FM station frequency, ± 0.5 MHz when terminated in a matched 50 ohm load.
INSERTION LOSS: (10 kW unit) Less than 0.05 dB. (25 kW unit) 0.10 dB or less.
INPUT: (10 kW unit) 1 5/8" EIA 50 ohm captive male swivel flange. (25 kW unit) 3 1/8" EIA 50 ohm male flange.
OUTPUT: (10 kW unit) 1 1/8" EIA 50 ohm female swivel flange. (25 kW unit) 3 1/8" EIA 50 ohm male flange (will mate with a 3 1/8" EIA 50 ohm female flange).
WEIGHT: (10 kW unit) Approx. 105 lbs. (25 kW unit) 255 lbs.
FLANGE TO FLANGE LENGTH: (10 kW unit) 67 to 73 inches, depending on the FM frequency. (25 kW unit) 44 inches.
MOUNTING: (10 kW unit) In a cradle supplied. The cradle is fitted with a 2-inch pipe flange on the bottom. Two stainless steel straps secure the tank to the cradle. The 2-inch mounting pipe is not supplied with the transformer. (25 kW unit) Separate 3-inch pipe flange on bottom. Two stainless steel straps secure tank to cradle.
PRESSURIZATION: Designed for use in a pressurized system with gas passing through the unit.

ORDERING INFORMATION

- 10 kW FM Isolation Transformer, standard 1 5/8" EIA flanges, adjusted to customer's operating frequency at the factory. For use with a maximum transmitter power of 10 kW 620-1027-000
 10 kW FM Isolation Transformer, same as above except supplied with 1 1/8" - 3 1/8" adapters. Input and output 3 1/8" EIA 50 ohm female 620-1028-000
 25 kW FM Isolation Transformer, standard 3 1/8" EIA flanges, adjusted to customer's operating frequency at the factory. For use with a maximum transmitter power of 25 kW 620-0444-000

ADV. 465 PTD. IN U.S.A.



HARRIS
COMMUNICATION AND
INFORMATION PROCESSING

SERVICE AND TRAINING



Harris' dedication to producing highest quality, state-of-the-art broadcast products is rivaled only by its commitment to offer complete customer service, both on a routine basis and in emergencies. Striving to eliminate the expense and inconvenience of equipment repairs and down time, Harris has assembled a dedicated team of qualified personnel to staff its non-stop, three-fold service department consisting of Field Services, Parts Department, and Customer Training.

FIELD SERVICE DEPARTMENT. Although technical service availability represents a value not always totally appreciated, Harris' 24 hours, 7 days a week Field Service Department has been many customer's salvation through the years. By dialing (217) 222-8200 and asking for the FIELD SERVICE DEPARTMENT you will be put in contact with a representative who has been specially trained in the product information

relevant to your particular service need. Over the telephone our Field Service engineer will listen to your difficulties and walk you through the proper trouble-shooting steps in order to isolate the problem. Once the difficulties are located, the representative will contact the Parts Department to order the necessary parts while you are still on the phone—thus assuring that the order has been placed and will be shipped on the next available transportation.

If the equipment difficulty you are experiencing has left you off-air or in an emergency condition, dial the 222-8200 number and state plainly that you are experiencing an EMERGENCY. The word EMERGENCY will immediately enter your problem and parts requirement upon the Emergency Service Board—a billboard type system designed by the Harris Service Department to provide priority service to emergency customers. Once you are listed on "the Board" service department personnel go directly to work tracking the needed parts and supplies; the job is not considered completed until the equipment is in your hands and you have confirmed its arrival.

While every effort is made to handle emergencies over the phone and eliminate costly customer expenses, a team of Field Service Engineers in Quincy and others strategically located across the country are available to make station visits and are qualified and equipped to handle emergencies in the field promptly and accurately.

PARTS DEPARTMENT. Although the Harris Parts Department works closely with Field Services, it is also capable of direct customer interaction. If you are knowledgeable of your equipment problems and wish to order a repair part, call the (217) 222-8200 number and request the PARTS DEPARTMENT. One of our Parts Department personnel will take your order and immediately confirm the parts availability from our inventory. A large parts inventory coupled with a main warehouse inventory makes it possible for Harris to offer you 24 hour receipt of your order for over 90% of all requests.

CUSTOMER TRAINING. Because the technology of broadcast equipment is advancing at an increasingly rapid rate, many station personnel are seeking ways to stay abreast with these changes. Knowledge acquired even a few years ago may not be sufficient now to ensure proper operation and maintenance of current equipment. Consequently, participation in a program of continuous technical updating is a high priority objective of many Broadcast technical staffs. Such participation can help considerably in maximizing equipment performance and reliability.

Several sources of update training are available and one of the most productive is the Harris broadcast seminar program conducted in Quincy, Illinois. Here instructors with years of formal teaching experience coupled with vast broadcast electronics knowledge conduct courses on all major equipment manufactured by the Harris Broadcast Products Division.

In order to maximize the benefits of these courses, circuit analysis presentations are made with an emphasis on understanding state-of-the-art component and system applications in present day equipment. Thorough conceptual sessions are conducted during the applicable seminar on such Harris features as Pulse Duration Modulation (PDM); Progressive Series Modulation (PSM); Intermediate Frequency (IF) Modulation; Digitally Synthesized Modulation (DSM); etc. As a preventative measure, a portion of each seminar addresses specific maintenance and troubleshooting techniques.

For more information on the types of training courses offered, the cost, and time and place of each seminar, call (217) 222-8200 and request the CUSTOMER TRAINING DEPARTMENT.



HARRIS
COMMUNICATION AND
INFORMATION PROCESSING

CYCLOTRAN SYSTEM FOR CIRCULARLY POLARIZED TELEVISION SIGNAL TRANSMISSION

- Cyclotran incorporates Harris' circularly polarized CPV antenna and 100-kW dual TVD-100H high band transmitter
- Transmitter and antenna designs eliminate need for new transmitter building and antenna tower
- Top mount CPV antenna offers tower loading comparable to Batwing and traveling wave antennas
- CPV also features excellent axial ratio, high power handling capabilities
- TVD-100H transmitter is very compact—occupies about the same floor space as existing 50-kW transmitters
- Dual 100-kW transmitter consists of two TV-50H, 50-kW transmitters operating in parallel—each featuring solid-state IPA and employing only 3 tubes

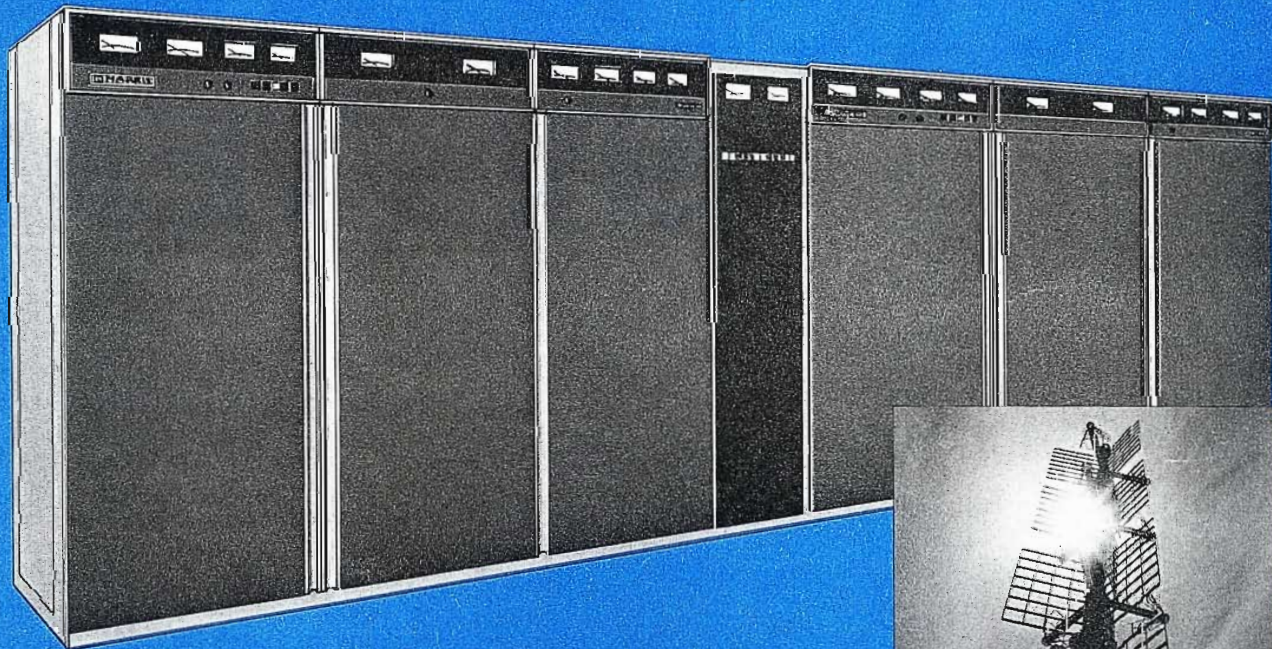

TVD-100H, 100-kilowatt high band TV transmitter



CPV Circularly Polarized TV Antenna

the most
efficient,
most economical way
to enjoy
the benefits
of circularly polarized
television
broadcasting...

Harris'

CYCLOTRAN SYSTEM

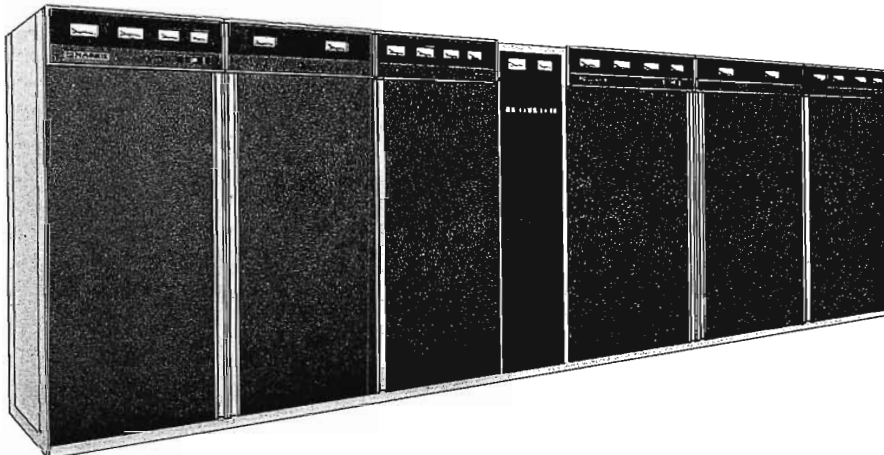

Now, with Harris' development of a *total concept* for circularly polarized TV signal transmission, CP really comes of age. This technological breakthrough, which we call "Cyclotran" ("Cyclo" for circular, "tran" for transmission), is the *first system* designed specifically for television CP applications. It incorporates the Harris TVD-100H, 100-kilowatt dual high band transmitter and the Harris CPV antenna, and offers the potential for sharper, clearer pictures through ghost reduction, improved signal-to-noise ratios, and better fringe area coverage. Even with horizontal receiving antennas, fringe area coverage will improve and

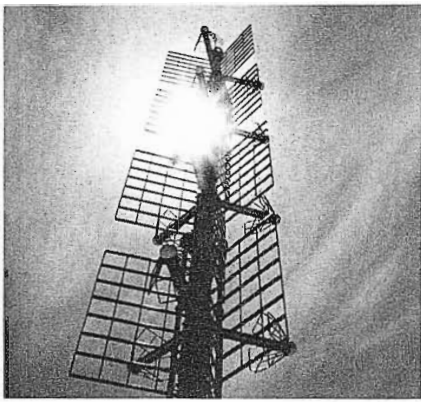

a practical improvement in signal-to-noise ratios may occur.

Cyclotran also offers the most economical way to achieve circular polarization!

As CP requires both a new antenna and increased transmitter power, one of Harris', and broadcasters', primary concerns has been the costs associated with going to circular polarization. Prior to the introduction of our Cyclotran System, CP might have meant expensive reinforcement, or even replacement, of an existing tower; and a potential doubling of space requirements for the transmitter—which could have required an entire new building.

Cyclotran eliminates the need for these costly changes. The 100-kilowatt dual Harris transmitter has been designed to fit into approximately the same floor space as existing 50-kilowatt transmitters, so that additional transmitter facilities should not be required. And, as the Harris CPV top mount antenna offers wind-loading specifications comparable to, or lower than Batwing and traveling wave antennas, it may be used as a direct replacement for either—without expensive changes in tower systems.

CP DEVELOPMENT

Although FCC approval of CP was granted in April, 1977, several years before that event Harris realized that a tremendous interest in CP was building in the broadcast industry.

As the "ratings race" heated up in most markets, broadcasters were looking for an edge—that something "extra" that might help add a few points. And CP offered the possibility of a better picture on home screens.

Harris' first development in TV circular polarization was the Cavity Backed Radiator (CBR) antenna, which was introduced in 1976. The CBR was designed to allow TV stations to broadcast a horizontally polarized signal until CP was approved—then the same antenna could be used for circular polarization once approval came from the FCC.

This antenna was the immediate predecessor of the CPV, and is currently radiating CP at Station KBYU-TV, Provo, Utah. Since the antenna's installation, a dramatic improvement has been seen in the station's signal throughout the coverage area, which includes Salt Lake City, the country's 49th ranked market.

With Cyclotran, combining a specially designed transmitter and an advanced CP antenna, Harris has now brought a systems concept to circular polarization.

TVD-100H TRANSMITTER

This 100-kilowatt dual transmitter consists of two completely independent Harris TV-50H, 50-kilowatt transmitters operating in parallel, combined through a Harris Dualtran RF switching system. The TVD-100H is designed specifically for CP applications.

Along with its unusually compact design, the TVD-100H features solid-state IPA's containing broadband amplifiers. Also, each TV-50H employs only three tubes, including a conservatively rated Type 8984 tetrode operating as the visual PA, for low power consumption. DC filaments in the visual and aural stages provide improved signal-to-noise ratios.

Another TVD-100H feature is complete redundancy. In the event of a malfunction of one-half of the parallel combination, you still stay on the air at one-fourth authorized power, without interruption of the carrier—and half-power operation is achieved in 3 seconds with the touch of a button.

The transmitter also incorporates Harris' state-of-the-art Transversal SideBand (TSB) filters; IF (Intermediate Frequency) Modulation; true linear operation of power amplifiers; and solid-state visual and aural exciter/modulators to provide the finest color performance and sound fidelity available.

CPV ANTENNA

In addition to its low windloading characteristics, the Harris CPV antenna is fed from a single transmission line, thereby reducing tower loading due to transmission line.

Other characteristics of the CPV include excellent circularity (standard omnidirectional pattern varies less than $\pm 2\text{dB}$); low axial ratio (less than 2dB); VSWR less than 1.05:1 at visual carrier and below 1.1:1 over each channel; directional horizontal pattern capability; and a variety of vertical patterns that may be tailored to specific coverage requirements.

THE BEST, MOST ECONOMICAL WAY TO GO CP

Again, we want to emphasize that with a Harris Cyclotran System, a broadcaster may enjoy all of the benefits of CP signal transmission without the expense and inconvenience of providing extensive new facilities. In most cases the existing transmitter building will be large enough to house the TVD-100H, and the existing tower will be adequate to handle the CPV antenna.

This system was designed specifically to give you the best circularly polarized television performance, while minimizing capital investment. For CP applications, there's nothing to equal it.

See your Harris District Sales Representative, or call the Harris Television Sales Department at 217-222-8200. We'll be glad to give you additional information.

HARRIS



COMMUNICATION AND
INFORMATION PROCESSING



Harris AM-FM-TV Transmitter Powers

AM - Medium Wave

	Model
200,000 watt	VP-200A
100,000 watt	VP-100A
	MWD-100
50,000 watt	MW-50A
20,000 watt	MWD-20
10,000 watt	MW-10
	MWD-10A
5,000 watt	MW-5A
1,000 watt	MW-1A

AM - Short Wave

100,000 watt	SW-100
50,000 watt	SW-50

FM

50 kilowatt	FMD-50K
40 kilowatt	FM-40K
25 kilowatt	FM-25K
20 kilowatt	FM-20K
10 kilowatt	FM-10K
7.5 kilowatt	FM-7.5K
5 kilowatt	FM-5K
3 kilowatt	FM-3K
2.5 kilowatt	FM-2.5K
1 kilowatt	FM-1K
300 watt	FM-300KD/FM-300K
100 watt	FM-100K
50 watt	BFE-50G3
15 watt	MS-15

TV-Low Band VHF

	Model
50 kilowatt	BTD-50L2
36 kilowatt	BTD-36L3
35 kilowatt	BT-35L2
25 kilowatt	BT-25L2
18 kilowatt	BT-18L3
1.3 kilowatt	BT-1300L2

TV - High Band VHF

100 kilowatt	TVD-100H
50 kilowatt	TV-50H
	TVD-50H
36 kilowatt	TVD-36H
35 kilowatt	TV-35H
25 kilowatt	TV-25H
18 kilowatt	TV-18H
10 kilowatt	TV-10H
1.3 kilowatt	BT-1300H2

TV - UHF

220 kilowatt	TV-220U
	TV-220UA
110 kilowatt	TV-110U
	TV-110UA
60 kilowatt	TV-60U
	TV-60UA
55 kilowatt	TV-55U
	TV-55UA
40 kilowatt	BT-40U1
30 kilowatt	TV-30U
	TV-30UA



HARRIS
COMMUNICATION AND
INFORMATION PROCESSING

TV-50H

50-Kilowatt VHF High Band
Color Television Transmitter

TVD-100H

100-Kilowatt Dual VHF High Band
Color Television Transmitter

- Compact TV-50H design permits 100-kW dual configuration for CP use in approximately same floor space as existing 50-kW transmitters
- Solid-State IPA's
- Only 3 tubes (TV-50H)/6 tubes (TVD-100H)
- Transversal SideBand filter—no group delay, no tuning adjustments required
- IF Modulation of the visual and aural carriers
- Automatic power control standard
- Excellent cooling system
- Latest design for unattended operation
- Modular, pre-wired cabinets for easiest installation



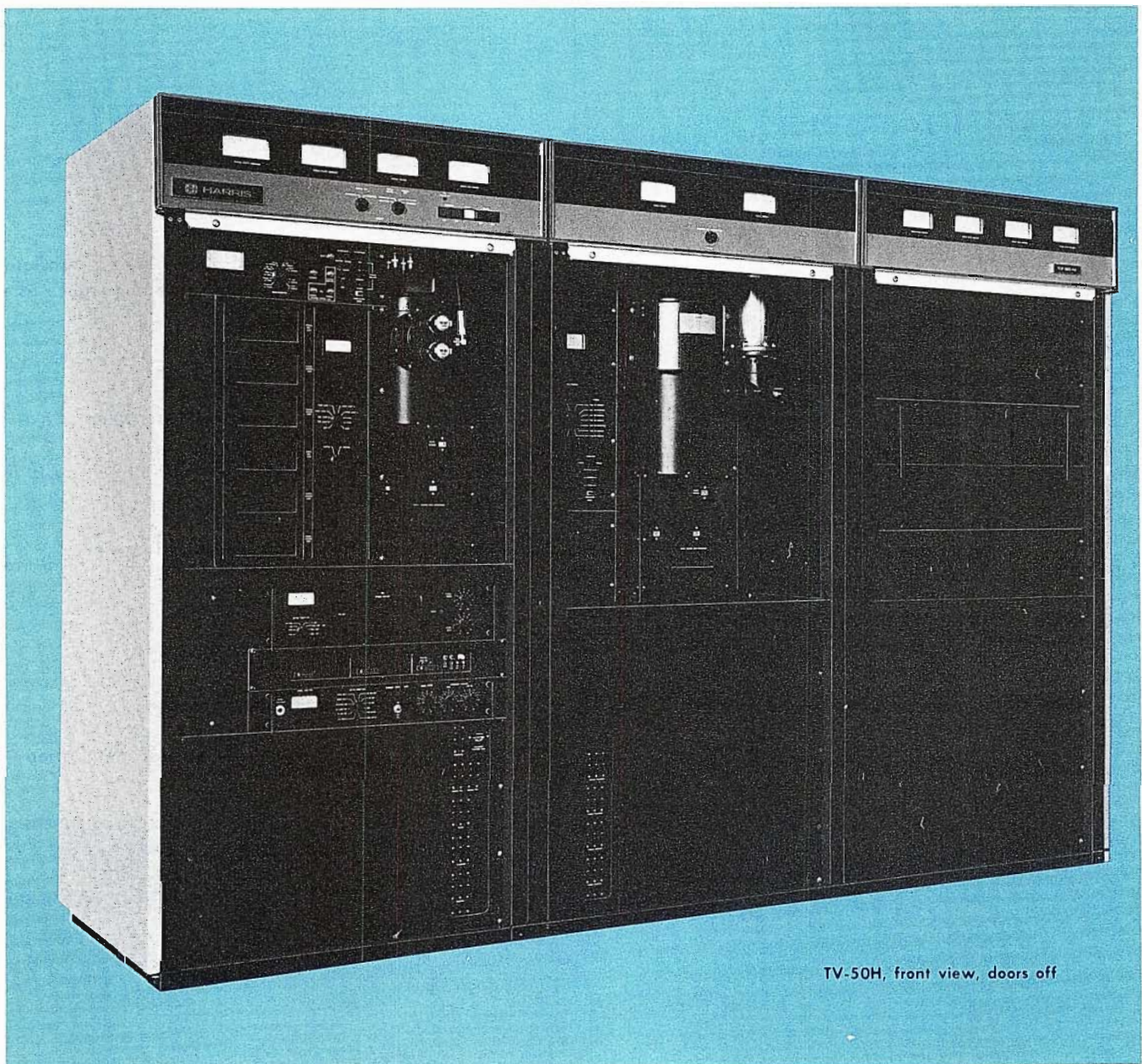

TV-50H, front view, doors off

TV-50H... SOLID-STATE IPA/ THREE-TUBE DESIGN

The Harris TV-50H features a solid-state IPA and a three-tube design to greatly enhance reliability, reduce tuning requirements and allow an unusually compact cabinet configuration.

This advanced high band VHF-TV transmitter requires only one aural and two visual tubes to provide a 50-kilowatt visual and a 5-kilowatt aural output. A circulator between the visual stages minimizes retuning requirements after a tube change.

The solid-state IPA contains broadband amplifiers so that no tuning is required—and it is fully protected against damage caused by overloads or load variations. Gradual (1 to 2 seconds) RF turn-on permits DC voltage stabilization before RF drive application to power

amplifiers, for added transmitter protection. The IPA is fully metered for monitoring and maintenance, while excellent cooling helps maintain long transistor life.

DUAL CONFIGURATION FOR CP APPLICATIONS

The compact design of the TV-50H makes it ideal for 100-kilowatt dual configurations for use with circularly polarized TV antennas. A 100-kilowatt configuration, employing two TV-50H's and a center control cabinet, would require only about the same floor space as one existing 50-kilowatt transmitter!

SUPERB PERFORMANCE

In addition to a solid-state IPA, the TV-50H incorporates such state-of-the-art

features as Harris' Transversal SideBand (TSB) filter; IF (intermediate frequency) Modulation; true linear operation of power amplifiers; and solid-state visual and aural exciter/modulators, to provide the finest color performance and sound fidelity available today. As no envelope delay correction or adjustments are required for the sideband filter, stability, reliability and color quality are greatly enhanced. Frequency adjustment, power output control and amplifier tuning are straightforward and uncomplicated, while design simplicity and conservatively rated components assure long-term "hands-off" operation and minimum maintenance.

The TV-50H consists of a 1.7-kilowatt exciter/driver, an aural power amplifier, a visual power amplifier, and an external HV power supply. The transmitter employs a single-ended visual PA

(8984 tetrode) for low power consumption, and DC filaments in the visual and aural stages for improved signal-to-noise ratios.

TRANSVERSAL SIDE BAND (TSB) FILTER

The Harris solid-state sideband filter is an advanced surface acoustic wave design, and shapes visual sidebands at the IF frequency, rather than "on frequency" at the full output power of the transmitter. Unlike previous VSB filters, which require from 600 to 1000 nsec of group delay correction and many adjustments, the TSB filter has an inherent linear phase characteristic and requires no group delay correction. Other VSB filters need 6 to 12 tuning controls, while the Harris TSB filter needs no tuning controls as it requires no tuning adjustments—ever!

Additionally, the TSB filter has steeper skirts and higher attenuation outside the channel passband for improved VSB wave shaping.

Only 1½ square inches in size, the TSB filter is mounted on a PC board in the visual exciter.

SOLID-STATE VISUAL AND AURAL EXCITER/MODULATORS

The Harris solid-state MCP-1V visual exciter/modulator is an independent, self-contained unit which provides a fully processed on-channel picture signal. Power output can be varied up to one watt with a single front panel control, or from a remote location, without retuning of any kind.

The exciter is mounted in a pull-out drawer and may be operated outside the main transmitter for test purposes. A switch and meter mounted on the front panel permit monitoring exciter parameters. Power and video gain controls are motor driven with manual override provision.

The MCP-1V provides great reliability and stability, excellent frequency response, and truest color quality. It is also designed for minimum maintenance and set-up time, and for remote control and unattended operation. This is all made possible through the use of the latest design techniques, including Harris' solid-state TSB filter.

The Harris aural exciter/modulator is a solid-state self-contained unit which furnishes a fully processed aural signal at a level up to 10 watts. Power output can be set with a single knob on the front panel, or by remote control, with no need for retuning. The aural exciter/modulator is mounted in a pull-out drawer, and may be operated with the

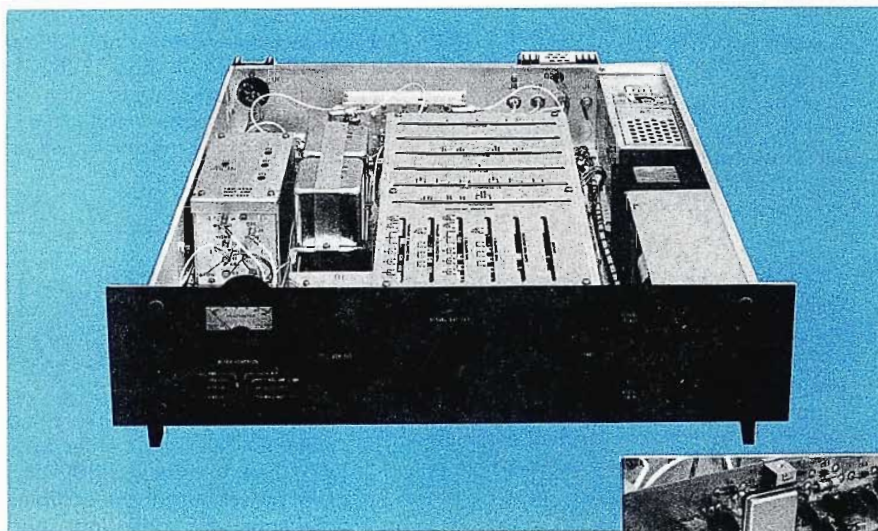

The MCP-1V visual exciter/modulator is a solid-state, independent, self-contained "on-channel" signal source. Harris' TSB filter (right) is mounted on a PC board in the visual exciter, and measures only 1½ inches square.



drawer extended for test purposes.

IF MODULATION

One of the important features of the TV-50H is its true low-level IF Modulation, which offers a top quality picture, and excels in electrical performance, reliability and simplicity of operation.

In the TV-50H the visual and aural exciters generate fully modulated low-level IF signals. The output of a common crystal controlled reference oscillator is used to raise the individual IF signal to the desired "on channel" output frequency.

As it occurs at much lower power levels than other designs, intermediate frequency modulation needs fewer circuits to produce a fully processed, quality picture signal. Less than one volt of video signal is needed to modulate the RF carrier.

The Harris ring modulator design permits modulation percentages to approximately 2% without compromising transmitter performance—and eliminates most pre-distortion circuitry. This results in exceptional color performance and nearly perfect signal linearity. Even such colors as highly saturated yellow and cyan are faithfully reproduced with IF Modulation.

Due to the low-level techniques, which include the use of devices such as an extremely linear broadband diode ring modulator, low-level sideband filtering and very linear broadband amplifiers, the broadcast signal is a faithful reproduction of the signal applied to the transmitter input. IF Modulation results in low incidental phase noise, and the elimination of many transmission problems at their source. This means that no half-way measures—such

as numerous correction, compensation and feedback circuits—are required to eliminate the effects of these problems later.

SOLID-STATE CONTROL CIRCUITS

Solid-state memory, timing and logic circuits—employing CMOS IC's for design simplicity and enhanced reliability—offer complete and foolproof control of all transmitter functions. Built-in memory circuitry enables the entire transmitter to return to the air automatically in the stage it was operating prior to a partial or full power failure. The memory is continuous, and is maintained without an emergency power source during power failures.

The control logic and protective circuitry, in addition to commanding normal AC control functions, is also used to visually indicate, through indicator lights, the operating status of the transmitter system. These indicator lights allow isolation of circuit faults, and are easily removed.

REMOTE CONTROL, UNATTENDED AND AUTOMATIC OPERATION

All control, metering and monitoring circuits have been designed specifically for remote control and unattended operation. The power controls are motor driven and the necessary remote control sampling points are built-in on accessible terminal boards.

Today, Harris TV transmitters are being operated successfully worldwide in an unattended mode, with and without remote control access. In addition, Harris' transmitter design is consistent with anticipated automatic transmitter needs in the future.

AUTOMATIC POWER CONTROL

Automatic gain control of all RF amplifier stages, in conjunction with the exciter's automatic power control, insures constant power output, even with variations in line voltages. This feature is standard in the TV-50H.

STABILITY

One factor assuring RF stability is the use of a solid-state IPA and conservatively rated Type 8988 and 8984 ceramic tetrodes operating as VHF linear amplifiers. These amplifier stages operate in a common grid and screen configuration and tube neutralization is not required.

EXCELLENT COOLING SYSTEM

The cooling system of the TV-50H is quiet and efficient, and employs direct drive blowers, with motors fully protected by automatic reset devices. Tube manufacturers' recommendations are met or exceeded at altitudes up to 7,500 feet, enhancing tube life without power derating.

POWER SUPPLIES

The HV power supply is a multi-phase full wave rectifying system exhibiting very low ripple content prior to output filtering. It is designed for excellent regulation and low video impedance for optimum picture performance. This power supply, including transformer and solid-state rectifiers, is housed in a single assembly, mounted externally from the transmitter. Routine maintenance access is provided by a removable panel.

Vacuum tube filaments are fed with DC to maximize the output signal-to-noise ratio. Grid and screen supplies use solid-state regulators.

The 1700-watt driver cabinet has an independent solid-state HV power supply, and the visual and aural exciters have their own independent, solid-state regulated power supplies.

EASE OF MAINTENANCE AND INSTALLATION

Total transmitter component accessibility is provided, front and back. Visual and aural exciters slide out and can operate independently from the transmitter outside the exciter/driver cabinet. Various exciter circuits, such as oscillators, modulators and processing circuitry, are of modular construction and can be removed for maintenance or replacement.

Easy to read, and mounted at eye-level, 4-inch meters are provided to monitor required transmitter functions. Meter panels are double-hinged for con-

venient access during maintenance. A complete system of overload indicators is also provided in each cabinet for monitoring transmitter operation. In the event of a transmitter malfunction, an examination of the indicators will locate the problem area.

The transmitter has been built in a modular fashion so that cabinets may be separated into convenient, easy-to-handle sub-assemblies to facilitate installation. Additionally, the compact design of the TV-50H minimizes space requirements in the transmitter building.

TVD-100H - 100-KILOWATT DUAL HIGH BAND COLOR TV TRANSMITTER

Designed for use with circularly polarized television antennas, the TVD-100H furnishes a 100-kilowatt visual power output, yet occupies approximately the same floor space as existing 50-kilowatt TV transmitters! This dual transmitter consists of two completely independent 50-kilowatt transmitters (TV-50H's) operating in parallel, combined through the Harris unique-design Dualtran RF switching system.

With the TVD-100H you get two aural exciter/modulators, two visual exciter-modulators, two TSB filters, two solid-state visual and aural IPA's, two visual and aural PA's and two HV power supplies—in short, total redundancy. Complete reliability.

The Dualtran switching system is factory assembled in one cabinet, and can interface with either a hybrid or a notch diplexer.

AUTOMATIC SWITCHING. In the event of a malfunction of one-half of the parallel combination, the Harris TVD-100H offers automatic and instantaneous reduction to one-fourth authorized power. This function will occur without interruption of the carrier. With the touch of a button, half-power operation is achieved in less than three seconds.

Visual and aural exciters are connected in a hot standby condition, and will automatically switch in less than 10 milliseconds in case of failure in either unit. In all modes, aural follows visual for simplified logic control and reliable operation.

OPERATING VERSATILITY. Four modes of operation may be obtained electrically by means of control pushbuttons on the output switcher; by control buttons on the transmitter control panel; or by remote control. These are:

- Transmitters A and B combined and diplexed to the antenna (normal operating mode).
- Transmitter A diplexed to the antenna and transmitter B to the station loads (alternate/main or

emergency operation).

- Transmitter B diplexed to the antenna and transmitter A to the station loads (alternate/main or emergency operation).
- Transmitters A and B combined to the station loads (test mode).

The switching operation from one mode to any other mode requires less than three seconds.

When using a notch diplexer, three other operating modes may be selected manually by changing links on the Dualtran output switching cabinet; transmitters A and B combined and diplexed to the station loads; transmitter A diplexed to the station loads; and transmitter B diplexed into station loads.

CONTROL CABINET. The RF Phasing and Control Panel and the Automatic Exciter/Modulator Switcher are standard equipment with the TVD-100H, and are located in a control cabinet that is typically placed between the two independent 50-kilowatt transmitters. The cabinet is the same height as the transmitters, and the same color, to provide a pleasing installation. All adjustments for dual operation may be made at this cabinet.

The Harris exciter/modulators, with IF Modulation, allow phasing of transmitters for dual operation to be accomplished simply and reliably at low power levels from the RF Phasing and Control Panel. In addition to phasing control, the panel has provisions for monitoring total combined aural power and total combined visual power in forward and reflected modes.

The Automatic Exciter/Modulator Switcher is also a standard part of the control cabinet, and allows for either manual or automatic selection of exciters.

SPECIFICATIONS. Visual and aural performance specifications of the TVD-100H are the same as those of the TV-50H (with the exception of visual power output and aural power output).

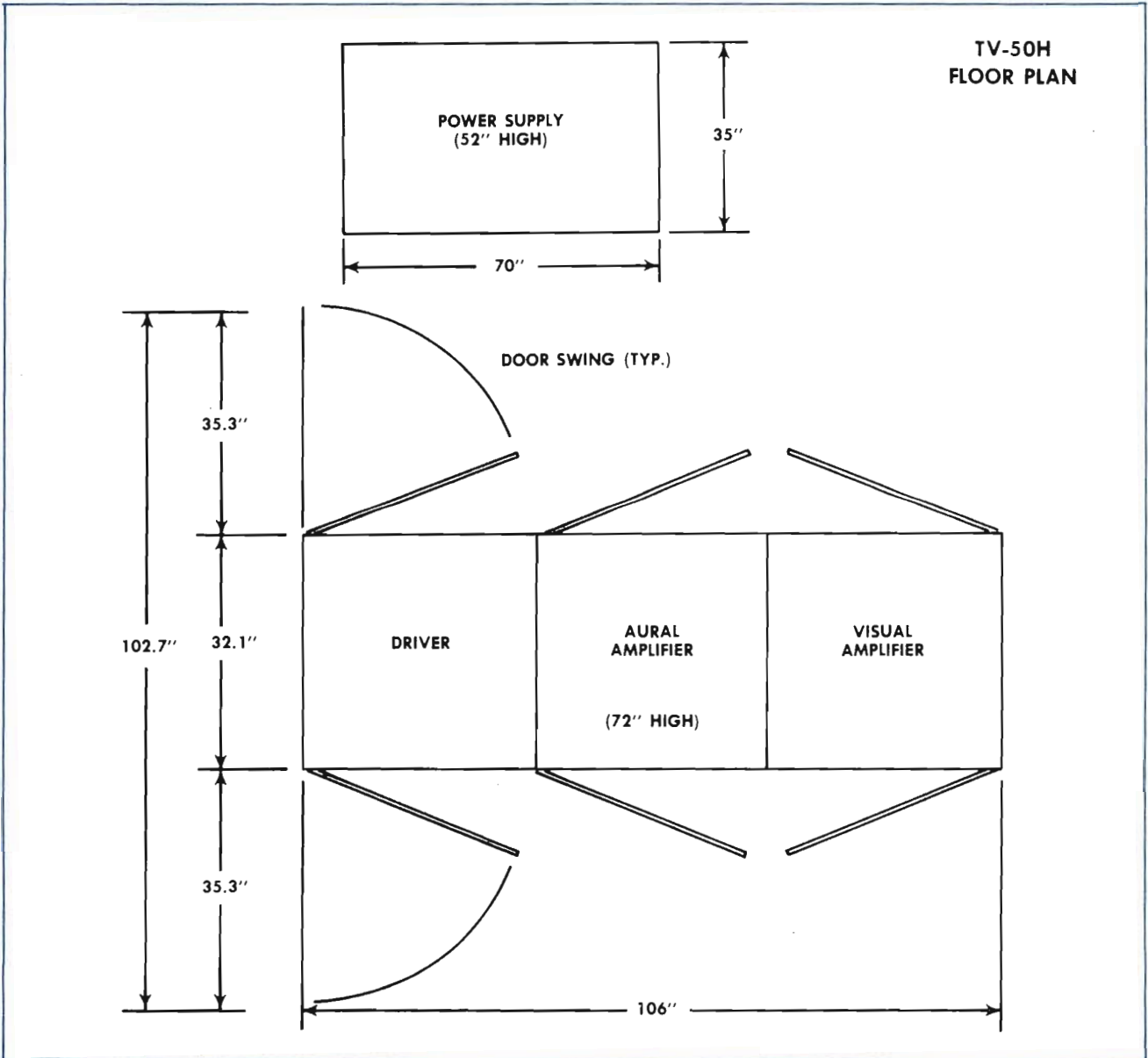
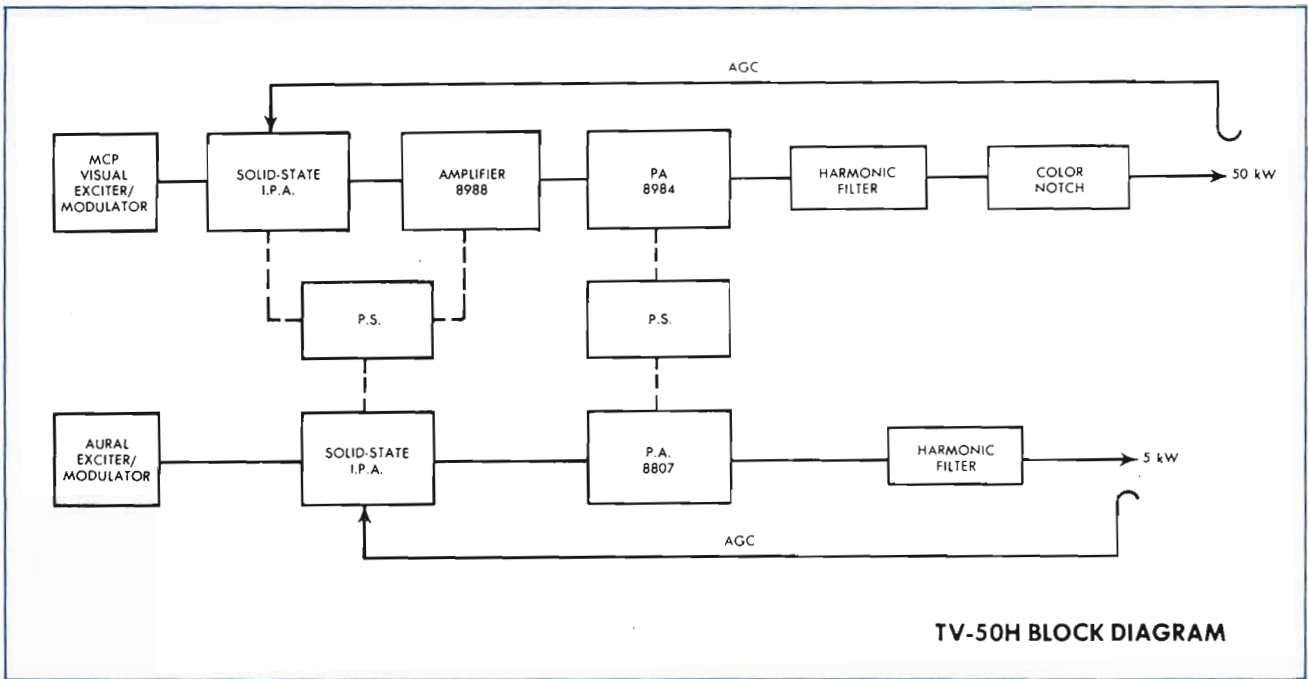

TV-50H SPECIFICATIONS

(NOTE: TVD-100H visual and aural performance specifications same as below except for visual power output and aural power output.)

VISUAL PERFORMANCE

POWER OUTPUT:
OUTPUT IMPEDANCE:
FREQUENCY RANGE:
CARRIER STABILITY:¹
REG. OF RF OUTPUT POWER (Black to white pic.):
VARIATION OF OUTPUT (over one frame):
VISUAL SIDEBAND RESPONSE:

FREQUENCY RESPONSE VS. BRIGHTNESS:²
VISUAL MODULATION CAPABILITY:
DIFFERENTIAL GAIN:³
LINEARITY (LOW FREQUENCY):
DIFFERENTIAL PHASE:⁴
INCIDENTAL PHASE MODULATION:
SIGNAL-TO-NOISE RATIO:
K FACTORS:
EQUIVALENT ENVELOPE DELAY:

VIDEO INPUT:⁵
HARMONIC RADIATION:

AURAL PERFORMANCE

POWER OUTPUT:
OUTPUT IMPEDANCE:
AUDIO INPUT:
FREQUENCY DEVIATION:
INPUT IMPEDANCE:
PRE-EMPHASIS:
FREQUENCY RESPONSE:
DISTORTION:
FM NOISE:
AM NOISE:⁶
FREQUENCY STABILITY:⁷

SERVICE CONDITIONS

AMBIENT TEMPERATURE:
AMBIENT HUMIDITY RANGE:
ALTITUDE:
PHYSICAL AND MECHANICAL DIMENSIONS:

ELECTRICAL REQUIREMENTS:

FCC

50 kW peak.
50 ohms. Output connector: 3/8" EIA standard.
174-216 MHz (Channels 7-13).
±250 Hz (maximum variation over 30 days).
3% or less.
Less than 2%.
—3.58 MHz—42 dB or better
—1.25 MHz and lower—23 dB or better
Carrier to —0.75 MHz±0.5 dB
Carrier0 dB reference
Carrier to +4.20 MHz±0.5 dB
+4.75 MHz and higher—30 dB or better
±0.75 dB.
1% of sync peak.
0.5 dB or better.
1.0 dB or better.
±1° or better.
±3° or better.
—55 dB or better (RMS) below sync level.
2± 2%, 12.5± less than 5% baseline disturbance.
.05 to 2.1 MHz: ±40 ns
at 3.58 MHz: ±30 ns
at 4.18 MHz: ±60 ns
(referenced to standard curve—FCC).
75 ohm system.
—80 dB.

5 kW at diplexer output. (10 kW optional).
50 ohms. Output connector: 3/8" EIA Std.
+10 dBm, ±2 dB.
±25 kHz.
600 ohms.
75 microseconds.
±0.5 dB rel. to pre-emphasis (30-15,000 Hz).
0.5% or less after 75 microseconds de-emphasis with ±25 kHz deviation
—60 dB or better rel. to ±25 kHz dev.
—55 dB relative to 100% modulation.
±250 Hz.

0° to +45°C (at sea level).
0 to 95% relative humidity.
Sea level to 7500 ft.
106"W x 32.1"D x 72"H. Weight: 2600 lbs.
Power supply: 70"W x 35"D x 52"H.
Weight: 2600 lbs.
Power input: 480 Volts, ±25 Volts and 208/240 volts,
±11 volts, 3 phase, 60 Hz. Power consumption:
125 kVA, black picture. Power factor: .9 or better.

SPECIFICATIONS SUBJECT TO CHANGE WITHOUT NOTICE.

- ¹ After initial aging of 60 days.
- ² Measured at 65% and 15% of modulation. Reference 100%=peak of sync.
- ³ Maximum variation of sub-carrier amplitude from 75% to 10% of mod. Sub-carrier mod. percentage: 10% peak to peak.
- ⁴ Maximum variation of sub-carrier phase with respect to burst for mod. percentage from 75% to 10%. Sub-carrier mod. percentage: 10% peak to peak.
- ⁵ Bridging, loop through input with—30 dB or better return loss up to 5.5 MHz.
- ⁶ After de-emphasis.
- ⁷ Relative to frequency offset by 4.5 MHz (FCC) from the visual carrier.

ORDERING INFORMATION

TV-50H, 50 kW VHF-TV transmitter for FCC standards service, Channels 7-13, with operating tubes, transistors, IC's, solid-state rectifiers, crystals, required pre-correction circuitry, low-level vestigial sideband filter, harmonic and color notch filters 994-8225-001
TVD-100H, 100 kW dual VHF-TV transmitter for FCC standards service, Channels 7-13, equipped as above 994-8457-001



HARRIS
COMMUNICATION AND
INFORMATION PROCESSING

TVD-50H

50-Kilowatt Dual VHF High Band Color Television Transmitter

- Two independent, complete 25-kilowatt transmitters for total redundancy and on-the-air reliability
- "Hot" standby exciters, modulators and sideband filter for maximum redundancy
- Harris' Dualtran output switching system allows parallel, single transmitter or alternate/main operation
- Advanced Transversal SideBand (TSB) filters—no group delay, no tuning adjustments required
- Solid-State exciters and IPAs enhance reliability
- IF Modulation of the visual and aural carriers for superb color and sound reproduction
- Superior color performance—minimal corrections required
- Easily interfaced with ATS and remote control systems
- Simple solid-state logic control
- Fast turn-on time
- Modular pre-wired cabinets for fast and easy installation

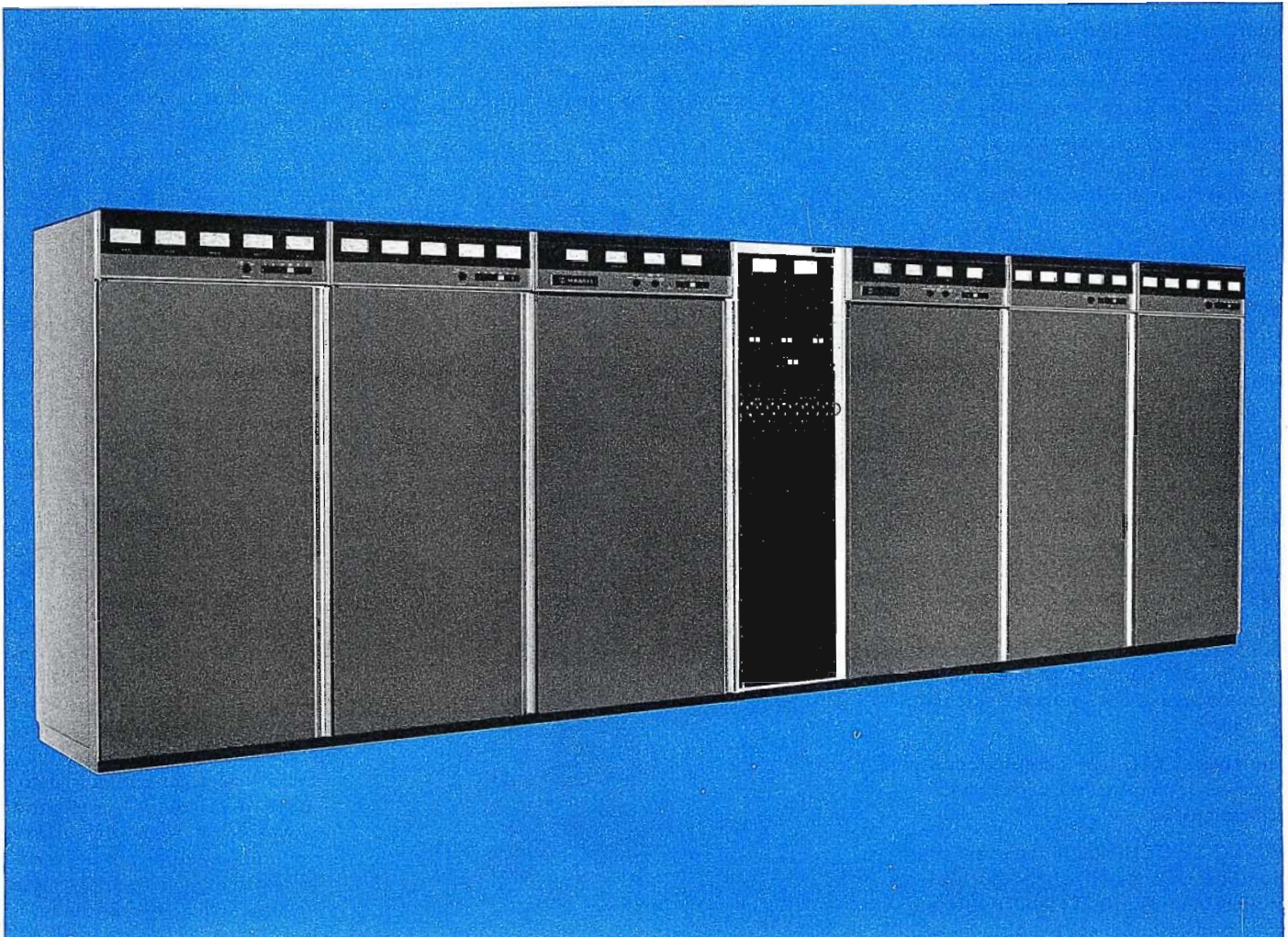

TVD-50H

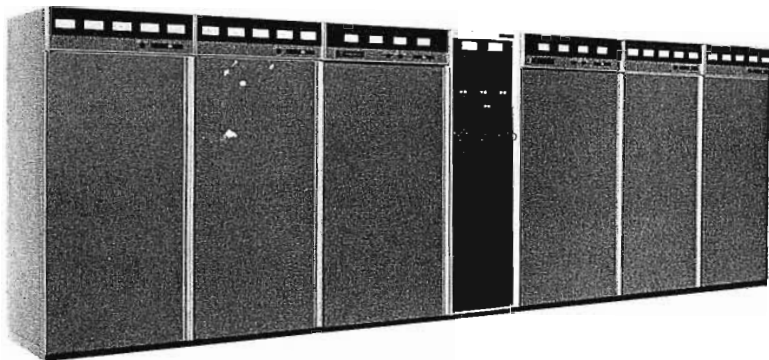

TOTAL REDUNDANCY FOR COMPLETE RELIABILITY

The Harris TVD-50H, 50-kilowatt dual high band VHF TV transmitter, is designed for television broadcasters who want the utmost in reliability and performance—with the flexibility for remote control or automatic operation. This dual transmitter consists of two completely independent 25-kilowatt transmitters operating in parallel, combined through the Harris unique-design Dualtran RF switching system.

With the TVD-50H you get two aural exciter/modulators, two visual exciter/modulators, two TSB filters, two solid-state visual and aural IPA's, two visual and aural PA's, and two HV power supplies—in short, total redundancy! Complete reliability!

The Dualtran switching system is factory assembled in one cabinet, and can be supplied to interface with either a hybrid or a notch diplexer.

IF (intermediate frequency) Modulation, low-level sideband filtering, true linear operation of power amplifiers and solid-state visual and aural exciter/modulators combine to provide outstanding color and sound fidelity. As no envelope delay correction or adjustments are required for the solid-state Transversal SideBand filter(s), stability, reliability and color quality are greatly enhanced.

Frequency adjustment, power output control and amplifier tuning are straightforward and uncomplicated, while design simplicity and conservatively rated components in the TVD-50H assure long-term "hands-off" operation and minimum maintenance. DC filaments in the visual and aural stages provide improved signal-to-noise ratios.

The transmitter is FCC type accepted, and factory power testing assures performance to specifications.

AUTOMATIC SWITCHING. In the event of a malfunction of one-half of the parallel combination, the Harris TVD-50H offers automatic and instantaneous reduction to

one-fourth authorized power. This function will occur without interruption of the carrier. With the touch of a button, half-power operation is achieved in less than two seconds.

Visual and aural exciters are connected in a hot standby condition, and will automatically switch in less than 10 milliseconds in case of failure in either unit. In all modes, aural follows visual for simplified logic control and reliable operation.

OPERATING VERSATILITY. Four modes of operation may be obtained electrically by means of control pushbuttons on the output switcher; by control buttons on the transmitter control panel; or by remote control. These are:

- Transmitters A and B combined On-Air.
- Transmitter A On-Air and transmitter B into the station loads.
- Transmitter B On-Air and transmitter A into the station loads.
- Transmitters A and B combined to the station loads (test mode).

The switching operation from one mode to any other mode requires less than two seconds.

When using a notch diplexer, three other operating modes may be selected manually by changing links on the Dualtran output switching cabinet: transmitters A and B combined and diplexed to the station loads; transmitter A diplexed into station loads; and transmitter B diplexed into station loads.

EXCELLENT PERFORMANCE

Surface acoustic wave technology is applied to vestigial sideband filtering in the visual exciter. The Transversal SideBand (TSB) filter displays a near-ideal bandpass function for CCIR Systems "M" (FCC) and "B" bandwidths. This, combined with the filter's true linear phase characteristic, offers excellent reproduction of pulse waveforms and encoded color information without adjustment.

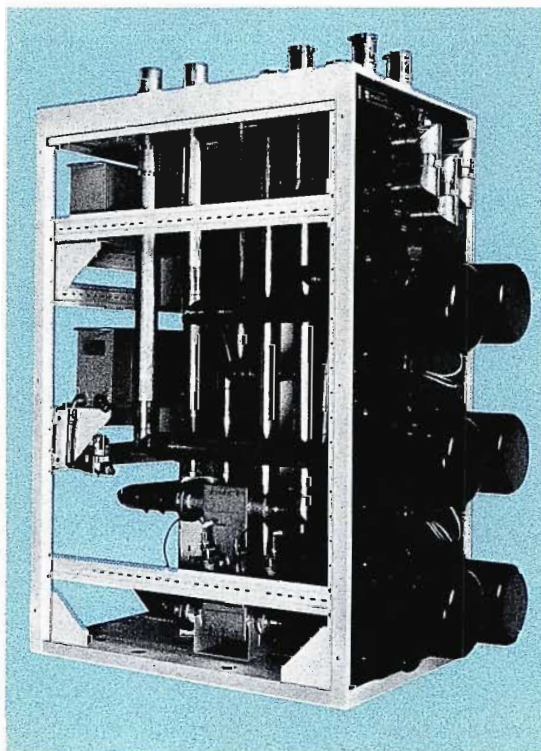

DUALTRAN OUTPUT SWITCHER CABINET

All switches, patch panels, combiners, reject and dummy loads, couplers, sensors and control logic are factory assembled, tested and optimized for best VSWR across the channel. The only external transmission line connections are for the transmitters, antenna and diplexer. This saves installation labor and time, and insures excellent performance without field optimization. Motorized coaxial switches accomplish RF switching at the push of a button on the output switcher control panel, center transmitter control cabinet or via remote control. Solid-state control logic automatically routes command signals to turn off plate voltages, operate proper coaxial switches and re-apply plate voltage...all in two seconds or less.



CENTER CONTROL CABINET

All adjustments and control of dual transmitter operation can be accomplished from the control cabinet, supplied as standard equipment in all Harris Dualtran systems. This cabinet is normally mounted between the two independent transmitters to provide a pleasing installation. The RF phasing and control panel, the exciter/modulator switcher, and the local control panel are standard equipment with the Harris Dualtran systems.

RF Phasing and Control Panel: Here the output of the on-air exciter/modulator is split to drive the two transmitters. Phasing controls and attenuators provide adjustment of the two signals to assure maximum combined transmitter output. Switchable visual and aural power meters are provided to monitor combined forward, combined reflected and reject power levels. Also, Dualtran output switcher control logic pushbuttons on this panel can select "A + B Air", "A Air", "B Air" or "A + B Test" modes.

Local Control Panel: Provides simultaneous control of both transmitters including filament and plate on/off and aural and visual raise/lower functions. All system remote control terminals are available on this panel.

Exciter/Modulator Switcher: Solid-state control logic provides manual or automatic switching of the two exciter/modulators from "hot standby" to "on-air" status in case of exciter failure. Switching occurs in 10 milliseconds for no perceptible loss of signal.

Input Patch Panel (Optional): Permits bypassing the exciter/modulator switcher via BNC cables to patch any combination of aural/visual exciters to any transmitter. This provides extra flexibility for emergency situations and for system maintenance and testing.

RF Input Bypass Switcher (Optional—Not Shown): In single transmitter modes this switcher removes the 3 dB coupler in the RF phasing/control panel from input circuitry, thereby putting full rated power of any one transmitter on the air.

TVD-50H

SOLID-STATE IPA

Each 25-kilowatt transmitter features a solid-state IPA to greatly enhance reliability and reduce tuning requirements.

The solid-state IPAs contain broadband amplifiers, so that periodic bandpass adjustments are not required—and they are fully protected against damage caused by overloads or load variations. For added transmitter protection, RF drive is applied over a one to two second interval, which permits DC voltage stabilization before full RF drive application to power amplifiers. The IPAs are fully metered for monitoring and maintenance, while excellent cooling helps maintain long transistor life.

Each 25-kilowatt transmitter employs a single-ended visual PA (8916 tetrode), and DC filaments in every stage for an excellent signal-to-noise ratio.

TRANSVERSAL SIDE BAND (TSB) FILTER

The Harris solid-state sideband filter is an advanced surface acoustic wave design, and shapes visual sidebands at the IF frequency, rather than "on frequency" at the full output power of the transmitter. Unlike previous VSB filters, the TSB filter has an inherent linear phase characteristic and requires no group delay correction or tuning.

SOLID-STATE VISUAL AND AURAL EXCITER/MODULATORS

The Harris solid-state MCP-1V visual exciter/modulator is an independent, self-contained unit which provides a fully processed on-channel picture signal. Power output can be varied up to one watt with a single front panel control, or from a remote location, without retuning of any kind.

The MCP-1V provides great reliability and stability, excellent frequency response, and truest color quality. It is designed for minimum maintenance and set-up time, and for remote control and unattended operation. This is all made possible through the use of the latest design techniques, including Harris' solid-state TSB filter.

The Harris aural exciter/modulator is a solid-state, self-contained unit which furnishes a fully processed aural signal at a level up to 10 watts. Power output can be set with a single knob on the front panel, or by remote control, with no need for retuning. It is mounted in a pull-out drawer, and may be operated with the drawer extended for test purposes.

INTERMEDIATE FREQUENCY (IF) MODULATION

One of the features of the TVD-50H is its true low-level IF Modulation, which offers a top quality picture, and excels in electrical performance, reliability and simplicity of operation.

Due to the low-level techniques, which include the use of devices such as an extremely linear broadband diode ring modulator, low-level sideband filtering and very linear broadband amplifiers, the color signal is a faithful reproduction of the signal applied to the transmitter input.

SOLID-STATE CONTROL CIRCUITS

Solid-state memory, timing and logic circuits offer complete and foolproof control of all transmitter functions. Built-in memory circuitry enables the entire transmitter to return to the air automatically in the state it was operating prior to an AC power interruption.

The control logic, in addition to commanding normal AC control functions, is also used to visually indicate, through indicator lights, the operating status of the transmitter system. These indicator lights allow easy isolation of circuit faults, and are easily removed.

REMOTE CONTROL, UNATTENDED AND AUTOMATIC OPERATION

All control, metering and monitoring circuits have been designed specifically for remote control and ATS. The power controls are motor driven and the necessary remote control sampling points are built-in on accessible terminal boards. Today, Harris TV transmitters are being operated successfully worldwide with a variety of remote control systems.

AUTOMATIC POWER CONTROL

Automatic gain control of all RF amplifier stages, in conjunction with the exciters' automatic power control, insures essentially constant power output, even with variations in line voltages. This feature is standard in the TVD-50H.

STABILITY

One factor assuring RF stability is the use of solid-state IPA'S and conservatively rated Type 8988, 8807 and 8916 ceramic tetrodes operating as VHF linear amplifiers. These amplifier stages operate in a common grid and screen configuration and tube neutralization is not required.

EXCELLENT COOLING SYSTEM

The cooling system of the TVD-50H is quiet and efficient, and employs direct drive blowers, with the motors fully protected by automatic reset devices.

POWER SUPPLIES

The HV power supplies for the TVD-50H visual and aural PAs exhibit very low ripple content. They are designed for excellent regulation and low video impedance for optimum picture performance. In addition, for ease of maintenance, the two power supplies, including transformers and solid-state rectifiers, are housed in two separate assemblies, mounted externally from the transmitter. Routine maintenance access is provided by removable panels.

Vacuum tube filaments in the visual transmitters are operated from DC power supplies to maximize the output signal-to-noise ratio. Grid and screen supplies are 100% solid state.

The visual and aural exciters have their own independent, solid-state regulated power supplies.

EASE OF MAINTENANCE

Convenient access to components is provided, permitting the transmitter to be easily maintained. Visual and aural exciters slide out and can operate independently from the transmitter outside the cabinet. Various exciter circuits, such as oscillators, modulators and processing circuitry, are of modular construction and can be removed for maintenance or replacement.

Easy-to-read, eye-level 4-inch meters are used to monitor required transmitter functions. Meter panels are of double-hinged construction for easy access during maintenance.

TVD-50H

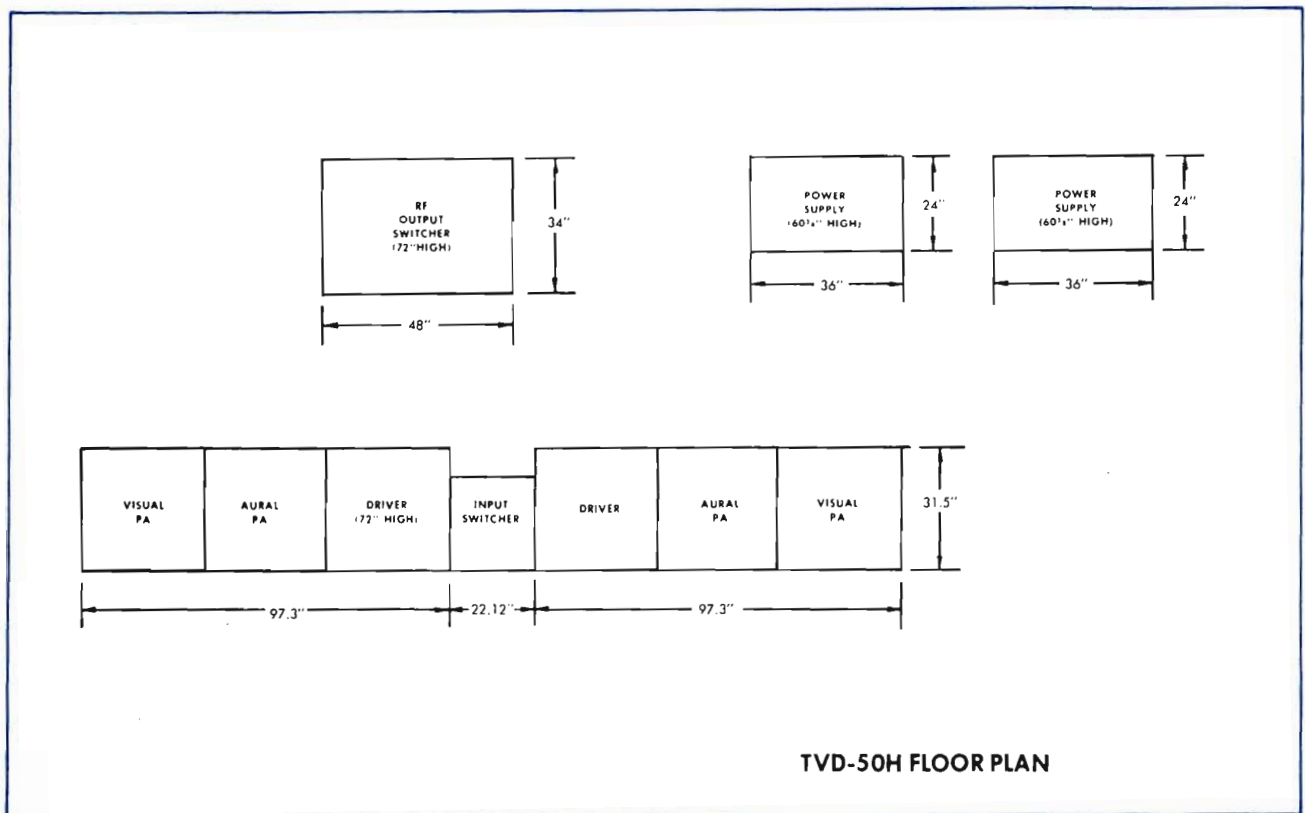
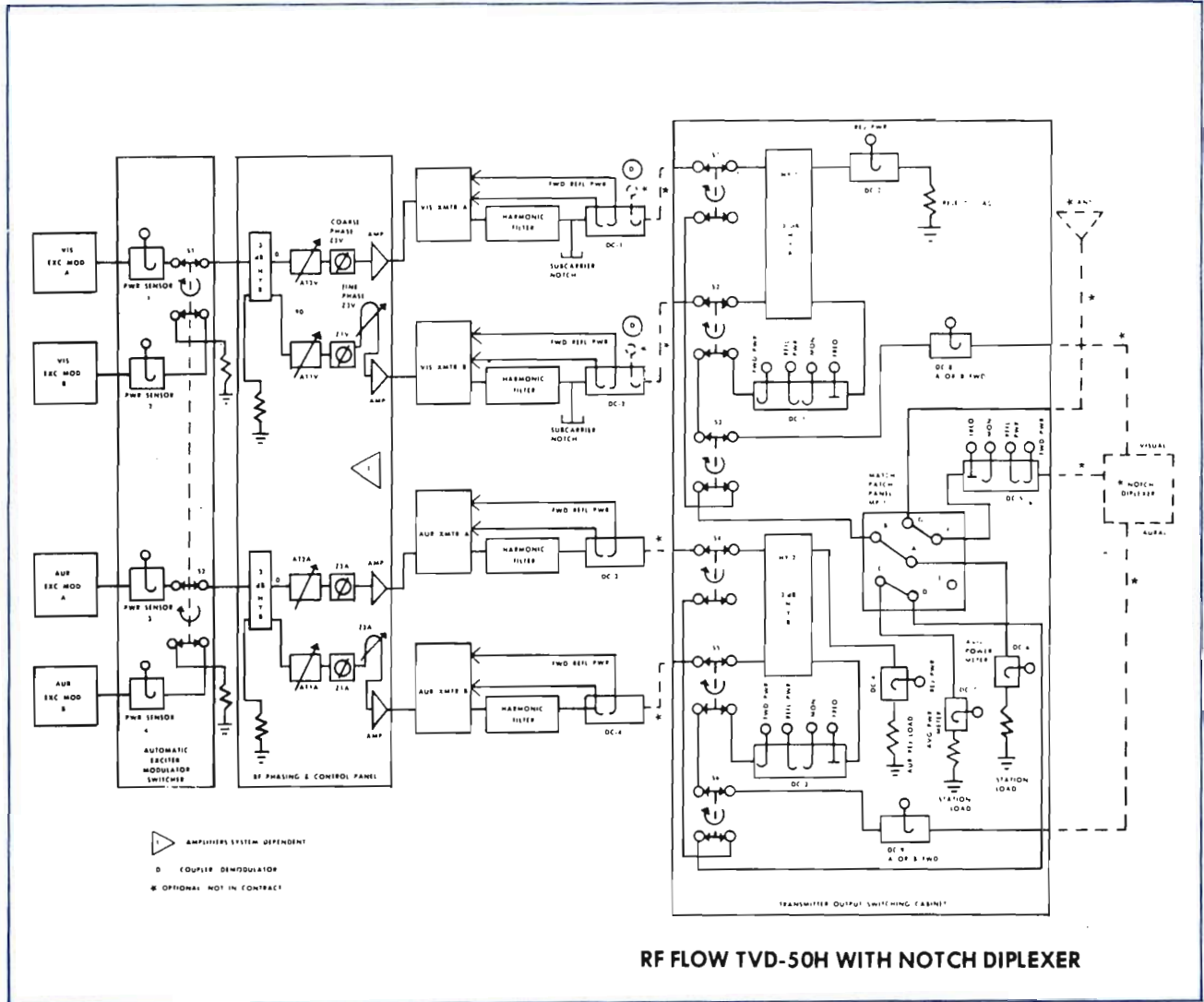

TVD-50H SPECIFICATIONS

VISUAL PERFORMANCE

POWER OUTPUT:
 OUTPUT IMPEDANCE:
 FREQUENCY RANGE:
 CARRIER STABILITY:¹
 REG. OF RF OUTPUT POWER (Black to white pic.):
 VARIATION OF OUTPUT (over one frame):
 VISUAL SIDEBAND RESPONSE:

FREQUENCY RESPONSE VS. BRIGHTNESS:²
 VISUAL MODULATION CAPABILITY:
 DIFFERENTIAL GAIN:³
 LINEARITY (LOW FREQUENCY):
 INCIDENTAL PHASE MODULATION:

DIFFERENTIAL PHASE:⁴
 SIGNAL-TO-NOISE RATIO:
 K FACTORS:
 EQUIVALENT ENVELOPE DELAY:

VIDEO INPUT:⁵
 HARMONIC RADIATION:

AURAL PERFORMANCE

POWER OUTPUT:
 OUTPUT IMPEDANCE:
 AUDIO INPUT:
 FREQUENCY DEVIATION:
 INPUT IMPEDANCE:
 PRE-EMPHASIS:
 FREQUENCY RESPONSE:
 DISTORTION:

FM NOISE:
 AM NOISE:⁶
 FREQUENCY STABILITY:⁷

SERVICE CONDITIONS

AMBIENT TEMPERATURE:
 AMBIENT HUMIDITY RANGE:
 ALTITUDE:

PHYSICAL AND MECHANICAL DIMENSIONS:

ELECTRICAL REQUIREMENTS:

FCC (System "M")

50 kW peak.
 50 ohms. Output connector: 3/8" EIA standard.
 174-216 MHz (Channels 7-13).
 ±250 Hz (maximum variation over 30 days).
 3% or less.
 Less than 2%.
 —3.58 MHz —42 dB or better
 —1.25 MHz and lower —26 dB or better
 Carrier to —0.75 MHz ±0.5 dB
 Carrier 0 dB reference
 Carrier to +4.20 MHz ±0.5 dB
 +4.75 MHz and higher —30 dB or better
 ±0.75 dB.
 1% or better.
 3% or better.
 1.0 dB or better.
 ±3° or better.
 ±1° or better.
 —55 dB or better (RMS) below sync level.
 2± 2%, 12.5± less than 5% baseline disturbance.
 .05 to 2.1 MHz: ± 40 ns.
 at 3.58 MHz: ± 30 ns.
 at 4.18 MHz: ± 60 ns.
 (referenced to standard curve—FCC).
 75 ohm system.
 —80 dB.

10 kW at diplexer output.
 50 ohms. Output connector: 3/8" EIA Std.
 +10 dBm, ±2 dB.
 ±25 kHz.
 600 ohms.
 75 microseconds.
 ±0.5 dB rel. to pre-emphasis (30-15,000 Hz).
 0.5% or less after 75 microseconds de-emphasis
 with ±25 kHz deviation.
 —60 dB or better rel. to ±25 kHz dev.
 —55 dB relative to 100% modulation.
 ±250 Hz.

—10° to +50°C (14° to 122°F).
 0 to 95% relative humidity.
 Sea level to 7500 ft.

216.72" W x 31.5" D x 72.0" H. Weight: 6,770 lbs.
 Power supplies (2) each: 36" W x 24" D x 60.4" H.
 Weight: 950 lbs.

Output switcher: 34" W x 48" D x 72" H. Weight:
 1,350 lbs.

Power input: 208/240 volts, ±11 volts, 3 phase,
 50/60 Hz. Power consumption (approx.): 116
 kVA, black picture, 10% aural; 98 kVA, average
 picture (50% APL), 10% aural; 124 kVA, black
 picture at 20% aural; 106 kVA, average picture
 at 20% aural.

SPECIFICATIONS SUBJECT TO CHANGE WITHOUT NOTICE.

¹ After initial aging of 60 days.

² Measured at 65% and 15% of modulation. Reference 100% = peak of sync.

³ Maximum variation of sub-carrier amplitude from 75% to 10% of mod. Sub-carrier mod. percentage: 10% peak to peak.

⁴ Maximum variation of sub-carrier phase with respect to burst for mod. percentage from 75% to 10%. Sub-carrier mod. percentage: 10% peak to peak.

⁵ Bridging, loop through input with —30 dB or better return loss up to 5.5 MHz.

⁶ After de-emphasis.

⁷ Relative to frequency offset by 4.5 MHz (FCC) from the visual carrier.

ORDERING INFORMATION

TVD-50H, 50 kW dual VHF-TV transmitter for FCC standards service, Channels 7-13, with operating tubes, semiconductors, crystals, VSB filter, color notch filter, harmonic filters, input and output switchers 994-8408-001



HARRIS
COMMUNICATION AND
INFORMATION PROCESSING

TVD-36H

36-Kilowatt Dual VHF High Band Color Television Transmitter

- Two independent, complete 18-kilowatt transmitters for total redundancy and on-the-air reliability
- "Hot" standby exciters, modulators and sideband filter for maximum redundancy
- Harris' Dualtran output switching system allows parallel, single transmitter or alternate/main operation
- Advanced Transversal SideBand (TSB) filters—no group delay, no tuning adjustments required
- Solid-State exciters and IPAs enhance reliability
- IF Modulation of the visual and aural carriers for superb color and sound reproduction
- Superior color performance—minimal corrections required
- Easily interfaced with ATS and remote control systems
- Simple solid-state logic control
- Fast turn-on time
- Modular pre-wired cabinets for fast and easy installation

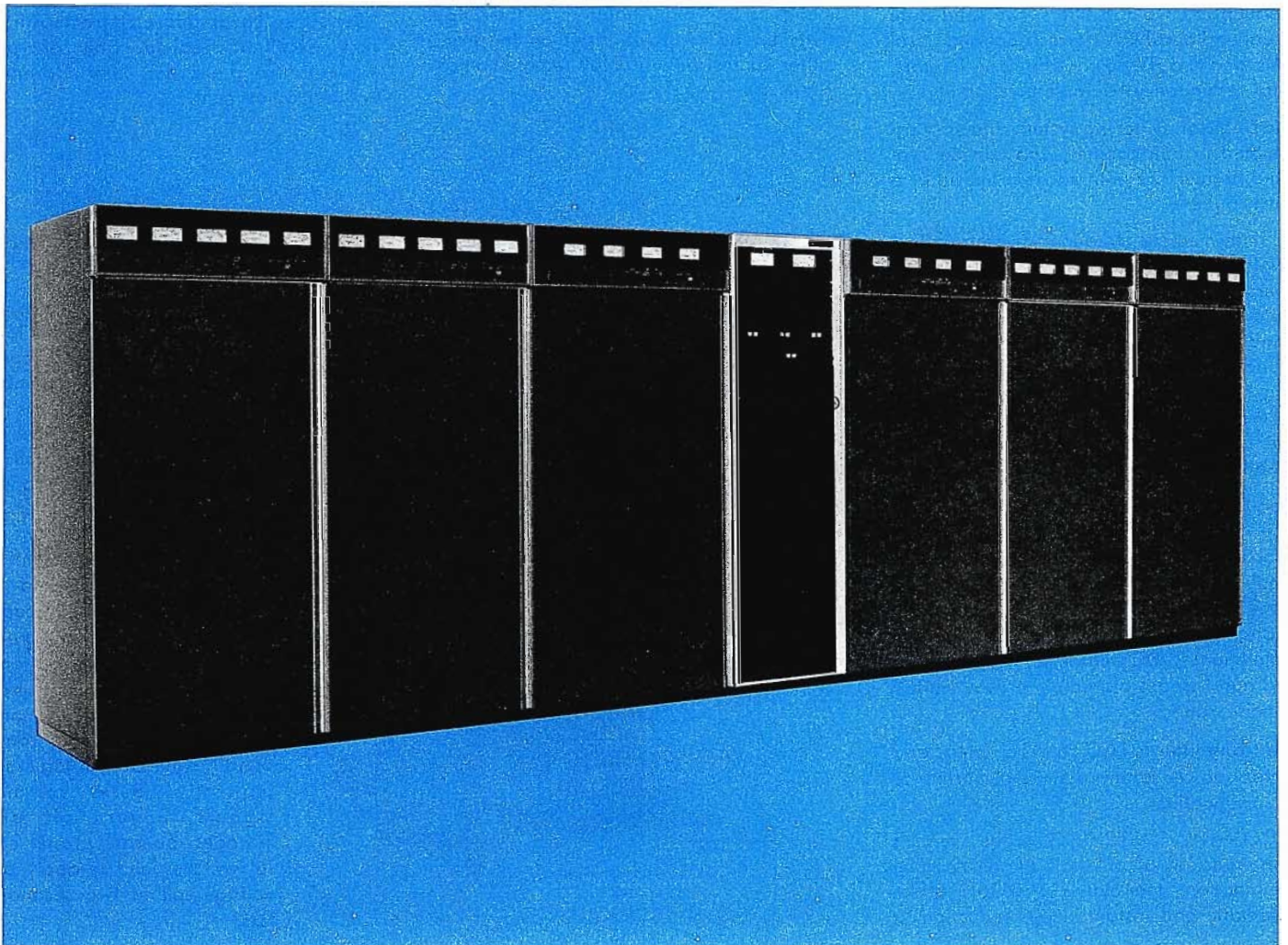

TVD-36H

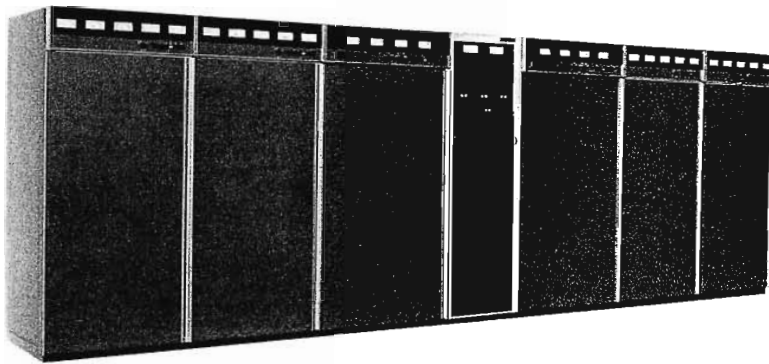

TOTAL REDUNDANCY FOR COMPLETE RELIABILITY

The Harris TVD-36H, 36-kilowatt dual high band VHF TV transmitter, is designed for television broadcasters who want the utmost in reliability and performance—with the flexibility for remote control or automatic operation. This dual transmitter consists of two completely independent 18-kilowatt transmitters operating in parallel, combined through the Harris unique-design Dualtran RF switching system.

With the TVD-36H you get two aural exciter/modulators, two visual exciter/modulators, two TSB filters, two solid-state visual and aural IPA's, two visual and aural PA's, and two HV power supplies—in short, total redundancy! Complete reliability!

The Dualtran switching system is factory assembled in one cabinet, and can be supplied to interface with either a hybrid or a notch diplexer.

IF (intermediate frequency) Modulation, low-level sideband filtering, true linear operation of power amplifiers and solid-state visual and aural exciter/modulators combine to provide outstanding color and sound fidelity. As no envelope delay correction or adjustments are required for the solid-state Transversal SideBand filter(s), stability, reliability and color quality are greatly enhanced.

Frequency adjustment, power output control and amplifier tuning are straightforward and uncomplicated, while design simplicity and conservatively rated components in the TVD-36H assure long-term "hands-off" operation and minimum maintenance. DC filaments in the visual and aural stages provide improved signal-to-noise ratios.

The transmitter is FCC type accepted, and factory power testing assures performance to specifications.

AUTOMATIC SWITCHING. In the event of a malfunction of one-half of the parallel combination, the Harris TVD-36H offers automatic and instantaneous reduction to

one-fourth authorized power. This function will occur without interruption of the carrier. With the touch of a button, half-power operation is achieved in less than two seconds.

Visual and aural exciters are connected in a hot standby condition, and will automatically switch in less than 10 milliseconds in case of failure in either unit. In all modes, aural follows visual for simplified logic control and reliable operation.

OPERATING VERSATILITY. Four modes of operation may be obtained electrically by means of control pushbuttons on the output switcher; by control buttons on the transmitter control panel; or by remote control. These are:

- Transmitters A and B combined On-Air.
- Transmitter A On-Air and transmitter B into the station loads.
- Transmitter B On-Air and transmitter A into the station loads.
- Transmitters A and B combined to the station loads (test mode).

The switching operation from one mode to any other mode requires less than two seconds.

When using a notch diplexer, three other operating modes may be selected manually by changing links on the Dualtran output switching cabinet: transmitters A and B combined and diplexed to the station loads; transmitter A diplexed into station loads; and transmitter B diplexed into station loads.

EXCELLENT PERFORMANCE

Surface acoustic wave technology is applied to vestigial sideband filtering in the visual exciter. The Transversal SideBand (TSB) filter displays a near-ideal bandpass function for CCIR Systems "M" (FCC) and "B" bandwidths. This, combined with the filter's true linear phase characteristic, offers excellent reproduction of pulse waveforms and encoded color information without adjustment.

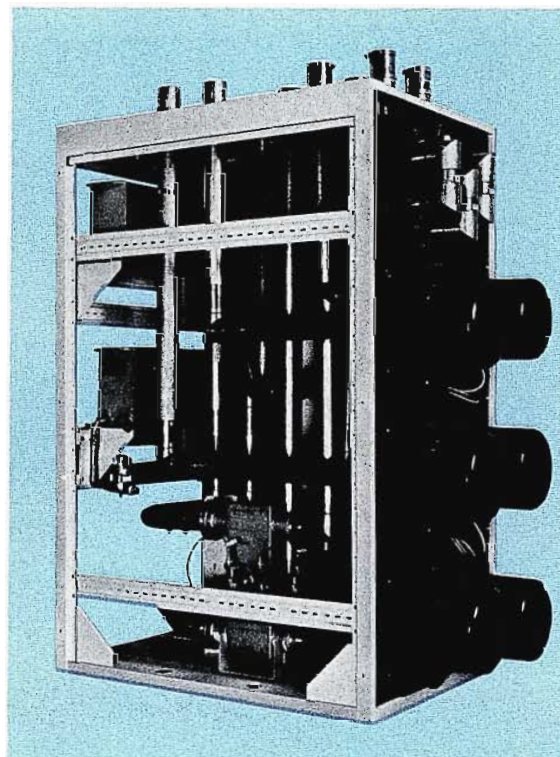

DUALTRAN OUTPUT SWITCHER CABINET

All switches, patch panels, combiners, reject and dummy loads, couplers, sensors and control logic are factory assembled, tested and optimized for best VSWR across the channel. The only external transmission line connections are for the transmitters, antenna and diplexer. This saves installation labor and time, and insures excellent performance without field optimization. Motorized coaxial switches accomplish RF switching at the push of a button on the output switcher control panel, center transmitter control cabinet or via remote control. Solid-state control logic automatically routes command signals to turn off plate voltages, operate proper coaxial switches and re-apply plate voltage...all in two seconds or less.

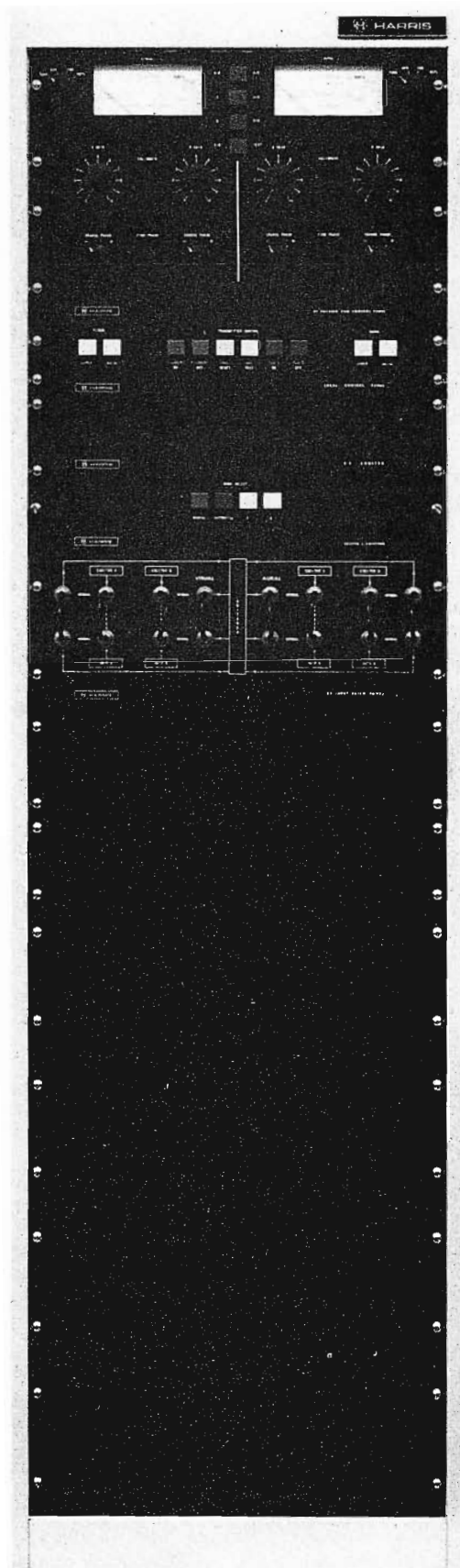

CENTER CONTROL CABINET

All adjustments and control of dual transmitter operation can be accomplished from the control cabinet, supplied as standard equipment in all Harris Dualtran systems. This cabinet is normally mounted between the two independent transmitters to provide a pleasing installation. The RF phasing and control panel, the exciter/modulator switcher, and the local control panel are standard equipment with the Harris Dualtran systems.

RF Phasing and Control Panel: Here the output of the on-air exciter/modulator is split to drive the two transmitters. Phasing controls and attenuators provide adjustment of the two signals to assure maximum combined transmitter output. Switchable visual and aural power meters are provided to monitor combined forward, combined reflected and reject power levels. Also, Dualtran output switcher control logic pushbuttons on this panel can select "A + B Air", "A Air", "B Air" or "A + B Test" modes.

Local Control Panel: Provides simultaneous control of both transmitters including filament and plate on/off and aural and visual raise/lower functions. All system remote control terminals are available on this panel.

Exciter/Modulator Switcher: Solid-state control logic provides manual or automatic switching of the two exciter/modulators from "hot standby" to "on-air" status in case of exciter failure. Switching occurs in 10 milliseconds for no perceptible loss of signal.

Input Patch Panel (Optional): Permits bypassing the exciter/modulator switcher via BNC cables to patch any combination of aural/visual exciters to any transmitter. This provides extra flexibility for emergency situations and for system maintenance and testing.

RF Input Bypass Switcher (Optional—Not Shown): In single transmitter modes this switcher removes the 3 dB coupler in the RF phasing/control panel from input circuitry, thereby putting full rated power of any one transmitter on the air.

TVD-36H

SOLID-STATE IPA

Each 18-kilowatt transmitter features a solid-state IPA to greatly enhance reliability and reduce tuning requirements.

The solid-state IPAs contain broadband amplifiers, so that periodic bandpass adjustments are not required—and they are fully protected against damage caused by overloads or load variations. For added transmitter protection, RF drive is applied over a one to two second interval, which permits DC voltage stabilization before full RF drive application to power amplifiers. The IPAs are fully metered for monitoring and maintenance, while excellent cooling helps maintain long transistor life.

Each 18-kilowatt transmitter employs a single-ended visual PA (8916 tetrode) and DC filaments in every stage for an excellent signal-to-noise ratio.

TRANSVERSAL SIDE BAND (TSB) FILTER

The Harris solid-state sideband filter is an advanced surface acoustic wave design, and shapes visual sidebands at the IF frequency, rather than "on frequency" at the full output power of the transmitter. Unlike previous VSB filters, the TSB filter has an inherent linear phase characteristic and requires no group delay correction or tuning.

SOLID-STATE VISUAL AND AURAL EXCITER/MODULATORS

The Harris solid-state MCP-1V visual exciter/modulator is an independent, self-contained unit which provides a fully processed on-channel picture signal. Power output can be varied up to one watt with a single front panel control, or from a remote location, without retuning of any kind.

The MCP-1V provides great reliability and stability, excellent frequency response, and truest color quality. It is designed for minimum maintenance and set-up time, and for remote control and unattended operation. This is all made possible through the use of the latest design techniques, including Harris' solid-state TSB filter.

The Harris aural exciter/modulator is a solid-state, self-contained unit which furnishes a fully processed aural signal at a level up to 10 watts. Power output can be set with a single knob on the front panel, or by remote control, with no need for retuning. It is mounted in a pull-out drawer, and may be operated with the drawer extended for test purposes.

INTERMEDIATE FREQUENCY (IF) MODULATION

One of the features of the TVD-36H is its true low-level IF Modulation, which offers a top quality picture, and excels in electrical performance, reliability and simplicity of operation.

Due to the low-level techniques, which include the use of devices such as an extremely linear broadband diode ring modulator, low-level sideband filtering and very linear broadband amplifiers, the color signal is a faithful reproduction of the signal applied to the transmitter input.

SOLID-STATE CONTROL CIRCUITS

Solid-state memory, timing and logic circuits offer complete and foolproof control of all transmitter functions. Built-in memory circuitry enables the entire transmitter to return to the air automatically in the state it was operating prior to an AC power interruption.

The control logic, in addition to commanding normal AC control functions, is also used to visually indicate, through indicator lights, the operating status of the transmitter system. These indicator lights allow easy isolation of circuit faults, and are easily removed.

REMOTE CONTROL, UNATTENDED AND AUTOMATIC OPERATION

All control, metering and monitoring circuits have been designed specifically for remote control and ATS. The power controls are motor driven and the necessary remote control sampling points are built-in on accessible terminal boards. Today, Harris TV transmitters are being operated successfully worldwide with a variety of remote control systems.

AUTOMATIC POWER CONTROL

Automatic gain control of all RF amplifier stages, in conjunction with the exciters' automatic power control, insures essentially constant power output, even with variations in line voltages. This feature is standard in the TVD-36H.

STABILITY

One factor assuring RF stability is the use of solid-state IPA'S and conservatively rated Type 8988, 8807 and 8916 ceramic tetrodes operating as VHF linear amplifiers. These amplifier stages operate in a common grid and screen configuration and tube neutralization is not required.

EXCELLENT COOLING SYSTEM

The cooling system of the TVD-36H is quiet and efficient, and employs direct drive blowers, with the motors fully protected by automatic reset devices.

POWER SUPPLIES

The HV power supplies for the TVD-36H visual and aural PAs exhibit very low ripple content. They are designed for excellent regulation and low video impedance for optimum picture performance. In addition, for ease of maintenance, the two power supplies, including transformers and solid-state rectifiers, are housed in two separate assemblies, mounted externally from the transmitter. Routine maintenance access is provided by removable panels.

Vacuum tube filaments in the visual transmitters are operated from DC power supplies to maximize the output signal-to-noise ratio. Grid and screen supplies are 100% solid state.

The visual and aural exciters have their own independent, solid-state regulated power supplies.

EASE OF MAINTENANCE

Convenient access to components is provided, permitting the transmitter to be easily maintained. Visual and aural exciters slide out and can operate independently from the transmitter outside the cabinet. Various exciter circuits, such as oscillators, modulators and processing circuitry, are of modular construction and can be removed for maintenance or replacement.

Easy-to-read, eye-level 4-inch meters are used to monitor required transmitter functions. Meter panels are of double-hinged construction for easy access during maintenance.

TVD-36H

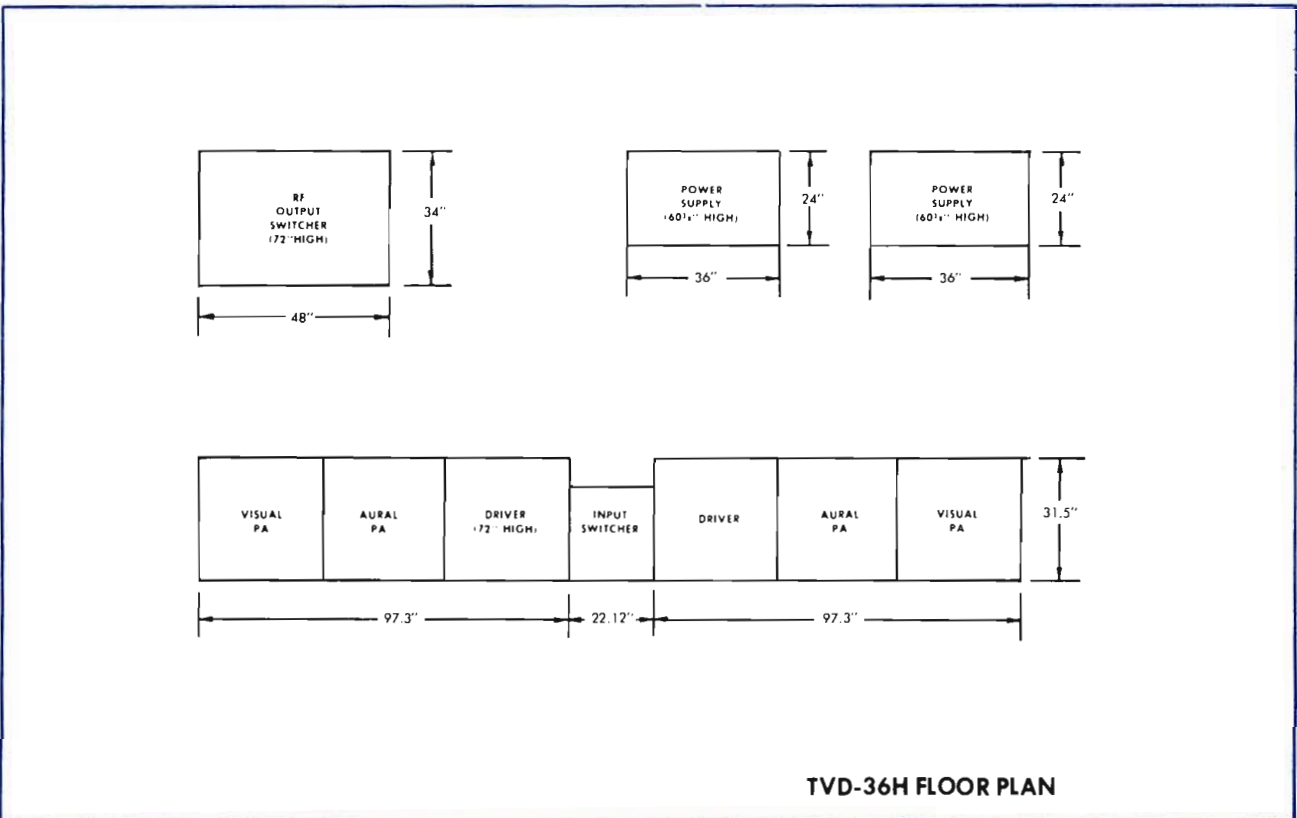
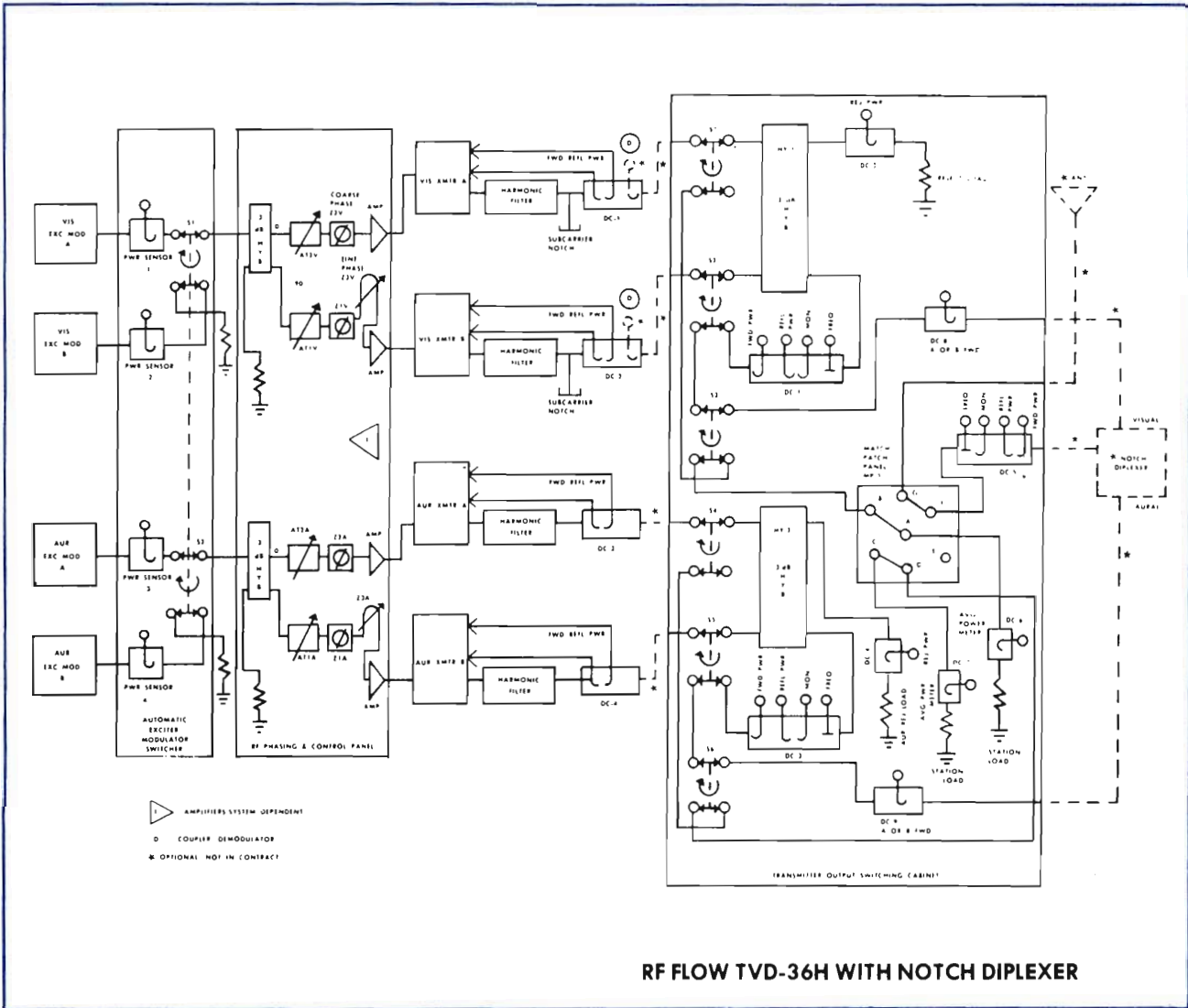

TVD-36H SPECIFICATIONS

VISUAL PERFORMANCE

POWER OUTPUT:
 OUTPUT IMPEDANCE:
 FREQUENCY RANGE:
 CARRIER STABILITY:¹
 REG. OF RF OUTPUT POWER (Black to white pic.):
 VARIATION OF OUTPUT (over one frame):
 VISUAL SIDEBAND RESPONSE:

FREQUENCY RESPONSE VS. BRIGHTNESS:²
 VISUAL MODULATION CAPABILITY:
 DIFFERENTIAL GAIN:³
 LINEARITY (LOW FREQUENCY):
 INCIDENTAL PHASE MODULATION:
 DIFFERENTIAL PHASE:⁴
 SIGNAL-TO-NOISE RATIO:
 K FACTORS:
 EQUIVALENT ENVELOPE DELAY:

VIDEO INPUT:⁵
 HARMONIC RADIATION:

AURAL PERFORMANCE

POWER OUTPUT:
 OUTPUT IMPEDANCE:
 AUDIO INPUT:
 FREQUENCY DEVIATION:
 INPUT IMPEDANCE:
 PRE-EMPHASIS:
 FREQUENCY RESPONSE:
 DISTORTION:

FM NOISE:
 AM NOISE:⁶
 FREQUENCY STABILITY:⁷

SERVICE CONDITIONS

AMBIENT TEMPERATURE:
 AMBIENT HUMIDITY RANGE:
 ALTITUDE:

PHYSICAL AND MECHANICAL DIMENSIONS:

ELECTRICAL REQUIREMENTS:

FCC (System "M")

36 kW peak.
 50 ohms. Output connector: 3 1/8" EIA standard.
 174-216 MHz (Channels 7-13).
 ±250 Hz (maximum variation over 30 days).
 3% or less.
 Less than 2%.
 —3.58 MHz —42 dB or better
 —1.25 MHz and lower —26 dB or better
 Carrier to —0.75 MHz ±0.5 dB
 Carrier 0 dB reference
 Carrier to +4.20 MHz ±0.5 dB
 +4.75 MHz and higher —30 dB or better
 ±0.75 dB.
 1% or better.
 3% or better.
 1.0 dB or better.
 ±3° or better.
 ±1° or better.
 —55 dB or better (RMS) below sync level.
 2t 2%, 12.5t less than 5% baseline disturbance.
 .05 to 2.1 MHz: ± 40 ns.
 at 3.58 MHz: ± 30 ns.
 at 4.18 MHz: ± 60 ns.
 (referenced to standard curve—FCC).
 75 ohm system.
 —80 dB.

7.2 kW at diplexer output.
 50 ohms. Output connector: 3 1/8" EIA Std.
 +10 dBm, ±2 dB.
 ±25 kHz.
 600 ohms.
 75 microseconds.
 ±0.5 dB rel. to pre-emphasis (30-15,000 Hz).
 0.5% or less after 75 microseconds de-emphasis
 with ±25 kHz deviation.
 —60 dB or better rel. to ±25 kHz dev.
 —55 dB relative to 100% modulation.
 ±250 Hz.

—10° to +50°C (14° to 122°F).
 0 to 95% relative humidity.
 Sea level to 7500 ft.
 216.72" W x 31.5" D x 72.0" H. Weight: 6,770 lbs.
 Power supplies (2) each: 36" W x 24" D x 60.4" H.
 Weight: 950 lbs.
 Output switcher: 34" W x 48" D x 72" H. Weight:
 1,350 lbs.
 Power input: 208/240 volts, ±11 volts, 3 phase,
 50/60 Hz. Power consumption (approx.): 110
 kVA, black picture, 10% aural; 93.6 kVA,
 average picture (50% APL), 10% aural; 118 kVA,
 black picture at 20% aural; 100.4 kVA, average
 picture at 20% aural.

SPECIFICATIONS SUBJECT TO CHANGE WITHOUT NOTICE.

- ¹ After initial aging of 60 days.
- ² Measured at 65% and 15% of modulation. Reference 100% = peak of sync.
- ³ Maximum variation of sub-carrier amplitude from 75% to 10% of mod. Sub-carrier mod. percentage: 10% peak to peak.
- ⁴ Maximum variation of sub-carrier phase with respect to burst for mod. percentage from 75% to 10%. Sub-carrier mod. percentage: 10% peak to peak.
- ⁵ Bridging, loop through input with —30 dB or better return loss up to 5.5 MHz.
- ⁶ After de-emphasis.
- ⁷ Relative to frequency offset by 4.5 MHz (FCC) from the visual carrier.

ORDERING INFORMATION

TVD-36H, 36 kW dual VHF-TV transmitter for FCC standards service, Channels 7-13, with operating tubes, semiconductors, crystals, VSB filter, color notch filter, harmonic filters, input and output switchers 994-8499-001



TV-25H

25-Kilowatt VHF High Band Color Television Transmitter

- Advanced Transversal SideBand (TSB) filter—requires no group delay correction, no tuning adjustments
- Solid-state exciters and IPA
- Superior color performance—minimal corrections required
- Fast turn-on time
- Automatic power control is a standard feature
- IF Modulation of the visual and aural carriers
- Solid-state control circuits
- Easily interfaced with ATS and remote control systems
- Compact design, with excellent accessibility
- Pre-wired cabinets for fast and easy installation

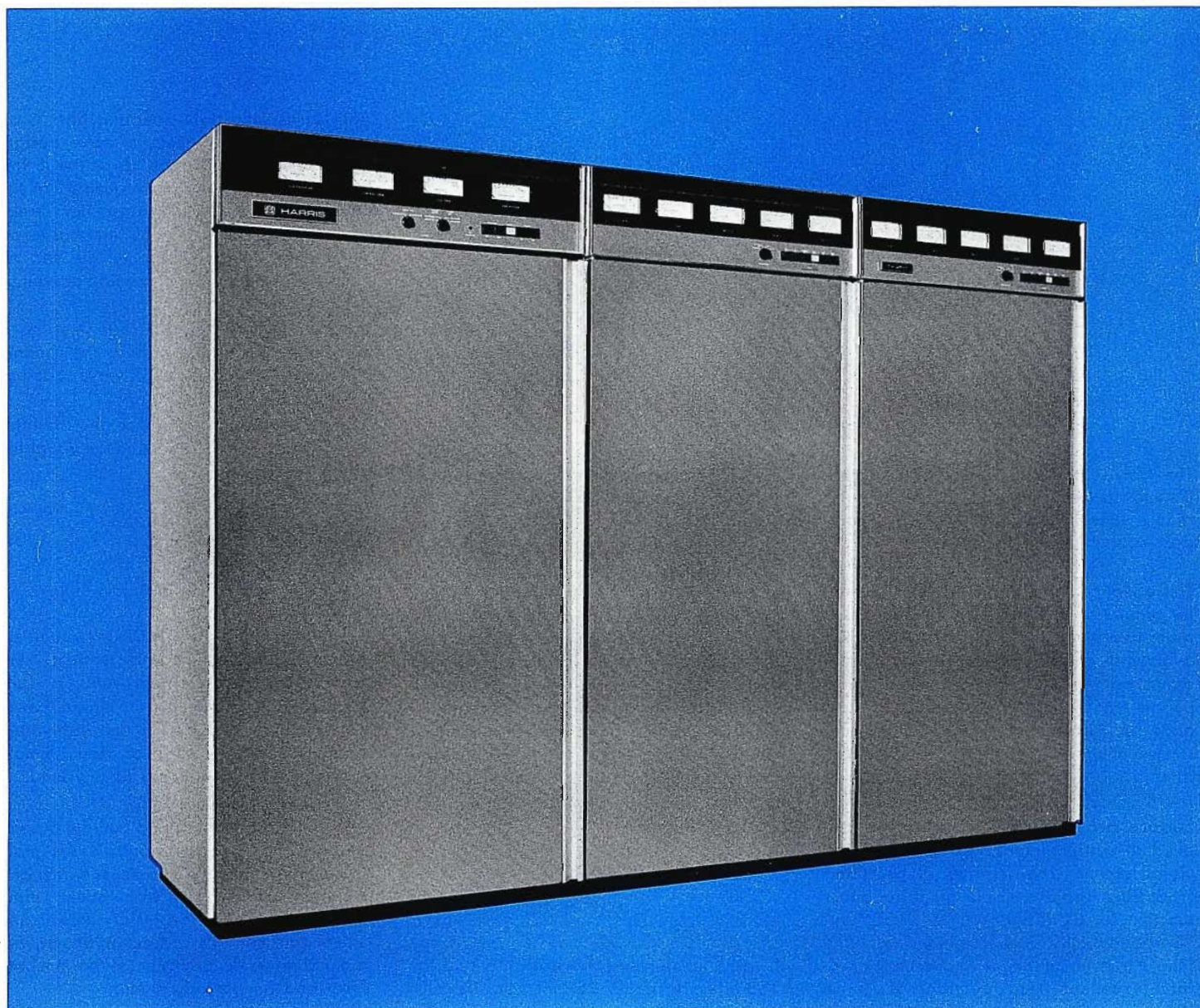

TV-25H

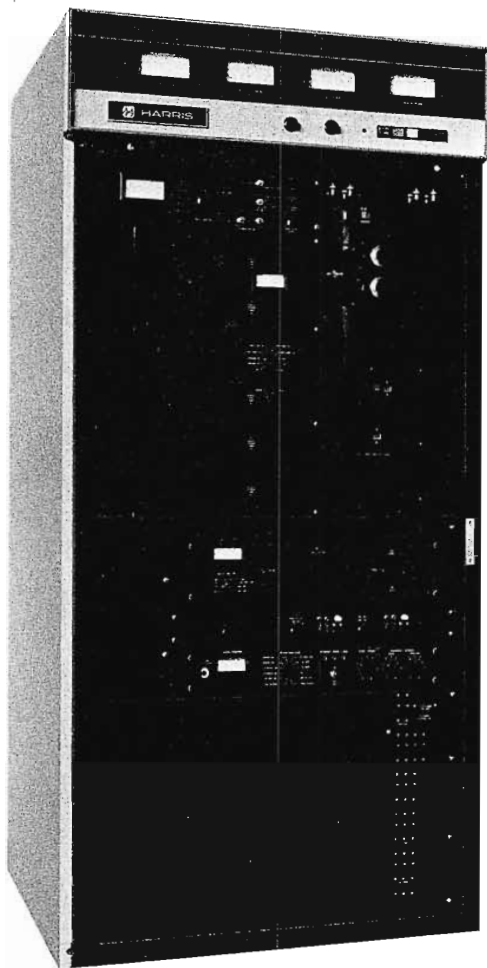

Ultra-linear driver cabinet with solid-state IPA

The Harris TV-25H features a solid-state IPA to greatly enhance reliability and reduce tuning requirements, with a compact cabinet configuration.

This advanced high-band VHF-TV transmitter requires only one aural and two visual tubes to provide a 25-kilowatt visual and a 5-kilowatt aural output. Under normal operating conditions the quick-heat tubes permit transmitter turn-on within 20 seconds. A circulator between the visual stages minimizes retuning requirements after a tube change.

Surface acoustic wave technology is applied to vestigial sideband filtering in the visual exciter. The Transversal SideBand (TSB) filter displays a near-ideal bandpass function for CCIR Systems "M" (FCC) and "B" bandwidths. This, combined with the filter's true linear phase characteristic, offers excellent reproduction of pulse

waveforms and encoded color information without adjustment.

The solid-state IPA contains broadband amplifiers, so that periodic bandpass adjustment is not required—and it is fully protected against damage caused by overloads or load variations. For added transmitter protection, RF drive is applied over a one to two second interval, which permits DC voltage stabilization before full RF drive application to power amplifiers. The IPA is fully metered for monitoring and maintenance, while excellent cooling helps maintain long transistor life.

SUPERB COLOR PERFORMANCE

In addition to the solid-state IPA and the TSB filter, Harris' TV-25H incorporates such

state-of-the-art features as IF (intermediate frequency) Modulation, true linear operation of power amplifiers, and solid-state visual and aural exciter/modulators, to provide the finest color performance and sound fidelity available today. As no envelope delay correction or adjustments are required for the sideband filter, stability, reliability and color quality are greatly enhanced. Frequency adjustment, power output control and amplifier tuning are straightforward and uncomplicated, while design simplicity and conservatively rated components assure long-term "hands-off" operation and minimum maintenance.

The transmitter employs a single-ended visual PA (8916 tetrode), and DC filaments in every stage for an excellent signal-to-noise ratio.

TRANSVERSAL SIDEBAND (TSB) FILTER

The Harris solid-state sideband filter is an advanced surface acoustic wave design, and shapes visual sidebands at the IF frequency, rather than "on frequency" at the full output power of the transmitter. Unlike previous VSB filters, the TSB filter has an inherent linear phase characteristic and requires no group delay correction or tuning.

Additionally, the TSB filter has steep skirts and high attenuation outside the channel passband for excellent VSB wave shaping.

Only 1½ square inches in size, the TSB filter is mounted on a PC board in the visual exciter.

SOLID-STATE VISUAL AND AURAL EXCITER/MODULATORS

The Harris solid-state MCP-1V visual exciter/modulator is an independent, self-contained unit which provides a fully processed on-channel picture signal. Power output can be varied up to one watt with a single front panel control, or from a remote location, without retuning of any kind.

The exciter is mounted in a pull-out drawer and may be operated outside the main transmitter for test purposes. A switch and meter mounted on the front panel permit monitoring exciter parameters. Power and video gain controls are motor driven with manual override provision to permit both local and remote adjustment.

TV-25H

The MCP-TV provides great reliability and stability, excellent frequency response, and truest color quality. It is designed for minimum maintenance and set-up time, and for remote control and unattended operation. This is all made possible through the use of the latest design techniques, including Harris' solid-state TSB filter.

The Harris aural exciter/modulator is a solid-state, self-contained unit which furnishes a fully processed aural signal at a level up to 10 watts. Power output can be set with a single knob on the front panel, or by remote control, with no need for retuning. It is mounted in a pull-out drawer, and may be operated with the drawer extended for test purposes.

INTERMEDIATE FREQUENCY (IF) MODULATION

One of the important features of the TV-25H is its true low-level IF Modulation, which offers a top quality picture, and excels in electrical performance, reliability and simplicity of operation.

In the TV-25H the visual and aural exciters generate fully modulated low-level IF signals. The output of a common crystal controlled reference oscillator is used to raise the individual IF signal to the desired "on channel" output frequency.

Due to the low-level techniques, which include the use of devices such as an extremely linear broadband diode ring modulator, low-level sideband filtering and very linear broadband amplifiers, the color signal is a faithful reproduction of the signal applied to the transmitter input.

SOLID-STATE CONTROL CIRCUITS

Solid-state memory, timing and logic circuits offer complete and foolproof control of all transmitter functions. Built-in memory circuitry enables the entire transmitter to return to the air automatically in the state it was operating prior to an AC power interruption.

The control logic, in addition to commanding normal AC control functions, is also used to visually indicate, through indicator lights, the operating status of the transmitter system. These indicator lights allow isolation of circuit faults, and are easily removed.

REMOTE CONTROL, UNATTENDED AND AUTOMATIC OPERATION

All control, metering and monitoring circuits have been designed specifically for remote control and ATS. The power controls are motor driven and the necessary remote control sampling points are built-in on accessible terminal boards. Today, Harris TV transmitters are being successfully operated worldwide with a variety of remote control systems.

AUTOMATIC POWER CONTROL

Automatic gain control of all RF amplifier stages, in conjunction with the exciters' automatic power control, insures essentially constant power output, even with variations in line voltages. This feature is standard in the TV-25H.

STABILITY

One factor assuring RF stability is the use of a solid-state IPA and conservatively rated Type 8988 and 8916 ceramic tetrodes operating as VHF linear amplifiers. These amplifier stages operate in a common grid and screen configuration and tube neutralization is not required.

EXCELLENT COOLING SYSTEM

The cooling system of the TV-25H is quiet and efficient, and employs direct drive blowers, with the motors fully protected by automatic reset devices.

POWER SUPPLIES

The HV power supply for the visual and aural PAs exhibits very low ripple content. It is designed for excellent regulation and low video impedance for optimum picture performance. In addition, for ease of maintenance, this power supply, including transformer and solid-state rectifiers, is housed in a single assembly, mounted externally from the transmitter. Routine maintenance access is provided by a removable panel.

Vacuum tube filaments in the visual and aural transmitters are operated from DC power supplies to maximize the output signal-to-noise ratio. Grid and screen supplies are 100% solid state.

The visual and aural exciters have their own independent, solid-state regulated power supplies.

EASE OF MAINTENANCE

Convenient access to components is provided, permitting the transmitter to be easily maintained. Visual and aural exciters slide out and can operate independently from the transmitter outside the cabinet. Various exciter circuits, such as oscillators, modulators and processing circuitry, are of modular construction and can be removed for maintenance or replacement.

Easy-to-read, eye-level 4-inch meters are used to monitor required transmitter functions. Meter panels are of double-hinged construction for easy access during maintenance.

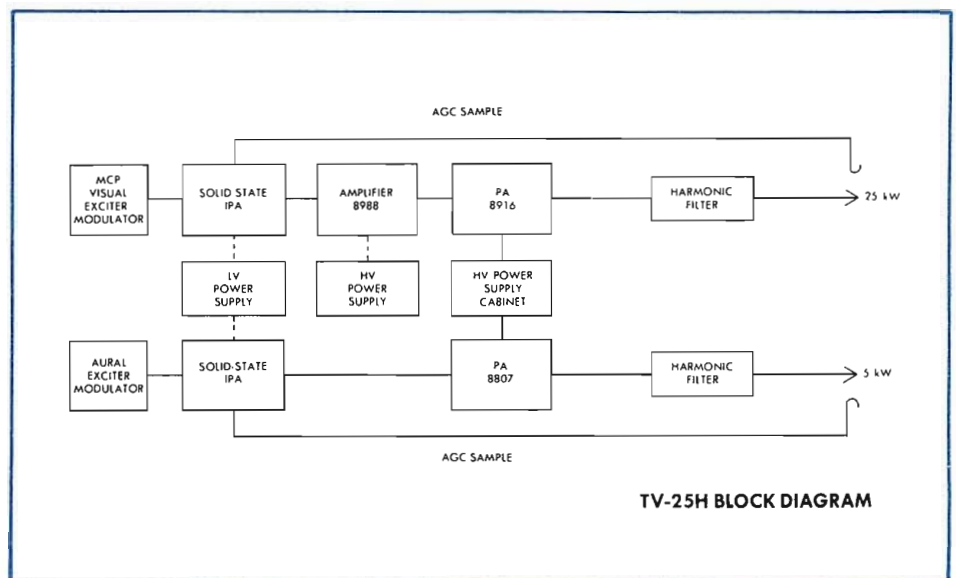

TV-25H BLOCK DIAGRAM

TV-25H SPECIFICATIONS

VISUAL PERFORMANCE

POWER OUTPUT:
OUTPUT IMPEDANCE:
FREQUENCY RANGE:
CARRIER STABILITY:¹
REG. OF RF OUTPUT POWER (Black to white pic.):
VARIATION OF OUTPUT (over one frame):
VISUAL SIDEBAND RESPONSE:

FCC (System "M")
 25 kW peak.
 50 ohms. Output connectors: 3/8" EIA standard.
 174-216 MHz (Channels 7-13).
 ±250 Hz (maximum variation over 30 days).
 3% or less.
 Less than 2%.
 —3.58 MHz —42 dB or better
 —1.25 MHz and lower —26 dB or better
 Carrier to —0.75 MHz ±0.5 dB
 Carrier 0 dB reference
 Carrier to +4.20 MHz ±0.5 dB
 +4.75 MHz and higher —30 dB or better

CCIR (System "B")

21 kW peak.
 50 ohms. Output connector: 3/8" EIA standard.
 174-230 MHz (Band III).
 ±250 Hz (Maximum variation over 30 days).
 3% or less.
 Less than 2%.
 —4.43 MHz —30 dB or better
 —1.25 MHz —26 dB or better
 —0.75 MHz +0.5, —3 dB
 —0.50 MHz +0.5, —1 dB
 Carrier +0.5, —0.5 dB
 +1.5 MHz Reference
 +3.0 MHz ±0.5 dB
 +4.43 MHz +0.5, —1 dB
 +5.0 MHz +0.5, —2.5 dB
 +5.5 MHz —26 dB or better
 ±0.75 dB.
 1% or better.
 3% or better.
 ±3° or better.
 Amplitude dev. ⁵min/⁵ max better than 0.85 mod.
 with signal No. 3 CCIR, from 10% to 85% in
 frequency range 1 to 5 MHz.
 ±1° or better.
 —40 dB below black to white transition.
 2± 2%, 20± 3% or better.
 up to 4.5 MHz: ±50 ns.
 from 4.5 MHz to 4.8 MHz: ±100 ns.
 (measured with Nyquist demodulator meeting ARD
 specifications.)
 75 ohm system.
 —80 dB.
 —40 dB or better with ref. to ±50 kHz dev.
 ±75 ns —10% ±200 ns +7%
 ±100 ns + 11% ±400-1000 ns ±5%
 400-1000 ns ±3% for LF variation.

FREQUENCY RESPONSE VS. BRIGHTNESS:²
VISUAL MODULATION CAPABILITY:
DIFFERENTIAL GAIN:³
INCIDENTAL PHASE MODULATION:
LINEARITY (LOW FREQUENCY):

±0.75 dB.
 1% or better.
 3% or better.
 ±3° or better.
 1.0 dB or better.

DIFFERENTIAL PHASE:⁴
SIGNAL-TO-NOISE RATIO:
K-FACTORS:
EQUIVALENT ENVELOPE DELAY:

±1° or better.
 —55 dB or better (RMS) below sync level.
 2± 2%, 12.5± less than 5% baseline disturbance.
 .05 to 2.1 MHz: ± 40 ns.
 at 3.58 MHz: ± 30 ns.
 at 4.18 MHz: ± 60 ns.
 (referenced to standard curve—FCC).
 75 ohm system.
 —80 dB.
 (Not applicable).
 (Not applicable).

VIDEO INPUT:⁵
HARMONIC RADIATION:
INTERCARRIER PHASE MODULATION (noise):
HIGH FREQUENCY TRANSIENT RESPONSE,
 15 kHz and 250 kHz:

AURAL PERFORMANCE

POWER OUTPUT:
OUTPUT IMPEDANCE:
AUDIO INPUT:
FREQUENCY DEVIATION:
INPUT IMPEDANCE:
PRE-EMPHASIS:
FREQUENCY RESPONSE:
DISTORTION:

5 kW at diplexer output.
 50 ohms. Output connector: 3/8" EIA Std.
 +10 dBm, ±2 dB.
 ±25 kHz.
 600 ohms.
 75 microseconds.
 ±0.5 dB rel. to pre-emphasis (30-15,000 Hz).
 0.5% or less after 75 microseconds de-emphasis
 with ±25 kHz deviation.

Up to 5 kW at diplexer output.
 50 ohms. Output connector: 3/8" EIA Std.
 +10 dBm, ±2 dB.
 ±50 kHz.
 600 ohms.
 50 microseconds ±5 microseconds.
 ±0.5 dB rel. to pre-emphasis (30-15,000 Hz).
 Less than 1% from 30 to 15,000 Hz with ±50 kHz
 dev. (Less than twice measured amount at 70 kHz
 deviation).
 —60 dB or better rel. to ±50 kHz dev.
 —55 dB relative to 100% modulation.
 —40 dB or better.
 ±250 Hz.

FM NOISE:
AM NOISE:⁶
SYNCHRONOUS AM NOISE:⁷
FREQUENCY STABILITY:⁸

—60 dB or better rel. to ±25 kHz dev.
 —55 dB relative to 100% modulation.
 (Not applicable).
 ±250 Hz.

SERVICE CONDITIONS

AMBIENT TEMPERATURE:
AMBIENT HUMIDITY RANGE:
ALTITUDE:
PHYSICAL AND MECHANICAL DIMENSIONS:

—10° to +50°C (14° to 122°F).
 0 to 95% relative humidity.
 Sea level to 7500 ft.
 97.3" W x 31.5" D x 72" H. Weight: 3235 lbs. Power
 supply: 36" W x 24" D x 60.4" H. Weight: 950 lbs.

—10° to +50°C.
 0 to 95% relative humidity.
 Sea level to 2286 meters.
 247.1 cm W x 80 cm D x 183 cm H. Weight 1,470 Kg.
 Power supply: 91.5 cm W x 61 cm D x 153.4 cm H.
 Weight: 432 Kg.
 Power input: 380/415 volts, 3 phase, 50/60 Hz. Power
 consumption (approx.): 58 kVA, black picture,
 10% aural; 49 kVA, average picture (50% APL),
 10% aural; 62 kVA, black picture at 20% aural;
 53 kVA, average picture at 20% aural.

ELECTRICAL REQUIREMENTS:

Power input: 208/240 volts, ±11 volts, 3 phase,
 50/60 Hz. Power consumption (approx.): 58 kVA,
 black picture, 10% aural; 49 kVA, average pic-
 ture (50% APL), 10% aural; 62 kVA, black pic-
 ture at 20% aural; 53 kVA, average picture at
 20% aural.

SPECIFICATIONS SUBJECT TO CHANGE WITHOUT NOTICE.

- ¹ After initial aging of 60 days.
- ² Measured at 65% and 15% of modulation. Reference 100%=peak of sync.
- ³ Maximum variation of sub-carrier amplitude from 75% to 10% of mod. Sub-carrier mod. percentage: 10% peak to peak.
- ⁴ Maximum variation of sub-carrier phase with respect to burst for mod. percentage from 75% to 10%. Sub-carrier mod. percentage: 10% peak to peak.
- ⁵ Bridging, loop through input with —30 dB or better return loss up to 5.5 MHz.
- ⁶ After de-emphasis.
- ⁷ Rel. to 100% AM modulation at ±50 kHz deviation.
- ⁸ Relative to frequency offset by 4.5 MHz (FCC), 5.5 MHz (CCIR) from the visual carrier.

ORDERING INFORMATION

TV-25H, 25 kW VHF-TV transmitter for FCC standards service, Channels 7-13, with operating tubes, transistors, ICs, solid-state rectifiers, crystals, required pre-correction circuitry, low-level vestigial sideband filter, harmonic and color notch filters 994-8405-001

TV-25H 21 kW VHF-TV transmitter for CCIR System "B" service, 174-230 MHz (Band III), 380/415 volts, 50/60 Hz, equipped as above 994-8405-003



HARRIS
COMMUNICATION AND
INFORMATION PROCESSING

TV-18H

18-Kilowatt VHF High Band Color Television Transmitter

- Advanced Transversal SideBand (TSB) filter—requires no group delay correction, no tuning adjustments
- Solid-state exciters and IPA for enhanced reliability
- Superior color performance—minimal corrections required
- Fast turn-on time
- Automatic power control is a standard feature
- IF Modulation of the visual and aural carriers
- Solid-state control circuits
- Easily interfaced with ATS and remote control systems
- Compact design, with excellent accessibility
- Pre-wired cabinets for fast and easy installation

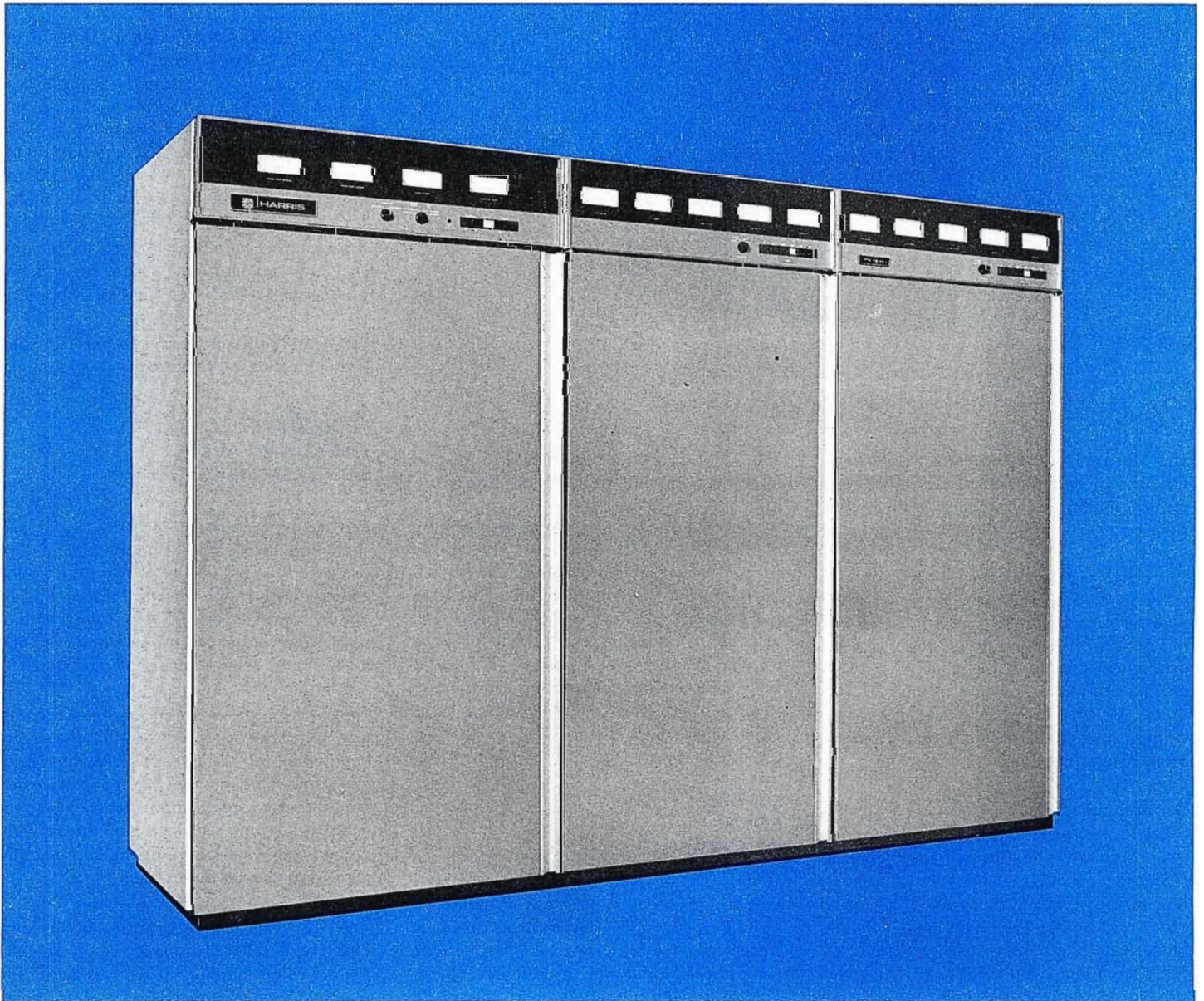

TV-18H

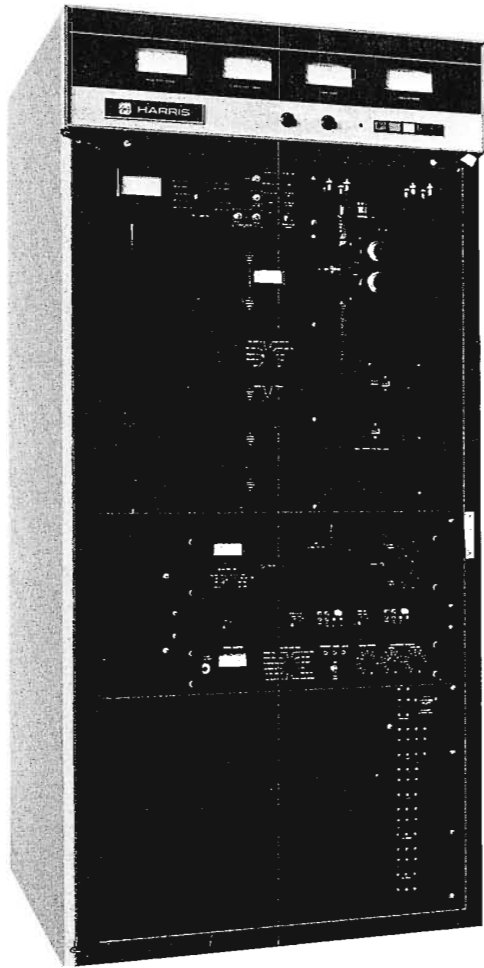

Ultra-linear driver cabinet with solid-state IPA

The Harris TV-18H features a solid-state IPA to greatly enhance reliability and reduce tuning requirements, with a compact cabinet configuration.

This advanced high-band VHF-TV transmitter requires only one aural and two visual tubes to provide an 18-kilowatt visual and a 3.6-kilowatt aural output. Under normal operating conditions, the quick-heat tubes permit transmitter turn-on within 20 seconds. A circulator between the visual stages minimizes retuning requirements after a tube change.

Surface acoustic wave technology is applied to vestigial sideband filtering in the visual exciter. The Transversal SideBand (TSB) filter displays a near-ideal bandpass function for CCIR Systems "M" (FCC) and "B" bandwidths. This, combined with the filter's true linear phase characteristic, offers excellent reproduction of pulse waveforms and encoded color information without adjustment.

The solid-state IPA contains broadband amplifiers, so that periodic bandpass adjustment is not required—and it is fully protected against damage caused by overloads or load variations. For added transmitter protection at turn on, RF drive is brought up to operating level over a one to two second interval, which permits DC voltage stabilization before full RF drive application to power amplifiers. The IPA is fully metered for monitoring and maintenance, while excellent cooling helps maintain long transistor life.

SUPERB COLOR PERFORMANCE

In addition to the solid-state IPA and the TSB filter, Harris' TV-18H incorporates such state-of-the-art features as IF (intermediate frequency) Modulation, true linear operation of power amplifiers, and solid-state visual and aural exciter/modulators, to

provide the finest color performance and sound fidelity available today. As no envelope delay correction or adjustments are required for the sideband filter, stability, reliability and color quality are greatly enhanced. Frequency adjustment, power output control and amplifier tuning are straightforward and uncomplicated, while design simplicity and conservatively rated components assure long-term "hands-off" operation and minimum maintenance.

The transmitter employs a single-ended visual PA (8916 tetrode), and DC filaments in every stage for an excellent signal-to-noise ratio.

TRANSVERSAL SIDEBAND (TSB) FILTER

The Harris solid-state sideband filter is an advanced surface acoustic wave design, and shapes visual sidebands at the IF frequency, rather than "on frequency" at the full output power of the transmitter. Unlike previous VSB filters, the TSB filter has an inherent linear phase characteristic and requires no group delay correction or tuning.

Additionally, the TSB filter has steep skirts and high attenuation outside the channel passband for excellent VSB wave shaping.

Only 1½ square inches in size, the TSB filter is mounted on a PC board in the visual exciter.

SOLID-STATE VISUAL AND AURAL EXCITER/MODULATORS

The Harris solid-state MCP-1V visual exciter/modulator is an independent, self-contained unit which provides a fully processed on-channel picture signal. Power output can be varied up to one watt with a single front panel control, or from a remote location, without retuning of any kind.

The exciter is mounted in a pull-out drawer and may be operated outside the main transmitter for test purposes. A switch and meter mounted on the front panel permit monitoring exciter parameters. Power and video gain controls are motor driven with manual override provision to permit both local and remote adjustment.

The MCP-1V provides great reliability and stability, excellent frequency response, and truest color quality. It is designed for minimum maintenance and set-up time, and for remote control and unattended

TV-18H

operation. This is all made possible through the use of the latest design techniques, including Harris' solid-state TSB filter.

The Harris aural exciter/modulator is a solid-state, self-contained unit which furnishes a fully processed aural signal at a level up to 10 watts. Power output can be set with a single knob on the front panel, or by remote control, with no need for retuning. It is mounted in a pull-out drawer, and may be operated with the drawer extended for test purposes.

INTERMEDIATE FREQUENCY (IF) MODULATION

One of the important features of the TV-18H is its true low-level IF Modulation, which offers a top quality picture, and excels in electrical performance, reliability and simplicity of operation.

In the TV-18H the visual and aural exciters generate fully modulated low-level IF signals. The output of a common crystal controlled reference oscillator is used to raise the individual IF signal to the desired "on channel" output frequency.

Due to the low-level techniques, which include the use of devices such as an extremely linear broadband diode ring modulator, low-level sideband filtering and very linear broadband amplifiers, the color signal is a faithful reproduction of the signal applied to the transmitter input.

SOLID-STATE CONTROL CIRCUITS

Solid-state memory, timing and logic circuits offer complete and foolproof control of all transmitter functions. Built-in memory circuitry enables the entire transmitter to return to the air automatically in the state it was operating prior to an AC power interruption.

The control logic, in addition to commanding normal AC control functions, is also used to visually indicate, through indicator lights, the operating status of the transmitter system. These indicator lights allow isolation of circuit faults, and are easily removed.

REMOTE CONTROL, UNATTENDED AND AUTOMATIC OPERATION

All control, metering and monitoring circuits have been designed specifically for remote control and ATS. The power con-

trols are motor driven and the necessary remote control sampling points are built-in on accessible terminal boards. Today, Harris TV transmitters are being successfully operated worldwide with a variety of remote control systems.

AUTOMATIC POWER CONTROL

Automatic gain control of all RF amplifier stages, in conjunction with the exciters' automatic power control, insures essentially constant power output, even with variations in line voltages. This feature is standard in the TV-18H.

STABILITY

One factor assuring RF stability is the use of a solid-state IPA and conservatively rated Type 8988, 8807 and 8916 ceramic tetrodes operating as VHF linear amplifiers. These amplifier stages operate in a common grid and screen configuration and tube neutralization is not required.

EXCELLENT COOLING SYSTEM

The cooling system of the TV-18H is quiet and efficient, and employs direct drive blowers, with the motors fully protected by automatic reset devices.

POWER SUPPLIES

The HV power supply for the visual and

aural PAs exhibits very low ripple content. It is designed for excellent regulation and low video impedance for optimum picture performance. In addition, for ease of maintenance, this power supply, including transformer and solid-state rectifiers, is housed in a single assembly, mounted externally from the transmitter. Routine maintenance access is provided by a removable panel.

Vacuum tube filaments in the visual and aural transmitters are operated from DC power supplies to maximize the output signal-to-noise ratio. Grid and screen supplies are 100% solid state.

The visual and aural exciters have their own independent, solid-state regulated power supplies.

EASE OF MAINTENANCE

Convenient access to components is provided, permitting the transmitter to be easily maintained. Visual and aural exciters slide out and can operate independently from the transmitter outside the cabinet. Various exciter circuits, such as oscillators, modulators and processing circuitry, are of modular construction and can be removed for maintenance or replacement.

Easy-to-read, eye-level 4-inch meters are used to monitor required transmitter functions. Meter panels are of double-hinged construction for easy access during maintenance.

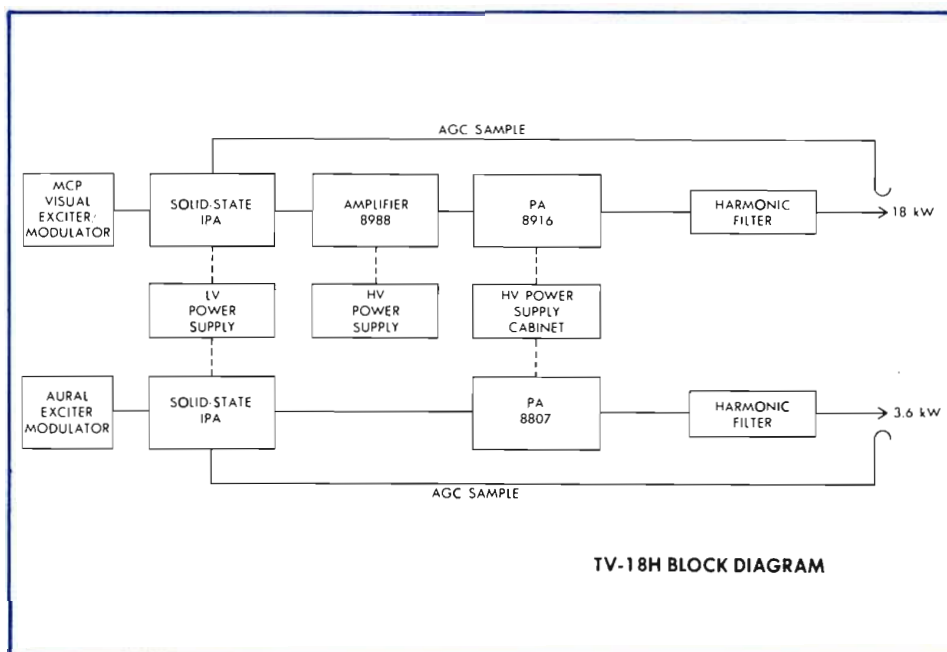

TV-18H SPECIFICATIONS

VISUAL PERFORMANCE

POWER OUTPUT:
OUTPUT IMPEDANCE:
FREQUENCY RANGE:
CARRIER STABILITY:¹
REG. OF RF OUTPUT POWER (Black to white pic.):
VARIATION OF OUTPUT (over one frame):
VISUAL SIDEBAND RESPONSE:

FCC (System "M")

18 kW peak.
 50 ohms. Output connector: 3/8" EIA standard.
 174-216 MHz (Channels 7-13).
 ±250 Hz (maximum variation over 30 days).
 3% or less.
 Less than 2%.
 —3.58 MHz —42 dB or better
 —1.25 MHz and lower —26 dB or better
 Carrier to —0.75 MHz ±0.5 dB
 Carrier 0 dB reference
 Carrier to +4.20 MHz ±0.5 dB
 +4.75 MHz and higher —30 dB or better

CCIR (System "B")

18 kW peak.
 50 ohms. Output connector: 3/8" EIA standard.
 174-230 MHz (Band III).
 ±250 Hz (maximum variation over 30 days).
 3% or less.
 Less than 2%.
 —4.43 MHz —30 dB or better
 —1.25 MHz —26 dB or better
 —0.75 MHz +0.5, —3 dB
 —0.50 MHz +0.5, —1 dB
 Carrier +0.5, —0.5 dB
 +1.5 MHz Reference
 +3.0 MHz ±0.5 dB
 +4.43 MHz +0.5, —1 dB
 +5.0 MHz +0.5, —2.5 dB
 +5.5 MHz —26 dB or better
 ±0.75 dB.
 1% or better.
 3% or better.
 ±3°

FREQUENCY RESPONSE VS. BRIGHTNESS:²
VISUAL MODULATION CAPABILITY:
DIFFERENTIAL GAIN:³
INCIDENTAL PHASE MODULATION:
LINEARITY (LOW FREQUENCY):

±0.75 dB.
 1% or better.
 3% or better.
 ±3° or better.
 1.0 dB or better.

DIFFERENTIAL PHASE:⁴
SIGNAL-TO-NOISE RATIO:
K-FACTORS:
EQUIVALENT ENVELOPE DELAY:

±1° or better.
 —55 dB or better (RMS) below sync level.
 2t 2%, 12.5t less than 5% baseline disturbance.
 .05 to 2.1 MHz: ± 40 ns.
 at 3.58 MHz: ± 30 ns.
 at 4.18 MHz: ± 60 ns.
 (referenced to standard curve—FCC).
 75 ohm system.
 —80 dB.
 (Not applicable).
 (Not applicable).

Amplitude dev. ⁵min/⁵ max better than 0.85 mod.
 with signal No. 3 CCIR, from 10% to 85% in
 frequency range 1 to 5 MHz.
 ±1° or better.
 —50 dB or better (RMS) below sync level.
 2t 2%, 20t 3% or better.
 up to 4.5 MHz: ±50 ns.
 from 4.5 MHz to 4.8 MHz: ±100 ns.
 (measured with Nyquist demodulator meeting ARD
 specifications.)
 75 ohm system.
 —80 dB.
 —40 dB or better with ref. to ±50 kHz dev.
 ±75 ns —10% ±200 ns +7%
 ±100 ns +11% ±400-1000 ns ±5%
 400-1000 ns ±3% for LF variation.

VIDEO INPUT:⁵
HARMONIC RADIATION:
INTERCARRIER PHASE MODULATION (noise):
HIGH FREQUENCY TRANSIENT RESPONSE,
 15 kHz and 250 kHz:

75 ohm system.
 —80 dB.
 (Not applicable).
 (Not applicable).

AURAL PERFORMANCE

POWER OUTPUT:
OUTPUT IMPEDANCE:
AUDIO INPUT:
FREQUENCY DEVIATION:
INPUT IMPEDANCE:
PRE-EMPHASIS:
FREQUENCY RESPONSE:
DISTORTION:

3.6 kW at diplexer output.
 50 ohms. Output connector: 3/8" EIA Std.
 +10 dBm, ±2 dB.
 ±25 kHz.
 600 ohms.
 75 microseconds.
 ±0.5 dB rel. to pre-emphasis (30-15,000 Hz).
 0.5% or less after 75 microseconds de-emphasis
 with ±25 kHz deviation.

Up to 3.6 kW at diplexer output.
 50 ohms. Output connector: 3/8" EIA Std.
 +10 dBm, ±2 dB.
 ±50 kHz.
 600 ohms.
 50 microseconds ±5 microseconds.
 ±0.5 dB rel. to pre-emphasis (30-15,000 Hz).
 Less than 1% from 30 to 15,000 Hz with ±50 kHz
 dev. (Less than twice measured amount at 70 kHz
 deviation).
 —60 dB or better rel. to ±50 kHz dev.
 —55 dB relative to 100% modulation.
 —40 dB or better.
 ±250 Hz.

FM NOISE:
AM NOISE:⁶
SYNCHRONOUS AM NOISE:⁷
FREQUENCY STABILITY:⁸

—60 dB or better rel. to ±25 kHz dev.
 —55 dB relative to 100% modulation.
 (Not applicable).
 ±250 Hz.

SERVICE CONDITIONS

AMBIENT TEMPERATURE:
AMBIENT HUMIDITY RANGE:
ALTITUDE:
PHYSICAL AND MECHANICAL DIMENSIONS:

—10° to +50°C (14° to 122°F).
 0 to 95% relative humidity.
 Sea level to 7500 ft.
 97.3" W x 31.5" D x 72" H. Weight: 3235 lbs. Power
 supply: 36" W x 24" D x 60.4" H. Weight: 950 lbs.

—10° to +50°C.
 0 to 95% relative humidity.
 Sea level to 2286 meters.
 247.1 cm W x 80 cm D x 183 cm H. Weight 1,470 Kg.
 Power supply: 91.5 cm W x 61 cm D x 153.4 cm H.
 Weight: 432 Kg.

ELECTRICAL REQUIREMENTS:

SPECIFICATIONS SUBJECT TO CHANGE WITHOUT NOTICE.

Power input: 208/240 volts, ±11 volts, 3 phase,
 50/60 Hz. Power consumption (approx.): 55 kVA,
 black picture, 10% aural; 46.8 kVA, average picture
 (50% APL), 10% aural; 59 kVA, black picture
 at 20% aural; 50.2 kVA, average picture at
 20% aural.

Power input: 380/415 volts, 3 phase, 50/60 Hz. Power
 consumption (approx.): 63.8 kVA, black picture,
 10% aural; 54.3 kVA, average picture (50%
 APL), 10% aural; 68.4 kVA, black picture at 20%
 aural; 58.2 kVA, average picture at 20% aural.

¹ After initial aging of 60 days.

² Measured at 65% and 15% of modulation. Reference 100% = peak of sync.

³ Maximum variation of sub-carrier amplitude from 75% to 10% of mod. Sub-carrier mod. percentage: 10% peak to peak.

⁴ Maximum variation of sub-carrier phase with respect to burst for mod. percentage from 75% to 10%. Sub-carrier mod. percentage: 10% peak to peak.

⁵ Bridging, loop through input with —30 dB or better return loss up to 5.5 MHz.

⁶ After de-emphasis.

⁷ Rel. to 100% AM modulation of ±50 kHz deviation.

⁸ Relative to frequency offset by 4.5 MHz (FCC), 5.5 (CCIR) from the visual carrier.

ORDERING INFORMATION

TV-18H, 18 kW VHF-TV transmitter for FCC standards service, Channels 7-13, with operating tubes, transistors, ICs, solid-state rectifiers, crystals, required pre-correction circuitry, low-level vestigial sideband filter, harmonic and color notch filters 994-8497-001
 TV-18H 18 kW VHF-TV transmitter for CCIR System "B" service, 174-230 MHz (Band III), 380/415 volts, 50/60 Hz, equipped as above 994-8497-003



HARRIS
COMMUNICATION AND
INFORMATION PROCESSING

TV-10H 10-Kilowatt CCIR Band III Color Television Transmitter

The Harris TV-10H, ten-kilowatt CCIR Band III color TV transmitter, is designed specifically for use in CCIR Systems "B" and "M"—with many features of particular interest to international broadcasters.

The solid-state IPA/three-tube design greatly enhances reliability, reduces tuning requirements and allows an unusually compact cabinet configuration. With its reduced floor space requirements, and full front access to all normally serviced components, the TV-10H is ideal for installation in small quarters, such as a TV transmitter shelter.

Surface acoustic wave technology is applied to vestigial sideband filtering in the visual exciter, so that the Transversal SideBand (TSB) filter displays a near-ideal bandpass function for CCIR Systems "B" and "M" bandwidths. This, combined with the filter's true linear phase characteristic, offers excellent pulse and color transmissions without adjustment.

The solid-state IPA contains broadband amplifiers, so no tuning is

required—and it is fully protected against damage caused by overloads or load variations. Gradual (1 to 2 seconds) RF turn-on permits DC voltage stabilization before RF drive application to power amplifiers, for added transmitter protection. The IPA is fully metered for monitoring and maintenance, while excellent cooling helps maintain long transistor life.

SUPERB PERFORMANCE

In addition to the solid-state IPA and the TSB filter, Harris' TV-10H incorporates such state-of-the-art features as IF (intermediate frequency) Modulation, true linear operation of power amplifiers, and solid-state visual and aural exciter/modulators, to provide the finest color performance and sound fidelity available today. As no envelope delay correction or adjustments are required for the sideband filter, stability, reliability and color quality are greatly enhanced. Frequency adjustment, power output control and amplifier tuning are straightforward and uncomplicated, while design simplicity and conservatively rated components assure long-term "hands-off" operation and minimum maintenance.

The transmitter employs a single-ended visual PA (8807 tetrode) for low power consumption, and DC filaments in the visual stage for improved signal-to-noise ratio.

TRANSVERSAL SIDEBAND (TSB) FILTER

The Harris solid-state sideband filter is an advanced surface acoustic wave design, and shapes visual sidebands at the IF frequency, rather than "on frequency" at the full output power of the transmitter. Unlike previous VSB filters, which require from 600 to 1000 nsec of group delay correction, and many adjustments, the TSB filter has an inherent linear phase characteristic and requires no group delay correction. Other VSB filters need 6 to 12 tuning controls, while the Harris TSB filter needs no tuning controls, as it requires no tuning adjustments—ever!

Additionally, the TSB filter has steeper skirts and higher attenuation outside the channel passband for improved VSB wave shaping.

Only 1½ square inches in size, the TSB filter is mounted on a PC board in the visual exciter.

SOLID-STATE VISUAL AND AURAL EXCITER/MODULATORS

The Harris solid-state MCP-1V visual ex-



citer/modulator is an independent, self-contained unit which provides a fully processed on-channel picture signal. Power output can be varied up to one watt with a single front panel control, or from a remote location, without retuning of any kind.

The exciter is mounted in a pull-out drawer and may be operated outside the main transmitter for test purposes. A switch and meter mounted on the front panel permit monitoring exciter parameters. Power and video gain controls are motor driven with manual override provision.

The MCP-1V provides great reliability and stability, excellent frequency response, and truest color quality. It is also designed for minimum maintenance and set-up time, and for remote control and unattended operation. This is all made possible through the use of the latest design techniques, including Harris' solid-state TSB filter.

The Harris aural exciter/modulator is a solid-state self-contained unit which furnishes a fully processed aural signal at a level up to 10 watts. Power output can be set with a single knob on the front panel, or by remote control, with no need for retuning. It is mounted in a pull-out drawer, and may be operated with the drawer extended for test purposes.

INTERMEDIATE FREQUENCY (IF) MODULATION

One of the features of the TV-10H is its true low-level IF Modulation, which offers a top quality picture, and excels in electrical performance, reliability and simplicity of operation.

In the TV-10H the visual and aural exciters generate fully modulated low-level IF signals. The output of a common crystal controlled reference oscillator is used to raise the individual IF signal to the desired "on channel" output frequency.

Due to the low-level techniques, which include the use of devices such as an extremely linear broadband diode ring modulator, low-level sideband filtering and very linear broadband amplifiers, the broadcast signal is a faithful reproduction of the signal applied to the transmitter input.

SOLID-STATE CONTROL CIRCUITS

Solid-state memory, timing and logic circuits—employing CMOS IC's for design simplicity and enhanced reliability—offer complete and foolproof control of all transmitter functions. Built-in memory circuitry enables the entire transmitter to return to the air automatically in the stage it was operating prior to a partial or full power failure. The memory is continuous, and is

maintained without an emergency power source during power failures.

The control logic and protective circuitry, in addition to commanding normal AC control functions, is also used to visually indicate, through indicator lights, the operating status of the transmitter system. These indicator lights allow isolation of circuit faults, and are easily removed.

REMOTE CONTROL, UNATTENDED AND AUTOMATIC OPERATION

All control, metering and monitoring circuits have been designed specifically for remote control and unattended operation. The power controls are motor driven and the necessary remote control sampling points are built-in on accessible terminal boards.

Today, Harris TV transmitters are being operated successfully worldwide in an unattended mode, with and without remote control access. In addition, Harris' transmitter design is consistent with anticipated automatic transmitter needs in the future.

AUTOMATIC POWER CONTROL

Automatic gain control of all RF amplifier stages, in conjunction with the exciters' automatic power control, insures essentially constant power output, even with variations in line voltages. This feature is standard in the TV-10H.

STABILITY

One factor assuring RF stability is the use of a solid-state IPA and conservatively rated Type 8988 and 8807 ceramic tetrodes operating as VHF linear amplifiers. These amplifier stages operate in a common grid and screen configuration and tube neutralization is not required.

EXCELLENT COOLING SYSTEM

The cooling system of the TV-10H is quiet and efficient, and employs a direct drive blower, with the motor fully protected by automatic reset devices. Tube manufacturers' recommendations are met or exceeded at altitudes up to 3000 meters, enhancing tube life without power derating.

POWER SUPPLIES

The HV power supply is a 3-phase choke input supply, exhibiting very low ripple content. It is designed for excellent regulation and low video impedance for optimum picture performance. This power supply, including transformer and solid-state rectifiers, is housed in a single assembly, mounted externally from the transmitter. Routine maintenance access is provided by a removable panel.

Vacuum tube filaments in the visual transmitter are operated from DC power supplies to maximize the output signal-to-noise ratio. Grid and screen supplies use solid-state regulators.

The visual and aural exciters have their own independent, solid-state regulated power supplies.

EASE OF MAINTENANCE

Total front access to components is provided, permitting the transmitter to be installed against a wall. Visual and aural exciters slide out and can operate independently from the transmitter outside the cabinet. Various exciter circuits, such as oscillators, modulators and processing circuitry, are of modular construction and can be removed for maintenance or replacement.

Easy-to-read, eye-level 4-inch meters are used to monitor required transmitter functions. Meter panels are of double-hinged construction for convenient access during maintenance.

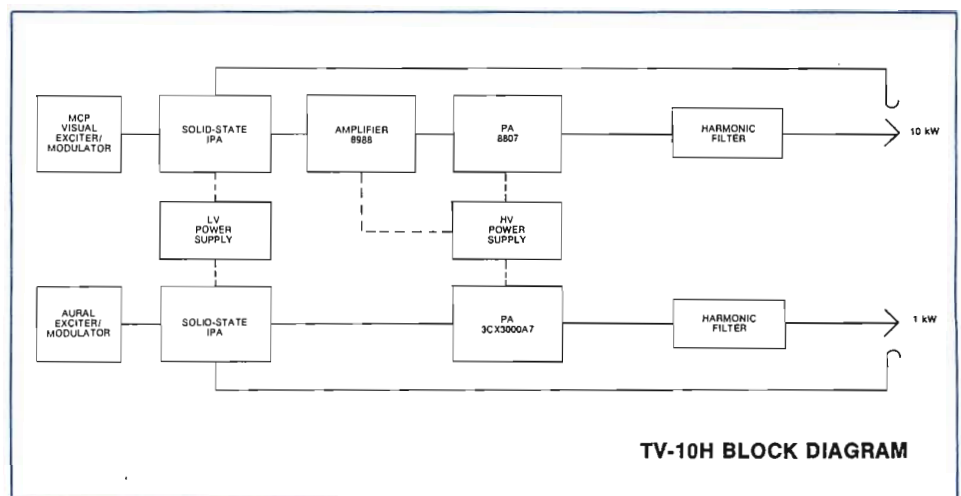

TV-10H SPECIFICATIONS

CCIR System M, 525 Lines, 60 Hz (FCC Type)

VISUAL PERFORMANCE

POWER OUTPUT:	13 kW peak.
OUTPUT IMPEDANCE:	50 ohms. Output connector: 3/8" EIA standard. (FCC Channels 7-13).
FREQUENCY RANGE:	174-216 MHz.
CARRIER STABILITY:¹	±250 Hz (maximum variation over 30 days).
REG. OF RF OUTPUT POWER (Black to white pic.):	3% or less.
VARIATION OF OUTPUT (over one frame):	Less than 2%.
VISUAL SIDEBAND RESPONSE:	-3.58 MHz..... -42 dB or better -1.25 MHz and lower..... -26 dB or better Carrier to -0.75 MHz..... ±0.5 dB Carrier..... 0 dB reference Carrier to +4.20 MHz..... ±0.5 dB +4.75 MHz and higher..... -30 dB or better ±0.75 dB.
FREQUENCY RESPONSE VS. BRIGHTNESS:²	0%.
VISUAL MODULATION CAPABILITY:	3% or better.
DIFFERENTIAL GAIN:³	10% or better.
LINEARITY (LOW FREQUENCY):	±1° or better.
DIFFERENTIAL PHASE:⁴	±55 dB or better (RMS) below sync level.
SIGNAL-TO-NOISE RATIO:	2% maximum.
21 K FACTOR:	5% Total Baseline disturbance.
12.5μs GAIN & DELAY RESPONSE:	.05 to 2.1 MHz: ±40 ns at 3.58 MHz: ±30 ns at 4.18 MHz: ±60 ns
EQUIVALENT ENVELOPE DELAY:	(referenced to standard curve—FCC) 75 ohm system.
VIDEO INPUT:⁵	-80 dB.
HARMONIC RADIATION:	±3° or less relative to blanking.
INCIDENTAL PHASE MODULATION:	

AURAL PERFORMANCE

POWER OUTPUT:	1.3 kW at diplexer output.
OUTPUT IMPEDANCE:	50 ohms. Output connector: 3/8" EIA Std.
AUDIO INPUT:	+10 dBm, ±2 dB.
FREQUENCY DEVIATION:	±25 kHz.
INPUT IMPEDANCE:	600 ohms.
PRE-EMPHASIS:	75 microseconds.
FREQUENCY RESPONSE:	±0.5 dB rel. to pre-emphasis (30-15,000 Hz).
DISTORTION:	0.5% or less after 75 microseconds de-emphasis with ±25 kHz deviation.
FM NOISE:	-60 dB or better rel. to ±25 kHz dev.
AM NOISE:⁶	-55 dB relative to 100% modulation.
INTERCARRIER PHASE MODULATION:⁷	-46 dB or better relative to ±25 kHz deviation.
FREQUENCY STABILITY:⁸	±250 Hz.
ELECTRICAL REQUIREMENTS:	Power input: 208/240 Volts, ±11 Volts, 3 phase, 60 Hz. Typical power consumption: 30 kVA, black picture; 27 kVA, average picture. Power factor: .97 typical.

SERVICE CONDITIONS

AMBIENT TEMPERATURE:	-10° to +50° C (14° to 122° F).
AMBIENT HUMIDITY RANGE:	0 to 95% relative humidity.
ALTITUDE:	Sea level to 10,000 feet (3048 meters).
PHYSICAL AND MECHANICAL DIMENSIONS:	Transmitter cabinet: 71 in. W x 32.3 in. D x 71.7 in. H. (180 cm x 82 cm x 182 cm). Weight: 1,874 lbs. (850 kg). Power supply: 48 in. W x 24 in. D x 60.7 in. H. (122 cm x 61 cm x 153 cm). Weight: 1,477 lbs. (670 kg).

SPECIFICATIONS SUBJECT TO CHANGE WITHOUT NOTICE

¹After initial aging of 60 days.

²Pedestal set to 50 IRE Units carrier plus 200 kHz set to 0 dB reference. Sweep amplitude set to 20 IRE units peak to peak. Pedestal varied from 20 to 80 IRE units.

³Maximum variation of sub-carrier amplitude from 75% to 10% of mod. Sub-carrier mod. percentage: 10% peak to peak.

⁴Maximum variation of sub-carrier phase with respect to burst for mod. percentage from 75% to 10%. Sub-carrier mod. percentage: 10% peak to peak.

⁵Bridging, loop through input with -30 dB or better return loss up to 5.5 MHz.

⁶After de-emphasis.

⁷Rel. to 100% AM modulation at ±50 kHz deviation.

⁸Relative to frequency offset by 4.5 MHz (FCC), 5.5 MHz (CCIR) from the visual carrier.

ORDERING INFORMATION

TV-10H 10 kW VHF-TV transmitter for CCIR System "M" service, 174-216 MHz 208/240 volts, 60 Hz, with operating tubes, transistors, IC's, solid-state rectifiers, crystals, required pre-correction circuitry, low level sideband filter, harmonic filters..... 994-8224-003

TV-10H SPECIFICATIONS

CCIR System B, 625 Lines, 50 Hz

VISUAL PERFORMANCE

POWER OUTPUT:	10 kW.
COLOR SYSTEM:	PAL, SECAM.
TYPE MODULATION:	A5C negative.
FREQUENCY RANGE:	174-230 MHz, Band III, Channels E5-E12.
VIDEO INPUT IMPEDANCE: ¹	75 ohms.
VIDEO INPUT LEVEL:	.7 to 2.0 volts, peak to peak, sync. negative.
RF OUTPUT:	50 ohms. Output connector: 3/8" EIA, flanged with unflanged adapter.
AM NOISE: ²	
HUM AND LOW FREQUENCY:	-60 dB or better peak to peak.
PERIODIC NOISE 10 kHz to 5.2 MHz:	-40 dB peak to peak.
TOTAL RANDOM AND PERIODIC NOISE UNWEIGHED:	-55 dB RMS or better.
MODULATION CAPABILITY:	0%, sync equal to 100%.
RF POWER OUTPUT VARIATION:	Less than 2% total variation for pedestal levels 10% to 75% of sync.
FREQUENCY RESPONSE VARIATION: ³	Less than ± 0.75 dB.
LUMINANCE NONLINEARITY: ⁴	10% or better.
VISUAL SIDEBAND RESPONSE:	-4.43 MHz -30 dB -1.25 MHz -22 dB -0.75 MHz to 5.5 MHz ± 0.5 dB +5.5 MHz -22 dB
DIFFERENTIAL GAIN: ⁴	3% or better.
DIFFERENTIAL PHASE: ⁴	$\pm 1^\circ$ or better.
2:1 K FACTOR:	2% maximum.
20:1 GAIN & DELAY RESPONSE:	5% or less total baseline disturbance.
CHROMANANCE INTERMODULATION: ⁵	Less than 2% total distortion.
BLANKING VARIATION:	Less than 2% total variation.
FIELD FREQUENCY SQUARE WAVE TILT:	Less than 2% total variation.
INCIDENTAL PHASE MODULATION:	$\pm 3^\circ$ or less relative to blanking.
EQUIVALENT ENVELOPE DELAY:	Complies with system requirements.
CARRIER STABILITY:	± 250 Hz (maximum variation over 30 days).
HARMONIC RADIATION:	-80 dB or better below sync peak.

AURAL PERFORMANCE

TYPE OF EMISSION:	FM.
POWER OUTPUT:	1 kW at diplexer output.
CARRIER STABILITY:	± 250 Hz (for 30 days relative to frequency offset from 5.5 MHz visual carrier).
RF OUTPUT IMPEDANCE:	50 ohms output connector: 3/8" EIA, flanged with unflanged adapter.
AUDIO INPUT IMPEDANCE:	600 ohms, balanced.
AUDIO INPUT LEVEL:	0 to +12 dBm.
FREQUENCY DEVIATION:	± 50 kHz.
FREQUENCY RESPONSE:	$\pm .5$ dB relative to 50 microsecond pre-emphasis.
AUDIO DISTORTION:	Less than 1% from 30 to 15,000 Hz with 50 kHz deviation; less than 2% for ± 70 kHz deviation.
AM NOISE:	-55 dB or better relative to 100% modulation.
FM NOISE:	-60 dB or better relative to ± 50 kHz deviation.
SYNCHRONOUS AM NOISE:	Less than 1% relative to 100% AM modulation from 30 to 15,000 Hz with ± 50 kHz deviation.
INTERCARRIER NOISE:	-46 dB or better relative to ± 50 kHz deviation.
FREQUENCY STABILITY:	± 250 Hz.
ELECTRICAL REQUIREMENTS:	Power Input: 380/415 volts, ± 18 volts, 50 Hz. Typical power consumption; 30 kVA, Black picture; 26 kVA Average picture. Power factor: .97 typical.

SERVICE CONDITIONS

AMBIENT TEMPERATURE:	-10° to +50° C (14° to 122° F).
AMBIENT HUMIDITY RANGE:	0 to 95% relative humidity.
ALTITUDE:	Sea level to 3048 meters (10,000 feet).
PHYSICAL AND MECHANICAL DIMENSIONS:	Transmitter cabinet: 180 cm W x 82 cm D x 182 cm H. (71" x 32.3" x 71.7"). Weight: 850 kg (1,874 lbs.). Power supply: 122 cm W x 61 cm D x 153 cm H. (48" x 24" x 60.7"). Weight: 670 kg (1,477 lbs.).

SPECIFICATIONS SUBJECT TO CHANGE WITHOUT NOTICE

¹Bridging, loop through input with -30 dB or better return loss up to 5.5 MHz.

²Noise measured with respect to black to white transition.

³Pedestal set to 42% of sync, carrier plus 200 kHz set to 0 dB reference. Sweep amplitude set to 20 IRE units peak to peak. Pedestal varied from 15 to 65%.

⁴Measured with a 5 step riser signal. Test signal No. 3 CCIR REC 421-3.

⁵Measured with a three level chrominance signal with constant pedestal level.

ORDERING INFORMATION

TV-10H 10 kW VHF-TV transmitter for CCIR System "B" service, 174-230 MHz (Band III), 380/415 volts, 50 Hz, with operating tubes, transistors, IC's solid-state rectifiers, crystals, required pre-correction circuitry, low level sideband filter, harmonic filters 994-8224-001



HARRIS
COMMUNICATIONS AND
INFORMATION HANDLING

BTD-50L2

50-Kilowatt Dual VHF Low Band Color Television Transmitter

- Two independent, complete 25-kilowatt transmitters for total redundancy and on-the-air reliability
- "Hot" standby exciters, modulators and sideband filter
- Harris' Dualtran output switching system allows parallel, single transmitter or alternate/main operation
- Advanced Transversal SideBand (TSB) filters—no group delay, no tuning adjustments required
- IF Modulation of the visual and aural carriers for superb color and sound reproduction
- Latest design for unattended operation
- Simple solid-state logic control
- DC filaments on directly heated cathodes
- Less maintenance
- Modular pre-wired cabinets for easiest installation

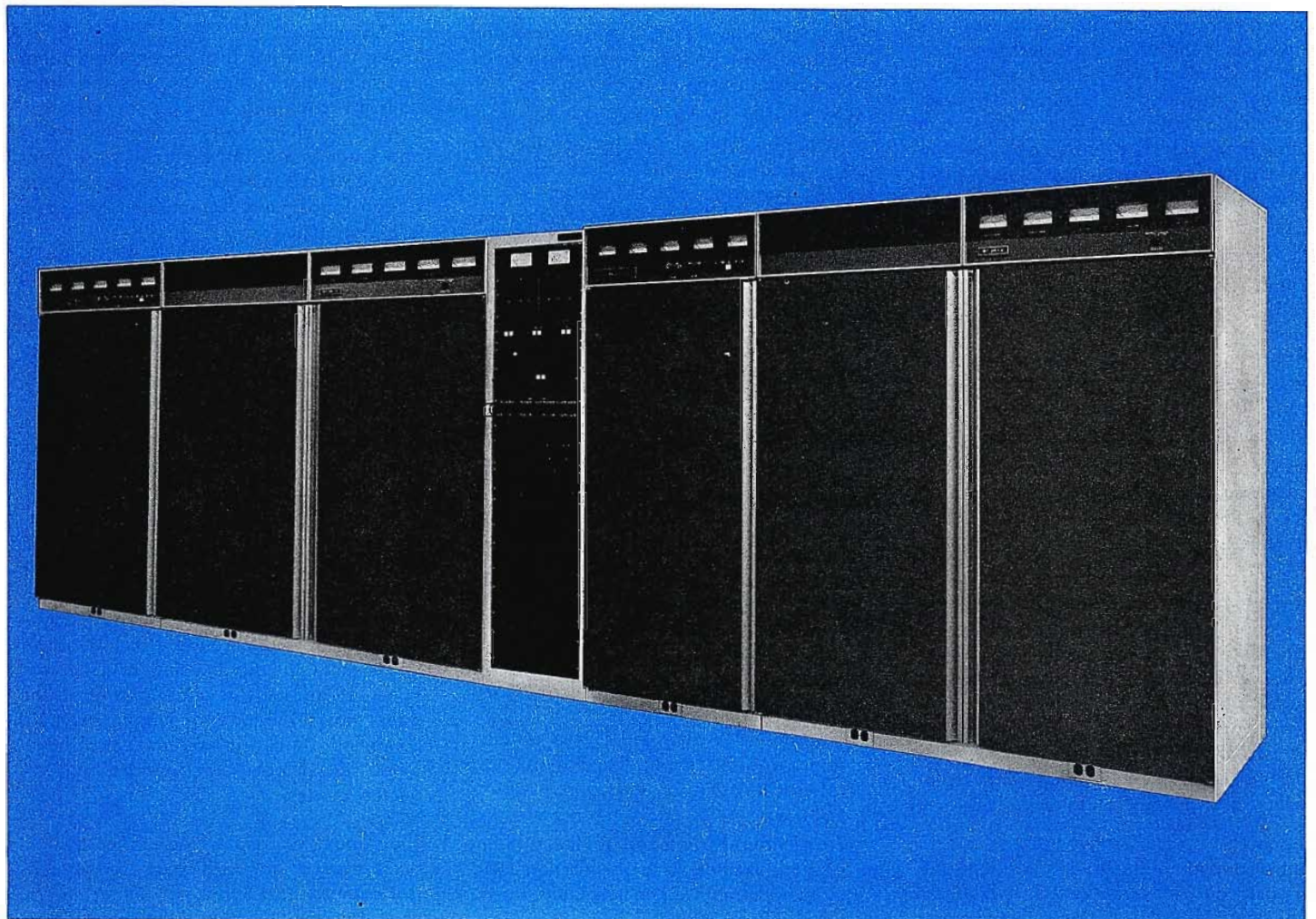

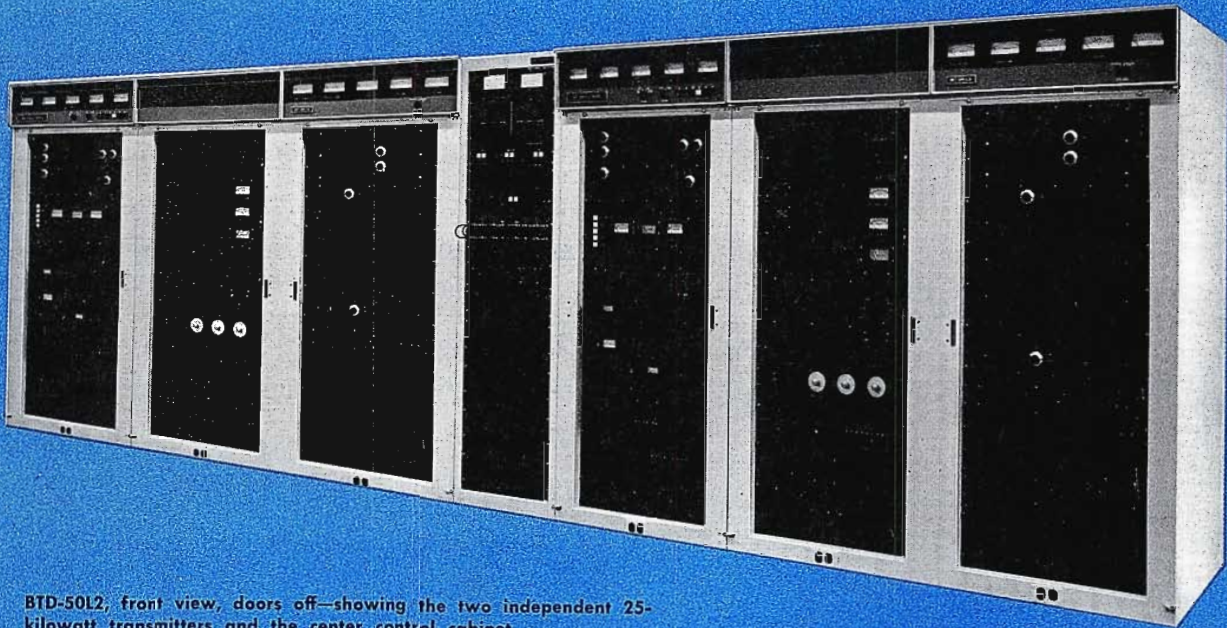

BTD-50L2, front view, doors off—showing the two independent 25-kilowatt transmitters and the center control cabinet.

TOTAL REDUNDANCY FOR COMPLETE RELIABILITY

The Harris BTD-50L2, 50-kilowatt dual low band VHF TV transmitter, is designed for television broadcasters who want the utmost in reliability and performance—with the flexibility for remote control operation, attended operation or unattended/computer operation. This dual transmitter consists of two completely independent 25-kilowatt transmitters operating in parallel, combined through the Harris unique-design Dualtran RF switching system.

With the BTD-50L2 you get two aural exciter/modulators, two visual exciter/modulators, two TSB filters, two visual and aural IPA's, two visual and aural PA's, and two HV power supplies—in short, total redundancy! Complete reliability!

The Dualtran switching system is factory assembled in one cabinet, and can interface with either a hybrid or a notch diplexer.

IF (intermediate frequency) Modulation, low-level sideband filtering, true linear operation of power amplifiers and solid-state visual and aural exciter/modulators combine to provide outstanding color and sound fidelity. As no envelope delay correction or adjustments are required for the solid-state Transversal SideBand filter(s), stability, reliability and color quality are greatly enhanced.

Frequency adjustment, power output control and amplifier tuning are straightforward and uncomplicated, while design simplicity and conservatively rated

components in the BTD-50L2 assure long-term "hands-off" operation and minimum maintenance. DC filaments in the visual and aural stages provide improved signal-to-noise ratios.

The transmitter is FCC type accepted, and complete factory power testing assures performance to specifications.

AUTOMATIC SWITCHING. In the event of a malfunction of one-half of the parallel combination, the Harris BTD-50L2 offers automatic and instantaneous reduction to one-fourth authorized power. This function will occur without interruption of the carrier. With the touch of a button, half-power operation is achieved in less than three seconds.

Visual and aural exciters are connected in a hot standby condition, and will automatically switch in less than 10 milliseconds in case of failure in either unit. In all modes, aural follows visual for simplified logic control and reliable operation.

OPERATING VERSATILITY. Four modes of operation may be obtained electrically by means of control pushbuttons on the output switcher; by control buttons on the transmitter control panel; or by remote control. These are:

- Transmitters A and B combined and diplexed to the antenna (normal operating mode).
- Transmitter A diplexed to the antenna and transmitter B to the station loads (alternate/main or emergency operation).
- Transmitter B diplexed to the antenna and transmitter A to the station loads (alternate/main or emergency operation).

- Transmitters A and B combined to the station loads (test mode).

The switching operation from one mode to any other mode requires less than three seconds.

When using a notch diplexer, three other operating modes may be selected manually by changing links on the Dualtran output switching cabinet: transmitters A and B combined and diplexed to the station loads; transmitter A diplexed into station loads; and transmitter B diplexed into station loads.

CONTROL CABINET. The RF Phasing and Control Panel and the Automatic Exciter/Modulator Switcher are standard equipment with the BTD-50L2, and are located in a control cabinet that is typically placed between the two independent 25-kilowatt transmitters. The cabinet is the same height as the transmitters, and the same color, to provide a pleasing installation. All adjustments for dual operation may be made at this cabinet.

The Harris exciter/modulators, with IF Modulation, allow phasing of transmitters for dual operation to be accomplished simply and reliably at low power levels from the RF Phasing and Control Panel. In addition to phasing control, the panel has provisions for monitoring total combined aural power and total combined visual power in forward and reflected modes.

The Automatic Exciter/Modulator Switcher is also a standard part of the control cabinet, and allows for either manual or automatic selection of exciters.

CONTROL CABINET OPTIONS. An optional System Control Panel can be used to control the transmitter system from the control cabinet or from an adjacent room. Controls include: transmitter on/off; output switcher mode select; exciter/modulator mode select; transmitter power raise/lower; and power metering.

Another option, the Input Patch Panel, provides additional flexibility by bypassing all of the input switching coaxial relays for single transmitter operation, or for maintenance and testing. Coaxial cables allow patching from any aural or visual exciter to any aural or visual transmitter IPA input. The low-level RF flow is shown on the front of the panel for ease of operation.

The RF Input Bypass Switcher is a valuable option where the dual transmitter is operating at reduced power in the combined mode, and it is desired to return to full power of one transmitter when operating in the single transmitter mode. The RF Input Bypass Switcher does this automatically, and can be disabled by a switch or returned to manual control.

Auxiliary, remotely switched correction circuits for differential phase and differential gain are available to optimize operation in a single transmitter mode.

TRANSVERSAL SIDE BAND (TSB) FILTER

The Harris solid-state sideband filter is an advanced surface acoustic wave design, and shapes visual sidebands at the IF frequency, rather than "on frequency" at the full output power of the transmitter. Unlike conventional VSB filters, the TSB filter has an inherent linear phase characteristic, which means that it requires no group delay correction. A conventional VSB filter requires from 600 to 1,000 nsec of group delay correction, and many adjustments—the TSB filter requires no correction or adjustments—ever! A conventional VSB filter needs 6 to 12 tuning controls—the TSB filter needs no tuning controls, as it requires no tuning adjustment—ever!

In addition, the TSB filter has steeper skirts and higher attenuation outside the channel passband for improved VSB wave shaping.

Only 1½ square inches in size, the TSB filter is mounted on a PC board in the visual exciter(s).

ADVANCE-DESIGN VISUAL AND AURAL EXCITER/MODULATORS

The Harris solid-state MCP visual exciter/modulator is an independent, self-con-

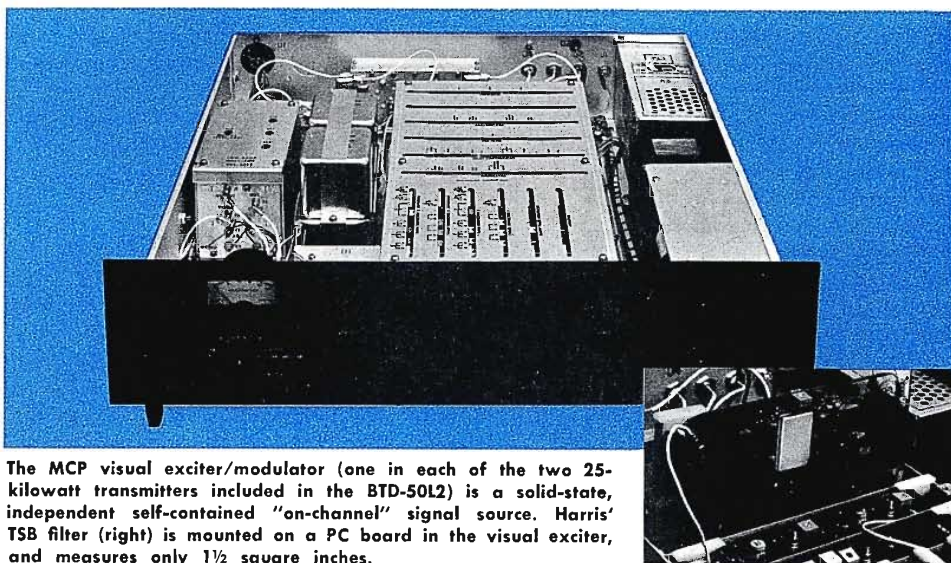

The MCP visual exciter/modulator (one in each of the two 25-kilowatt transmitters included in the BTD-50L2) is a solid-state, independent self-contained "on-channel" signal source. Harris' TSB filter (right) is mounted on a PC board in the visual exciter, and measures only 1½ square inches.

tained unit which provides a fully processed on-channel picture signal. Power output can be varied up to one watt with a single front panel control, or from a remote location, without retuning of any kind.

The master oscillator is located in the visual exciter in a proportional controlled oven, and master oscillator frequency can be varied ± 500 Hz. With one control the station engineer can make precise frequency adjustments to both the visual and aural carriers. Actual frequency determining circuitry is also contained in the visual exciter in a proportional controlled oven. Visual modulation takes place at 37.0 MHz. Sidebands are filtered by the Harris TSB filter, which may be bypassed easily for transmitter tuning and maintenance.

The visual exciter is mounted in a pull-out drawer and may be operated outside the main transmitter for test purposes. A switch and meter mounted on the front panel permit monitoring exciter parameters. Power and video gain controls are motor driven with manual override provision.

The Harris visual exciter/modulator provides great reliability and stability, excellent frequency response, and truest color quality. It is also designed for minimum maintenance and set-up time, and for remote control and unattended operation. This is all made possible through the use of the latest design techniques, including Harris' solid-state TSB filter.

The Harris aural exciter/modulator is a solid-state self-contained unit which furnishes a fully processed aural signal at a level up to 10 watts. Power output can be set with a single knob on the front panel, or by remote control, with no need for retuning.

Audio information is used to modulate a direct FM 32.5 MHz carrier derived from the master oscillator in the visual exciter.

This information is then translated to the desired "on channel" signal through stable frequency determining circuitry housed in a proportional controlled oven in the visual exciter. A digital phase-locked loop is also used to guarantee absolute frequency stability.

The aural exciter/modulator is mounted in a pull-out drawer, and may be operated with the drawer extended for test purposes. The exciter has been designed for remote control and unattended operation.

IF MODULATION

One of the most important features of the BTD-50L2 is its true low-level IF Modulation, which offers a top quality picture, and excels in electrical performance, reliability and simplicity of operation.

In the BTD-50L2 the visual and aural exciters generate fully modulated low-level IF signals. The output of a common crystal controlled reference oscillator is used to raise the individual IF signal to the desired "on channel" output frequency.

As it occurs at much lower power levels than conventional designs, intermediate frequency modulation needs fewer circuits to produce a fully processed, quality picture signal. Less than one volt of video signal is needed to modulate the RF carrier.

The Harris ring modulator design permits modulation percentages to approximately 2% without compromising transmitter performance—and eliminates most pre-distortion circuitry. This results in exceptional color purity and nearly perfect signal linearity. Even such colors as highly saturated yellow and cyan are faithfully reproduced with IF Modulation.

Due to the low-level techniques, which include the use of devices such as an extremely linear broadband diode ring

modulator, low-level sideband filtering and very linear broadband amplifiers, the broadcast signal is a faithful reproduction of the signal applied to the transmitter input. IF Modulation results in low incidental phase noise, and the elimination of many transmission problems at their source. This means that no half-way measures—such as numerous correction, compensation and feedback circuits—are required to eliminate the effects of these problems later on.

SOLID-STATE CONTROL LOGIC

Complete and foolproof control of all transmitter functions is achieved through the use of solid-state memory, timing and logic circuits. A self-charging emergency power source is provided to maintain control logic memory during periods of power line failure.

The solid-state control logic and protective circuitry, in addition to commanding

normal AC control functions, is also used to visually indicate, through indicator lights, the operating status of the transmitter system. These indicator lights allow easy isolation of circuit faults.

AUTOMATIC RECYCLING

The BTD-50L2's built-in memory circuitry enables the entire transmitter to return to the air automatically in the stage it was operating immediately prior to a partial or full power failure. When the transmitter returns to "on-air", status lights provide visual indication of any malfunctions caused by the outage.

REMOTE CONTROL, UNATTENDED AND AUTOMATIC OPERATION

All control, metering and monitoring circuits have been designed specifically for

remote control and unattended operation. The power controls are motor driven and the necessary remote control sampling points are built-in on accessible terminal boards. High and low power switching functions may also be remote controlled.

Today, Harris TV transmitters are being operated successfully worldwide in an unattended mode, with and without remote control access. In addition, Harris' transmitter design is consistent with anticipated automatic transmitter needs in the future.

POWER SUPPLIES

The HV power supplies are multi-phase, full wave rectifying systems exhibiting very low ripple content prior to output filtering. They are designed for excellent regulation and low video impedance for optimum picture performance. Each power supply, including transformer and solid-state rectifiers, is housed in a single assembly, mounted externally from the transmitter. Routine maintenance access is provided by a removable panel.

Directly heated vacuum tube filaments are fed with DC to maximize the output signal-to-noise ratio. Grid and screen supplies use solid-state regulators.

The 1300-watt driver cabinets have independent solid-state HV power supplies, and the visual and aural exciters have their own independent, solid-state, regulated power supplies.

EASE OF MAINTENANCE AND INSTALLATION

Total transmitter component accessibility is provided, front and back. Visual and aural exciters slide out and can operate independently from the transmitter outside the exciter/driver cabinet. Various exciter circuits, such as oscillators, modulators and processing circuitry, are of modular construction and can be removed for maintenance or replacement.

Easy-to-read, eye-level 4-inch meters are used to monitor required transmitter functions. Meter panels are of double-hinged construction for convenient access during maintenance. A complete system of overload indicators is also provided in each cabinet for monitoring transmitter operation. In the event of a transmitter malfunction, an examination of the indicators will locate the problem area.

The transmitter has been built in a modular fashion so that cabinets may be separated into convenient, easy-to-handle sub-assemblies to facilitate installation.

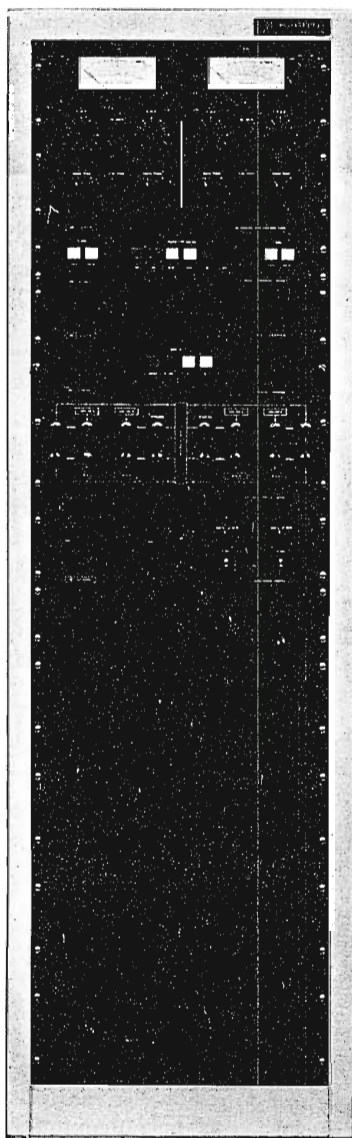

All adjustments for dual transmitter operation may be made from the center control cabinet of the BTD-50L2. An RF Phasing and Control Panel and an Automatic Exciter/Modulator Switcher are standard equipment in the cabinet—and several optional control panels are available.

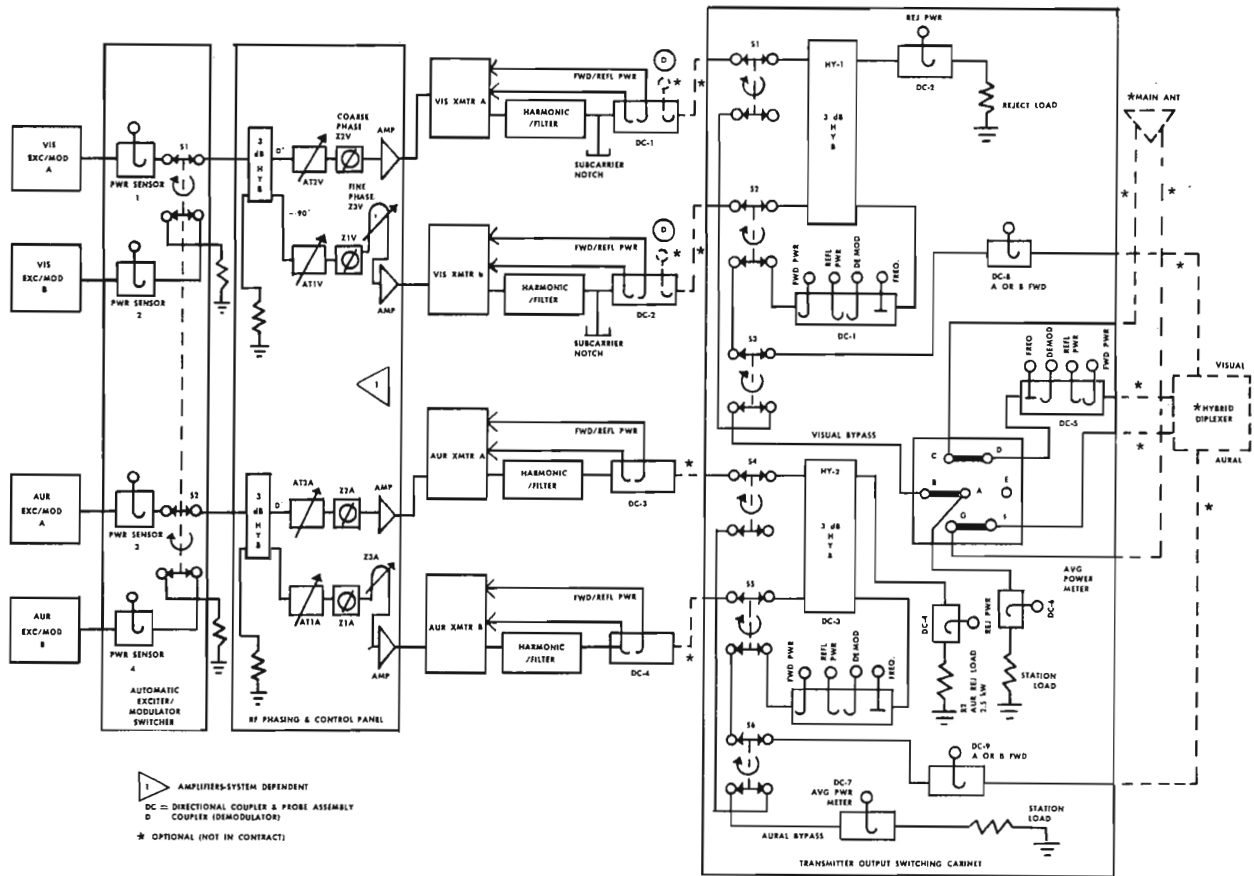

RF FLOW BTD-50L2 WITH HYBRID DIPLEXER

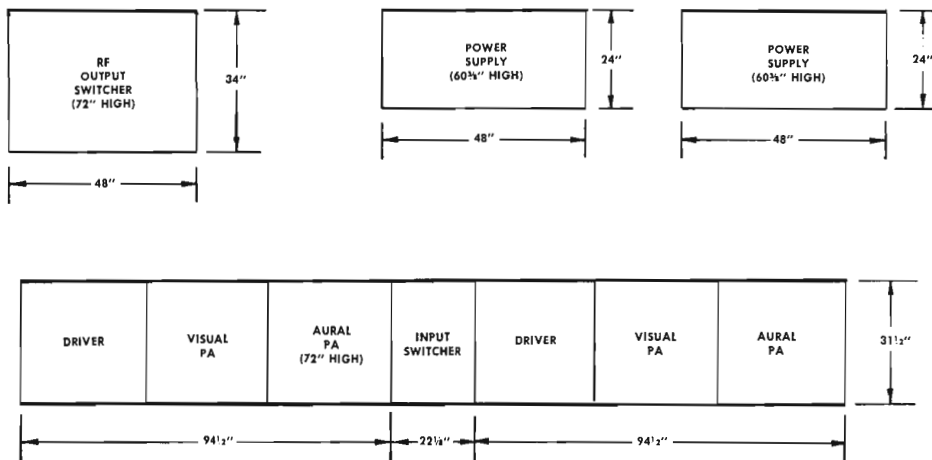

BTD-50L2 FLOOR PLAN

BTD-50L2 SPECIFICATIONS

VISUAL PERFORMANCE

POWER OUTPUT:
 OUTPUT IMPEDANCE:
 FREQUENCY RANGE:
 CARRIER STABILITY:¹
 REG. OF RF OUTPUT POWER (Black to white pic.):
 VARIATION OF OUTPUT (over one frame):
 VISUAL SIDEBAND RESPONSE:

FREQUENCY RESPONSE VS. BRIGHTNESS:²
 VISUAL MODULATION CAPABILITY:
 DIFFERENTIAL GAIN:³
 LINEARITY (LOW FREQUENCY):
 DIFFERENTIAL PHASE:⁴
 SIGNAL-TO-NOISE RATIO:
 K-FACTORS:
 EQUIVALENT ENVELOPE DELAY:

VIDEO INPUT:⁵
 HARMONIC RADIATION:
 INTERCARRIER PHASE MODULATION (noise):
 HIGH FREQUENCY TRANSIENT RESPONSE, 15 kHz and 250 kHz:

AURAL PERFORMANCE

POWER OUTPUT:
 OUTPUT IMPEDANCE:
 AUDIO INPUT:
 FREQUENCY DEVIATION:
 INPUT IMPEDANCE:
 PRE-EMPHASIS:
 FREQUENCY RESPONSE:
 DISTORTION:
 FM NOISE:
 AM NOISE:⁶
 SYNCHRONOUS AM NOISE:⁷
 FREQUENCY STABILITY:⁸

SERVICE CONDITIONS

AMBIENT TEMPERATURE:
 AMBIENT HUMIDITY RANGE:
 ALTITUDE:
 PHYSICAL AND MECHANICAL DIMENSIONS:

ELECTRICAL REQUIREMENTS:

FCC

50 kW peak.
 50 ohms. Output connector: 3/8" EIA standard.
 54-88 MHz (Channels 2-6).
 ±250 Hz (maximum variation over 30 days).
 3% or less.
 Less than 2%.
 -3.58 MHz ----- -42 dB or better
 -1.25 MHz and lower ----- -26 dB or better
 Carrier to 0.75 MHz ----- ±0.5 dB
 Carrier ----- 0 dB reference
 Carrier to +4.20 MHz ----- ±0.5 dB
 +4.75 MHz and higher ----- -30 dB or better
 ±0.75 dB.
 3% or better.
 3% or better.
 0.5 dB or better.
 ±1° or better.
 -55 dB or better (RMS) below sync level.
 2± 2%, 12.5± less than 5% baseline disturbance.
 .05 to 2.1 MHz: ± 40 ns
 at 3.58 MHz: ± 30 ns
 at 4.18 MHz: ± 70 ns
 (referenced to standard curve—FCC)
 75 ohm system.
 -80 dB.
 (Not applicable).
 (Not applicable).

10 kW at diplexer output.
 50 ohms. Output connector: 3/8" EIA Std.
 +10 dBm, ±2 dB.
 ±25 kHz.
 600 ohms.
 75 microseconds.
 ±0.5 dB rel. to pre-emphasis (30-15,000 Hz).
 0.5% or less after 75 microseconds de-emphasis with ±25 kHz deviation.
 -60 dB or better rel. to ±25 kHz dev.
 -55 dB relative to 100% modulation.
 (Not applicable).
 ±250 Hz.

-10° to +50°C (14° to 122°F).
 0 to 95% relative humidity.
 Sea level to 7500 ft.
 Transmitters (2): Each 94½"W x 31½"D x 72"H. Weight, each 2195 lbs.
 Input Switcher Cabinet (1): 22½"W (without side panels) x 24¾"D (with front and rear doors) x 72"H. Weight, 300 lbs. RF Output Switcher (1): 48"W x 34"D x 72"H. Weight, 1350 lbs. Power Supplies (2): Each 48"W x 24"D x 60¾"H. Weight, each 1475 lbs.
 Power input: 208/240 Volts, ±11 Volts, 3 phase, 50/60 Hz. Power consumption: 114 kVA, black picture; 98 kVA, average picture. Power factor: .97 typical.

¹ After initial aging of 60 days.
² Measured at 65% and 15% of modulation. Reference 100% = peak of sync.
³ Maximum variation of sub-carrier amplitude from 75% to 10% of mod. Sub-carrier mod. percentage: 10% peak to peak.
⁴ Maximum variation of sub-carrier phase with respect to burst for mod. percentage from 75% to 10%. Sub-carrier mod. percentage: 10% peak to peak.
⁵ Bridging, loop through input with -30 dB or better return loss up to 5.5 MHz.
⁶ After de-emphasis.
⁷ Rel. to 100% AM modulation at ±50 kHz deviation.
⁸ Relative to frequency offset by 4.5 MHz.

ORDERING INFORMATION

BTD-50L2 50 kW VHF-TV transmitter for FCC standards service, Channels 2-6, with operating tubes, transistors, IC's, solid-state rectifiers, crystals, required pre-correction circuitry, low-level vestigial sideband filter, harmonic and color notch filters ----- 994-8039-001



HARRIS
COMMUNICATIONS AND
INFORMATION HANDLING

BTD-36L2

36-Kilowatt Dual VHF Low Band Color Television Transmitter

- Two independent, complete 18-kilowatt transmitters for total redundancy
- "Hot" standby exciters, modulators and sideband filter
- Harris' Dualtran output switching system allows parallel, single transmitter or alternate/main operation
- More than a two-to-one improvement in color performance specifications
- Advanced Transversal SideBand (TSB) filter(s)—no group delay correction, no tuning adjustments required
- IF Modulation of the visual and aural carriers for superb color and sound reproduction
- Latest design for unattended operation
- Simple solid-state logic control
- DC filaments on directly heated cathodes
- Less maintenance
- Modular pre-wired cabinets for low-cost installation

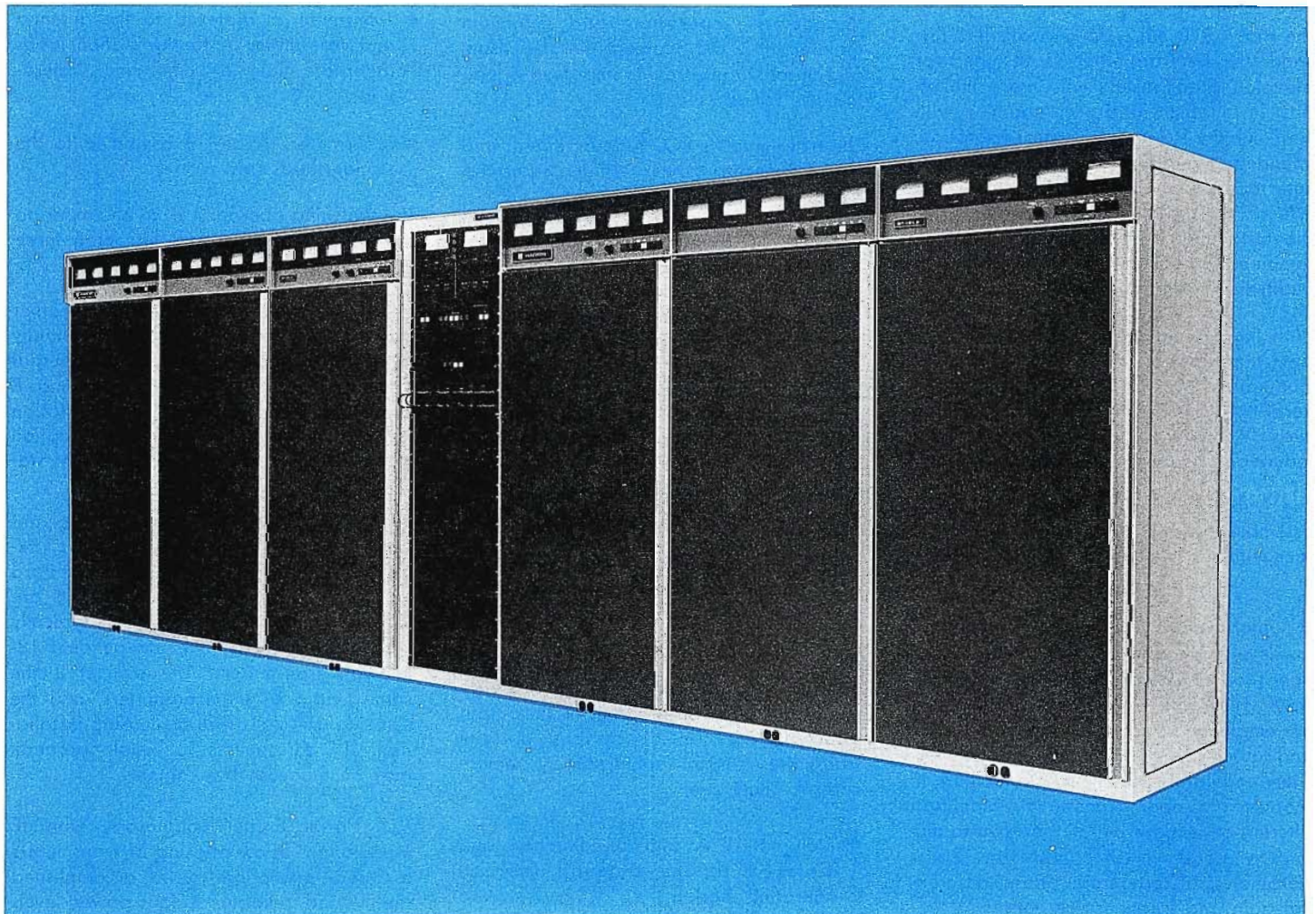

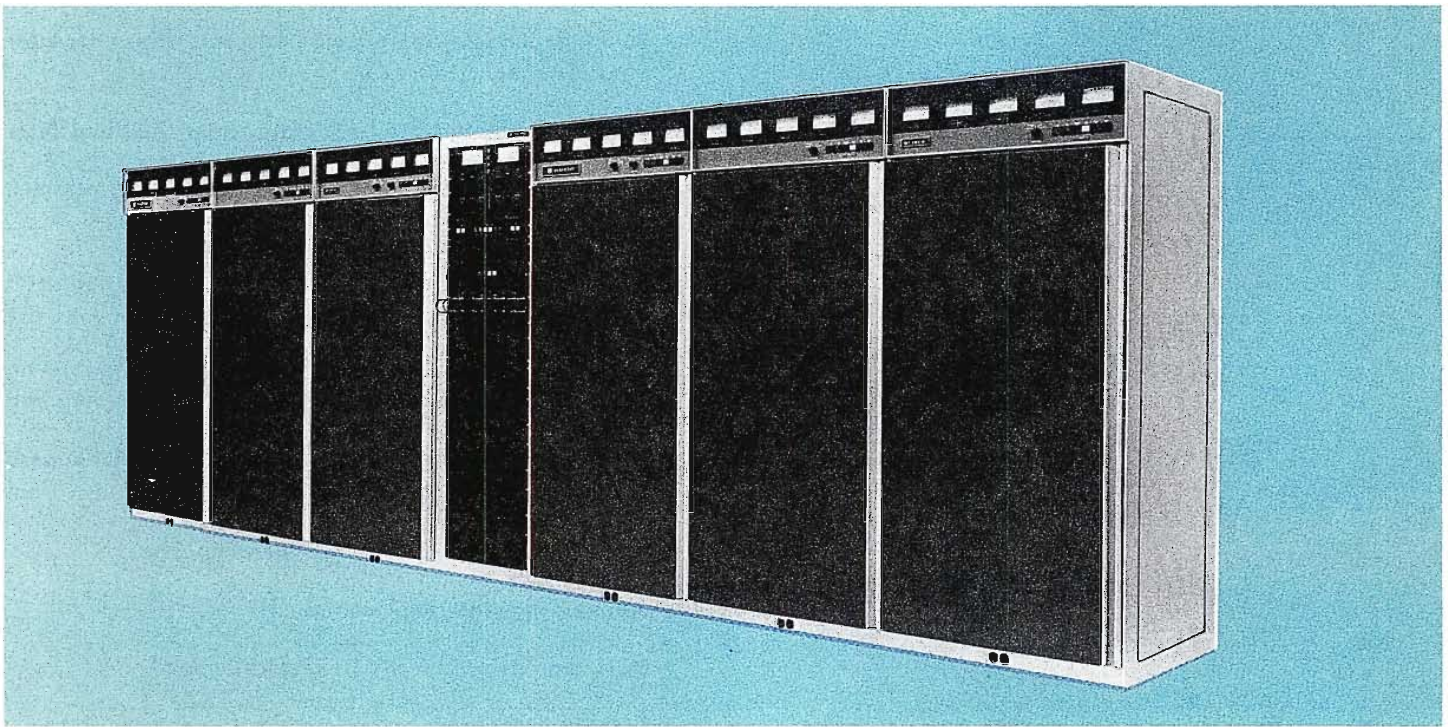

TOTAL REDUNDANCY FOR COMPLETE RELIABILITY

The Harris BTD-36L2, 36-kilowatt dual low band VHF TV transmitter, is designed for television broadcasters who want the utmost in reliability and performance—with the flexibility for remote control operation, attended operation or unattended/computer operation. This dual transmitter consists of two completely independent 18-kilowatt transmitters operating in parallel, combined through the Harris unique-design Dualtran RF switching system.

With the BTD-36L2 you get two aural exciter/modulators, two visual exciter/modulators, two TSB filters, two visual and aural IPA's, two visual and aural PA's, and two HV power supplies—in short, total redundancy! Complete reliability!

The Dualtran switching system is factory assembled in one cabinet, and can interface with either a hybrid or a notch diplexer.

IF (intermediate frequency) Modulation, low-level sideband filtering, true linear operation of power amplifiers and solid-state visual and aural exciter/modulators are employed to provide outstanding color and sound fidelity. In the MCP-TV visual exciter/modulator, Harris has combined IF Modulation and Transversal SideBand filtering to achieve better than two-to-one improvements in the important color parameters of differential phase, differential gain and frequency response!

Frequency adjustment, power output control and amplifier tuning are straight-

forward and uncomplicated, while design simplicity and conservatively rated components in the BTD-36L2 assure long-term "hands-off" operation and minimum maintenance. DC filaments in the visual and aural stages provide improved signal-to-noise ratios.

The transmitter is FCC type accepted, and complete factory power testing assures performance to specifications.

AUTOMATIC SWITCHING. In the event of a malfunction of one-half of the parallel combination, the Harris BTD-36L2 offers automatic and instantaneous reduction to one-fourth authorized power. This function will occur without interruption of the carrier. With the touch of a button, half-power operation is achieved in less than three seconds.

Visual and aural exciters are connected in a hot standby condition, and will automatically switch in less than 10 milliseconds in case of failure in either unit. In all modes, aural follows visual for simplified logic control and reliable operation.

OPERATING VERSATILITY. Four modes of operation may be obtained electrically by means of control pushbuttons on the output switcher; by control buttons on the transmitter control panel; or by remote control. These are:

- Transmitters A and B combined and diplexed to the antenna (normal operating mode).
- Transmitter A diplexed to the antenna and transmitter B to the station loads

(alternate/main or emergency operation).

- Transmitter B diplexed to the antenna and transmitter A to the station loads (alternate/main or emergency operation).
- Transmitters A and B combined to the station loads (test mode).

The switching operation from one mode to any other mode requires less than three seconds.

When using a notch diplexer, three other operating modes may be selected manually by changing links on the Dualtran output switching cabinet: transmitters A and B combined and diplexed to the station loads; transmitter A diplexed into station loads; and transmitter B diplexed into station loads.

CONTROL CABINET. The RF Phasing and Control Panel and the Automatic Exciter/Modulator Switcher are standard equipment with the BTD-36L2, and are located in a control cabinet that is typically placed between the two independent 18-kilowatt transmitters. The cabinet is the same height as the transmitters, and the same color, to provide a pleasing installation. All adjustments for dual operation may be made at this cabinet.

The Harris exciter/modulators, with IF Modulation, allow phasing of transmitters for dual operation to be accomplished simply and reliably at low power levels from the RF Phasing and Control Panel. In addition to phasing control, the panel has provisions for monitoring total combined

aural power and total combined visual power in forward and reflected modes.

The Automatic Exciter/Modulator Switcher is also a standard part of the control cabinet, and allows for either manual or automatic selection of exciters.

CONTROL CABINET OPTIONS. An optional System Control Panel can be used to control the transmitter system from the control cabinet or from an adjacent room. Controls include: transmitter on/off; output switcher mode select; exciter/modulator mode select; transmitter power raise/lower; and power metering.

Another option, the Input Patch Panel, provides additional flexibility by bypassing all of the input switching coaxial relays for single transmitter operation, or for maintenance and testing. Coaxial cables allow patching from any aural or visual exciter to any aural or visual transmitter IPA input. The low-level RF flow is shown on the front of the panel for ease of operation.

The RF Input Bypass Switcher is a valuable option where the dual transmitter is operating at reduced power in the combined mode, and it is desired to return to full power of one transmitter when operating in the single transmitter mode. The RF Input Bypass Switcher does this automatically, and can be disabled by a switch or returned to manual control.

Auxiliary, remotely switched correction circuits for differential phase and differential gain are available to optimize operation in a single transmitter mode.

TRANSVERSAL SIDE BAND (TSB) FILTER

The Harris solid-state sideband filter is an advanced surface acoustic wave design, and shapes visual sidebands at the IF frequency, rather than "on frequency" at the full output power of the transmitter. Unlike older VSB filters, the TSB filter has an inherent linear phase characteristic, which means that it requires no group delay correction. A conventional VSB filter requires from 600 to 1000 nsec of group delay correction, and many adjustments—the TSB filter requires no correction or adjustments—ever! A conventional VSB filter needs 6 to 12 tuning controls—the TSB filter needs no tuning controls, as it requires no tuning adjustment—ever!

In addition, the TSB filter has steeper skirts and higher attenuation outside the channel passband for improved VSB wave shaping.

Only 1½ square inches in size, the TSB filter is mounted on a PC board in the visual exciter(s).

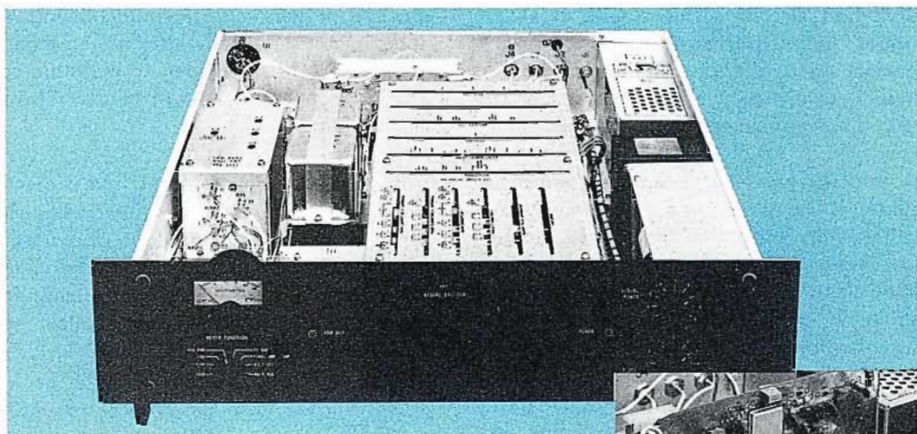

The MCP-1V visual exciter/modulator (one in each of the two 18-kilowatt transmitters included in the BTD-36L2) is a solid-state, independent self-contained "on-channel" signal source. Harris' TSB filter (right) is mounted on a PC board in the visual exciter, and measures only 1½ square inches.

ADVANCED-DESIGN VISUAL AND AURAL EXCITER/MODULATORS

The Harris solid-state maximum color performance MCP-1V visual exciter/modulator is an independent, self-contained unit which provides a fully processed on-channel signal. Combining IF Modulation and recent breakthroughs in filtering technology, the MCP-1V offers the best color performance specifications ever offered in VHF-TV transmitting equipment!

Power output of the visual exciter/modulator can be varied with a single front panel control, or from a remote location, without retuning of any kind.

The master oscillator is located in the visual exciter in a proportional controlled oven, and master oscillator frequency can be varied ± 500 Hz. With one control the station engineer can make precise frequency adjustments to both the visual and aural carriers. Actual frequency determining circuitry is also contained in the visual exciter in a proportional controlled oven. Visual modulation takes place at 37.0 MHz. Sidebands are filtered by the Harris TSB filter, which may be bypassed easily for transmitter tuning and maintenance.

The visual exciter is mounted in a pullout drawer and may be operated outside the main transmitter for test purposes. A switch and meter mounted on the front panel permit monitoring exciter parameters. Power and video gain controls are motor driven with manual override provision.

The Harris visual exciter/modulator provides great reliability and stability, excellent frequency response, and truest color quality. It is also designed for minimum maintenance and set-up time, and for remote control and unattended operation. This is all made possible through the use of the latest design techniques, including Harris' solid-state TSB filter.

The Harris aural exciter/modulator is a solid-state self-contained unit which furnishes a fully processed aural signal at a level up to 10 watts. Power output can be set with a single knob on the front panel, or by remote control, with no need for retuning.

Audio information is used to modulate a direct FM 32.5 MHz carrier derived from the modulated oscillator in the aural exciter. This information is then translated to the desired "on channel" signal through stable frequency determining circuitry housed in a proportional controlled oven in the visual exciter. A digital phase-locked loop is also used to guarantee absolute frequency stability.

The aural exciter/modulator is mounted in a pull-out drawer, and may be operated with the drawer extended for test purposes. The exciter has been designed for remote control and unattended operation.

IF MODULATION

One of the most important features of the BTD-36L2 is its true low-level IF Modulation, which offers a top quality picture, and excels in electrical performance, reliability and simplicity of operation.

In the BTD-36L2 the visual and aural exciters generate fully modulated low-level IF signals. The output of a common crystal controlled reference oscillator is used to raise the individual IF signal to the desired "on channel" output frequency.

As it occurs at much lower power levels than other designs, intermediate frequency modulation needs fewer circuits to produce a fully processed, quality picture signal. Less than one volt of video signal is needed to modulate the RF carrier.

The Harris ring modulator design permits modulation percentages to approximately 2% without compromising transmitter performance—and eliminates most pre-

distortion circuitry. This results in exceptional color performance and nearly perfect signal linearity. Even such colors as highly saturated yellow and cyan are faithfully reproduced with IF Modulation.

Due to the low-level techniques, which include the use of devices such as an extremely linear broadband diode ring modulator, low-level sideband filtering and very linear broadband amplifiers, the broadcast signal is a faithful reproduction of the signal applied to the transmitter input. IF Modulation results in low incidental phase noise, and the elimination of many transmission problems at their source. This means that no half-way measures—such as numerous correction, compensation and feedback circuits—are required to eliminate the effects of these problems later on.

SOLID-STATE CONTROL LOGIC

Complete and foolproof control of all transmitter functions is achieved through

the use of solid-state memory, timing and logic circuits. A self-charging emergency power source is provided to maintain control logic memory during periods of power line failure.

The solid-state control logic and protective circuitry, in addition to commanding normal AC control functions, is also used to visually indicate, through indicator lights, the operating status of the transmitter system. These indicator lights allow easy isolation of circuit faults.

AUTOMATIC RECYCLING

The BTD-36L2's built-in memory circuitry enables the entire transmitter to return to the air automatically in the stage it was operating immediately prior to a partial or full power failure. When the transmitter returns to "on-air", status lights provide visual indication of any malfunctions caused by the outage.

REMOTE CONTROL, UNATTENDED AND AUTOMATIC OPERATION

All control, metering and monitoring circuits have been designed specifically for remote control and unattended operation. The power controls are motor driven and the necessary remote control sampling points are built-in on accessible terminal boards. High and low power switching functions may also be remote controlled.

Today, Harris TV transmitters are being operated successfully worldwide in an unattended mode, with and without remote control access. In addition, Harris' transmitter design is consistent with anticipated automatic transmitter needs in the future.

POWER SUPPLIES

The HV power supplies are multi-phase, full wave rectifying systems exhibiting very low ripple content prior to output filtering. They are designed for excellent regulation and low video impedance for optimum picture performance. Each power supply, including transformer and solid-state rectifiers, is housed in a single assembly, mounted externally from the transmitter. Routine maintenance access is provided by a removable panel.

Directly heated vacuum tube filaments are fed with DC to maximize the output signal-to-noise ratio. Grid and screen supplies use solid-state regulators.

The 1300-watt driver cabinets have independent solid-state HV power supplies, and the visual and aural exciters have their own independent, solid-state, regulated power supplies.

EASE OF MAINTENANCE AND INSTALLATION

Total transmitter component accessibility is provided, front and back. Visual and aural exciters slide out and can operate independently from the transmitter outside the exciter/driver cabinet. Various exciter circuits, such as oscillators, modulators and processing circuitry, are of modular construction and can be removed for maintenance or replacement.

Easy-to-read, eye-level 4-inch meters are used to monitor required transmitter functions. Meter panels are of double-hinged construction for convenient access during maintenance. A complete system of overload indicators is also provided in each cabinet for monitoring transmitter operation. In the event of a transmitter malfunction, an examination of the indicators will locate the problem area.

The transmitter has been built in a modular fashion so that cabinets may be separated into convenient, easy-to-handle sub-assemblies to facilitate installation.

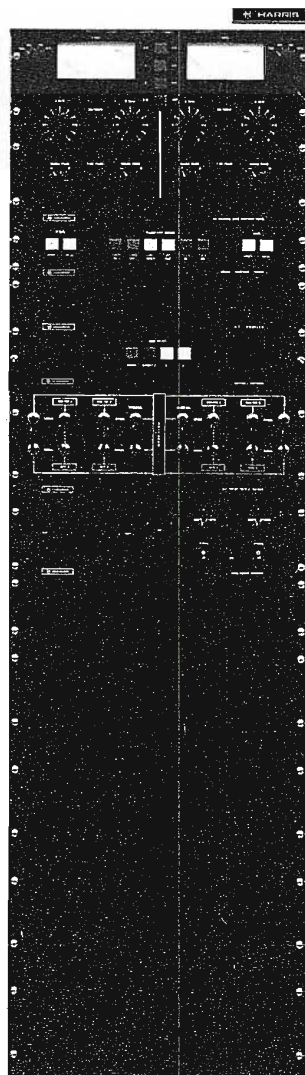

All adjustments for dual transmitter operation may be made from the center control cabinet of the BTD-36L2. An RF Phasing and Control Panel and an Automatic Exciter/Modulator Switcher are standard equipment in the cabinet—and several optional control panels are available.

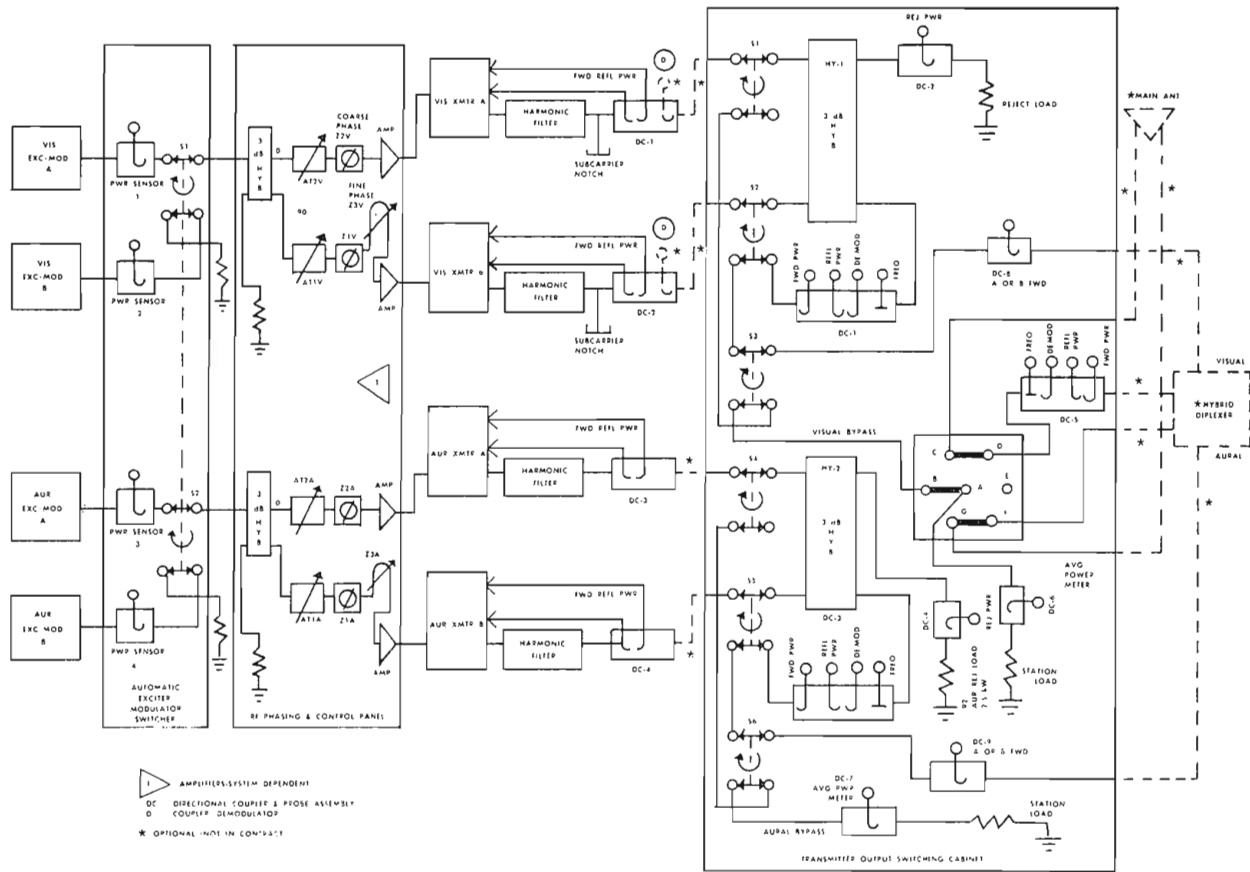

RF FLOW BTD-36L2 WITH HYBRID DIPLEXER

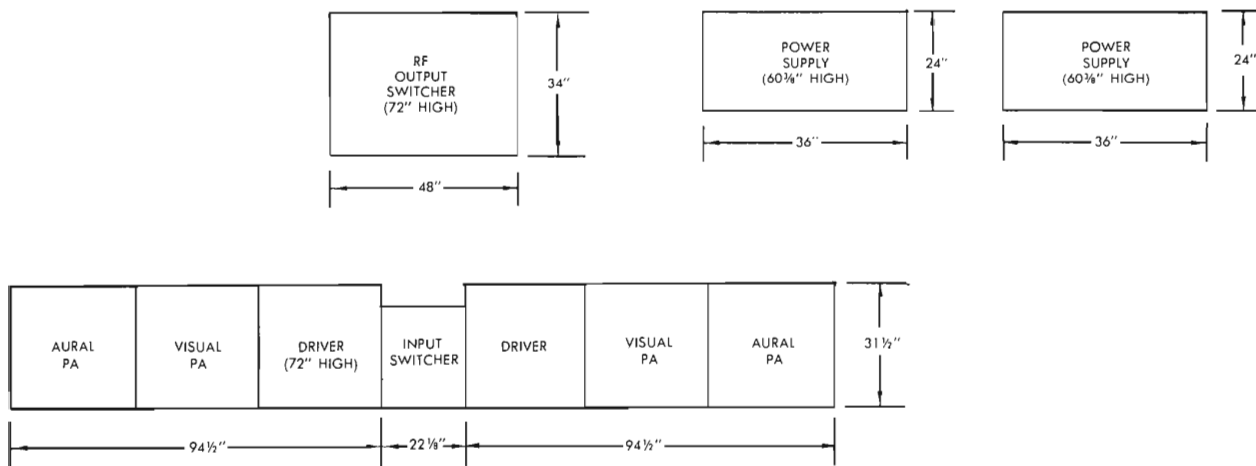

BTD-36L2 FLOOR PLAN

BTD-36L2 SPECIFICATIONS

VISUAL PERFORMANCE

POWER OUTPUT:
OUTPUT IMPEDANCE:
FREQUENCY RANGE:
CARRIER STABILITY:¹
REG. OF RF OUTPUT POWER (Black to white pic.):
VARIATION OF OUTPUT (over one frame):
VISUAL SIDEBAND RESPONSE:

FREQUENCY RESPONSE VS. BRIGHTNESS:²
VISUAL MODULATION CAPABILITY:
DIFFERENTIAL GAIN:³
LINEARITY (LOW FREQUENCY):
DIFFERENTIAL PHASE:⁴
SIGNAL-TO-NOISE RATIO:
K-FACTORS:
EQUIVALENT ENVELOPE DELAY:

VIDEO INPUT:⁵
HARMONIC RADIATION:
INTERCARRIER PHASE MODULATION (noise):
HIGH FREQUENCY TRANSIENT RESPONSE, 15kHz and 250 kHz:

AURAL PERFORMANCE

POWER OUTPUT:
OUTPUT IMPEDANCE:
AUDIO INPUT:
FREQUENCY DEVIATION:
INPUT IMPEDANCE:
PRE-EMPHASIS:
FREQUENCY RESPONSE:
DISTORTION:
FM NOISE:
AM NOISE:⁶
SYNCHRONOUS AM NOISE:⁷
FREQUENCY STABILITY:⁸

SERVICE CONDITIONS

AMBIENT TEMPERATURE:
AMBIENT HUMIDITY RANGE:
ALTITUDE:
PHYSICAL AND MECHANICAL DIMENSIONS:

ELECTRICAL REQUIREMENTS:

FCC

36 kW peak.
50 ohms. Output connector: 3 1/8" EIA standard.
54-88 MHz (Channels 2-6).
±250 Hz (maximum variation over 30 days).
3% or less.
Less than 2%.
—3.58 MHz —42 dB or better.
—1.25 MHz and lower —26 dB or better.
Carrier to —0.75 MHz ±0.5 dB.
Carrier 0 dB reference.
Carrier to +4.20 MHz ±0.5 dB.
+4.75 MHz and higher —30 dB or better.
±0.75 dB.
3% or better.
3% or better.
0.5 dB or better.
±1° or better.
—53 dB or better (RMS) below sync level.
2t 2%, 12.5t less than 5% baseline disturbance.
.05 to 2.1 MHz: ± 40 ns.
at 3.58 MHz: ± 30 ns.
at 4.18 MHz: ± 60 ns.
(referenced to standard curve—FCC).
75 ohm system.
—80 dB.
(Not applicable).
(Not applicable).

7.2 kW at diplexer output.
50 ohms. Output connector: 3 1/8" EIA Std.
+10 dBm, ±2 dB.
±25 kHz.
600 ohms.
75 microseconds.
±0.5 dB rel. to pre-emphasis (30-15,000 Hz).
0.5% or less after 75 microseconds de-emphasis with ±25 kHz deviation.
—60 dB or better rel. to ±25 kHz dev.
—55 dB relative to 100% modulation.
(Not applicable).
±250 Hz.

—10° to +50°C (14° to 122°F).
0 to 95% relative humidity.
Sea level to 7500 ft.
Transmitters (2): Each 94 1/2"W x 31 1/2"D x 72"H. Weight, each 2195 lbs. Input Switcher Cabinet (1): 22 1/8"W (without side panels) x 24 3/4"D (with front and rear doors) x 72"H. Weight, 300 lbs. RF Output Switcher (1): 48"W x 34"D x 72"H. Weight, 1350 lbs. Power Supplies (2): Each 36"W x 24"D x 60 3/8"H. Weight, each 950 lbs.
Power input: 208/240 Volts, ±11 Volts, 3 phase, 50/60 Hz. Power consumption: 86 kVA, black picture; 72 kVA, average picture. Power factor: .97 typical.

¹ After initial aging of 60 days.

² Measured at 65% and 15% of modulation. Reference 100%=peak of sync.

³ Maximum variation of sub-carrier amplitude from 75% to 10% of mod. Sub-carrier mod. percentage: 10% peak to peak.

⁴ Maximum variation of sub-carrier phase with respect to burst for mod. percentage from 75% to 10%. Sub-carrier mod. percentage: 10% peak to peak.

⁵ Bridging, loop through input with —30 dB or better return loss up to 5.5 MHz.

⁶ After de-emphasis.

⁷ Rel. to 100% AM modulation at ±50 kHz deviation.

⁸ Relative to frequency offset by 4.5 MHz.

ORDERING INFORMATION

BTD-36L2 36 kW dual VHF-TV transmitter for FCC standards service, Channels 2-6, with operating tubes, semi-conductors, crystals, VSB filter, harmonic and color notch filters, input and output switchers 994-8037-001



HARRIS
COMMUNICATIONS AND
INFORMATION HANDLING

BT-35L2

35-Kilowatt VHF Low Band Color Television Transmitter

- More than a two-to-one improvement in color performance specifications
- Advanced Transversal SideBand (TSB) filter—no group delay correction, no tuning adjustments required
- IF Modulation of the visual and aural carriers for superb color and sound reproduction
- Latest design for unattended operation
- Outstanding long-term stability and reliability
- Low power consumption
- Solid-state control logic
- DC filaments on directly heated cathodes
- Less maintenance
- Modular, pre-wired cabinets for easiest installation.

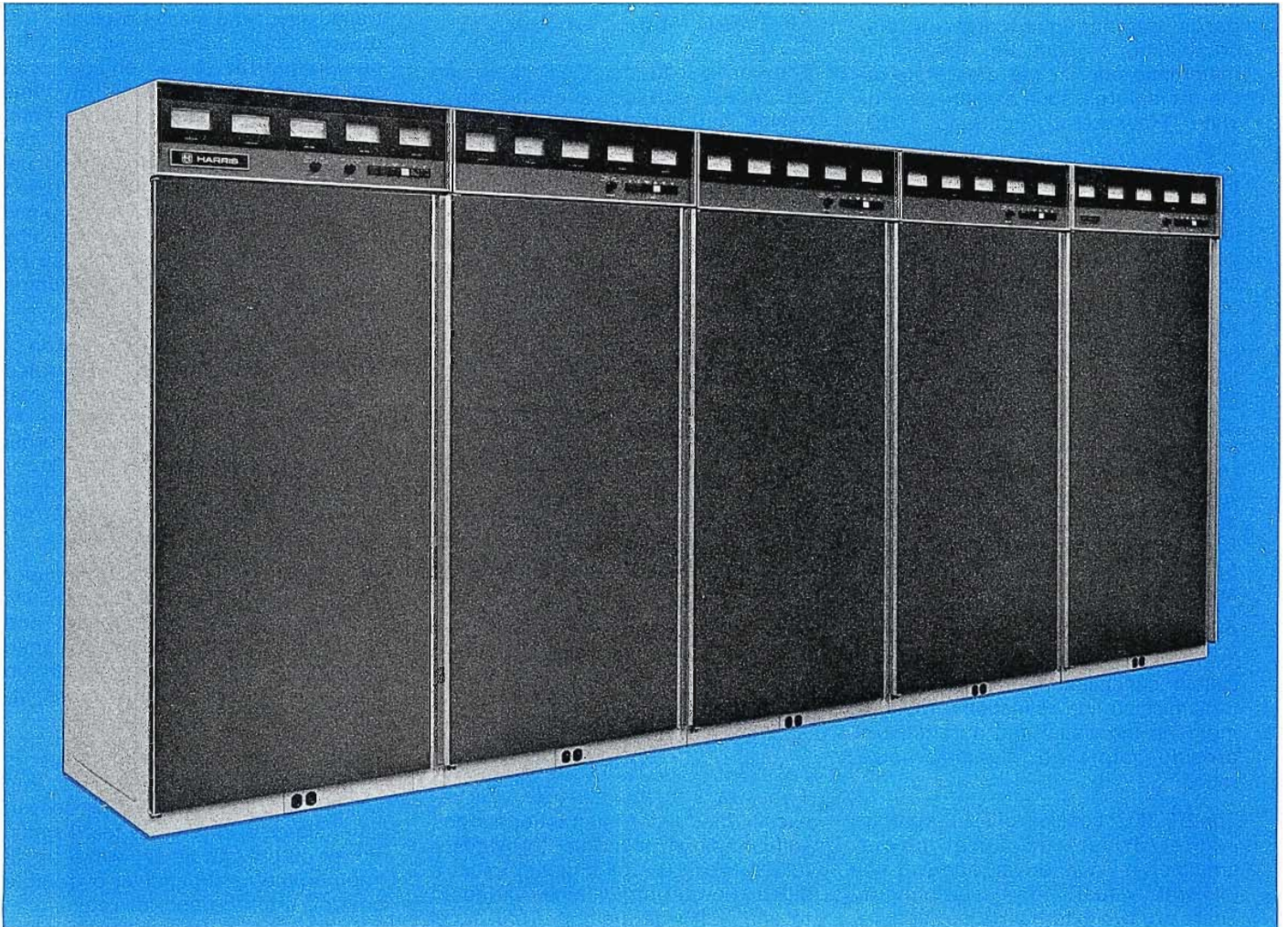

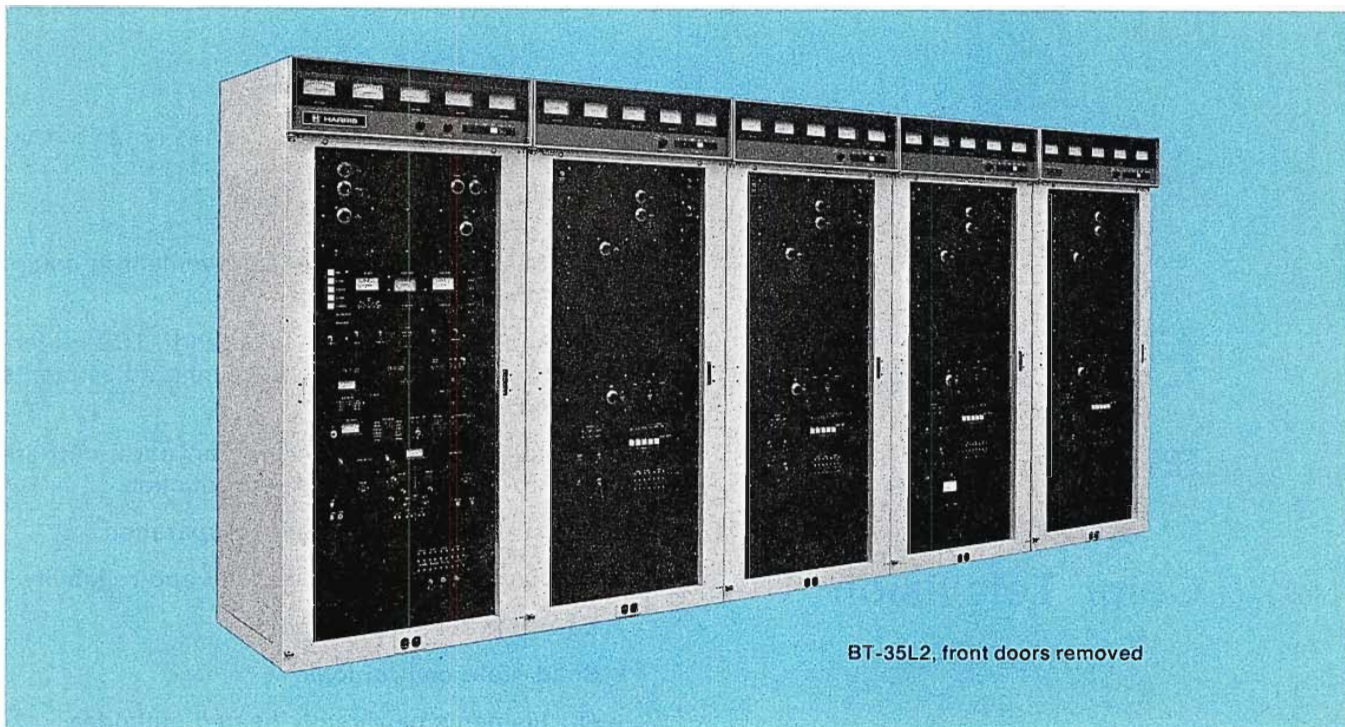

BT-35L2, front doors removed

Harris' BT-35L2 is the most advanced 35 kilowatt low band VHF television transmitter on the market. Designed to meet the high performance standards demanded by today's discriminating broadcaster, this transmitter incorporates the latest state-of-the-art features, such as Harris' solid-state Transversal SideBand (TSB) filter.

IF (intermediate frequency) Modulation, low-level sideband filtering, true linear operation of power amplifiers and solid-state visual and aural exciter/modulators combine to provide outstanding color and sound fidelity. As no envelope delay correction or adjustments are required for the VSB filter, stability, reliability and color quality are greatly enhanced. Frequency adjustment, power output control and amplifier tuning are straightforward and uncomplicated, while design simplicity and conservatively rated components in the BT-35L2 assure long-term "hands-off" operation and minimum maintenance.

Parallel visual PA's (8807's) provide for redundancy in operation and excellent cancellation of antenna and transmission line reflections. DC filaments in the visual and aural stages provide improved signal-to-noise ratios.

The BT-35L2 consists of a 1.3-kilowatt exciter/driver; an aural power amplifier; a visual driver; and two 18-kilowatt visual power amplifiers. There are two external HV power supplies. The transmitter is FCC type ac-

cepted, and meets or exceeds CCIR specifications (furnished on request).

TRANSVERSAL SIDE BAND (TSB) FILTER

The Harris solid-state VSB filter is an advanced surface acoustic wave design, and shapes visual sidebands at the IF frequency, rather than "on frequency" at the full output power of the transmitter. Unlike previous VSB filters, the TSB filter has an inherent linear phase characteristic, which means that it requires no group delay correction. Formerly, VSB filters required from 600 to 1,000 nsec of group delay correction, and many adjustments—the TSB filter requires no correction or adjustments—ever! Previous VSB filters needed 6 to 12 tuning controls—the TSB filter needs no tuning controls, as it requires no tuning adjustment—ever!

In addition, the TSB filter has steeper skirts and higher attenuation outside the channel passband for improved VSB wave shaping.

Only 1½ square inches in size, the TSB filter is mounted on a PC board in the visual exciter.

SOLID-STATE VISUAL AND AURAL EXCITER/MODULATORS

The Harris solid-state visual exciter/modulator is an independent, self-contained unit which provides a fully processed on-channel picture signal. Power output can be varied up to one watt with a single front panel control, or from a remote location,

without retuning of any kind.

The master oscillator is located in the visual exciter in a proportional controlled oven, and master oscillator frequency can be varied ± 500 Hz. With one control the station engineer can make precise frequency adjustments to both the visual and aural carriers. Actual frequency determining circuitry is also contained in the visual exciter in a proportional controlled oven. Visual modulation takes place at 37.0 MHz. Sidebands are filtered by the Harris TSB filter, which may be bypassed easily for transmitter tuning and maintenance.

The visual exciter is mounted in a pull-out drawer and may be operated outside the main transmitter for test purposes. A switch and meter mounted on the front panel permit monitoring exciter parameters. Power and video gain controls are motor driven with manual override provision.

The Harris visual exciter/modulator provides great reliability and stability, excellent frequency response, and truest color quality. It is also designed for minimum maintenance and set-up time, and for remote control and unattended operation.

The Harris aural exciter/modulator is a solid-state, self-contained unit which furnishes a fully processed aural signal at a level up to 10 watts. Power output can be set with a single knob on the front panel, or by remote control, with no need for retuning.

Audio information is used to modulate

a direct FM 32.5 MHz carrier derived from the modulated oscillator in the aural exciter. This information is then translated to the desired "on channel" signal through stable frequency determining circuitry housed in a proportional controlled oven in the visual exciter. A digital phase-locked loop is also used to guarantee absolute frequency stability.

The aural exciter/modulator is mounted in a pull-out drawer, and may be operated with the drawer extended for test purposes. The exciter has been designed for remote control and unattended operation.

IF MODULATION

One of the most important features of the BT-35L2 is its true low-level IF (intermediate frequency) Modulation, which offers a top quality picture, and excels in electrical performance, reliability and simplicity of operation.

Due to the low-level techniques, which include the use of devices such as an extremely linear broadband diode ring modulator, low-level side-band filtering and very linear broadband amplifiers, the broadcast signal is a faithful reproduction of the signal applied to the transmitter input. IF Modulation results in low incidental phase noise, and the elimination of many transmission problems at their source. This means that no half-way measures—such as numerous correction, compensation and feedback circuits—are required to eliminate the effects of these problems later on.

SOLID-STATE CONTROL LOGIC

Complete and foolproof control of all transmitter functions is achieved through the use of solid-state memory, timing and logic circuits. A

self-charging emergency power source is provided to maintain control logic memory during periods of power line failure. The solid-state control logic and protective circuitry, in addition to commanding normal AC control functions, is also used to visually indicate, through indicator lights, the operating status of the transmitter system. These indicator lights allow easy isolation of circuit faults.

AUTOMATIC RECYCLING

The BT-35L2's built-in memory circuitry enables the entire transmitter to return to the air automatically in the state it was operating immediately prior to a partial or full power failure. When the transmitter returns to "on-air", status lights provide visual indication of any malfunctions caused by the outage.

REMOTE CONTROL, UNATTENDED AND AUTOMATIC OPERATION

All control, metering and monitoring circuits have been designed specifically for remote control and unattended operation. The power controls are motor driven and the necessary remote control sampling points are built-in on accessible terminal boards. Also, Harris' transmitter design is consistent with anticipated automatic transmitter needs in the future.

POWER SUPPLIES

The HV power supplies are multiphase, full wave rectifying systems exhibiting very low ripple content prior to output filtering. They are designed for excellent regulation and low video impedance for optimum picture performance. Each power

supply, including transformer and solid-state rectifiers, is housed in a single assembly, mounted externally from the transmitter. Routine maintenance access is provided by a removable panel.

Directly heated vacuum tube filaments are fed with DC to maximize the output signal-to-noise ratio. Grid and screen supplies use solid-state regulators.

The 1300-watt driver cabinet has an independent solid-state HV power supply, and the visual and aural exciters have their own independent, solid-state, regulated power supplies.

EASE OF MAINTENANCE AND INSTALLATION

Total transmitter component accessibility is provided, front and back. Visual and aural exciters slide out and can operate independently from the transmitter outside the exciter/driver cabinet. Various exciter circuits, such as oscillators, modulators and processing circuitry, are of modular construction and can be removed for maintenance or replacement.

Easy-to-read, eye-level 4-inch meters are used to monitor required transmitter functions. Meter panels are of double-hinged construction for convenient access during maintenance. A complete system of overload indicators is also provided in each cabinet for monitoring transmitter operation. In the event of a transmitter malfunction, an examination of the indicators will locate the problem area.

The transmitter has been built in a modular fashion so that cabinets may be separated into convenient, easy-to-handle sub-assemblies to facilitate installation.

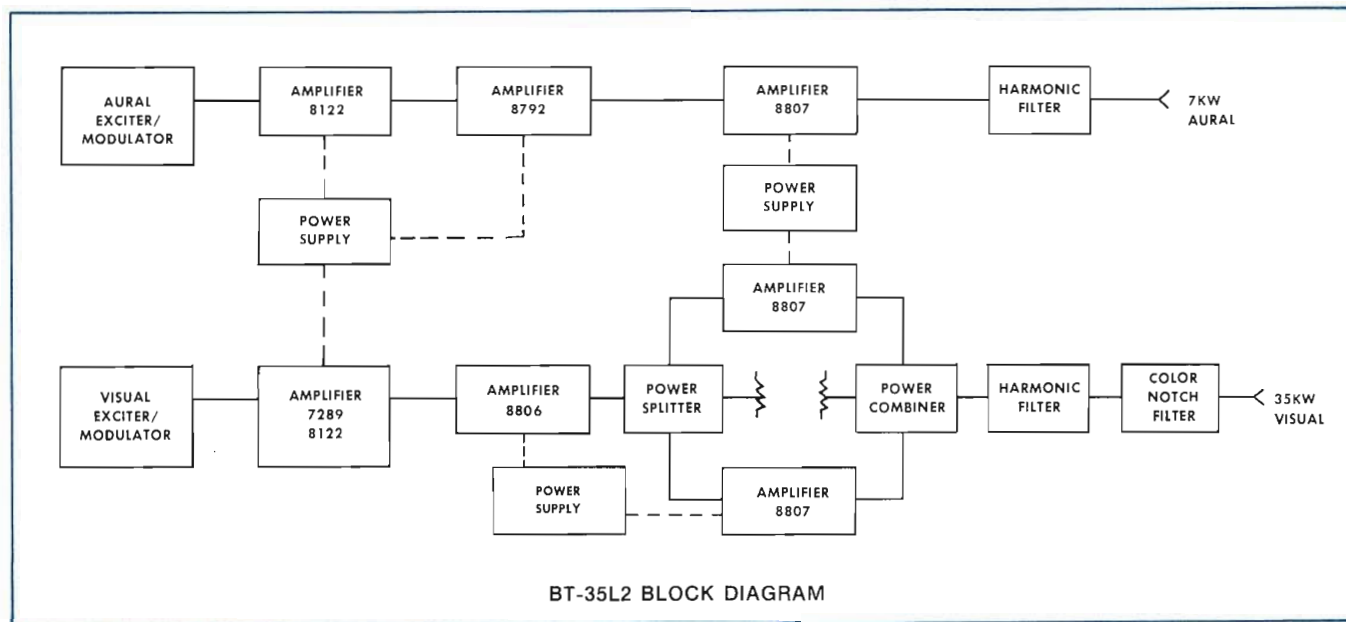

BT-35L2 SPECIFICATIONS

VISUAL PERFORMANCE

POWER OUTPUT: 35 kW peak.
OUTPUT IMPEDANCE: 50 ohms. Output connector: 3/8" EIA standard.
FREQUENCY RANGE: 54-88 MHz (Channels 2-6).
CARRIER STABILITY:¹ ±250 Hz (maximum variation over 30 days).
REG. OF RF OUTPUT POWER (Black to white pic.): 3% or less.
VARIATION OF OUTPUT (over one frame): Less than 2%.
VISUAL SIDEBAND RESPONSE: -3.58 MHz -42 dB or better
-1.25 MHz and lower -26 dB or better
Carrier to -0.75 MHz ±0.5 dB
Carrier 0 dB reference
Carrier to +4.20 MHz ±0.5 dB
+4.75 MHz and higher -30 dB or better

FREQUENCY RESPONSE VS. BRIGHTNESS:² ±0.75 dB.
VISUAL MODULATION CAPABILITY: 3% or better.
DIFFERENTIAL GAIN:³ 3% or better.
LINEARITY (LOW FREQUENCY): 1.0 dB or better
DIFFERENTIAL PHASE:⁴ ±1° or better.
SIGNAL-TO-NOISE RATIO: -53 dB or better (RMS) below sync level.
K FACTORS: 2t 2%, 12.5t less than 5% baseline disturbance.
EQUIVALENT ENVELOPE DELAY: .05 to 2.1 MHz: ±40 ns
at 3.58 MHz: ±30 ns
at 4.18 MHz: ±60 ns
(referenced to standard curve—FCC).

VIDEO INPUT:⁵ 75 ohm system.
HARMONIC RADIATION: -80 dB.

AURAL PERFORMANCE

POWER OUTPUT: 7kW at diplexer output.
OUTPUT IMPEDANCE: 50 ohms. Output connector: 3/8" EIA Std.
AUDIO INPUT: +10 dBm, ±2 dB.
FREQUENCY DEVIATION: ±25 kHz.
INPUT IMPEDANCE: 600 ohms.
PRE-EMPHASIS: 75 microseconds.
FREQUENCY RESPONSE: ±0.5 dB rel. to pre-emphasis (30-15,000 Hz).
DISTORTION: 0.5% or less after 75 microseconds de-emphasis with ±25 kHz deviation.

FM NOISE: -60 dB or better rel. to ±25 kHz dev.
AM NOISE:⁶ -55 dB relative to 100% modulation.
FREQUENCY STABILITY:⁷ ±250 Hz.

SERVICE CONDITIONS

AMBIENT TEMPERATURE: -10° to +50°C (14° to 122°F).
AMBIENT HUMIDITY RANGE: 0 to 95% relative humidity.
ALTITUDE: Sea level to 7500 ft.
PHYSICAL AND MECHANICAL DIMENSIONS: 157 1/2"W x 31 1/2"D x 72"H. Weight: 4,415 lbs. Power Supplies (2): each 36"W x 24"D x 60"H. Weight each: 950 lbs.
ELECTRICAL REQUIREMENTS: Power input: 208/230/380 volts, ±11 volts, 3 phase, 50/60 Hz. Power consumption: 82 kVA, black picture; 68 kVA, average picture. Power factor: .95 typical.

SPECIFICATIONS SUBJECT TO CHANGE WITHOUT NOTICE.

- ¹ After initial aging of 60 days.
² Measured at 65% and 15% of modulation. Reference 100% = peak of sync.
³ Maximum variation of sub-carrier amplitude from 75% to 10% of mod. Sub-Carrier mod. percentage: 10% peak to peak.
⁴ Maximum variation of sub-carrier phase with respect to burst for mod. percentage from 75% to 10%. Sub carrier mod. percentage: 10% peak to peak.
⁵ Bridging, loop through input with -30 dB or better return loss up to 5.5 MHz.
⁶ After de-emphasis.
⁷ Relative to frequency offset by 4.5 MHz from the visual carrier.

ORDERING INFORMATION

BT-35L2 35 kW VHF-TV transmitter for FCC standards service, Channels 2-6, with operating tubes, semi-conductors, crystals, VSB filter, color notch filter and harmonic filters 994-8032-001



HARRIS
COMMUNICATIONS AND
INFORMATION HANDLING

BT-25L2

**25-Kilowatt VHF
Low Band
Color Television
Transmitter**

- Advanced Transversal SideBand filter — no group delay, no tuning adjustments required
- IF Modulation of the visual and aural carriers for superb color and sound reproduction
- Latest design for unattended operation
- Outstanding long-term stability and reliability
- Low power consumption
- Simple solid-state logic control
- DC filaments on directly heated cathodes
- Less maintenance
- Modular, pre-wired cabinets for easiest installation





BT-25L2, front view, doors off.

UNSURPASSED PERFORMANCE

Harris' BT-25L2 is the most advanced 25-kilowatt low band VHF television transmitter on the market. Designed to meet the high performance standards demanded by today's discriminating broadcaster, this transmitter incorporates the latest state-of-the-art features, such as Harris' solid-state Transversal SideBand (TSB) filter.

IF (intermediate frequency) Modulation, low-level sideband filtering, true linear operation of power amplifiers and solid-state visual and aural exciter/modulators combine to provide outstanding color and sound fidelity. As no envelope delay correction or adjustments are required for the VSB filter, stability, reliability and color quality are greatly enhanced. Frequency adjustment, power output control and amplifier tuning are straightforward and uncomplicated, while design simplicity and conservatively rated com-

ponents in the BT-25L2 assure long-term "hands-off" operation and minimum maintenance.

Low power consumption and a more compact transmitter design result from the use of a single ended visual PA (8916 tetrode). DC filaments in the visual and aural stages provide improved signal-to-noise ratios.

The BT-25L2 consists of a 1.3 kilowatt exciter/driver, an aural power amplifier, a visual power amplifier, and an external HV power supply. It is FCC type accepted, and meets or exceeds CCIR specifications. Complete factory testing assures performance to specifications.

TRANSVERSAL SIDE BAND (TSB) FILTER

The Harris solid-state VSB filter is an ad-

vanced surface acoustic wave design, and shapes visual sidebands at the IF frequency, rather than "on frequency" at the full output power of the transmitter. Unlike conventional VSB filters, the TSB filter has an inherent linear phase characteristic, which means that it requires no group delay correction. A conventional VSB filter requires from 600 to 1000 nsec of group delay correction, and many adjustments—the TSB filter requires no correction or adjustments—ever! A conventional VSB filter needs 6 to 12 tuning controls—the TSB filter needs no tuning controls, as it requires no tuning adjustment ever!

In addition, the TSB filter has steeper skirts and higher attenuation outside the channel passband for improved VSB wave shaping.

Only 1½ square inches in size, the TSB filter is mounted on a PC board in the visual exciter.

ADVANCE-DESIGN VISUAL AND AURAL EXCITER/MODULATORS

The Harris solid-state MCP visual exciter/modulator is an independent, self-contained unit which provides a fully processed on-channel picture signal. Power output can be varied up to one watt with a single front panel control, or from a remote location, without retuning of any kind.

The master oscillator is located in the visual exciter in a proportional controlled oven, and master oscillator frequency can be varied ± 500 Hz. With one control the station engineer can make precise frequency adjustments to both the visual and aural carriers. Actual frequency determining circuitry is also contained in the visual exciter in a proportional controlled oven. Visual modulation takes place at 37.0 MHz (38.9 MHz for CCIR B). Sidebands are filtered by the Harris TSB filter, which may be bypassed easily for transmitter tuning and maintenance.

The visual exciter is mounted in a pull-out drawer and may be operated outside the main transmitter for test purposes. A switch and meter mounted on the front panel permit monitoring exciter parameters. Power and video gain controls are motor driven with manual override provision.

The Harris visual exciter/modulator provides great reliability and stability, excellent frequency response, and truest color quality. It is also designed for minimum maintenance and set-up time, and for remote control and unattended operation. This is all made possible through the use of the latest design techniques, including Harris' solid-state TSB filter.

The Harris aural exciter/modulator is a solid-state self-contained unit which furnishes a fully processed aural signal at a level up to 10 watts. Power output can be set with a single knob on the front panel, or by remote control, with no need for retuning.

Audio information is used to modulate a direct FM 32.5 MHz (33.4 MHz for CCIR B) carrier derived from the modulated oscillator in the aural exciter. This information is then translated to the desired "on channel" signal through stable frequency determining circuitry housed in a proportional controlled oven in the visual exciter. A digital phase-locked loop is also used to guarantee absolute frequency stability.

The aural exciter/modulator is mounted in a pull-out drawer, and may be operated with the drawer extended for test purposes. The exciter has been designed for remote control and unattended operation.

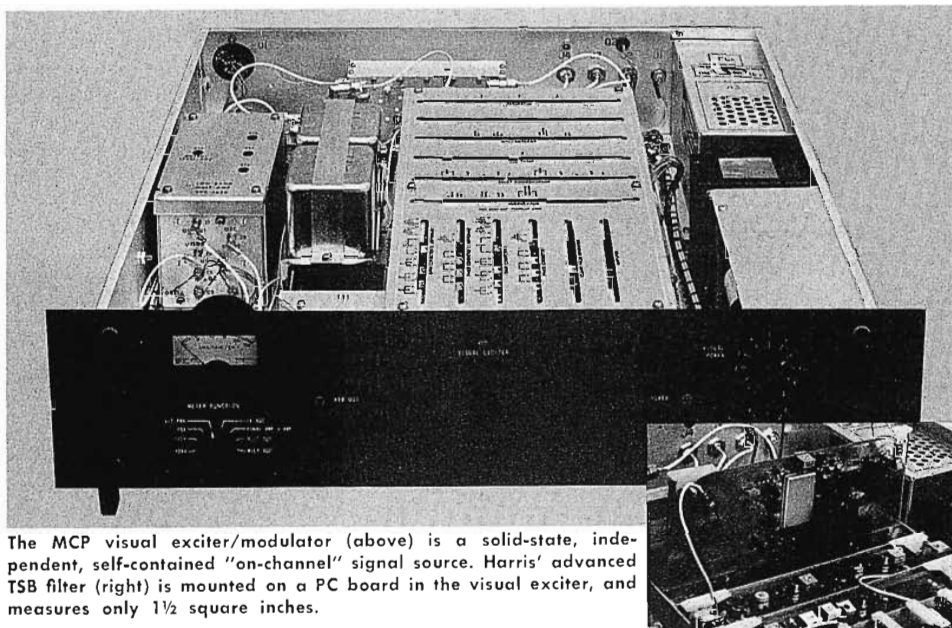

The MCP visual exciter/modulator (above) is a solid-state, independent, self-contained "on-channel" signal source. Harris' advanced TSB filter (right) is mounted on a PC board in the visual exciter, and measures only 1½ square inches.

IF MODULATION

One of the most important features of the BT-25L2 is its true low-level IF Modulation, which offers a top quality picture, and excels in electrical performance, reliability and simplicity of operation.

In the BT-25L2 the visual and aural exciters generate fully modulated low-level IF signals. The output of a common crystal controlled reference oscillator is used to raise the individual IF signal to the desired "on channel" output frequency.

As it occurs at much lower power levels than conventional designs, intermediate frequency modulation needs fewer circuits to produce a fully processed, quality picture signal. Less than one volt of video signal is needed to modulate the RF carrier.

The Harris ring modulator design permits modulation percentages to approximately 2% without compromising transmitter performance—and eliminates most pre-distortion circuitry. This results in exceptional color performance and nearly perfect signal linearity. Even such colors as highly saturated yellow and cyan are faithfully reproduced with IF Modulation.

Due to the low-level techniques, which include the use of devices such as an extremely linear broadband diode ring modulator, low-level sideband filtering and very linear broadband amplifiers, the broadcast signal is a faithful reproduction of the signal applied to the transmitter input. IF Modulation results in low incidental phase noise, and the elimination of many transmission problems at their source. This means that no half-way measures—such as numerous correction, compensation and feedback circuits—are

required to eliminate the effects of these problems later on.

SOLID-STATE CONTROL LOGIC

Complete and foolproof control of all transmitter functions is achieved through the use of solid-state memory, timing and logic circuits. A self-charging emergency power source is provided to maintain control logic memory during periods of power line failure.

The solid-state control logic and protective circuitry, in addition to commanding normal AC control functions, is also used to visually indicate, through indicator lights, the operating status of the transmitter system. These indicator lights allow easy isolation of circuit faults.

AUTOMATIC RECYCLING

The BT-25L2's built-in memory circuitry enables the entire transmitter to return to the air automatically in the stage it was operating immediately prior to a partial or full power failure. When the transmitter returns to "on-air", status lights provide visual indication of any malfunctions caused by the outage.

REMOTE CONTROL, UNATTENDED AND AUTOMATIC OPERATION

All control, metering and monitoring circuits have been designed specifically for remote control and unattended operation. The power controls are motor driven and the necessary remote control sampling points are built-in on accessible terminal boards.

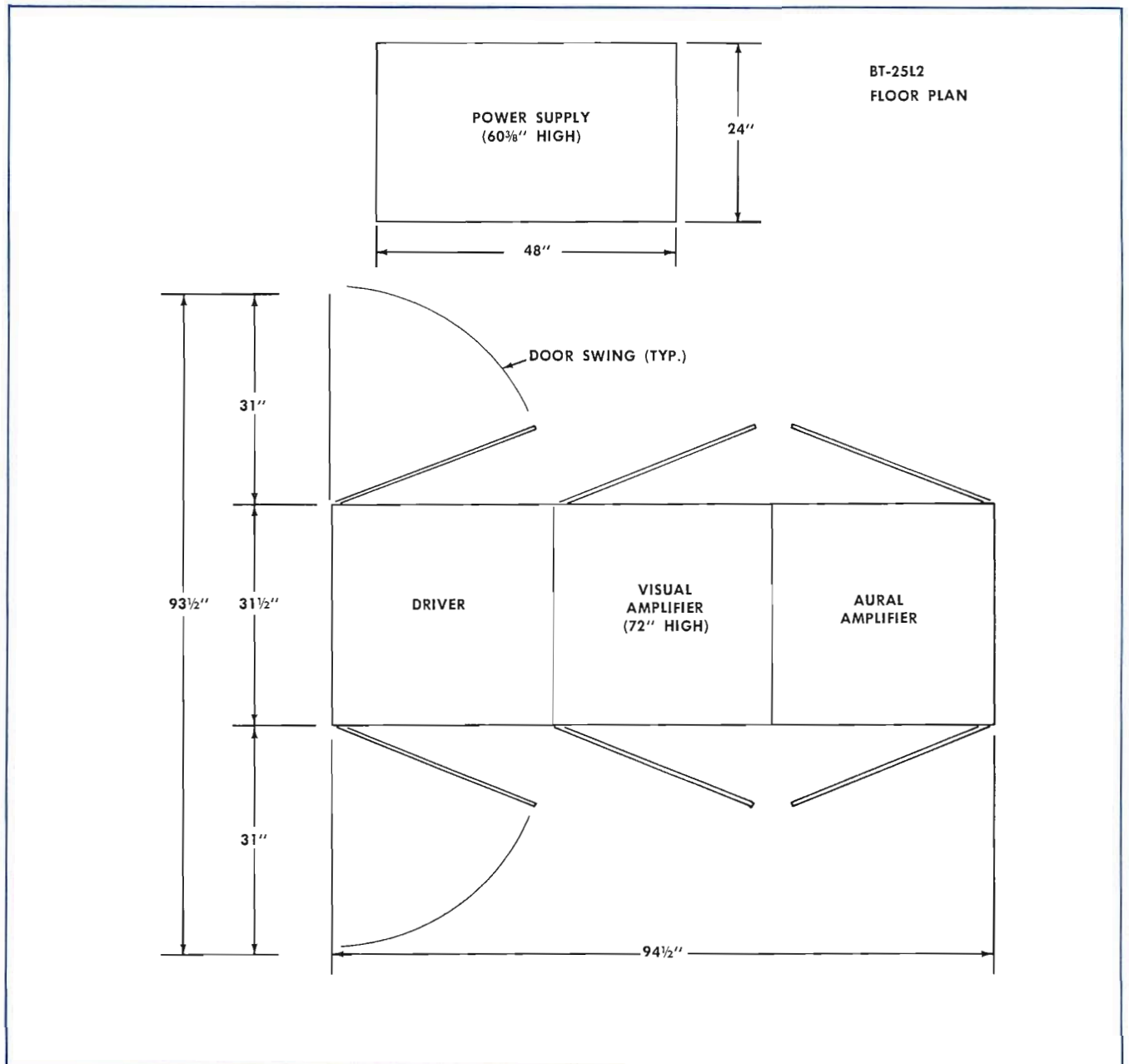
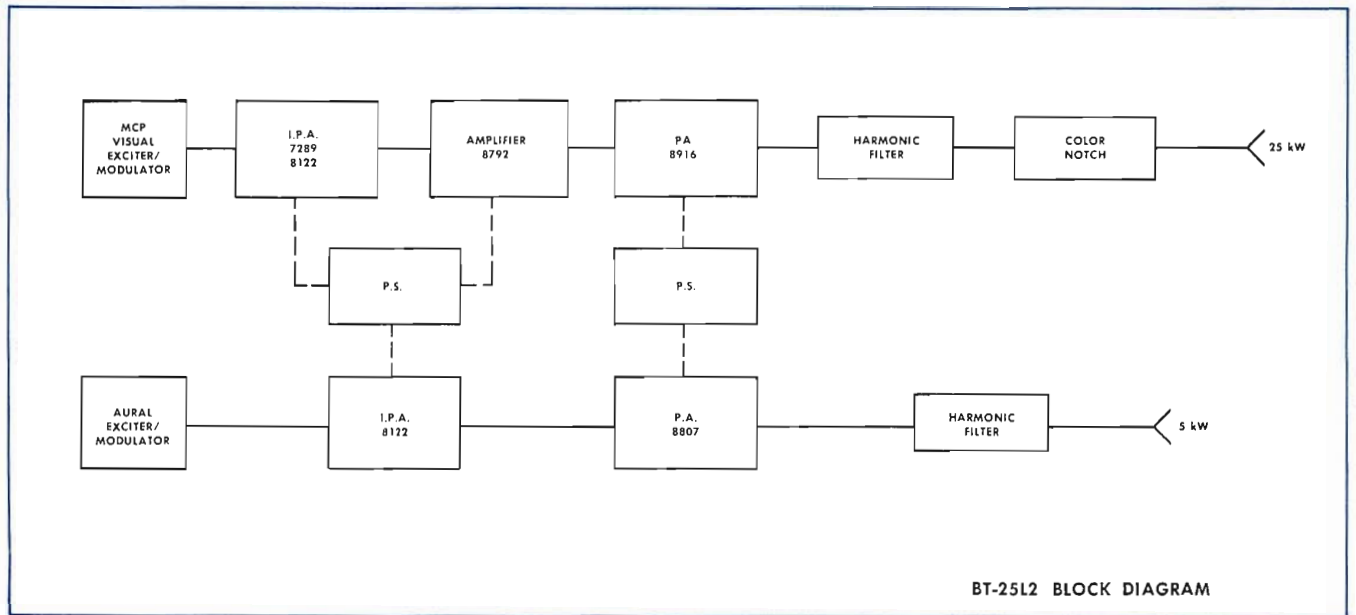

BT-25L2 SPECIFICATIONS

FCC

VISUAL PERFORMANCE

POWER OUTPUT:
 OUTPUT IMPEDANCE:
 FREQUENCY RANGE:
 CARRIER STABILITY:¹
 REG. OF RF OUTPUT POWER (Black to white pic.):
 VARIATION OF OUTPUT (over one frame):
 VISUAL SIDEBAND RESPONSE:

25 kW peak.
 50 ohms. Output connector: 3/8" EIA standard.
 54-88 MHz (Channels 2-6).
 ± 250 Hz (maximum variation over 30 days).
 3% or less.
 Less than 2%.
 -3.58 MHz ----- -42 dB or better
 -1.25 MHz and lower ----- -26 dB or better
 Carrier to -0.75 MHz ----- ± 0.5 dB
 Carrier ----- 0 dB reference
 Carrier to +4.20 MHz ----- ± 0.5 dB
 +4.75 MHz and higher ----- -30 dB or better

FREQUENCY RESPONSE VS. BRIGHTNESS:²
 VISUAL MODULATION CAPABILITY:
 DIFFERENTIAL GAIN:³
 LINEARITY (LOW FREQUENCY):

± 0.75 dB.
 3% or better.
 3% or better.
 0.5 dB or better.

DIFFERENTIAL PHASE:⁴
 SIGNAL-TO-NOISE RATIO:
 K FACTORS:
 EQUIVALENT ENVELOPE DELAY:

$\pm 1^\circ$ or better.
 -55 dB or better (RMS) below sync level.
 2 \pm 2%, 12.5 \pm less than 5% baseline disturbance.
 .05 to 2.1 MHz: ± 40 ns
 at 3.58 MHz: ± 30 ns
 at 4.18 MHz: ± 60 ns
 (referenced to standard curve—FCC)

VIDEO INPUT:⁵
 HARMONIC RADIATION:
 INTERCARRIER PHASE MODULATION (noise):
 HIGH FREQUENCY TRANSIENT RESPONSE,
 15 kHz and 250 kHz:

75 ohm system.
 -80 dB.
 (Not applicable).
 (Not applicable).

AURAL PERFORMANCE

POWER OUTPUT:
 OUTPUT IMPEDANCE:
 AUDIO INPUT:
 FREQUENCY DEVIATION:
 INPUT IMPEDANCE:
 PRE-EMPHASIS:
 FREQUENCY RESPONSE:
 DISTORTION:

5 kW at diplexer output.
 50 ohms. Output connector: 3/8" EIA Std.
 +10 dBm, ± 2 dB.
 ± 25 kHz.
 600 ohms.
 75 microseconds.
 ± 0.5 dB rel. to pre-emphasis (30-15,000 Hz).
 0.5% or less after 75 microseconds de-emphasis
 with ± 25 kHz deviation.

FM NOISE:
 AM NOISE:⁶
 SYNCHRONOUS AM NOISE:⁷
 FREQUENCY STABILITY:⁸

-60 dB or better rel. to ± 25 kHz dev.
 -55 dB relative to 100% modulation.
 (Not applicable).
 ± 250 Hz.

SERVICE CONDITIONS

AMBIENT TEMPERATURE:
 AMBIENT HUMIDITY RANGE:
 ALTITUDE:
 PHYSICAL AND MECHANICAL DIMENSIONS:

-10° to +50°C (14° to 122°F).
 0 to 95% relative humidity.
 Sea level to 7500 ft.
 94 1/2" W x 31 1/2" D x 72" H. Weight: 2195 lbs.
 Power supply: 48" W x 24" D x 60 3/8" H.
 Weight: 1475 lbs.

ELECTRICAL REQUIREMENTS:

Power input: 208/240 Volts, ± 11 Volts, 3 phase,
 50/60 Hz. Power consumption: 57 kVA, black
 picture; 49 kVA, average picture. Power factor:
 .96 typical.

CCIR (System "B")

21 kW peak.
 50 ohms. Output connector: 3/8" EIA standard.
 54-68 MHz (Channels 3 and 4, Band 1).
 ± 250 Hz (maximum variation over 30 days).
 3% or less.
 Less than 2%.
 -4.43 MHz ----- -30 dB or better
 -1.25 MHz ----- -26 dB or better
 -0.75 MHz ----- +0.5, -3 dB
 -0.50 MHz ----- +0.5, -1 dB
 Carrier ----- +0.5, -0.5 dB
 +1.5 MHz ----- Reference
 +3.0 MHz ----- ± 0.5 dB
 +4.43 MHz ----- +0.5, -1 dB
 +5.0 MHz ----- +0.5, -2.5 dB
 +5.5 MHz ----- -26 dB or better
 ± 0.75 dB.
 3% or better.
 3% or better.
 Amplitude dev. 9min/5 max better than 0.85 mod.
 with signal No. 3 CCIR, from 10% to 85% in
 frequency range 1 to 5 MHz.
 $\pm 1^\circ$ or better.
 -40 dB pp below black to white transition.
 2 \pm 2%, 20 \pm 3% or better.
 up to 4.5 MHz: ± 50 ns.
 from 4.5 MHz to 4.8 MHz: ± 100 ns.
 (measured with Nyquist demodulator meeting ARD
 specifications).
 75 ohm system.
 -80 dB.
 -40 dB or better with ref. to ± 50 kHz dev.
 ± 75 ns -10% ± 200 ns +7%
 ± 100 ns +11% ± 400 -1000 ns $\pm 5\%$
 400-1000 ns $\pm 3\%$ for LF variation

Up to 5 kW at diplexer output.
 50 ohms. Output connector: 3/8" EIA Std.
 +10 dBm, ± 2 dB.
 ± 50 kHz.
 600 ohms.
 50 microseconds ± 5 microseconds.
 ± 0.5 dB rel. to pre-emphasis (30-15,000 Hz).
 Less than 1% from 30 to 15,000 Hz with ± 50
 kHz dev. (Less than twice measured amount at
 70 kHz deviation).
 -60 dB or better rel. to ± 50 kHz dev.
 -55 dB relative to 100% modulation.
 -40 dB or better.
 ± 250 Hz.

-10° to +50°C.
 0 to 95% relative humidity.
 Sea level to 2400 meters.
 240cm W x 80cm D x 183cm H. Weight: 998 kg.
 Power supply: 122cm W x 61cm D x 153cm H.
 Weight: 670 kg.
 Power input: 380/415 Volts, 3 phase, 50/60 Hz.
 Power consumption: 53 kVA, black picture; 45
 kVA, average picture (10:1 vision to sound ra-
 tio). Power factor: .96 typical.

¹ After initial aging of 60 days.

² Measured at 65% and 15% of modulation. Reference 100% = peak of sync.

³ Maximum variation of sub-carrier amplitude from 75% to 10% of mod. Sub-carrier mod. percentage: 10% peak to peak.

⁴ Maximum variation of sub-carrier phase with respect to burst for mod. percentage from 75% to 10%. Sub-carrier mod. percentage: 10% peak to peak.

⁵ Bridging, loop through input with -30 dB or better return loss up to 5.5 MHz.

⁶ After de-emphasis.

⁷ Rel. to 100% AM modulation at ± 50 kHz deviation.

⁸ Relative to frequency offset by 4.5 MHz (FCC), 5.5 MHz (CCIR) from the visual carrier.

ORDERING INFORMATION

BT-25L2 25 kW VHF-TV transmitter for FCC standards service, Channels 2-6, with operating tubes, transistors, IC's, solid-state rectifiers, crystals, required pre-correction circuitry, low-level vestigial sideband filter, harmonic and color notch filters ----- 994-8030-001

BT-25L2 21 kW VHF-TV transmitter for CCIR System "B" service, 54 to 68 MHz [Band I], 380/415 volts, 50/60 Hz, equipped as above ----- 994-8030-003



HARRIS
COMMUNICATIONS AND
INFORMATION HANDLING

BT-18L2

18-Kilowatt VHF Low Band Color Television Transmitter

- More than a two-to-one improvement in color performance specifications
- Advanced Transversal SideBand (TSB) filter—no group delay correction, no tuning adjustments required
- IF Modulation of the visual and aural carriers for superb color and sound reproduction
- Latest design for unattended operation
- Outstanding long-term stability and reliability
- Low power consumption
- Simple solid-state logic control
- DC filaments on directly heated cathodes
- Less maintenance
- Modular, pre-wired cabinets for easiest installation

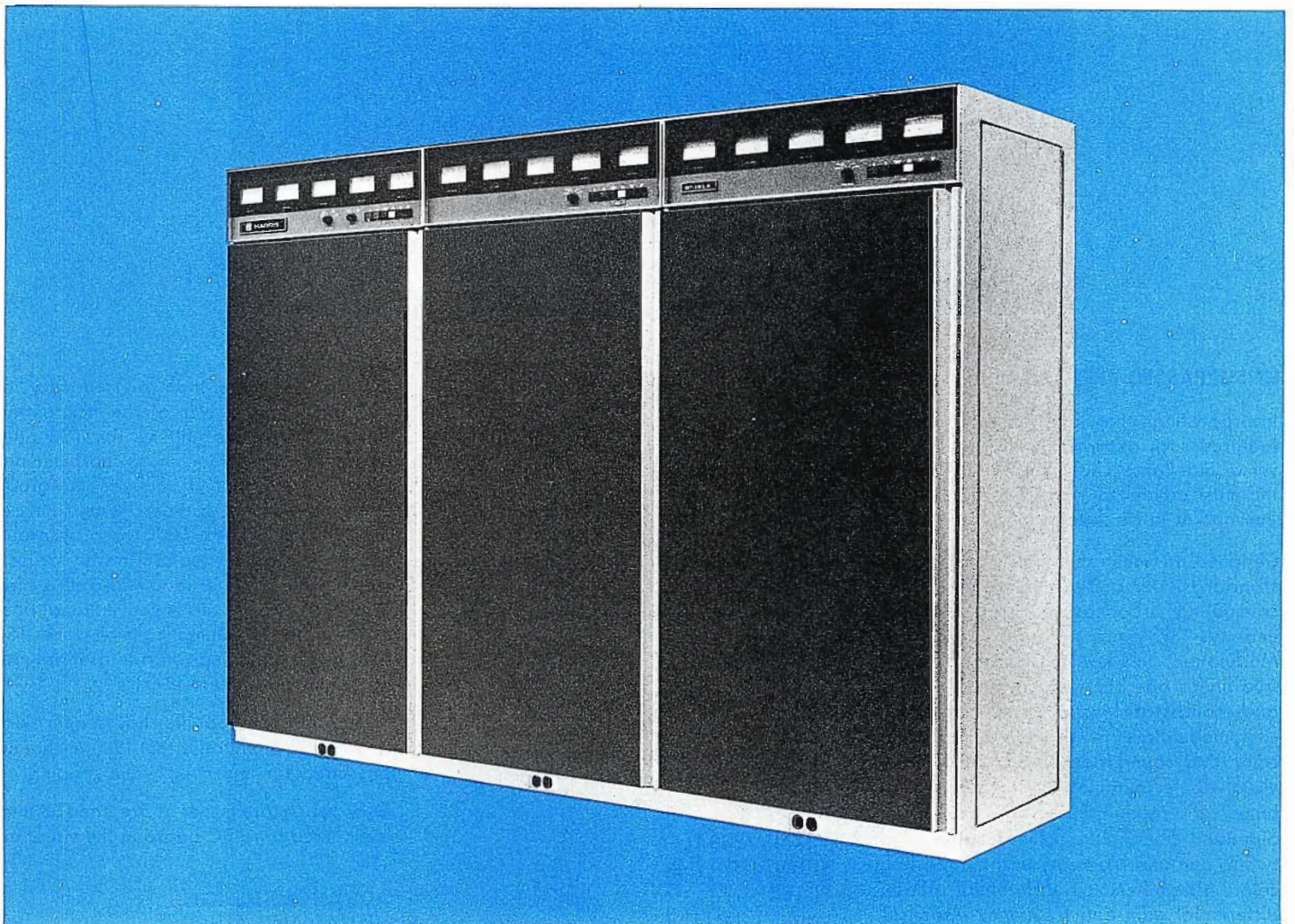

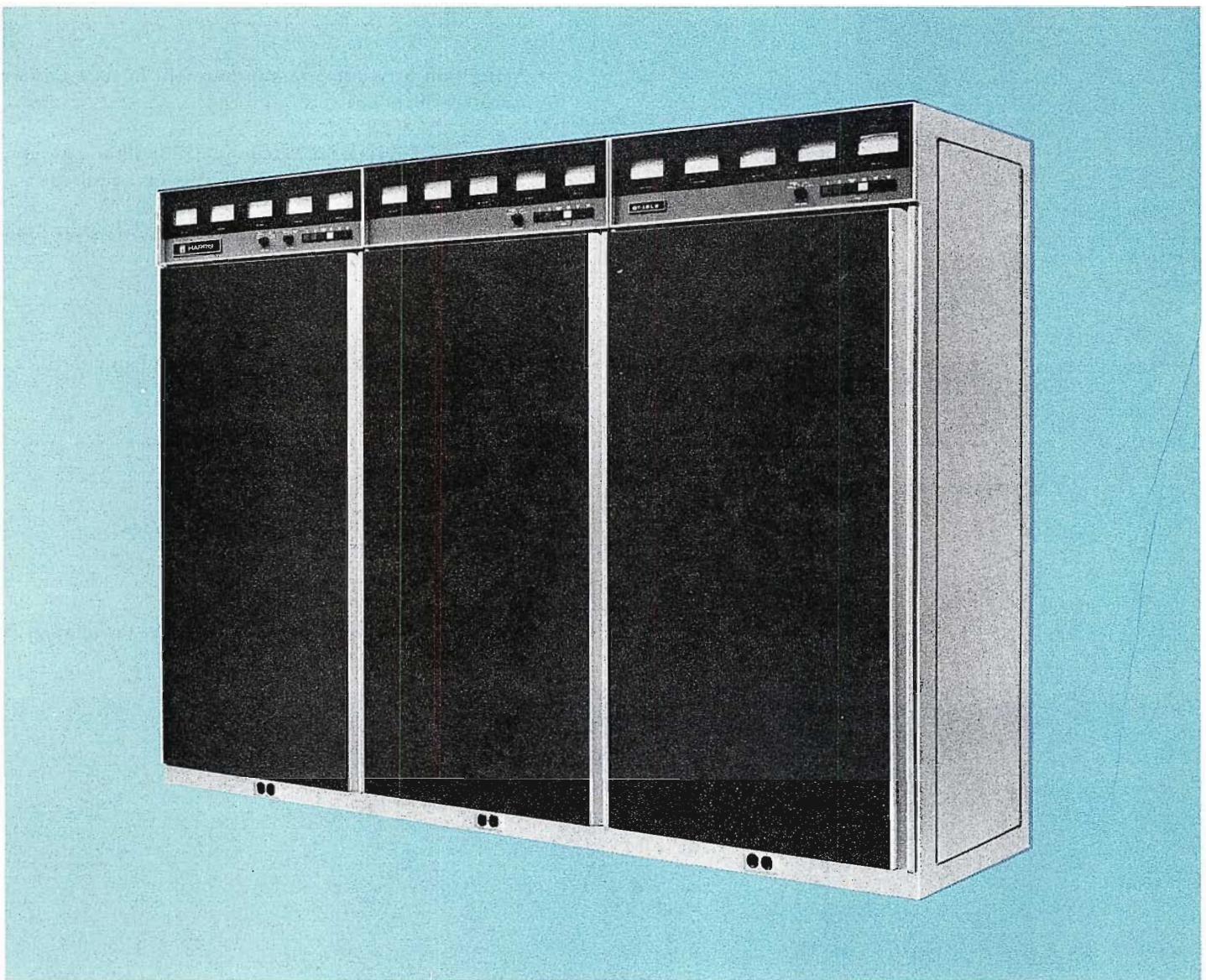

UNSURPASSED PERFORMANCE

Incorporating the latest state-of-the-art features, such as Harris' solid-state Transversal SideBand (TSB) filter, the BT-18L2 is the most advanced VHF-TV transmitter on the market in its power range.

Designed to meet the high performance standards demanded by today's discriminating broadcaster, Harris' BT-18L2 employs IF (intermediate frequency) Modulation, low-level sideband filtering, true linear operation of power amplifiers and solid-state visual and aural exciter/modulators to provide outstanding color and sound fidelity. In the MCP-TV visual exciter/modulator, Harris has combined IF Modulation and Transversal SideBand filtering to achieve better than two-to-one improvements in the important color parameters of differential phase, differential gain and frequency response!

Frequency adjustment, power output control and amplifier tuning are straight-

forward and uncomplicated, while design simplicity and conservatively rated components in the transmitter assure long-term "hands-off" operation and minimum maintenance.

Low power consumption and a more compact transmitter design result from the use of a single ended visual PA (8807 tetrode). DC filaments in the visual and aural stages provide improved signal-to-noise ratios.

The BT-18L2 consists of a 1.3 kilowatt exciter/driver, an aural power amplifier, a visual power amplifier, and an external HV power supply. It is FCC type accepted, and meets or exceeds CCIR specifications. Complete factory testing assures performance to specifications.

TRANSVERSAL SIDE BAND (TSB) FILTER

The Harris solid-state vestigial sideband filter is an advanced surface acoustic wave design, and shapes visual sidebands at the

IF frequency, rather than "on frequency" at the full output power of the transmitter. Unlike conventional filters, the TSB filter has an inherent linear phase characteristic, which means that it requires no group delay correction. An older model filter requires from 600 to 1000 nsec of group delay correction, and many adjustments—the TSB filter requires no correction or adjustments—ever! A conventional filter needs 6 to 12 tuning controls—the TSB filter needs no tuning controls, as it requires no tuning adjustment ever!

In addition, the TSB filter has steeper skirts and higher attenuation outside the channel passband for improved wave shaping.

Only 1 1/2 square inches in size, the TSB filter is mounted on a PC board in the visual exciter.

ADVANCED-DESIGN VISUAL AND AURAL EXCITER-MODULATORS

The Harris solid-state maximum color per-

formance MCP-1V visual exciter/modulator is an independent, self-contained unit which provides a fully processed on-channel signal. Combining IF Modulation and recent breakthroughs in filtering technology, the MCP-1V offers the best color performance specifications ever offered in VHF-TV transmitting equipment!

Power output of the visual exciter/modulator can be varied with a single front panel control, or from a remote location, without retuning of any kind.

The master oscillator is located in the visual exciter in a proportional controlled oven, and master oscillator frequency can be varied ± 500 Hz. With one control the station engineer can make precise frequency adjustments to both the visual and aural carriers. Actual frequency determining circuitry is also contained in the visual exciter in a proportional controlled oven. Visual modulation takes place at 37.0 MHz (38.9 MHz for CCIR B). Sidebands are filtered by the Harris TSB filter, which may be bypassed easily for transmitter tuning and maintenance.

The visual exciter is mounted in a pull-out drawer and may be operated outside the main transmitter for test purposes. A switch and meter mounted on the front panel permit monitoring exciter parameters. Power and video gain controls are motor driven with manual override provision.

The Harris visual exciter/modulator provides great reliability and stability, excellent frequency response, and truest color quality. It is also designed for minimum maintenance and set-up time, and for remote control and unattended operation. This is all made possible through the use of the latest design techniques, including Harris' solid-state TSB filter.

The Harris aural exciter/modulator is a solid-state self-contained unit which furnishes a fully processed aural signal at a level up to 10 watts. Power output can be set with a single knob on the front panel, or by remote control, with no need for retuning.

Audio information is used to modulate a direct FM 32.5 MHz (33.4 MHz for CCIR B) carrier derived from the modulated oscillator in the aural exciter. This information is then translated to the desired "on channel" signal through stable frequency determining circuitry housed in a proportional controlled oven in the visual exciter. A digital phase-locked loop is also used to guarantee absolute frequency stability.

The aural exciter/modulator is mounted in a pull-out drawer, and may be operated with the drawer extended for test purposes. The exciter has been designed for remote control and unattended operation.

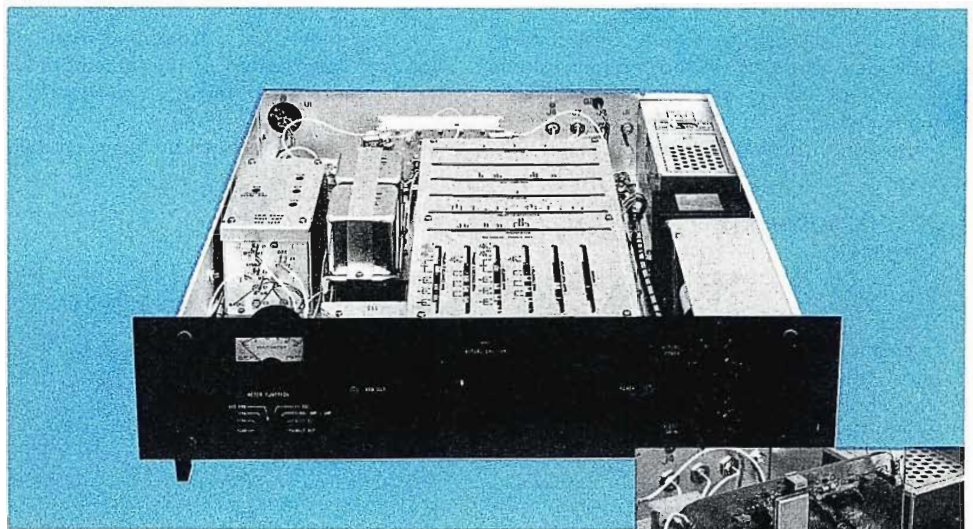

The MCP-1V visual exciter/modulator (above) is a solid-state, independent, self-contained "on-channel" signal source. Harris' advanced TSB filter (right) is mounted on a PC board in the visual exciter, and measures only 1½ square inches.

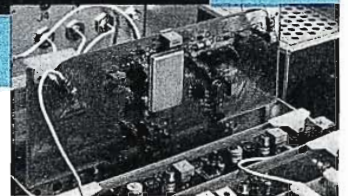

IF MODULATION

One of the most important features of the BT-18L2 is its true low-level IF Modulation, which offers a top quality picture, and excels in electrical performance, reliability and simplicity of operation.

In the BT-18L2 the visual and aural exciters generate fully modulated low-level IF signals. The output of a common crystal controlled reference oscillator is used to raise the individual IF signal to the desired "on channel" output frequency.

As it occurs at much lower power levels than older designs, intermediate frequency modulation needs fewer circuits to produce a fully processed, quality picture signal. Less than one volt of video signal is needed to modulate the RF carrier.

The Harris ring modulator design permits modulation percentages to approximately 2% without compromising transmitter performance—and eliminates most predistortion circuitry. This results in exceptional color performance and nearly perfect signal linearity. Even such colors as highly saturated yellow and cyan are faithfully reproduced with IF Modulation.

Due to the low-level techniques, which include the use of devices such as an extremely linear broadband diode ring modulator, low-level sideband filtering and very linear broadband amplifiers, the broadcast signal is a faithful reproduction of the signal applied to the transmitter input. IF Modulation results in low incidental phase noise, and the elimination of many transmission problems at their source. This means that no half-way measures—such as numerous correction, compensation and

feedback circuits—are required to eliminate the effects of these problems later on.

SOLID-STATE CONTROL LOGIC

Complete and foolproof control of all transmitter functions is achieved through the use of solid-state memory, timing and logic circuits. A self-charging emergency power source is provided to maintain control logic memory during periods of power line failure.

The solid-state control logic and protective circuitry, in addition to commanding normal AC control functions, is also used to visually indicate, through indicator lights, the operating status of the transmitter system. These indicator lights allow easy isolation of circuit faults.

AUTOMATIC RECYCLING

The BT-18L2's built-in memory circuitry enables the entire transmitter to return to the air automatically in the state it was operating immediately prior to a partial or full power failure. When the transmitter returns to "on-air", status lights provide visual indication of any malfunctions caused by the outage.

REMOTE CONTROL, UNATTENDED AND AUTOMATIC OPERATION

All control, metering and monitoring circuits have been designed specifically for remote control and unattended operation. The power controls are motor driven and the necessary remote control sampling points are built-in on accessible terminal boards.

Today, Harris TV transmitters are being operated successfully worldwide in an unattended mode, with and without remote control access. In addition, Harris' transmitter design is consistent with anticipated automatic transmitter needs in the future.

EXCITER/DRIVER CABINET

The exciter/driver cabinet is an entire 1300-watt transmitter and can be used as such should it be desirable. This feature is most valuable during an emergency when the whole cabinet can be operated from a 5-kilowatt, 3-phase, 230-volt generator.

STABILITY

One factor assuring RF stability is the use of conservatively-rated Type 8792 and 8807 ceramic tetrodes operating as VHF linear amplifiers. These amplifier stages operate in a common grid and screen configuration and tube neutralization is not required.

POWER SUPPLIES

The HV power supply is a multi-phase, full wave rectifying system exhibiting very low ripple content prior to output filtering. It is designed for excellent regulation and low video impedance for optimum picture performance. This power supply, including transformer and solid-state rectifiers, is housed in a single assembly, mounted externally from the transmitter. Routine maintenance access is provided by a removable panel.

Directly heated vacuum tube filaments are fed with DC to maximize the output signal-to-noise ratio. Grid and screen supplies use solid-state regulators.

The 1300-watt driver cabinet has an independent solid-state HV power supply, and the visual and aural exciters have their own independent, solid-state, regulated power supplies.

EASE OF MAINTENANCE AND INSTALLATION

Total transmitter component accessibility is provided, front and back. Visual and aural exciters slide out and can operate independently from the transmitter outside the exciter/driver cabinet. Various exciter circuits, such as oscillators, modulators and processing circuitry, are of modular construction and can be removed for maintenance or replacement.

Easy-to-read, eye-level 4-inch meters are used to monitor required transmitter functions. Meter panels are of double-hinged construction for convenient access during maintenance. A complete system of overload indicators is also provided in each

cabinet for monitoring transmitter operation. In the event of a transmitter malfunction, an examination of the indicators will locate the problem area.

The transmitter has been built in a modular

fashion so that cabinets may be separated into convenient, easy-to-handle sub-assemblies to facilitate installation. Additionally, the compact design of the BT-18L2 minimizes space requirements in the transmitter building.

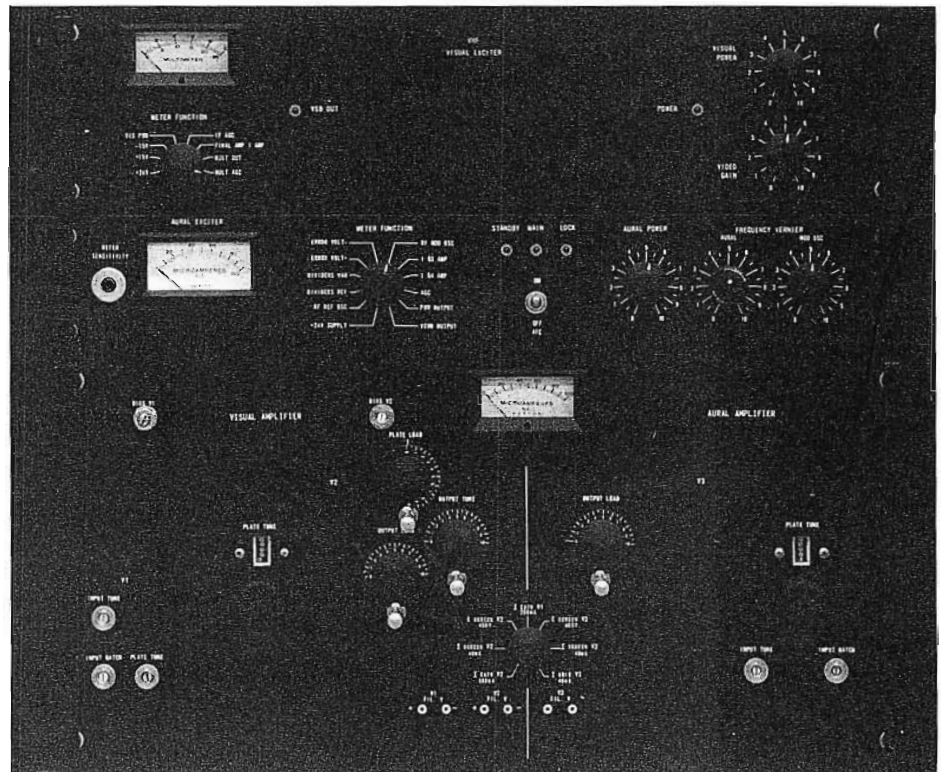

Visual and aural exciter/modulators and IPA.

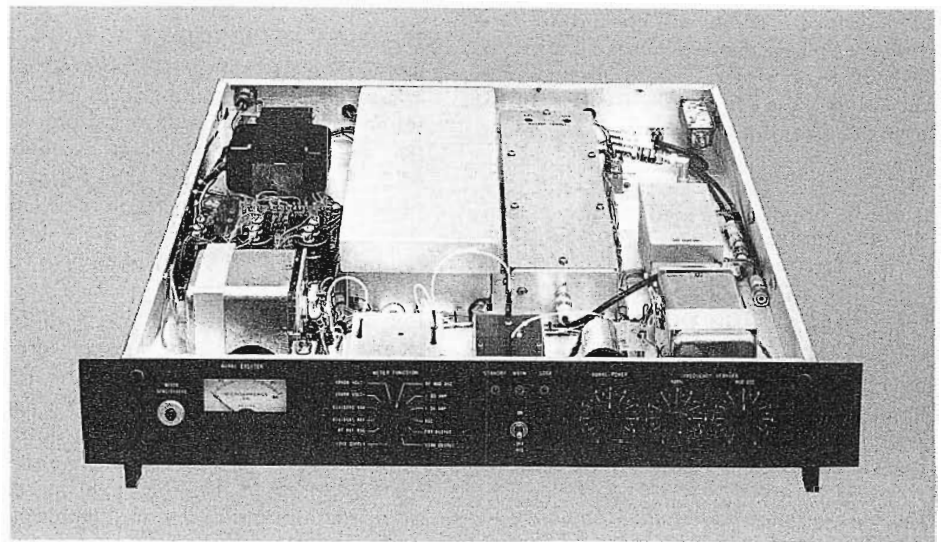

The aural exciter/modulator is a solid-state, self-contained unit.

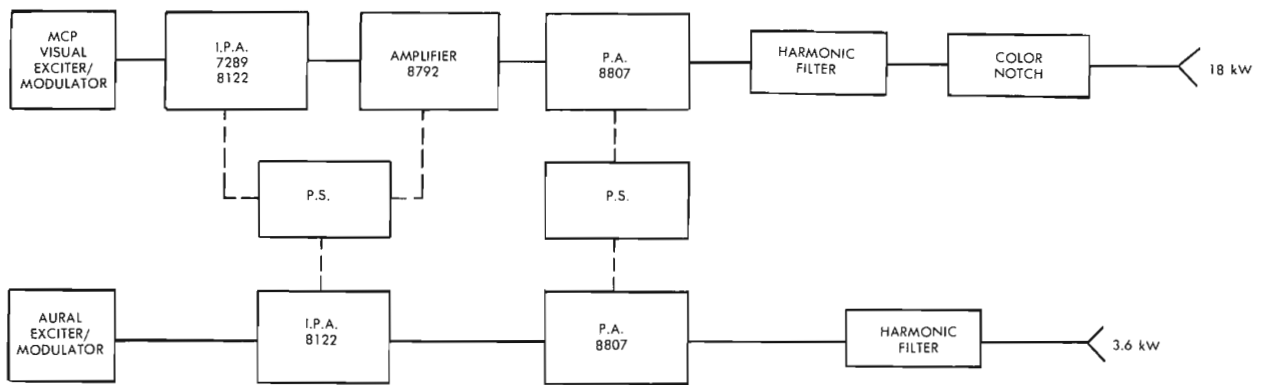

BT-18L2 BLOCK DIAGRAM

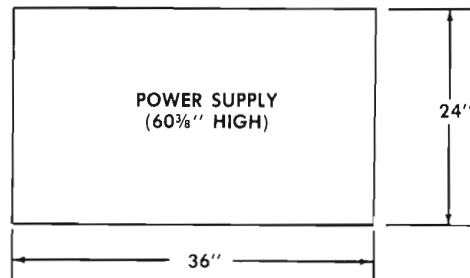

BT-18L2 FLOOR PLAN

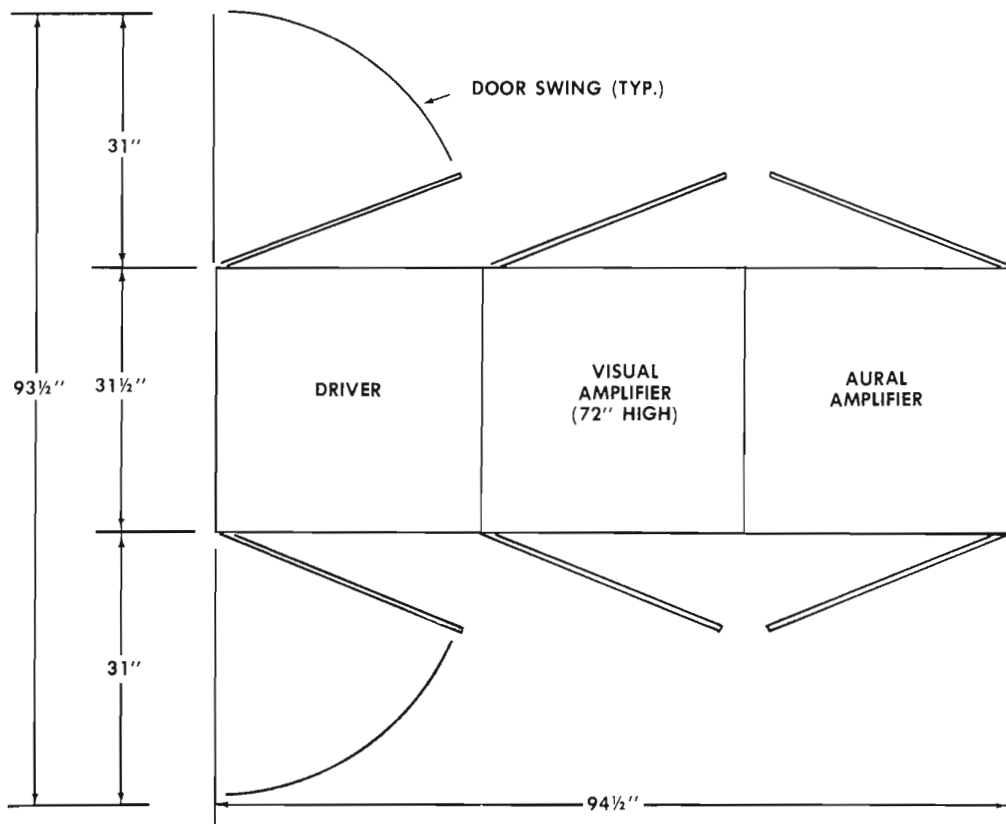

BT-18L2 SPECIFICATIONS

FCC

VISUAL PERFORMANCE

POWER OUTPUT:
OUTPUT IMPEDANCE:
FREQUENCY RANGE:
CARRIER STABILITY:¹
REG. OF RF OUTPUT POWER (Black to white pic.):
VARIATION OF OUTPUT (over one frame):
VISUAL SIDEBAND RESPONSE:

18 kW peak.
 50 ohms. Output connector: 3 1/8" EIA standard.
 54-88 MHz (Channels 2-6).
 ±250 Hz (maximum variation over 30 days).
 3% or less.
 Less than 2%.
 —3.58 MHz —42 dB or better
 —1.25 MHz and lower —26 dB or better
 Carrier to —0.75 MHz ±0.5 dB
 Carrier 0 dB reference
 Carrier to +4.20 MHz ±0.5 dB
 +4.75 MHz and higher —30 dB or better

FREQUENCY RESPONSE VS. BRIGHTNESS:²
VISUAL MODULATION CAPABILITY:
DIFFERENTIAL GAIN:³
LINEARITY (LOW FREQUENCY):

±0.75 dB.
 3% or better.
 3% or better.
 0.5 dB or better.

DIFFERENTIAL PHASE:⁴
SIGNAL-TO-NOISE RATIO:
K FACTORS:
EQUIVALENT ENVELOPE DELAY:

±1° or better.
 —53 dB or better (RMS) below sync level.
 2t 2%, 12.5t less than 5% baseline disturbance.
 .05 to 2.1 MHz: ±40 ns
 at 3.58 MHz: ±30 ns
 at 4.18 MHz: ±60 ns
 (referenced to standard curve—FCC).
 75 ohm system.
 —80 dB.

VIDEO INPUT:⁵
HARMONIC RADIATION:
INTERCARRIER PHASE MODULATION (noise):
HIGH FREQUENCY TRANSIENT RESPONSE,
 15 kHz and 250 kHz:

(Not applicable).
 (Not applicable).

AURAL PERFORMANCE

POWER OUTPUT:
OUTPUT IMPEDANCE:
AUDIO INPUT:
FREQUENCY DEVIATION:
INPUT IMPEDANCE:
PRE-EMPHASIS:
FREQUENCY RESPONSE:
DISTORTION:

3.6 kW at diplexer output.
 50 ohms. Output connector: 3 1/8" EIA Std.
 +10 dBm, ±2 dB.
 ±25 kHz.
 600 ohms.
 75 microseconds.
 ±0.5 dB rel. to pre-emphasis (30-15,000 Hz).
 0.5% or less after 75 microseconds de-emphasis
 with ±25 kHz deviation.

FM NOISE:
AM NOISE:⁶
SYNCHRONOUS AM NOISE:⁷
FREQUENCY STABILITY:⁸

—60 dB or better rel. to ±25 kHz dev.
 —55 dB relative to 100% modulation.
 (Not applicable).
 ±250 Hz.

SERVICE CONDITIONS

AMBIENT TEMPERATURE:
AMBIENT HUMIDITY RANGE:
ALTITUDE:
PHYSICAL AND MECHANICAL DIMENSIONS:

—10° to +50°C (14° to 122°F).
 0 to 95% relative humidity.
 Sea level to 7500 ft.
 94 1/2"W x 31 1/2"D x 72"H. Weight: 2195 lbs.
 Power supply: 36"W x 24"D x 60 3/8"H.
 Weight: 950 lbs.

ELECTRICAL REQUIREMENTS:

Power input: 208/240 Volts, ±11 Volts, 3 phase,
 50/60 Hz. Power consumption: 43 kVA, black pic-
 ture; 36 kVA, average picture. Power factor: .97
 typical.

CCIR (System "B")

15 kW peak.
 50 ohms. Output connector: 3 1/8" EIA standard.
 54-68 MHz (Channels 3 and 4, Band 1).
 ±250 Hz (maximum variation over 30 days).
 3% or less.
 Less than 2%.
 —4.43 MHz —30 dB or better
 —1.25 MHz —26 dB or better
 —0.75 MHz +0.5, —3 dB
 —0.50 MHz +0.5, —1 dB
 Carrier +0.5, —0.5 dB
 +1.5 MHz Reference
 +3.0 MHz ±0.5 dB
 +4.43 MHz +0.5, —1 dB
 +5.0 MHz +0.5, —2.5 dB
 +5.5 MHz —26 dB or better
 ±0.75 dB.

3% or better.
 3% or better.
 Amplitude dev. ¹min, ²max better than 0.85 mod. with
 signal No. 3 CCIR, from 10% to 85% in frequen-
 cy range 1 to 5 MHz.
 ±1° or better.
 —53 dB or better (RMS) below sync level.
 2t 2%, 20t 3% or better.
 up to 4.5 MHz: ±50 ns.
 from 4.5 MHz to 4.8 MHz: ±100 ns.
 (measured with Nyquist demodulator meeting ARD
 specifications).
 75 ohm system.
 —80 dB.
 —40 dB or better with ref. to ±50 kHz dev.
 ±75 ns —10% ±200 ns +7%
 ±100 ns +11% ±400-1000 ns ±5%
 400-1000 ns ±3% for LF variation.

Up to 3.6 kW at diplexer output.
 50 ohms. Output connector: 3 1/8" EIA Std.
 +10 dBm, ±2 dB.
 ±50 kHz.
 600 ohms.
 50 microseconds ±5 microseconds.
 ±0.5 dB rel. to pre-emphasis (30-15,000 Hz).
 Less than 1% from 30 to 15,000 Hz with ±50 kHz
 dev. (Less than twice measured amount at 70
 kHz deviation).
 —60 dB or better rel. to ±50 kHz dev.
 —55 dB relative to 100% modulation.
 —40 dB or better.
 ±250 Hz.

—10° to +50°C.
 0 to 95% relative humidity.
 Sea level to 2400 meters.
 240cm W x 80cm D x 183cm H. Weight: 998 kg.
 Power supply: 92cm W x 61cm D x 153cm H.
 Weight: 430 kg.
 Power input: 380/415 Volts, 3 phase, 50/60 Hz.
 Power consumption: 43 kVA, black picture; 36
 kVA, average picture (10:1 vision to sound ratio).
 Power factor: .97 typical.

¹ After initial aging of 60 days.
² Measured at 65% and 15% of modulation. Reference 100% = peak of sync.
³ Maximum variation of sub-carrier amplitude from 75% to 10% of mod. Sub-Carrier mod. percentage: 10% peak to peak.
⁴ Maximum variation of sub-carrier phase with respect to burst for mod. percentage from 75% to 10%. Sub carrier mod. percentage: 10% peak to peak.
⁵ Bridging, loop through input with—30 dB or better return loss up to 5.5 MHz.
⁶ After de-emphasis.
⁷ Rel. to 100% AM modulation at ±50 kHz deviation.
⁸ Relative to frequency offset by 4.5 MHz (FCC), 5.5 MHz (CCIR) from the visual carrier.

ORDERING INFORMATION

BT-18L2 18kW VHF-TV transmitter for FCC standards service, Channels 2-6, with operating tubes, transistors, IC's, solid-
 state rectifiers, crystals, required pre-correction circuitry, low-level vestigial sideband filter, harmonic and color notch
 filters 994-8028-001
 BT-18L2 15 kW VHF-TV transmitter for CCIR System "B" service, 54 to 68 MHz [Band I], 380/415 volts, 50/60 Hz,
 equipped as above 994-8028-003



HARRIS
COMMUNICATIONS AND
INFORMATION HANDLING

MCP-1V

VHF-TV Visual Exciter/Modulator

- More than a two-to-one improvement in color performance specifications
- TSB (Transversal SideBand) filter requires no group delay correction, no adjustments—only 1½ inches square
- Exciter interfaces with all Harris' VHF IF Modulation transmitters
- Excellent reliability and stability
- Easy serviceability

With the introduction of the MCP-1V visual exciter/modulator, Harris presents the television industry with the best color performance specifications ever offered in VHF-TV transmitting equipment! This dramatic advancement in color performance is made possible through the use of IF Modulation, pioneered in the United States by Harris, and through the use of recent breakthroughs in filtering technology. In the MCP-1V, Harris has combined IF Modulation and Transversal SideBand filtering to achieve better than two-to-one improvements in the important color parameters of differential phase, differential gain and frequency response.

TRANSVERSAL SIDEBAND FILTER. The Harris solid-state vestigial sideband filter is an advanced surface acoustic wave design, and shapes visual sidebands at the IF frequency, rather than "on frequency" at the full output power of the transmitter. Unlike conventional filters, the TSB filter has an inherent linear phase characteristic, which means that it requires no group delay correction. A conventional filter requires from 600 to 1000 nsec of group delay correction, and many adjustments—the TSB filter requires no correction or adjustments—ever! A conventional filter needs 6 to 12 tuning controls—the TSB filter needs no tuning controls. As no envelope delay correction or adjustments are required, color quality, stability and reliability are greatly enhanced. The TSB filter also offers great temperature stability, and is unaffected by aging.

In addition, the TSB filter has steeper skirts and higher attenuation outside the channel passband for improved wave shaping.

Only 1½ square inches in size, the filter is mounted on a PC board in the MCP-1V.

IF MODULATION. The refined IF Modulation techniques used in the MCP-1V offer inherently low values in differential phase and differential gain without the use of complex precorrection or feedback circuits. Additional gain and phase corrector boards may be plugged into the exciter to permit optimum performance at either of two transmitter power levels.

INDEPENDENT, SELF-CONTAINED UNIT. The maximum color performance MCP-1V is an independent, self-contained unit which provides a fully processed on-channel picture signal. Power output can be varied up to one watt with a single front panel control with no adjustment of transmitter tuning controls.

The exciter is mounted in a pull-out drawer, and may be operated outside the main transmitter for test purposes. It is designed for minimum maintenance and set-up time, and for remote control and unattended operation.

The MCP-1V is standard in all of Harris' L2 and H2 TV transmitters—and interfaces easily with any Harris VHF IF Modulation transmitter. See the reverse side for specifications and ordering information.

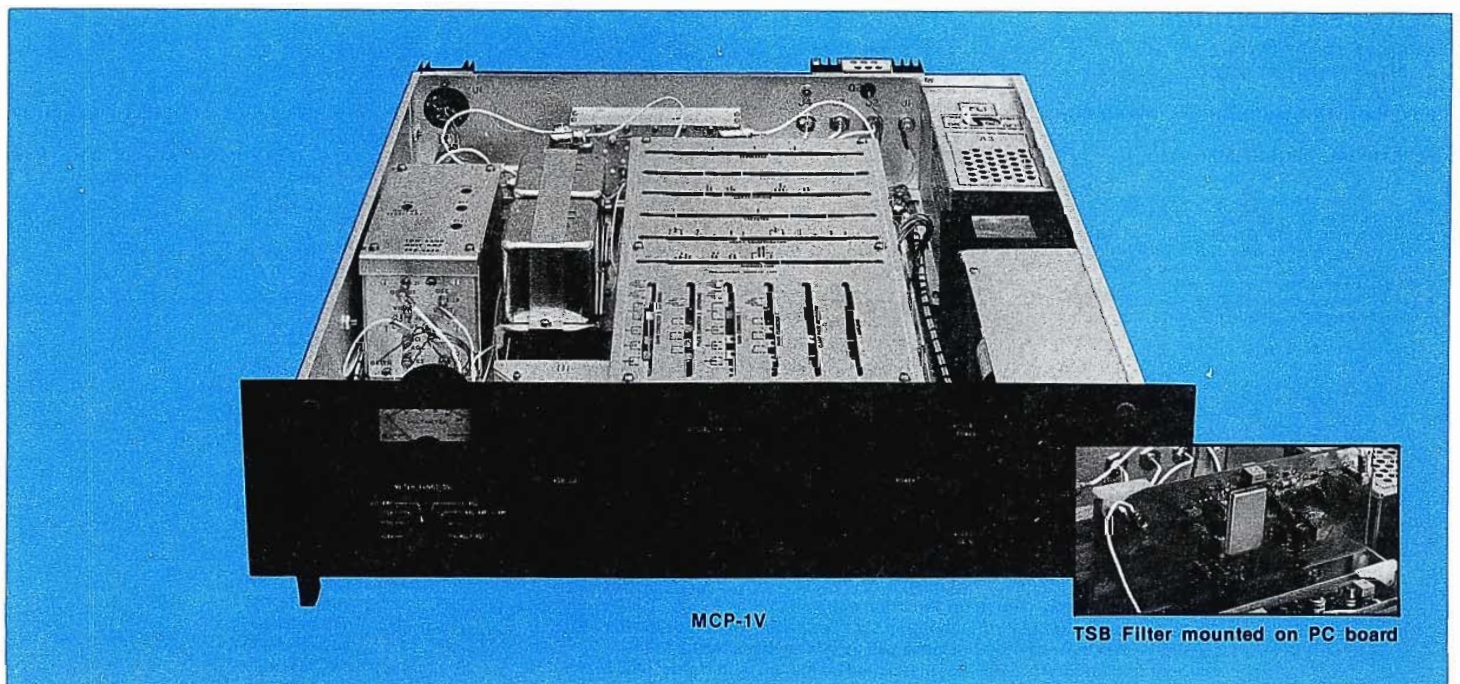

MCP-1V

TSB Filter mounted on PC board

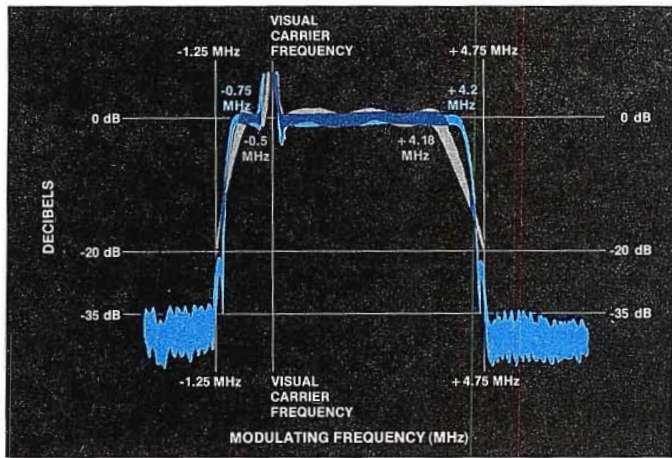

Sideband response of MCP-1V exciter (in blue) showing improvement over typical response of older exciters (shown in gray).

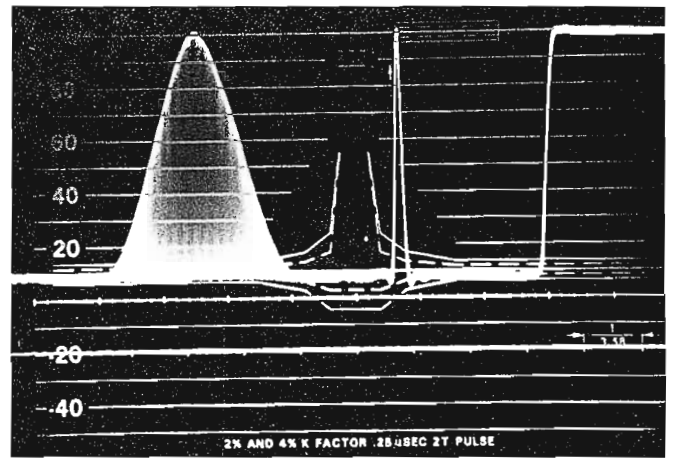

Waveforms of 12.5t and window pulses showing response through the MCP-1V visual exciter.

MCP-1V SPECIFICATIONS

VISUAL PERFORMANCE

POWER OUTPUT:
 OUTPUT IMPEDANCE:
 FREQUENCY RANGE:
 CARRIER STABILITY:¹
 REG. OF RF OUTPUT POWER (Black to white plc.):
 VARIATION OF OUTPUT (over one frame):
 VISUAL SIDEBAND RESPONSE:

FREQUENCY RESPONSE VS. BRIGHTNESS:²
 VISUAL MODULATION CAPABILITY:
 DIFFERENTIAL GAIN:³
 LINEARITY (LOW FREQUENCY):

DIFFERENTIAL PHASE:⁴
 SIGNAL-TO-NOISE RATIO:
 K FACTORS:
 EQUIVALENT ENVELOPE DELAY:

VIDEO INPUT:⁵
 HARMONIC RADIATION⁶

SERVICE CONDITIONS

AMBIENT TEMPERATURE:
 AMBIENT HUMIDITY RANGE:
 ALTITUDE:
 PHYSICAL AND MECHANICAL DIMENSIONS:

ELECTRICAL REQUIREMENTS:

FCC

One watt peak of sync.
 50 ohms unbalanced. Output connector: BNC.
 Channels 2-6 (54-88 MHz) or Channels 7-13 (174-216 MHz).
 ± 250 Hz (maximum variation per month).
 1% or less.
 1% or less.
 -1.25 MHz and lower -30 dB
 Carrier to -0.75 MHz ± 0.5 dB
 Carrier 0 dB reference
 Carrier to +4.20 MHz ± 0.5 dB
 +4.75 MHz and higher -30 dB
 ± 0.25 dB.
 3% or better.
 3% maximum.
 0.5 dB or better.
 $\pm 1^\circ$ maximum.
 -58 dB or better (RMS) below sync level.
 2t 2%, 12.5t less than 5% baseline disturbance.
 0.5 to 2.1 MHz: ± 40 ns
 at 3.58 MHz: ± 30 ns
 at 4.18 MHz: ± 60 ns
 (referenced to standard curve-FCC)
 75 ohm, terminated.
 -20 dB.

-10° to +60° C (14° to 140° F).
 0 to 95% relative humidity.
 Sea level to 10,000 feet.
 24" W x 22" D x 5.25" H. Weight: 38 lbs.

105-125 VAC or 210-250 VAC, 50/60 Hz. Power consumption: 150 VA maximum.

CCIR (System "B")

One watt peak of sync.
 50 ohms unbalanced. Output connector: BNC.
 Band I: E3-E4 (54-68 MHz) or Band III: E5-E11 (174-223 MHz).
 ± 250 Hz (maximum variation per month).
 1% or less.
 1% or less.
 -1.25 MHz and lower -30 dB
 +1.5 MHz to -0.75 MHz ± 0.5 dB
 +1.5 MHz 0 dB reference
 +1.5 MHz to 5.0 MHz ± 0.5 dB
 +5.5 MHz and higher -30 dB
 ± 0.25 dB.
 3% or better.
 3% maximum.
 Amplitude dev. $\frac{\Delta \text{min}}{\Delta \text{max}}$ max. better than 0.5 dB mod. with signal No. 3 CCIR, from 10% to 85% in frequency range 1 to 5 MHz.
 $\pm 1^\circ$ maximum.
 -40 dB pp below black to white transition.
 2t 2%, 20t 3% or better.
 0.5 to 4.5 MHz: ± 50 ns
 4.5 to 4.8 MHz: ± 100 ns
 (measured with Nyquist demodulator meeting ARD specifications).
 75 ohm, terminated.
 -20 dB.

-10° to +60° C.
 0 to 95% relative humidity.
 Sea level to 3000 meters.
 61 cm W x 55.9 cm D x 13.3 cm H. Weight: 17.3 kg.
 105-125 VAC or 210-250 VAC, 50/60 Hz. Power consumption: 150 VA maximum.

¹ After initial aging of 60 days.

² Measured at 10% and 90% APL relative to response at 50% APL.

³ Maximum variation of sub-carrier amplitude from 75% to 10% of mod. Sub-carrier mod. percentage: 10% peak to peak.

⁴ Maximum variation of sub-carrier phase with respect to burst for mod. percentage from 75% to 10%. Sub-carrier mod. percentage: 10% peak to peak.

⁵ -30 dB or better return loss up to 5.0 MHz.

⁶ The MCP-1V Exciter does not provide sufficient selectivity in the exciter alone to meet FCC and CCIR transmitter specifications for -3.58 MHz suppression or harmonic radiation. However, when the MCP-1V is used in a Harris IF modulated transmitter, FCC and CCIR performance requirements in these areas will be met or exceeded.

ORDERING INFORMATION

MCP-1V visual exciter/modulator for FCC standards service, Channels 2-6	994-7861-002
MCP-1V retrofit visual exciter/modulator for FCC standards service, Channels 2-6	994-8136-001
MCP-1V visual exciter/modulator for FCC standards service, Channels 7-13	994-7861-003
MCP-1V retrofit visual exciter/modulator for FCC standards service, Channels 7-13	994-8135-001
MCP-1V visual exciter/modulator for CCIR System "B" service, Band I (54-68 MHz)	994-7861-005
MCP-1V visual exciter/modulator for CCIR System "B" service, Band III (174-223 MHz)	994-7861-006
Precise Frequency Control (optional)	994-6760-001
Phase Corrector PC Board (optional)	992-4717-001
Gain Corrector PC Board (optional)	992-4718-001
Automatic Exciter/Modulator Switcher (optional)	994-7016-001
RAK-96 basic rack (24") for mounting backup exciter, automatic exciter switcher	448-0636-000
Side panel kit for RAK-96. Includes two panels in Harris' white finish	448-0589-000
Front trim kit for RAK-96. Trim in brushed aluminum with Harris' blue insert	448-0637-000
Door handle with lock for rear door of RAK-96	448-0559-000



HARRIS

COMMUNICATION AND
INFORMATION PROCESSING

TV-110U

110-Kilowatt UHF Color Television Transmitter

- Advanced Transversal SideBand filter—no group delay, no tuning adjustments required
- Highly linear IF Modulation of the visual and aural carriers for superior color and sound reproduction
- Easily interfaced with ATS and remote control systems
- Outstanding long-term stability and reliability
- High-efficiency 5-cavity klystrons (Ch. 14-51)
- Mod Anode Pulser for increased transmitter efficiency (Ch. 14-51)
- Simple solid-state logic control
- Modular pre-wired cabinets for fast and easy installation

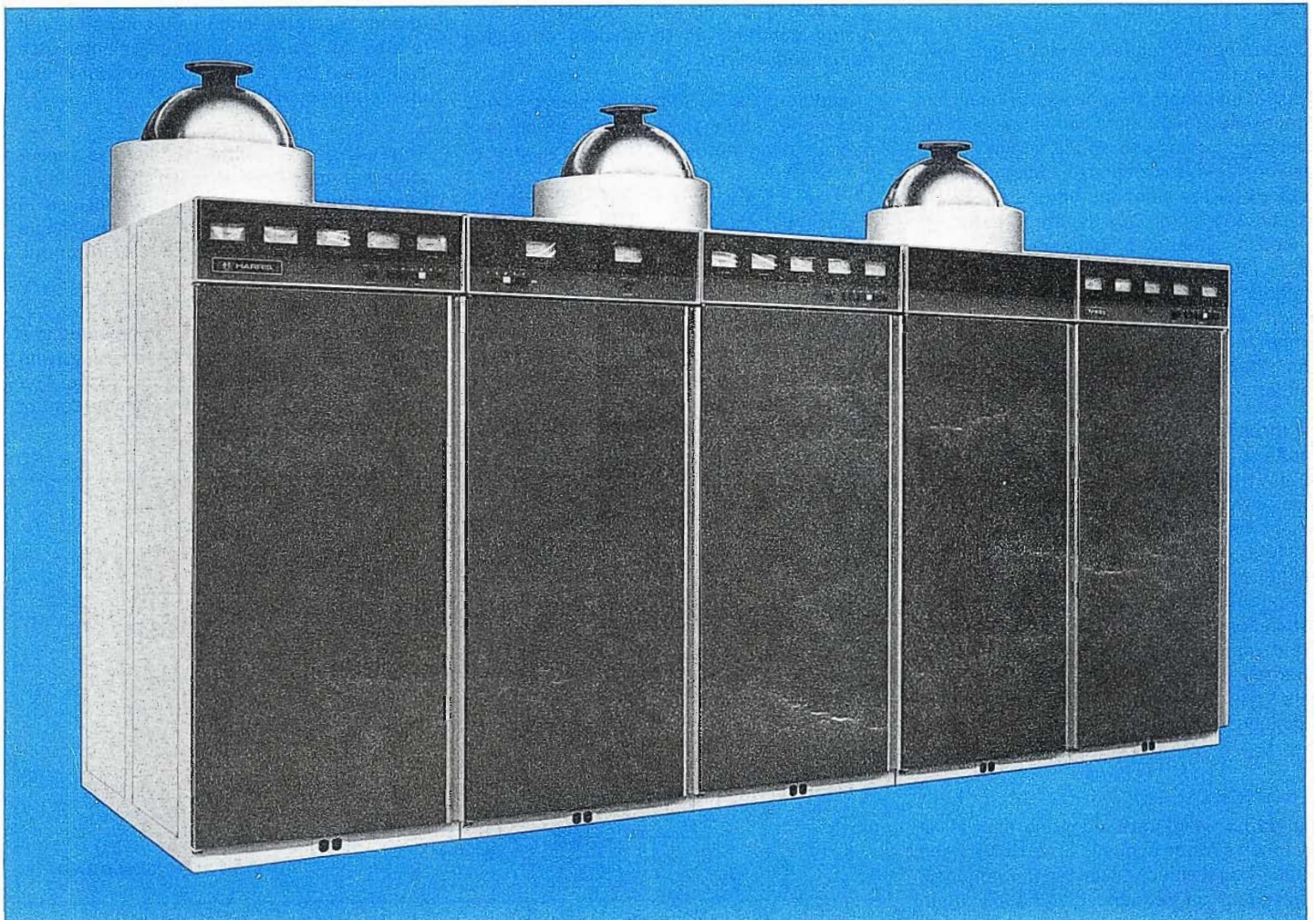

HARRIS' TV-110U PROVIDES SUPERB COLOR QUALITY, LONG-TERM RELIABILITY

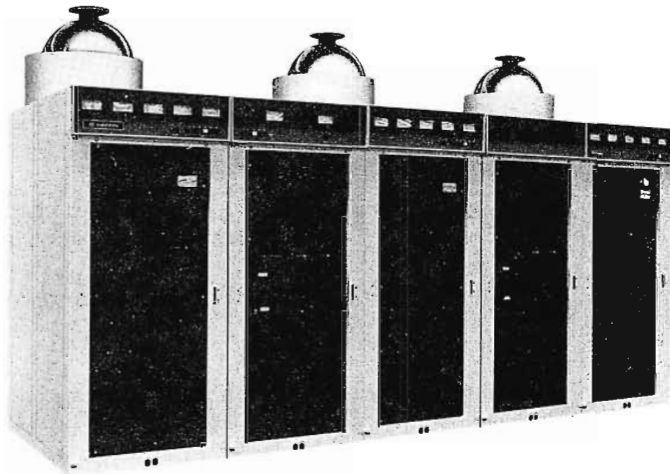

UNSURPASSED PERFORMANCE. Harris' TV-110U is the most advanced 110-kilowatt UHF television transmitter on the market. Designed to meet the high performance standards demanded by today's discriminating broadcaster, this transmitter incorporates the latest state-of-the-art features, such as Harris' solid-state Transversal SideBand (TSB) filter.

IF (intermediate frequency) Modulation, low-level sideband filtering, true linear operation of power amplifiers and solid-state visual and aural exciter/modulators combine to provide outstanding color and sound fidelity. As no envelope delay correction or adjustments are required for the sideband filter, stability, reliability and color quality are greatly enhanced. Frequency adjustment, power output control and amplifier tuning are straightforward and uncomplicated, while design simplicity and conservatively rated components in the TV-110U assure long-term "hands-off" operation and minimum maintenance.

The three five-cavity, vapor-cooled klystrons employed as visual and aural amplifiers in the TV-110U require less than one watt of drive power each to develop full power output. The klystrons are housed in separate cabinets, containing identical control logic, magnetic supplies and overload sensors, and operate independently of one another. Installation or replacement can be accomplished rapidly by one man. Except for the klystrons, the transmitters are totally solid state for stable operation and highest reliability.

TRANSVERSAL SIDEBAND (TSB) FILTER.

The Harris solid-state sideband filter is an advanced surface acoustic wave design, and shapes visual sidebands at the IF frequency, rather than "on frequency" at the full output

power of the transmitter. Unlike other VSB filters, the TSB filter has an inherent linear phase characteristic, which means that it requires no group delay correction. Other VSB filters require from 600 to 1000 nsec of group delay correction, and many adjustments—the TSB filter requires no correction or adjustments—ever! Other VSB filters need 6 to 12 tuning controls—the TSB filter needs no tuning controls, as it requires no tuning adjustment—ever!

In addition, the TSB filter has steeper skirts and higher attenuation outside the channel passband for improved VSB wave shaping.

Only 1½ square inches in size, the TSB filter is mounted on a PC board in the visual exciter.

ADVANCED-DESIGN VISUAL AND AURAL EXCITER/MODULATORS.

The Harris solid-state MCP-1U visual exciter/modulator is an independent, self-contained unit which provides a fully processed on-channel picture signal. Power output of the visual exciter/

modulator can be varied with a single front panel control, or from a remote location, without retuning of any kind.

The master oscillator is located in the visual exciter in a proportional controlled oven, and master oscillator frequency can be varied ± 500 Hz. With one control the station engineer can make precise frequency adjustments to both the visual and aural carriers. Actual frequency determining circuitry is also contained in the visual exciter in a proportional controlled oven. Visual modulation takes place at 37.0 MHz (38.9 MHz for CCIR B). Sidebands are filtered by the Harris TSB filter, which may be bypassed easily for transmitter tuning and maintenance.

The visual exciter is mounted in a pull-out drawer and may be operated outside the main transmitter for test purposes. A switch and meter mounted on the front panel permit monitoring exciter parameters. Power and video gain controls are motor driven with manual override provision.

The Harris visual exciter/modulator provides great reliability and stability, excellent frequency response, and truest color quality. It is also designed for minimum maintenance and set-up time, and for remote control and unattended operation.

The Harris aural exciter/modulator is a solid-state self-contained unit which furnishes a fully processed aural signal at a level up to .5 watts. Power output can be set with a single knob on the front panel, or by remote control, with no need for retuning.

The aural exciter/modulator is mounted in a pull-out drawer, and may be operated with the drawer extended for test purposes. The exciter has been designed for remote control and unattended operation.

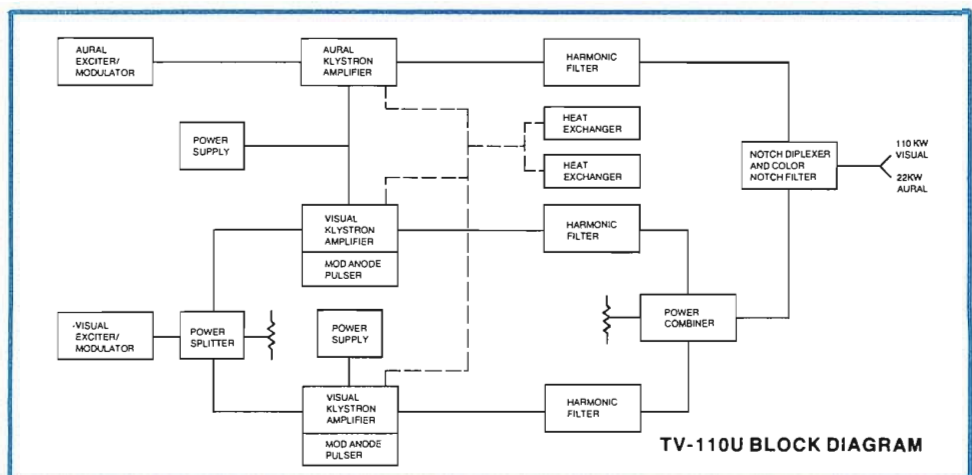

IF MODULATION. One of the most important features of the TV-110U is its true low-level IF Modulation, which offers a top quality picture, and excels in electrical performance, reliability and simplicity of operation.

Due to the low-level techniques, which include the use of devices such as an extremely linear broadband diode ring modulator, low-level sideband filtering and very linear broadband amplifiers, the broadcast signal is a faithful reproduction of the signal applied to the transmitter input. IF Modulation results in low incidental phase noise, and the elimination of many transmission problems at their source. This means that no half-way measures—such as numerous correction, compensation and feedback circuits—are required to eliminate the effects of these problems later.

SOLID-STATE CONTROL LOGIC. Complete and foolproof control of all transmitter functions is achieved through the use of solid-state memory, timing and logic circuits. A self-charging emergency power source is provided to maintain control logic memory during periods of power line failure.

The solid-state control logic and protective circuitry, in addition to commanding normal AC control functions, is also used to visually indicate, through indicator lights, the operating status of the transmitter system. These indicator lights allow easy isolation of circuit faults.

AUTOMATIC RECYCLING. The TV-110U's built-in memory circuitry enables the entire transmitter to return to the air automatically in the state it was operating immediately prior to a partial or full power failure. When the transmitter returns to "on-air", status lights provide visual indication of any malfunctions caused by the outage.

REMOTE CONTROL, UNATTENDED AND AUTOMATIC OPERATION. All control, metering and monitoring circuits have been designed specifically for remote control and automatic operation. The power controls are motor driven and the necessary remote control sampling points are built-in on accessible terminal boards. In addition, Harris' transmitter design is consistent with anticipated automatic transmitter needs in the future.

KLYSTRONS. High gain klystrons, containing five internal cavities, amplify the exciter outputs to the proper power levels. The klystrons are vapor cooled, and are mounted in special assemblies which pivot to allow easy installation. A klystron carriage is provided.

MOD ANODE PULSER. The Mod Anode Pulser provides a means of operating the High Efficiency Klystrons at reduced beam current during the video portion of the signal, and high beam current during sync. This feature provides a significant reduction in transmitter input power requirements. The Mod Anode Pulser is generally used only with High Efficiency Visual Klystrons.

HEAT EXCHANGERS. Each of the two unitized heat exchangers employed in the TV-110U contains a cooling core, blower and motor, circulating pump, spare pump, storage tank and control devices. The cooling system is a departure from conventional designs which use individual components which must be installed separately.

HV POWER SUPPLIES. There are two HV power supplies, which are multi-phase, full wave rectifying systems exhibiting very low ripple content prior to output filtering. They are designed for excellent regulation. Each power supply, including transformer and solid-state rectifiers, is housed in a single assembly mounted externally from the transmitter. Routine maintenance access is provided by a removable panel.

EASE OF MAINTENANCE AND INSTALLATION. Total transmitter component accessibility is provided, front and back. Visual and aural exciters slide out and can operate independently from the transmitter outside the exciter/driver cabinet. Various exciter circuits such as oscillators, modulators and processing circuitry, are of modular construction and can be removed for maintenance or replacement.

TRANSMITTER CONFIGURATION. The TV-110U consists of: a visual amplifier (which can become an aural amplifier with the touch

of a button in an emergency—an optional feature); a control cabinet containing exciters, plus splitting, phasing and balance networks; a second visual amplifier; a second control cabinet which can be used to mount optional spare exciters; and an aural amplifier. The transmitter has been built in a modular fashion so that cabinets may be separated into convenient, easy-to-handle sub-assemblies to facilitate installation.

DIPLEXER/RF SYSTEM. The standard TV-110U is supplied with a waveguide assembly that includes the visual combiner, notch diplexer and color notch filter. This assembly is factory tested and optimized to provide excellent performance and easy installation.

To provide flexibility during abnormal conditions (such as a klystron failure), an optional Unitized RF System is available. In addition to the waveguide combiner, diplexer and color notch filter, the Unitized RF System contains coax and waveguide switches and patch panels.

This switching system permits bypassing the combiner to increase the visual output power from 25% to 50% with only one visual klystron operating. This system also provides the capability of using one of the visual klystrons for aural service. All switches are motorized and can be operated by remote control. Dummy loads and patch panels permit testing of any individual klystron and the combined output of all three klystrons.

The entire Unitized RF System is factory assembled, tested and optimized to one channel.

The Unitized RF System provides maximum utilization of the flexibility and redundancy inherent in the TV-110U, providing maximum power and performance at all times.

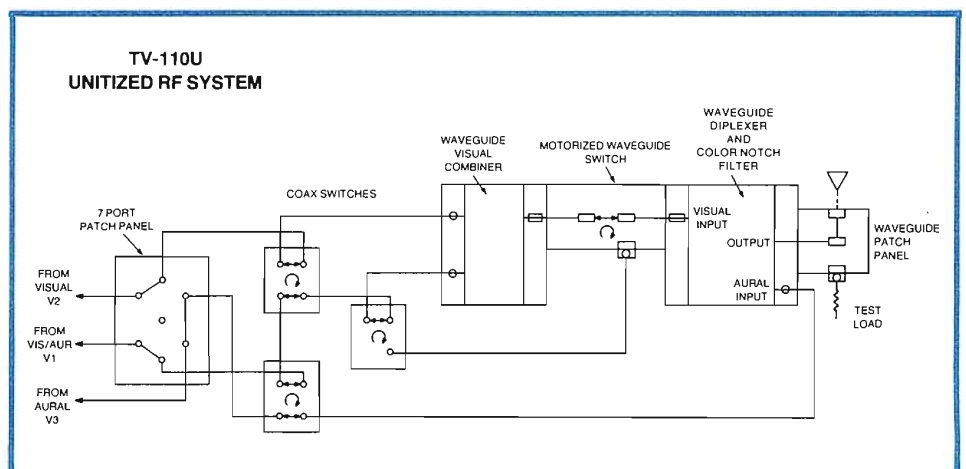

TV-110U SPECIFICATIONS

VISUAL PERFORMANCE

POWER OUTPUT:
OUTPUT IMPEDANCE:
FREQUENCY RANGE:
CARRIER STABILITY:¹
REG. OF RF OUTPUT POWER (Black to white pic.):
VARIATION OF OUTPUT (over one frame):
VISUAL SIDEBAND RESPONSE: (Measured at output of diplexer and color notch filter)

FREQUENCY RESPONSE VS. BRIGHTNESS:²
VISUAL MODULATION CAPABILITY:
DIFFERENTIAL GAIN:³
LINEARITY (LOW FREQUENCY):
DIFFERENTIAL PHASE:⁴
SIGNAL-TO-NOISE-RATIO:
K-FACTORS:
EQUIVALENT ENVELOPE DELAY:

VIDEO INPUT:⁵
HARMONIC RADIATION:

AURAL PERFORMANCE

POWER OUTPUT:
OUTPUT IMPEDANCE:
AUDIO INPUT:
FREQUENCY DEVIATION:
INPUT IMPEDANCE:
PRE-EMPHASIS:
FREQUENCY RESPONSE:
DISTORTION:
FM NOISE:
AM NOISE:⁶
FREQUENCY STABILITY:⁷

SERVICE CONDITIONS

AMBIENT TEMPERATURE:
AMBIENT HUMIDITY RANGE:
ALTITUDE:

PHYSICAL AND MECHANICAL DIMENSIONS:

ELECTRICAL REQUIREMENTS.

⁸

FCC

110 kW peak.
From cabinet: 6- $\frac{1}{8}$ " EIA flanged, 50 ohm (Channels 14-51) Waveguide (Channels 52-69). Output to antenna: Waveguide (Channels 14-69).
470-806 MHz (Channels 14-69).
 ± 500 Hz (maximum variation over 30 days).
3% or less.
Less than 2%.
-3.58 MHz-42 dB or better
-1.25 MHz and lower-20 dB or better
Carrier to -0.75 MHz ± 0.5 dB
Carrier0 dB reference
Carrier to +4.18 MHz +0.5 dB, -2.0 dB
+4.75 MHz and higher-30 dB or better
 ± 0.75 dB.
1% or better.
0.5 dB or better.
1.0 dB or better.
 $\pm 4^\circ$ or better.
-50 dB or better (RMS) below sync level.
2t 2%, 12.5t less than 10% baseline disturbance.
.05 to 2.1 MHz: ± 40 ns.
at 3.58 MHz: ± 30 ns.
at 4.18 MHz: ± 60 ns.
(referenced to standard curve-FCC).
75 ohm system.
-80 dB

22 kW at diplexer output (Channels 14-51). 11 kW at diplexer output (Channels 52-69).
50 ohms. Output connector: 6- $\frac{1}{8}$ " EIA standard (from cabinet).
+10 dBm, ± 2 dB.
 ± 25 kHz for 100% modulation
600 ohms.
75 microseconds.
 ± 0.5 dB rel. to pre-emphasis (30-15,000 Hz).
0.5% or less after 75 microseconds de-emphasis with ± 25 kHz deviation.
-59 dB or better rel. to ± 25 kHz deviation.
-55 dB relative to 100% modulation.
 ± 500 Hz.

+2° C to +50° C (36° to 122° F).
0 to 95% relative humidity.
Sea Level to 7500 ft. (2286 meters).

Transmitter cabinet: 157 $\frac{1}{2}$ " W \times 63" D \times 72" H. (400 cm W \times 160 cm D \times 183 cm H). Note: hoods and steam weirs are higher than cabinet (height varies with channel). Approximate weight: 6500 lbs. (2948 kg).
Power supplies (2): each 73" W \times 62" D \times 58" H. (185 cm W \times 157 cm D \times 150 cm H). Approximate weight: each 7450 lbs. (3380 kg.).
Heat exchangers (2): each 96" W \times 48" D \times 79" H (plus ducting). (244 cm W \times 122 cm D \times 201 cm H). Approximate weight: each 4,000 lbs. (1815 kg.).

Power input: 440/460/480 volts, 3 phase, 50/60 Hz. Power consumption (typical): Channels 14-51—329 kW (10% aural), 377 kW (20% aural); Channels 52-69—465 kW (10% aural). Power factor: better than 90%.

SPECIFICATIONS SUBJECT TO CHANGE WITHOUT NOTICE.

- 1 After initial aging of 60 days.
- 2 Measured at 65% and 15% of modulation. Reference 100%=peak of sync.
- 3 Maximum variation of sub-carrier amplitude from 75% to 10% of mod. Sub-carrier mod. percentage: 10% peak to peak.
- 4 Maximum variation of sub-carrier phase with respect to burst for mod. percentage from 75% to 10%. Sub-carrier mod. percentage: 10% peak to peak.
- 5 Bridging, loop through input with -30 dB or better return loss up to 5.5 MHz.
- 6 After de-emphasis.
- 7 Relative to frequency offset by 4.5 MHz from the visual carrier.
- 8 With pulser (Channels 14-51); consult Harris for Ch. 52-69 pulser applications.

ORDERING INFORMATION

TV-110U 110 KW UHF-TV transmitter for FCC standards service, Channels 14-51, with operating klystrons, semi-conductors, crystals, VSB filter, Mod Anode Pulser, harmonic and color notch filters, notch diplexer994-8460-001
TV-110UA, as above except without Mod Anode Pulser, for Channels 14-69994-8008-001
For optional Unitized RF System contact Harris.



TV-60U

60-Kilowatt UHF Color Television Transmitter

- Advanced Transversal SideBand filter—no gross delay, no tuning adjustments required
- Highly linear IF Modulation of the visual and audio carriers for superior color and sound reproduction
- Easily interfaced with ATS and remote control systems
- Outstanding long-term stability and reliability
- High-efficiency 5-cavity klystrons (Ch. 14-51)
- Mod Anode Pulser for increased transmitter efficiency (Ch. 14-51)
- Simple solid-state logic control
- Modular pre-wired cabinets for fast and easy installation

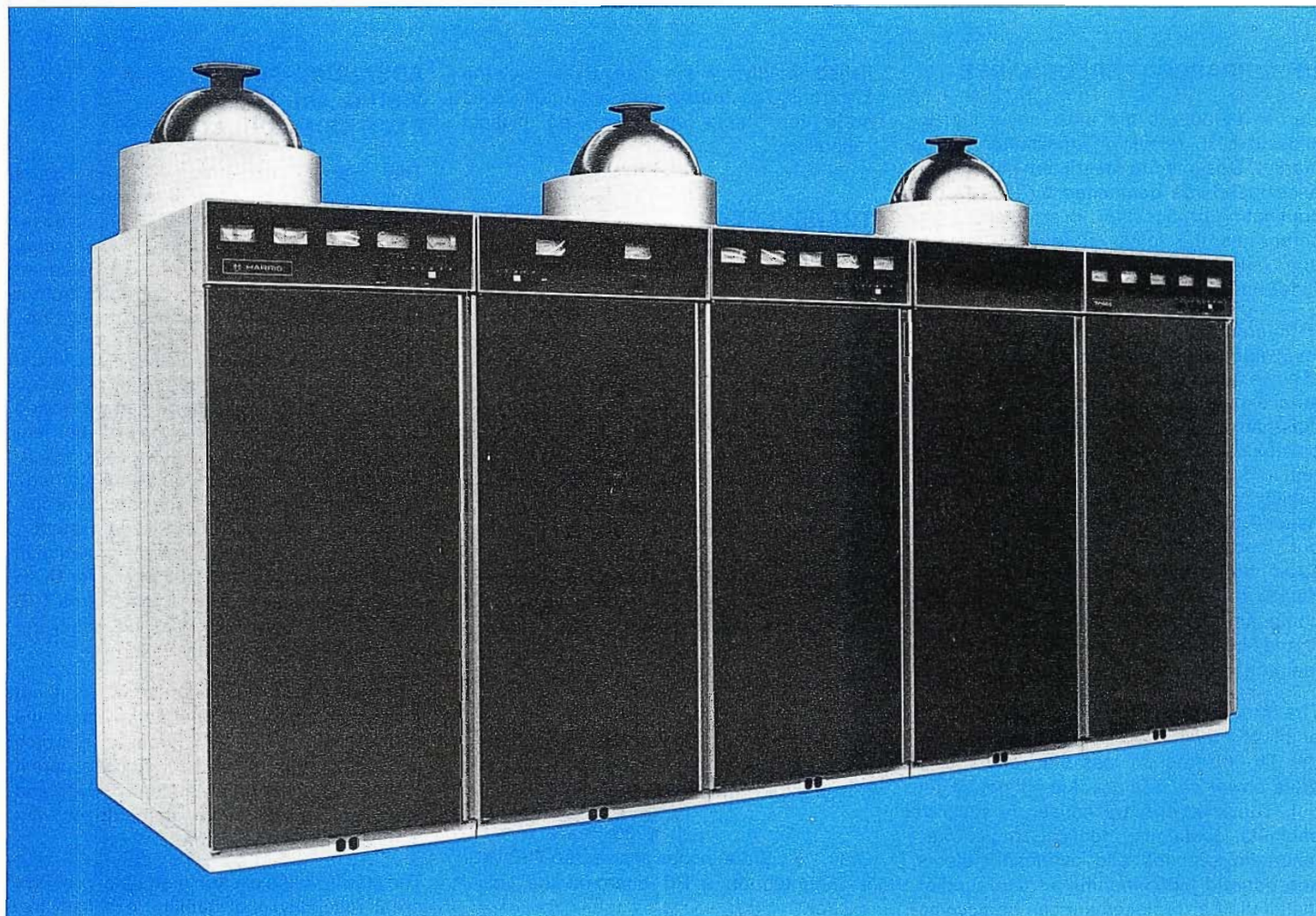

HARRIS' TV-60U PROVIDES SUPERB COLOR QUALITY, LONG-TERM RELIABILITY



UNSURPASSED PERFORMANCE

Harris' TV-60U is the most advanced 60-kilowatt UHF television transmitter on the market. Designed to meet the high performance standards demanded by today's discriminating broadcaster, this transmitter incorporates the latest state-of-the-art features, such as Harris' solid-state Transversal SideBand (TSB) filter.

IF (intermediate frequency) Modulation, low-level sideband filtering, true linear operation of power amplifiers and solid-state visual and aural exciter/modulators combine to provide outstanding color and sound fidelity. As no envelope delay correction or adjustments are required for the sideband filter, stability, reliability and color quality are greatly enhanced. Frequency adjustment, power output control and amplifier tuning are straightforward and uncomplicated, while design simplicity and conservatively rated components in the TV-60U assure long-term "hands-off" operation and minimum maintenance.

The three five-cavity, vapor-cooled klystrons employed as visual and aural amplifiers in the TV-60U require less than one watt of drive power each to develop full power output. The klystrons are housed in separate cabinets, containing identical control logic, magnetic supplies and overload sensors, and operate independently of one another. Installation or replacement can be accom-

plished rapidly by one man. Except for the klystrons, the transmitters are totally solid state for stable operation and highest reliability.

TRANSVERSAL SIDEBAND (TSB) FILTER

The Harris solid-state sideband filter is an advanced surface acoustic wave design, and shapes visual sidebands at the IF frequency, rather than "on frequency" at the full output power of the transmitter. Unlike other VSB filters, the TSB filter has an inherent linear phase characteristic, which means that it requires no group delay correction. Other VSB filters require from 600 to 1000 nsec of group delay correction, and many adjustments—the TSB filter requires no correction or adjustments—ever! Other VSB filters need 6 to 12 tuning controls—the TSB filter needs no tuning controls, as it requires no tuning adjustment—ever!

In addition, the TSB filter has steeper skirts and higher attenuation outside the channel passband for improved VSB wave shaping.

Only 1½ square inches in size, the TSB filter is mounted on a PC board in the visual exciter.

ADVANCED-DESIGN VISUAL AND AURAL EXCITER/MODULATORS

The Harris solid-state MCP-1U visual exciter/modulator is an independent, self-contained unit which provides a fully processed on-channel picture signal. Power output of the visual exciter/modulator can be varied with a single front panel control, or from a remote location, without retuning of any kind.

The master oscillator is located in the visual exciter in a proportional controlled oven, and master oscillator frequency can be varied ± 500 Hz. With one control the station engineer can make precise frequency adjustments to both the visual and aural carriers. Actual frequency determining circuitry is also contained in the visual exciter in a proportional controlled oven. Visual modulation takes place at 37.0 MHz (38.9 MHz for CCIR B). Sidebands are filtered by the Harris TSB filter, which may be bypassed easily for transmitter tuning and maintenance.

The visual exciter is mounted in a pull-out drawer and may be operated outside the main transmitter for test purposes. A switch and meter mounted on the front panel permit monitoring exciter parameters. Power and video gain controls are motor driven with manual override provision.

The Harris visual exciter/modulator provides great reliability and stability, excellent fre-

quency response, and truest color quality. It is also designed for minimum maintenance and set-up time, and for remote control and unattended operation.

The Harris aural exciter/modulator is a solid-state self-contained unit which furnishes a fully processed aural signal at a level up to .5 watts. Power output can be set with a single knob on the front panel, or by remote control, with no need for retuning.

The aural exciter/modulator is mounted in a pull-out drawer, and may be operated with the drawer extended for test purposes. The exciter has been designed for remote control and unattended operation.

IF MODULATION

One of the most important features of the TV-60U is its true low-level IF Modulation, which offers a top quality picture, and excels in electrical performance, reliability and simplicity of operation.

Due to the low-level techniques, which include the use of devices such as an extremely linear broadband diode ring modulator, low-level sideband filtering and very linear broadband amplifiers, the broadcast signal is a faithful reproduction of the signal applied to the transmitter input. IF Modulation results in low incidental phase noise, and the elimination of many transmission problems at their source. This means that no half-way measures—such as numerous correction, compensation and feedback circuits—are required to eliminate the effects of these problems later.

SOLID-STATE CONTROL LOGIC

Complete and foolproof control of all transmitter functions is achieved through the use of solid-state memory, timing and logic circuits. A self-charging emergency power source is provided to maintain control logic memory during periods of power line failure.

The solid-state control logic and protective circuitry, in addition to commanding normal AC control functions, is also used to visually indicate, through indicator lights, the operating status of the transmitter system. These indicator lights allow easy isolation of circuit faults.

AUTOMATIC RECYCLING

The TV-60U's built-in memory circuitry enables the entire transmitter to return to the air automatically in the state it was operating

immediately prior to a partial or full power failure. When the transmitter returns to "on-air", status lights provide visual indication of any malfunctions caused by the outage.

REMOTE CONTROL, UNATTENDED AND AUTOMATIC OPERATION

All control, metering and monitoring circuits have been designed specifically for remote control and automatic operation. The power controls are motor driven and the necessary remote control sampling points are built-in on accessible terminal boards. In addition, Harris' transmitter design is consistent with anticipated automatic transmitter needs in the future.

KLYSTRONS

High gain klystrons, (Ch. 14-51), containing five internal cavities, amplify the exciter outputs to the proper power levels. The klystrons are vapor cooled, and are mounted in special assemblies which pivot to allow easy installation. A klystron carriage is provided.

MOD ANODE PULSER

The Mod Anode Pulser provides a means of operating the High Efficiency Klystrons at reduced beam current during the video portion of the signal, and high beam current during sync. This feature provides a significant reduction in transmitter input power requirements. The Mod Anode Pulser is generally used only with High Efficiency Visual Klystrons.

HEAT EXCHANGER

The unitized heat exchanger employed in the TV-60U contains a cooling core, blower and motor, circulating pump, spare pump, stor-

age tank and control devices. The cooling system is a departure from conventional designs which use individual components which must be installed separately.

HV POWER SUPPLY

The unitized HV power supply is a multi-phase, full wave rectifying system exhibiting very low ripple content prior to output filtering. It is designed for excellent regulation. The power supply, including transformer and solid-state rectifiers, is housed in a single assembly, mounted externally from the transmitter. Routine maintenance access is provided by a removable panel.

EASE OF MAINTENANCE AND INSTALLATION

Total transmitter component accessibility is provided, front and back. Visual and aural exciters slide out and can operate independently from the transmitter outside the exciter/driver cabinet. Various exciter circuits such as oscillators, modulators and processing circuitry, are of modular construction and can be removed for maintenance or replacement.

TRANSMITTER CONFIGURATION

The TV-60U consists of: a visual amplifier (which can become an aural amplifier with the touch of a button in an emergency); a control cabinet containing exciters, plus splitting, phasing and balance networks; a second visual amplifier; a second control cabinet which can be used to mount optional spare exciters; and an aural amplifier. The transmitter has been built in a modular fashion so that cabinets may be separated into convenient, easy-to-handle sub-assemblies to facilitate installation.

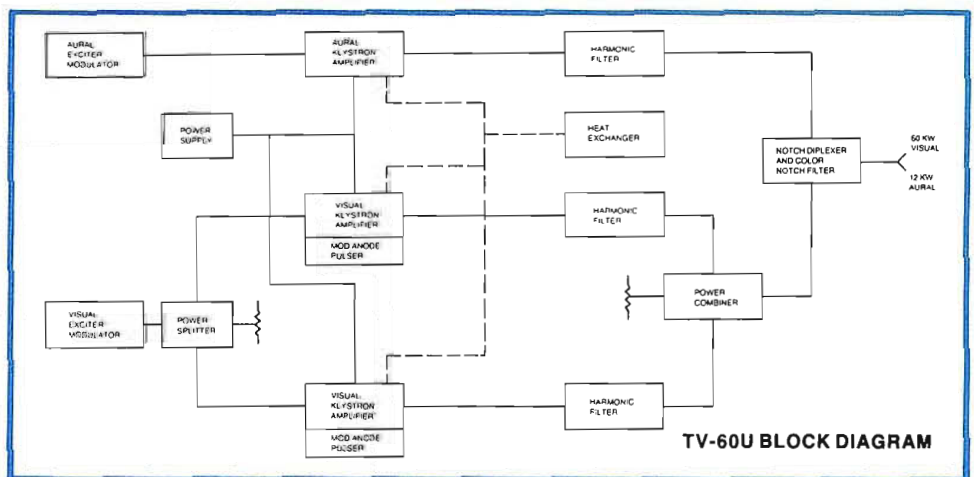

TV-60U SPECIFICATIONS

VISUAL PERFORMANCE

POWER OUTPUT:

OUTPUT IMPEDANCE:

FREQUENCY RANGE:

CARRIER STABILITY:¹

REG. OF RF OUTPUT POWER (Black to white plc.):

VARIATION OF OUTPUT (over one frame):

VISUAL SIDEBAND RESPONSE: (Measured at output of diplexer and color notch filter)

FREQUENCY RESPONSE VS. BRIGHTNESS:²

VISUAL MODULATION CAPABILITY:

DIFFERENTIAL GAIN:³

LINEARITY (LOW FREQUENCY):

DIFFERENTIAL PHASE:⁴

SIGNAL-TO-NOISE-RATIO:

K-FACTORS:

EQUIVALENT ENVELOPE DELAY:

VIDEO INPUT:⁵

HARMONIC RADIATION:

AURAL PERFORMANCE

POWER OUTPUT:

OUTPUT IMPEDANCE:

AUDIO INPUT:

FREQUENCY DEVIATION:

INPUT IMPEDANCE:

PRE-EMPHASIS:

FREQUENCY RESPONSE:

DISTORTION:

FM NOISE:

AM NOISE:⁶

FREQUENCY STABILITY:⁷

SERVICE CONDITIONS

AMBIENT TEMPERATURE:

AMBIENT HUMIDITY RANGE:

ALTITUDE:

PHYSICAL AND MECHANICAL DIMENSIONS:

ELECTRICAL REQUIREMENTS.⁸

FCC

60 kW peak.

From cabinet: 3-1/8" EIA flanged (Channels 14-51), 6 1/8" EIA flanged (Channels 52-69). Output to antenna: 6 1/8", 50 ohm, EIA flanged.

470-806 MHz (Channels 14-69).

±500 Hz (maximum variation over 30 days).

3% or less.

Less than 2%.

-3.58 MHz -42 dB or better

-1.25 MHz and lower -20 dB or better

Carrier to -0.75 MHz ± 0.5 dB

Carrier 0 dB reference

Carrier to +4.18 MHz +0.5 dB, -2.0 dB

+4.75 MHz and higher -30 dB or better

±0.75 dB.

1% or better.

0.5 dB or better.

1.0 dB or better.

±4° or better.

-50 dB or better (RMS) below sync level.

2t 2%, 12.5t less than 10% baseline disturbance.

.05 to 2.1 MHz: ± 40 ns.

at 3.58 MHz: ± 30 ns.

at 4.18 MHz: ± 60 ns.

(referenced to standard curve-FCC).

75 ohm system.

-80 dB

12 kW at diplexer output.

50 ohms. Output connector: 3 1/8" EIA standard (from cabinet).

+10 dBm, ± 2 dB.

±25 kHz for 100% modulation

600 ohms.

75 microseconds.

±0.5 dB rel. to pre-emphasis (30-15,000 Hz).

0.5% or less after 75 microseconds de-emphasis with ± 25 kHz deviation.

-59 dB or better rel. to ± 25 kHz deviation.

-55 dB relative to 100% modulation.

± 500 Hz.

+2° C to +50° C (36° to 122° F).

0 to 95% relative humidity.

Sea level to 7500 ft. (2286 meters).

Transmitter cabinet: 157 1/2" W × 63" D × 72" H. (400 cm W × 160 cm D × 183 cm H). Note: hoods and steam weirs are higher than cabinet (height varies with channel). Approximate weight: 6500 lbs. (2948 kg.).

Power supply: 73" W × 62" D × 58" H. (185 cm W × 157 cm D × 150 cm H). Approximate weight: 7450 lbs. (3380 kg.).

Heat exchanger: 96" W × 48" D × 79" H (plus ducting). (244 cm W × 122 cm D × 201 cm H). Approximate weight: 4,000 lbs. (1815 kg.).

Power input: 440/460/480 volts, 3 phase, 50/60 Hz. Power consumption (typical): 215 kW (10% aural), 236 kW (20% aural). Power factor: better than 90%.

SPECIFICATIONS SUBJECT TO CHANGE WITHOUT NOTICE.

1 After initial aging of 60 days.

2 Measured at 65% and 15% of modulation. Reference 100%=peak of sync.

3 Maximum variation of sub-carrier amplitude from 75% to 10% of mod. Sub-carrier mod. percentage: 10% peak to peak.

4 Maximum variation of sub-carrier phase with respect to burst for mod. percentage from 75% to 10%. Sub-carrier mod. percentage: 10% peak to peak.

5 Bridging, loop through input with -30 dB or better return loss up to 5.5 MHz.

6 After de-emphasis.

7 Relative to frequency offset by 4.5 MHz from the visual carrier.

8 With pulser (Channels 14-51); consult Harris for Ch. 52-69 pulser applications.

ORDERING INFORMATION

TV-60U 60 KW UHF-TV transmitter for FCC standards service, Channels 14-51, with operating klystrons, semi-conductors, crystals, VSB filter, Mod Anode Pulser, harmonic and color notch filters, notch diplexer 994-8459-001

TV-60UA, as above except without Mod Anode Pulser, for Channels 14-69 994-8007-001



HARRIS
COMMUNICATION AND
INFORMATION PROCESSING

TV-55U

55-Kilowatt UHF Color Television Transmitter

- Advanced Transversal SideBand filter—no group delay, no tuning adjustments required
- Highly linear IF Modulation of the visual and aural carriers for superior color and sound reproduction
- Easily interfaced with ATS and remote control systems
- Outstanding long-term stability and reliability
- High-efficiency 5-cavity klystrons (Ch. 14-51)
- Mod Anode Pulser for increased transmitter efficiency (Ch. 14-51)
- Simple solid-state logic control
- Modular pre-wired cabinets for fast and easy installation

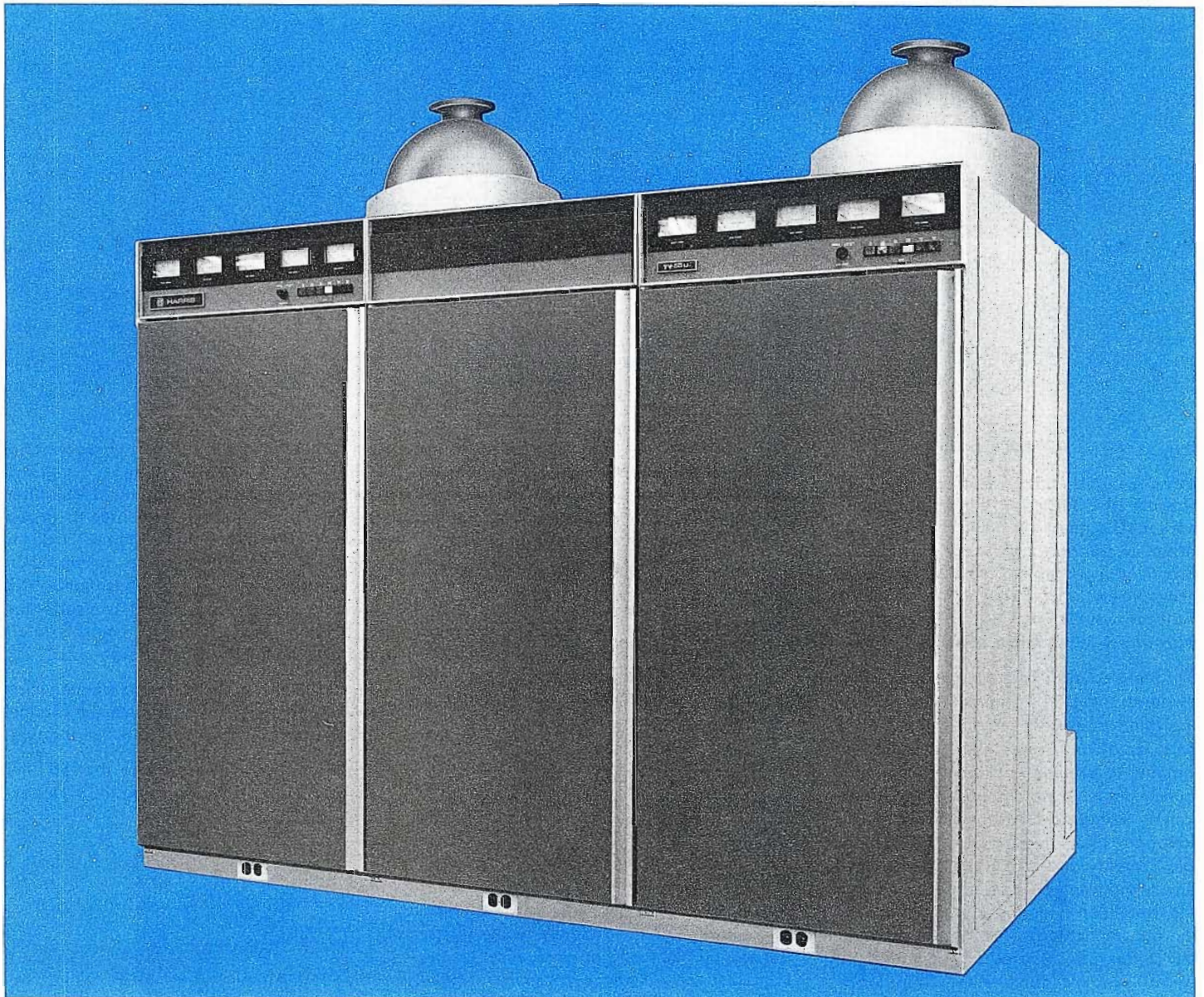

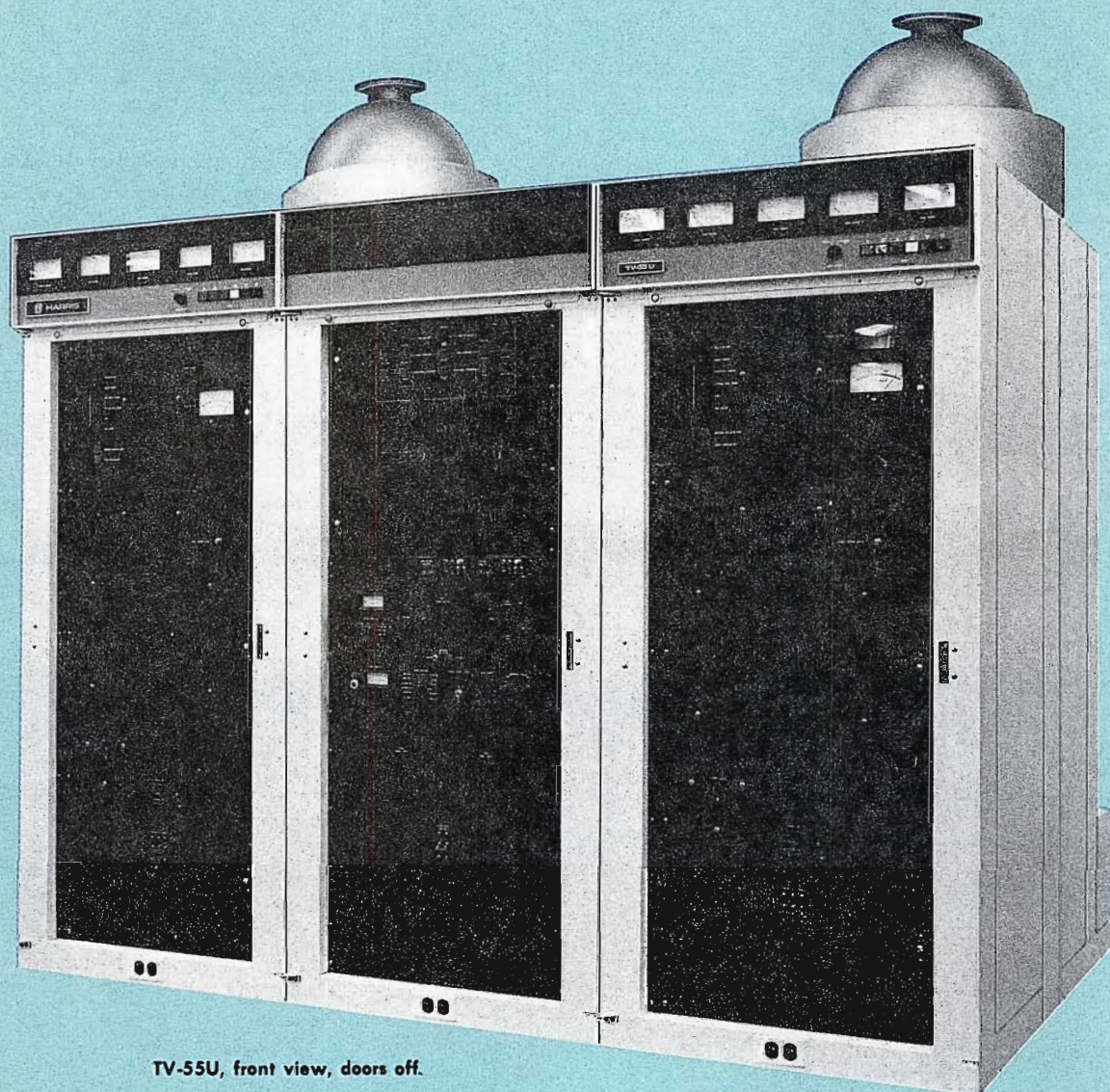

TV-55U, front view, doors off.

UNSURPASSED PERFORMANCE

Harris' TV-55U is the most advanced 55-kilowatt UHF television transmitter on the market. Designed to meet the high performance standards demanded by today's discriminating broadcaster, this transmitter incorporates the latest state-of-the-art features, such as Harris' solid-state Transversal SideBand (TSB) filter.

IF (intermediate frequency) Modulation, low-level sideband filtering, true linear operation of power amplifiers and solid-state visual and aural exciter/modulators combine to provide outstanding color and sound fidelity. As no envelope delay correction or adjustments are required for the sideband filter, stability, reliability and color quality are greatly enhanced. Frequency adjustment, power output control and amplifier tuning are straightforward and uncomplicated, while design simplicity and conservatively rated components in the TV-55U assure long-term "hands-off" operation and minimum maintenance.

The two five-cavity, vapor-cooled klystrons employed as visual and aural amplifiers in the TV-55U require less than one watt of drive power each to develop full power output. The klystrons are housed in separate cabinets, containing identical control logic, magnetic supplies and overload sensors, and operate independently of one another. Installation or replacement can be accomplished rapidly by one man. Except for the klystrons, the transmitters are totally solid state for stable operation and highest reliability.

TRANSVERSAL SIDE BAND (TSB) FILTER

The Harris solid-state sideband filter is an advanced surface acoustic wave design, and shapes visual sidebands at the IF frequency, rather than "on frequency" at the full output power of the transmitter. Unlike conventional VSB filters, the TSB filter has

an inherent linear phase characteristic, which means that it requires no group delay correction. A conventional VSB filter requires from 600 to 1000 nsec of group delay correction, and many adjustments—the TSB filter requires no correction or adjustments—ever! A conventional VSB filter needs 6 to 12 tuning controls—the TSB filter needs no tuning controls, as it requires no tuning adjustment—ever!

In addition, the TSB filter has steeper skirts and higher attenuation outside the channel passband for improved VSB wave shaping.

Only 1½ square inches in size, the TSB filter is mounted on a PC board in the visual exciter.

ADVANCED-DESIGN VISUAL AND AURAL EXCITER/MODULATORS

The Harris solid-state MCP visual exciter/modulator is an independent, self-

contained unit which provides a fully processed on-channel picture signal. Power output of the visual exciter/modulator can be varied with a single front panel control, or from a remote location, without retuning of any kind.

The master oscillator is located in the visual exciter in a proportional controlled oven, and master oscillator frequency can be varied ± 500 Hz. With one control, the station engineer can make precise frequency adjustments to both the visual and aural carriers. Actual frequency determining circuitry is also contained in the visual exciter in a proportional controlled oven. Visual modulation takes place at 37.0 MHz (38.9 MHz for CCIR B). Sidebands are filtered by the Harris TSB filter, which may be bypassed easily for transmitter tuning and maintenance.

The visual exciter is mounted in a pull-out drawer and may be operated outside the main transmitter for test purposes. A switch and meter mounted on the front panel permit monitoring exciter parameters. Power and video gain controls are motor driven with manual override provision.

The Harris visual exciter/modulator provides great reliability and stability, excellent frequency response, and truest color quality. It is also designed for minimum maintenance and set-up time, and for remote control and unattended operation. This is all made possible through the use of the latest design techniques, including Harris' solid-state TSB filter.

The Harris aural exciter/modulator is a solid-state self-contained unit which furnishes a fully processed aural signal at a level up to .5 watts. Power output can be set with a single knob on the front panel, or by remote control, with no need for retuning.

Audio information is used to modulate a direct FM 32.5 MHz (33.4 MHz for CCIR B) carrier derived from the master oscillator in the visual exciter. This information is then translated to the desired "on channel" signal through stable frequency determining circuitry housed in a proportional controlled oven in the visual exciter. A digital phase-locked loop is also used to guarantee absolute frequency stability.

The aural exciter/modulator is mounted in a pull-out drawer, and may be operated with the drawer extended for test purposes. The exciter has been designed for remote control and unattended operation.

IF MODULATION

One of the most important features of the TV-55U is its true low-level IF Modulation,

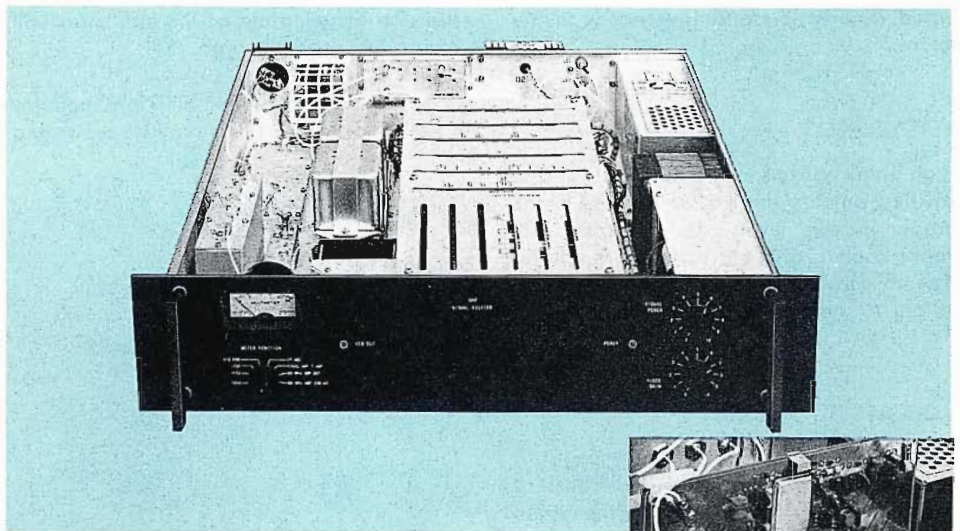

The MCP-1U visual exciter/modulator (above) is a solid-state, independent self-contained "on-channel" signal source. Harris' advanced TSB filter (right) is mounted on a PC board in the visual exciter, and measures only 1½ inches square.

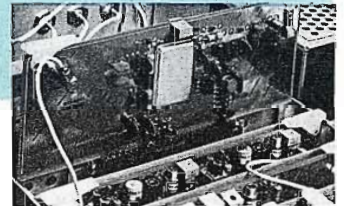

which offers a top quality picture, and excels in electrical performance, reliability and simplicity of operation.

In the TV-55U the visual and aural exciters generate fully modulated low-level IF signals. The output of a common crystal controlled reference oscillator is used to raise the individual IF signal to the desired "on channel" output frequency.

As it occurs at much lower power levels than conventional designs, intermediate frequency modulation needs fewer circuits to produce a fully processed, quality picture signal. Less than one volt of video signal is needed to modulate the RF carrier.

The Harris ring modulator design permits modulation percentages to approximately 1% without compromising transmitter performance—and eliminates most pre-distortion circuitry. This results in exceptional color performance and nearly perfect signal linearity. Even such colors as highly saturated yellow and cyan are faithfully reproduced with IF Modulation.

Due to the low-level techniques, which include the use of devices such as an extremely linear broadband diode ring modulator, low-level sideband filtering and very linear broadband amplifiers, the broadcast signal is a faithful reproduction of the signal applied to the transmitter input. IF Modulation results in low incidental phase noise, and the elimination of many transmission problems at their source. This means that no half-way measures—such as numerous correction, compensation and feedback circuits—are required to eliminate the effects of these problems later on.

SOLID-STATE CONTROL LOGIC

Complete and foolproof control of all

transmitter functions is achieved through the use of solid-state memory, timing and logic circuits. A self-charging emergency power source is provided to maintain control logic memory during periods of power line failure.

The solid-state control logic and protective circuitry, in addition to commanding normal AC control functions, is also used to visually indicate, through indicator lights, the operating status of the transmitter system. These indicator lights allow easy isolation of circuit faults.

AUTOMATIC RECYCLING

The TV-55U's built-in memory circuitry enables the entire transmitter to return to the air automatically in the state it was operating immediately prior to a partial or full power failure. When the transmitter returns to "on-air", status lights provide visual indication of any malfunctions caused by the outage.

REMOTE CONTROL, UNATTENDED AND AUTOMATIC OPERATION

All control, metering and monitoring circuits have been designed specifically for remote control and automatic operation. The power controls are motor driven and the necessary remote control sampling points are built-in on accessible terminal boards.

Today, Harris TV transmitters are being operated successfully worldwide with and without remote control. In addition, Harris' transmitter design is consistent with anti-

pated automatic transmitter needs in the future.

KLYSTRONS

High gain klystrons, containing five internal cavities, amplify the exciter outputs to the proper power levels. The klystrons are vapor cooled, and are mounted in special assemblies which pivot to allow easy installation. A klystron carriage is provided.

MOD ANODE PULSER

The mod anode pulser provides a means of operating High Efficiency Klystrons at reduced beam current during the video portion of the signal, and high beam current during sync. This feature provides a significant reduction in transmitter input power requirements. The mod anode pulser is generally used only with High Efficiency Visual Klystrons.

HEAT EXCHANGER

The unitized heat exchanger employed in the TV-55U contains the cooling core, blower and motor, circulating pump, spare pump, storage tank and control devices. The cooling system is a departure from conventional designs which use individual components which must be installed separately.

HV POWER SUPPLY

The HV power supply is a multi-phase, full wave rectifying system exhibiting very low ripple content prior to output filtering. It is designed for excellent regulation. This power supply, including transformer and solid-state rectifiers, is housed in a single assembly, mounted externally from the transmitter. Routine maintenance access is provided by a removable panel.

EASE OF MAINTENANCE AND INSTALLATION

Total transmitter component accessibility is provided, front and back. Visual and aural exciters slide out and can operate independently from the transmitter outside the exciter/driver cabinet. Various exciter circuits, such as oscillators, modulators and processing circuitry, are of modular construction and can be removed for maintenance or replacement.

Easy-to-read, eye-level 4-inch meters are used to monitor required transmitter functions. Meter panels are of double-hinged construction for convenient access during maintenance. A complete system of overload indicators is also provided in each cabinet for monitoring transmitter operation. In the event of a transmitter malfunction,

an examination of the indicators will locate the problem area.

The transmitter has been built in a modular fashion so that cabinets may be separated

into convenient, easy-to-handle sub-assemblies to facilitate installation. Additionally, the compact design of the TV-55U minimizes space requirements in the transmitter building.

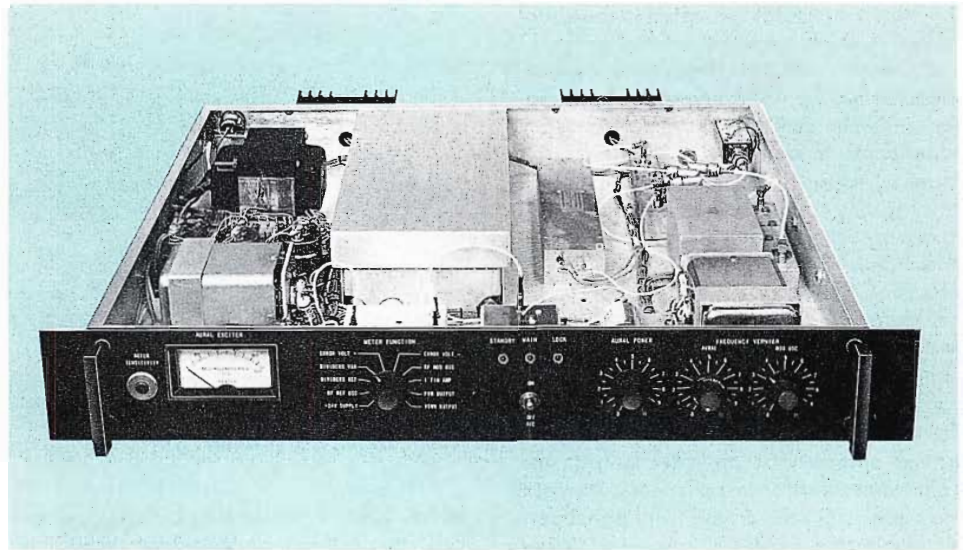

The aural exciter/modulator is a solid-state, self-contained unit.

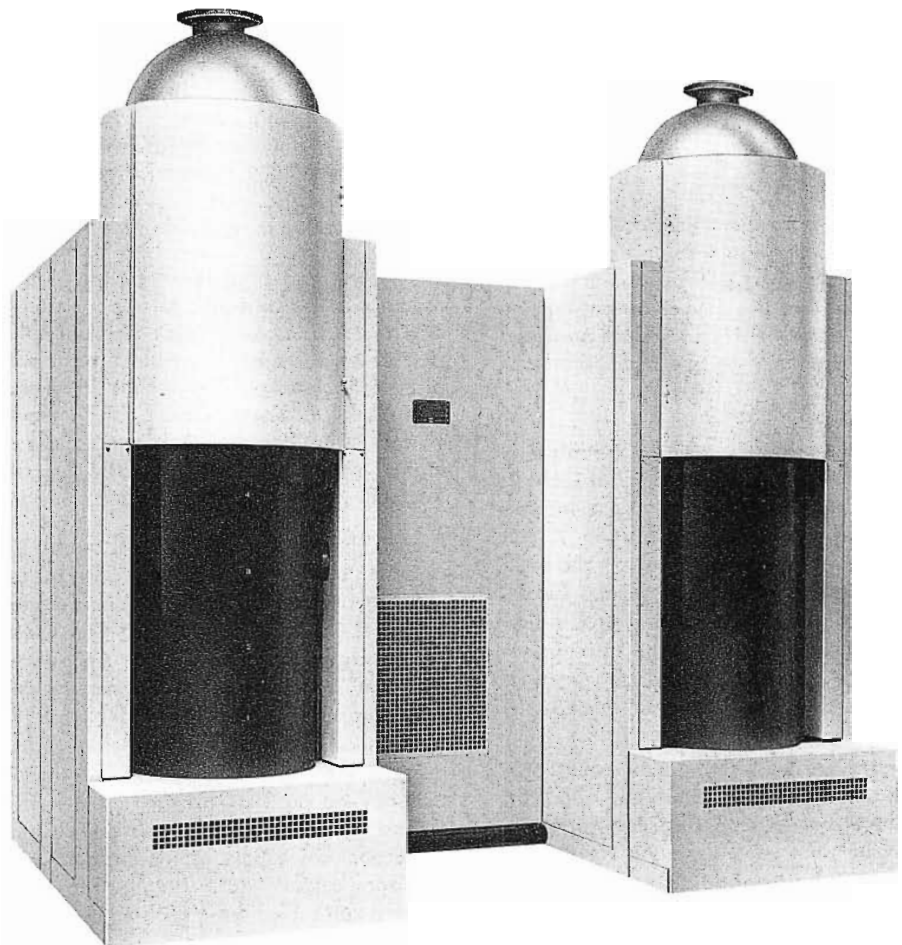

TV-55U, rear view.

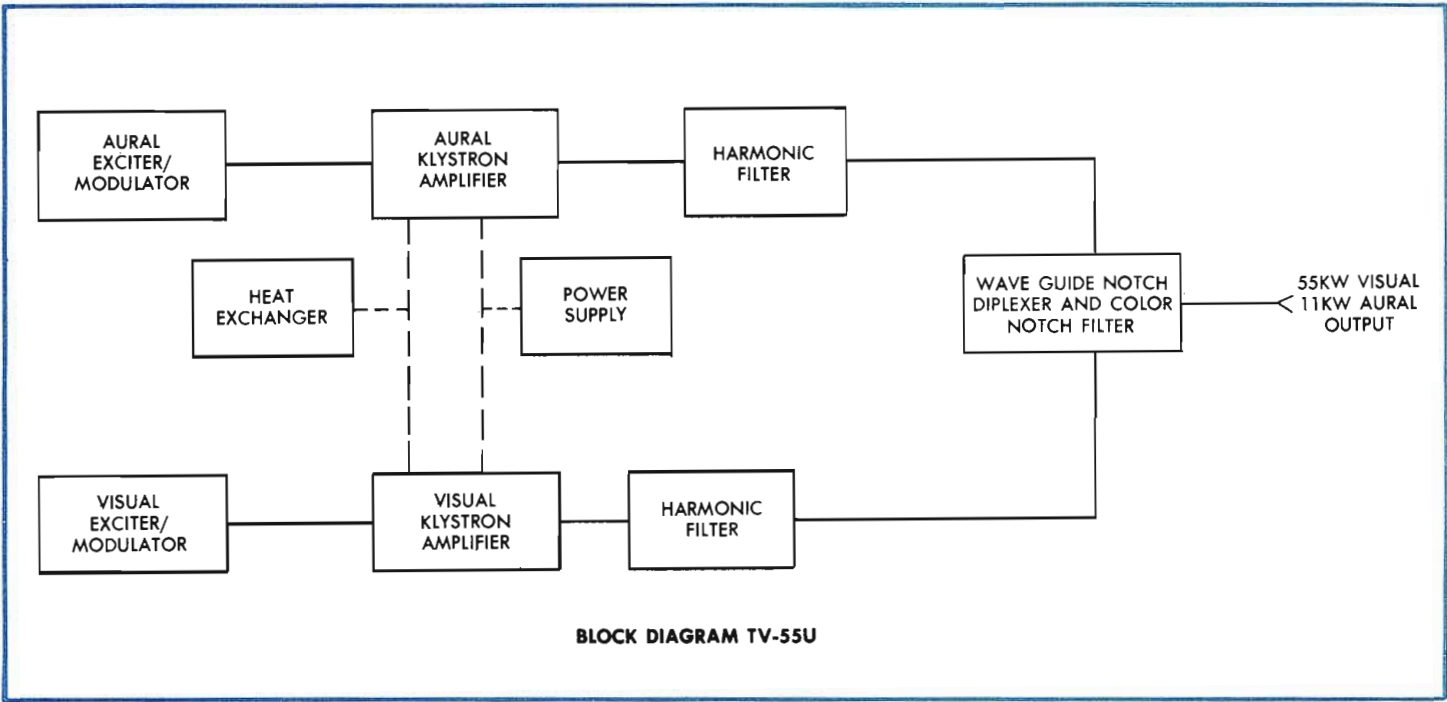

BLOCK DIAGRAM TV-55U

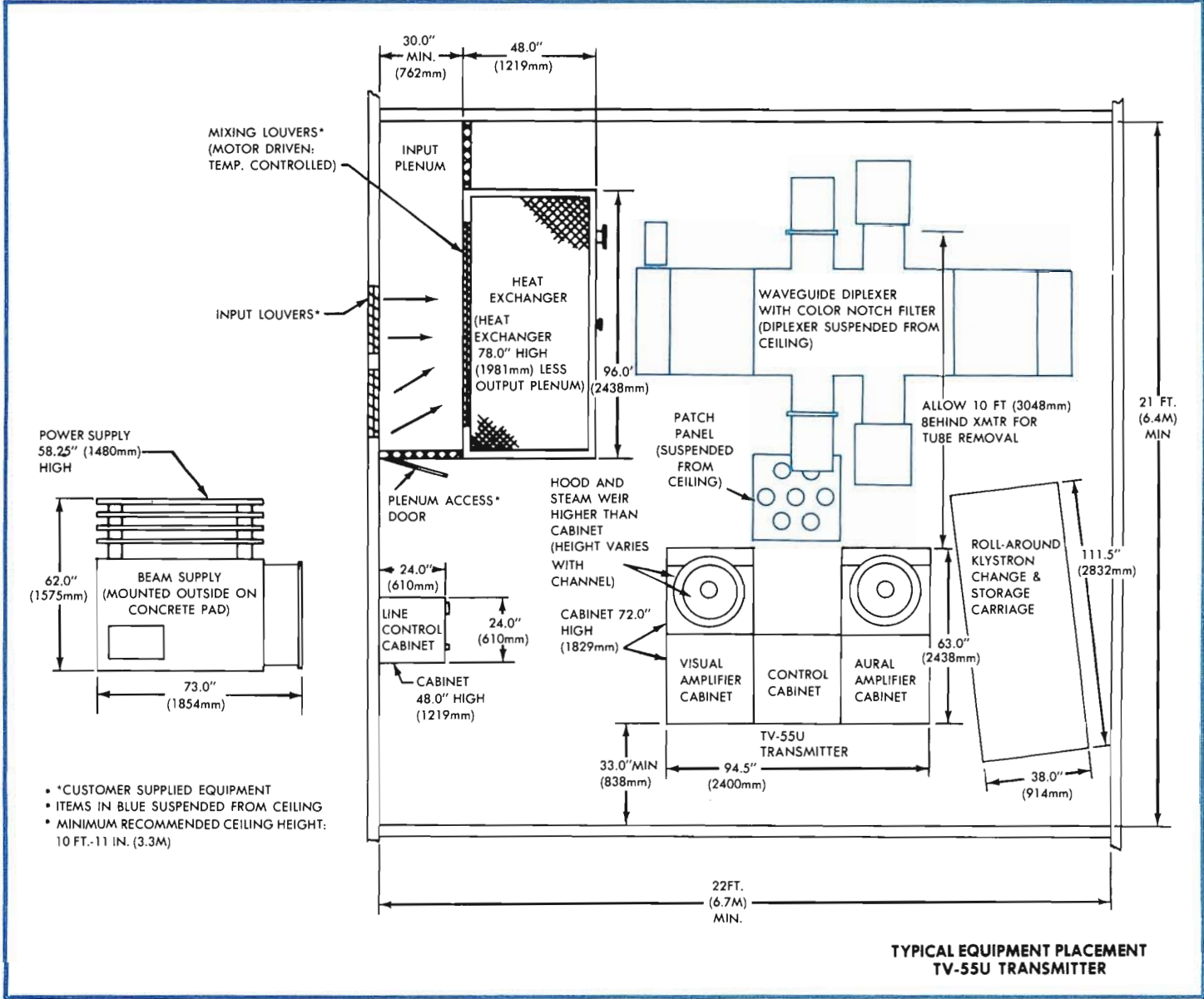

- *CUSTOMER SUPPLIED EQUIPMENT
- ITEMS IN BLUE SUSPENDED FROM CEILING
- MINIMUM RECOMMENDED CEILING HEIGHT: 10 FT.-11 IN. (3.3M)

TV-55U SPECIFICATIONS

VISUAL PERFORMANCE

POWER OUTPUT:
OUTPUT IMPEDANCE:
FREQUENCY RANGE:
CARRIER STABILITY:¹
REG. OF RF OUTPUT POWER (Black to white pic.):
VARIATION OF OUTPUT (over one frame):
VISUAL SIDEBAND RESPONSE: (measured at output of diplexer and color notch filter)

FREQUENCY RESPONSE VS. BRIGHTNESS:²
VISUAL MODULATION CAPABILITY:
DIFFERENTIAL GAIN:³
LINEARITY (LOW FREQUENCY):
DIFFERENTIAL PHASE:⁴
SIGNAL-TO-NOISE RATIO:
K-FACTORS:
EQUIVALENT ENVELOPE DELAY:

VIDEO INPUT:⁵
HARMONIC RADIATION:

AURAL PERFORMANCE

POWER OUTPUT:
OUTPUT IMPEDANCE:
AUDIO INPUT:
FREQUENCY DEVIATION:
INPUT IMPEDANCE:
PRE-EMPHASIS:
FREQUENCY RESPONSE:
DISTORTION:
FM NOISE:
AM NOISE:⁶
FREQUENCY STABILITY:⁷

SERVICE CONDITIONS

AMBIENT TEMPERATURE:
AMBIENT HUMIDITY RANGE:
ALTITUDE:

PHYSICAL AND MECHANICAL DIMENSIONS:

ELECTRICAL REQUIREMENTS:⁸

FCC

55 kW peak.
 From cabinet: 6- $\frac{1}{8}$ " EIA flanged (Channels 14-51). Waveguide (Channels 52-69). Output to antenna: 6- $\frac{1}{8}$ ", 50 ohm, EIA flanged (Channels 14-69).
 470-806 MHz (Channels 14-69).
 ± 500 Hz (maximum variation over 30 days).
 3% or less.
 Less than 2%.
 —3.58 MHz —42 dB or better
 —1.25 MHz and lower —20 dB or better
 Carrier to —0.75 MHz ± 0.5 dB
 Carrier 0 dB reference
 Carrier to +4.18 MHz +0.5 dB, —2.0 dB
 +4.75 MHz and higher —30 dB or better
 ± 0.75 dB.
 1% or better.
 0.5 dB or better.
 1.0 dB or better.
 $\pm 4^\circ$ or better.
 —50 dB or better (RMS) below sync level.
 2 $\frac{1}{2}$ %, 12.5 $\frac{1}{2}$ less than 10% baseline disturbance.
 .05 to 2.1 MHz: ± 40 ns.
 at 3.58 MHz: ± 30 ns.
 at 4.18 MHz: ± 60 ns.
 (referenced to standard curve—FCC).
 75 ohm system.
 —80 dB.

11 kW at diplexer output.
 50 ohms. Output connector: 3- $\frac{1}{8}$ " EIA standard (from cabinet).
 +10 dBm, ± 2 dB.
 ± 25 kHz.
 600 ohms.
 75 microseconds.
 ± 0.5 dB rel. to pre-emphasis (30-15,000 Hz).
 0.5% or less after 75 microseconds de-emphasis with ± 25 kHz deviation.
 —59 dB or better rel. to ± 25 kHz dev.
 —55 dB relative to 100% modulation.
 ± 500 Hz.

+2°C to +50°C (36° to 122°F).
 0 to 95% relative humidity.
 Sea level to 7500 ft. (2286 meters).

94 $\frac{1}{2}$ " W x 63" D x 72" H (240cm W x 160cm D x 183cm H). Weight: 4100 lbs. (1864 kg.). Power supply: 73" W x 62" D x 58 $\frac{1}{4}$ " H (185cm W x 157cm D x 148cm H). Weight: 7450 lbs. (3380 kg.).
 Heat exchanger: 96" W x 48" D x 78" H (244cm W x 122cm D x 198cm H). Weight: 4000 lbs. (1816 kg.).

Power input: 440/460/480 volts, 3 phase, 50/60 Hz. Power consumption (typical): (Channels 14-51)—169 kW (10% aural), 185 kW (20% aural); (Channels 52-69)—249 kW (10% aural), 269 kW (20% aural). Power factor: better than 90%.

SPECIFICATIONS SUBJECT TO CHANGE WITHOUT NOTICE.

- ¹ After initial aging of 60 days.
- ² Measured at 65% and 15% of modulation. Reference 100% = peak of sync.
- ³ Maximum variation of sub-carrier amplitude from 75% to 10% of mod. Sub-carrier mod. percentage: 10% peak to peak.
- ⁴ Maximum variation of sub-carrier phase with respect to burst for mod. percentage from 75% to 10%. Sub-carrier mod. percentage: 10% peak to peak.
- ⁵ Bridging, loop through input with —30 dB or better return loss up to 5.5 MHz.
- ⁶ After de-emphasis.
- ⁷ Relative to frequency offset by 4.5 MHz from the visual carrier.
- ⁸ With pulser (Channels 14-51); consult Harris for Ch. 52-69 pulser applications.

ORDERING INFORMATION

TV-55U 55 kW UHF-TV transmitter for FCC standards service, Channels 14-51, with operating klystrons, semiconductors, crystals, Mod Anode Pulser, VSB filter, harmonic and color notch filters, notch diplexer 994-8458-001
 TV-55UA, as above except without Mod Anode Pulser, for Channels 14-69 994-8006-001



TV-30U

30-Kilowatt UHF Color Television Transmitter

- Advanced Transversal SideBand filter—no group delay, no tuning adjustments required
- Highly linear IF Modulation of the visual and aural carriers for superior color and sound reproduction
- Easily interfaced with ATS and remote control systems
- Outstanding long-term stability and reliability
- High-efficiency 5-cavity klystrons (Ch. 14-51)
- Mod Anode Pulser for increased transmitter efficiency (Ch. 14-51)
- Simple solid-state logic control
- Modular pre-wired cabinets for fast and easy installation

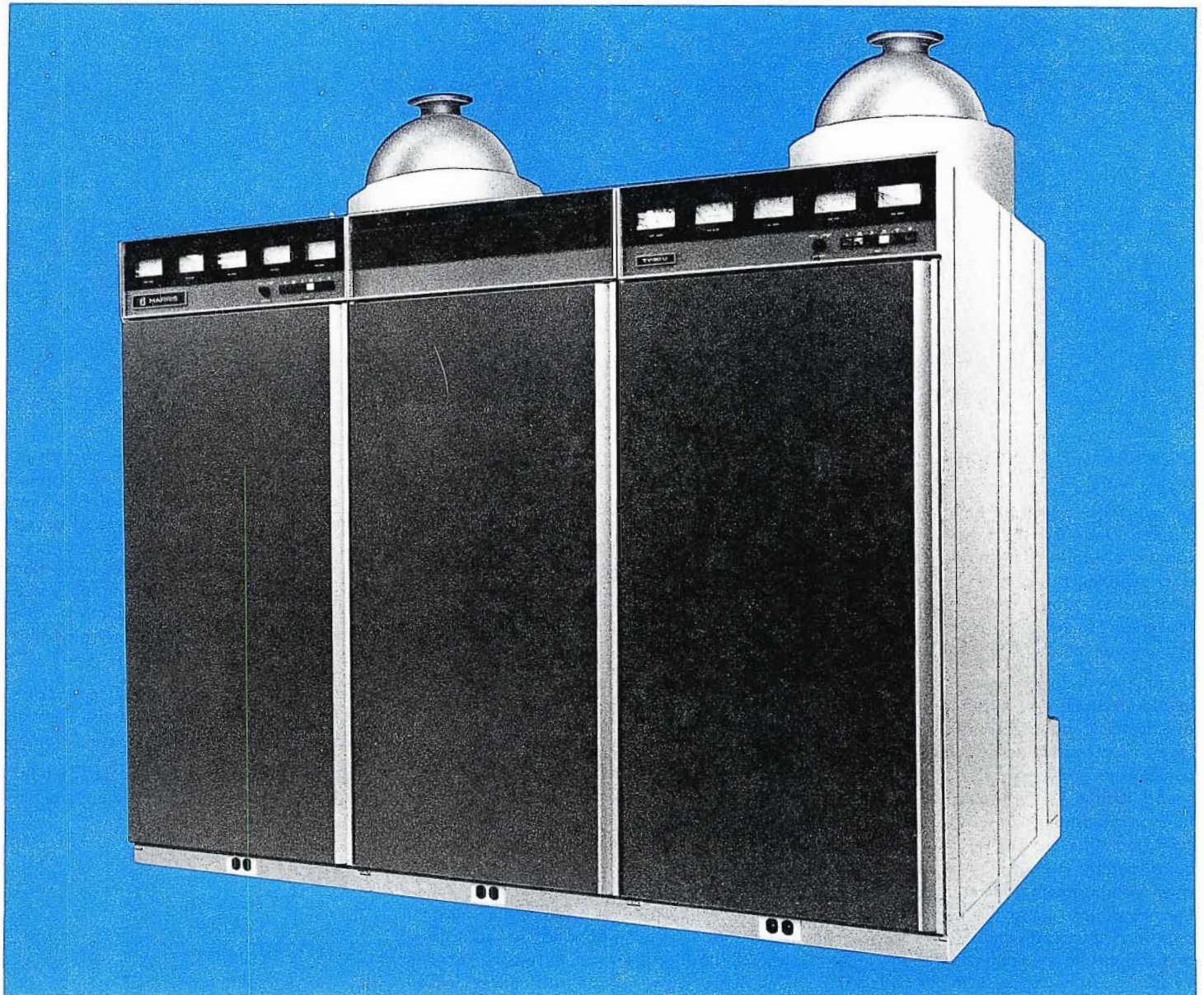

TV-30U

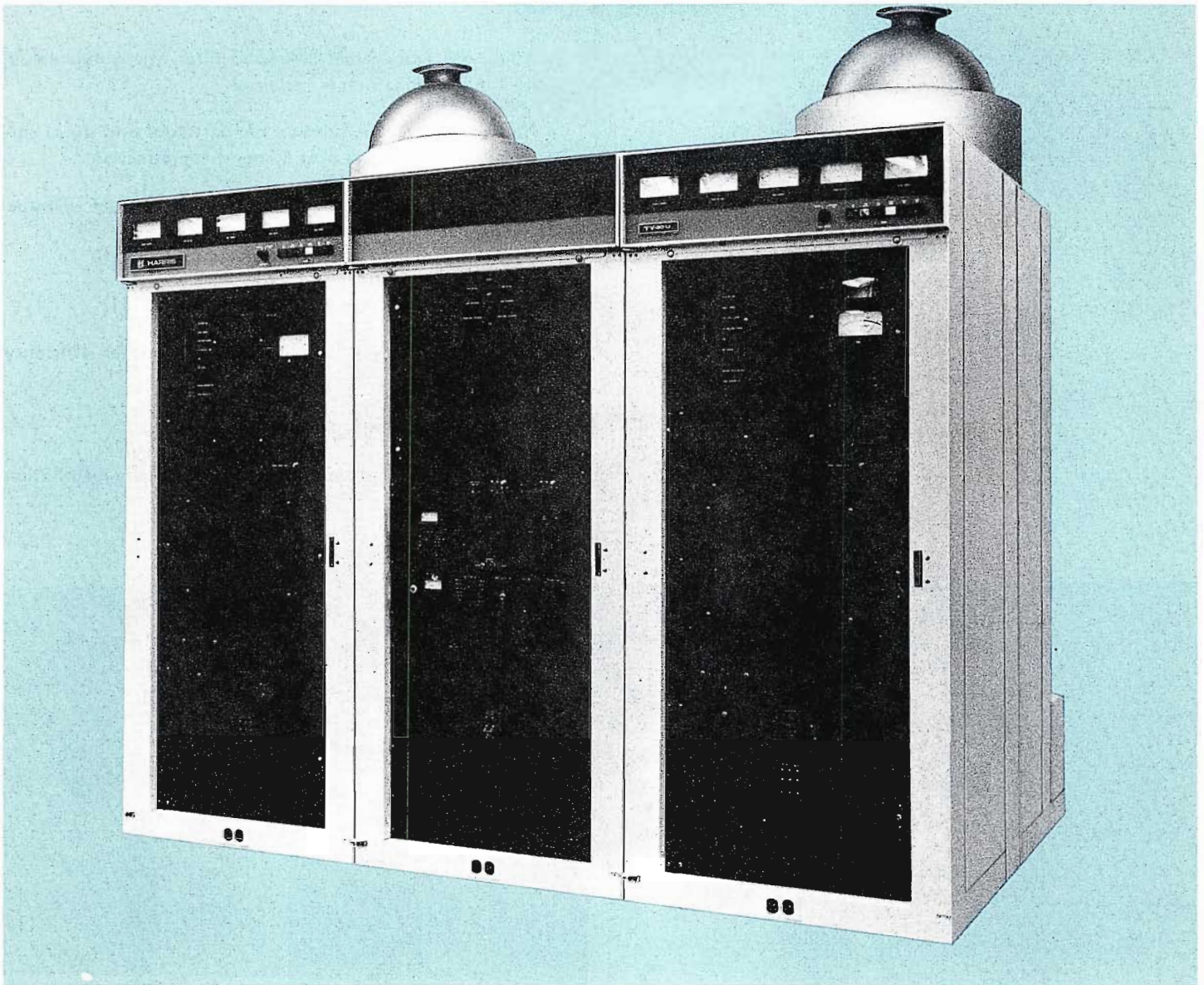

UNSURPASSED PERFORMANCE

Harris' TV-30U is the most advanced 30-kilowatt UHF television transmitter on the market. Designed to meet the high performance standards demanded by today's discriminating broadcaster, this transmitter incorporates the latest state-of-the-art features, such as Harris' solid-state Transversal SideBand (TSB) filter.

IF (intermediate frequency) Modulation, low-level sideband filtering, true linear operation of power amplifiers and solid-state visual and aural exciter/modulators combine to provide outstanding color and sound fidelity. As no envelope delay correction or adjustments are required for the sideband filter, stability, reliability and color quality are greatly enhanced. Frequency adjustment, power output control and amplifier tuning are straightforward and uncomplicated, while design simplicity and conservatively rated components in the TV-30U assure long-term "hands-off" operation and minimum maintenance.

The two five-cavity, vapor-cooled klystrons employed as visual and aural amplifiers in the TV-30U require less than one watt of drive power each to develop full power output. The klystrons are housed in separate cabinets, containing identical control logic, magnetic supplies and overload sensors, and operate independently of one another. Installation or replacement can be accomplished rapidly by one man. Except for the klystrons, the transmitters are totally solid state for stable operation and highest reliability.

TRANSVERSAL SIDEBAND (TSB) FILTER

The Harris solid-state sideband filter is an advanced surface acoustic wave design, and shapes visual sidebands at the IF frequency, rather than "on frequency" at the full output power of the transmitter. Unlike conventional VSB filters, the TSB filter has

an inherent linear phase characteristic, which means that it requires no group delay correction. A conventional VSB filter requires from 600 to 1000 nsec of group delay correction, and many adjustments—the TSB filter requires no correction or adjustments—ever! A conventional VSB filter needs 6 to 12 tuning controls—the TSB filter needs no tuning controls, as it requires no tuning adjustment—ever!

In addition, the TSB has steeper skirts and higher attenuation outside the channel passband for improved VSB wave shaping.

Only 1½ square inches in size, the TSB filter is mounted on a PC board in the visual exciter.

ADVANCED-DESIGN VISUAL AND AURAL EXCITER/MODULATORS

The Harris solid-state MCP visual exciter/modulator is an independent, self-

TV-30U

contained unit which provides a fully processed on-channel picture signal. Power output of the visual exciter/modulator can be varied with a single front panel control, or from a remote location, without retuning of any kind.

The master oscillator is located in the visual exciter in a proportional controlled oven, and master oscillator frequency can be varied ± 500 Hz. With one control, the station engineer can make precise frequency adjustments to both the visual and aural carriers. Actual frequency determining circuitry is also contained in the visual exciter in a proportional controlled oven. Visual modulation takes place at 37.0 MHz (38.9 MHz for CCIR B). Sidebands are filtered by the Harris TSB filter which may be bypassed easily for transmitter tuning and maintenance.

The visual exciter is mounted in a pull-out drawer and may be operated outside the main transmitter for test purposes. A switch and meter mounted on the front panel permit monitoring exciter parameters. Power and video gain controls are motor driven with manual override provision.

The Harris visual exciter/modulator provides great reliability and stability, excellent frequency response, and truest color quality. It is also designed for minimum maintenance and set-up time, and for remote control and unattended operation. This is all made possible through the use of the latest design techniques, including Harris' solid-state TSB filter.

The Harris aural exciter/modulator is a solid-state self-contained unit which furnishes a fully processed aural signal at a level up to .5 watts. Power output can be set with a single knob on the front panel, or by remote control, with no need for retuning.

Audio information is used to modulate a direct FM 32.5 MHz (33.4 MHz for CCIR B) carrier derived from the modulated oscillator in the aural exciter. This information is then translated to the desired "on channel" signal through stable frequency determining circuitry housed in a proportional controlled oven in the visual exciter. A digital phase-locked loop is also used to guarantee absolute frequency stability.

The aural exciter/modulator is mounted in a pull-out drawer, and may be operated with the drawer extended for test purposes. The exciter has been designed for remote control and unattended operation.

IF MODULATION

One of the most important features of the TV-30U is its true low-level IF Modulation,

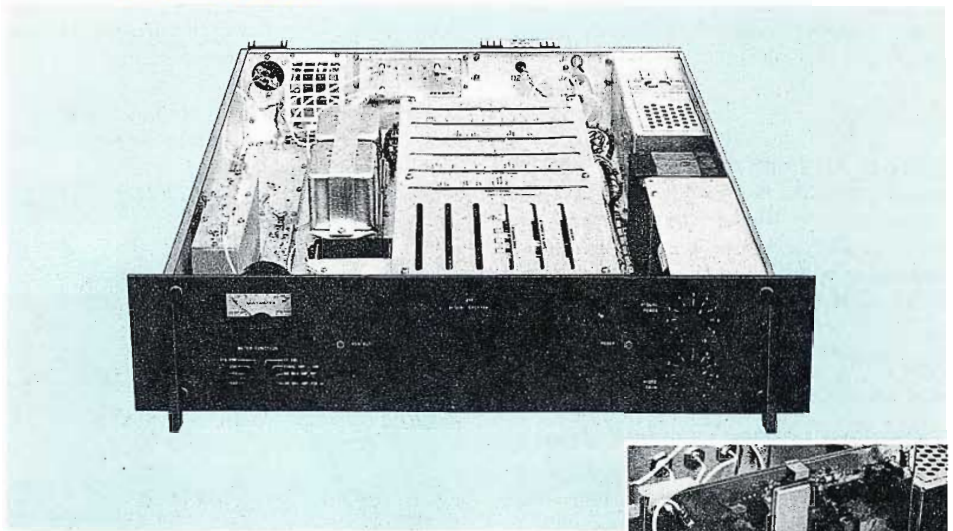

The MCP-1U visual exciter/modulator (above) is a solid-state, independent, self-contained "on-channel" signal source. Harris' advanced TSB filter (right) is mounted on a PC board in the visual exciter, and measures only 1½ inches square.

which offers a top quality picture, and excels in electrical performance, reliability and simplicity of operation.

In the TV-30U the visual and aural exciters generate fully modulated low-level IF signals. The output of a common crystal controlled reference oscillator is used to raise the individual IF signal to the desired "on channel" output frequency.

As it occurs at much lower power levels than conventional designs, intermediate frequency modulation needs fewer circuits to produce a fully processed, quality picture signal. Less than one volt of video signal is needed to modulate the RF carrier.

The Harris ring modulator design permits modulation percentages to approximately 1% without compromising transmitter performance—and eliminates most pre-distortion circuitry. This results in exceptional color performance and nearly perfect signal linearity. Even such colors as highly saturated yellow and cyan are faithfully reproduced with IF Modulation.

Due to the low-level techniques, which include the use of devices such as an extremely linear broadband diode ring modulator, low-level sideband filtering and very linear broadband amplifiers, the broadcast signal is a faithful reproduction of the signal applied to the transmitter input. IF Modulation results in low incidental phase noise, and the elimination of many transmission problems at their source. This means that no half-way measures—such as numerous correction, compensation and feedback circuits—are required to eliminate the effects of these problems later on.

SOLID-STATE CONTROL LOGIC

Complete and foolproof control of all

transmitter functions is achieved through the use of solid-state memory, timing and logic circuits. A self-charging emergency power source is provided to maintain control logic memory during periods of power line failure.

The solid-state control logic and protective circuitry, in addition to commanding normal AC control functions, is also used to visually indicate, through indicator lights, the operating status of the transmitter system. These indicator lights allow easy isolation of circuit faults.

AUTOMATIC RECYCLING

The TV-30U's built-in memory circuitry enables the entire transmitter to return to the air automatically in the state it was operating immediately prior to a partial or full power failure. When the transmitter returns to "on-air", status lights provide visual indication of any malfunctions caused by the outage.

REMOTE CONTROL, UNATTENDED AND AUTOMATIC OPERATION

All control, metering and monitoring circuits have been designed specifically for remote control and automatic operation. The power controls are motor driven and the necessary remote control sampling points are built-in on accessible terminal boards.

Today, Harris TV transmitters are being operated successfully worldwide with and without remote control. In addition, Harris' transmitter design is consistent with anti-

TV-30U

patented automatic transmitter needs in the future.

KLYSTRONS

High gain klystrons, containing five internal cavities, amplify the exciter outputs to the proper power levels. The klystrons are vapor cooled, and are mounted in special assemblies which pivot to allow easy installation. A klystron carriage is provided.

MOD ANODE PULSER

The mod anode pulser provides a means of operating High Efficiency Klystrons at reduced beam current during the video portion of the signal, and high beam current during sync. This optional feature provides a significant reduction in transmitter input power requirements. The mod anode pulser is generally used only with High Efficiency Visual Klystrons.

HEAT EXCHANGER

The unitized heat exchanger employed in the TV-30U contains the cooling core, blower and motor, circulating pump, spare pump, storage tank and control devices. The cooling system is a departure from conventional designs which use individual components which must be installed separately.

HV POWER SUPPLY

The HV power supply is a multi-phase, full wave rectifying system exhibiting very low ripple content prior to output filtering. It is designed for excellent regulation. This power supply, including transformer and solid-state rectifiers, is housed in a single assembly, mounted externally from the transmitter. Routine maintenance access is provided by a removable panel.

EASE OF MAINTENANCE AND INSTALLATION

Total transmitter component accessibility is provided, front and back. Visual and aural exciters slide out and can operate independently from the transmitter outside the exciter/driver cabinet. Various exciter circuits, such as oscillators, modulators and processing circuitry, are of modular construction and can be removed for maintenance or replacement.

Easy-to-read, eye-level 4-inch meters are used to monitor required transmitter functions. Meter panels are of double-hinged construction for convenient access during maintenance. A complete system of overload indicators is also provided in each cabinet for monitoring transmitter operation. In the event of a transmitter malfunction,

an examination of the indicators will locate the problem area.

The transmitter has been built in a modular fashion so that cabinets may be separated

into convenient, easy-to-handle sub-assemblies to facilitate installation. Additionally, the compact design of the TV-30U minimizes space requirements in the transmitter building.

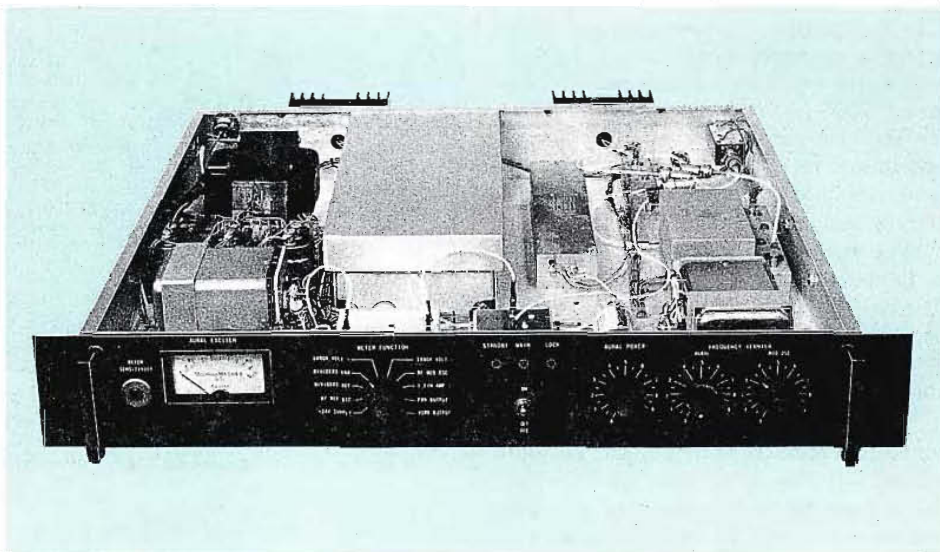

The aural exciter/modulator is a solid-state, self-contained unit.

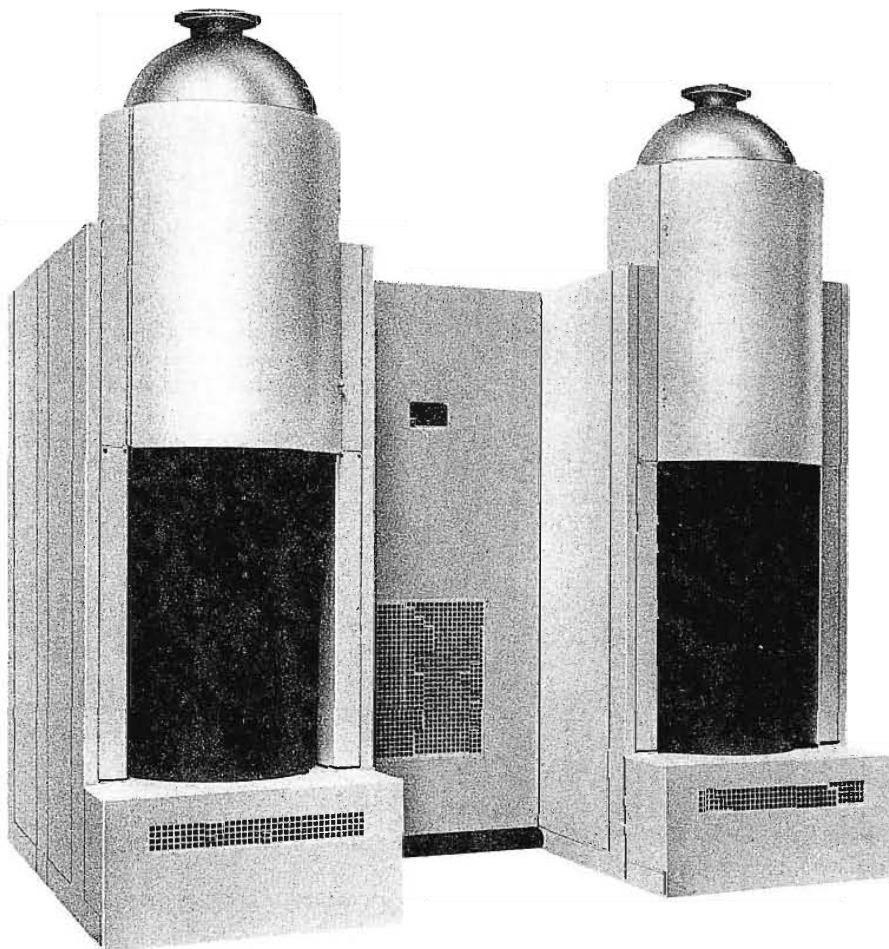

TV-30U, rear view.

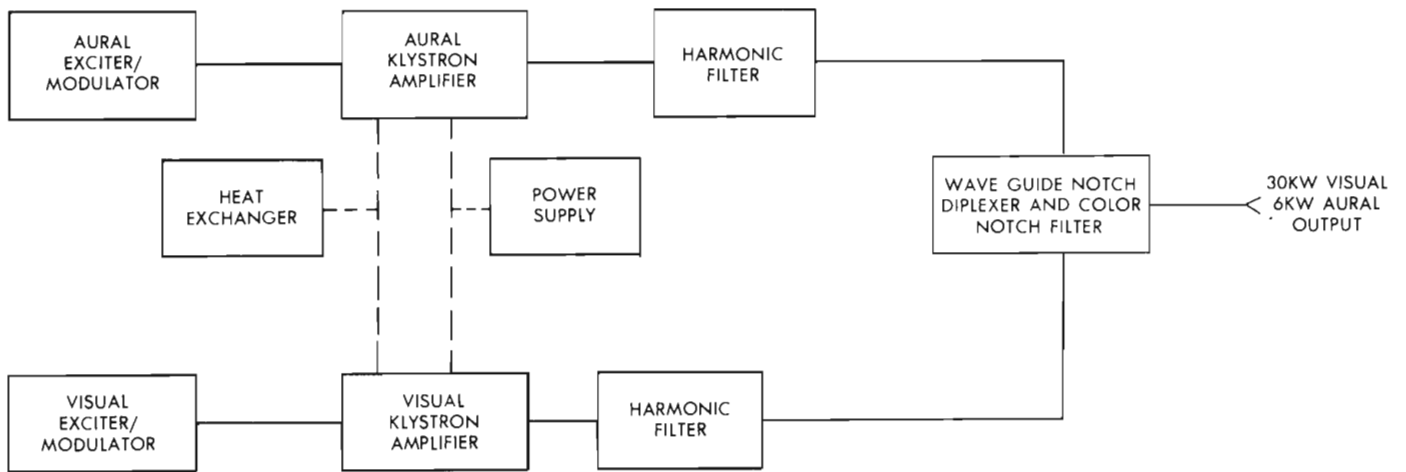

BLOCK DIAGRAM TV-30U

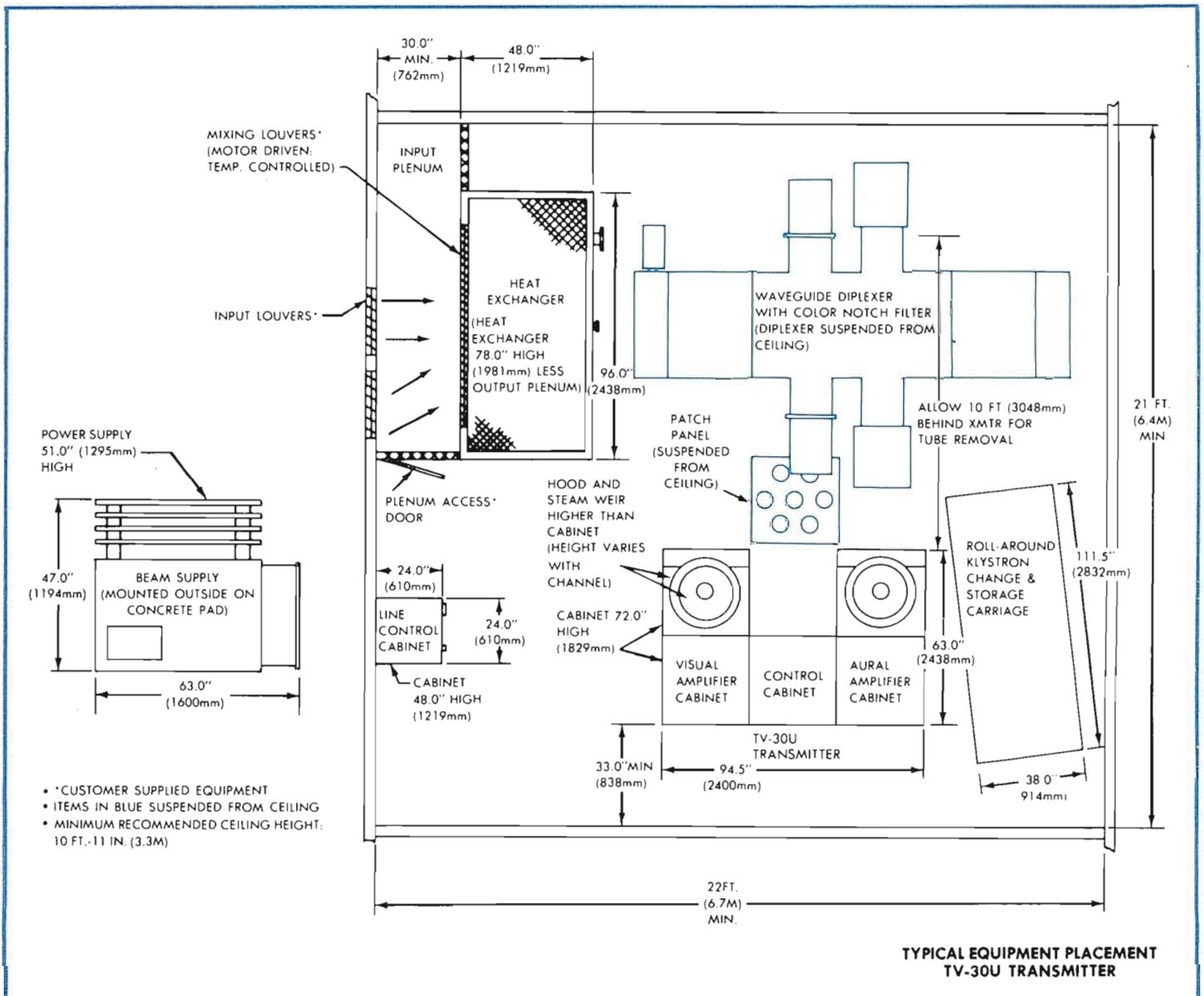

TYPICAL EQUIPMENT PLACEMENT TV-30U TRANSMITTER

- *CUSTOMER SUPPLIED EQUIPMENT
- ITEMS IN BLUE SUSPENDED FROM CEILING
- MINIMUM RECOMMENDED CEILING HEIGHT: 10 FT.-11 IN. (3.3M)

TV-30U SPECIFICATIONS

VISUAL PERFORMANCE

POWER OUTPUT:
OUTPUT IMPEDANCE:
FREQUENCY RANGE:
CARRIER STABILITY:¹
REG. OF RF OUTPUT POWER (Black to white pic.):
VARIATION OF OUTPUT (over one frame):
VISUAL SIDEBAND RESPONSE (Measured at output of diplexer and color notch filter):

FREQUENCY RESPONSE VS. BRIGHTNESS:²
VISUAL MODULATION CAPABILITY:
DIFFERENTIAL GAIN:³
LINEARITY (LOW FREQUENCY):
DIFFERENTIAL PHASE:⁴
SIGNAL-TO-NOISE RATIO:
K-FACTORS:
EQUIVALENT ENVELOPE DELAY:

VIDEO INPUT:⁵
HARMONIC RADIATION:

AURAL PERFORMANCE

POWER OUTPUT:
OUTPUT IMPEDANCE:
AUDIO INPUT:
FREQUENCY DEVIATION:
INPUT IMPEDANCE:
PRE-EMPHASIS:
FREQUENCY RESPONSE:
DISTORTION:
FM NOISE:
AM NOISE:⁶
FREQUENCY STABILITY:⁷

SERVICE CONDITIONS

AMBIENT TEMPERATURE:
AMBIENT HUMIDITY RANGE:
ALTITUDE:

PHYSICAL AND MECHANICAL DIMENSIONS:

ELECTRICAL REQUIREMENTS:

⁸

FCC

30 kW peak.
 From cabinet: 3-1/8" EIA flanged (Channels 14-51). 6-1/8" EIA flanged (Channels 52-69). Output to antenna: 6-1/8", 50 ohm, EIA flanged. 470-806 MHz (Channels 14-69).
 ±500 Hz (maximum variation over 30 days).
 3% or less.
 Less than 2%.
 —3.58 MHz —42 dB or better
 —1.25 MHz and lower —20 dB or better
 Carrier to —0.75 MHz ±0.5 dB
 Carrier 0 dB reference
 Carrier to +4.18 MHz +0.5 dB, —2.0 dB
 +4.75 MHz and higher —30 dB or better
 ±0.75 dB.
 1% or better.
 0.5 dB or better.
 1.0 dB or better.
 ±4° or better.
 —50 dB or better (RMS) below sync level.
 2± 2%, 12.5± less than 10% baseline disturbance.
 .05 to 2.1 MHz: ± 40 ns.
 at 3.58 MHz: ± 30 ns.
 at 4.18 MHz: ± 60 ns.
 (referenced to standard curve—FCC).
 75 ohm system.
 —80 dB.

6 kW at diplexer output.
 50 ohms. Output connector: 3-1/8" EIA standard (from cabinet).
 +10 dBm, ±2 dB.
 ±25 kHz for 100% modulation.
 600 ohms.
 75 microseconds.
 ±0.5 dB rel. to pre-emphasis (30-15,000 Hz).
 0.5% or less after 75 microseconds de-emphasis with ±25 kHz deviation.
 —59 dB or better rel. to ±25 kHz dev.
 —55 dB relative to 100% modulation.
 ±500 Hz.

+2°C to +50°C (36° to 122°F).
 0 to 95% relative humidity.
 Sea level to 7500 ft. (2286 meters).

94 1/2" W x 63" D x 72" H (240cm W x 160cm D x 183cm H). Weight: 4100 lbs. (1864 kg.). Power supply: 63" W x 47" D x 51" H (160cm W x 119cm D x 130cm H). Weight: 4700 lbs. (2133 kg.).
 Heat exchanger: 96" W x 48" D x 78" H (244cm W x 122cm D x 198cm H). Weight: 4000 lbs. (1816 kg.).

Power input: 440/460/480 volts, 3 phase, 50/60 Hz. Power consumption (typical): 146 kW (20% aural); 137 kW (10% aural) Channels 14-69. Power factor: better than 90%.

SPECIFICATIONS SUBJECT TO CHANGE WITHOUT NOTICE.

- ¹ After initial aging of 60 days.
- ² Measured at 65% and 15% of modulation. Reference 100%=peak of sync.
- ³ Maximum variation of sub-carrier amplitude from 75% to 10% of mod. Sub-carrier mod. percentage: 10% peak to peak.
- ⁴ Maximum variation of sub-carrier phase with respect to burst for mod. percentage from 75% to 10%. Sub-carrier mod. percentage: 10% peak to peak.
- ⁵ Bridging, loop through input with —30 dB or better return loss up to 5.5 MHz.
- ⁶ After de-emphasis.
- ⁷ Relative to frequency offset by 4.5 MHz from the visual carrier.
- ⁸ Optional pulser reduces power consumption approximately 16 kW.

ORDERING INFORMATION

TV-30UA, 30 kW UHF-TV transmitter for FCC standards service, Channels 14-69, with operating klystrons, semiconductors, crystals, VSB filter, harmonic and color notch filters, notch diplexer 994-8004-001
 TV-30U, as above except with Mod Anode Pulser, for Channels 14-51 994-8485-001



MCP-1U

UHF-TV Visual Exciter/Modulator

- More than a two-to-one improvement in color performance specifications
- TSB (Transversal SideBand) filter requires no group delay correction, no adjustments—only 1½ inches square
- Exciter interfaces with all Harris' UHF IF Modulation transmitters
- Excellent reliability and stability
- Easy serviceability

With the introduction of the MCP-1U visual exciter/modulator, Harris presents the television industry with the best color performance specifications ever offered in UHF-TV transmitting equipment! This dramatic advancement in color performance is made possible through the use of IF Modulation, pioneered in the United States by Harris, and through the use of recent breakthroughs in filtering technology. In the MCP-1U, Harris has combined IF Modulation and Transversal SideBand filtering to achieve better than two-to-one improvements in the important color parameters of differential phase, differential gain and frequency response.

TRANSVERSAL SIDEBAND FILTER. The Harris solid-state vestigial sideband filter is an advanced surface acoustic wave design, and shapes visual sidebands at the IF frequency, rather than "on frequency" at the full output power of the transmitter. Unlike conventional filters, the TSB filter has an inherent linear phase characteristic, which means that it requires no group delay correction. A conventional filter requires from 600 to 1000 nsec of group delay correction, and many adjustments—the TSB filter requires no correction or adjustments—ever! A conventional filter needs 6 to 12 tuning controls—the TSB filter needs no tuning controls. As no envelope delay correction or adjustments are required, color quality, stability and reliability are greatly enhanced. The TSB filter also offers great temperature stability, and is unaffected by aging.

In addition, the TSB filter has steeper skirts and higher attenuation outside the channel passband for improved wave shaping.

Only 1½ square inches in size, the filter is mounted on a PC board in the MCP-1U.

IF MODULATION. The refined IF Modulation techniques used in the MCP-1U offer inherently low values in differential phase and differential gain without the use of complex precorrection or feedback circuits.

INDEPENDENT, SELF-CONTAINED UNIT. The maximum color performance MCP-1U is an independent, self-contained unit which provides a fully processed on-channel picture signal. Power output can be varied up to one watt with a single front panel control with no adjustment of transmitter tuning controls.

The exciter is mounted in a pull-out drawer, and may be operated outside the main transmitter for test purposes. It is designed for minimum maintenance and set-up time, and for remote control and unattended operation.

The MCP-1U is standard in all of Harris' "U2" series of TV transmitters—and interfaces easily with any Harris UHF IF Modulation TV transmitter. See the reverse side for specifications and ordering information.

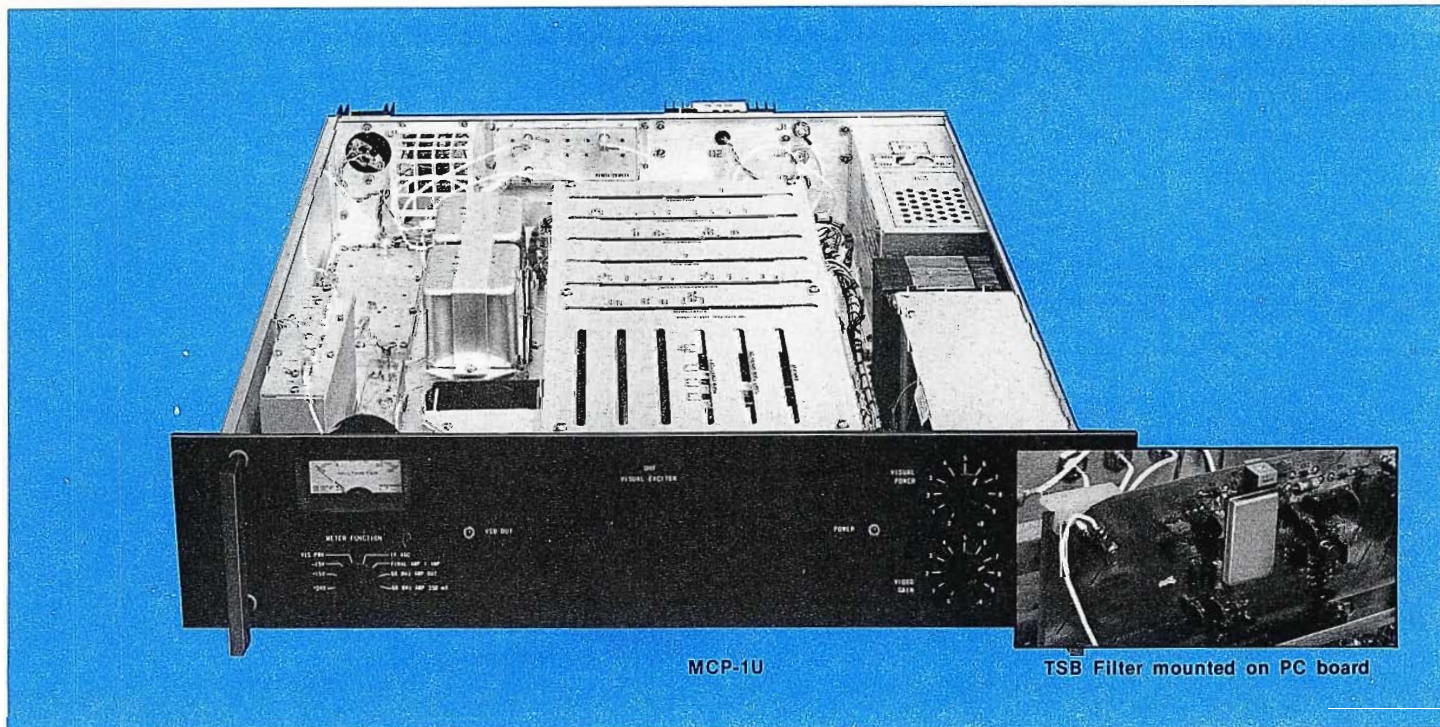

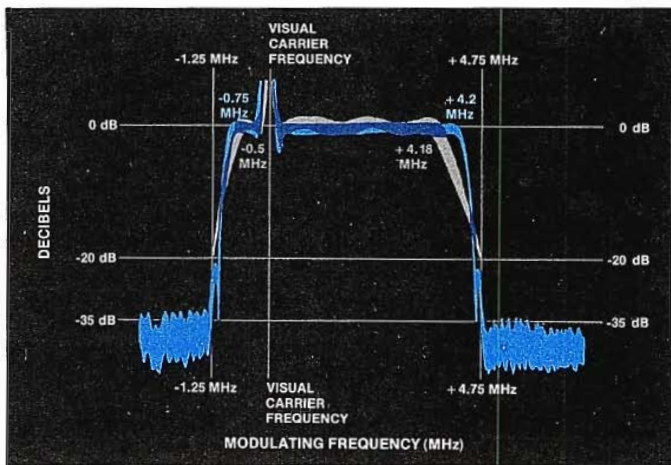

Sideband response of MCP-1U exciter (in blue) showing improvement over typical response of older exciters (shown in gray).

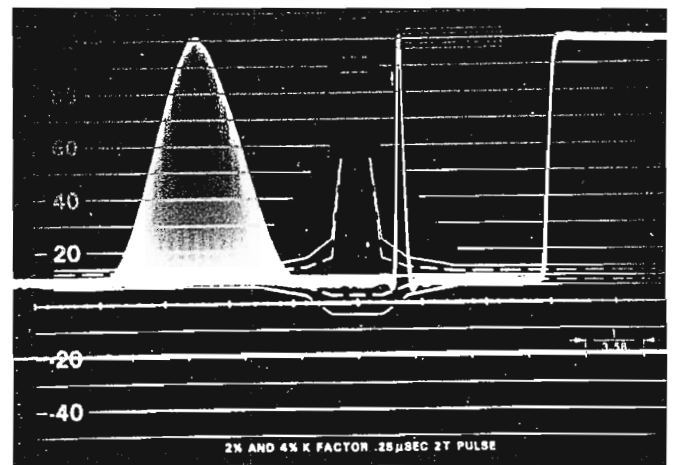

Waveforms of 12.5t, 2t and window pulses showing responses through the MCP-1U visual exciter.

MCP-1U SPECIFICATIONS

VISUAL PERFORMANCE

POWER OUTPUT:
 OUTPUT IMPEDANCE:
 FREQUENCY RANGE:
 CARRIER STABILITY:¹
 REG. OF RF OUTPUT POWER(Black to white pic.):
 VARIATION OF OUTPUT (over one frame):
 VISUAL SIDEBAND RESPONSE:

FREQUENCY RESPONSE VS. BRIGHTNESS:²
 VISUAL MODULATION CAPABILITY:
 DIFFERENTIAL GAIN:³
 LINEARITY (LOW FREQUENCY):

DIFFERENTIAL PHASE:⁴
 SIGNAL-TO-NOISE RATIO:
 K FACTORS:
 EQUIVALENT ENVELOPE DELAY:

VIDEO INPUT:⁵
 HARMONIC RADIATION⁶

SERVICE CONDITIONS

AMBIENT TEMPERATURE:
 AMBIENT HUMIDITY RANGE:
 ALTITUDE:
 PHYSICAL AND MECHANICAL DIMENSIONS:

ELECTRICAL REQUIREMENTS:

1 After initial aging of 60 days.
 2 Measured at 10% and 90% APL relative to 50% APL.
 3 Maximum variation of sub-carrier amplitude from 75% to 10% of mod. Sub-carrier mod. percentage: 10% peak to peak.
 4 Maximum variation of sub-carrier phase with respect to burst for mod. percentage from 75% to 10%. Sub-carrier mod. percentage: 10% peak to peak.
 5 -30 dB or better return loss up to 5.0 MHz.
 6 The MCP-1U exciter does not provide sufficient selectivity in the exciter alone to meet FCC and CCIR transmitter specifications for -3.58 MHz suppression or harmonic radiation. However, when the MCP-1U is used in a Harris IF modulated transmitter, FCC and CCIR performance requirements in these areas will be met or exceeded.

FCC

0.75 watt peak of sync.
 50 ohms unbalanced. Output connector: BNC.
 Channels 14-69 (470-806 MHz).
 ± 500 Hz (maximum variation per month).
 1% or less.
 1% or less.
 -1.25 MHz and lower Carrier to -0.75 MHz ± 0.5 dB
 Carrier 0 dB reference
 Carrier to + 4.20 MHz ± 0.5 dB
 + 4.75 MHz and higher -30 dB
 ± 0.25 dB.
 3% or better.
 3% maximum.
 0.5 dB or better.
 ± 2° maximum.
 -58 dB or better (RMS) below sync level.
 2t 2%, 12.5t less than 5% baseline disturbance.
 0.5 to 2.1 MHz: ± 40 ns
 at 3.58 MHz: ± 30 ns
 at 4.18 MHz: ± 60 ns
 (referenced to standard curve-FCC)
 75 ohm, terminated.
 -20 dB.

-10° to +60° (14° to 140°F).
 0 to 95% relative humidity.
 Sea level to 10,000 feet.
 24" W x 22" D x 5.25" H. Weight: 38 lbs.

105-125 VAC or 210-250 VAC, 50/60 Hz. Power consumption: 150 VA maximum.

CCIR (System "G")

0.75 watt peak of sync.
 50 ohms unbalanced. Output connector: BNC.
 Bands IV & V: E21-E68 (470-806 MHz).
 ± 500 Hz (maximum variation per month).
 1% or less.
 1% or less.
 -1.25 MHz and lower Carrier to -0.75 MHz ± 0.5 dB
 + 1.5 MHz 0 dB reference
 + 1.5 MHz to 5.0 MHz ± 0.5 dB
 + 5.5 MHz and higher -30 dB
 ± 0.25 dB.
 3% or better.
 3% maximum.
 Amplitude dev. $\frac{5}{\text{min}} \frac{5}{\text{max}}$ better than 0.5 dB mod. with signal No. 3 CCIR, from 10% to 85% in frequency range 1 to 5 MHz.
 ± 2° maximum.
 -40 dB pp below black to white transition.
 2t 2%, 20t 3% or better.
 0.5 to 4.5 MHz: ± 50 ns
 4.5 to 4.8 MHz: ± 100 ns
 (measured with Nyquist demodulator meeting ARD specifications).
 75 ohm, terminated.
 -20 dB.

-10° to +60° C.
 0 to 95% relative humidity.
 Sea level to 3000 meters.
 61 cm W x 55.9 cm D x 13.3 cm H. Weight: 17.3 kg.
 105-125 VAC or 210-250 VAC, 50/60 Hz. Power consumption: 150 VA maximum.

ORDERING INFORMATION

MCP-1U visual exciter/modulator for FCC standards service, Channels 14-69	994-8003-001
MCP-1U retrofit visual exciter/modulator for FCC standards service, Channels 14-69	994-8137-001
MCP-1U visual exciter/modulator for CCIR System "G" service, Bands IV & V (E21-E68)	994-8003-002
Automatic exciter/modulator switcher (optional)	994-7076-001
RAK-96 basic rack (24") for mounting backup exciter, automatic exciter switcher	448-0636-000
Side panel kit for RAK-96. Includes two panels in Harris' white finish	448-0589-000
Front trim kit for RAK-96. Trim in brushed aluminum with Harris' blue insert	448-0637-000
Door handle with lock for rear door of RAK-96	448-0559-000



CPV CIRCULARLY POLARIZED TELEVISION ANTENNA

- Tower loading comparable to Batwing and traveling wave antennas
- Top mount design
- Excellent axial ratio—reduces ghosting effects
- High power handling capabilities
- Requires no electrical deicing
- Superb horizontal circularity
- Excellent control of vertical pattern
- Horizontal plane pattern directional capability
- Antenna elements are at DC ground potential for lightning protection

Harris' new circularly polarized television broadcast antenna, the CPV, features a top mount design with windloading specifications comparable to Batwing and traveling wave antennas. Now a broadcaster may simply replace his present antenna with a CPV—with only minor modifications to his tower!

In addition to its outstanding mechanical specifications, the CPV antenna also features excellent circularity (standard omnidirectional pattern varies less than ± 2 dB); low axial ratio (less than 2 dB); VSWR less than 1.05:1 at visual carrier and below 1.1:1 over each channel; directional horizontal pattern capability; and a variety of vertical patterns that may be tailored to specific coverage requirements. Harris has spent years in research and development of the CP concept for TV broadcasting, so that the current design now combines optimum circularly polarized performance with all of the regular features of the Harris line of television antennas.

With the Harris CPV, picture quality may be improved through ghost reduction. Also, increased signal-to-noise ratios may be achieved whether the viewer uses a CP receiving antenna, conventional rabbit ears or an ordinary outside receiving antenna.

DESIGN. Each bay of the CPV consists of three crossed vee dipoles mounted at 120° intervals around a vertical mast. These dipoles are separated by three vertical grids which isolate the vee dipoles and provide horizontal beam shaping. Each set of crossed dipoles is fed in phase quadrature to produce rotating RF energy. The signal emanating from each set of dipoles is considered right hand circular when the field rotation is clockwise as viewed in the direction of propagation.

The Harris CPV is available with power ratings up to 100 kilowatts, and a special wideband flat dipole is used to safely handle

the required power levels. Each dipole is mechanically supported and fed from special baluns for both vertical and horizontal polarization. Because of their independent nature, either the horizontal or both sets of elements may be driven to provide horizontal or circular polarization. In addition, the baluns provide DC ground potential to each dipole element for lightning protection for antenna and transmitter.

Radomes are standard with the CPV, and eliminate the need for electrical deicing in virtually all environments. This can result in substantial savings each year in electrical heating costs—in addition to the initial savings in not having to purchase heater elements, transformers and wiring.

AXIAL RATIO. The CPV has superb axial ratio characteristics as a direct result of the precise tailoring of the radiated pattern of the vee dipoles. Axial ratio, the ratio of the major and minor axes of the polarization ellipse, critically defines the quality of a radiating element. When circularly polarized receiving antennas are used by the viewer, reflected signals are attenuated, thereby reducing ghosting effects.

VERTICAL PATTERN. Vertical pattern contouring to introduce beam tilt and null fill may be provided by means of standard phase distribution techniques—such as those used in many successful Batwing installations. Control of the vertical pattern is accomplished with no degradation of the axial ratio. Therefore, contoured vertical patterns are available much the same as in conventional horizontally polarized TV antennas.

HORIZONTAL CIRCULARITY. For omnidirectional stations, the shape of the horizontal pattern will vary from omni by less than ± 2 dB. Stations employing directional arrays will find one of the several patterns available to be ideally suited to their specific need.



Preliminary mechanical specifications for typical CPV models are shown in the charts below. These values are based on a 50 lb./sq. ft. EIA wind. From the comparisons listed below each chart, it is apparent that, bay for bay, the tower loading of the

CPV is usually below that of the Batwing. Also, tower loading of the CPV is below that of the corresponding traveling wave antenna in most cases.

CPV Low Band—gain 2.7 per polarization (allows for 15% null fill)

CHANNEL	NO. OF BAYS	HEIGHT (FEET)	RAD. CENTER (FEET)	SHEAR (LBS.)	MOMENT (FT.-LBS.)	WEIGHT (LBS.)
2	6	100.5	47.3	10,200	388,170	17,800
3	6	95.0	44.8	9,235	334,500	16,900
4	6	82.9	38.2	7,625	236,160	12,500
5	6	76.8	35.8	6,675	191,975	11,320
6	6	71.5	33.3	6,280	166,950	10,100

(For a six-bay Batwing for Channels 2-3, the overturn moment is 335,720 ft.-lbs., and the weight is 16,900 lbs. For a six-bay Batwing for Channels 4-6, the overturn moment is 229,180 ft.-lbs., and the weight is 12,000 lbs.)

CPV High Band—gain 5.7 per polarization (allows for 15% null fill)

CHANNEL	NO. OF BAYS	HEIGHT (FEET)	RAD. CENTER (FEET)	SHEAR (LBS.)	MOMENT (FT.-LBS.)	WEIGHT (LBS.)
7	12	70.3	33.7	4,965	156,592	8,553
8	12	70.3	33.7	4,952	156,156	8,543
9	12	66.2	31.6	4,698	139,000	7,459
10	12	66.2	31.6	4,673	138,810	7,441
11	12	61.9	29.5	4,394	121,426	6,869
12	12	61.9	29.5	4,372	120,779	6,854
13	12	61.9	29.5	4,353	120,210	6,841

(For a 12-bay Batwing for Channels 7-13, the overturn moment is 151,300 ft.-lbs., and the weight is 12,200 lbs. For a TW-12 traveling wave antenna for Channel 12 the overturn moment is 144,400 ft.-lbs. with slot covers, and 187,000 ft.-lbs. with radomes.)

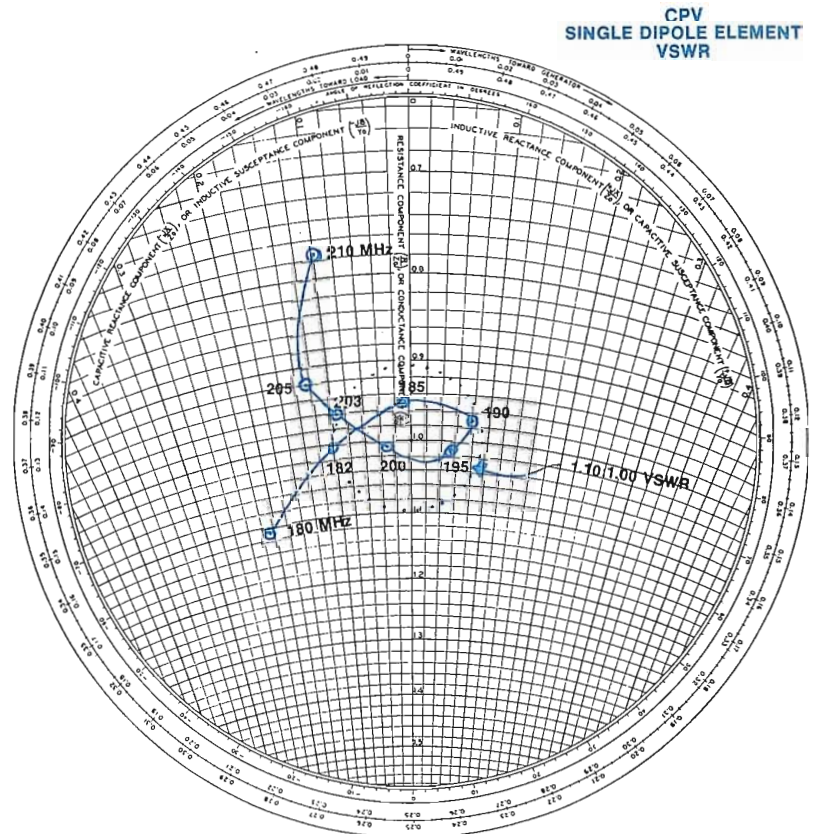
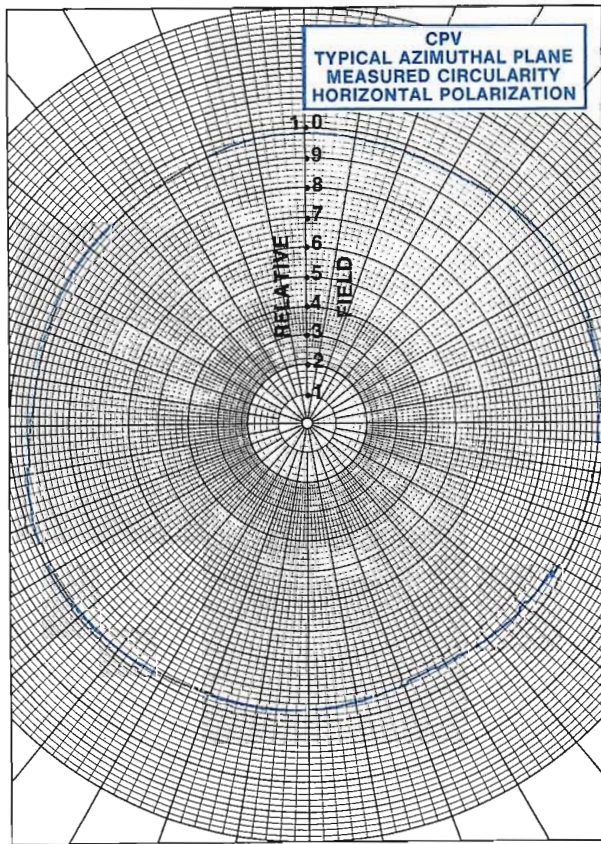



HARRIS
COMMUNICATIONS AND
INFORMATION HANDLING

CIRCULARLY POLARIZED TELEVISION ANTENNA

- Excellent axial ratio--reduces ghosting effects
- Wide bandwidth permits multiplexing of all V.H.F. high-band T.V. channels
- High power handling capabilities
- Requires no electrical de-icing when used with radomes
- Wire-mesh cavity design minimizes windloading
- Superb horizontal circularity
- Excellent control of vertical pattern
- Antenna elements are at D.C. ground potential for lightning protection
- Horizontal elements may be driven independent of vertical elements

The new Harris Cavity Backed Radiator (CBR) circularly polarized television broadcast antenna offers the ultimate in television signal transmission and reception. Whether the viewer uses a circularly polarized receiving antenna, conventional rabbit ears or ordinary outside receiving antenna, picture quality may be improved with the reduction of ghosting and/or increased signal to noise ratios.

In addition, the extremely wide bandwidth inherent in Harris' CBR antennas permits multiplexing of any two or more stations in the VHF high-band channels. All cavity backed radiators are designed, built and tested at the Harris antenna test facility, assuring the optimum in axial ratio, horizontal circularity and vertical pattern shape.

CBR DEVELOPMENT. Harris has spent more than 2 years in research and development of the circular transmission concept for television broadcasting. Basic design objectives of the CP antenna stressed optimum circularly polarized performance, combined with all of the conventional features of the Harris line of television antennas. Theoretical design followed by extensive prototype testing has proven the CBR to be the best approach to circularly polarized transmission to date.



The Harris Cavity Backed Radiator consists of a crossed dipole radiator fed in phase quadrature and mounted within a circular cavity director. Rotating RF energy is produced when the cavity is excited by the dipole elements. The signal emanating from the cavity is considered right-hand circular when the field of rotation is clockwise as viewed in the direction of propagation. Cavity size is principally determined by beamwidth requirements. A beamwidth of 90 degrees is required for a 4-around array and 120 degrees is required for a 3-around array, (measured at the half-voltage coordinates).

GRID CAVITY. The cavity used in the Harris circularly polarized television antenna is welded steel grid which is then galvanized. The cavity grid is supported from a center mounting plate, which also serves as a mounting for the dipole assembly and for attachment of the unit to the supporting structure.

Radomes, standard with the Harris CBR circularly polarized TV antenna, eliminate the need for electrical de-icing in virtually all environments. This can save hundreds of dollars per year in electrical heating costs--in addition to the savings in not having to purchase heater elements, transformers and wiring. The combination of grid cavities and aerodynamically designed radomes minimizes windloading of the Harris C P antenna.

DIPOLE ELEMENTS. A special wideband flat dipole is used for excitation of the cavity and to safely handle the required power

levels. Each dipole is mechanically supported and fed from special baluns for both vertical and horizontal polarization. Because of their independant nature, either the horizontal or both sets of elements may be driven to provide horizontal or circular polarization. In addition, the baluns provide D.C. ground potential to each dipole element for lightning protection for antenna and transmitter.

AXIAL RATIO. The Harris CBR antenna has superb axial ratio characteristics as a direct result of the precise tailoring of the radiated pattern by the cavity. Axial ratio, the ratio of the major and minor axes of the polarization ellipse, critically defines the quality of a radiating element. When circularly polarized receiving antennas are used by the viewer, reflected signals are attenuated, thereby reducing ghosting effects.

WIDE BANDWIDTH. Maximum utilization of antenna aperture is realized with the Harris CP antenna because two, three or more VHF high-band stations may feed one structure. Multiplexing has become a significant factor in reducing station costs in view of the recent increases in the price of tower structures. The broadband radiating element used in conjunction with conventional high power hybrid junctions assures excellent performance over all channels from 7-13. VSWR is 1.1:1 or better at any frequency between channels 7 and 13 as illustrated in the measured VSWR graph on the facing page.

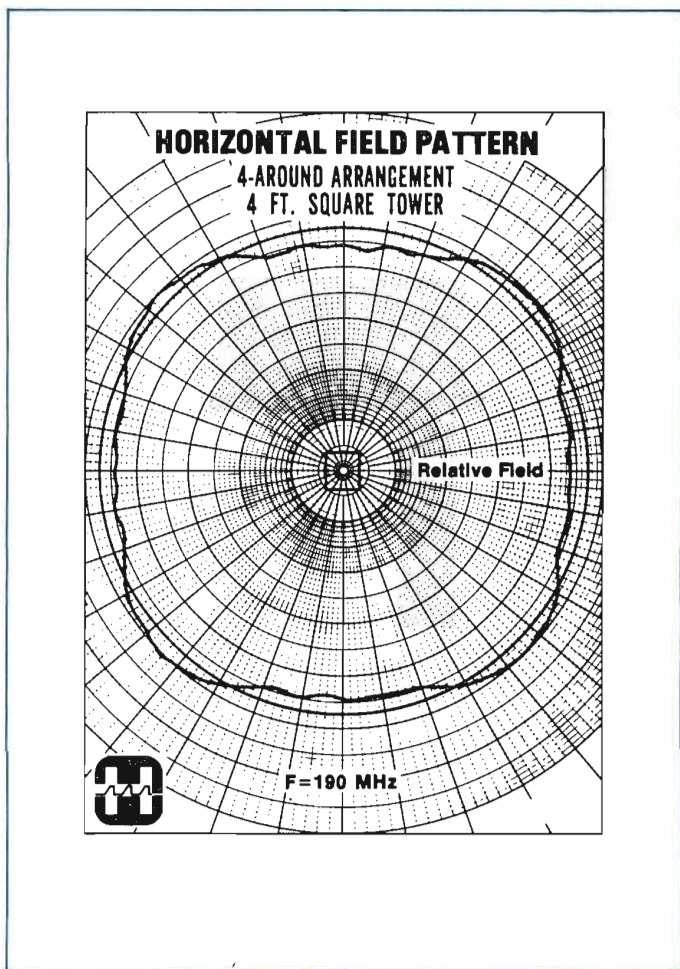
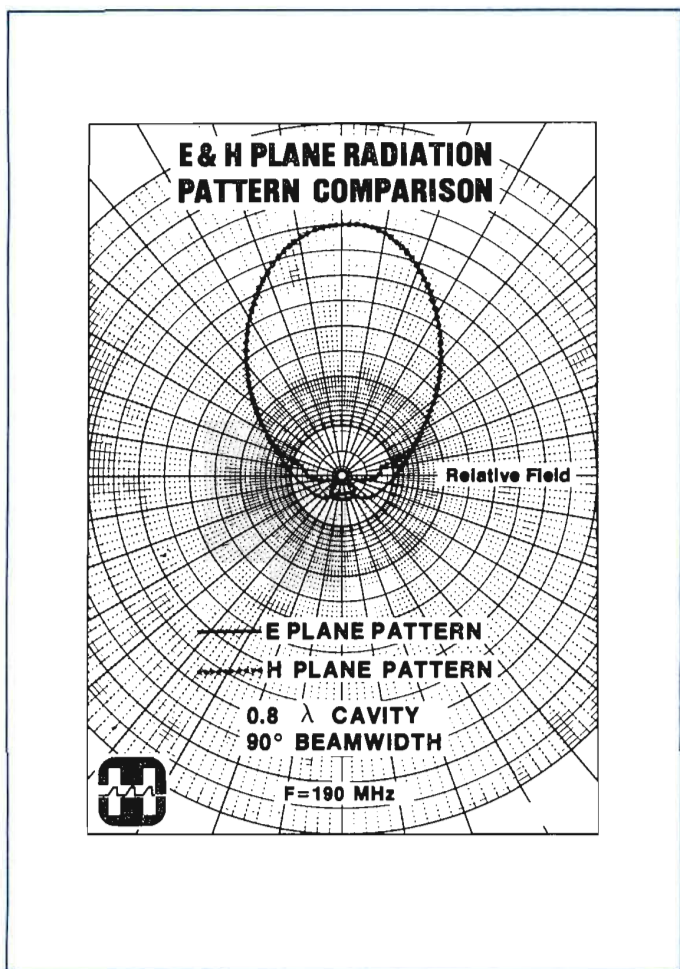

HIGH POWER CAPABILITIES. The Harris CP antenna is designed for multiplex applications as well as single station operation. Up to 100kW power ratings are available for single transmitter operation. For dual station operation, up to 150kW input may be accommodated. For applications requiring the multiplexing of more than two stations, special high power feed systems are available.

VERTICAL PATTERN. Vertical pattern contouring to introduce beam tilt and null fill may be provided by means of standard phase distribution techniques such as has been used in many successful Batwing installations. Control of the vertical pattern is accomplished with no degradation of the axial ratio. Therefore, contoured vertical patterns are available much the same as in conventional horizontally polarized TV antennas.

HORIZONTAL CIRCULARITY. For omnidirectional stations, the shape of the horizontal pattern will vary from omni by less than ± 2 dB for three-sided tower configurations. With a four-around antenna array, the typical circularity will be comparable.

Stations employing directional arrays will find one of the several patterns available to be ideally suited to their specific need.

The Harris Cavity Backed Radiator circularly polarized antenna marks a new dimension in television broadcasting. The excellent axial ratio, superb horizontal and vertical patterns and application flexibility make it a technically superior antenna. Careful design consideration of important mechanical details assures a long and dependable lifespan. No matter what your VHF high band television antenna requirements may be. . . Harris has a circularly polarized antenna to meet them.

MEASURED HORIZONTAL RADIATION PATTERN MECHANICALLY ROTATING DIPOLE ILLUMINATION

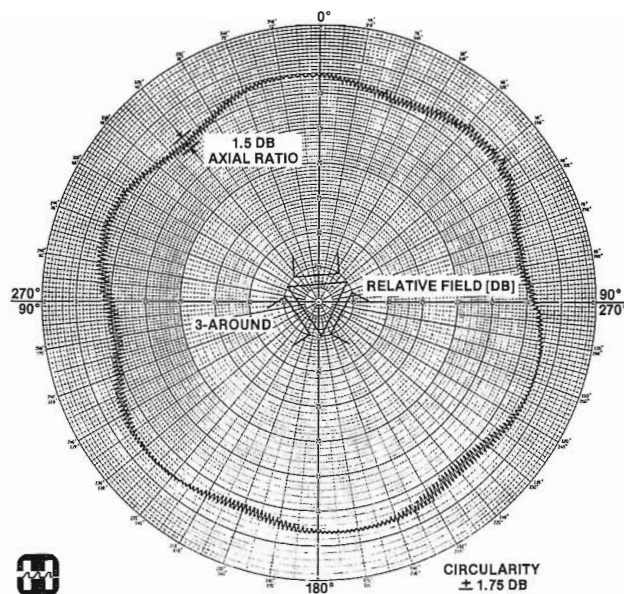

MEASURED VSWR OF A SINGLE HIGH POWER CAVITY CP MODE

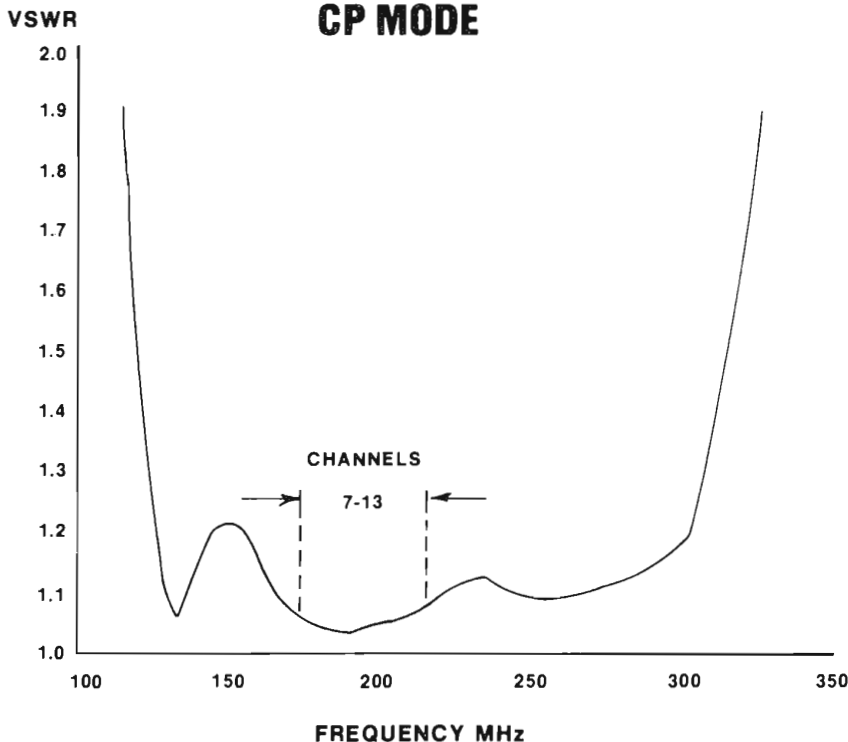

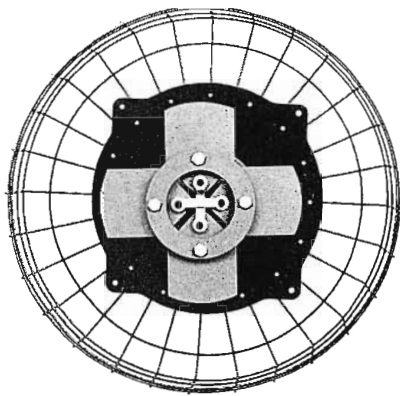

Single radiating element of the Harris C P antenna

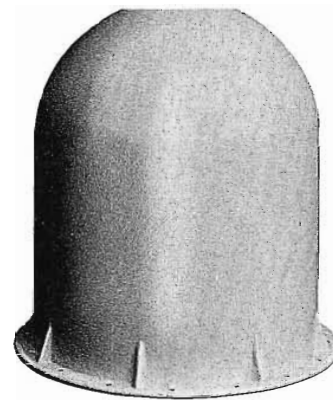

Radomes eliminate the need for electrical de-icing equipment

WINDLOADING

[Triangular Mast with Radomes]

CHANNEL	NO.OF BAYS	MAST LENGTH [FEET]	SHEAR @ 50 PSF [LBS.]	MOMENT [FT. LBS.]	WEIGHT [LBS.]
7	6	34.0	4,885	83,045	5,425
7	8	45.3	6,550	148,360	7,350
7	10	56.5	8,350	235,890	9,300
7	12	67.7	10,205	345,440	11,500
8	6	33.2	4,770	79,185	5,300
8	8	44.0	6,355	139,810	7,150
8	10	55.0	8,130	223,575	9,075
8	12	65.8	9,925	326,535	11,175
9	6	32.2	4,625	74,465	5,150
9	8	42.7	6,175	131,840	6,950
9	10	53.2	7,875	209,475	8,775
9	12	63.7	9,600	305,760	10,825
10	6	31.4	4,510	70,810	5,025
10	8	41.6	6,010	125,010	6,750
10	10	51.7	7,650	197,775	8,525
10	12	62.0	9,350	289,850	10,525
11	6	30.7	4,410	67,700	4,900
11	8	40.6	5,865	119,060	6,600
11	10	50.5	7,475	188,750	8,325
11	12	60.4	9,110	275,125	10,250
12	6	30.0	4,310	64,650	4,800
12	8	39.5	5,710	112,775	6,425
12	10	49.1	7,260	178,250	8,100
12	12	58.7	8,850	259,750	9,975
13	6	29.3	4,210	61,680	4,675
13	8	38.7	5,590	108,200	6,275
13	10	48.0	7,100	170,400	7,900
13	12	57.3	8,640	247,550	9,725

SPECIFICATIONS

	SINGLE CHANNEL	MULTIPLEX
VSWR	1.1:1	1.1:1
GAIN/BAY	UNITY	UNITY
CIRCULARITY (Top Mount)	± 2 dB	± 3 dB
AXIAL RATIO	< 2 dB	< 2 dB
POWER RATING	100 kW	150 kW



HARRIS
COMMUNICATIONS AND
INFORMATION HANDLING

TRAVELING WAVE HELICAL TV ANTENNA

- High quality performance
- Simple, reliable, economical design
- Maximum pattern versatility
- Low VSWR
- Low impedance, non-resonant radiating element
- Maximum lightning protection
- Superior pattern stability under adverse wind conditions
- Easy to de-ice—no internal heaters or radomes required
- Actual factory measurements of horizontal and vertical patterns provided for each antenna
- Heavy duty mechanical construction
- Low maintenance costs

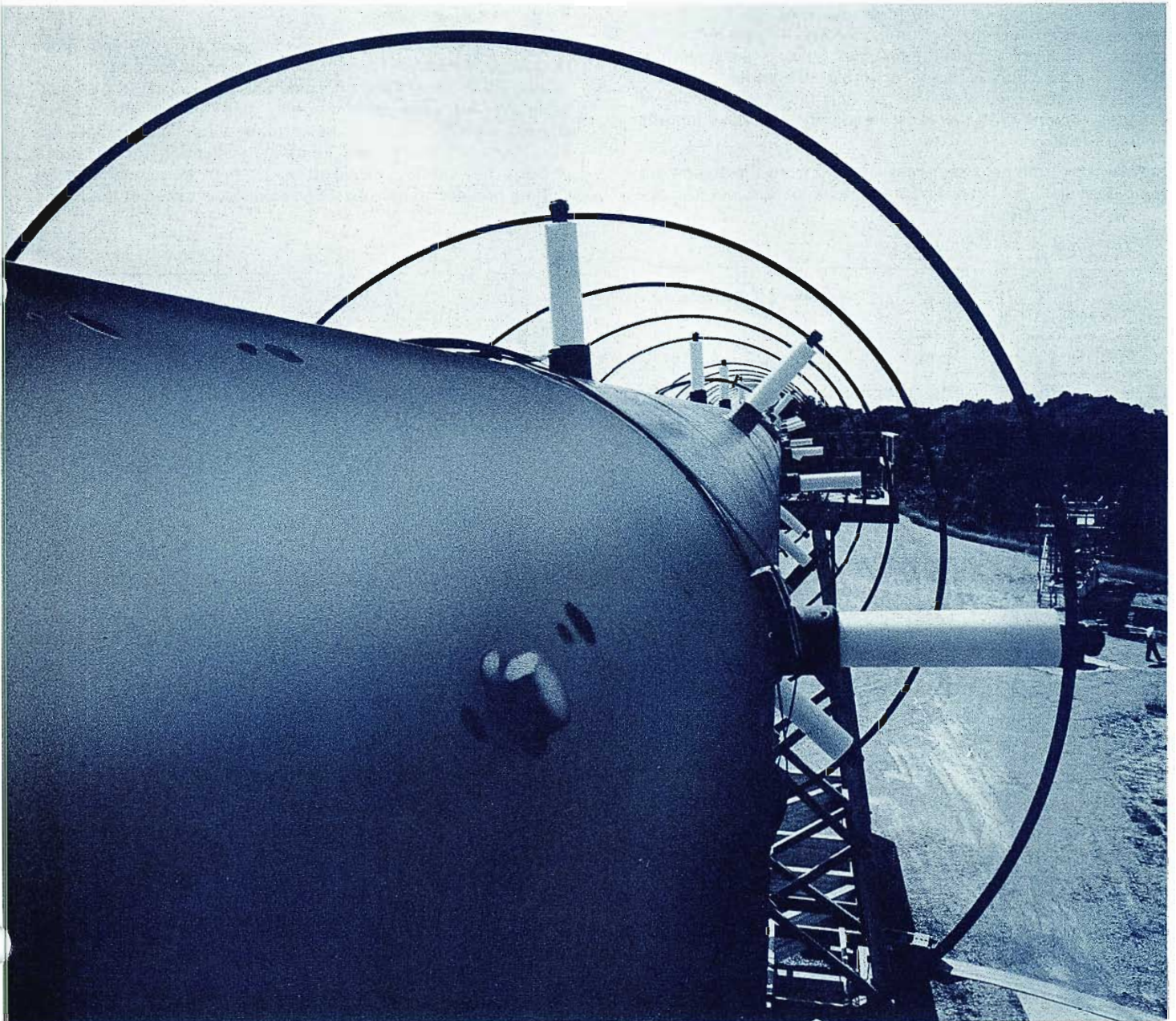

The Harris traveling wave Helical television transmitting antenna is noted for its uncomplicated design that greatly enhances reliability, while providing maximum pattern versatility and stability. The antenna employs the traveling-wave principle, which results in a smoothly contoured, low sideband single bay pattern, and excellent VSWR characteristics. VSWR is typically 1.08 or better across the band, 1.05 or better at visual carrier. When used in a multi-bay array, the Helical can provide an infinite variety of patterns. Typical VHF high band vertical and horizontal patterns are shown below.

HELICAL DESIGN. The traveling wave Helical antenna consists of a right-and-left-hand helix wound around a conducting mast with the feed point at the center. The antenna uses the traveling-wave principle to excite a large portion of the aperture from a single feed point on each bay. The RF current, because of the radiation loss, is attenuated as it approaches the ends of the conductor. Since only a small amount of energy remains at this point, the ends of the helices may be left open or grounded to the mast, rather than terminated, with negligible effects on performance.

The helix is designed to meet certain dimensional requirements as necessitated by the frequency so that the currents at like points in each of its turns are in phase. Thus, as the current progresses from turn to turn, it is delayed for each turn an amount of time equal to that consumed by an integral number of cycles. Each turn is made an integral number of wave-lengths in helical circumference as measured at the velocity of propagation along the helix. Most frequently, two wave-lengths per turn are used.

The spacing of the helix radiating element from the steel mast is such that an appreciable amount of radiation loss per turn oc-

curs along the helix. The design objective for this radiation loss is about 4 dB per turn. Since there are approximately six turns on the helix, the energy remaining at the ends is down 24 dB. The total length of the helix has been adjusted commensurate with the loss per turn so that resonance effects due to end reflections are avoided. This reduces partial clover-leafing of the horizontal pattern to meet horizontal-pattern requirements.

LOW-IMPEDANCE, NON-RESONANT RADIATING ELEMENT. A right- and left-hand helix are used in each section to effectively cancel the vertically polarized radiation components due to the helix pitch angle. The two helices are placed end to end and are fed by a common feed point at their junction located at the section's center. This reduces the feed-point impedance to approximately 100 ohms. This low impedance, and consequent low RF voltages, minimizes dielectric breakdown problems, and results in an antenna design inherently immune to moderate icing conditions. This basic design characteristic, coupled with the fact that the Helical antenna is fundamentally a non-resonant circuit, contributes to reliable, stable performance under extreme weather conditions. In addition, each feed point is provided with a shorted quarter-wave stub that prevents coupling lightning surges into the transmission line and the transmitter.

ANTENNA PATTERNS. Since the gains achieved with most Helical antennas are usually high, the need for pattern contouring must be carefully considered. The Helical is designed especially for ease of contouring, and almost any pattern desired is obtainable. Also, beam tilt and null fill are tailored to the customer's specific requirements, and simple modifications of both may be accomplished in the field to compensate for shifting population densities. Each Helical is tested at the Harris

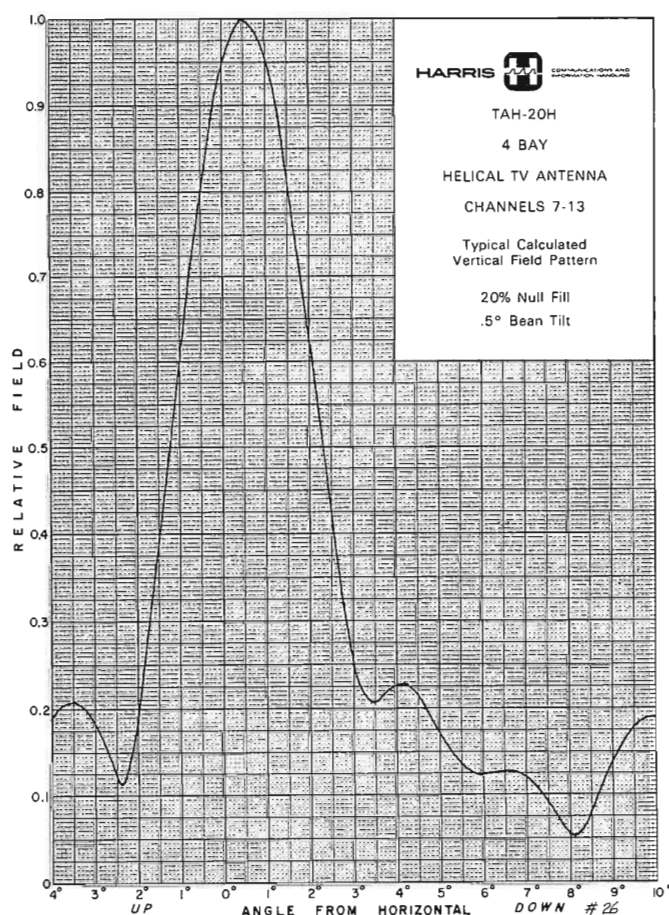
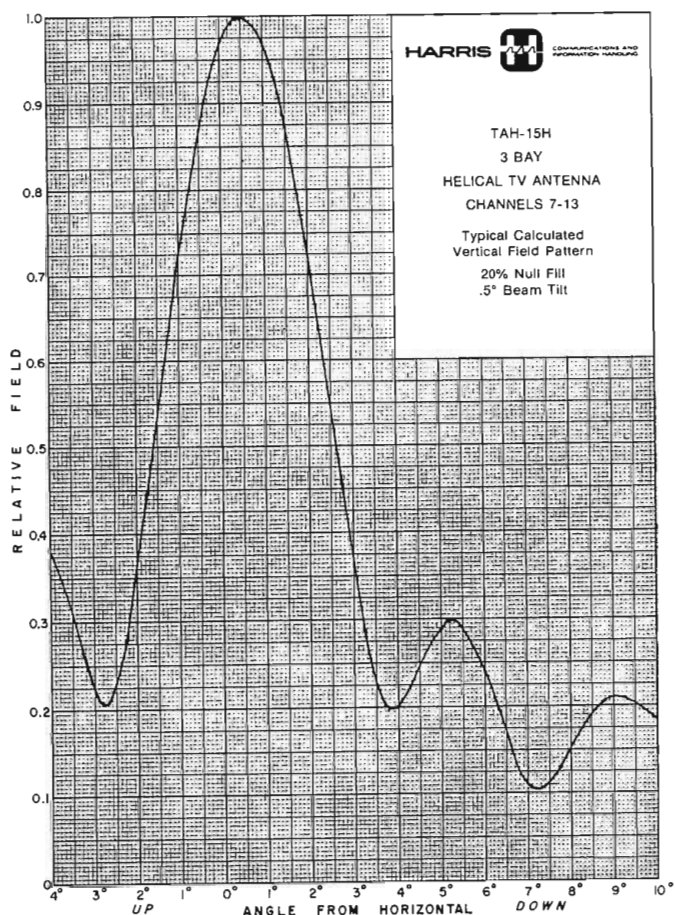

TV antenna test range before shipment, and the customer is furnished the measured horizontal and vertical patterns.

BEAM TILTING. Simple beam tilting without appreciable null fill-in may be achieved on the Helical antenna by introducing phase shift between successive sections. This is accomplished by using a different length of feed line between the power divider and feed elbow of each section on a VHF Helical. Simple beam tilt in the range of zero-to-one degree does not basically change the vertical pattern shape as compared to a standard vertical pattern. Nor do simple beam tilts of this order reduce the peak-power gain appreciably.

NULL FILL. Null fill-in is often desirable and may be obtained by proper power distribution and current phase in each bay. Large degrees of null fill-in will reduce the antenna gain. However, the advantage of a higher signal level over the close-in area will often justify this loss in gain.

EASY DE-ICING. De-icing is accomplished by a low-voltage, high current fed through the radiating helix—no internal heaters or radomes are required. This current is supplied by a thermostatically controlled transformer (for each bay), which is included when de-icing is ordered. The dissipation is a nominal 1.5 watts per square inch of helix element surface. Because of the relatively small area, only 2.5 kilowatts of power per section is required for effective de-icing on VHF high band Helicals.

HEAVY-DUTY CONSTRUCTION. All Harris traveling wave Helical antennas are of heavy-duty construction and are designed to operate in areas where heavy winds and/or heavy ice

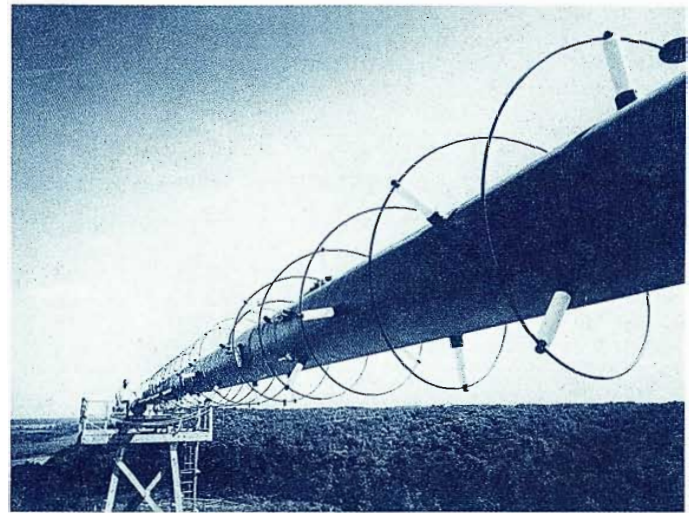

loading may be encountered. The extra stiffness and strength of the Helical mast minimizes antenna sway, and enables the Helical to withstand a pressure on projected flat surfaces of 50 pounds per square feet of windloading—which corresponds to an actual wind velocity of 112 miles per hour. All hardware is weather resistant stainless steel or zinc plated.

COMPLETE MECHANICAL ACCESS, LOW MAINTENANCE COSTS. All radiating elements are totally accessible on the outside of the mast, and pole steps are provided on the mast for easy inspection and maintenance. Due to the convenient element accessibility and the simplicity of the antenna design, maintenance costs are typically very low.

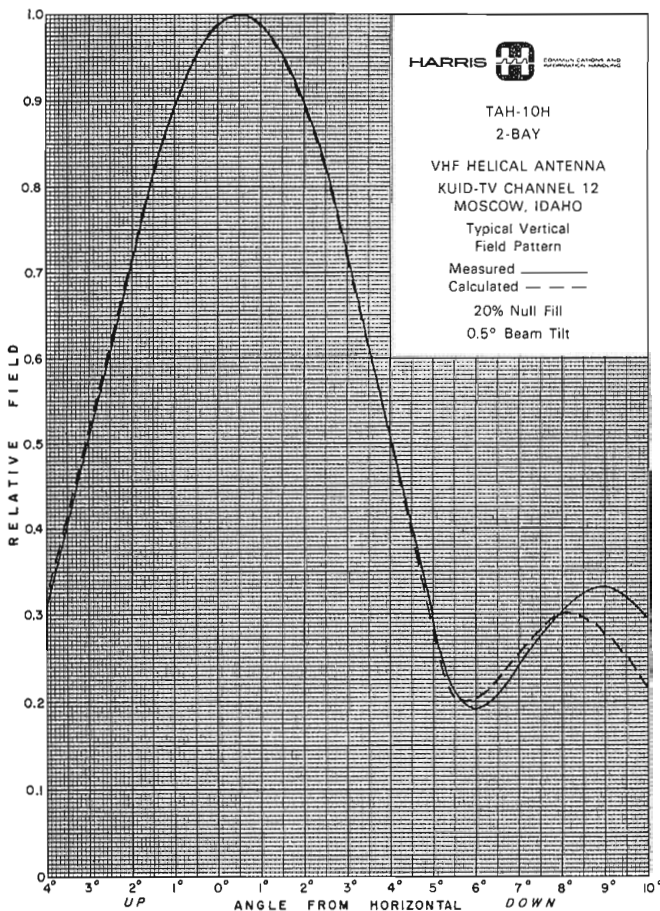

MEASURED HORIZONTAL FIELD PATTERN
TAH-10H VHF HELICAL ANTENNA
KUID-TV CHANNEL 12
MOSCOW, IDAHO

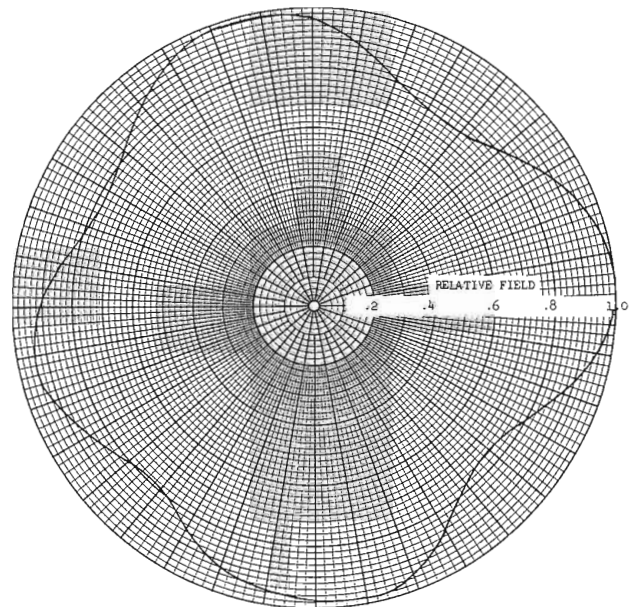

measured circularity
± 1.26 dB from
average circle

HELICAL VHF SPECIFICATIONS CHANNELS 7-13

For information on VHF low band and UHF Helicals contact Harris

TAH-10H 2 Sections
TAH-15H 3 Sections
TAH-20H 4 Sections

Antenna Type	Null Fill	Antenna Height H ft. (c)	Rad. Center R ft. (d)	Input Power (e) kW	Input Power (e) dBk	Power Gain Ratio	Power Gain Maximum (b) dB	M Moment ft.-lbs. (a)	S Shear lbs. (a)	W Weight lbs.
CHANNEL 7										
TAH-10H	20%	67.67	35.51	56	17.48	9.0	9.54	159,540	4,950	7,500
TAH-15H	20%	97.25	53.74	67	18.26	12.6	11.00	330,480	7,030	13,000
TAH-15H	15%	97.25	50.88	72	18.57	13.5	11.30	330,480	7,030	13,000
TAH-20H	15%	127.25	67.90	123	20.90	17.4	12.41	587,650	9,250	19,500
CHANNEL 8										
TAH-10H	20%	67.67	35.51	55	17.40	9.2	9.64	159,540	4,950	7,500
TAH-15H	20%	97.25	53.74	66	18.20	13.0	11.14	330,480	7,030	13,000
TAH-15H	15%	97.25	50.88	71	18.51	14.0	11.46	330,480	7,030	13,000
TAH-20H	15%	127.25	67.90	121	20.83	18.0	12.55	587,650	9,250	19,500
CHANNEL 9										
TAH-10H	20%	63.33	33.24	54	17.32	8.9	9.49	131,410	4,310	6,500
TAH-15H	20%	91.25	50.25	65	18.13	12.5	10.97	272,610	6,190	11,000
TAH-15H	15%	91.25	47.61	70	18.45	13.5	11.30	272,610	6,190	11,000
TAH-20H	15%	119.25	63.70	118	20.72	17.4	12.41	472,450	8,140	17,800
CHANNEL 10										
TAH-10H	20%	63.33	33.24	53	17.24	9.2	9.64	131,410	4,310	6,500
TAH-15H	20%	91.25	50.25	64	18.06	12.9	11.11	272,610	6,190	11,000
TAH-15H	15%	91.25	47.61	69	18.39	13.9	11.43	272,610	6,190	11,000
TAH-20H	15%	119.25	63.70	115	20.61	17.4	12.41	472,450	8,140	17,800
CHANNEL 11										
TAH-10H	20%	63.33	33.24	52	17.16	9.4	9.73	131,410	4,310	6,500
TAH-15H	20%	91.25	50.25	63	17.99	13.3	11.24	272,610	6,190	11,000
TAH-15H	15%	91.25	47.61	68	18.33	14.3	11.55	272,610	6,190	11,000
TAH-20H	15%	119.25	63.70	113	20.53	17.4	12.41	472,450	8,140	17,800
CHANNEL 12										
TAH-10H	20%	59.25	30.97	51	17.08	9.1	9.59	102,980	3,670	5,900
TAH-15H	20%	85.25	46.77	62	17.92	12.7	11.04	219,310	5,340	10,000
TAH-15H	15%	85.25	44.31	67	18.26	13.7	11.37	219,310	5,340	10,000
TAH-20H	15%	111.25	59.50	111	20.45	17.7	12.48	379,030	7,010	15,500
CHANNEL 13										
TAH-10H	20%	59.25	30.97	50	16.99	9.2	9.64	102,980	3,670	5,900
TAH-15H	20%	85.25	46.77	61	17.85	12.8	11.07	219,310	5,340	10,000
TAH-15H	15%	85.25	44.31	66	18.20	13.8	11.40	219,310	5,340	10,000
TAH-20H	15%	111.25	59.50	109	20.37	17.7	12.48	379,030	7,010	15,500

HELICAL NOTES:

1. Gains shown in the tables: Antennas having .5° beam tilt and either 15% or 20% null fill. Other patterns available on request.
2. Horizontal pattern circularity: ±1.5 dB or better.
3. Input connections: Standard single 6 1/8" EIA flanged line. 50 ohm.

KEY TO DATA:

- a. The antennas are designed in accordance with the Uniform Building Code and the American National Standard of Building Code Requirements for Minimum Design Loads in Building and Other Structures (ANSI A58.1-1972). The loading data shown in the table is based on a wind pressure of 50 lbs. per sq. ft. acting normal to flat surfaces.
- b. For all antennas listed, installed above 500 feet AAT, the relative field at the Radio Horizon is greater than 90% of max. and thus, per FCC 73.684 (c) 1, need not be given separately.
- c. H: height above tower top including 4.00 ft. of lightning protector.
- d. R: height of radiation center above tower top.
- e. Peak visual power rating: For average black level power including 20% aural, multiply by .8.

- f. Data shown in these tables is typical. Specific data may be obtained on request from Harris Corporation, Broadcast Products Division.
- g. Antennas are delivered completely assembled to the customer F.O.B. Harris Test Range and at the customer's option may be partially disassembled to facilitate transportation. Re-assembly of the antenna at installation site is the responsibility of the customer. Supervision of re-assembly and impedance test can be supplied at the customer's request. Supporting structure necessary to support antenna during re-assembly and test must be supplied by the customer. Construction prints of the supporting structure will be supplied by the company.
- h. The beacon lighting cable to the bottom of the antenna is included.
- i. Antenna will be supplied with a coat of protective primer only. Customer to paint color required at time of installation.
- j. All mechanical parts are fabricated from hot dipped galvanized steel or other materials that resist corrosion such as copper, brass, bronze and stainless steel.
- k. Demonstration of pattern test at the test range available at extra cost.
- l. Supervision of installation and testing of antenna and transmission line at the customer's site is available at extra cost.
- m. Nominal amounts of null fill and beam tilt available at no increase in price.

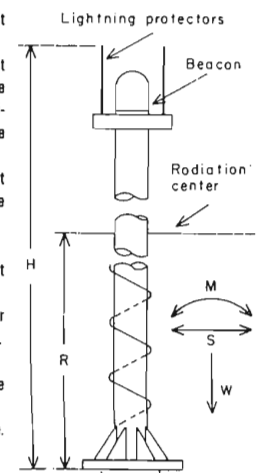



TC-80A

Automatic Live Color TV Camera

- Available with Diode Gun Plumbicon® pick-up tubes
- Exclusive Highlight Handling system
- Complete remote set-up saves time and money
- High signal-to-noise ratio for quiet pictures
- Automatic color balance, automatic iris and automatic timing are standard
- Versatile add-on modular Triax system
- Efficient switching power supply greatly reduces power consumption
- Master-gamma allows picture contrast control flexibility
- Rugged construction; designed for use with any quality lens
- Stability of camera settings means controlled, repeatable performance.

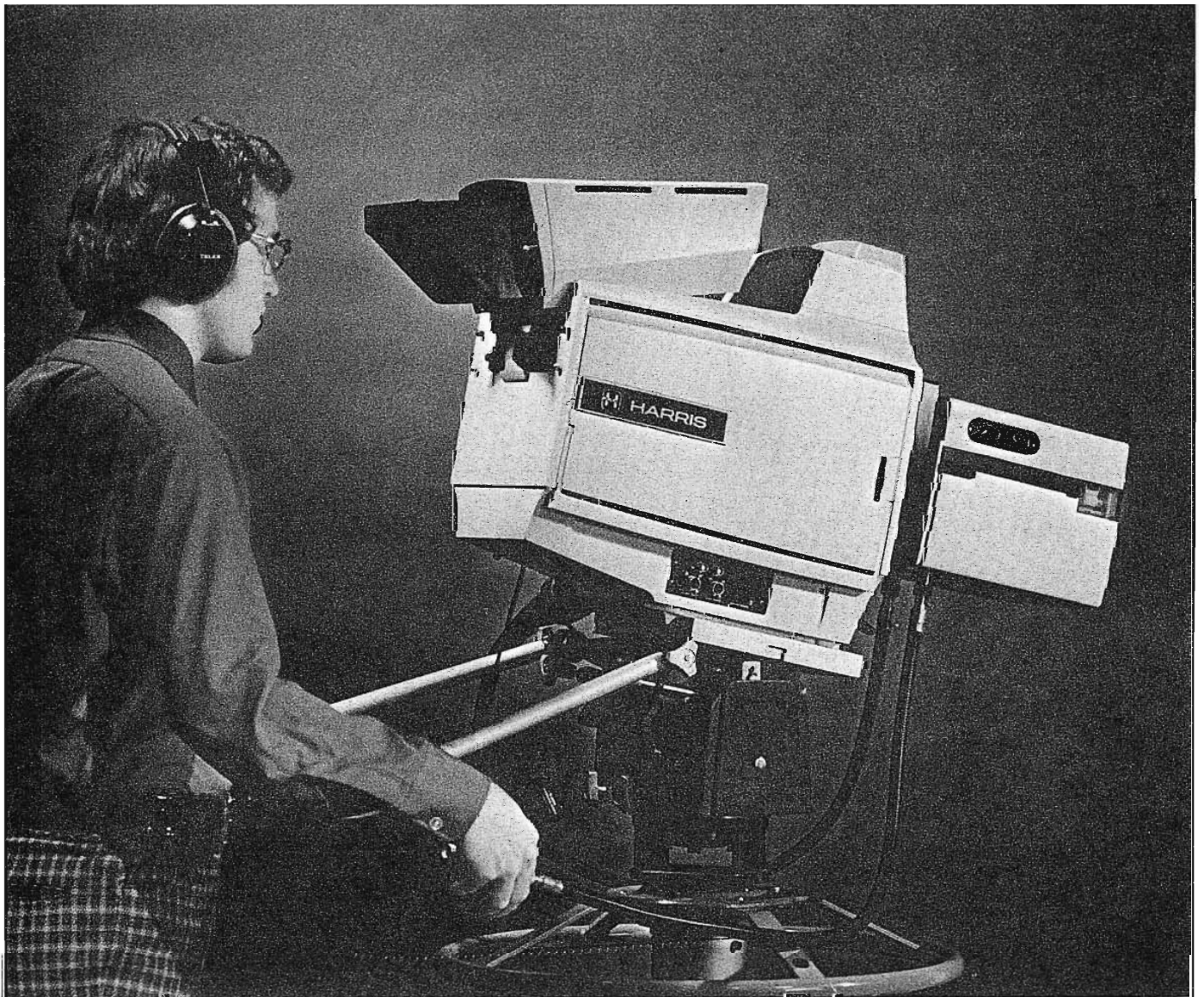

TC-80A...a significant advance in

As an evolution in TV camera design from previous Harris successes with the TC-50 and TC-80, the TC-80A offers you the most recent developments in TV camera technology—including Diode Gun Plumbicon** pick-up tubes and Highlight Handling—to bring you superb picture quality in the studio or in the most demanding remote situations.

Harris' broadcast cameras are now being used in a variety of markets in the U.S., ranging from large markets such as Los Angeles (ADI No. 2), through medium size markets such as Dayton, Ohio (ADI No. 49), to small markets such as Quincy, Illinois (ADI No. 138). The continuing development of new features by the Harris video engineering staff has added to our cameras' usefulness to broadcasters throughout the country. All of these features have now been combined with a breakthrough in pick-up technology to produce the Harris TC-80A. As a result, color fidelity and picture integrity of this top-of-the-line model set a new standard of excellence for live color cameras.

A philosophy of complete remote set-up and operation has guided the development of the TC-80A, from the add-on Triax feature, to the location of all set-up and operational controls at the Camera Control Unit (CCU). When more than one TC-80A is being used, the remote set-up provides consistency across camera chains for uniform video throughout a production. Also, operate panels for several TC-80A cameras may be centrally located so that one person can control the video, freeing the cameramen to follow the action. Now you can have network quality pictures in the field as well as the studio, with high camera sensitivity and a master gamma contrast control that provides sharply defined pictures under all types of lighting conditions.

*Trademark of N.V. Philips of Holland

Standard automatics in the TC-80A include digital black and white balance, a three-speed automatic iris and automatic timing. Automatic full-time horizontal and vertical centering is optional. These automatic features, combined with the TC-80A's inherent stability, allow camera operation by non-technical personnel, freeing your engineers for other station duties. The stability has been engineered in, so that most controls for the TC-80A, under normal studio conditions, seldom require resetting.

All lenses designed for the one-inch image format may be used with the TC-80A, from the largest 42:1 to 10:1, or smaller. All standard lenses use a hanging, self-positioning mount and positive lock, and may be connected or disconnected quickly.

With its outstanding picture quality, low-light-level capability, true ease of set-up and operation, and unique flexibility, the TC-80A offers you a positive way to improve the quality of your live telecasts and commercial productions, while

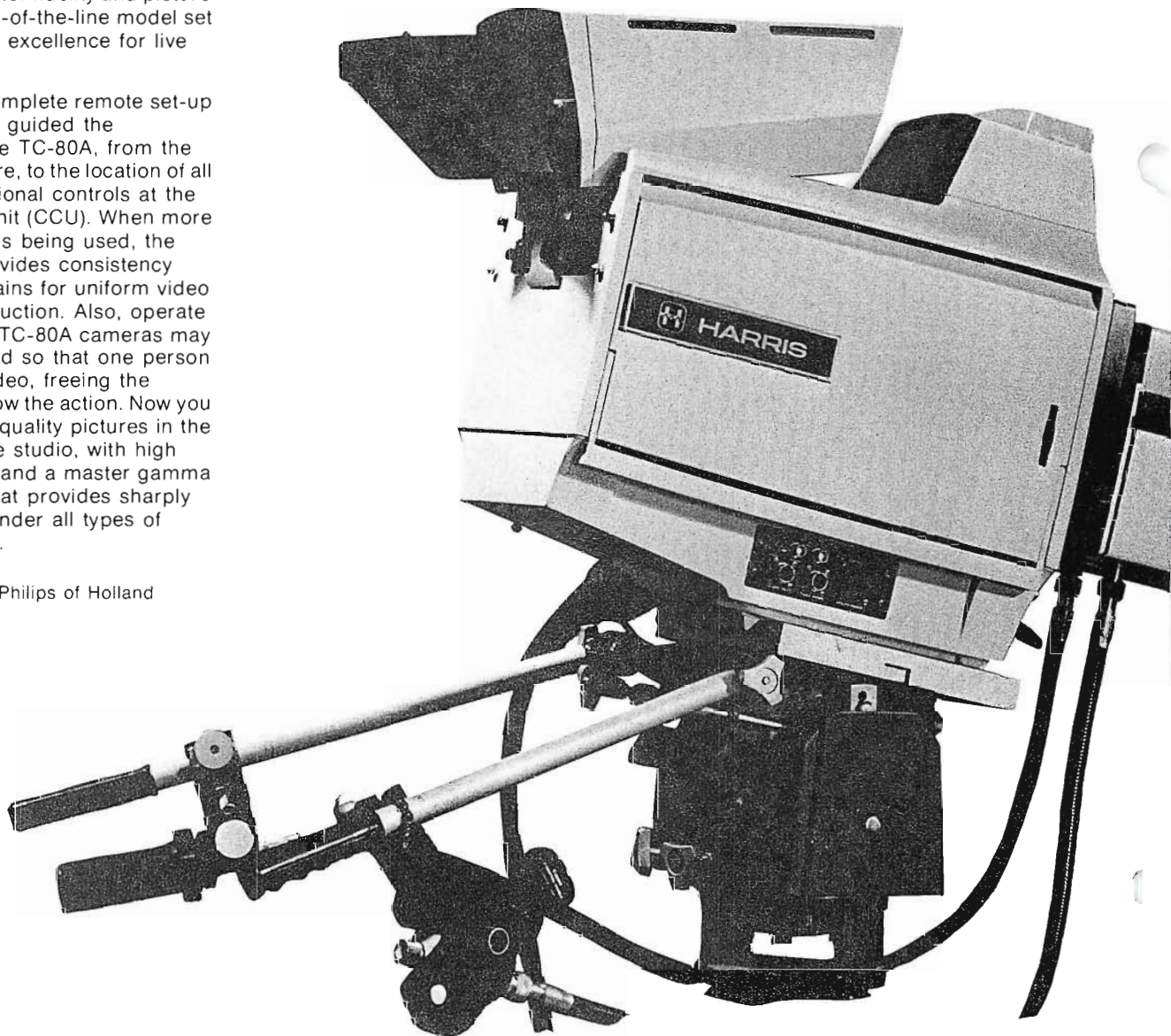

broadcast television camera design

holding the line on operating costs. This camera reflects Harris' many years of broadcast experience, and is another industry leader in the Harris video product line.

Advances in Pick-Up Technology.

Topping the long list of TC-80A features are:

- Diode Gun Plumbicon camera tubes, the most useful recent development in broadcast pick-up technology.
- Highlight Handling at the flick of a switch...a revolutionary, easy-to-use circuit that reduces comet tailing 10:1!

Diode Gun Plumbicon tubes demonstrate better resolution, overbeam capability and lag. The standard 1-inch Plumbicon has always demonstrated better lag than the 1¼-inch tube, but now the performance gap is even wider. Modulation depth at 400 TV lines has been improved to better than 65% in Green, 65% in Blue and 60% in Red.

The adjustment-free Highlight Handling system makes objectionable comet-tails

from picture highlights virtually disappear on Diode Gun Plumbicon tubes, and substantial improvement is seen on standard XQ1070 Plumbicon tubes as well. Able to handle up to 4F stops of highlights **in any color**, this circuit dramatically pulls crisp detail out of shots with difficult exposures by eliminating blooming. The duty cycle of increased beam current in the Plumbicon tube is extremely low so that the lifetime of the tubes is not materially affected.

The TC-80A is available with Diode Gun or regular Plumbicon tubes; and changing tubes, or even tube types, is an amazingly simple field operation taking only minutes and requiring no tools.

Highlight Handling and Diode Gun Plumbicon tubes provide clean, sharp video under the most severe conditions of extreme contrast with brilliant specular reflections; or in action situations under low-light-level conditions. Take this camera into any situation and you'll get the shots you want.

Automatic Color Balance. Color balance is simply and easily achieved at the touch of a button, with modern digital circuitry providing error-free white and black alignment in a matter of seconds. During white balance, the TC-80A viewfinder provides a window area for aiming the camera at a white reference target.

Similarly, black balance is achieved by pushbutton control. Capping the lens provides the camera with its reference black, and again, the camera automatically indicates balance completion.

While balancing, the camera's paint controls are disabled, meaning that artistic effects can be preserved even though color balance is retouched.

Automatic Centering. With this optional feature, independent digital electronic circuitry in the TC-80A provides constant sensing of scene content for registration errors and automatically compensates horizontal and vertical centering. These circuits operate continuously on picture information and do not require special charts, scenes or operator intervention.

Automatic Iris Control. Special weighting and frequency discriminating digital circuitry prevents specular reflections or momentary errors from upsetting an otherwise properly exposed picture. High iris speeds are used to correct big errors fast—then, as the proper exposure is approached, slower speeds are used to reach, and never overshoot, the proper setting. Several front panel response controls permit tailoring automatic performance to specific requirements.

Super-Quiet Pre-Amps. The front end of each pre-amp is a folded-cascode configuration utilizing the lowest-noise field effect transistors available. This provides a wideband video amplifier which is the heart of the transresistance pre-amplifier. D.C. coupling from the tube and through the pre-amplifier eliminates low frequency break points for clean, smear-free video.

Low-light-level performance is enhanced by these low-noise pre-amplifiers in conjunction with bias light, efficient prism optics and a master gain control. The master gain control switches in steps of +6, +12 and -6 dB, and has 6 dB of continuous vernier adjustment for up to +18 dB of gain.

Pictures are surprisingly noise free at five foot-candles or less! The electronic color temperature corrector, in conjunction with the automatic color balance feature, is especially useful when color temperature shifts accompany changes in light level.

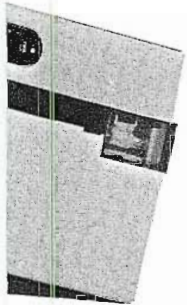

The pre-amps are identical in all three channels and may be interchanged easily for troubleshooting.

Contrast Control. The unique master gamma control on the CCU/operate panel allows you to either increase or decrease contrast for interesting shots in difficult lighting conditions. The master gamma control can reduce contrast under conditions of severe lighting differences such as shadows on a football field, but can also increase contrast for pleasing shots from very flat scenes such as skylines with ground haze or fog.

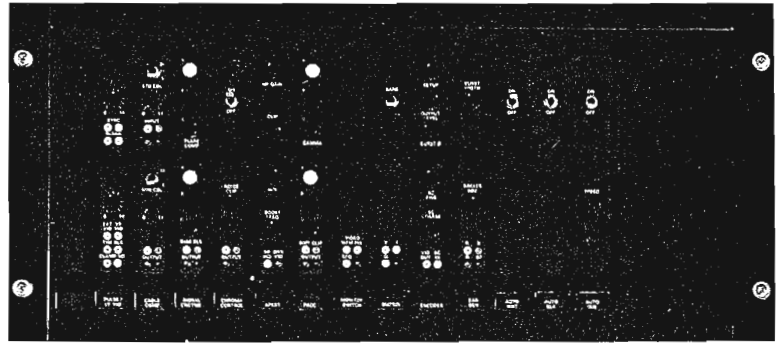

The TC-80A remote set-up philosophy is evident from the set-up and operate panels which allow complete centralized picture control, even 3-channel remote picture rotation. The TC-80A CCU has four 19" rack unit components—the processor frame, the set-up and operate panels, an intercom panel and the main power supply. A modern console-type cabinet is available from Harris to house the CCU.

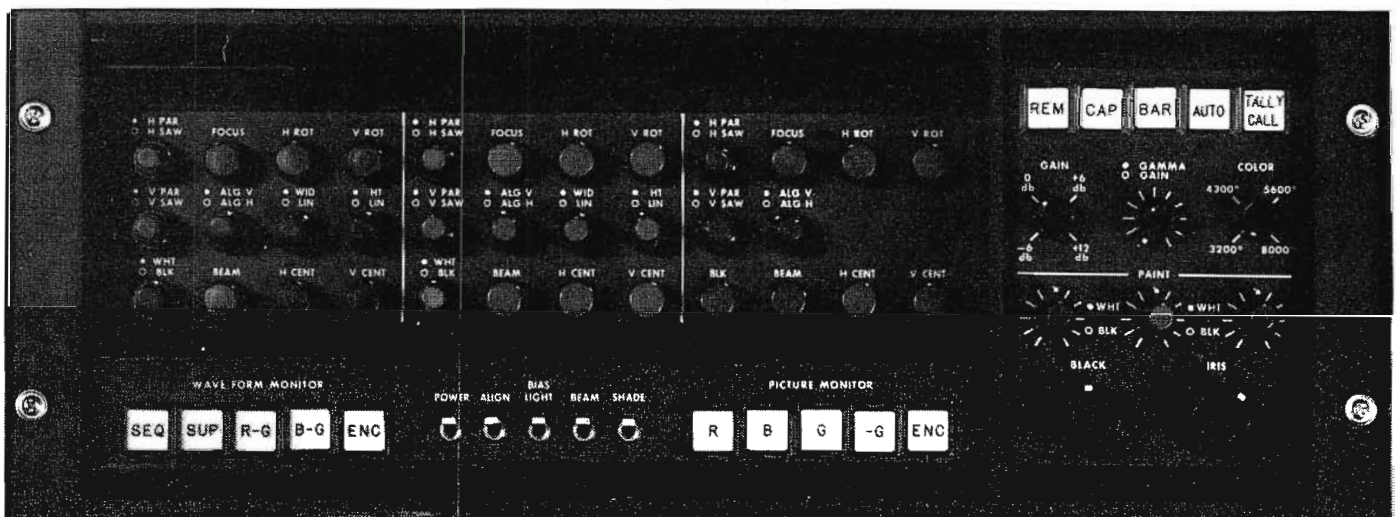

Linear Color Matrix. True color masking allows accurate compensation for optical color-splitting deficiencies, and for phosphor inadequacies in receiver tubes. Positive and negative addition of the three primary colors is accomplished prior to encoding of the color signal to optimize the camera taking characteristics. Flesh tones, deeply saturated reds and pale yellows—the truest test of a camera's accuracy—are faithfully reproduced by the TC-80A.

Electronic Color Temperature Corrector. This exclusive feature provides lighting temperature equalization in four calibrated increments, without reduction of pick-up tube face plate illumination. This means that the camera's excellent signal-to-noise ratio is maintained even when a long zoom lens is employed.

Aperture Correction. A horizontal and 2-line vertical aperture corrector, employing both comb filter and noise coring techniques, provides a new

dimension in picture quality. Some unique features of this system include: fully gamma corrected detail enhancement to maintain resolution even in the low-light areas; and adjustable horizontal boost frequency and single control horizontal/vertical ratio adjustment to allow tailoring the picture crispness to the scene material.

Calibrated Beam Set. The TC-80A uses a calibrated electronic attenuator to reduce sensitivity in all three channels by 50% at the turn of a knob, ensuring consistent registration.

Flare Compensation. Individual front-panel controls are provided for flare compensation in all three color channels. This ensures accurate reproduction of blacks, even with scenes of extreme contrast.

Master Blanking. Blanking level is readily adjusted with a black level control, and a unique electronic null provides the operator with easy return to

correct set-up level. Master blanking is unaffected by the electronically independent contrast control.

Encoder Flexibility. The TC-80A's new integral encoder emphasizes more versatility for the video engineer. Output options include: three individually selectable composite/non-composite signals; and front panel choice of color, mono or mono with burst.

The inserted sync is an AGC'd replica of the incoming signal from the station sync generator, so that the timing and controlled rise and fall times of the incoming sync signal are maintained. Burst flag is internally generated with controlled rise and fall times, and is timed from the leading edge of sync to conform to the proposed EIA standard.

The built-in color bar generator is inserted before encoding for accurate verification of system performance, and can be activated either locally or from the operate panel. Color bar options

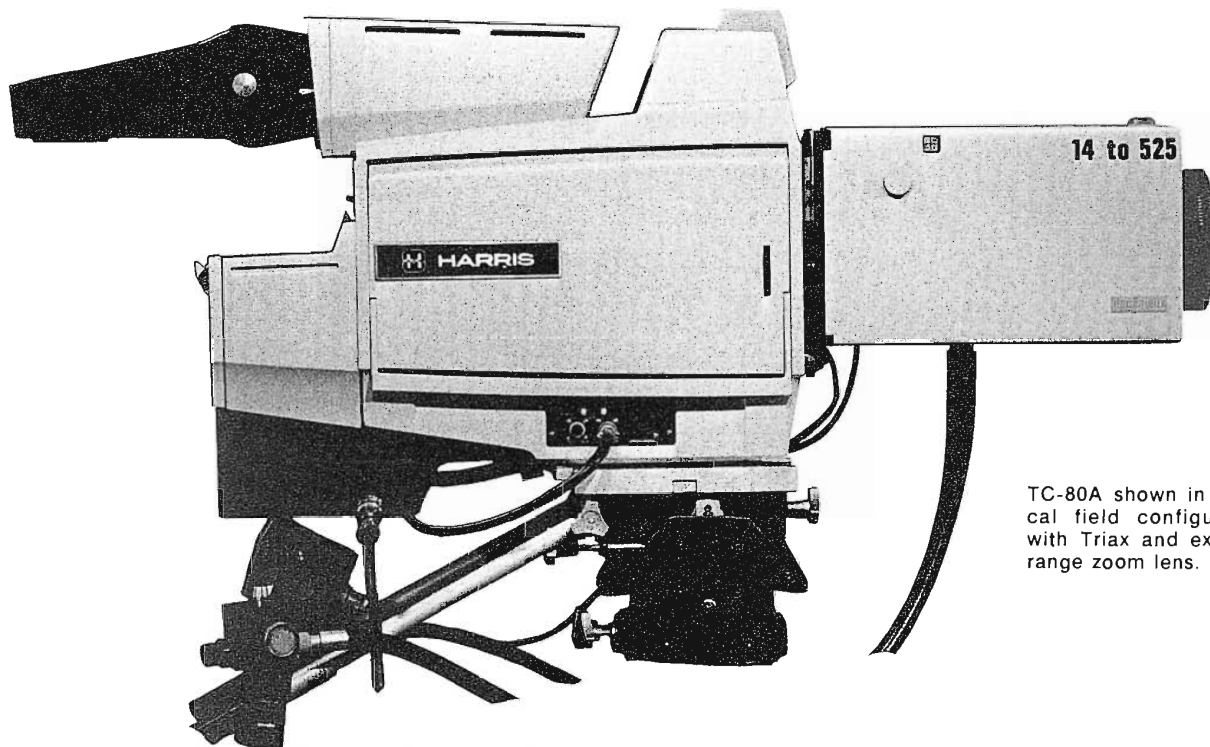

TC-80A shown in a typical field configuration, with Triax and extended range zoom lens.

include: 75% bars or 75% bars with 100% white; and full field or split field format. Color bars are produced by synchronous switching, with shaping controlled by active filters, to generate an exceptionally clean signal.

Add-On Triax. An optional Triax accessory offers maximum versatility in field operations. Eliminating bulky and costly multicore cable on runs of up to **one mile**, the Triax system extends operation without picture degradation or loss of the TC-80A's fine automatics and other features.

Sync Generator. The modular optional NTSC sync generator plugs into the processor frame of the CCU. Color genlock, with protection for loss of reference, is a standard feature. With this accessory, single cable synchronization of camera chains is simply and inexpensively accomplished. Sync, blanking and subcarrier outputs are available at the rear of the CCU for driving other cameras or ancillary equipment.

Special Effects. Various optical accessories such as star filters, close-up adapters, additional color and neutral density filters, etc. are available for use in the filter wheel to create special visual effects. Linear red, blue and green outputs are standard with the camera for use with Chroma Keyers or other special effects generators.

Waveform And Picture Monitoring. The TC-80A provides the following waveform outputs: sequential R,B,G; superimposed R,B,G; R-G; B-G; and encoded output. These signals are routed to the waveform monitor by pushbutton control. Video signals to the

picture monitor, also selected by pushbutton, are: R,B,G, - G; and encoded output.

Cameraman Conveniences. The TC-80A camera head is a cameraman's delight, with numerous conveniences, including advance design for smooth panning and tilting; a tilting, detachable viewfinder; four tally lights; two-way signaling; and a spring-loaded script clip. The intercom system has two independent channels with a separate channel for program audio.

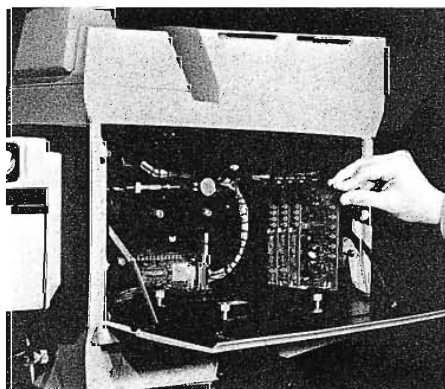

Planned For Serviceability. With its designed-in reliability, the TC-80A will provide long-term, trouble-free operation with minimal servicing. When service is required, however, many useful features such as easy tube change, interchangeable pre-amps, readily accessible components and extensive use of test points and voltage status lights have been included to cut maintenance time and costs.

High-Efficiency Switching Power Supply. The TC-80A power supply uses high-efficiency switching regulators for both camera head and processor frame power. Switching frequency has been optimized to reduce weight while increasing efficiency to insure reliable, cool operation without need for forced-air cooling. Size, weight and heat reductions for the switching supply, and a wide-input-lines spec of 90-130/180-260 VAC, make this supply ideal for operation in remote vans or under "brown-out" conditions.

Mechanical Integrity. The all-aluminum TC-80A camera case and the ½-inch-thick aluminum optical mounting plate are combined in a solid, precision-machined and stress-relieved unit. This provides stable operation even under the most demanding field conditions. All optics, yoke assemblies and lens are precision-mounted in this integral unit to give the TC-80A a truly adjustment-free optical system.

The camera head weighs only 85 pounds with viewfinder, enhancing its portability yet maintaining enough weight for smooth panning and tilting. Swing-out carrying handles add to the TC-80A's portability. The removable viewfinder, with indoor and outdoor viewing hoods, has an advanced tilt mechanism with TEFLON[®] impregnated bearings and improved tension adjustment for smoother tilting action.

For complete information on the TC-80A, contact your Harris TV District Manager or Harris' TV Sales Department in Quincy, Illinois (phone: 217/222-8200).

[®]Registered Trademark of DuPont

TC-80A Specifications

Electrical Scan Standards

EIA 525/60
 CCIR 625/50

Power Requirements

Voltage 90 to 130V or 180 to 260V
 Frequency 47 to 63Hz
 Power Load 500W (exclusive of monitoring)

Inputs (Loop-Through, Bridging)

Sync 2 to 8 Vpp, negative
 Blanking 2 to 8 Vpp, negative
 Sub Carrier 1 to 4 Vpp
 VF External Video... 1.0 Vpp Composite
 External video or black burst with optional sync generator 1.0 Vpp

Outputs

Program Video .. 3 separately selectable for composite or non-composite
 Chroma Key (R, B, G) ..0.7 Vpp across 75 ohms
 Picture Monitor Video ..0.7 Vpp across 75 ohms
 Waveform Monitor
 Video0.7 Vpp across 75 ohms

Monitor Switching Facilities

Picture R, B, & G or - G separately or combined; color output (program)
 Waveform R, B, G sequential or superimposed; R-G; B-G; color output (program)
 Viewfinder..... R, B or G; Y video; external video

Sensitivity (Typical tubes)

Minimum Incident Light for full output with f1.6 lens 6 fc
 Incident Light for rated Signal/Noise at f2.8 80 fc
 Signal/Noise Ratio
 NTSC 52 dB
 PAL 49 dB
 (300 na green signal current; 1.0 gamma; bandwidth NTSC - 10 kHz to 4.2 MHz, PAL - 10 kHz to 5.5 MHz; masking, aperture & chroma-off)
 Resolution (no aperture correction) 600 TV lines

Optical System

Color Separation ..Single unit prism with Integral Bias Light
 Correction Filters ..5 position filter wheel

Pick-Up Tubes

Red S73XQER or XQ1073R
 Blue S73XQB or XQ1070B
 Green S73XQG or XQ1070G
 ACT tubes also available.

Registration Accuracy

Zone 1 (circle = .8V) 0.05%
 Zone 2 (circle = 1.0V) 0.1%
 Zone 3 (circle = 1.0V) 0.2%
 Zone 4 (all other) 0.4%

Picture Geometry

Zone 2 1.0%
 Zone 4 1.0%

Camera Cable Length

With 0.65 inch (17mm) diameter cable2000 ft. (610m)
 With 1.1 inch (28mm) diameter cable3000 ft. (914m)
 With 0.5 inch (13mm) diameter Triaxial Cable and optional Triax System 5000 ft. (1524m)
 Over 5000 feet with larger diameter Triax Cable.

Operating Environment

Temperature
 Camera Head -20 to +50 degrees C
 Control Unit 0 to +50 degrees C
 Humidity 0 to 95% RH
 Altitude 0 to 10,000 ft. (3048m)

Shading Provisions

H & V sawtooth and parabola modulation. H & V sawtooth and parabola additive, for Bias Light.

Aperture Correction

Combined horizontal and vertical aperture correction derived from green with Comb filtering and noise coring. Primary horizontal boost frequency 6 MHz, with adjustable 2.5 MHz secondary boost.

Gamma Correction

Each Channel Continuously variable from linear to 0.35
 Master Gamma ..Continuously variable from linear to 0.35 independent of channel controls

Intercom

Camera Head & CCU Two headsets; Production, Engineering & Cue circuits
 Party Line ... Accepts up to three party lines; selectable impedance matching
 Program Audio Unbalanced bridging for cue audio

Signaling System

CCU to Camera Pushbutton flashes camera tally lights
 Camera to CCU...Pushbutton operates audible signal

Viewfinder

Screen Diagonal6.1 in. (155mm)
 Picture Brightness 0 to 150 ft. lamberts
 Resolution..... better than 600 TV lines
 Picture Timing AFC
 Video Equalization ... Full Cable length
 Controls Contrast, Brightness, Input Select and Response (flat, peak, notch)
 Focal Length Indicator ... White bar top of picture

Mechanical

Camera Head (Less lens)
 Height19.5 in. (495 mm)
 Width10.5 in. (267 mm)
 Depth21 in. (533 mm)
 Weight 85 lbs. (38 kg)

Processor Frame

Height8.75 in. (222 mm)
 Width19 in. (483 mm)
 Depth15.5 in. (393 mm)
 Weight 30 lbs.(14 kg)

Operate & Set-Up Panel

Height 7.0 in. (178 mm)
 Width19 in. (483 mm)
 Depth 7.0 in. (178 mm)
 Weight 11 lbs. (5 kg)

Intercom Panel

Height 1.75 in. (44 mm)
 Width19 in. (483 mm)
 Depth 7.25 in. (184 mm)
 Weight3 lbs. (1.4 kg)

Main Power Supply

Height5.25 in. (133 mm)
 Width19 in. (483 mm)
 Depth20 in. (508 mm)
 Weight 56 lbs. (25 kg)

Interconnect Panel

Height 7 in. (178 mm)
 Width19 in. (483 mm)
 Depth 6 in. (142 mm)
 Weight8 lbs. (3.6 kg)

Accessories

Triax System
 NTSC Sync Generator Module
 All one-inch format zoom lenses from Angenieux, Canon, Fujinon, Rank and Schneider.
 Camera Cable, std. length 50 ft., 75 ft., 100 ft., 150 ft., 200 ft., 250 ft., 300 ft., 400 ft., 500 ft.
 Triax Cable, std. length 100 ft., 250 ft., 500 ft., 1000 ft.
 Headset, single or dual, carbon mic
 Conrac SNA9 9-in. Picture Monitor
 Tektronix 528 or 1480 Waveform Monitor
 Cam Heads and Pedestals from Vinten, ITE and Quick-Set (Houston-Fearless).
 Vinyl Rain Cover



HARRIS
COMMUNICATIONS AND
INFORMATION HANDLING

TC-80 ADD-ON TRIAX CABLE SYSTEM

- Extends range of camera operation up to 5,000 feet
- Maintains all operational features of the Harris TC-80 color camera, including automatic features
- Reduces camera cable costs for remotes
- Triax cable is easier to transport, install, repair and use on remotes
- Allows camera use in previously inconvenient locations for more interesting coverage

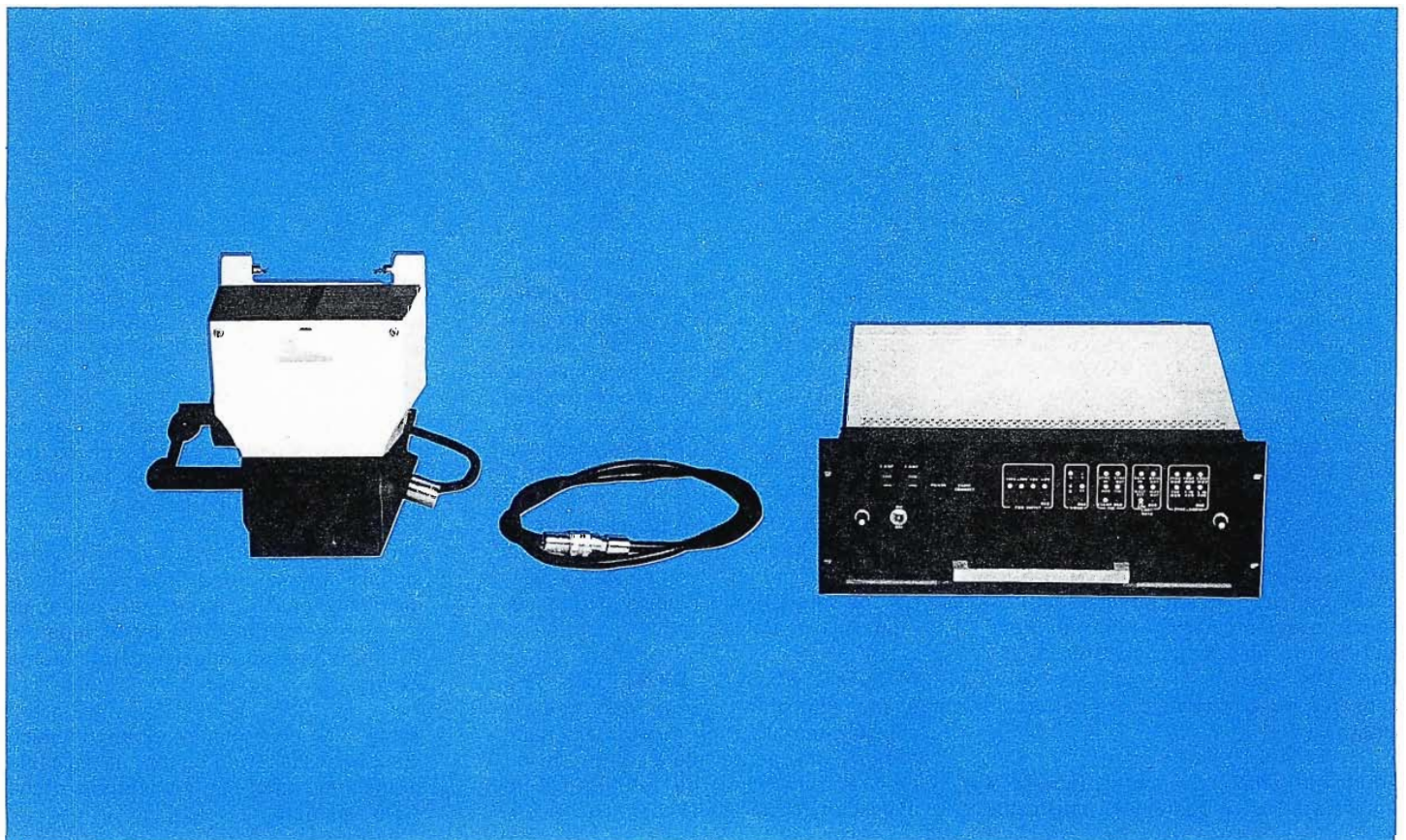

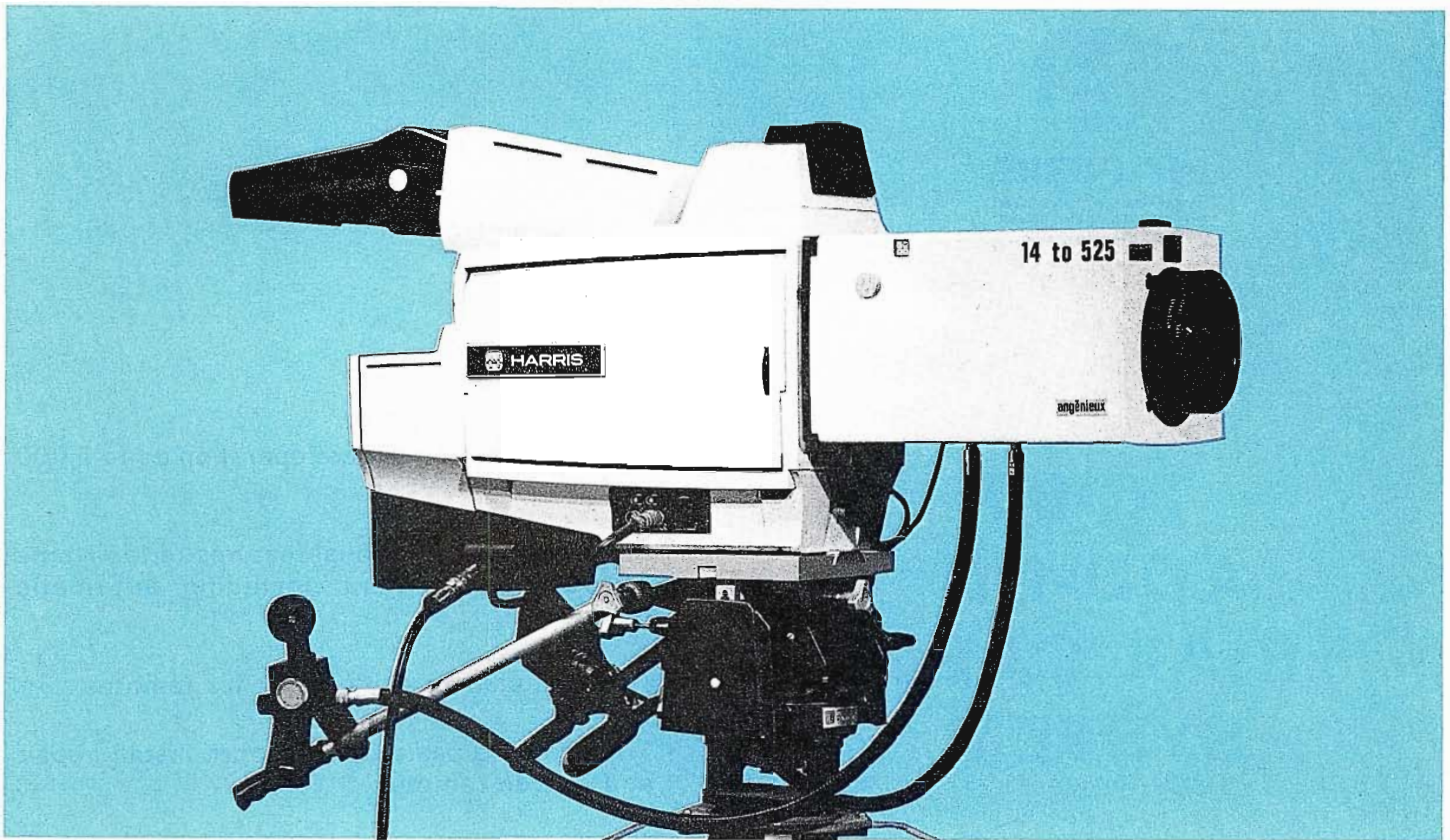

TC-80 (above), shown in a typical field configuration, with Triax and extended range zoom lens. Complete Triax system is made up of components at right: camera head unit, Triaxial cable, and CCU interface drawer.

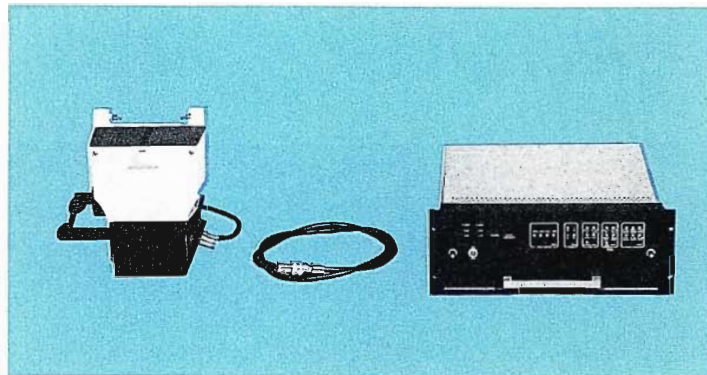

The Harris Triax Cable System provides a new dimension in versatility and flexibility for field operation of the Harris TC-80 camera. Easily added, with no special tools or camera modifications, the Triax system eliminates bulky, multi-conductor camera cable, and greatly extends the camera's range of operation.

Careful development of the Triax system has allowed Harris to offer this modern camera convenience with all of the basic TC-80 camera's fine automatic features. The Triax system itself is fully automatic and has no operational controls of any kind. The system automatically compensates for any change of Triax cable length.

Additional Triax advantages include a significant cost reduction in long cable

runs. And, since the system operates with smaller cable, not only will there be less weight to carry, but cable will take up less space in storage. There will also be sizeable cost reductions in permanent cable installations such as sports arenas, college campuses, or industrial complexes.

The TC-80 is the first American-built TV camera to offer you triaxial operation as an option without compromises in set-up or operation—a significant advancement in camera design.

MULTIPLEXING SYSTEM. The positioning of all set-up and operate controls remote from the camera head allows convenient camera set-up, saving time and money. The remote set-up philosophy requires 40 channels of con-

tinuously variable control information and 9 channels of switch information to be transferred from the CCU to the camera head.

The frame update rate is fast, so that the operator feels he has solid wire control from the set-up panel, and is unaware of the signal processing.

The red, blue and green camera video signals are returned to the CCU individually, on AM carriers, rather than as one encoded signal. This allows separate RBG outputs for clear, sharp chroma keying.

Table 1 shows the information which must be transmitted on the triaxial cable to maintain all of the fine features of the TC-80 camera.

CAMERA CABLE. The Triax system functions completely automatically on 75 ohm triaxial cable. The second shield of the triaxial cable provides added safety by maintaining an equal potential between the CCU and the camera head chassis. Cable lengths are limited only by DC resistance of the center conductor-shield loop and/or the RF attenuation of the coaxial cable. The Triax system will compensate for as much as 25 ohms of loop resistance and an RF attenuation of 55 dB at 50 MHz. The camera system is designed to operate using any of the Triax cables available.

Table 2 (on back page) shows typical cable types and maximum operating cable lengths. The Triax unit is supplied with a male bulkhead Kings Tri-Loc® connector at the camera head and a 4-foot pigtail with a female Kings Tri-Loc® cable connector at the CCU. The pigtail allows increased flexibility for installation in studio or van racks.

SERVICEABILITY. With its designed-in reliability, the Triax system will provide long-term, trouble-free operation with minimal servicing. When service is required, many useful features such as plug-in modules, use of common electronic components, IC sockets, readily accessible components, the drawer-within-drawer concept of the CCU, voltage status lights and front panel test points at the CCU have been included to cut maintenance time and costs. The CCU drawer has been designed so that the unit can be extended, exposing all circuitry for troubleshooting without removal from the rack, and without the use of extender boards. In addition, 23 test points on the front panel monitor the operation of all subsystems and verify correct operation without opening the unit.

**Table 1
TRIAX CABLE SPECTRUM**

CCU-TO-CAMERA HEAD	FREQUENCY ALLOCATION
1. Power (+130V DC)	D.C.
2. Composite Sync	Carrier 2.04 MHz, VSB AM
3. CCU-to-Camera Controls (40 control channels, 9 channels of switch data)	Carrier 2.04 MHz, VSB AM, digital information, time domain multiplexed with composite sync
4. Audio channels	Carriers 2.7, 2.8, 2.9 MHz, DSB AM
5. Viewfinder Video	Carrier 55.5 MHz, DSB AM
CAMERA HEAD-TO-CCU	
1. Red Video	Carrier 18.5 MHz, DSB AM
2. Blue Video	Carrier 9.25 MHz, DSB AM
3. Green Video	Carrier 37 MHz, DSB AM
4. Camera-to-CCU Controls	Carrier 18.5 MHz, DSB AM, digital information, time domain multiplexed with red video blanking
5. Audio Channels	Carriers 3.1 and 3.3 MHz, DSB AM

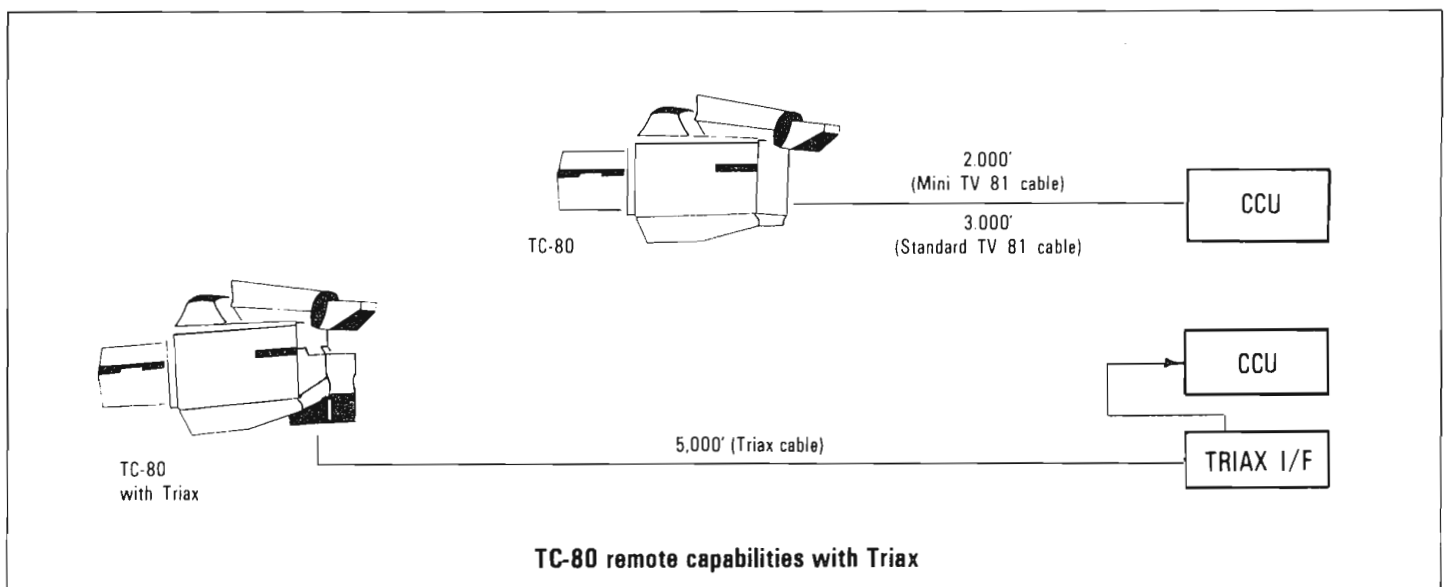

**TABLE 2
TYPICAL CABLE FOR USE WITH TRIAX SYSTEM**

CABLE	OUTSIDE DIAMETER		TYPE	MANUFACTURER	JACKET	MAXIMUM CABLE LENGTH		WEIGHT	
	Inches	(mm)				Feet	(Meters)	Per 1,000 ft. in lbs.	Per 100m (in kg)
TRIAx	0.36	(9.1)	9267 TV20	Belden BIW	Neoprene or Hypelon	2,000	(650)	74	(54)
	0.52	(13.2)	9232 TV14	Belden BIW	Neoprene or Hypelon	5,000	(1,640)	135	(98)
	1.03	(26.2)	— —	Belden BIW	Neoprene or Vinyl	7,700	(2,520)	550	(401)
MULTI- CONDUCTOR (Shown for comparison purposes only)	0.65	(17)	TV81 Mini	—	Vinyl	2,000	(610)	375	(273)
	1.1	(28)	TV81	—	Vinyl	3,000	(914)	875	(638)

TC-80 TRIAX SYSTEM SPECIFICATIONS

See the Harris TC-80 brochure for specifications of the camera.

ELECTRICAL SCAN STANDARDS

EIA 525/60.
CCIR 625/50.

POWER REQUIREMENTS

Supplied completely by Harris TC-80 camera.

INPUTS AT CCU: Signals on 81 conductor cable connector and 14 pin triax accessory connector.

INPUTS AT HEAD: Signals on 81 conductor cable connector and 13 pin triax audio connector.

CHANNEL BANDWIDTH

GREEN VIDEO: 1 dB at 5 MHz.

RED VIDEO: 1 dB at 3 MHz.

BLUE VIDEO: 3 dB at 3 MHz.

VIEWFINDER VIDEO: 1 dB at 5 MHz.

OPERATING ENVIRONMENT

TEMPERATURE: Camera Head —20 to +50° C. Control Unit 0 to +50° C.

HUMIDITY: 0 to 95% RH, non-condensing.

ALTITUDE: 0 to 10,000 ft.

MECHANICAL

CAMERA HEAD: Height 12.5 in. (31.8cm). Width 9.1 in. (23.1 cm) excluding camera cable. Depth 12.8 in. (32.5 cm). Weight 17 lbs. (7.7 kg).

CCU: Height 7 in. (17.7 cm). Width 19 in. (48.3 cm). Depth 21 in. (53.3 cm). Weight 40 lbs. (18.1 kg).

**CABLE AND CONNECTOR
ORDERING INFORMATION**

Triax cable may be ordered in standard lengths of:

- 50 feet (15.2m)
- 100 feet (30.5m)
- 250 feet (76.2m)
- 500 feet (152.4m)
- 1,000 feet (304.8m)

The above include connectors. Triax cable may also be ordered in 1,000-foot (304.8m) rolls, without connectors.

Connectors available include:

- Connector, male
- Connector, female
- Connector, female bulkhead
- Connector retro-fit kits

Specifications subject to change without notice.



HARRIS
COMMUNICATIONS AND
INFORMATION HANDLING

TC-50

Live Color
Television
Camera

- Top-of-the-line camera performance
- Bias light for low light level capability
- Triple voltage regulation for excellent stability
- Sealed prism optics
- Rugged, cast aluminum frame for precision alignment
- Electronic picture rotation
- Integral encoder with color bars
- Designed to accept long, heavy lenses

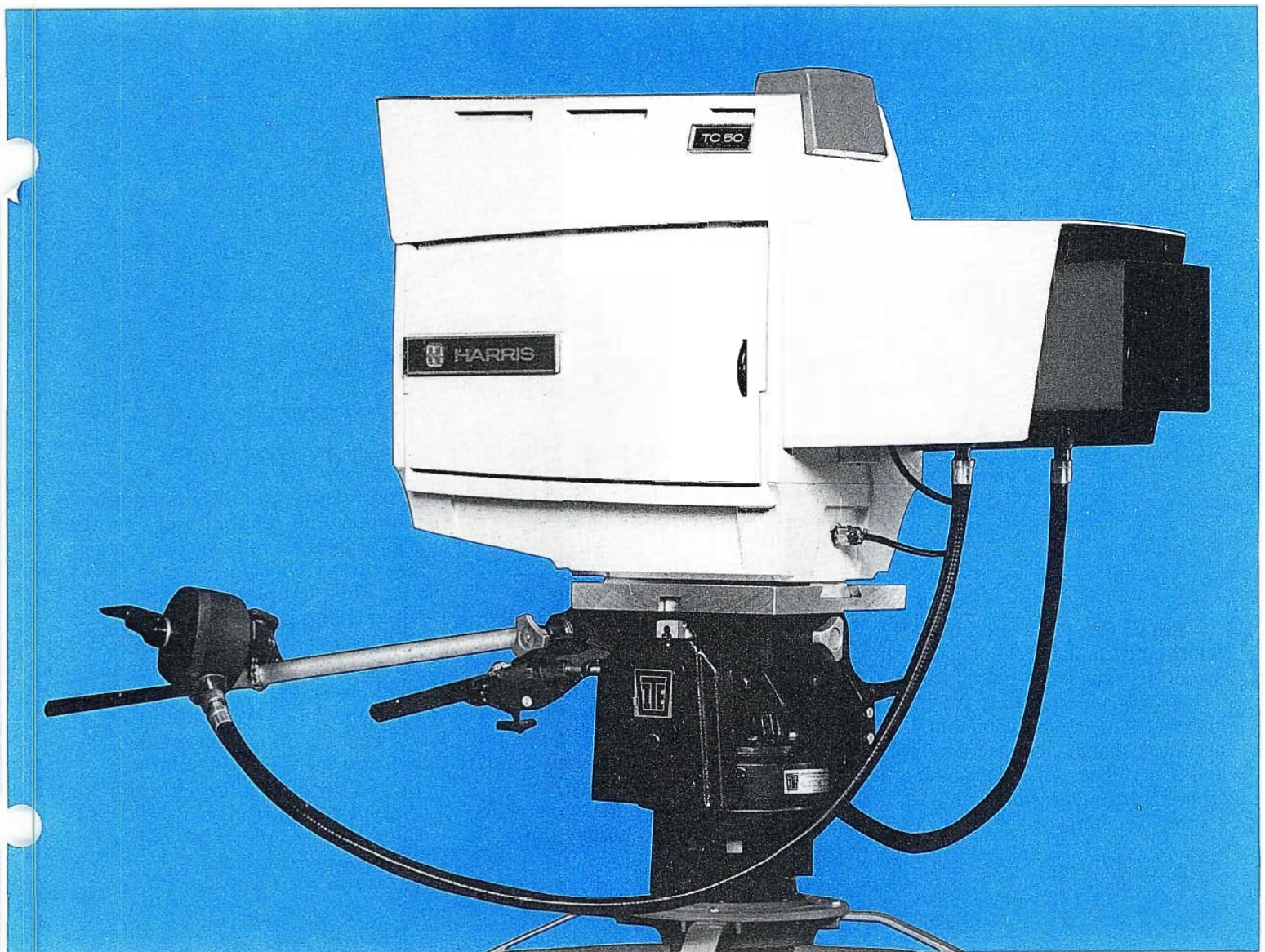

... a first line broadcast quality prism camera

In the TC-50, Harris has applied its extensive experience in broadcast equipment to offer you a camera with excellent color fidelity, superb picture quality, and great flexibility—all at a much lower price than you would expect for top grade broadcast performance. To accomplish this, we have concentrated on basics, and eliminated frills and seldom used automatic features.

For operating convenience, a remote control philosophy has guided the design of the TC-50. The camera can be set up and operated from the Camera Control Unit. Cameraman controls are minimized.

The system has been designed throughout to provide excellent stability and reliability in performance.

Superb color performance

The TC-50 is a prism camera using three 1-inch Plumbicon® tubes. The prism, which includes all color separation surfaces, is built and installed as a sealed package unit in the camera. This assures uniformity from camera to camera, and optimum colorimetry.

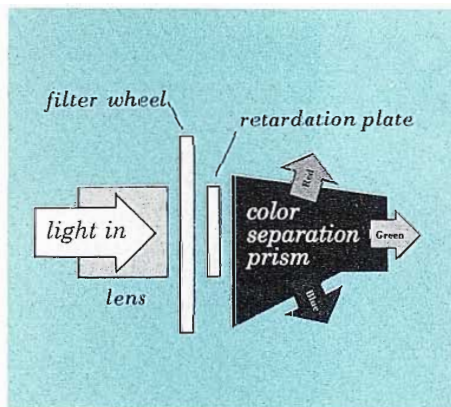

Linear color matrix: Superb colorimetry is achieved through the use of a linear color matrix.

Aperture correction: An integral horizontal aperture corrector produces sharp, clear pictures. For added crispness an integral contours-from-green image enhancer with comb filter is provided.

©Reg. trademark N.V. Philips

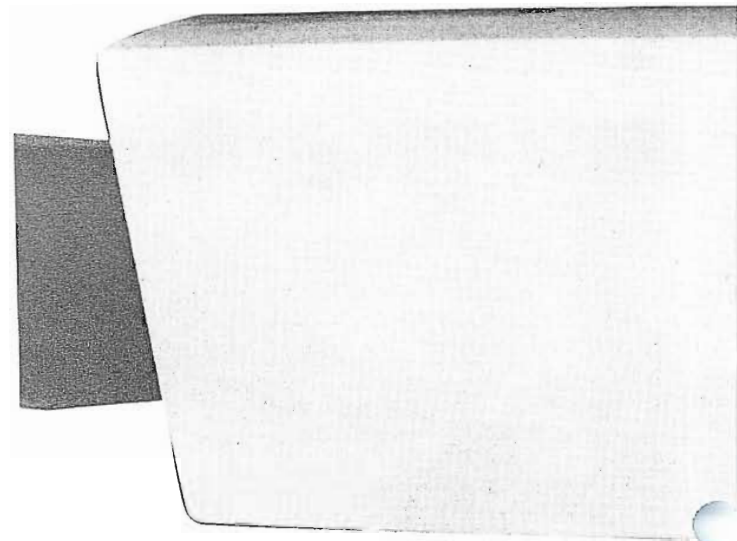

Anti-polarization: The TC-50 optical system incorporates a retardation plate, which eliminates color shift or distortion resulting from polarized light produced by sources such as polished floors or hair spray.

Color correction: A 5-position color correction filter wheel is incorporated in the optical system to allow for varying light conditions.

Low-light capability: The TC-50 is designed for outstanding capability under low-light-level conditions. Through the use of a single master gain control, correct color balance is maintained with optimum signal to noise.

Integral bias light: The optical system includes an integral bias light which reduces lag when operating at low light levels. This improves picture quality and avoids "smear."

Stability and reliability

A basic objective of outstanding stability and reliability of operation has been achieved through rugged, imaginative design.

For example, the color separation prism is a sealed, adjustment-free unit. All optical components are mounted on a rigid cast-aluminum plate and case to assure long-term stability.

The TC-50 is light enough to be transportable, yet solid and rugged for durability and reliability. Strong handles attached to the camera frame swing out to permit easy carrying.

TC 50

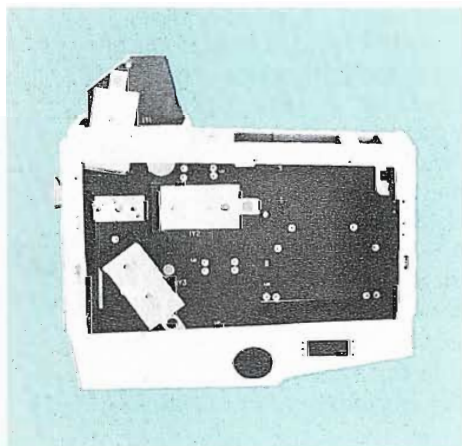
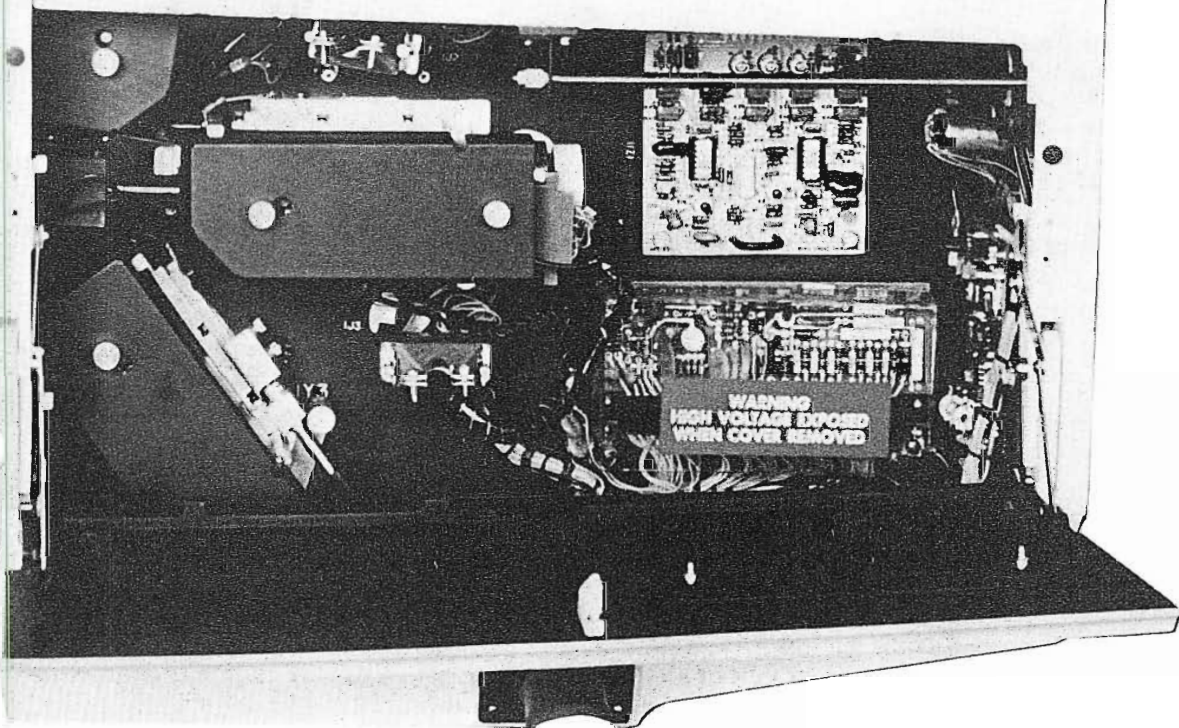

Cast aluminum mounting plate and case comprise a solid, precision-machined, stress-relieved, integral unit. The lens interface surface is machined after assembly to assure adjustment-free optical alignment. The rigidity of construction permits the camera to accommodate long, heavy lenses where desired.

Precision yoke assemblies: Each of the Plumbicon® tubes is mounted in a printed coil yoke. Each yoke assembly is precisely located on the

rigid optical bed by a self-aligning quick-release mechanism.

Triple regulation: All critical voltages are regulated—not once but three times—to assure excellent stability of operation.

Interference protection: Shielding is incorporated throughout the camera to minimize effects of radio frequency interference.

Keeps cool and dry: A fan is mounted in the bottom of the camera to provide forced air ventilation and positive air pressure inside the case. This assures increased reliability of camera and viewfinder. Camera head is designed for dependable outdoor operation.

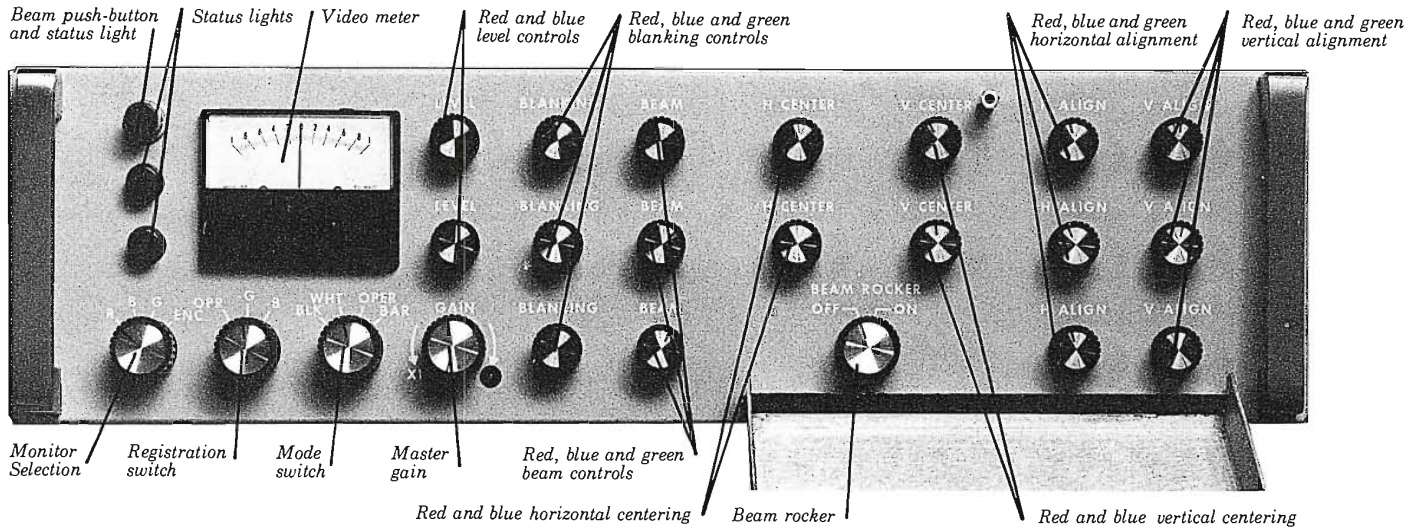
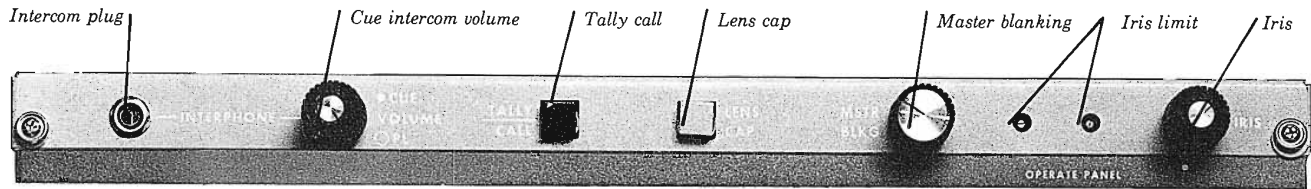

Designed for convenient set-up and control

A remote control philosophy has guided the design of the TC-50. Controls are centralized at the CCU (Camera Control Unit), thus the camera can be set up and operated from the CCU. Control and set-up procedures have been designed to eliminate control inter-action.

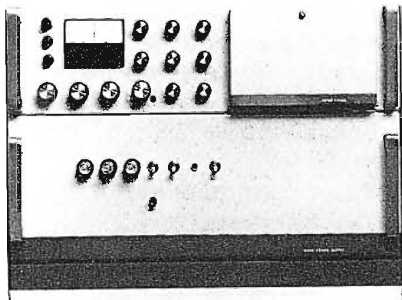

The CCU has three components: operate panel, set-up panel control drawer, and power supply. These can be conveniently rack mounted in one location, or the operate panel can be remoted to another location.

Mounting: Control units can be mounted in a standard 19-inch rack occupying only 8 rack units (14 inches) or in a compact field case.

Picture rotation: A unique design feature provides an adjustment at the CCU for electronic rotation of the red and blue pictures. This eliminates the need for mechanical yoke rotation.

Master gain control: Under insufficient light conditions, the master gain control provides for boosting video gains while maintaining correct color balance. The master gain control is continuously variable, providing smooth transition and optimum signal-to-noise ratio.

Push-button beam set: The beam can be adjusted easily by using a push-button circuit which momentarily reduces sensitivity in each channel by 50%. This -6 dB gain feature facilitates following the recommended beam setting procedure.

Flare compensation: Controls are provided for flare compensation in all three color channels. This circuitry maintains blacks even under extremes of contrast.

Master blanking: The video operator can readily adjust the black level of the picture over a wide range with the master blanking control. The normal operating point is located readily by an electronic null at the center position of the control.

Video meter: A small video meter on the front panel of the control drawer provides quick, simple set-up of white balance and black balance and can substitute for a waveform monitor.

Integral encoder: Camera system includes NTSC encoder in the control drawer. A built-in color bar generator facilitates encoder alignment.

Lens cap: Lens cap is remotely operable for ease of set-up, and for standby periods.

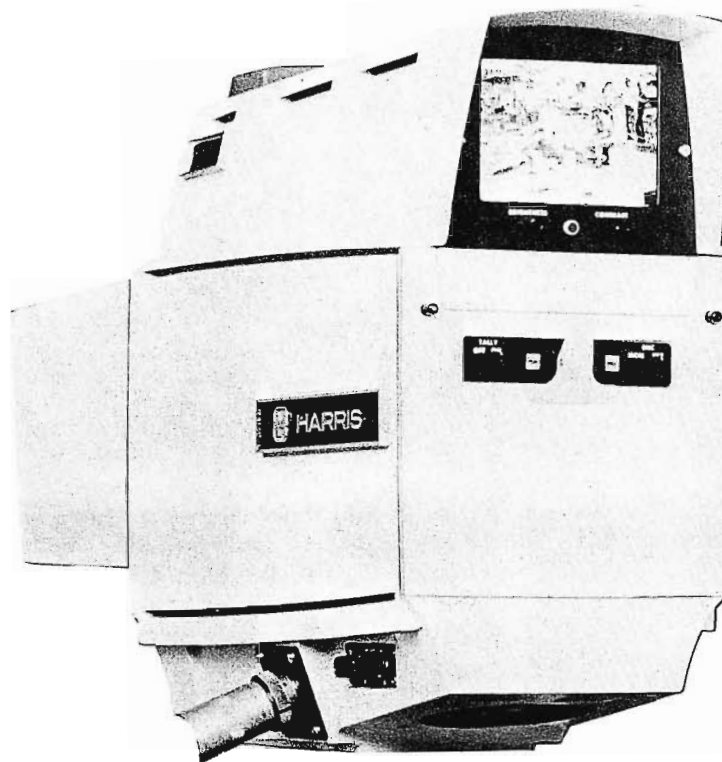

Cameraman convenience

Filter wheel: A color correction filter wheel, particularly desirable for outdoor use, is incorporated in the optical system. To simplify use, the wheel is accessible without opening camera head doors.

Clip control: To simplify set-up, the camera is equipped with a master white clip control.

Special effects: Many visual effects can be created with various optical accessories including star filters, close-up adapters, additional color and neutral density filters, etc. These are available off-the-shelf for use with the TC-50.

Red, blue, and green outputs are provided for use with Chroma Keyers or other special effects generators.

Camera operation is enhanced by its weight and size, assuring smooth panning and tilting. With controls centralized at the CCU, a technical man is not required at the camera head. Likewise, adjustments in the camera head are minimized.

For the cameraman's convenience, the following controls are provided at the camera head:

- High peaking control, activated by push-button, to aid in focusing.
- Selectable viewfinder display.
- Viewfinder brightness and contrast.
- Intercom volume—one for each headset.
- Main tally "off-on" switch.
- Call button.

Versatile viewfinder display: The integral viewfinder is designed for versatility, with a three-position selection of display.

The encoded output position displays properly framed output of the camera. The CCU monitor switch output position presents individual red, blue, green, or difference pictures. The external

video position displays special effects such as split screen.

Separate viewing hoods for indoor and outdoor service are included.

Tallys: The main camera head tally light is large, bright, and located on top of the unit for 360-degree visibility. Another tally is located on the viewfinder for convenience of the cameraman.

A two-way signaling system is provided between the camera and the CCU. A push-button at the camera head energizes an audible signal and the tally light at the CCU. A push-button at the operate panel lights the camera tallys.

Intercom: An intercom system links the camera and the CCU. Facilities are provided at the camera head for two headsets.

A bridging input is provided so that program audio can be inserted in the intercom system. A volume control for this input is located at the CCU.

Script clip: As an added convenience feature for the cameraman, a script clip is provided at the rear of the camera.

Planned for serviceability

The TC-50 has a rugged mechanical design, and numerous innovative features to provide exceptional reliability. When service is required, however, the system is designed for ready accessibility and simplified service.

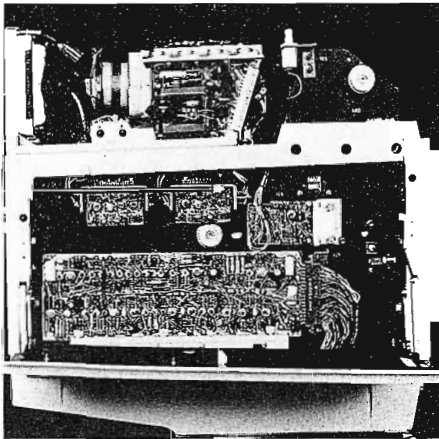

Camera head can be serviced without use of extenders; circuit boards can be checked without removing.

Interchangeable pre-amps: Because of differences in sensitivity in the three channels, selectable pre-amp gain is provided to assure matched pre-amp outputs. Pre-amps are interchangeable, simplifying maintenance and stocking of parts.

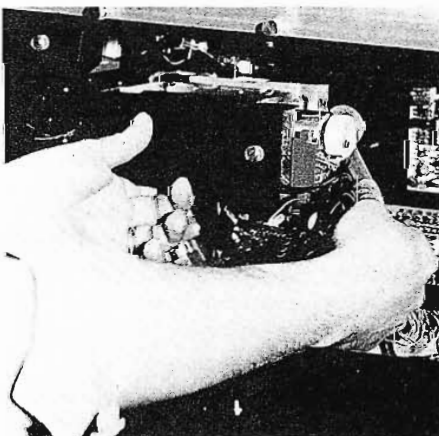

Pick-up tubes: Replacement is quickly accomplished without use of tools, and does not require removal of other camera head components. Each precision yoke assembly is attached with a self-

aligning quick-release mechanism. A single connector provides connections for the pre-amp, the tube, and the yoke.

Captivated hardware: All covers and camera head circuit boards are fastened with captivated thumbscrews.

Removable viewfinder: The viewfinder is detachable. A long extension cable is provided to facilitate servicing.

Status lights: Seven indicator lights inside the camera show availability of necessary voltages from the CCU to assist in fault isolation.

Test points are provided at all critical locations to simplify maintenance.

Hour meter: The camera head includes an elapsed time meter as an aid to preventive maintenance.

User connections: Tally light and intercom connections are readily accessible and identified at the rear of the CCU.

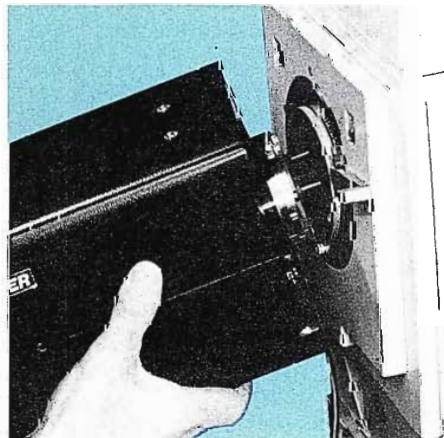

Camera will handle a variety of standard lenses. These are interchangeable, and are attached with a quick-disconnect bayonet mount.

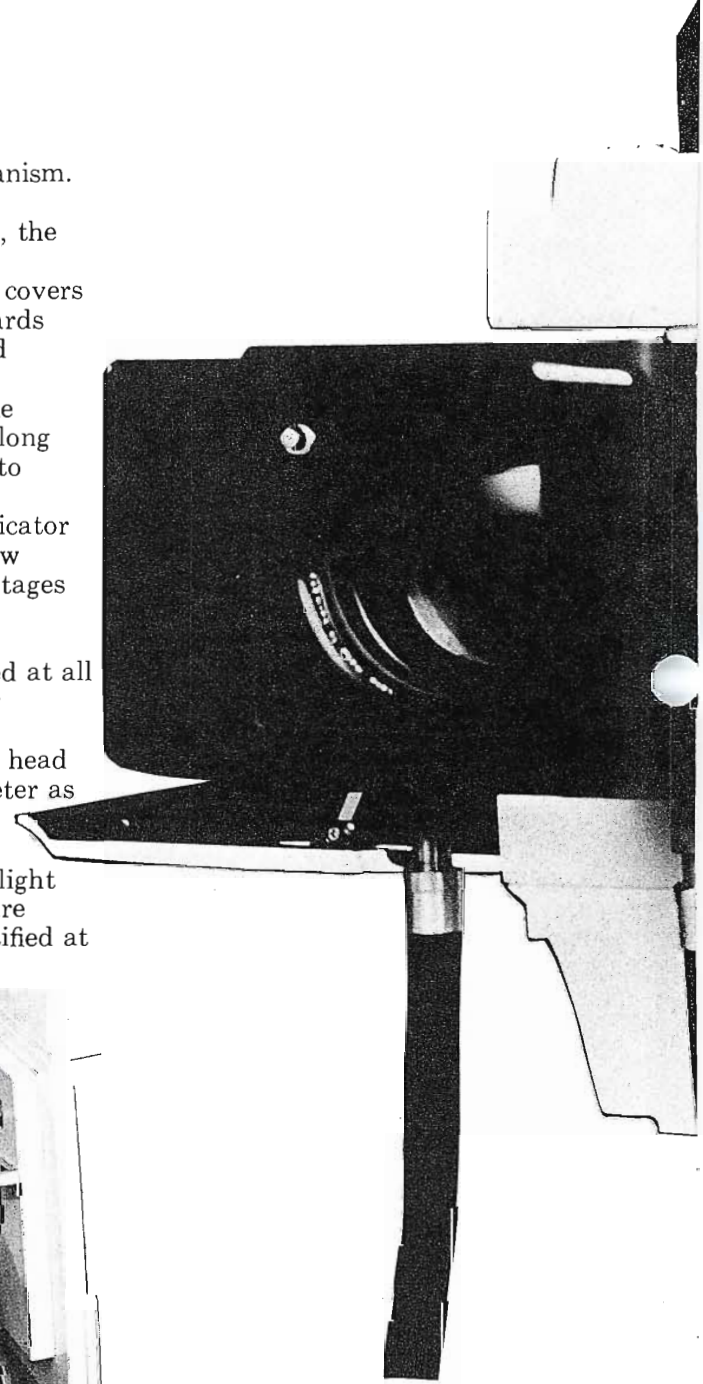

CCU control drawer extends and tilts for ready access and servicing.

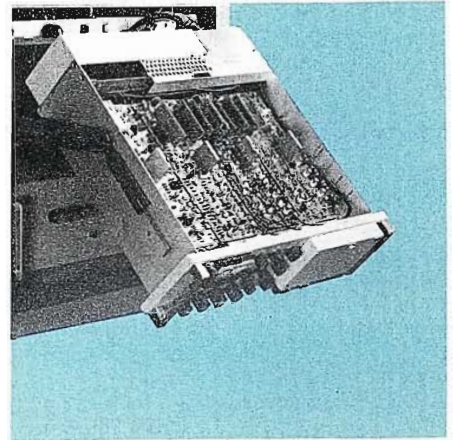

Flexibility in accessory selection

Lenses: The camera accommodates a wide choice of standard, readily available lenses offered by all leading lens manufacturers. These range from the basic 10/1 zoom, up through faster, more versatile lenses with extended zoom ranges.

Commonly used lenses which interface with TC-50:

- Schneider TV-38.
- 10X (17-170mm f/2.0)
- Canon PV10X15B-IE.
- 10X (15-150mm f/1.8)
- Fujinon K10X16RW-2
- 10X (16-160mm f/2.0)

In addition, most other standard broadcast lenses available for the 1-inch format can readily be used with the camera.

Compatible pedestals: All popular cam heads and pedestals can be used.

Optional plug-in module accessories in CCU:

- Integral cable compensator module for up to 1500 feet.
- Integral NTSC sync generator module.

TC-50 Specifications

Electrical Scan Standards

EIA 525/60
CCIR 625/50

Power Requirements

Voltage 90 to 130V or 180 to 260V,
60 Hz (50 Hz on request)
Power Load 260 VA (exclusive
of monitoring)

Inputs (Loop—Through, Bridging)

Sync 2 to 8Vpp, negative
H Drive 2 to 8Vpp, negative
V Drive 2 to 8Vpp, negative
Sub Carrier 1.5 to 4Vpp
VF External Video 1.0Vpp composite

Outputs

Program
Video Two Composite,
1Vpp across 75 ohm

Chroma Key
(R,B,G) non-composite 0.7Vpp
across 75 ohm

Monitor Video
non-composite 0.7Vpp
across 75 ohm

Monitor Switching Facilities

Picture and
Waveform R,B, & G separately
or combined with —G or
—B; color output (program)
Viewfinder output of picture &
waveform monitor switch;
Y video; external video

Sensitivity (Typical tubes)

Minimum Incident Light for full output
with f2.0 lens 12fc
with f1.6 lens 8fc

Incident Light for
rated Signal/Noise 100fc at f2.8

Signal/Noise
Ratio better than 48 dB
(300 na green signal current;
1.0 Gamma; bandwidth 10 kHz to
4.2 MHz; masking, aperture and
chroma—off)

Center Resolution: typically 40% @ 5MHz
at program output—correctable to 100%

Optical System

Color Separation single unit prism
with Integral Bias Light
Correction Filters 5 position
filter wheel
Depolarization retardation plate
at prism input

Pick-up Tubes

Red Amperex XQ1073 extended red
Blue Amperex XQ1070B
Green Amperex XQ1070G

Registration Accuracy

Zone 1 (Circle=.8V) 0.05%
Zone 2 (Circle=1.0V) 0.1%
Zone 3 (Circle=1.0H) 0.2%
Zone 4 (All Other) 0.4%

Picture Geometry

Zone 2 0.5%
Zone 4 1.0%

Camera Cable Length

Without Optional
Module to 300 ft. (91M)
With Optional
Module to 1500 ft. (457M)

Operating Environment

Temperature
—Camera Head —20 to +50
degrees C
—Control Unit 0 to +50
degrees C
Humidity 0 to 95% RH
Altitude 0 to 10,000 ft. (3048m)

Stability

After a 30 minute warm-up the camera
will perform within specifications for 8
hours, provided the temperature change
does not exceed ±10 degrees C or the
specified limits.

Shading Provisions

H&V sawtooth and parabola modulation,
H&V sawtooth and parabola additive,
for Bias Light.

Aperture Correction

Combined horizontal and vertical aper-
ture correction derived from green with
comb filtering and noise coring.

Gamma Correction

Continuously variable from linear to 0.35,
each channel.

Intercom

Party Line 600 ohm balanced
to ground
Camera Head accommodates
two headsets;
separate amps
& controls
Operate Panel one headset,
amp & controls
Program Audio bridging input
(unbalanced with
level control)

Signaling System

CCU to Camera push-button
operates camera
tally lights
Camera to CCU push-button
operates tally lights
and audible signal

Viewfinder

Screen Diagonal 7 in. (178 mm)
Picture Brightness 0 to 150 ft.
lamberts
Resolution better than 600 TV lines
Picture Timing AFC
Video Equalization Automatic to
maximum cable length
Controls Contrast, Brightness,
Video Peaking and
Input Select

Mechanical

Camera Head (Less lens)
Height 19.5 in. (495 mm)
Width 10.5 in. (267 mm)
Depth 21 in. (533 mm)
Weight Approximately
75 lbs. (34 kg)

Control Drawer

Height 5.25 in. (133 mm)
Width 19 in. (483 mm)
Depth 22 in. (559 mm)
Weight 20 lbs. (9 kg)

Operate Panel

Height 1.75 in. (45 mm)
Width 19 in. (483 mm)
Depth 7.25 in. (184 mm)
Weight 2 lbs. (.9 kg)

Main Power Supply

Height 7 in. (178 mm)
Width 19 in. (483 mm)
Depth 18 in. (457 mm)
Weight 38 lbs. (17 kg)

Accessories

NTSC Sync Generator Module
Cable Compensation Module
Zoom Lenses
Canon PV10X15B-IE, 15-150mm, f1.8
Schneider TV-38, 17-170mm f2.0
Fujinon K10X16RW-2, 16-160mm, f2.0
Most other one-inch format lenses from
Angenieux, Canon, Fujinon, Rank and
Schneider
Camera Cable, std. lengths 50 ft., 100 ft.,
150 ft., 200 ft., 250 ft., 300 ft.,
400 ft., 500 ft.
Operate Panel Extension Cable, std.
lengths 25 ft., 50 ft., 100 ft., 200 ft.
Headset, single and dual
Conrac SNA9, 9-inch Picture Monitor
Tektronix 528 Waveform Monitor
ITE Cam Head, H2 or H3; ITE P4 or P5
Studio Pedestal
ITE-WA Wedge Adapter; ITE-WP Wedge
Plate
Quick-Set (Houston-Fearless) and Vinten
Cam Heads, Pedestals, etc.
Vinyl Rain Cover

EPIC

Computer-Aided Editing System



HARRIS



COMMUNICATION AND
INFORMATION PROCESSING

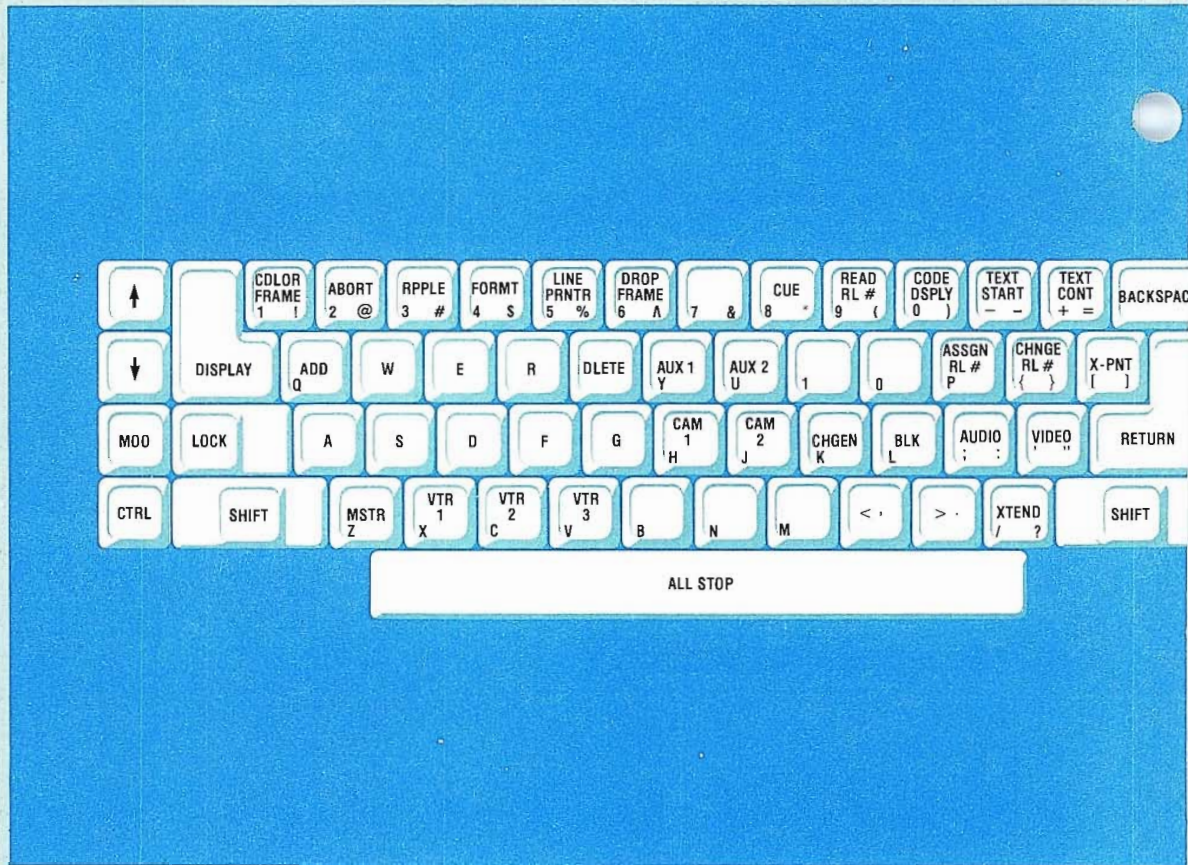

EPIC:

Computer versatility with less hardware overhead

The CVS EPIC is a complete, software-based system that provides everything you need for fast, accurate, on-line or off-line editing with multiple VTRs—from quadruplex and 1" units to 3/4" cassette units. Unlike other editing systems, EPIC puts as many functions as possible into software, to reduce total system costs while giving you more editing versatility and convenience.

With EPIC, functions that, before, required separate, costly hardware, such as time code generation, are now done in software. In addition, all necessary interface circuitry is on plug-in circuit cards (See Figure 2) housed in a single, rack mounted chassis. Figure 1 (see flap page) compares a typical "hardware-oriented" system with EPIC.

What's more, EPIC comes with a completely developed software package. You don't need computer experience or a knowledge of programming. Commands and displays

are in simple English, and operator training time is minimal.

The flexibility of a software approach also allows customizing many aspects of the system to your special requirements at little, or no, extra cost. Future capabilities are also easily implemented in existing systems. And, of course, reliable performance and service is assured because Harris is an established leader in video signal processing for the television industry.

Wide Range of VTRs

Generally speaking, any VTR with remote control can be used in the EPIC system. Plug-in interface cards are available for a large number of VTRs, from 3/4" to 2", and you can mix formats. VTR interface requires only minimal modification with no loss of VTR capabilities.

VariShuttle™ VTR Control

Many newer VTRs feature variable-speed play and shuttle modes. With VariShuttle, you don't give up any of these features. You keep complete control of all VTR functions, such as shuttle speeds, slow motion and so on. Whatever the VTR will do, EPIC will do.

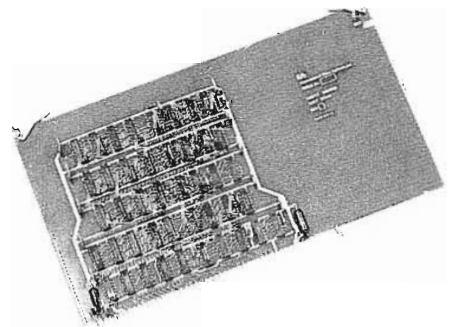
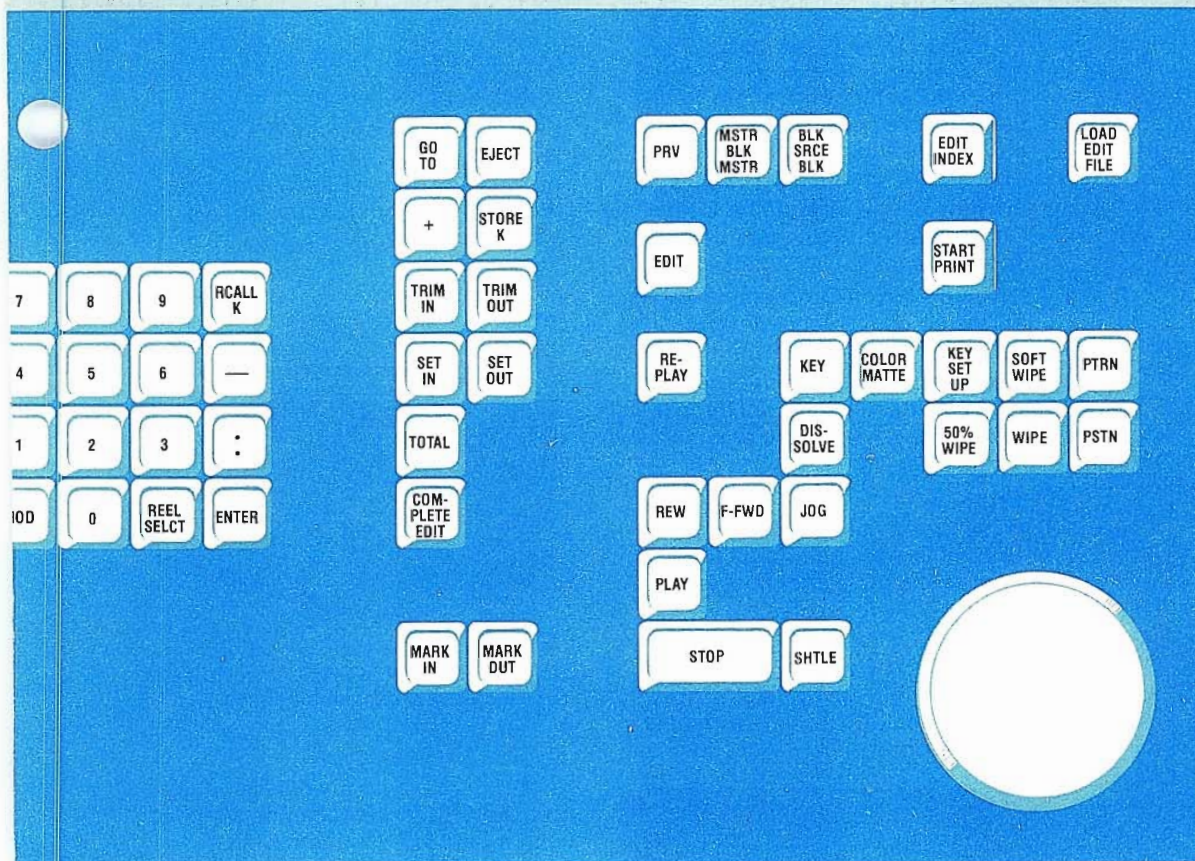

Figure 2: Circuitry for 4 time code generators is contained on one EPIC plug-in card.



Time Saving Thru Multi-Tasking

A major advantage of the EPIC system is multi-tasking: the ability to do more than one thing at a time. This feature alone saves hours over other editing systems.

For example, while you're executing one edit decision, you can be storing another and be printing out previous edits. Or while you're using some VTRs for editing, you can, at the same time, be writing time code on others and searching out the next take on still another.

Works With Most Video Switchers

EPIC can be interfaced easily to almost any computer-compatible video switcher, with virtually no loss of video switcher capability. CVS's unique capability to control two mix/effects buses and up to 16 input crosspoints adds flexibility and makes editing much faster. Wipe keys, dissolves, split screens . . . whatever the switcher can do, EPIC will do.



Figure 3: A single, re-usable EPIC mini floppy disc automatically stores 2,000 edits.

Full Audio Capability

EPIC is available with an 8 x 2 audio switcher that has both mix and position capabilities. Split audio/video edits, with no limit on in-out times, is also part of EPIC. Many audio tape recorders may also be readily interfaced.

A Complete Software Package

The Standard EPIC software package includes everything you need for fast, accurate professional editing with multiple VTRs. Computer programming experience isn't required.

All of the following functions are EPIC standard.

- **Rapid Entry of Edit Data:** Edits can be entered from floppy discs, optional paper tape, on line video tapes or manually. Edits can be modified the way *you* want, without addition or subtraction.
- **Flexible List Management:** Modify decisions, insert new ones anywhere on the list and move or delete existing ones. Changes are verified immediately on the display. Pushbutton selection of ripple or non-ripple is also standard.
- **Look Ahead:** VTRs are positioned ahead of time (with staggered start) to set up edits as switcher transitions. This allows smooth A/B rolls without need for a matched edit.
- **Continuous Editing:** A long chain of edits can be entered at one time, then executed without interruption.

- **Multi-Tape SMPTE or EBU Time Code Generation and Reading:** Permits coding of 4 tapes simultaneously, saving hours of production time. Also, a time code reader is included on each VTR interface card. You don't need expensive, stand-alone time code generators or readers for each VTR.
- **Jam Time Code:** Allows rewriting missing or poorly recorded time code.
- **Adjustable Cue Time:** Variable from 3 seconds to 2 minutes to match pre-roll times to varying VTR requirements or different tape conditions.

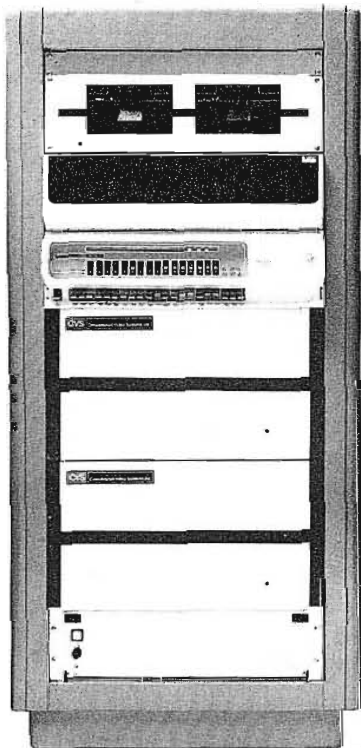

Figure 4: All EPIC components, except the compact keyboard, can be housed in a single 19" rack.

- **Color Framing:** EPIC writes time code at pre-established color phase, thus reducing color frame discontinuities. An optional color framing accessory will soon be available to look at off-tape color burst and provide absolute framing.

- **User Bit Reel Identification:** Reel numbers are put on tapes in user bits. EPIC reads the tape, and the reel number appears on display.
- **Preview Single or Multiple Edits:** On the master, on the source or on both together.
- **Mix Drop & Non-Drop Frame Tapes:** An added convenience for production, if necessary.
- **Text Notations:** Notes are recorded with edits and will appear on the display when the edit is recalled.

Software Expansion

Due to the software-based design of EPIC, it is anticipated that new software routines—adding even more flexibility to the system—will be developed. Because of this, the basic EPIC system price includes a full year of software updates. Subsequent updates will be made available at nominal cost.



Figure 5: EPIC uses standard video monitors to display editing data on uncluttered formats.

Almost Unlimited Edit Storage

EPIC discs give you essentially unlimited capacity, plus millisecond access to stored edits. A single, reusable disc holds 2,000 edits (See Figure 3). In addition, EPIC automatically stores edits on disc, as you make them, without slowing down your editing. This protects against the loss of your edit decision list if there's a power failure or other malfunction.

Direct Action Keyboard

EPIC is designed for editors who know what they want. When you press a key on the EPIC keyboard, the related function happens instantaneously.

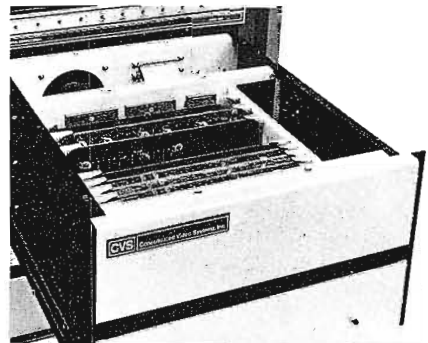

Figure 6: "Slide-out" rack mount chassis provide easy access to all circuitry.

Choice of Outputs

In addition to a floppy disc list output, the EPIC system can be supplied with a printer, TTY and a CMX-compatible paper tape punch/reader.

Multiple Display Formats

Instead of jamming everything onto one display format, EPIC can provide several different, uncluttered displays. One of these is shown in Figure 5. And, since the display is a standard TV monitor, updates and changes are displayed almost instantly.

Reliability Backed By Service

Since EPIC has less electronic hardware than most other systems, there are fewer things that can go wrong. And that means less downtime. In addition, every EPIC system is checked out completely, using the most stringent standards in the industry. Along with this, an established worldwide network of authorized sales and service distributors provides unequalled service support.

A complete system for on or off-line editing

EPIC provides everything you need for professional, multiple VTR editing. The basic 3-VTR system can be easily expanded to 8 VTRs (or more) by merely adding plug-in interface cards. In addition to a complete software package (described on facing page), the standard EPIC system consists of a keyboard, a proven, off-the-shelf minicomputer, a disc storage unit and one or (optional) two, 10½" high, 19" wide chassis. The chassis hold printed circuit boards which contain all necessary circuitry.

Customizing

Since many EPIC functions are in software, the system can be readily tailored to your way of doing things.

Initialization, for example, is an easily changed software routine. What cue time do you want? Do you want to look at all VTRs immediately? Do you want time code with drop frame or non-drop frame? The versatility made possible by EPIC is almost unlimited.

EPIC Fits Your Facility

With EPIC, the only thing you interact with is the free standing keyboard. Electronic chassis and the computer fit in a customer-supplied 19" rack (See Figure 4). And, since the keyboard is compact, you can put it anywhere you like: on a desk or in your own custom console. You can also put the display anywhere you want because EPIC uses a standard video monitor to display the edit list.

Figure 1: Comparison of typical "hardware-oriented" system with EPIC software-oriented system.

A "hardware" system needs separate units for such things as time code generating and reading.

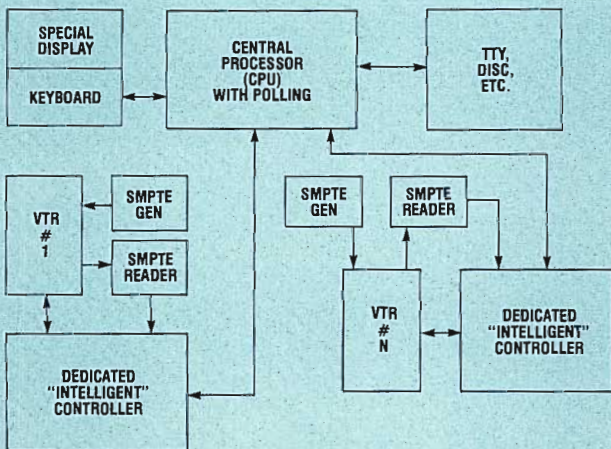

EPIC puts most functions in software to significantly reduce hardware. This improves cost effectiveness.

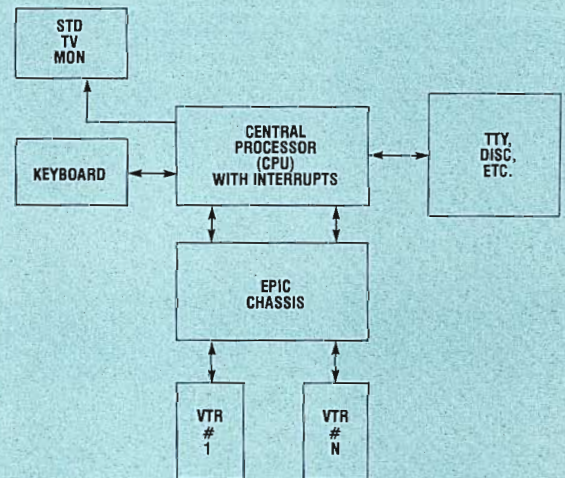

CONDENSED SPECIFICATIONS

Digital Chassis10.5" (26.7cm) high
19" (48.3cm) wide
20" (50.8cm) deep
Audio/Video Chassis10.5" (26.7cm) high
19" (48.3cm) wide
20" (50.8cm) deep
Computer5.25" (13.3cm) high
19" (48.3cm) wide
23" (58.4cm) deep
Keyboard (stand-alone or
panel mountable)4" (10.2cm) high
25.75" (67.3cm) wide
11.5" (29.2cm) deep

Power 117 VAC 50/60 Hz, 500 W
approx.
Video Input/Output (Time
Code Character Insertion) . . .1V p-p @ 75 ohms (opt.)
Video Output, Display Compatible with 525/60
T.V. Monitor
Audio Input (8) +4 dBm balanced or
unbalanced bridging (opt.)
Audio Output +4 dBm balanced, low
impedance (opt.)

Specifications subject to change without notice.

THE COMPANY BEHIND EPIC

EPIC is just one of the ways Harris Video Systems (formerly Consolidated Video Systems) uses modern digital and analog technology to make your video production look better. Besides being the acknowledged world leader in digital time base correction, Harris also manufactures other advanced products using video and digital techniques for professional television.

Worldwide customers include all major TV networks, many independent commercial and educational stations, most large duplicating facilities and a large number of educational, industrial and CATV organizations. All Harris products are

backed by a worldwide network of Authorized Sales and Service Distributors. For a demonstration of the CVS EPIC, or any other Harris product, contact your local Authorized Distributor.

CVS 516 Digital Video Time Base Corrector



HARRIS
COMMUNICATION AND
INFORMATION PROCESSING

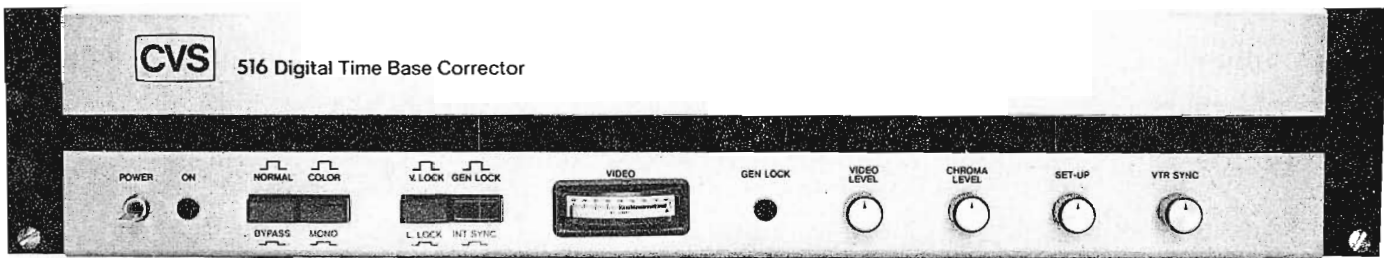

CVS-516: the ideal TBC for heterodyne VTRs

GENERAL

The CVS 516 is a broadcast quality, NTSC digital time base corrector made and priced to give users of non-segmented, heterodyne VTRs all the proven advantages of modern digital video processing. It works with 525/60 monochrome and NTSC color heterodyne video signals from helical VTRs to give both broadcast and non-broadcast video users expanded creative versatility for ENG, teleproduction, studio VTR backup and much more. Based on the field proven experience of over 3000 CVS digital TBCs, the CVS 516 comes with features that, before, were found only in units costing up to twice as much.

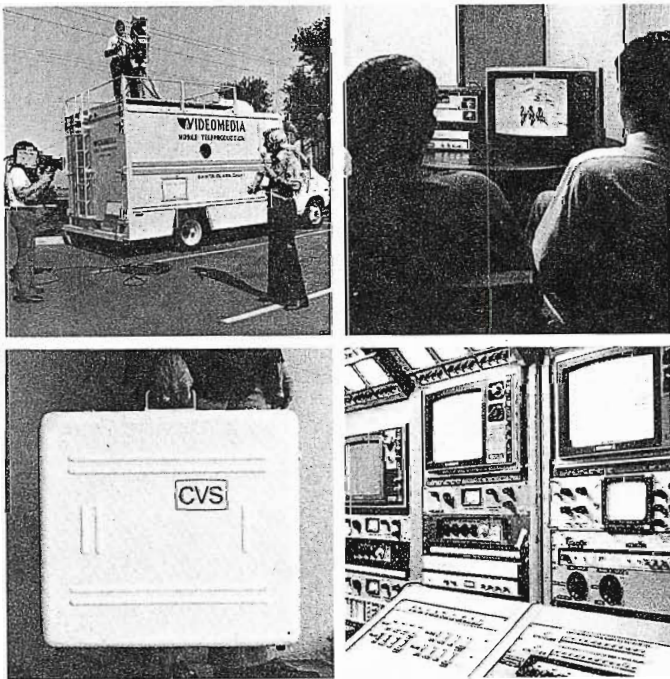

**The CVS 516 is more than a digital TBC—
it is a total video signal corrector.**

STANDARD FEATURES

- *“Gyrocomp” Memory Organization* — allows correction of large time base errors (such as gyroscopic errors), without breakup or hue shift, to make ENG tapes broadcast compatible.
- *Bypass Record Mode* — automatically routes genlock video to the VTR advanced sync output. This allows the VTR to record the live genlock signal without changing connectors.
- *Automatic Advanced VTR Sync* — automatically monitors off-tape and local sync to correctly position vertical blanking.
- *Adjustable H & V Blanking* — allows signal to be tailored to user needs. Provides added assurance of compliance with FCC rules.
- *Digital Color Averaging* — lowers chroma noise by 3 dB and reduces velocity errors by using digital variable delay lines to average chroma.
- *Compact Size* — advanced electronic circuitry makes the CVS 516 exceptionally compact, a key advantage for field production. Height is just 3½ inches (8.9 cm); weight is only 35 lbs (15.9 Kg).
- *Convenient, Front Panel Operation* — makes possible pushbutton selection of operating mode. Controls have a preset unity position to reduce the possibility of misalignment. Secondary controls and switches are behind a sliding cover — easy to get at but protected from accidental use.
- *One Cable Gen Lock Sync Generator with Outputs* — simplifies system interface.
- *Built-in Color Dropout Compensator* — cleans up “dirty” tapes.
- *Built-in Processing Amplifier* — provides clean, stable outputs.
- *Digital Chrominance-to-luminance Delay Adjustment* — compensates for a common heterodyne VTR defect.
- *Frame Locked Vertical Interval Edits* — smooths out rough edits.
- *VTR Versatility* — works with Capstan Servo and Non-Capstan Servo VTRs.

TESTED RELIABILITY

Each CVS 516 is individually tested before shipment using the toughest quality control in the industry. This includes computer checking of components and individual testing of each board. Units are then vibration tested, baked out for 100 hours and checked by inspectors who are independent of manufacturing. The result? A TBC that stands up to the most demanding operation, backed by a worldwide network of distributors and service centers.

APPLICATIONS

The CVS 516, with its advanced features and ease of operation, opens up entire new application areas for the use of video, from Field Production to closed circuit instruction. Listed below are just a few of the uses for this versatile TBC.

Electronic Journalism

The CVS 516 plays an integral part in field production applications, like Electronic Journalism. You can use a relatively inexpensive, portable VTR for remote coverage, documentaries, news, commercials and special features. Additionally, the built-in sync generator gives you field production capability, field editing and mixing of sources, and direct feedback to the studio via microwave.

Back-Up Operations At The Studio

Instead of using an expensive, non-segmented or quad VTR for back-up recording requirements, use the CVS 516 with an inexpensive, V lock heterodyne VTR. This allows you to make better and more efficient use of your expensive machines to do in-house production. Overall savings can be significant.

General Playback, Dubbing, Editing & Problem Tape Correction

The CVS 516 effectively handles many chores related to broadcast, cable and closed circuit TV operations, whether monochrome or heterodyne color. Among other things, it ensures high picture quality playback for special review, training or CCTV distribution systems. It also gives you the ability to do quality dubbing or editing. This latter application is where the full signal correction potential of the CVS 516 is realized. With the CVS 516, problem tapes no longer need to be a problem.

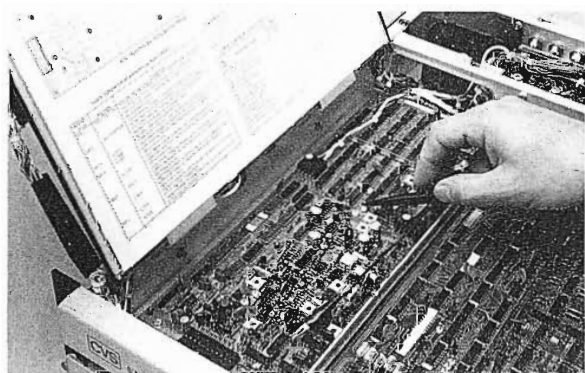

The unique "flat-pack" design of the CVS 516 makes all components easily accessible for fast, easy maintenance, testing and troubleshooting.

THE COMPANY

Harris Video Systems (formerly Consolidated Video Systems, Inc.) is located in Sunnyvale, California, U.S.A. Customers include all four major U.S. TV networks (ABC, CBS, NBC and PBS), major international networks, independent commercial and educational stations, most duplicating facilities and a large number of educational and industrial organizations worldwide.

HVS received the coveted Emmy Award for "outstanding achievement in engineering development" in May, 1974. HVS has been issued a basic U.S. patent covering the general technique of correcting certain video signals by means of a digital time base corrector.

OPTIONS

Image Enhancer/Noise Reducer

The CVS 516 Image Enhancer/Noise Reducer is a plug-in board that reduces noise in both the luminance and chroma channels. It also provides a 3 to 5 dB reduction in noise of the input signal, and horizontal enhancement. These picture quality improvements are accomplished without any degradation or compromise of other specifications, including differential phase and gain. Switches for adjustment of noise reduction and enhancement levels, and an Enhancer on/off switch, are located behind the sliding panel on the front of the TBC.

16 Line Window

This increased memory is available for special "worst case" applications. With a ± 8 line correction range, it further minimizes the effect of gyroscopic errors.

Fiberglass Carrying Case

Unique packaging and minimal weight (35 lbs.) make the CVS 516 easy to take anywhere. With this specially designed fiberglass carrying case, the unit is fully protected—a special advantage when doing field productions.

BASIC OPERATION

Operationally, the Model CVS 516 accepts an input video signal, digitizes it and stores it. The signal is then clocked out at a corrected rate and referenced to either an external or internal sync generator. The result is a time base corrected video signal.

Capstan Servo VTR

When the input signal to the CVS 516 is a heterodyne type recording from a capstan servo VTR, the output signal is a broadcast stable, fully interlaced and color framed video signal.

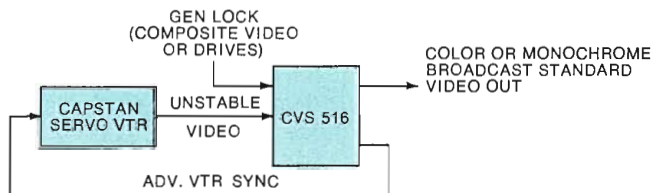

Note: For DOC, the CVS 516 requires R.F. carrier from VTR.

Non-Capstan Servo VTR

When the input signal to the CVS 516 is a heterodyne type recording from a non-capstan-servo VTR, the output signal is a stabilized color signal. Dub to quad capability is also available at the flip of a switch.

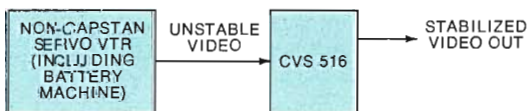

Note: For DOC, the CVS 516 requires R.F. carrier from VTR.

525/60 Monochrome Signal

When the input signal to the CVS 516 is a wideband 525/60 monochrome signal, the output is a stabilized signal with bandwidth of 5 MHz.

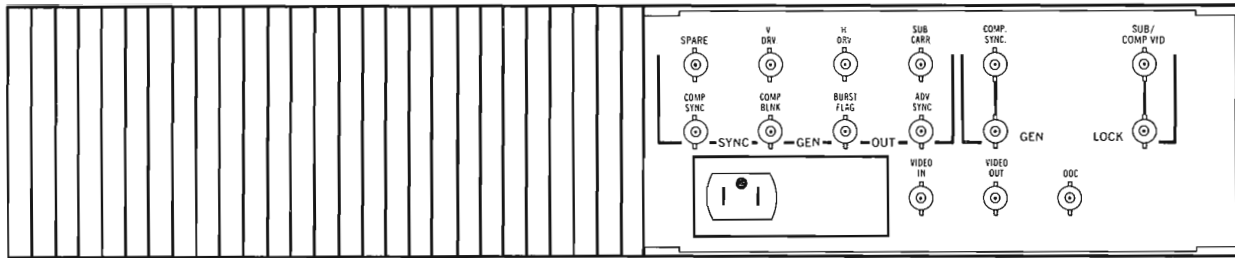

CVS 516 NTSC SPECIFICATIONS

GENERAL

Television Signal	
Standard	Accepts monochrome or heterodyne NTSC standard 525 line 60 Hz signals.
Recorder Interface	Requires signal from capstan servo or line lock VTR. Not designed to work with quadruplex or segmented VTRs.
Window of Correction	2 Horizontal lines.
Resultant Time Base Correction*	
Video Luminance:	± 20 nsec.
Video Chrominance:	± 2 nsec relative to burst.
K-Factor (2T Pulse)	4% color, 2% monochrome.
Differential Phase	Less than 1.5% at 0.280 V sub-carrier.
Differential Gain	Less than 1.5% at 0.280 V sub-carrier.
Signal-to-Noise Ratio	55 dB (peak-to-peak signal to rms noise) as measured on Rohde and Schwarz noise meter.
Bandwidth, Color	3 dB down at 2.5 MHz.
Bandwidth, Monochrome	
	Less than 3 dB down at 5.5 MHz.
Color/Mono Compatibility	
	If burst is not present, the CVS 516 automatically selects mono mode.
Lock Time	Color lock within one millisecond after capstan servo VTR has obtained V-lock. Approximately 2 seconds after line lock VTR has reached operating speed.
Processing Amplifier	Reinserts sync, blanking and color burst (color burst deleted on monochrome signals).
Frame Lock	Will automatically frame lock segments edited randomly at vertical interval.
Gen Lock Range	Adjustable ± 2 μ sec.

INPUTS

Input Reference (Gen Lock)	1 V p-p composite video with burst or composite sync and sub-carrier.
Input Video	Composite video from VTR, 1 V p-p @ 75 Ohms.
Input D.O.C. Reference	R.F. from VTR for drop out compensator, 0.5 V p-p (nominal) @ 75 Ohms.

OUTPUTS

Video	Composite video output, 1 V p-p @ 75 ohms.
Advanced VTR Sync	For V-lock VTR: Advanced composite sync ± 10 lines, 1 V @ 75 ohms; automatic or manual.
Sync	Horizontal, vertical, composite sync, composite blanking, burst flag, 4 V @ 75 ohms. Subcarrier 2 V @ 75 ohms.

PHYSICAL

Size	48.3 cm (19") wide x 8.9 cm (3.5") high x 48.3 cm (19") deep. Shipped as stand alone unit with rack ears.
Power	Approx. 175 W: 100,120,220,240V, 48-66 Hz
Weight	35 lbs. (15.9 kg)
Ambient Temperature	50°F - 104°F (10° - 40°C)
Ambient Humidity	10% - 80%

OPTIONS

- Image Enhancer/Noise Reducer
- 16 Line Memory
- Fiberglass Shipping Case

*Note: Recorder and tape signal to noise capabilities affect time base stability. A decrease in signal-to-noise ratio below approximately 40 dB will cause an increase in residual time base error.

Specifications subject to change without notice.

CVS 517 PAL/SECAM Digital Video Time Base Corrector

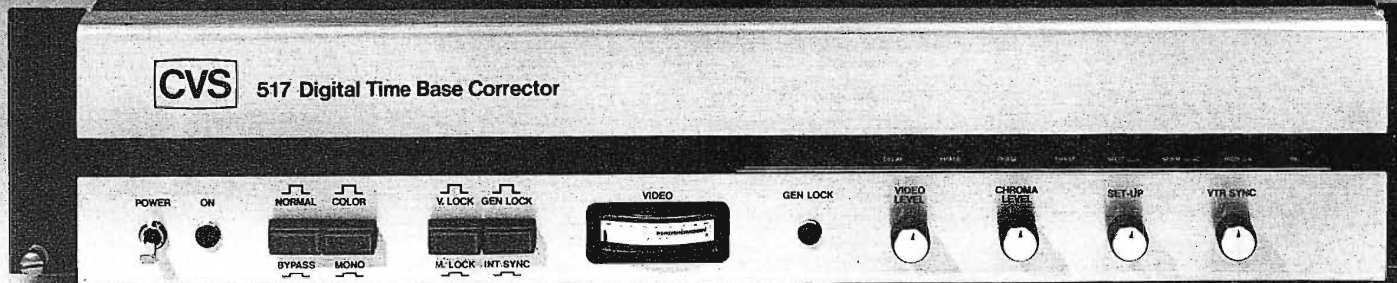

HARRIS

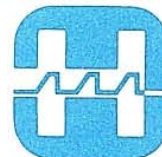

**COMMUNICATION AND
INFORMATION PROCESSING**



CVS 517: the ideal TBC for PAL/SECAM

GENERAL

The CVS 517 is a broadcast quality, PAL (and optional SECAM) digital time base corrector made and priced to give users of non-segmented, heterodyne VTRs all the proven advantages of modern digital video processing. It works with 625/50 monochrome and color heterodyne video signals from helical VTRs to give both broadcast and non-broadcast video users expanded creative versatility for ENG, teleproduction, studio VTR backup and much more. Based on the field proven experience of over 3000 HVS digital TBCs, the CVS 517 comes with features that, before, were found only in units costing up to twice as much.

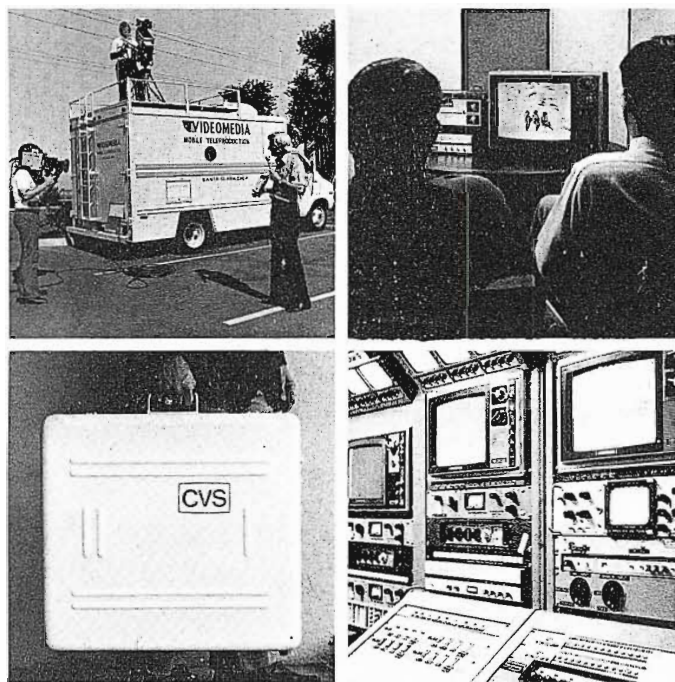

TESTED RELIABILITY

Each CVS 517 is individually tested before shipment using the toughest quality control in the industry. This includes computer checking of components and individual testing of each board. Units are then vibration tested, baked out for 100 hours and checked by inspectors who are independent of manufacturing. The result? A TBC that stands up to the most demanding operation, backed by a worldwide network of distributors and service centers.

STANDARD FEATURES

- *"Gyrocomp" Memory Organization*—allows correction of large time base errors (such as gyroscopic errors), without breakup, to make ENG tapes broadcast compatible. Standard memory has a 2 horizontal lines correction window.
- *Improved Bandwidth*—improved input circuitry allows tapes from new "high band" 3/4" cassette recorders to be processed without picture degradation.
- *Digital Color Averaging*—lowers chroma noise by 3 dB and reduces velocity errors by using digital variable delay lines to average chroma.
- *Compact Size*—advanced electronic circuitry makes the CVS 517 exceptionally compact, a key advantage for field production. Height is just 8.9 cm (3 1/2"); weight is only 15.9 Kg (35 lbs).
- *Convenient, Front Panel Operation*—controls have a preset unity position to reduce the possibility of misalignment. Secondary controls and switches are behind a sliding cover—easy to get at but protected from accidental use.
- *One Cable Gen Lock Sync Generator with Outputs*—simplifies system interface and maintains 25 Hz PAL offset in all modes.
- *Built-in Color Dropout Compensator*—cleans up "dirty" tapes.
- *Built-in Processing Amplifier*—provides clean, stable outputs.
- *Digital Chrominance-to-luminance Delay Adjustment*—compensates for a common heterodyne VTR defect.
- *Frame Locked Vertical Interval Edits*—smooths out rough edits.
- *VTR Versatility*—works with Capstan Servo and Non-Capstan Servo VTRs.

APPLICATIONS

The CVS 517, with its advanced features and ease of operation, opens up entire new application areas for the use of video, from Field Production to Closed Circuit Television distribution. Listed below are just a few of the uses for this versatile TBC.

Electronic Journalism

The CVS 517 plays an integral part in field production applications, like Electronic Journalism. You can use a relatively inexpensive, portable VTR for remote coverage, documentaries, news, commercials and special features. Additionally, the built-in sync generator gives you field production capability, field editing and mixing of sources, and direct feedback to the studio via microwave.

APPLICATIONS (cont.)

Back-Up Operations At The Studio

Instead of using an expensive, direct color VTR for back-up recording requirements, use the CVS 517 with an inexpensive, V lock heterodyne VTR. This allows you to make better and more efficient use of your expensive machines to do in-house production. Overall savings can be significant.

General Playback, Dubbing, Editing & Problem Tape Correction

The CVS 517 effectively handles many chores related to broadcast, cable and closed circuit TV operations, whether monochrome or heterodyne color. Among other things, it ensures high picture quality playback for special review, training or CCTV distribution systems. It also gives you the ability to do quality dubbing or editing. This latter application is where the full signal correction potential of the CVS 517 is realized. With the CVS 517, problem tapes no longer need to be a problem.

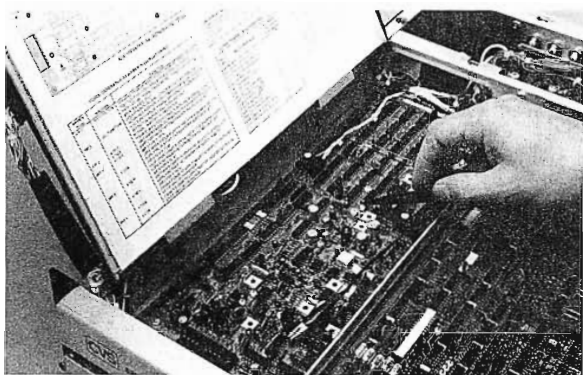

The unique "flat-pack" design of the CVS-517 makes all components easily accessible for fast, easy maintenance, testing and troubleshooting.

OPTIONS

SECAM

The SECAM option allows the CVS 517 to accept heterodyne or direct color inputs from non-segmented SECAM VTRs, and provides PAL to SECAM and SECAM to PAL transcoding.

When the input signal is from a vertical lock VTR, the output signal will be broadcast stable. When the input signal is from a mains lock VTR, the output will be a stabilized signal. RGB outputs are available on the back panel for routing to RGB switching systems or to an external, customer supplied SECAM encoder.

PAL/SECAM Image Enhancer/Noise Reducer

The Image Enhancer/Noise Reducer provides a total of 5 dB of noise reduction in both the luminance and chroma channels. Also included: a 3 to 5 dB reduction in ringing of the input signal, and horizontal enhancement. The level of noise reduction and enhancement is adjustable. An Enhancer on/off switch is located behind the sliding panel on the front of the TBC.

The picture quality improvements are accomplished without any degradation of specifications.

Increased Memory

A 16 line memory is available for special "worst case" applications. This ± 8 line correction range further minimizes the effect of gyroscopic errors.

Direct Color

This option is specifically designed to function with slide store devices. It allows processing of any direct color signal. However, bandwidth is limited to that of the CVS 517.

OPTIONS (cont.)

Dub-to-quad

This option allows PAL mains lock or remote VTRs to be dubbed to direct color video recorders such as quadruplex, type "C" and BCN.

Fiberglass Carrying Case

Unique packaging and minimal weight (11.4 Kg) make the CVS 517 easy to take anywhere. With this specially designed fiberglass carrying case, the unit is fully protected—a special advantage when doing field productions.

BASIC OPERATION

Operationally, the Model CVS 517 accepts an input video signal, digitizes it and stores it. The signal is then clocked out at a corrected rate and referenced to either an external or internal sync generator. The result is a time base corrected video signal.

Capstan Servo VTR

When the input signal to CVS 517 is a heterodyne type recording from a capstan servo VTR, the output signal is a broadcast stable, fully interlaced and color framed video signal.†

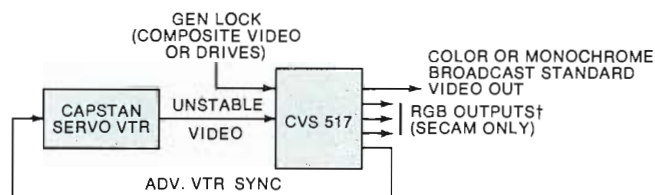

Note: For DOC, the CVS 517 requires R.F. carrier from VTR.

Non-Capstan Servo VTR

When the input signal to the CVS 517 is a heterodyne type recording from a non-capstan-servo VTR, the output signal is a stabilized color signal.† Dub-to-quad capability is also available at the flip of a switch (optional).

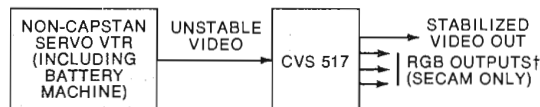

Note: For DOC, the CVS 517 requires R.F. carrier from VTR.

625/50 Monochrome Signal

When the input signal to the CVS 517 is a wideband 625/50 monochrome signal, the output is a stabilized signal with bandwidth of 5 MHz.

†In SECAM, CVS 517 has time base corrected PAL and synchronized RGB outputs. For composite time base corrected SECAM video out signal, feed RGB outputs through a SECAM encoder.

THE COMPANY

Harris Video Systems, Inc. is located in Sunnyvale, California, U.S.A. Customers include all four major U.S. TV networks (ABC, CBS, NBC and PBS), major international networks, independent commercial and educational stations, most duplicating facilities and a large number of educational and industrial organizations worldwide.

HVS received the coveted Emmy Award for "outstanding achievement in engineering development" in May, 1974. HVS has been issued a basic U.S. patent covering the general technique of correcting certain video signals by means of a digital time base corrector.

Other HVS products include the CVS 630 Series Digital Framestore Synchronizer and the EPIC™ computer-assisted videotape editor.

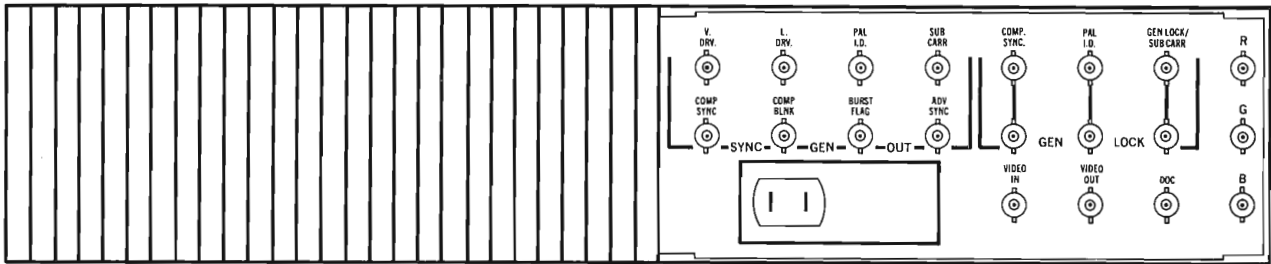

CVS-517 PAL/SECAM SPECIFICATIONS

GENERAL

- Television Signal Standard Accepts monochrome, heterodyne PAL or SECAM standard 625 line 50 Hz signals.
- Recorder Interface Requires signal from capstan servo or mains lock VTR. Not designed to work with quadruplex or segmented VTRs.
- Window of Correction 2 Horizontal lines.
- Resultant Time Base Correction* Video Luminance: ± 20 nsec. Video Chrominance: ± 2 nsec relative to burst.
- K-Factor (2T Pulse) 4% color, 2% monochrome.
- Differential Phase Less than 1.5% at 0.280 V subcarrier.
- Differential Gain Less than 1.5% at 0.280 V subcarrier.
- Signal-to-Noise Ratio 55 dB (peak-to-peak signal to rms noise) as measured on Rohde and Schwarz noise meter.
- Bandwidth, Color ± 1 dB, 50 Hz to 3.3 MHz. -3 dB at 3.5 MHz.
- Bandwidth, Monochrome Less than 3 dB down at 5.5 MHz.
- Color/Mono Compatibility If burst is not present, the CVS-517 automatically selects mono mode.
- Lock Time Color lock within one millisecond after capstan servo VTR has obtained V-lock. Approximately 2 seconds after line lock VTR has reached operating speed.
- Processing Amplifier Reinserts sync, blanking and color burst (color burst deleted on monochrome signals).
- Frame Lock Will automatically frame lock segments edited randomly at vertical interval.
- Gen Lock Range Adjustable $\pm 2 \mu\text{sec}$.

INPUTS

- Input Reference (Gen Lock) 1 V p-p composite video with burst or composite sync, sub-carrier and PAL I.D. Pulse.
- Input Video Composite video from VTR, 1 V p-p @ 75 Ohms.
- Input D.O.C. Reference R.F. from VTR for drop out compensator, 0.5 V p-p (nominal) @ 75 Ohms.

OUTPUTS

- Video Composite video output, 1 V p-p @ 75 Ohms. RGB (SECAM option only)—separate Red, Green and Blue outputs, composite or non-composite.†
- Advanced VTR Sync For V-lock VTR: Advanced composite sync ± 9 lines, 1 V @ 75 Ohms.
- Sync H., V., composite sync, composite blanking, burst flag, PAL I.D. Pulse, 4 V @ 75 Ohms. Subcarrier 2 V @ 75 Ohms.

PHYSICAL

- Size 48.3 cm (19") wide x 8.9 cm (3.5") high x 48.3 cm (19") deep. Shipped as stand alone unit with rack ears.
- Power Approx. 175 W: 100,120,220,240V, 48-66 Hz
- Weight 15.9 Kg. (35 lbs)
- Ambient Temperature 10° - 40° C
- Ambient Humidity 10% - 80%

OPTIONS

- SECAM
- PAL/SECAM Image Enhancer/Noise Reducer
- 16 Horizontal Line Memory
- Direct Color
- Dub-To-Quad
- Fiberglass Shipping Case

*Note: Recorder and tape signal to noise capabilities affect time base stability. A decrease in signal-to-noise ratio below approximately 40 dB will cause an increase in residual time base error.

†In SECAM, CVS-517 has time base corrected PAL and synchronized RGB outputs. For composite time base corrected SECAM video out signal, feed RGB outputs through a SECAM encoder.

**CVS 520
Digital Video
Time Base
Corrector**

CVS

520 Digital Time Base Corrector

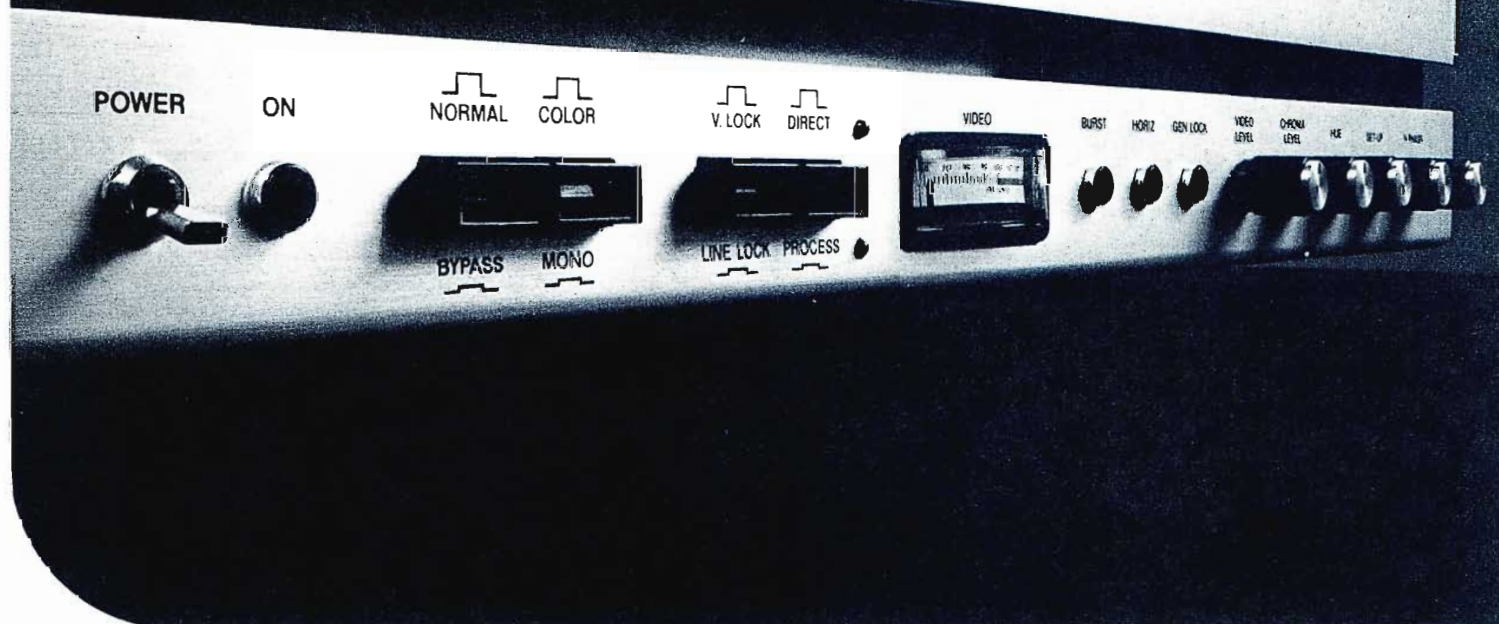

HARRIS
COMMUNICATION AND
INFORMATION PROCESSING

More than a superb TBC-- a complete signal processing system.

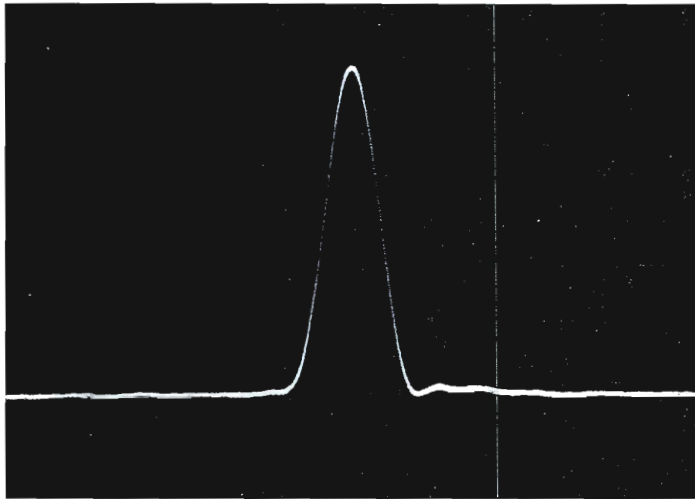

2T pulse response

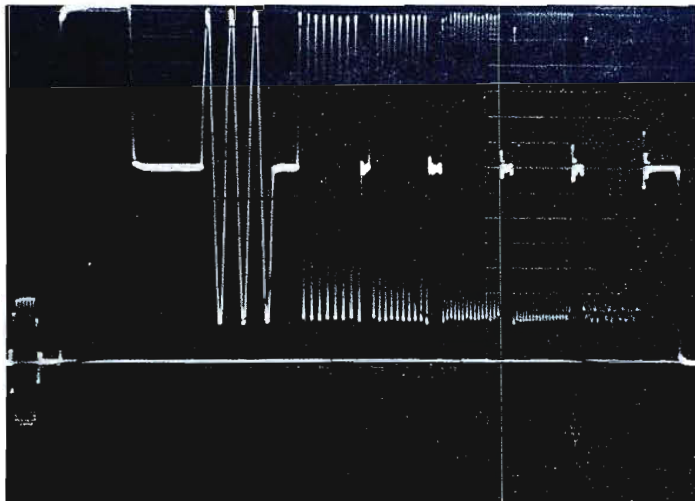

multiburst response

The 520, in addition to the industry's most advanced time base correction, gives you a complete, self-contained, digital signal processing system. Extra-cost options and accessories have been all but eliminated—those capabilities have been built into the basic package. For example:

Line-by-line look-ahead *velocity compensation* is standard; the 520 gives you a highly effective digital system that greatly reduces chroma phase errors within each video line. It functions with both heterodyne and direct color signals.

A digital *dropout compensator*, also standard, continually monitors RF carrier information from the VTR. In the event of a tape dropout, video information from the preceding line—in the correct color phase—is inserted in place of the missing information. *RF automatic gain control* (AGC) insures that high- and low-energy tapes can be intermixed without a need for any readjustment.

Switching on the *Color Interlace* system permits a feed from a non-capstan-servo recorder to be dubbed to a production recorder—a quadruplex VTR, for example. The 520 does this without resorting to any kind of auxiliary equipment—external amplifiers, for example.

What does nine-bit, four-times-subcarrier, PCM digital technique mean for you?

In any digital television system, the rate at which the video signal is sampled and the number of digital bits available to describe the video signal are critical. They establish theoretical limits for such key specifications as K factor, signal-to-noise ratio, differential gain and phase, and bandwidth. By increasing the sampling rate from three-times-subcarrier to four-times-subcarrier, the CVS 520 has made significant improvements in all these key areas. And by increasing the number of available digital bits from eight to nine, it has improved linearity and signal-to-noise ratio—while providing additional headroom for those occasions when “hot” video—at excessively high levels—is fed to the TBC.

How do these improvements affect what you see on the monitor?

Picture quality is better. The differences are evident even on first-generation program material, and they become more pronounced and obvious on multi-generation tapes. To look at the improvement another way, here are actual, unretouched photographs of two measurements of the 520's performance:

Tames even the wildest errors.

The 520 handles even the most severe errors with its wide correction range—three horizontal lines. Of course, a window of this size guarantees that even random edits, if made on a vertical interval editor, will be clean and smooth, without picture breakup or disturbance. The output of the 520 will always be a fully framed signal.

What happens to the output signal when errors exceed the width of the correction window—for example, when sudden movement of a portable VTR sets up gyroscopic errors? The 520's exclusive Gyrocomp circuitry is activated as soon as the window is exceeded. The picture then moves gently upward in one line steps—creating the subjective impression that the camera has been tilted downward slightly. The image does not break up; both horizontal movement and hue shift are held to the minimum.

Even noisy tapes are no problem for the 520. Normally, noise on the input signal tends to reduce the stability of the output signal; but Harris has designed an extra degree of noise immunity into all 520 circuitry. The result is superior time base stability—even with noisy tapes.

Better looking pictures from your ENG tapes.

Digital time base correction is what made ENG a reality. Now it has come into widespread use, and has been joined by more sophisticated Electronic Field Production techniques. The CVS 520 offers some special benefits for both of these applications. The 520 does more than just correct the signals from *all* ENG recorders—it can actually *improve picture quality*. For example: most VTRs commonly used for ENG suffer from chrominance-to-luminance delay problems. The 520 lets you program these problems out of your playbacks by way of internal jumpers. The 520 also provides regenerated or "jittered" 3.58 MHz subcarrier; you can feed this signal to the playback VTR, standardizing the output and permitting the 520 to be used in the Direct mode. The result will be better resolution and improved K factor.

The 520's size and power consumption are important benefits for ENG work. It weighs just 35 pounds (15.9 kg) and measures just 19 x 3.5 x 19 inches (48.3 x 8.9 x 48.3 cm).

Operation: Simple and straightforward.

There's nothing complicated about operating the 520.

Select the operating mode you want by pushbutton; if you want, the 520 will even select automatically between Direct and Heterodyne color—making the mode change without changing the hue! Status lights on the front panel confirm that the system is functioning properly.

The 520 gives you five operator controls: Video Level, Chroma Level, Hue, Set-Up, and V Phase. Three of these—Video Level, Chroma Level, and Set-Up—have a preset unity position to reduce the possibility of misadjustment. The Chroma Level control is operational in all modes; improper chroma levels from playback tapes can be corrected to give correct reproduction.

Secondary controls and switches are located behind a sliding cover—easy to get at but protected from inadvertent contact.

Maintenance made easy.

If testing and troubleshooting become necessary, the 520's concise, straightforward maintenance manual will make them easier. All components are readily accessible, and a number of thoughtful touches make it easy to work on the 520:

- Test points and components are easy to identify. Black test points are Ground; white test points are Signal.
- When an oscilloscope ground clip is put on a black test point, it is always in close proximity to a Signal test point.
- An internal test generator makes it easy to check the analog-to-digital and digital-to-analog circuitry: simply lift the 520's cover, move a jumper, and the 520 delivers a ramp signal for scope display that will identify the location of any errors in the system.
- Moving a set of jumpers makes the Most Significant Bit the Least Significant Bit—and vice versa. This provision lets the operator quickly locate problems relating to the LSB, which would otherwise be difficult to identify in the nine-bit system.

Interconnects easily with any television system.

The 520's advanced design makes for an easy interface with any system.

The genlock sync generator (with a complete set of outputs) has timing adjustable from four-microsecond advance to two-microsecond delay. It can be timed into virtually any system. An additional advance of one horizontal line is available to compensate for such external equipment as the CVS-310 Image Enhancer/Noise Reducer.

Pulse widths of the processing amplifier are set to nominal FCC values; they can be adjusted precisely to match those of your facility by means of internal jumpers.

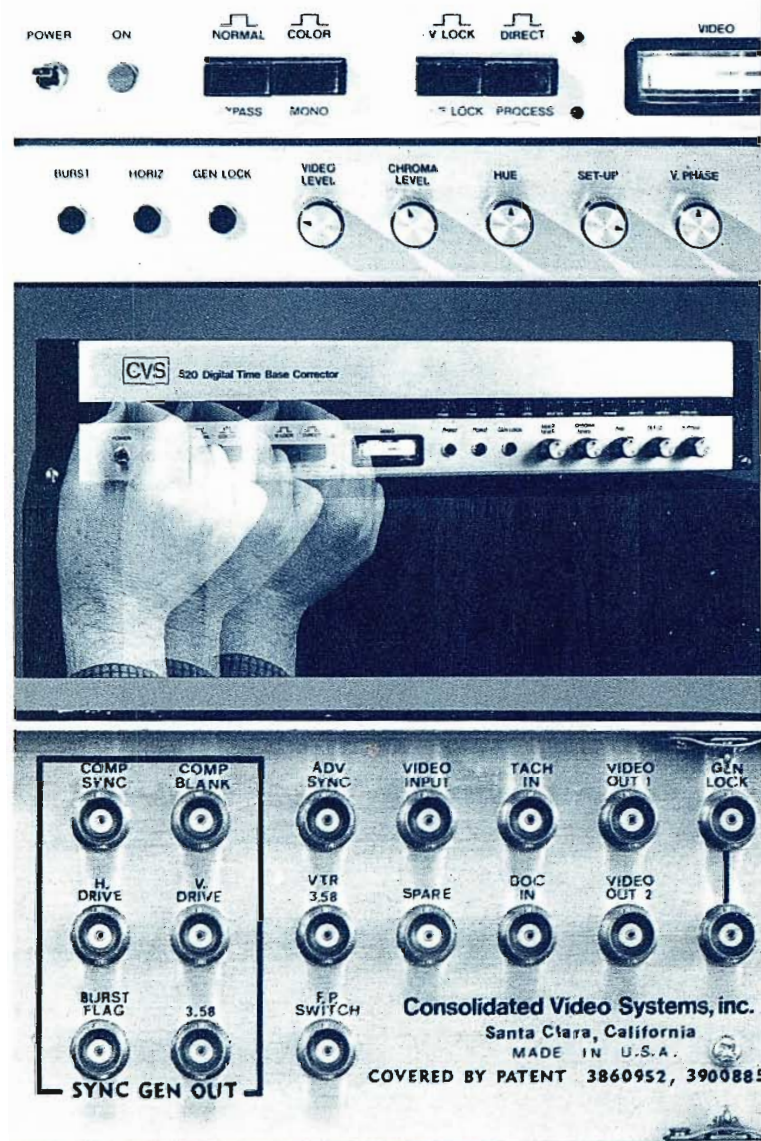

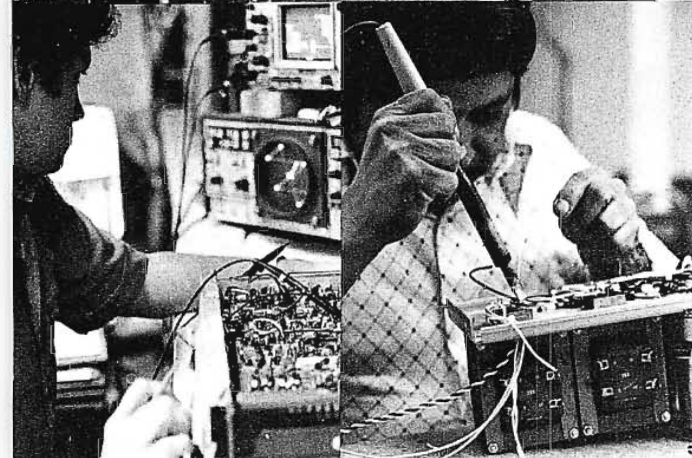
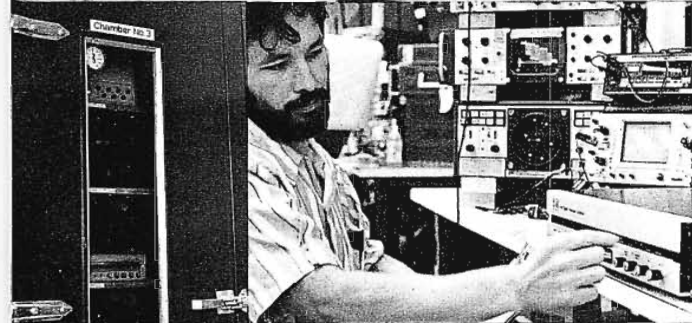
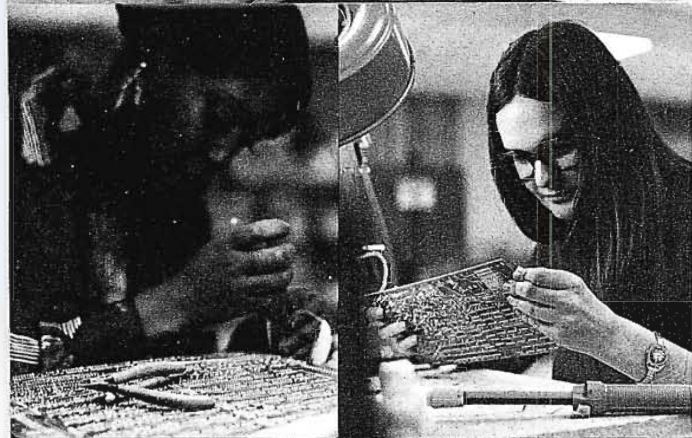
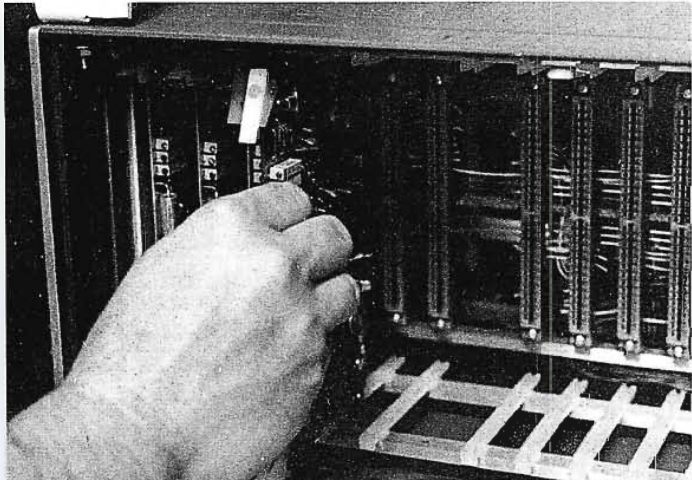

Any of the last eight lines of the vertical interval may be unblanked to pass VITS and VIRS information. H Blanking is also variable.

Adjustable advanced sync or vertical drive, for use with capstan servo recorders, makes it simple to connect the 520 to your VTR. The 520 readily uses front porch switch and tach pulse signals for segmented recorders (such as quadruplex). The dropout compensator uses RF feed for dropout sensing.

The 520 is reliable.

Every manufacturer, of course, claims to put out a reliable product. But Harris backs its claim with the most stringent quality control in the industry.

Several visual checks during assembly start the inspection process. Key components are pre-checked by computer before being installed.

Each circuit board is then "cooked"—connected to power for a period of time—and individually tested. Only then is it installed in the TBC.

The assembled TBC is subjected to a vibration test and placed, under power, in an environmental chamber where the temperature is cycled from +50°C to +10°C over a 100-hour period. Finally, it is checked by an inspector who is independent of the rest of the manufacturing/test organization. The inspector is under orders to behave like a customer—deciding whether the product is acceptable for purchase. If absolutely anything is substandard—including scratches on the front panel—it is rejected.

The result? A product that will stand up under even the most arduous day-to-day use—and that is backed by a worldwide network of distributors and service centers.

CVS 520. A major step forward in digital technology.

The CVS 520 is a versatile, high-performance device designed to accept signals from video recorders of every kind and to reduce or eliminate inherent time base errors. It's equally at home with segmented and non-segmented VTRs, monochrome VTRs, heterodyne or direct color VTRs, with or without capstan servos. It is compact, extremely reliable, and simple to operate. It is the most advanced digital TBC in the world.



CVS Model 520 Specifications

General

Television Signal Standard	Accepts NTSC or NTSC-type 525-line/60 Hz signal.
Recorder Interface	Requires a signal from any segmented or non-segmented VTR with or without capstan servo, heterodyne or direct color or monochrome.
Lock Time	One millisecond after vertical lock (capstan servo VTR); appr. 2 seconds after line lock VTR reaches operating speed.
Window of Correction	±1.5H
Resultant Time Base Correction * :	
Monochrome	±20ns
Direct Color	±2ns
Heterodyne Color	±3ns relative to burst
K Factor, 2T Pulse	1% Mono & Direct Color 3% Heterodyne Color 4% Line Lock
Differential Phase	2° with 40 IRE subcarrier
Differential Gain	2% with 40 IRE subcarrier
Signal-to-Noise Ratio (p-p signal to RMS noise)	Greater than 60dB as measured on Rohde & Schwarz noise meter with 10kHz highpass and 3.58MHz subcarrier traps engaged.
Bandwidth, Direct Color & Mono	±0.5dB from D.C. to 4.2MHz; -1dB @ 5.0MHz
Bandwidth, V-Lock, Heterodyne Color	-3dB @ 2.5MHz
Genlock Range	Advance of 4 μsec, delay of 2 μsec

Inputs

Input Video	0.56 to 1.78V p-p (1V nominal @ 75 Ohm) terminating input.
Input Reference (Genlock)	Composite video with burst 0.3 to 2.0 p-p @ 75 Ohm. High impedance looping input.
Input D.O.C. Reference	R.F. carrier, 3MHz to 10MHz nominal, 0.5V to 2.0V @ 75 Ohm.
Tach Pulse Input	TTL input 0 to +4.0V terminated in 75 Ohm.

Outputs

Video Output	One composite output available in all modes except bypass. One composite or non-composite output available in all modes. 1V p-p nominal into 75 Ohm.
Sync	H Drive, V Drive, Sync, Blanking and Burst Flag, 4.0V p-p into 75 Ohm. Subcarrier 2.0V p-p into 75 Ohm.
Advanced VTR Sync	Vertical drive or composite sync (selectable) 4.0V p-p into 75 Ohm.
VTR 3.58	Regenerated 3.58MHz subcarrier containing time base errors of input video signal, 1.0V p-p (minimum) into 75 Ohms.
F.P. Switch	Head switching pulse for segmented VTR 3V p-p.

Physical

Ambient Temperature	10°C to 40°C (50°F to 104°F)
Ambient Humidity	10% to 80%
Power	150W @ 100, 120, 220 or 240V. 50 or 60 Hz.
Weight	15.9 Kg (35 lbs.)
Dimensions: W-H-D	48.3 x 8.9 x 48.3 cm 19 x 3.5 x 19 inches

*Recorder and tape signal-to-noise capabilities affect time base stability. A decrease in signal-to-noise ratio below approximately 40dB will cause an increase in residual time base error.
Specifications subject to change without notice.

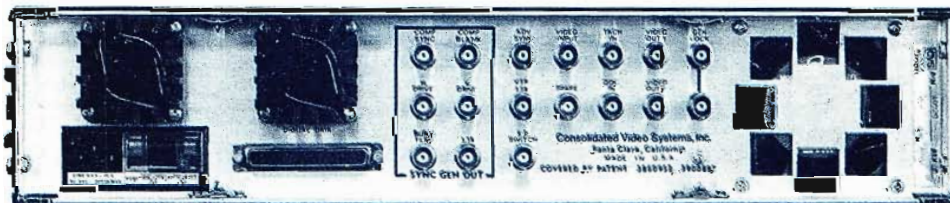

CVS 630 Series Digital Frame Synchronizer



HARRIS



**COMMUNICATION AND
INFORMATION PROCESSING**

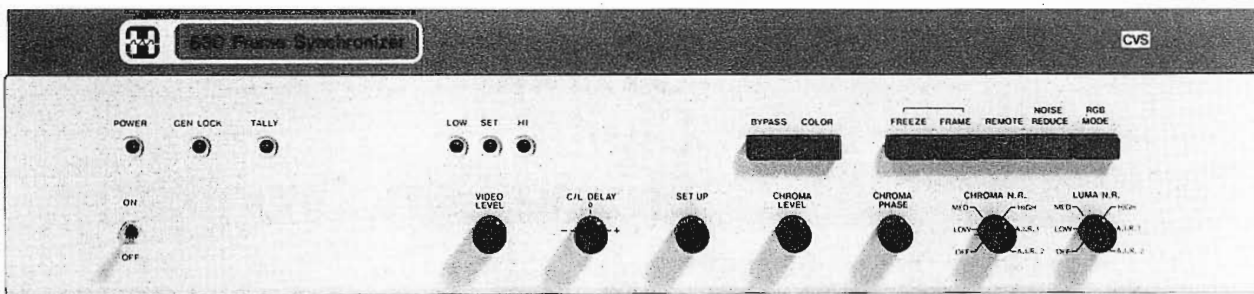

CVS 630 Series: A family of superb frame synchronizers, and much more

With the introduction of the CVS 630 Series, video users can now have a combination of signal processing capabilities that have never before been available in a single instrument.

Although this brochure specifically describes the CVS 630 NTSC unit, the features and options listed are also included in PAL, SECAM and PAL-M models.

First of all, the CVS 630 is a superb synchronizer that locks any non-synchronous video source—satellite, microwave, portable camera or studio feed—to any television system. And it does this as well as, or better than, any competitive unit.

Superb synchronization, however, is just the start of CVS 630 capabilities. Its combination of features, versatility and economy puts it in a class by itself.

A New Digital Architecture

The CVS 630 departs from other digital systems by using a unique 8 bit, 14 MHz coding system that processes the video signal in component form instead of in composite form.

In operation, when a signal is received, the CVS 630 captures it, digitizes it in component form and stores it in a modern, 16 K RAM-based frame memory. Then, using a PROM-actuated memory controller, it reads out the signal in precise synchronization, re-codes it and sends it out in correct vertical, horizontal and color synchronization.

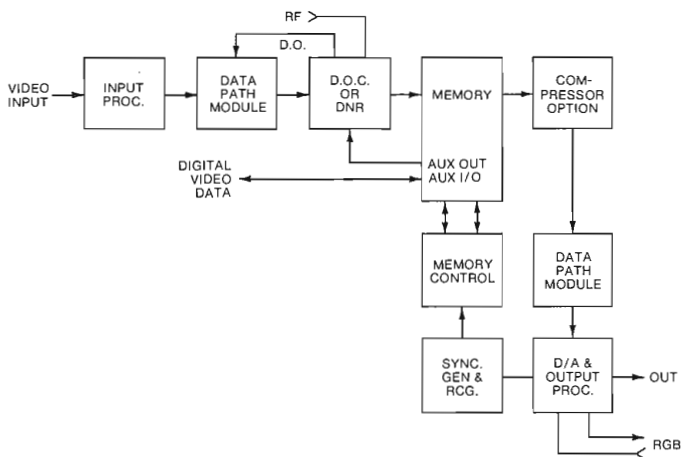

Figure 1: Basic Block Diagram CVS 630 Frame Synchronizer

This component coding technique, already thoroughly proven in over 1000 CVS digital time base correctors, results in simplification of digital circuitry and, consequently, more flexibility. It also allows a "universal" memory architecture that makes the CVS 630 much more than just a superb synchronizer.

Also, because component coding is inherently immune to color phasing problems, "cycle jump" and horizontal picture shift are both theoretically and actually impossible. The 4 field (NTSC), 8 field (PAL) or 12 field (SECAM) color sequence is always maintained without horizontal picture shift.

Adaptable to all TV Standards

Because the CVS 630 does have a universal memory, its basic design is applicable to all world TV standards—NTSC, PAL, SECAM and PAL-M. Furthermore, all models in the CVS 630 Series have a high degree of commonality in parts and plug-in circuitry, to provide additional cost and reliability benefits for all users.

Time Base Correction

Outstanding time base correction is a built-in feature of the CVS 630. Because Harris originated the digital TBC, and is still the world leader, HVS engineers have been able to incorporate the knowledge gained from more than 3000 digital TBCs now in use worldwide. As a result, you get a time base corrector that operates smoothly and efficiently under noisy and less than ideal conditions, without loss of output quality. In fact, its performance is actually superior to stand-alone TBC s.

Special Effects

Another advantage of the CVS 630 is an outstanding effects capability. Picture freeze (field or frame) is standard, and several other effects, like video compression and positioning (see facing page), are available as options.

In addition, because of the flexible memory architecture used in the CVS 630, many planned-for "optical" effects can be readily supported.

Digital Noise Reduction

To even further expand the capability of the CVS 630, a digital noise reducer is available as a simple and economical option. Designed to complement the built-in TBC, this option is described more fully on the facing page.

Future Expansion

Besides offering all of the performance features described above, the CVS 630 has been specifically designed to encourage and permit digital interface. As a result, the potential additional applications for the CVS 630 are virtually limitless: digital graphics . . . real time picture analysis . . . multiple picture effects . . . digital still store . . . and more.

FEATURES

- **Stable or Unstable Inputs:** Operator attention is not needed because stable and unstable inputs can be intermixed *without* switching from "normal" to "TBC" modes.
- **"Dual Mode" Hot Switching:** Exclusive circuitry permits switching of input sources without disruption of output video. It also provides smooth handling of odd field edits (see below).
- **Smooth Handling of Odd Field Edits:** At the flip of a switch, the CVS 630 is converted to a framestore/field action synchronizer. This allows odd field edits to "slide through" without freezing, eliminating the jerky, "1920's movie" effect often encountered in other synchronizers.
- **Compensation For Lost Video:** If input video is lost, the CVS 630 either automatically freezes on the last good picture or cuts to black, depending on the setting of a board-level switch.
- **Picture Freeze:** Increases production versatility by providing front panel-selectable field or frame freeze.
- **High Noise Immunity:** Built-in circuitry extracts maximum information from even the poorest quality tapes; signals with severe hum and noise pass through without difficulty.
- **Exceptional Write Clock Range:** Ensures that normal tapes, tapes with "gyro" errors and even off-speed tapes will play back with proper correction.
- **RGB Mode:** A unique RGB mode, is selectable from the front panel of the CVS 630. This mode allows use of the CVS 630 with a number of video processing devices already available, such as encoders, enhancers, color correctors and the like.
- **Digital Interface:** In addition to the normal video inputs and outputs, the CVS 630 incorporates a direct memory access (DMA) digital I/O. This opens the door to a wide range of digital video processing capabilities.
- **Convenient Front Panel Operation:** Operating modes are pushbutton selectable, and all operating controls are on the front panel. All controls are preset/variable so a "standard" setting is always achievable. Secondary controls are behind the sliding front panel. Included are chroma/luma delay adjustment and split screen for use in comparing input and output signals.
- **Easy Maintenance:** The use of plug-in cards for all circuitry makes maintenance and/or service of the CVS 630 simple and fast. Usually it will only involve swapping a board. A built-in test generator makes troubleshooting easy, and all technical adjustments and test points are located behind the front filter grill: readily accessible but out of the way.
- **Tested Reliability:** Outstanding reliability is achieved for the CVS 630 through a combination of careful design and thorough testing, using some of the most stringent quality assurance standards in the industry. All components are de-rated to ensure long life operation, even under extreme conditions. Additionally, air flow has been maximized to reduce the possibility of hot spots.
Furthermore, each CVS 630 is put through a 100 hour operating burn in. It is then inspected and operationally checked by a Customer Acceptance group that reports only to the company President. If the CVS 630 doesn't pass inspection in every detail, it isn't shipped.

OPTIONS

Video Compressor/Positioner

This plug-in circuit card and remote control panel package allows you to reduce, in real time, synchronous or non-synchronous video input signals to ¼ of their normal size. The resulting reduced picture can then be placed in any of 5 preset positions on the video screen or, through use of a joystick control, it may be positioned anywhere the operator desires. Horizontal and vertical joystick control of full-size pictures is also included.

Correct Color D.O.C.

Also contained on a plug-in card, this option is especially useful for local tape playback applications. It monitors off tape R.F., detects dropouts, reinserts correct color video from the previous line and stores corrected video in the frame memory. This ensures that even "frozen" video is dropout corrected.

Digital Noise Reducer

The flexibility of the unique memory architecture in the CVS 630 makes Digital Noise Reduction (DNR) a simple, economical plug-in option rather than an expensive, separate add-on. You don't even have to buy a D.O.C. because the DNR option includes it.

Through the use of X, Y and Z domain processing, 12 dB of noise reduction is readily achievable by the CVS 630 DNR without the motion artifacts and resolution loss common to other noise reduction devices. The DNR even reduces quad "banding" to help you salvage older tapes. And, since not all signals have the same kind of noise, the CVS 630 DNR has separate controls for luminance and chroma noise reduction. As a result, the achievement of quiet chroma no longer means over-reduction of the luminance.

CVS 630 SERIES SPECIFICATIONS

GENERAL

Signal Inputs

Video1 V p-p composite, stable interlaced or unstable heterodyne. 75 ohm terminating.
 Genlock1 V p-p composite video or composite sync, subcarrier and (625 only) PAL pulse. High impedance looping.
 D.O.C.1 V p-p R.F., 75 ohm terminating
 RGB0.7 V ea, 75 ohm terminating

Signal Outputs

Video #11 V p-p composite, by-passable
 Video #21 V p-p composite
 RGB0.7 V each
 Sync & Blanking4 V p-p

Stability

Residual luma TBE ±7 nsec with 50 dB S/N input signal
 ±20 ns with 40 dB S/N input signal
 Residual chroma TBE .. ±1° with 50 dB S/N input
 ±4° with 40 dB S/N input

Performance	625/50		
	525/60 NTSC/PAL-M	PAL SECAM	
Video bandwidth	±0.5 dB dc to 4.2 MHz	±0.5 dB dc to 5.0 MHz	±0.5 dB dc to 3.6 MHz
S/N ratio p-p video to RMS noise, R/S noise meter with bandpass filter, S.C. Trap & 10 kHz LPF	57 dB (ave)	55 dB (ave)	55 dB (ave)
Differential phase	1.5°	2°	N/A
Differential gain	1.5%	2%	N/A
2T K factor	1%	1%	2%
C/L delay	17 ns max.	17 ns max.	17 ns max.
Physical & Electrical			
Dimensions	10.5" (26.7 cm) H x 19" (48.3 cm) W x 22" (55.9cm) D		
Weight	50 lb (22.7 kg)		
Ambient temperature	10°-40°C		
Humidity	10%-90% non-condensing		
A.C. voltage	95-125V; 190-250V 50/60 Hz		
A.C. power	350 W		

ABOUT HARRIS VIDEO SYSTEMS

The CVS 630 is just one of the ways HVS uses modern digital and analog technology to make your video production look better. Besides being the acknowledged world leader in digital time base correction, HVS also manufactures other advanced products using video and digital techniques for professional television. Among these are the EPIC™ Computer-Aided Editing System and the CVS 310 Image Enhancer/Noise Reducer.

Worldwide customers include all major TV networks, many independent commercial and educational stations, most large duplicating facilities and a large number of educational, industrial and CATV organizations. All HVS products are backed by a worldwide network of Authorized Sales and Service Distributors.



HARRIS
COMMUNICATION AND
INFORMATION PROCESSING

HARRIS 9100 FACILITIES CONTROL

For Radio Or TV

- Building block concept allows a wide variety of applications, from complete automatic facilities control (including ATS), to simple remote or local control
- Reduces operating expenses
- Improves transmission quality
- Improves transmission system reliability
- Offers automatic security measures to protect your capital investment
- Allows automatic control of building environment
- Handles time-related functions automatically—tower lights on/off, etc.



Automatic Control Unit

The Harris 9100 Facilities Control Provides Protection...And Significant Savings!

The Harris 9100 is a facilities control system designed to improve your performance, protect your investment and cut your operating costs. The Harris 9100 in its various configurations can provide intelligent remote control; automatic transmitter control; automatic logging; plant protection through intrusion and fire alarms; automatic control of such items as tower lights and building temperature; and automatic exercising of standby equipment.

In short, the Harris 9100 Facilities Control provides surveillance over your transmission system and your physical plant, and offers protection from costly failures wherever they may occur.

The system is composed of a family of micro-computer controlled "building blocks" which determine the configuration, based on a specific application. Whether your need is to monitor and control a single co-located site or to operate up to three remote sites from a single location, the Harris 9100 Facilities Control has the flexibility to meet your requirements. No matter what the size of your operation—whether you're AM, FM or TV—you will find many beneficial applications for the Harris 9100 Facilities Control to help improve your profitability.

WHAT HARRIS 9100 CAN DO FOR YOU

There are three major areas where Harris 9100 Facilities Control can provide significant savings and/or improvements in a station's operation—1) manpower allocation, 2) protection, and 3) equipment performance. Let's take a closer look at each of these for specific examples.

Improved Manpower Allocation. The FCC requires monitoring and adjusting the broadcast transmission to assure compliance with technical standards. In addition, it is imperative that optimum use be made of the equipment while simultaneously protecting it from catastrophic failure. These requirements have been complicated by the increasing use of remote transmitter sites which, while ideal for transmission, are not conducive to manned operation.

The trend in both radio and television has

been toward delegation of the transmission system to operations personnel. Remote control equipment has been used increasingly as the only acceptable alternative to a full-time staff at the remote site. This has been a cost-effective approach for management, consistent with the increased stability and reliability of transmitting equipment. However, this approach does not provide the continuous monitoring which can spot trouble about to happen, which can provide trend analysis through careful parameter logging and which can allow operation at peak performance without rule violation.

The first responsibility of operations personnel is usually to the program chain. The combo operator often signs the transmitter log—in radio it's the announcer, in television it's the first-phone switcher. Even in those stations with a full-time transmitter engineering staff, monitoring the transmitter system may give way to higher priorities of equipment maintenance and repair.

The Harris 9100 Facilities Control meets all existing and currently proposed FCC regulations governing the monitoring, adjustment and remote control of radio and television transmitters. It can offer very valuable assistance to your operators for flawless transmission monitoring, adjustment and logging—freeing them for more effective work elsewhere.

Operation, Equipment and Plant Protection. The broadcaster is faced with potentially costly mishaps on a daily basis. One such area is violation of FCC rules and the resulting fines, particularly since Congress has dramatically raised the amount of maximum fines. This potential for higher fines has also increased as more stations operate their equipment at the legal maximum power and modulation levels, and operate with lower skilled, often untrained operators.

The transmission system also must meet its own rules in terms of what constitutes safe operation. Careful monitoring together with the proper action and associated alarms as provided by the Harris 9100 Facilities Control can help prevent operation outside the legal limits, or costly equipment failures with resulting lost air time.

Additional protection can be provided for the

entire physical plant with monitoring and alarms for intrusion or fire which may lead to reduced insurance premiums for these sites.

Improved Performance. Maximizing equipment life and minimizing FCC violations are not the only advantages of Harris 9100 Facilities Control. In an increasing number of markets, large and small, operating equipment at the maximum levels is a key to the successful competition for higher ratings and increased revenues. Even the most stable transmission system needs the attention of the Harris 9100 to operate at peak performance over extended periods of time with minimum equipment problems, and without FCC rule violations.

Another area for improved performance with the Harris 9100 is in trend analysis. Long-range tracking of very accurate readings helps locate problem areas in the transmission system and pinpoint areas for improvement.

HOW HARRIS 9100 FACILITIES CONTROL IS USED

Remote Control. The traditional remote control system provides commands to the transmission system and feeds back a limited amount of information to the control point. Such a system has command channels to raise, lower and turn off or on; status channels for on-off indication; and analog channels to measure such parameters as voltage, current, temperature, etc. The Harris 9100 Facilities Control opens a new dimension in remote control, providing intelligent surveillance and decision-making. Channels are automatically scanned and compared with pre-programmed limits; and alarms are initiated or corrective action taken, as appropriate. Power can be computed using the indirect method of power determination and the Harris 9100 can serve either as an efficiency monitor or as the primary means of power control.

Automatic logging of all parameters can be performed on a regular basis, eliminating periodic interruptions of station personnel. Also, the logger fully records out-of-limits conditions when they occur.

Time-initiated switching may be employed for power levels, changing control limits, check-

ing tower lights, and other time-oriented functions.

Automated Transmission System (ATS).

The Harris 9160 Automatic Control Unit (ACU) provides for ATS operation with its power and modulation control, yielding additional benefits to management. Relaxed operator restrictions will give greater flexibility in the selection of staff and duties; the FCC requirement for a person to be present for monitoring can now easily be met by utilizing a receptionist, switchboard operator or guard. Under existing and currently proposed ATS rules, there will be a reduction in requirements for routine inspections, meter readings and logging requirements. And there will be much less anxiety concerning the reliability of switching power modes in AM stations, very often a problem where "combo" operators are employed.

To sum it up, the Harris 9100, operating under ATS rules, will provide cost savings considerably beyond those provided by remote control, through more efficient use of manpower.

Facilities Control. The Harris 9100 Facilities Control is a true systems approach to the transmission system and related physical plant. Up to three remote sites can be controlled from a single common control unit at the studio. In addition to control of the transmission system, related functions can be surveyed and controlled. Heating, air conditioning and ventilation equipment can be monitored. Backup equipment can be exercised and performance logged, all on an automatic basis. And temperature sensors and intrusion alarms can be constantly on guard for plant protection. By combining the monitoring and control of all functions, the Harris 9100 Facilities Control will profitably produce greater consistency, precision and reliability of operation than is obtainable with existing manually operated equipment. In addition, The Harris 9100 will allow maximum operation of the transmission system to provide the most competitive broadcast signal in your market.

The Harris 9100 Facilities Control design is based on over half-a-century of experience by Harris in the broadcast equipment field—and the quality is backed by the most experienced service organization in the industry.

Harris 9100 Facilities Control Components

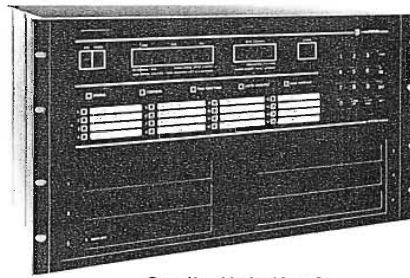

Studio Unit (9120)

Studio Unit (9120). Location: studio facility. Function: communicates with the Transmitter Unit (9130) or the Automatic Control Unit (9160) to provide monitoring and control of the transmitter facility.

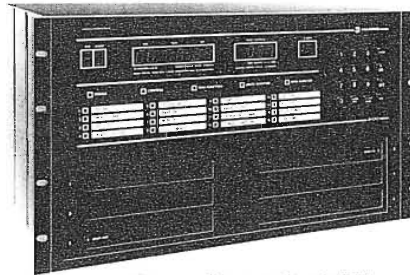

Transmitter Unit (9130)

Transmitter Unit (9130). Location: transmitter site. Function: provides remote control of the transmission facility when used with a Studio Unit (9120) or an Automatic Control Unit (9160). Allows remote control from a studio facility or from another transmitter facility. Alternate function: provides local control of the transmission facility.

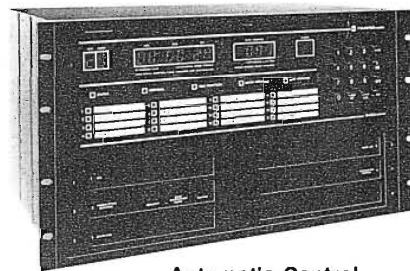

Automatic Control Unit (9160)

Automatic Control Unit (9160). Location: transmitter or studio site. Function: provides automatic facility control—i.e., automatic control of transmitter (ATS), building environment, security measures, etc.

Options

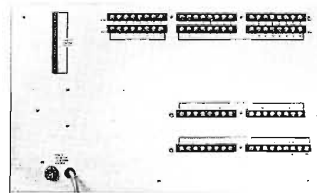

Channel Expansion Panel

Channel Expansion Panel. Offers additional channels for the Transmitter Unit (9130) and the Automatic Control Unit (9160). Each panel adds 8 telemetry, 16 status and 16 command functions. Up to 7 Channel Expansion Panels may be added to each 9130 and 9160 unit.

Multi-Site Module (not shown). Allows a Studio, Transmitter or Automatic Control Unit to communicate with up to three remote sites.

Logger. Provides printout of all analog and status channels from up to three remote sites.

Monitor and Alarm Panel. Used in conjunction with the Automatic Control Unit (9160), provides minimal monitoring and control in compliance with FCC ATS rules for monitor and alarm points.

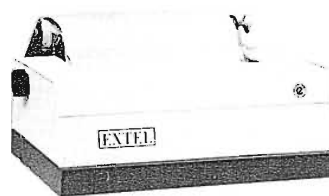

Logger

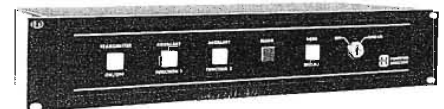

Monitor and Alarm Panel

From a complete multi-site automatic facilities control system...

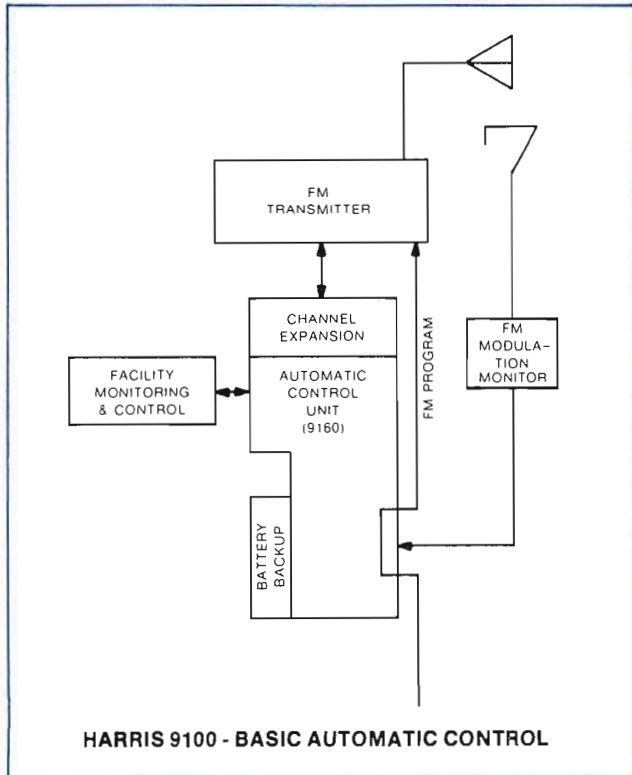
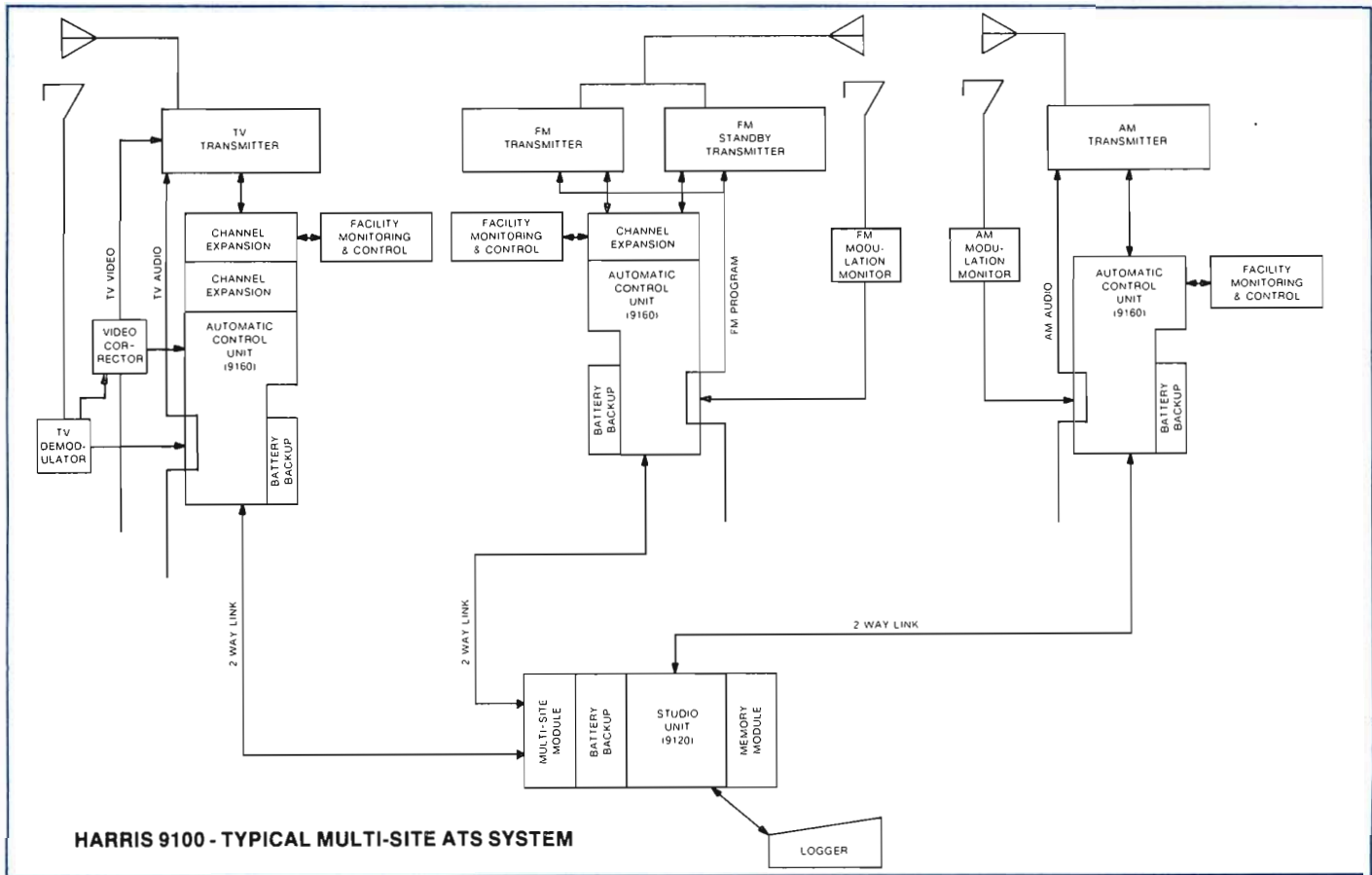

.....to basic automatic control

....to remote or local control, the Harris 9100 Facilities Control can be configured to fit your requirements.

For complete information and assistance in meeting your system needs, please contact your Harris Radio or Television District Sales Manager, or Harris' Domestic Sales Department in Quincy, Illinois (phone: 217/222-8200).



HARRIS
COMMUNICATION AND
INFORMATION PROCESSING

THE HARRIS 9000 PROGRAM CONTROL SERIES

• Three distinct systems available, offering the broadcaster a complete selection to meet his particular requirements • **MULTI-FILE™** Program Memory saves you time...and money • Easy-to-understand video display of current system status • Conversational messages • No special skills required to operate system • Live-assist features and ease of operation meet the needs of today's fast-paced combo operator • Advanced micro-computer design • Operationally and environmentally proven... hundreds of Harris' systems in field use.



The Harris 9000 Program Control

The purpose of radio program control equipment is to maximize station profits through greater operating efficiency and through the presentation of a more saleable program product. That's pretty basic, but that's what it's all about...saving time...improving your product...increasing your profits.

That's what the Harris 9000 Program Control is all about, too. It has been designed to give you the best tool available to increase the efficiency and effectiveness of your staff, while providing the opportunity to improve your sound—whatever your format may be.

As the originator of micro-computer program automation, Harris has drawn on its years of experience, and taken the next step forward to give you more flexible, more convenient, more reliable, and easier to operate systems than any available before. Harris 9000 systems will handle any format flawlessly, yet are so easy to understand, and so easy to program that even the most non-technical person in your station will readily see how they work and appreciate their help.

With many exclusives, from live-assist features to the truly advanced MULTI-FILE™ Program Memory, the Harris 9000 Series is definitely the most advanced concept in program automation, and the best there is at its job—helping you improve your results, on the air and on the bottom line.

UNLIMITED FLEXIBILITY TO HANDLE ANY FORMAT....

With the wide variety of program formats that are on the air today, a system must have great versatility if it is to be able to handle any one of them. Harris' 9000 systems have that versatility. No programming is too complicated—or too simple. They will faultlessly handle everything from fast-paced "lots-of-music, lots-of-talk" programming to a more simple sequence of reel-to-reel events integrated with commercials at the proper times. In addition, the Harris 9000 enables management to achieve its goal of minimizing the time and errors associated with entering commercials and other schedule changes.

EFFICIENCY AT EVERY STAGE....

The Harris 9000 aggressively pursues maximum efficiency at every stage of station operation. The video terminal provides necessary information—very **complete** yet very **simple**—for schedule entry and review. Even during editing, a status display informs the operator of the on-air situation, alerting him to possible problems. Conversational messages provide easy-to-understand prompting regarding the nature of errors. The keyboard layout, developed from Harris' experience in hundreds of installations, is aimed at fast and reliable scheduling.

SIMPLIFIED SCHEDULE ENTRY WITH MULTI-FILE PROGRAM MEMORY....

The need to separate commercials from repetitive format elements was partially satisfied with the use of sub-routines, a concept developed by Harris and now widely copied throughout the industry. With the MULTI-FILE Program Memory, Harris' 9000 has vastly improved on a good idea, providing a real solution to an error-prone, time-consuming problem.

Commercial schedules, music rotations, repetitive format elements and special programs are all independent schedules which must be integrated to create the broadcast day. MULTI-FILE Program Memory provides **independent** files for these schedules, eliminating the need to refer to unrelated material. Traffic, for instance, no longer needs to know where to go after a commercial cluster. Traffic keeps the commercial file, the music director keeps the playlist file, etc. This is a real time-saver.

The Harris 9000 with MULTI-FILE Program Memory keeps things simple by integrating these various schedule files, according to plan and always on time. The operator can highlight on the video screen the look-ahead display of entries from any particular file; in addition, a bar graph can be displayed, distinctly illustrating the integration of upcoming schedule files. The innovative use of graphics

MORE VERSATILE, MORE EFFICIENT THAN ANYTHING YOU'VE SEEN BEFORE

in the Harris 9000 is not only of great assistance to the operator, but minimizes effort in the area of operator training.

IMPECCABLE EXECUTION....

Today's competitive operation can't afford to waste time deciding whether or not a format change is possible. The Harris 9000 Program Control knows that any format is possible, and concentrates on impeccable execution. "Tighter playlist control...more consistent air sound...increased ratings" are broadcaster

comments that are frequently made about Harris' program control equipment.

Live or automated operation is no longer the issue when the end result is a significant advantage in ratings and revenues. The Harris 9000 provides multiple overlaps, dependable voice-track synchronization, plus solid support for the fast-paced live announcer.

Live-assist means never having to keep a program log, stack carts or cue records. A countdown timer, complete with a ten-second warning, helps maintain a tight sound. Insertion of unscheduled material is easy. This is live-assist that really aids your on-air talent and encourages more creative performance.

The 9000 Series Control Electronics

At right is a typical system for use with a program service. Music is on reel-to-reel. Commercials (and other cartridge material) are in the instant access Instacart (5) and the random access Go-Carts (6 & 7). When time-announce is used, deck 14 has even numbered minutes and deck 15 has odd numbered minutes. The system electronics require only half of a standard rack for mounting.

- A. The computer mainframe includes the monitor panel and control electronics.
- B. The solid-state Audio Switcher houses source modules, dual silence sensors, program amplifiers, faders and 25 Hz filters.
- C. Computer-grade power supply.
- D. Dual flexible-disk drives for increased memory storage capabilities (9002 and 9003).

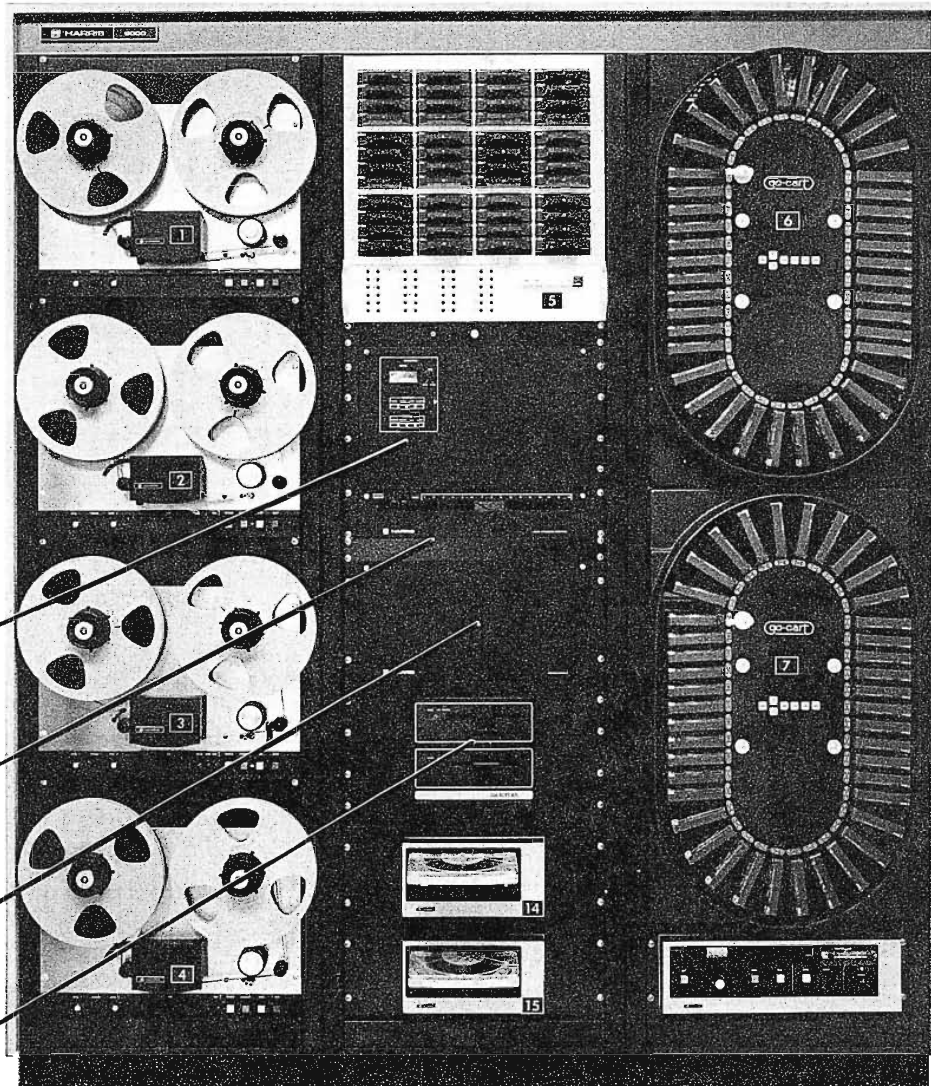

The 9000 Series Control Terminal

Programming and operating instructions are communicated to the system from a terminal that may be located up to 150 feet from the system electronics. The terminal provides continuous video display of various operational functions, and is also used for editing purposes.

Upper area shows on-air status, real time, and the next scheduled event.

Lower area shows, in the various operational displays, a list of upcoming schedule entries. In the editing modes, this serves as a "work area".

A full typewriter keyboard is provided for entering log messages for encoding. In the 9003, the keyboard is also used for titles and for live copy insertions.

In the 9003, up to 3 lines may be used for bulletins or other copy for live insertions. For instance, this copy may be typed on the news room terminal and will appear on the studio terminal video display.

The Mode Control Keys are used to determine what data is to be entered (scheduling, set clock, log encoding, etc.). Manual operation keys are used for remote control (START, STOP, FADE, etc.).

The Data Entry Keyboard is used for entering instructions. It includes dedicated function keys to eliminate typing frequently used instructions (PLAY, INTRO, LINK, etc.).

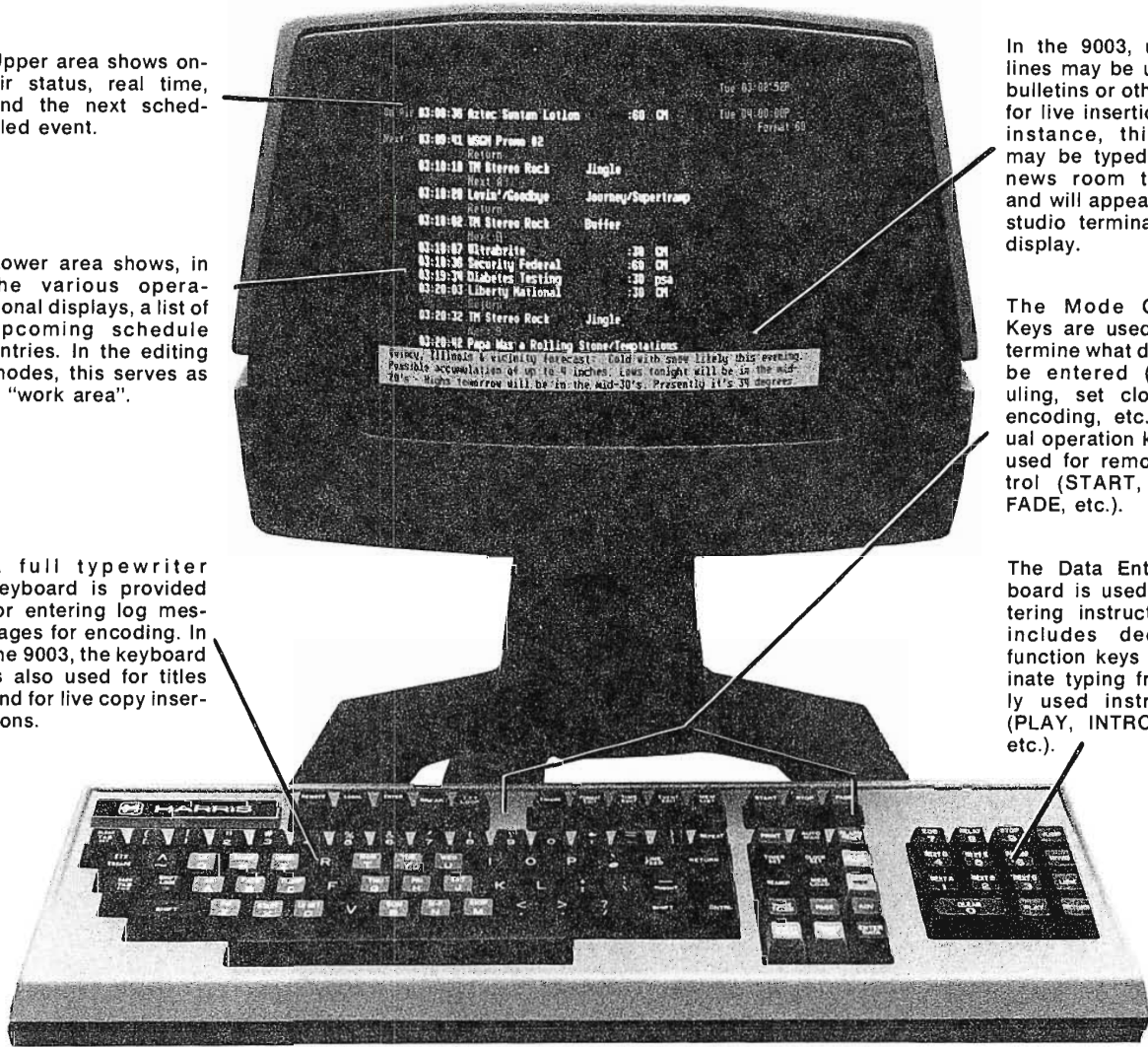

YOUR CHOICE OF SYSTEMS TO MEET YOUR PARTICULAR REQUIREMENTS.

The Harris 9000 Series is composed of three distinct systems, each showing a progressive increase in programming capability. The 9001 is a basic program control system which can be used for any automation requirement. It uses a single video terminal, and has a 1,999-event memory, which is expandable up to 9,999 events. The 9002 fills all program control requirements, plus has the ability to interface with an external business system, and can be programmed from totally independent terminals. It has a 1,999-event memory, expandable up to 9,999 events. The 9003 handles even the most sophisticated

format faultlessly—plus has the ability to **generate** a programming schedule!

The Harris 9000 Series has been designed to expand as your needs expand. All 9000 Series models can easily be upgraded in the field to a higher numbered model.

THE HARRIS 9001. The 9001 has the full mainframe, audio switcher and heavy-duty power supply already in use in hundreds of installations worldwide. The 1,999-event memory (expandable to 9,999 events) and the 7-day clock allow you to program for a weekend or an entire week ahead. The simple keyboard and plain-text programming assure mastery of system operation by most station

personnel in less than a day. Dual-intensity video allows highlighting of the schedule items chosen by the operator. The types of highlighted entries could be commercial clusters, music sets, contest/promos—any file from the MULTI-FILE™ Program Memory.

Among the many other important 9001 features are: automatic power failure restart, time announce control, network join, ready sensing to prevent dead air, remote control and countdown clock for live-assist, bulletin insertion, "coffee pot" function relays, self-testing for on-site troubleshooting, and MULTI-FILE Program Memory.

THE HARRIS 9002. In addition to the many features of the 9001, the 9002 includes dual flexible-disk drives to increase the memory capability and to provide a permanent memory storage medium.

Another key innovation is the ability of the 9002 to support totally independent terminals. Using MULTI-FILE Program Memory, the traffic director and program director can have their own files in the program memory. Now they can both edit their respective areas of event memory simultaneously! And, while this is happening, data can be received or transmitted to an external business system using the port provided for this purpose.

THE HARRIS 9003. The Harris 9003 has revolutionized the role of program control in radio broadcasting by integrating the program system into the planning process—extending the benefits of program control beyond the operations level to everyone concerned with the on-air product.

The traffic director can enter scheduling requirements on any 9003 terminal; the system either accepts the entry and determines where the source material should be placed in the system, or advises the traffic director of a conflict. Back-to-back scheduling problems, formerly possible using

random-access source equipment, are now avoided in the Harris 9003. For example, the system will alert you that deleting the airline spots, because of a plane crash, will result in a beer commercial adjacent to the Alcoholics Anonymous PSA.

With the plain-text title display feature, the music director no longer has to wonder if the system will air the recurrent record he wants following a commercial break. With Harris 9003 in charge of a random access music library, it is now possible to specify the names of the music selections. Instead of a "Play 05-27" indication, an operator will see that the scheduled selection is "Sara by Fleetwood Mac", along with other information, on the same line, such as intro/running time and chart position.

As more stations seek to better localize their syndicated programming, there is a need for periods of live programming; this may be for drive time or news blocks. In any case, the Harris 9003 is ideal for the live operator. The display shows the name of a song or commercial that is on the air, plus the names and starting times of upcoming scheduled events...and the countdown timer automatically gives the time remaining for the on-air event.

The system software is contained on the disk. In the unlikely event of disk failure, the system defaults to programmed Read-Only Memory (EPROM) chips located on the single 8080 CPU board; it would then operate similarly to the Harris 9002.

Going beyond the traditional role of the program system, the Harris 9003 brings significant benefits to the broadcaster—cost reduction due to reduced workload at the planning stage; improved on-air performance from scheduling flexibility; reduction in lost revenue due to scheduling errors; and improved operator performance due to easier system operation.

MAJOR SYSTEM CAPABILITIES

Harris 9000 Series Model	Standard No. of Days Operation (Walkaway)	Stand. No. of Days with Optional Memory Expansion	Interfaces with Business Automation	Countdown Clock	Independent Editing/Prog. Terminals	Logging Option	Program Scheduling	Plain-Text Programming	Plain-Text Title Display	Live Copy Display
9001	3*	15*	No	Program-mable	No	Yes	Manual	Yes	No	No
9002	3-15*	15-31*	Yes	Program-mable	Yes (Optional)	Yes	Manual	Yes	No	No
9003	31** (Minimum)	Not Appli-cable	Yes	Auto-matic	Yes (Optional)	Yes	Auto-matic	Yes	Yes	Yes

*Based on average of 50 events per hour **Based on average of 110 events per hour.
SPECIFICATIONS SUBJECT TO CHANGE WITHOUT NOTICE.

STANDARD FEATURES IN ALL HARRIS 9000 SYSTEMS...

- Video editing and display
- MULTI-FILE™ Program Memory
- Jock-assist countdown clock with 10-second warning
- Automatic power failure restart
- Internal diagnostic program for on-air troubleshooting
- Built-in time announce control
- Interfaces to all popular random access machines
- Ready sensing to prevent dead air
- Crystal-controlled 7-day clock
- Simple one-time bulletin insertion
- Operator "error sensing"
- Automatic voice track control
- Programmable fade-under for talk-over
- Software logic — your safeguard against future obsolescence
- Front panel access to test points and adjustments
- Full function monitoring and audition
- Optional logging, which provides discrepancy diagnostics
- 25 Hz detection included for all reel-to-reel sources
- Ready for most syndicated programming services
- Four "coffee pot" function relays included
- Micro-computer versatility
- Complete system remote control
- Dual silence sensors
- Stereo and sum-channel mono outputs
- Emergency back-up operation panel

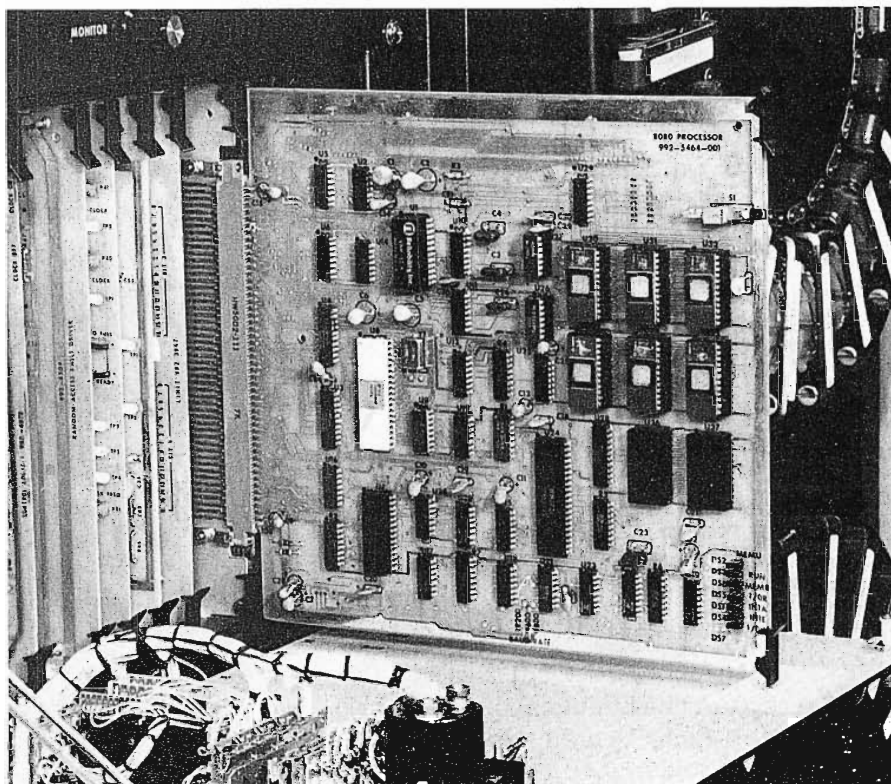

All processing is accomplished by a single CPU board. Harris 9000 Series circuit boards are designed and tested by computer-controlled equipment.

A COMPLETE LINE...

The Harris 9000 Series has been designed for easy plug-in expansion to accommodate the growth you expect for your station. Starting with the Harris 9001, which is the basic control system, on through the Harris 9002 and 9003, you have a choice of models, depending on your initial application requirements. Each model is easily upgraded in the field to any higher model number. The 9001 features the same mainframe, audio switcher and heavy-duty power supply already in use in hundreds of installations worldwide. The 9002 adds dual-drive flexible-disk storage, independent-terminal circuitry, and business system interface hardware. The Harris 9003 integrates the program system into the planning process to extend the benefits of program automation to

the management level. Additional sources may be added to all models, as may the sophisticated Harris logging system.

BUILT AND BACKED TO PROVIDE LONG-TERM VALUE...

The Harris 9000 Program Control is built using the latest computer-assisted techniques to assure outstanding reliability in the field. The quality of Harris' micro-computer program control is backed by the most experienced service organization in the industry, and is proven with the largest users' group in the country. Benefit from the experience of others. It all adds up to make the Harris 9000 Program Control a very secure investment for your station.

For a complete evaluation of your requirements, and a system proposal, please contact your Harris Radio District Sales Manager, or the Harris Radio Sales Department in Quincy, Illinois (217/222-8200).



HARRIS
COMMUNICATIONS AND
INFORMATION HANDLING

M90

Modular Audio

Control

Console

- Sophisticated audio control for the radio and television broadcaster
- High RFI/EMI immunity
- Factory pre-wired and tested, but field expandable
- Two, four and eight output configurations
- Combined monaural output standard
- Up to twenty-six mixing positions
- Up to fifty-two inputs—more on special order
- Customer selected module placement
- Patented linear motion attenuators—five year warranty
- Optional EQ on each input
- Switchable Hi Pass/Low Pass filter on each input
- Input level of -70 dBm to +20 dBm with gain trim
- LED function indicators
- Independent monitor feeds
- Input and output monitoring

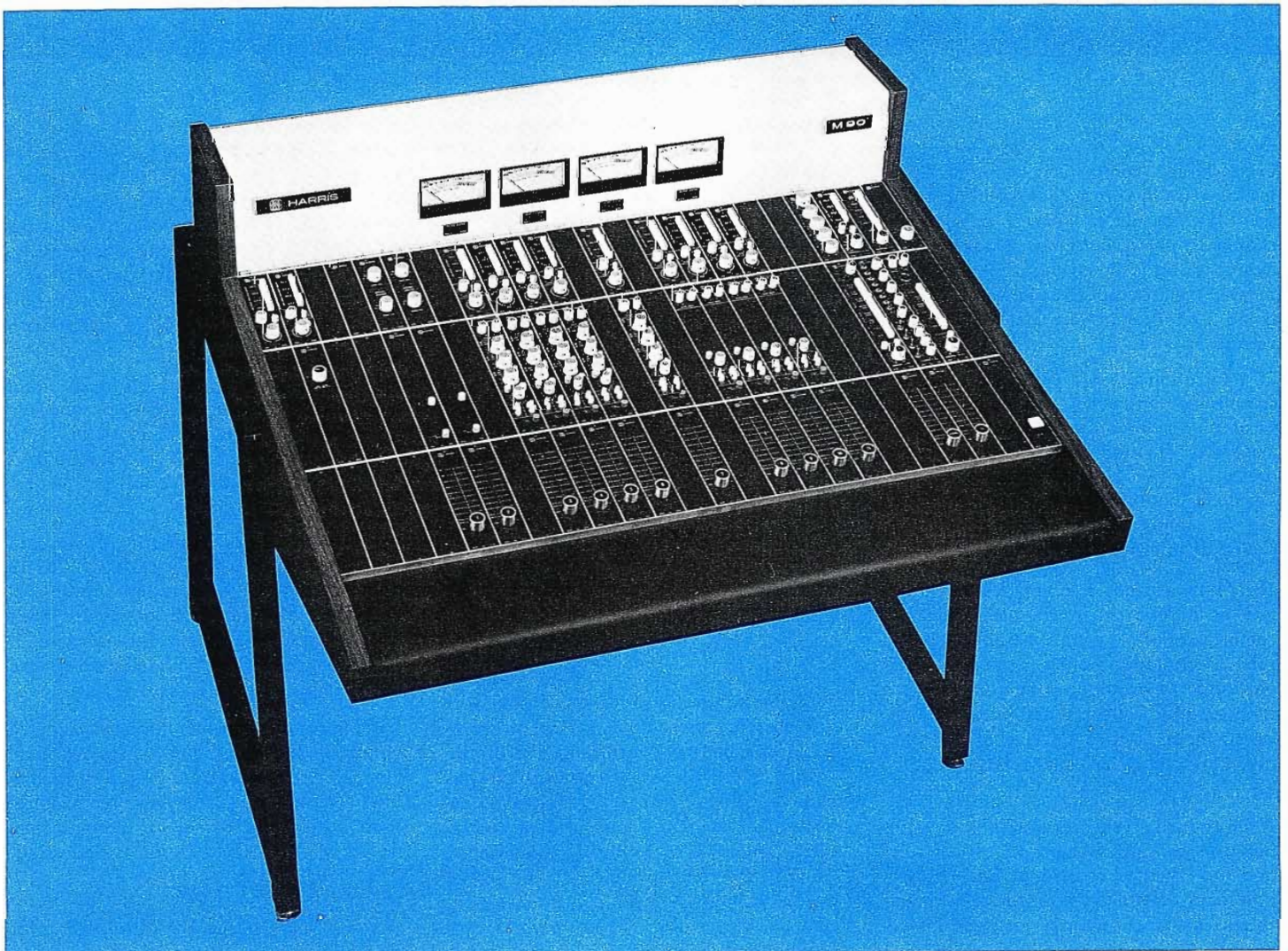

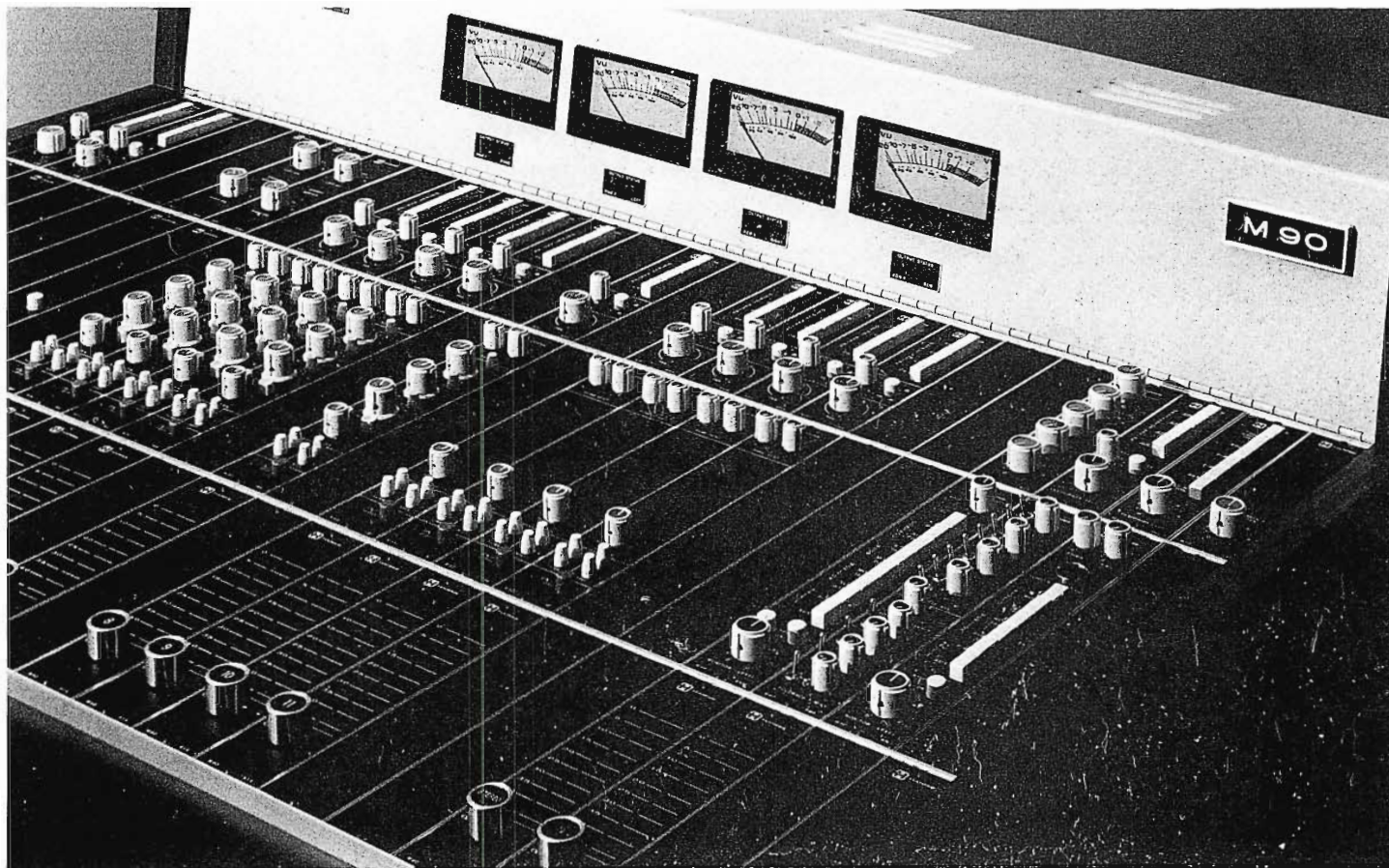

M90 control board, showing typical 4-output channel configuration.

One of the most versatile audio consoles available today, Harris' Model M90 is an expandable, completely modular, professional on-air/production/ reinforcement unit. The console provides 2 or 4 output channels with up to 26 mixing positions (52 inputs), or up to 24 mixing positions (48 inputs) in the 8 output channel version. Combined monaural output is standard in all versions.

Customization of each M90 is readily accomplished by selecting, from a wide variety of plug-in modules, those that exactly meet your requirements. In addition, there are a number of easily altered console functions that are "programmed" by the use of jumper wires, creating a broad choice of operating characteristics.

The M90 provides complete VU metering, two echo send/return channels, talkback communications, programmable control room and studio muting, optional EQ at each input, two foldback mix outputs (one is optional), a slate/test oscillator, optional stereo inputs, and a full line of matching accessories that includes a plug-in patch bay.

A full capacity system, the M90 fills the gap between conventional broadcast consoles and sophisticated recording consoles, with additional flexibility to meet demanding requirements of quality conscious broadcasters.

Depending on the choice of modules, the M90 is ready to be used in many different applications.

ON-AIR

The M90, in the 2, 4 or 8 channel versions, functions as either a mono or stereo on-air broadcast console. It may be used to provide simultaneous discrete mono and stereo feeds (rather than limiting the mono output to an inferior combine of the stereo program). Combined mono is available, primarily for checking phase compatibility (or where time does not allow a discrete mono mix to be established). Monitor muting is interfaced to the input module On/Off and Mic/Line switches in typical on-air fashion, except that reprogramming of muting is vastly simplified and improved by the use of Transistor-Transistor Logic (TTL) circuitry instead of relay logic.

PRODUCTION

The M90 also functions in the four channel configuration as a production console, with discrete program outputs suitable for professional multi-track recording and broadcast production. For these applications, the console is equipped with completely independent monitor feeds for the control room, studio, and foldback headphones. An important monitoring function is served by the built-in, 2-section, 4-channel overdub/foldback mixer which permits sync playback of previously recorded tracks

with the program output of the console. In television, the foldback mix is valuable for re-recording (looping). With many more monitoring features, and the capability of mono and stereo monitoring, awkward outboard mixers are no longer a necessity. With optional tone oscillator and high pass filter sections, this console becomes an outstanding production unit for automation tapes.

Pan pots are standard on most input modules for creative effects. High and low pass filters can be useful in cleaning up poor recordings. Channel input equalizers provide up to 12 dB of boost or cut at 6 selectable frequencies.

An 11 position input gain trim provides an additional 40 dB attenuation or 25 dB boost to handle unexpected input level variations, and accommodates input levels of -70 to +20 dBm. This feature is available on all input modules except the stereo line input module set.

Complementing the monitor system, a full input SOLO system permits preview of all inputs for cueing with far greater flexibility than conventional cue systems. Control room monitor speakers are automatically muted when a SOLO button is depressed.

CONSOLE MAIN FRAME

The M90 main frame provides housing for all modules, terminations, and intercon-

tions required in the console. The all aluminum enclosure is furnished with walnut formica sides. The system concept is one using a motherboard with plug-in modules containing amplifiers and associated controls. Behind the hinged meter panel are plug-in line output amplifier cards used as outputs for program, echo send, monitor and fold-back.

The main frame is exceptionally rugged, and lightweight enough to be practical in portable applications. Blank space on the meter panel can be used for installation of digital clocks or other accessories, and space is available on the console top panel for installation of tape remote controls, etc.

An illuminated VU meter appears for each of the 2, 4 or 8 program outputs in the console.

The main frame motherboard will accept input modules with or without EQ in any of the input positions. Unused positions are covered with matching blank panels. Positions to the extreme right are allocated to monitor and master control modules.

A fully protected rack-mount power supply is provided. Designed to work from 230 or 115 volt AC, 40-60 Hz line source, it is

regulated and protected against over voltage, excessive current, and line voltage variations. Power drain is less than 100 watts. A current limited, fully protected 48-volt phantom microphone power supply, wired to microphone inputs, is included for central powering of condenser microphones while retaining dynamic microphone compatibility.

TYPICAL INPUT

A typical input position provides a linear motion attenuator and stepped sensitivity control to accommodate levels from -70 dBm to +20 dBm. An optional 3 knob, 6 frequency equalizer provides 12 dB boost or cut at 80 Hz or 150 Hz, 1.8 kHz or 4 kHz, and 7.5 kHz or 12 kHz; In/Out switch with LED indicator; plus Hi-Lo filters.

Switch selection between two inputs which may be either microphone or line level is included. Solo function with LED indicator at each position may be used without interruption of program. A simple strapping change on the input module PC board permits altering solo function to a pre-fader cue function for broadcast applications. An On-Off switch with LED indicator and controls for echo send A and B appear on each input.

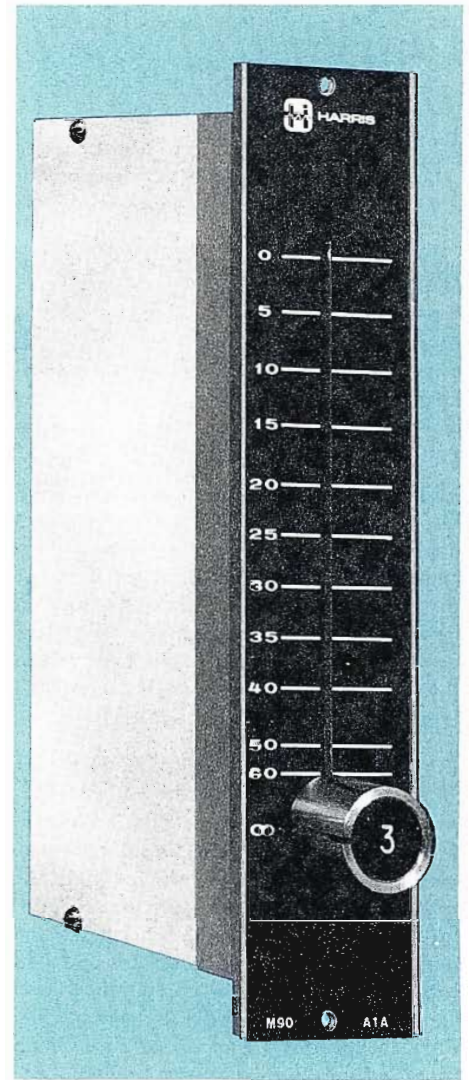

Patented linear motion fader is impervious to liquid or solid foreign matter—warranted for five years!

PERFORMANCE SPECIFICATIONS

- Frequency response: ± 1 dB 20-20,000 Hz, measured any input to any output at any level up to +18 dBm out.
- Noise: Measured from any microphone input to any output channel is not less than 74 dB below +4 dBm output, with a -50 input, nominal gain settings, 20-20,000 Hz unweighted. Measured from any line input to any output channel is not less than 80 dB below +4 dBm output, with +4 dBm input, nominal gain settings, 20-20,000 Hz unweighted.
- Distortion: THD less than 1/10 of 1%, 30-20,000 Hz at any level up to +18 dBm output. Less than 5/10 of 1% 30-15,000 Hz at levels +18 to +24 dBm output. Measured any input to output. IM distortion less than 0.5% at +18 dBm output.
- Crosstalk: Not in excess of -80 dBm at 1,000 Hz and -65 dBm at 10,000 Hz. Measured worst case condition, any input to any output, adjacent busses.
- Maximum Output Level: +24 dBm, transformer isolated.

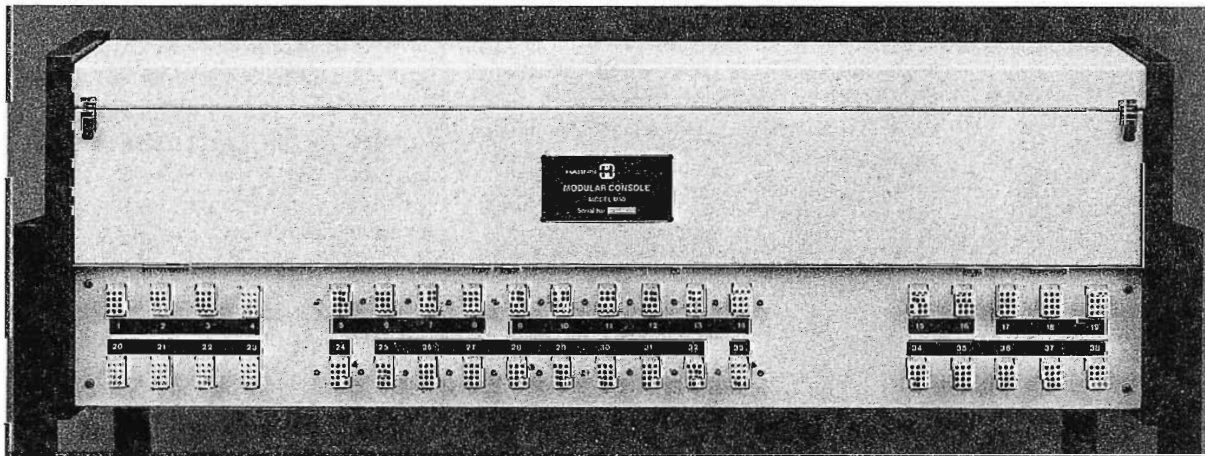

Rear view, M90, showing input and output connections through standard multi-pin connectors. XLR connectors are optional.

HARRIS' M90 MODULAR AUDIO CONSOLE MAIN FRAME AND MODULES

The following listings cover the major components available to customize the M90 audio console to your own requirements. Order numbers are listed in parentheses following the descriptions. A complete chart of these components is shown on the following two pages for your ordering convenience.

MAIN FRAMES

The M90 series includes four configurations of main frames involving two sizes—all constructed of heavy aluminum extrusions. Each main frame is supplied with support legs to make it free standing or it may be flush mounted in a desk or table top.

All plug-in modules and components, with the exception of the power supply, are housed in the main frame. Signal interconnect, logic and power distribution for all modules is provided by a mother board. Patch points, input and output terminations are located at the back of the main frame through multi-pin connectors; however, XLR terminations are also available.

M90-2MF TWO CHANNEL OUTPUT MAIN FRAME (MAXIMUM 18 FADERS).

Main frame for 2 channel output console. Includes master faders, master control module (MC4), talkback module (TB), 2 line amplifiers (A30), 2 VU meters, power supply, logic circuits and wired for maximum number of inputs. Accommodates up to 18 faders (mono, stereo or combination) and 12 line amplifiers. Size: 38 inches wide, 32½ inches deep and 29½ inches high (floor to padded arm rest). (740-0201-000.)

M90-4MF FOUR CHANNEL OUTPUT MAIN FRAME (MAXIMUM 18 FADERS).

Main frame for 4 channel output console. Same size and facilities as 2 channel output main frame except it is supplied with 4 VU meters and 4 line amplifiers. (740-0202-000.)

M90-4MFS FOUR CHANNEL OUTPUT MAIN FRAME (MAXIMUM 26 FADERS).

Same facilities as 4 channel output main frame except it will accommodate 26 faders. Size: 49½ inches wide, 32½ inches deep and 29½ inches high (floor to padded arm rest). (740-0225-000.)

M90-8MF EIGHT CHANNEL OUTPUT MAIN FRAME (MAXIMUM 24 FADERS).

Main frame for 8 channel output console. Accommodates up to 24 faders (mono, stereo or combinations). Includes master faders, 2 talkback modules (TB), 2 master control modules (MC4 and MC8), 1 foldback master control module (FBM), 8 VU meters, and 11 line amplifiers (A30). Frame will house up to 18 line amplifiers. Size: 49½ inches wide, 32½ inches deep and 29½ inches high (floor to padded arm rest). (740-0226-000.)

MIXING MODULES

The general term "mixing modules" encompasses a wide variety of plug-in modules, both mono and stereo, including faders, input modules (with or without equalization) and switching modules.

M90-A1A LINEAR MOTION MONO FADER.

Smooth linear action attenuator with over 4 inches of travel. Adjustable tension. Sealed elements are impervious to dust, dirt, liquids. Warranted 5 years! (740-0215-000.)

M90-A2 LINEAR MOTION STEREO FADER.

Same as mono fader, except stereo. (740-0216-000.)

M90-IME MONO INPUT MODULE WITH 3 SECTION EQUALIZER.

Plug-in mono input module for use in any main frame. On-Off switch with LED indicator. Automatic muting. Two inputs, mic or line, selected by interlocked pushbutton; supplied for 1 mic and 1 line input, but can be easily strapped for 2 mic and 2 line. Gain trim accommodates inputs from -70 to +20 dBm; patch points; switchable High Pass and Low Pass filters independent of equalizers. Solo selected by latching type pushbutton with LED indicated for "Cue" or "Preview", with option for pre-equalizer, pre-fader or post-equalizer, post-fader operation. Three section equalizer—each section fully adjustable and each individually selected by latching pushbutton, and two echo send controls for assigning an adjustable portion of the module output to either one or both of two "Echo" or effects busses. (740-0206-000.)

M90-IM INPUT MODULE (NO EQUALIZER).

Same as M90-IME module, but less the 3 section equalizer. (740-0207-000.)

M90-SIM STEREO LINE LEVEL INPUT MODULE (NO EQUALIZER).

Accepts left and right inputs at line level. Has module On-Off switch with LED indicator and provides SOLO feed as a combination of L and R. (740-0208-000.)

M90-SPF4 FOUR CHANNEL BUSS AND PAN MODULE WITH FOLDBACK #2.

Used with 4 channel output models only. Provides method of assigning output from mono input module (IME and IM) to any one or all of the four output busses. Also contains PAN pot and foldback On-Off switch and foldback level control. (740-0210-000.)

M90-SPF2 TWO CHANNEL BUSS ASSIGN AND PAN MODULE WITH FOLDBACK #2.

Performs same function as M90-SPF4 module, but for use with 2 channel output console. (740-0213-000.)

M90-8SPF8 EIGHT CHANNEL BUSS ASSIGN AND PAN MODULE WITH FOLDBACK 2 MIX.

Performs same function as M90-SPF4 module, but for use with 8 channel output console. (740-0230-000.)

M90-SSM4 STEREO SWITCHING/BUSS ASSIGN MODULE—FOUR CHANNEL.

Used with 4 channel output models only. Assigns left and right output from stereo input module (SIM) to output busses. (740-0211-000.)

M90-SSM2 STEREO SWITCHING MODULE—TWO CHANNEL.

Same function as M90-SSM4 module, but used only with 2 channel output models. (740-0214-000.)

MONITORING MODULES

Ten different monitoring modules are available, offering relatively simple to very extensive monitoring for both loudspeakers and headsets.

M90-CRM CONTROL ROOM MONITOR MODULE.

This is a basic monitor select and control module for 2 and 4 channel output consoles. Facilities include: mono or stereo operation; monitor level control; separate pushbutton switches for on-off operation of left and right control room speakers; 8 position interlocked pushbutton switch providing monitor inputs from 4 channel mix, 2 channel program, 2 track tape, mono program, mono tape, sum (L+R), foldback and auxiliary; LED indicators for control room mic and SOLO and SOLO buss level control. (740-0203-000.)

M90-8CRM CONTROL ROOM MONITOR MODULE FOR 8 CHANNEL OUTPUT CONSOLE.

Same operation as M90-CRM module, but used only with 8 channel output console. (740-0227-000.)

M90-SM STUDIO MONITOR MODULE.

Used with 2 and 4 channel output consoles. Provides the source for left and right studio monitoring speakers. Facilities include: level controls for monitor, talkback and foldback; talkback microphone; LED warning light for live studio microphone; manual pushbutton switch for studio muting with LED indicator and 6 position pushbutton switch for feeding studio monitor from: control room monitor, 2 track tape, mono tape, foldback 1 and 2 and an auxiliary input. (740-0204-000.)

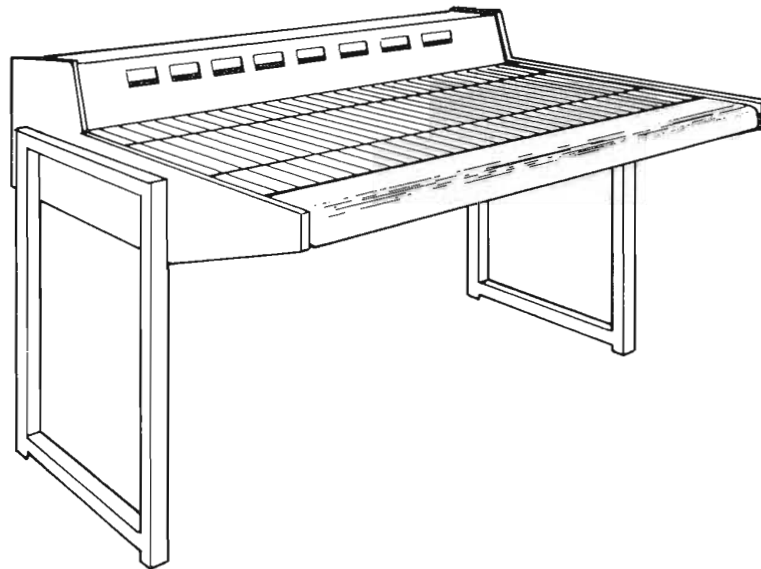

**M90 CONSOLE
MAIN FRAME**

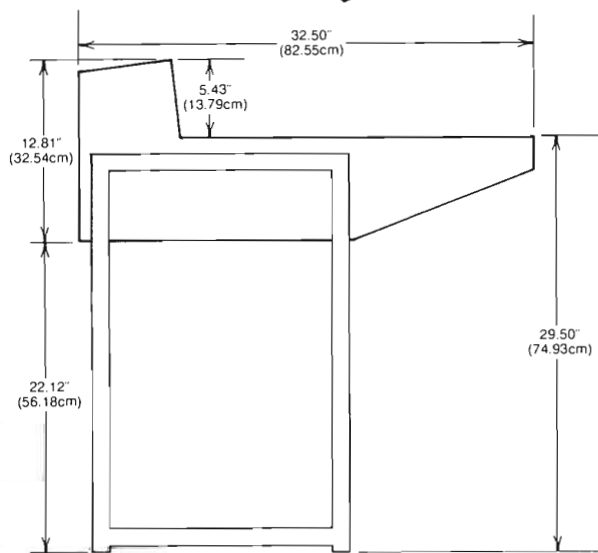

-SIDE VIEW-

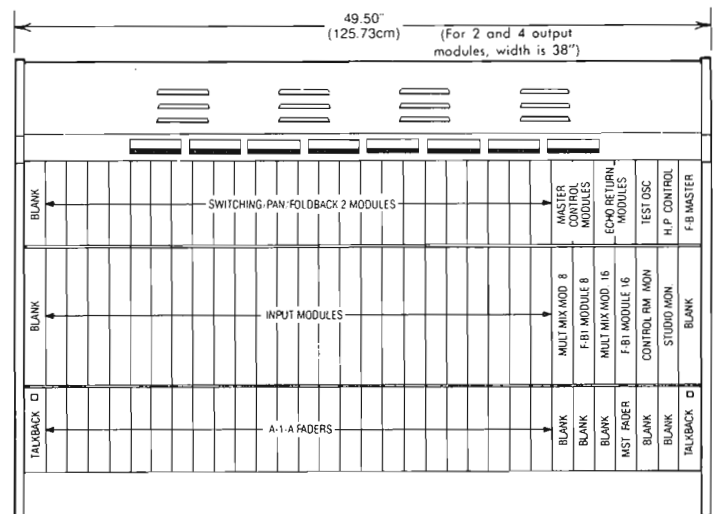

-TOP VIEW-

M90-8SM STUDIO MONITOR MODULE—8 CHANNEL. Provides same functions as M90-SM module, but used only with 8 channel output console. (740-0228-000.)

M90-HPC STEREO HEADPHONE CONTROL MODULE. Contains headphone level control and 6 position pushbutton switches, permitting headphone monitoring of: control room monitor, SOLO, foldback 1 and 2, and auxiliary inputs. (740-0218-000.)

M90-FM4 FOUR CHANNEL FOLDBACK #1 AND MONITOR MIX MODULE. This module is employed mainly in overdub recording where it is necessary to feed the performer a foldback mix from up to four sources at a different mix ratio than the control room operator. (740-0217-000.)

M90-8FB1/8 FOLDBACK 1 MIX MODULE. (740-0231-000.)

M90-8FB1/16 FOLDBACK 1 MIX MODULE. (740-0232-000.)

M90-8MM8 MONITOR MIX MODULE. (740-0233-000.)

M90-8MM16 MONITOR MIX MODULE. (740-0234-000.)

The four modules above perform the same function as the M90-FM4, but apply to 8 channel output operation.

SPECIAL PURPOSE MODULES

M90-TO TEST OSCILLATOR MODULE—2/4 CHANNEL OUTPUT. This module provides 8 fixed frequency sine waves from 50 Hz to 15 kHz for level setting plus a pushbutton operated 30 Hz slate tone. The output may be directed by pushbutton switches to any one or all of the mixing busses. (740-0220-000.)

M90-8TO TEST OSCILLATOR MODULE—8 CHANNEL OUTPUT. Performs same function as M90-TO module, but applies to 8 channel output operation. (740-0235-000.)

M90-ERM ECHO RETURN ASSIGN MODULE PROGRAM AND MONITOR—2/4 CHANNEL OUTPUT. This module allows the assignment of the echo return (delayed audio, reverb or special effects) to any one or all of the mixing busses. Echo return may also be directed only to the monitor circuit. Echo master gain control and pan control is also included. (740-0205-000.)

M90-8ERM ECHO RETURN ASSIGN MODULE PROGRAM AND MONITOR—8 CHANNEL OUTPUT. Performs same function as M90-ERM module, but applies to 8 channel output operation. (740-0229-000.)

HARRIS' M90 MODULAR AUDIO

ORDER NO.	TYPE NO.	DESCRIPTION	M90-2/18	M90-4/18	M90-4/26	M90-8/24
740-0201-000	M90-2MF	2 Channel Output Main Frame* ¹	✓			
740-0305-000	M90-2MFX	2 Channel Output Main Frame with XLR Connectors* ¹	✓			
740-0202-000	M90-4MF	4 Channel Output Main Frame (18 input pos. max.)* ¹		✓		
740-0306-000	M90-4MFX	4 Channel Output Main Frame (18 Pos.) with XLR Connectors* ¹		✓		
740-0225-000	M90-4MFS	4 Channel Output Main Frame (26 input pos. max.)* ¹			✓	
740-0307-000	M90-4MFSX	4 Channel Output Main Frame (26 Pos.) with XLR Connectors* ¹			✓	
740-0226-000	M90-8-MF	8 Channel Output Main Frame* ^{1, *2}				✓
740-0308-000	M90-8MFX	8 Channel Output Main Frame with XLR Connectors* ^{1, *2}				✓
740-0213-000	M90-SPF2	2 Channel Buss Assign & Pan Module w/Foldback #2	✓			
740-0214-000	M90-SSM2	Stereo Switching Module—2 Channel	✓			
740-0210-000	M90-SPF4	4 Channel Buss Assign & Pan Module w/Foldback #2		✓	✓	
740-0211-000	M90-SSM4	Stereo Switching/Buss Assign Module—4 Channel		✓	✓	
740-0203-000	M90-CRM	Control Room Monitor Module* ³	✓	✓	✓	
740-0204-000	M90-SM	Studio Monitor Module* ³	✓	✓	✓	
740-0205-000	M90-ERM	Echo Return Assign Module Pgm & Monitor* ⁴	✓	✓	✓	
740-0206-000	M90-1ME	Input Module with 3 Section Equalizer	✓	✓	✓	✓
740-0207-000	M90-1M	Input Module—No Equalizer	✓	✓	✓	✓
740-0208-000	M90-S1M	Stereo Line Level Input Module—No Equalizer	✓	✓	✓	✓
740-0215-000	M90-A1A	Linear Motion Mono Fader* ⁶	✓	✓	✓	✓
740-0216-000	M90-A2	Linear Motion Stereo Fader	✓	✓	✓	✓
740-0217-000	M90-FM4	4 Channel Foldback #1 & Monitor Mix Module	✓	✓	✓	✓
740-0218-000	M90-HPC	Stereo Headphone Control Module	✓	✓	✓	✓
740-0219-000	M90-A30	Plug-in Line Output Amplifier Card	✓	✓	✓	✓
740-0220-000	M90-T0	Test Oscillator Module	✓	✓	✓	✓
740-0310-000	M90-TBS	Talkback/Slate Switch Module	✓	✓	✓	✓
740-0236-000	M90-B	Input Position Blank Panel Kit* ⁵	✓	✓	✓	✓
740-0227-000	M90-8-CRM	Control Room Monitor Module* ³				✓
740-0228-000	M90-8-SM	Studio Monitor Module* ³				✓
740-0229-000	M90-8-ERM	Echo Return Assign Module Pgm & Monitor* ⁴				✓
740-0230-000	M90-8-SPF8	8 Channel Buss Assign & Pan Module w/Foldback 2 Mix				✓

NOTES

*¹Each main frame includes floor stand, housing, external power supply with phantom (48V) microphone power, master control module talkback switch, program line amplifiers, master faders, VU meters, logic circuits; completely wired for maximum number of inputs.

*²Includes M90 30/MS Power Supply, eleven A30 Line Amp. Cards, MC4 & MC8 Master Control Modules and FBM Foldback Master Control Module.

CONSOLE ORDERING INFORMATION

ORDER NO.	TYPE NO.	DESCRIPTION	M90-2/18	M90-4/18	M90-4/26	M90-8/24
740-0323-000	M90-8-HPC	8 Channel Stereo Headset Control Module				✓
740-0309-000	M90-8-SSM	8 Channel Stereo Buss Assign Module				✓
740-0231-000	M90-8-FB1/8	Foldback 1 Mix Module (Ch. 1 thru 8)				✓
740-0232-000	M90-8-FB1/16	Foldback 1 Mix Module (Ch. 9 thru 16)				✓
740-0233-000	M90-8-MM8	Monitor Mix Module (Ch. 1 thru 8)				✓
740-0234-000	M90-8-MM16	Monitor Mix Module (Ch. 9 thru 16)				✓
740-0235-000	M90-8-T0	Test Oscillator Module				✓
740-0237-000	M90-VU	Extra VU Meter Installed When Console Built	✓	✓	✓	✓
740-0313-000	M90-VUB	VU Meter w/Buffer Amp. Installed at time of manufacture	✓	✓	✓	✓
740-0314-000	M90-VUP	VU Meter w/Peak Indicator Installed at time of manufacture	✓	✓	✓	✓
740-0238-000	M90-TRC	Tape Transport Remote Control	✓	✓	✓	✓
740-0239-000	M90-PB	Plug-in Patch Bay—Inc. Desk Top Cabinet	✓	✓	✓	✓
740-0241-000	M90-EX6	6" Extender Module	✓	✓	✓	✓
740-0242-000	M90-EX9	9" Extender Module	✓	✓	✓	✓
740-0243-000	M90-30-MS	Spare Power Supply (115 or 230 Volt)	✓	✓	✓	✓
740-0263-000	M90-DC	Digital Clock Mounted in Console	✓	✓	✓	✓
740-0264-000	M90-DT	Digital Timer Mounted in Console	✓	✓	✓	✓
740-0265-000	M90-QS	Cue Speaker and Amplifier Mounted in Console	✓	✓	✓	✓
740-0315-000	M90-15AM	4 Pos. Input Selector Module - Mono	✓	✓	✓	✓
740-0316-000	M90-154TM	4 Pos. Input Selector - Mono - Mounted in Tray	✓	✓	✓	✓
740-0317-000	M90-15AS	4 Pos. Input Selector Module - Stereo	✓	✓	✓	✓
740-0318-000	M90-154TS	4 Pos. Input Selector - Stereo - Mounted in Tray	✓	✓	✓	✓
740-0311-000	M90-ABP2T	2 Channel Transformer Isolated Plug-in Amp. - Line Level	✓			
740-0312-000	M90-AMP-2	2 Channel Transformer Isolated Plug-in Amp. - Mic Level	✓			
740-0319-000	M90-0MM	4 Channel to Mono Mix Down Module		✓	✓	
740-0320-000	M90-5-PS	4 Channel Program Output On/off Switch Module		✓	✓	
740-0321-000	M90-PSM	4 Channel Program Output Solo Module		✓	✓	
740-0322-000	M90-BMS	8 Channel Mono Mix Down Module				✓
250-0288-000		Patch Cord for use with M90-PB patch bay. Switchcraft "Tini-telephone" patch cord type TT-/742; 1 ft. long, 2 conductor shielded with tip-ring sleeve plug, Type TT-253, on each end.	✓	✓	✓	✓

NOTES

*³Requires one Model M90-A30 Line Amp. for each of 2 Outputs. If only

Mono Monitoring is used, one Model M90-A30 is sufficient.

*⁴Requires one Model M90-A30 as Line Amp.

*⁵One Blank Kit required for each unused input position.

*⁶Must be used with Model M90-SIM Stereo Input Module.

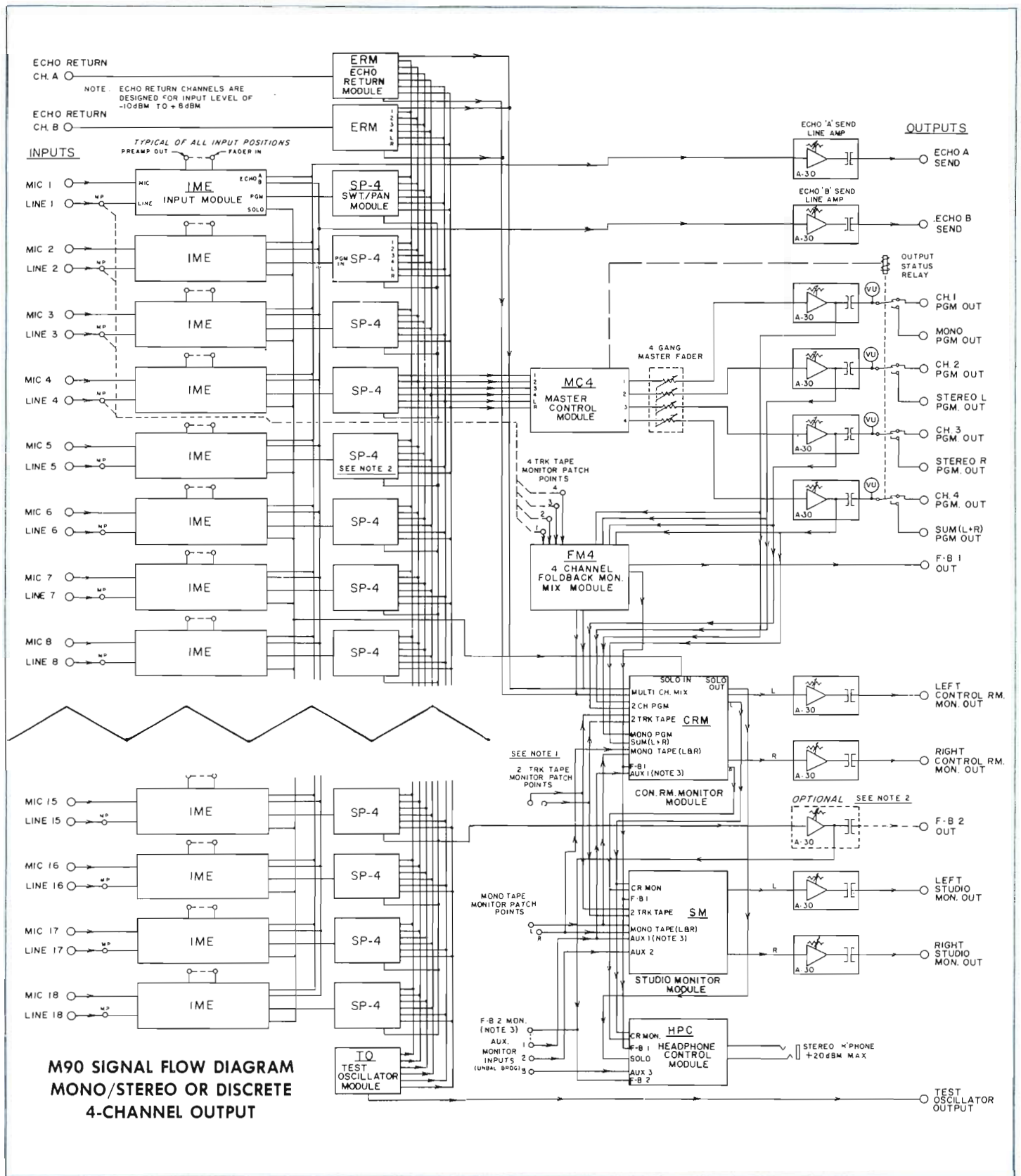



HARRIS
COMMUNICATION AND
INFORMATION PROCESSING

M90

Modular Audio On-Air Console

- Program stereo output, Audition stereo output, plus selectable PGM or AUD sum channel
- Simple stereo bus assign pushbutton switches
- Monitor selector switches for typical broadcast functions (PGM, AUD, AIR, etc.)
- Multiple studio speaker muting
- Available with 18 or 26 input channels
- Incorporates most of the features of the M90 two, four and eight output channel consoles

The Harris M90 ON-AIR audio console is an extremely versatile, highly flexible dual stereo modular unit with a selectable sum channel output. The console is available with an 18 or 26 input mainframe to mount the plug-in modules required for your operation. Except for the output bus switching and monitoring modules, most of the standard M90 modules can be installed in your M90 ON-AIR console to customize your board to your exact requirements.

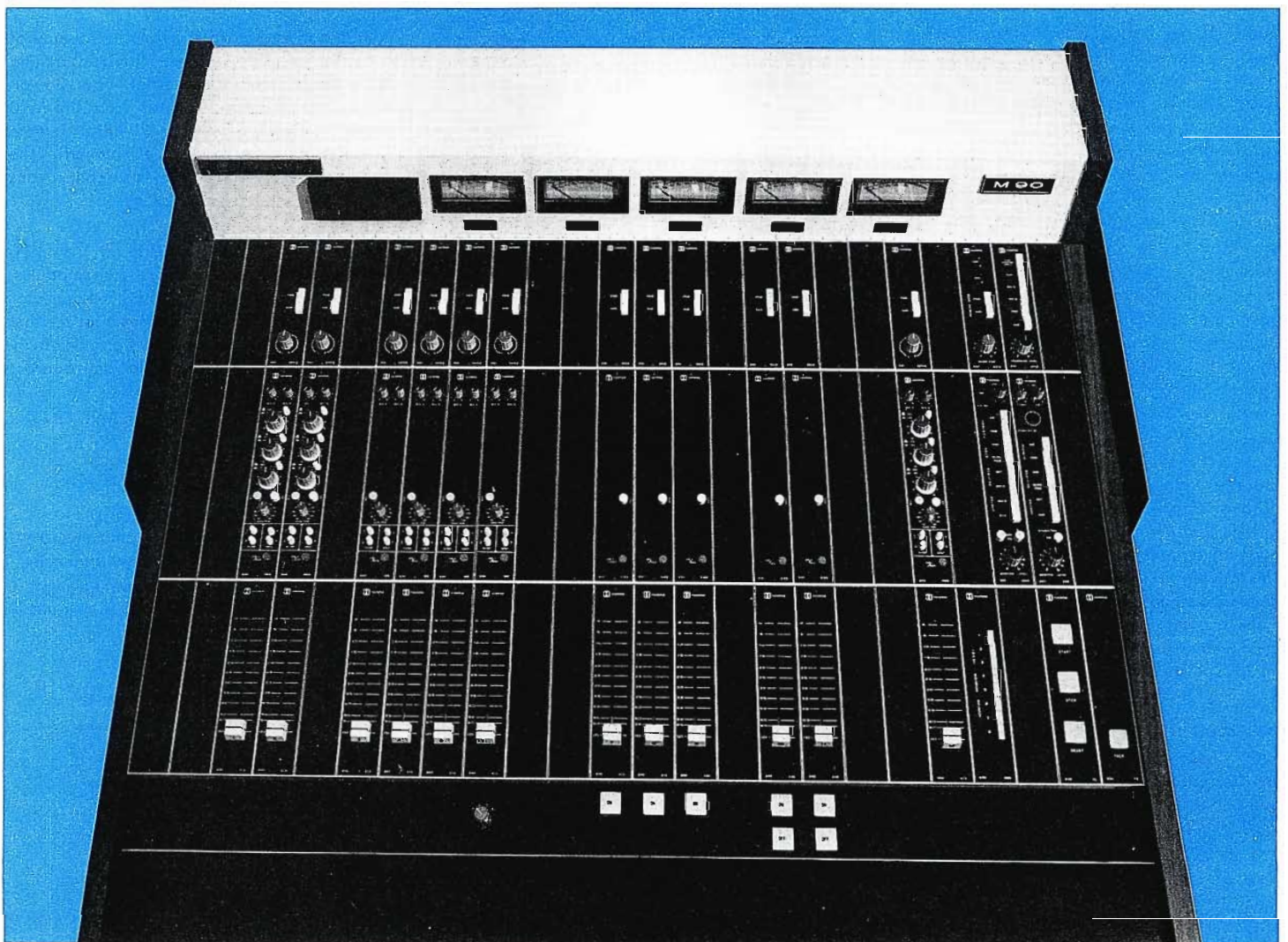

Designed specifically for on-air use, the modules described below feature simplified switching and ease of operation. The additional modules needed to complete your on-air console configuration are covered in our eight-page M90 Modular Audio Control Console brochure.

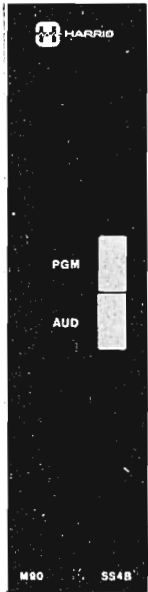

M90-SS4B



M90-SSP4B

The M90-SS4B PGM/AUD Bus Assign Module is used in stereo input channels with associated M90-SIM Input and M90-A2A Fader Modules. These three units are required for each stereo input channel. An engaged switch button will release when the other one is actuated on the M90-SS4B Module.

The M90-SSP4B PGM/AUD/PAN Bus Assign Module is similar to the M90-SS4B Module except for the pan pot. This is used to feed a mono input to the stereo output busses, panning the signal from stereo left to center to stereo right. An associated M90-IME or M90-IM Input and M90-A1A Fader Module completes a mono input channel.

The M90-MS4B Master Control Module contains recessed screwdriver adjustable program and audition stereo controls (individual left and right), a pushbutton selector to feed the sum channel from the program or audition outputs, and the sum gain control. The screwdriver pots provide for initial setup and discourage operator changes. The Mono PGM, or sum gain control, can be adjusted by the operator for center buildup and other summing problems.

The M90-HPCB Headphone Control Module has a 6-position input selector with a unique feature on the top pushbutton. This pushbutton interrupts the cue feed into the



M90-MS4B



M90-HPCB

M90-CRMB Module and the control room speaker muting. The second cue position permits normal control room monitoring. Mix A and Mix B are feeds from the optional line amps in the Echo Send A and B circuits.

The M90-CRMB Control Room Monitor Module has the input selectable to console output channels, air feed, network feed and an auxiliary input. Other facilities include: mono or stereo operation; monitor level control; and separate pushbutton switches for on-off operation of left and right control room speakers.

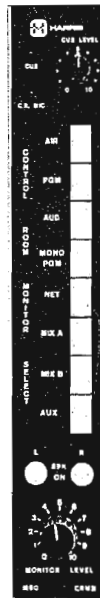

M90-CRMB

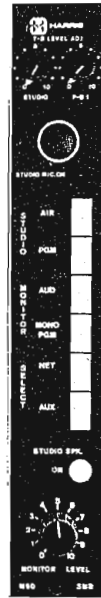

M90-SMB

The M90-SMB Studio Monitor Module has all but Mix A and Mix B inputs appearing on the M90-CRMB Module. It contains a high quality studio talkback microphone that is ac-

tuated by a switch located on the extreme right panel in the fader row. An external talkback microphone may be used if desired. A studio speaker feed ON/OFF switch and LED indicator provide additional operator control. In addition to the studio monitor level control, there are talkback level controls for studio speakers and foldback-1.

The studio talkback feeds into the left studio speaker with appropriate muting control. Foldback-1 is seldom used in an air board, but the feed is available for any special requirement. The Mix A and Mix B outputs may be used for any special requirements as well. They are available from mono input channels only.

Other optional items such as the digital timer, digital clock, cue amplifier and speaker can be obtained in the M90 ON-AIR Console. The cue function in this board replaces the solo function in the other M90 consoles, and the input and monitoring modules have the function designated as "cue" on the module panels. There is no reason to add the cue amplifier and speaker to the M90 consoles unless a different quality of sound is desired for cue than that obtained from the control room monitor speaker. The cue circuits are connected into the left control room speaker in boards without the cue amplifier.

A studio muting card is available for any of the M90 consoles with two individual muting relay driver circuits for external relays. 24-volt power for the relays is taken from the M90 power supply. Several M90-RSM Remote Studio Muting Cards may be mounted in the M90 cabinet with the relay coil connections appearing on rear panel plugs.

The very logical placement of the M90 modules, and the controls on the modules, make this board comfortable for the operator almost immediately after he sees it for the first time. Yet it has all the versatility and flexibility found on highly complicated looking boards.

Improve your operation with an M90 ON-AIR Console!

ORDERING INFORMATION

Order No.	Description
740-0326-000	M90-4MFB Mainframe, 5 VU meters, 18 input channels
740-0336-000	M90-4MFSB Mainframe, 5 VU meters, 26 input channels
740-0327-000	M90-MS4B Module
740-0328-000	M90-SS4B Module
740-0329-000	M90-SSP4B Module
740-0331-000	M90-CRMB Module
740-0332-000	M90-SMB Module
740-0333-000	M90-HPCB Module
740-0330-000	M90-RSM Card



EXECUTIVE

10-Channel Stereo Audio Control Console

- 10 full-stereo mixing channels
- 29 inputs to the mixers
- All solid-state plug-in amplifiers
- Low distortion
- Excellent frequency response
- Provision for plug-in sum channel amplifier

The Executive is one of the most versatile audio consoles available today, offering 29 inputs into 10 full-stereo mixing channels. This highest-quality console offers excellent audio performance, and has built a solid reputation for long-term reliability. In addition, the board layout has been "human engineered" to provide great operating convenience.

MIXING SYSTEM: This ten-channel stereo mixer utilizes low impedance ladder type controls in a parallel, minimum loss type, mixing circuit.

MICROPHONE CHANNELS: Three microphone channels can be individually switched from the front panel to either full stereo operation or fully isolated monophonic feed from one microphone into the stereo mixer. There are two separate preamplifiers in each of the three microphone channels, operated in parallel for stereo use. The second preamplifier is bridged off the first when a single microphone is used to feed the stereo program, simplifying disc jockey, control room or news room microphone insertions.

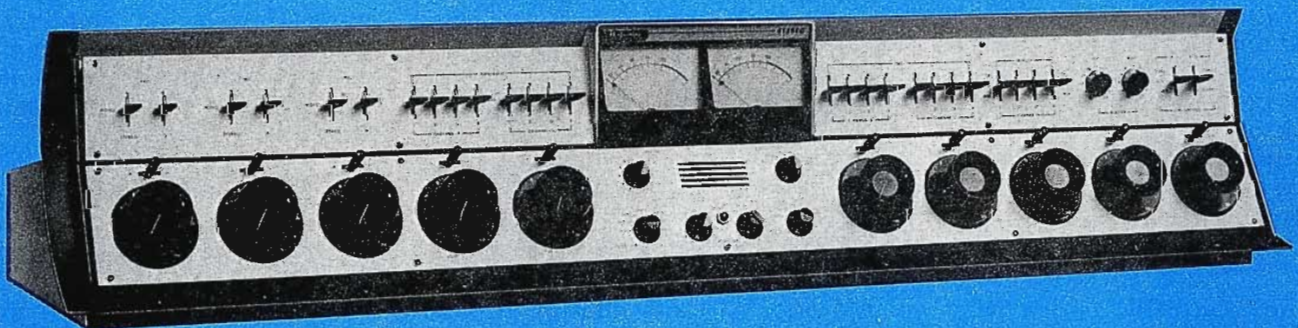

Microphone transfer switches are located immediately above the microphone mixing channels for instantaneous changes in programming requirements. A second switch for each microphone channel allows the selection of two sets of stereo microphones into each of the three channels. This permits the use of six sets of stereo microphones without patching.

TURNTABLE CHANNELS: Channels 4 and 5 have switching to accommodate four turntables into either channel in any sequence. A cue position on these two channels permits cueing in the channel not in use.

TAPE CHANNELS: Channels 6 and 7 have switching to accommodate four tape machines into either channel in any sequence. There is a cue position on channels 6 and 7 to permit previewing and cueing of all recorder material before feeding it to the transmitter.

REMOTE CHANNEL: Four remote lines are switched into channel 8 when mixed into either stereo or monophonic programming. The stereo mixer in channel 8 has a splitting pad on the input to permit feeding a monophonic source to both sides of the stereo mixer.

NETWORK CHANNEL: Channel 9 is the network channel. It is also a stereo mixer with a splitting pad on the input, since most network facilities are monophonic at the present time. Should this condition change, you simply remove the splitting pad and the full stereo facilities are restored. An occasional stereo network program could be patched into one of the stereo channels. A cue position permits previewing the network, then smoothly fading it into the program channel.

AUXILIARY CHANNEL: Channel 10 is the auxiliary channel, with two isolation transformers on the input of the stereo mixer to prevent any interaction or grounding problems with almost any input source.

CUE-INTERCOM SYSTEM: The cue-intercom system provides flawless network monitoring, remote over-

ride, remote talk-back, studio intercom, turntable cueing, tape cueing and general previewing and cueing on all but the microphone channels. The control room and studio speakers are muted by the channel keys and muting relays when there is a live microphone in any of these locations.

The cue signals from channels 4 through 10 are fed into the cue-intercom amplifier regardless of the position of the cue selector switch.

PROGRAM SWITCHING FUNCTIONS: One front panel switch changes the master operation of the Executive console from stereo to simultaneous or separate operation, as desired by the operator. Stereo program busses and stereo audition busses are designated: "Program Left," "Program Right," "Audition Left," and "Audition Right." The "Program Left" bus is permanently connected to the "Master Left" channel.

In the STEREO position, the input of the "Master Right" channel is connected directly to the "Program Right" bus. Thus, each half of the dual attenuators feed through a program amplifier to the stereo output line.

If the optional program amplifier is used during stereo programming, its input is bridged across the output of both the "Master Left" and "Master Right" channels. The output of the optional amplifier is then equal to L+R, the compatible stereo signal, and may be used to feed an AM transmitter.

In the SIMULTANEOUS position, the input of the "Master Right" channel is bridged off the output of the "Master Left" channel. This allows simultaneous programming of an AM and FM transmitter. If the optional program amplifier is used, its input can also bridge the output of the "Master Left" channel for simultaneous feed.

In the SEPARATE position, the input of the "Master Right" channel for the optional program amplifier is connected to the "Audition Left" bus, so

separate programming may be fed to the AM and FM transmitters.

The left hand VU meter is connected to the output of the "Master Left" channel at all times. This is the "Left" channel in stereo programming. The right hand meter can also be switched to the output of the "Master Left" channel for a calibration check. It may also be switched to the output of the "Master Right" channel for stereo metering. In addition, it may be switched to the output of the optional program amplifier to check the level of the compatible stereo, or separate programming, to the AM transmitter. The next position on this switch connects the meter to the network feed to check the level of the network at any time. The last position is for external measurements.

STEREO MONITORING AMPLIFIERS: Two 8 watt amplifiers are built in the Executive for complete stereo monitoring. An input switch on the stereo monitoring amplifiers permits them to be connected to the output of the master channels, the output of the audition bus booster amplifiers, or to an external stereo input. Two sets of muting contacts on each relay permit muting of the stereo speakers—in the control room and the studios. These relays are completely encased, and plug-in for complete reliability and maintenance.

TRANSISTOR AMPLIFIERS: The Executive stereo console is completely transistorized. All amplifiers are plug-in type, with the exception of the stereo monitor amplifiers. The standard amplifier complement consists of:

- 6 preamplifiers (3 pairs for stereo)
- 2 booster amplifiers (1 pair for stereo)
- 2 program amplifiers (1 pair for stereo)
- 2 monitor amplifiers (1 pair for stereo)
- 1 cue-intercom amplifier

In addition, there is the regulated transistorized power supply and provisions for a third compatible program amplifier.

EXECUTIVE CONSOLE

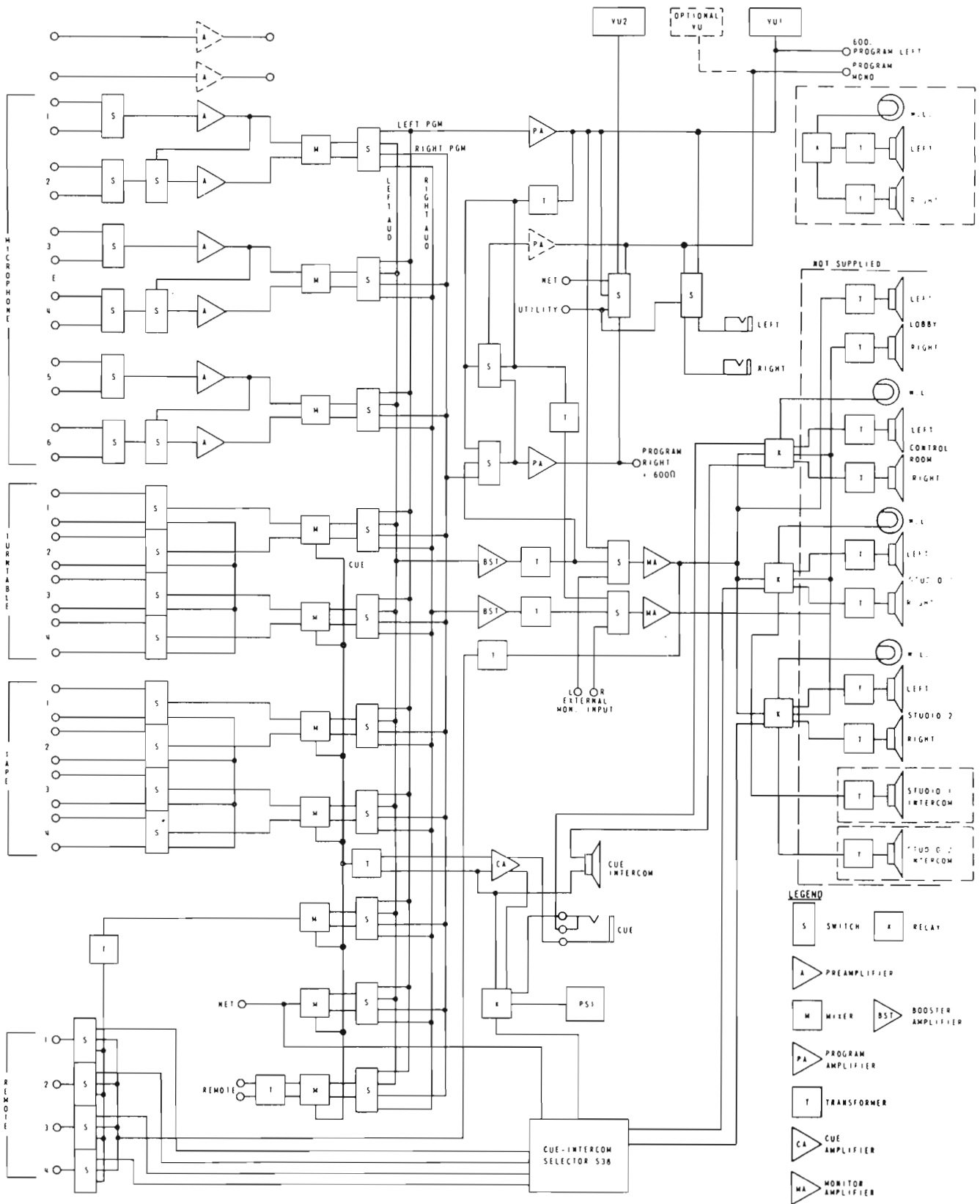

BLOCK DIAGRAM

EXECUTIVE SPECIFICATIONS

MIXING CHANNELS:

10 Full stereophonic each with stereo low impedance ladder attenuator.

INPUTS:

12 Stereo microphones to 6 preamps.
9 Stereo turntables, tape and projector inputs into 5 stereo mixers.
4 Remotes into 1 stereo mixer.
1 Individual stereo network channel.
3 Stereo monitor inputs.

OUTPUTS:

3 Program lines:
2 Stereo program lines—simultaneous or stereo.
1 Monophonic compatible or independent program line.
8 Stereo muted monitor outputs.
2 Stereo unmuted monitor outputs.
4 Stereo recording outputs.
10 or more Stereo speaker outputs.
2 Interlocked studio intercom outputs.
2 Headphone outputs.

AMPLIFIERS:

10 Plug-in transistor preamplifiers.
6 microphone preamplifiers.
2 Optional microphone preamplifiers (where ordered).
2 Booster amplifiers.
3 Plug-in transistor program amplifiers.
2 Program amplifiers feeding stereo/simultaneous outputs.
1 Optional compatible or independent.
1 Plug-in transistor cue/intercom amplifier.
2 Full level transistor monitor amplifiers with ganged level controls.

POWER SUPPLY:

1 Full regulated, electronically protected transistor power supply.

GAIN:

Microphone to program line: 102 dB \pm 2 dB, Turntable/tape/projector/remote to program line: 56 dB, \pm 2 dB.
Turntable/tape/projector/remote to speaker output: 70 dB.

FREQUENCY RESPONSE:

(Typical) \pm 1.5 dB from 20 to 20,000 Hz in all regular program circuits.
 \pm 1.0 dB from 30 to 15,000 Hz in all regular program circuits.
(Typical) \pm 2.0 dB from 20 to 20,000 Hz in all monitor speaker circuits.
 \pm 1.5 dB from 30 to 15,000 Hz in all monitoring speaker circuits.

HARMONIC DISTORTION:

(Typical) 0.5% Maximum, 20 to 20,000 Hz at +8 dBm output in all regular program circuits.
0.5% maximum, 30 to 15,000 Hz at +8 dBm output in all regular program circuits.
0.5% maximum, 50 to 15,000 Hz at +18 dBm output in all regular program circuits.
(Typical) 1.0% Maximum, 20 to 20,000 Hz at +38 dBm in all monitor speaker circuits.
1.0% maximum, 50 to 15,000 Hz at +39 dBm (8 watts) in speaker outputs.

INTERMODULATION DISTORTION:

(Typical) 0.5% maximum, 20 to 20,000 Hz at +8 dBm output in all regular program circuits.
0.5% maximum, 30 to 15,000 Hz at +8 dBm output in all regular program circuits.
(Typical) 0.5% maximum, 20 to 20,000 Hz at +18 dBm output in all regular program circuits.
0.5% maximum, 30 to 15,000 Hz at +18 dBm output in all regular program circuits.
(Typical) 1.0% maximum, 20 to 20,000 Hz at +38 dBm in all monitor speaker circuits.
1.0% maximum, 50 to 15,000 Hz at +39 dBm (8 watts) in all monitor speaker circuits.

SOURCE IMPEDANCE:

Microphones—30/50 or 150/250 ohms.
Turntable/tape/projector/remote/network—600 ohms.

LOAD IMPEDANCE:

All program lines—600 ohms.
Speaker outputs—4 to 16 ohms.
Recording outputs—600 ohms.

NOISE:

—122 dBm equivalent input noise—microphone to program line.

CROSSTALK:

Below noise level in all channels.

STEREO ISOLATION:

Below noise level in all channels.

TRANSISTOR COMPLEMENT:

10 Industrial type totaling 76.

POWER CONSUMPTION:

Approximately 50 watts at 110/117/125 volts, 50/60 Hz.

SIZE & WEIGHT:

53½" long, 11½" high and 17½" deep. 107 lbs. net wt., 220 lbs. domestic, 270 lbs. export, 27 cu. ft.

FINISH:

Satin anodized black nomenclature on natural anodized aluminum background panels, white cabinet, blue trim.

SPECIFICATIONS SUBJECT TO CHANGE WITHOUT NOTICE.

ORDERING INFORMATION

Executive 10-channel transistor stereo audio control console, complete with 2 monitor amplifiers, 6 preamplifiers, 2 booster amplifiers, cue-intercom amplifier, 2 program amplifiers and power supply 994-6158-002
Optional preamplifier 994-6034-001
Optional program amplifier 994-5700-003
Speaker matching transformer 478-0291-000
Optional 3rd VU meter 994-6208-001
Intercom sub-station 994-6424-001



HARRIS

COMMUNICATION AND
INFORMATION PROCESSING

STEREO 80 8-Channel Audio Control Console

AUDIO

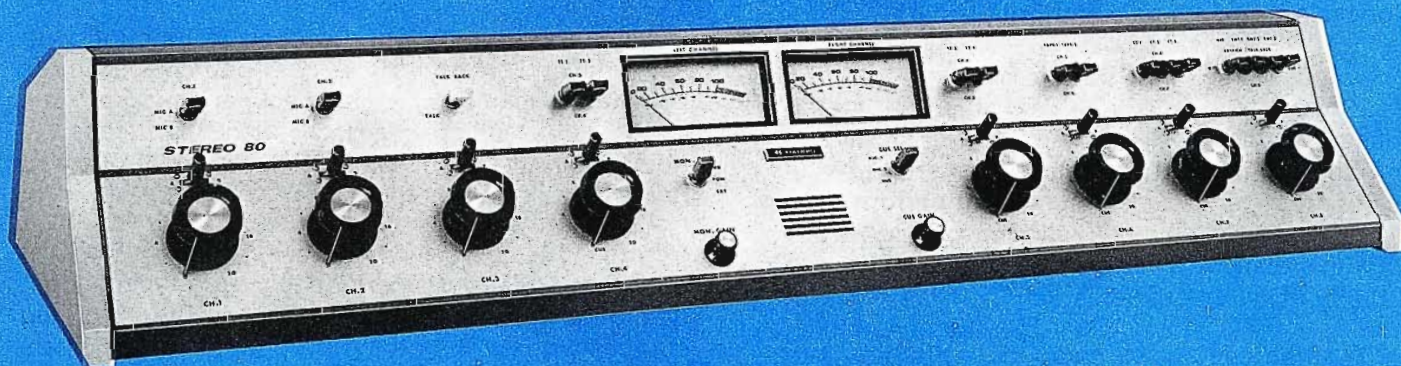

STEREO 80

Eight Channel Stereophonic Transistor Audio Console

FEATURES

- Eight stereo mixing channels
- Eighteen inputs to the mixers
- High program output capability
- Interchangeable cue, monitor and program amplifiers
- Cue amplifier and speaker built in
- All solid state plug-in amplifiers
- Talkback to and from two studios and remote lines, built in
- Excellent frequency response and low distortion
- Audition output for recording
- Concealed master gain controls

Harris' Stereo 80 is designed for the FM stereo broadcaster who is looking for great flexibility and superb audio quality. The console features a wide choice of inputs and such outstanding performance specifications as: frequency response, 20 to 20,000 Hz with less than 1 dB variation; and distortion less than 0.5% at all frequencies.

INPUTS: Eighteen inputs may be switched into eight stereo mixing channels to provide a degree of flexibility that will satisfy virtually any stereo requirement. Inputs include five microphones, four turntables, five tapes (cartridge or reel-to-reel), three remotes and network.

MIXING CHANNELS: Channels 1 and 2 are equipped with low-noise preamplifiers, and are to be used with low-impedance, broadcast-type microphones.

Each of these stereo channels may select from two different pairs of input signals by means of a front-panel switch.

Channel 3 is also equipped with low-noise preamplifiers, and is also intended for use with low-impedance, broadcast type microphones. This channel has a stereo input and is assigned to the control room since these microphones function as part of the talkback system.

Channels 4, 5, 6 and 7 are all medium level inputs and may be used with stereo turntable preamplifiers, reel-to-reel tape, or cartridge machines. All channels have input transformers whose center taps may or may not be grounded, depending upon the given installation. They are shipped with the center taps ungrounded. A nominal level of -20 dBm or $+4$ dBm at 600 ohms is required. Input pads for the $+4$ dBm are provided on the various tape inputs.

Channel 8 is specifically designed to function with network and remote lines as sources. Various combinations of preview, talkback, and program cue are possible using the front panel switches. A nominal input of at least -20 dBm at 600 ohms is required for remotes and -14 dBm for the network.

All eight channels may be switched to either the program or audition positions to permit independent recording and monitoring of any of the incoming sources without disturbing programming. Channels 4 through 8 have a cue position associated with the channel attenuator which provides signal to the amplified cue system. This signal can be monitored by an internal speaker or external headphones. On Channels 1 and 2, the center position of the program audition key switch provides a microphone cue signal to the cue selector switch. On Channel 3 this position is used with the control room microphones for talkback.

SPEAKER MUTING: A protective system of warning lights and relay speaker muting is provided to prevent acoustic feedback and broadcasting of cue signal when “live” microphones are nearby.

AMPLIFIERS: Each solid-state plug-in amplifier is mounted on a separate printed circuit board, which in turn mounts in a card-rack holder. These modules are as follows: six preamplifier modules, five booster amplifier modules, five output amplifier modules and one power supply regulator panel. Silicon transistors are used to assure the meeting of performance specifications and assure optimum console operation over a wide ambient temperature range. All amplifiers are completely accessible when the top of the console is opened, simplifying maintenance.

Program, cueing and monitor amplifiers all have the same electrical design and construction, and are interchangeable. As a result, two backup program amplifiers are provided as part of the console.

HIGH LEVEL, HIGH FIDELITY OUTPUT: The dynamic range of the preamplifiers will accommodate microphone levels to -17 dBm without overload or distortion. The program amplifiers deliver $+32$ dBm output and the monitor amplifiers $+40$ dBm, all with wide frequency response, low distortion and low noise.

STYLING: The Stereo 80 is handsomely styled with satin anodized aluminum front panels, and white Pebble-Tex cabinet. The modern design will complement any control room decor.

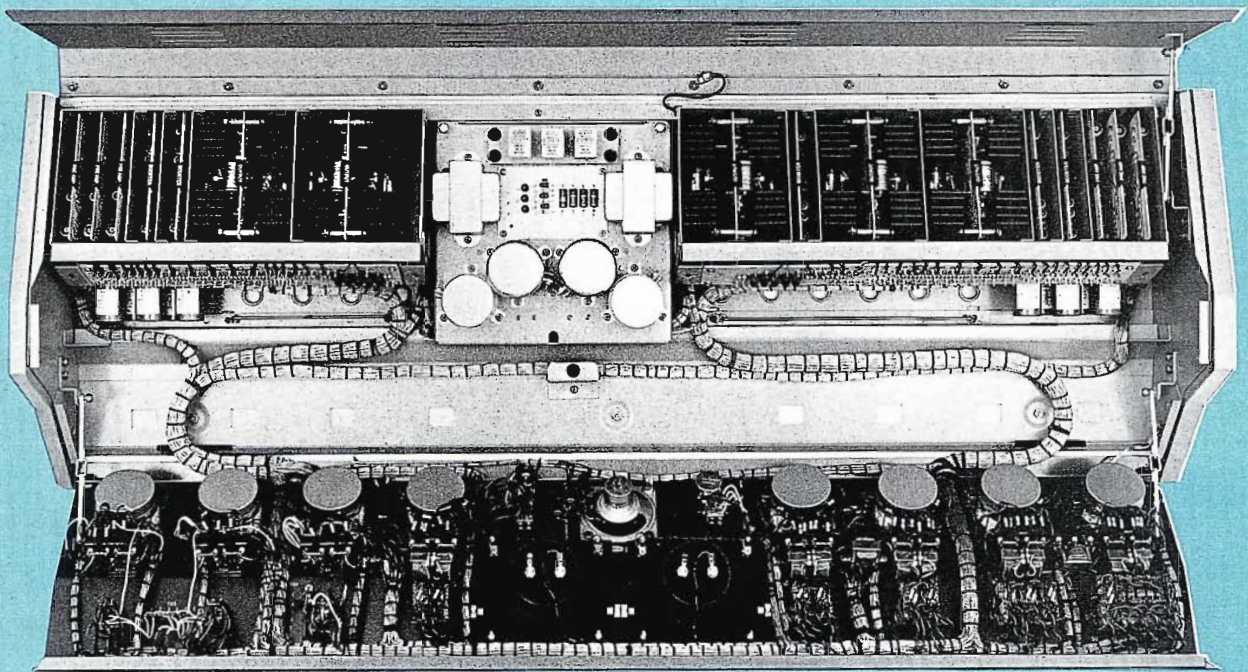

The hinged top of the Stereo 80 raises and the front panel lowers to provide easy access to all console components. The plug-in modular components are easily removed for service.

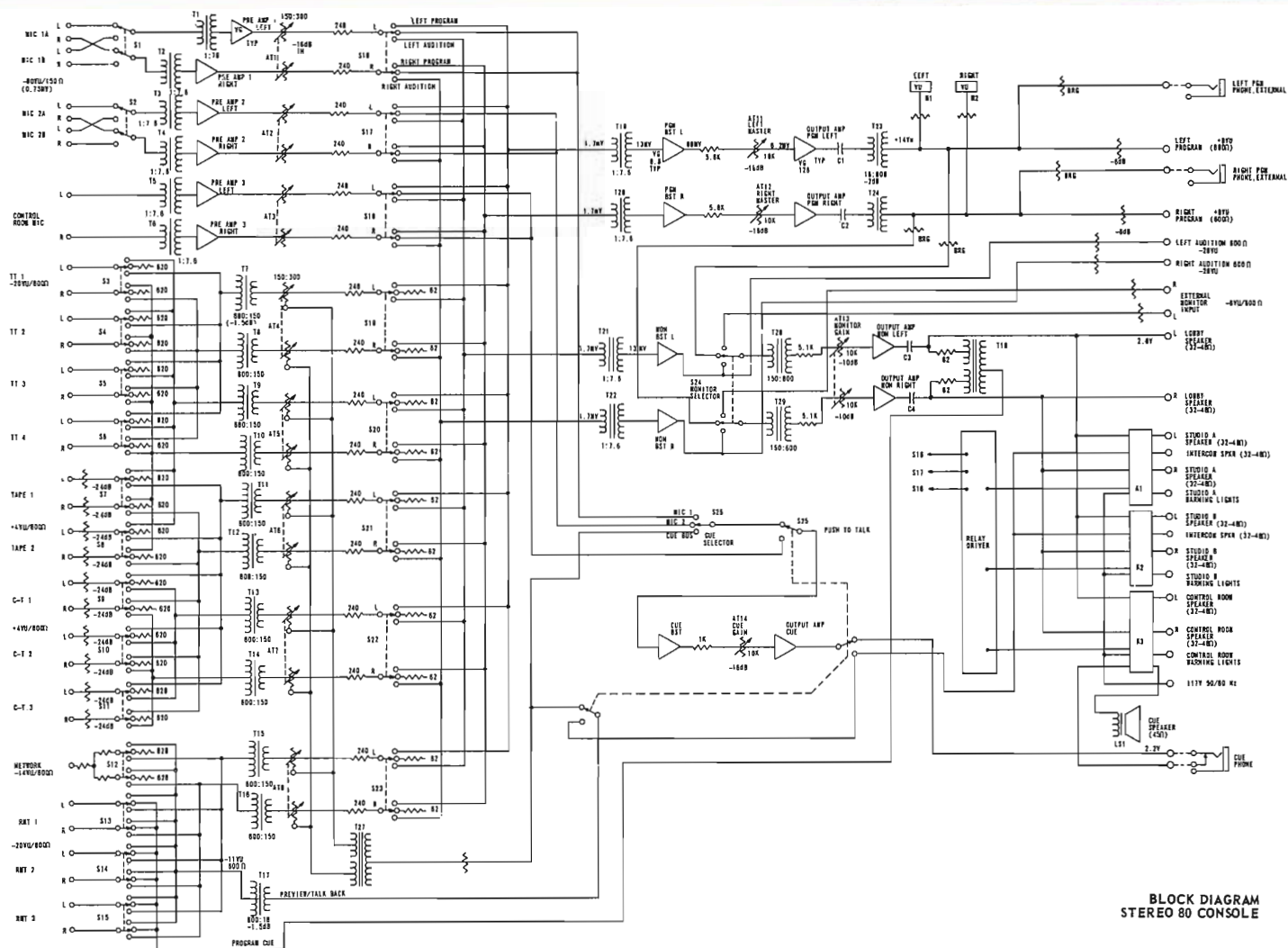

BLOCK DIAGRAM
STEREO 80 CONSOLE

Specifications

Operating Mode: Single output stereo programming with audition positions.

Mixing Channels: Total—8. Three for microphones, two for turntables, two for tapes and one for remote/network.

Input Circuits: Total—18. Five stereo pairs of microphones, four turntables, two tape machines, three cartridge tape machines, three remote lines and one mono network.

Amplifiers and Power Supplies Provided: Six preamplifiers, five boosters, five output modules—program, monitor and cue (interchangeable as supplied). One rack-mount power supply panel.

Output Circuits: One stereo program output @ +8 VU, one stereo audition output @ -26 VU, one monitor speaker pair unmuted for lobby, three monitor speaker pairs muted, one mono and one stereo headphone output.

Monitor Outputs: +40 dBm @ 8 ohm minimum load. Multi-speaker operation should use high impedance speakers (32-45 ohm) or accessory speaker-matching transformer (48/8 ohm) for minimum load of 8 ohms.

Gain: Microphone to line: 100 dB, ± 2 dB. Medium level to line: 60 dB/36 dB, ± 2 dB.

Impedances: Microphones: 150/250 ohms balanced. Turntable/tape: 600 ohms balanced. Network/remote: 600

ohms balanced. Monitor output: 8 ohms normal unbalanced. Program output: 600/150 ohms balanced. Audition output: 600 ohms built out.

Response: Program: ± 1.0 dB, 20 Hz to 20 kHz. Monitor: 1.0 dB, 30 Hz to 15 kHz.

Distortion: Program circuits: 0.5% maximum, 20 Hz to 20 kHz @ +18 dBm. Monitor circuits: 1.0% maximum, 30 Hz to 15 kHz @ +40 dBm (10 watts).

Noise: Program circuits: 75 dB below +18 dBm with -50 dBm input (-125 dBm equivalent input noise, measured 20 Hz to 20 kHz). Medium level inputs: (program) 78 dB below +18 dBm with -10 dBm input. Monitor circuits: signal/noise = 78 dB below +40 dBm output.

Finish: Satin anodized aluminum panels with lettering in black. Cabinet color... white Pebble-Tex.

Power: 117/234 volts, 50/60 Hz, single-phase. Consumption: 120 watts, maximum.

Mechanical Size: (Console) 45" wide, 15 $\frac{3}{4}$ " deep, 7 $\frac{3}{4}$ " high. Weight: 105 lbs. (Power supply panel) 19" wide, 7 $\frac{3}{4}$ " deep, 7" high. Weight: 21 lbs.

Shipping Data: Packed weight: domestic, 210 lbs.; export, 250 lbs. Cubage: 19 cubic feet.

Ordering Information

Stereo 80 eight channel stereo console, complete with six preamplifiers; five boosters; five program/monitor/cue output modules (interchangeable); and one power supply panel. .994-6867-001
Speaker matching transformer. .478-0291-000



HARRIS

COMMUNICATION AND
INFORMATION PROCESSING

STEREO 5

Solid-State 5-Channel Stereo Audio Control Console

- Thirteen inputs into five stereo mixing channels
- Compact size saves control room space
- Quiet "push-on/push-off" input switches
- Extensive use of integrated circuits
- All solid state... silicon transistors
- Great versatility at a modest price

Harris' Stereo 5 is a solid-state, stereophonic audio control console that provides a high degree of flexibility through the use of thirteen inputs into five mixing channels. Although compact in size, and economical in price, the Stereo 5 offers facilities and performance specifications comparable to many larger, more expensive consoles.

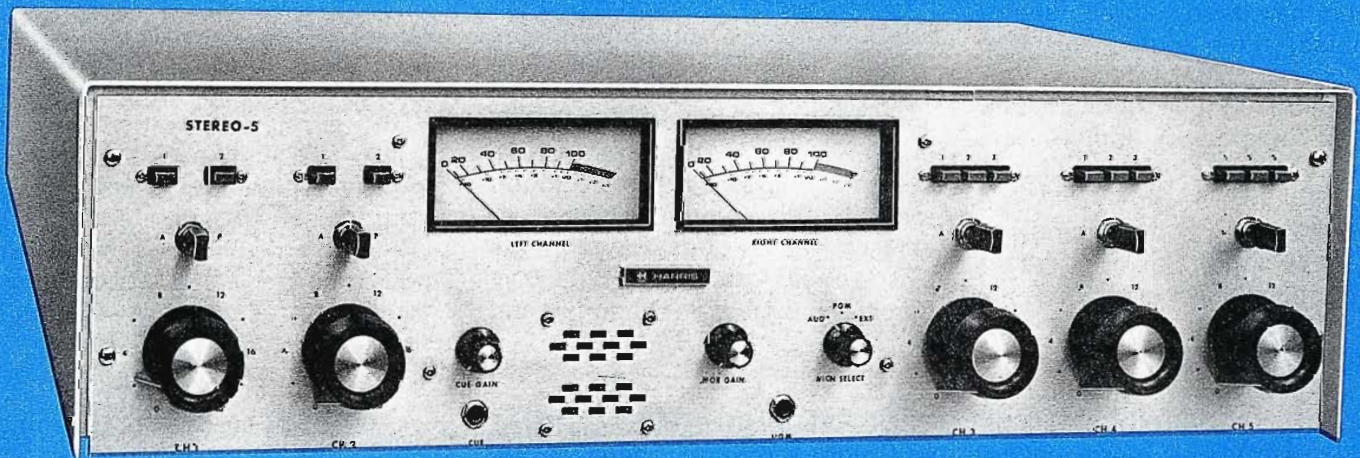

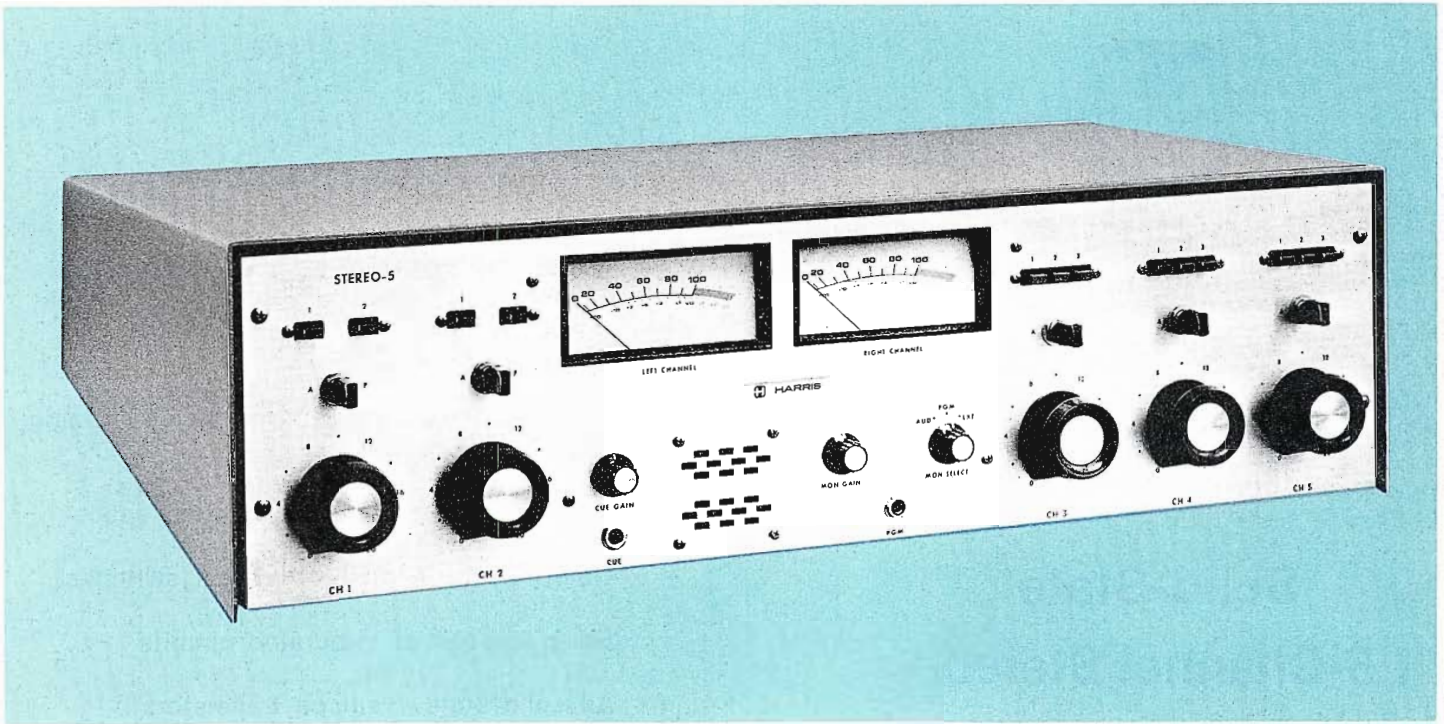

In medium and smaller size FM stereo stations, the Stereo 5 is ideal as a main console. In larger stations, the Stereo 5 will find application as a production console, or may be used for independent programming from a second facility.

VERSATILE INPUT SWITCHING:

Thirteen inputs can be switched into the five mixing channels in a manner to satisfy most stereo programming requirements. These inputs can include four stereo microphone pairs, three stereo turntables, three stereo cartridge reproducers, one stereo reel-to-reel reproducer, one network and one auxiliary stereo source. The thirteen front panel input switches are of the "push-on/push-off" type for quiet control room operation. There are isolation transformers on all program inputs and outputs.

MICROPHONE CHANNELS (1 & 2):

These two channels are equipped with low-noise preamplifiers for use with low-impedance, broadcast-type microphones. Each of these channels may select from two different input signals by use of front panel switches.

MEDIUM LEVEL CHANNELS (3, 4 & 5): These three channels are designed for medium level inputs and may be used with turntables, cartridge tape machines, or reel-to-reel machines. Remote, network or auxiliary sources may be assigned to any of the nine medium level inputs.

PROGRAM, AUDITION AND CUE SELECTION:

Any of the five mixing channels may be switched to the Program Channel or Audition to permit independent monitoring or recording of incoming sources without disturbing programming. Channels 3, 4 and 5 also have cue positions, which provide signal to the amplified cue system. This signal can be monitored by an internal speaker or external headphones. Switching is by telephone-grade lever-type keys that provide maximum durability and reliability.

PROGRAM CHANNELS: The left and right program channels are identical--each consisting of a summing type booster amplifier, audio output amplifier, VU meter, and a master gain control. The

master gain control, an internal adjustment, is preset at the factory to provide 16 dB of reserve gain for the console, and is the optimum setting for providing adequate operating margins of signal-to-noise and "headroom". The 4-inch VU meters are standard volume indicators and are used in conjunction with the mixing channel attenuators to establish a reference volume of "0" VU, which is equivalent to an output level of +8 dBm.

ADDITIONAL FACILITIES:

A three-position monitor selector switches the monitoring amplifier input to (1) program circuit, (2) terminals for an external source, and (3) audition circuit. Front panel controls also include monitor gain and cue gain, and conventional high impedance cue and program headset jacks for stereophonic headphones are provided.

A protective system of warning lights and speaker muting is included in the Stereo 5 to prevent acoustic feedback and broadcasting of a cue signal when live microphones are nearby.

STEREO 5 FUNCTIONAL DIAGRAM

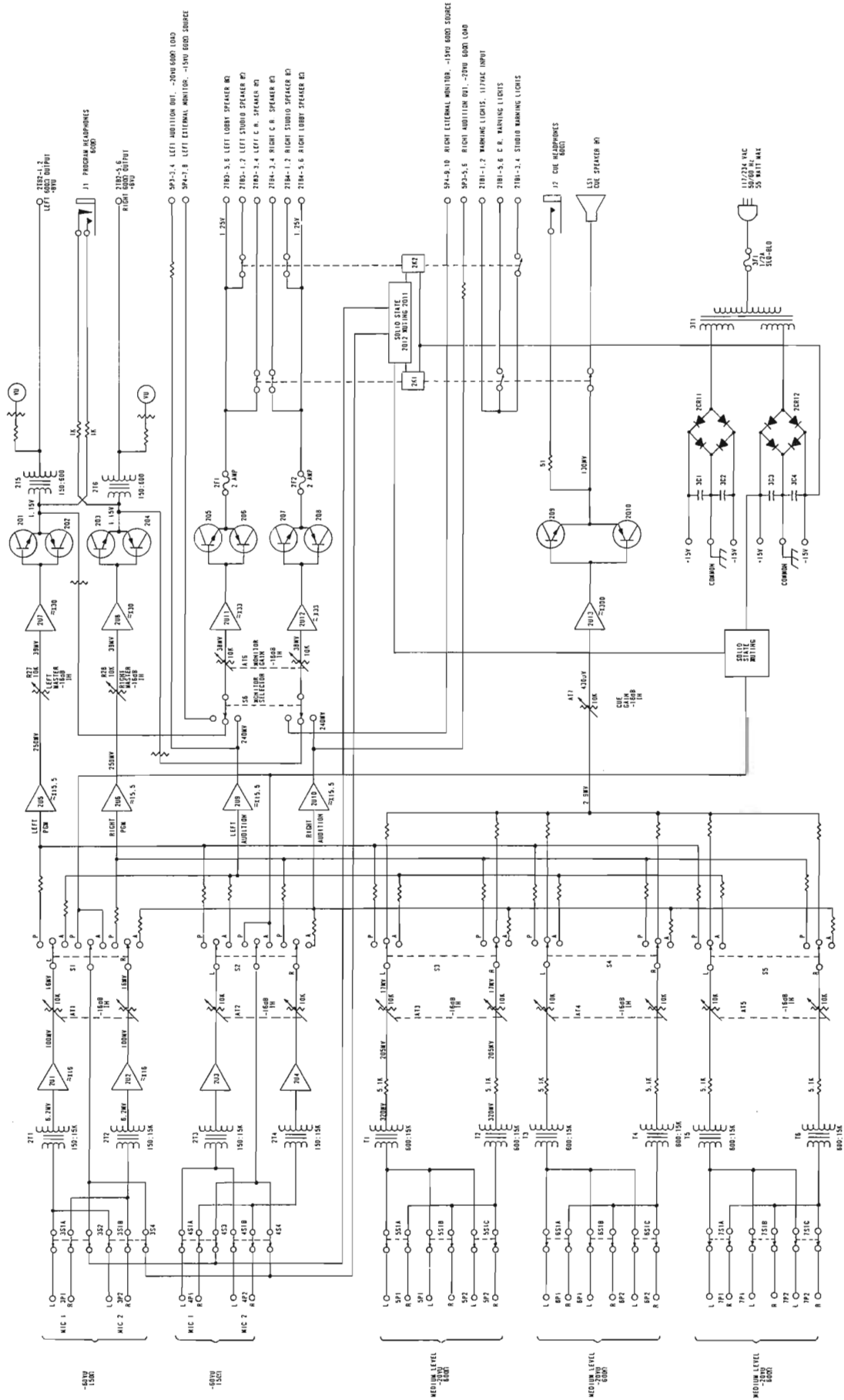

2. DC VOLTAGES ARE WITH LEFT SIGNAL ONLY
 1. AC VOLTAGES SHOWN ARE AT 1,000 Hz.

NOTES:

STEREO 5 SPECIFICATIONS

OPERATING MODE: Single-channel, stereophonic.

MIXING CHANNELS: Total-5. Two microphone channels, three medium level (turntable, tape, remote, network) channels. Cue positions on medium level channel switches.

INPUT CIRCUITS: Total-13. Four microphone inputs, nine medium level (turntable, tape, remote, network) inputs.

OUTPUT CIRCUITS: Total-5. Program, audition, two muted monitor for control room and studio, one unmuted monitor for lobby.

AMPLIFIERS AND POWER SUPPLY: Four pre-amplifiers, two program, one cue and two monitor amplifiers. Self-contained power supply.

IMPEDANCES: Microphones: 150/600 ohms, balanced. Medium level: 150/600 ohms, balanced. Program output: 150/600 ohms, balanced. Audition output: 1,400 ohms maximum. Monitor outputs: 8 ohms nominal. Audition and monitor outputs are unbalanced.

GAIN: Microphone input to line output: 100 dB, ± 3 dB. Medium level input to line

output: 60 dB, ± 3 dB. Medium level input to monitor output: 80 dB, ± 4 dB.

RESPONSE: Program circuits: ± 1 dB, 30-15,000 Hz. Monitor circuits: ± 1.5 dB, 30-15,000 Hz.

DISTORTION: Program circuits: 0.5% maximum @ ± 8 dBm; 1.0% maximum @ ± 18 dBm output level, 30-15,000 Hz. Monitor circuits: 3.0% maximum @ 6 watts output level (lobby output only).

NOISE: Program circuits: at least 70 dB below + 18 dBm output with -50 dB input to mic channels or -10 dBm input to medium level channels. Monitor circuits: at least 70 dB below 6 watts output level with same input levels.

FINISH: Beige-gray Pebble-Tex cabinet, natural aluminum front panel.

POWER: 117/234 volts, $\pm 10\%$, 50/60 Hz, single phase, 55 watts maximum.

SIZE: 30 inches long, 8½ inches high, 17½ inches deep (76.2 cm x 21.6 cm x 44.5 cm).

WEIGHT: 44 pounds (20 kg).

SHIPPING DATA: Packed weight, domestic, 54 pounds; export, 104 pounds (47.2 kg).

ORDERING INFORMATION

Stereo 5, five-channel stereophonic audio console, complete with preamplifiers, program amplifiers, cue amplifier, monitor amplifiers, and self-contained power supply 994-7691-001



HARRIS
COMMUNICATION AND
INFORMATION PROCESSING

GATESWAY 80

8-Channel Solid-State Audio Control Console

- Eight monaural mixing channels
- Eighteen inputs to the mixers
- Extremely low distortion
- Interchangeable cue, monitor and program amplifiers
- All solid state plug-in amplifiers
- Excellent frequency response
- User serviceability

The Gatesway 80 combines excellent audio, a wide choice of inputs, and operating ease in a unit which is attractively and functionally styled.

This is a high-quality monophonic console which provides all necessary studio functions and facilities for the typical AM, FM, or TV station that broadcasts monophonic programs exclusively.

INPUTS. The flexibility of the Gatesway 80 is in its wide choice of inputs. Eighteen inputs can be switched into eight mixing channels. These include five microphones, four turntables, five tapes (cartridge or reel-to-reel), three remotes and network.

MIXING CHANNELS. Channels 1 and 2 are equipped with low-noise preamplifiers, and are to be used with low-impedance, broadcast-type microphones. Each of these channels may select from two different input signals by means of a front-panel switch.

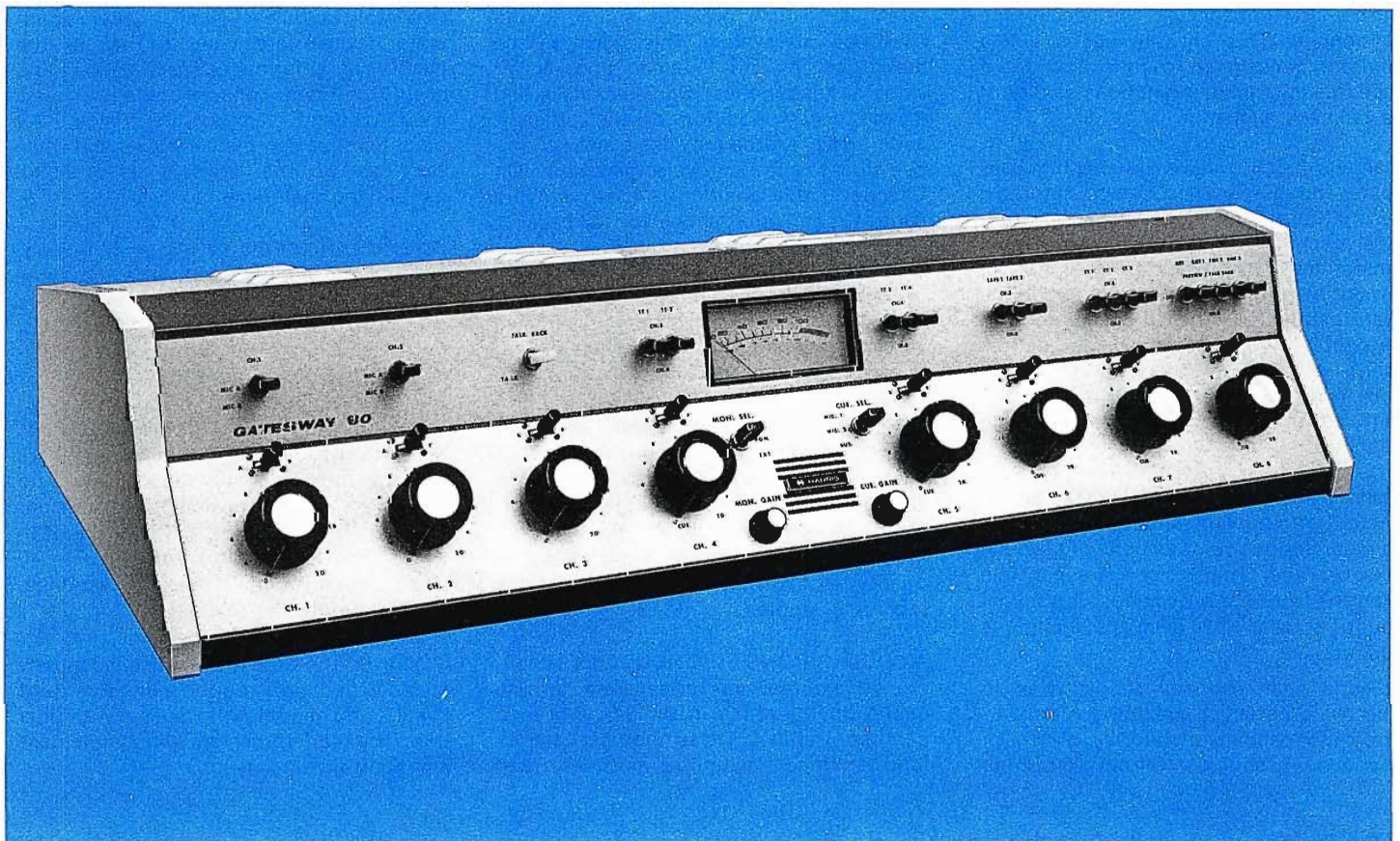

WIDE CHOICE OF INPUTS, UNSURPASSED SOUND

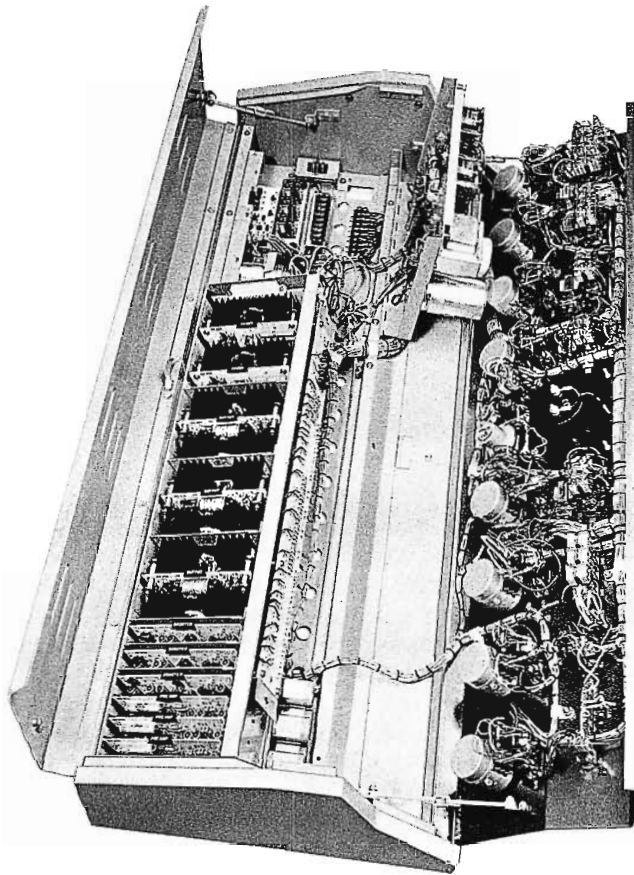

SERVICEABILITY

Full service accessibility to the Gatesway 80 is through the hinged cabinet cover and panel. All plug-in modular components are easily removed for service.

Channel 3 is equipped with a low-noise preamplifier and is also intended for use with a low-impedance, broadcast-type microphone. This channel has a single input and is assigned to the control room since this microphone functions as part of the talkback system.

Channels 4, 5, 6 and 7 are all medium level inputs and may be used with turntable preamplifiers, reel-to-reel tape, or cartridge machines. All channels have input transformers whose center taps may or may not be grounded, depending upon the given installation. They are shipped with the center taps ungrounded. A nominal level of -20 dBm or $+4$ dBm at 600 ohms is required. Input pads for the $+4$ dBm are provided on the various tape inputs.

Channel 8 is specifically designed to function with network and remote lines as sources. Various combinations of preview, talkback, and program cue are possible using the front panel switches. A nominal input of at least -20 dBm at 600 ohms is required.

All eight channels may be switched to either the program or audition positions to permit independent monitoring of any of the incoming sources without disturbing

programming. Channels 4 through 8 have a cue position associated with the channel attenuator which provides signal to the amplified cue system. This signal can be monitored by an internal speaker or external headphones. On Channels 1 and 2, the center position of the program audition key switch provides a microphone cue signal to the cue selector switch. On Channel 3 this position is used with the control room microphone for talkback.

SPEAKER MUTING. A protective system of warning lights and relay speaker muting is provided to prevent acoustic feedback and broadcasting of cue signal when "live" microphones are nearby.

UNSURPASSED AUDIO. Harris advanced all solid state plug-in amplifiers are one of the many reasons for the excellence of the Gatesway 80. Audio response is excellent, and distortion is at an extremely low level. The Gatesway 80 provides first-class audio quality for AM, FM, TV broadcasting, and recording studios.

MODULAR CONSTRUCTION. Each amplifier is mounted on a separate printed circuit board, which in turn mounts in a card-rack holder. These modules are as follows: three preamplifier modules, three

booster amplifier modules, three output amplifier modules and two power supply regulator modules. High quality solid-state devices are used to assure the meeting of performance specifications and assure optimum console operation over a wide ambient temperature range. All amplifiers are completely accessible when the top of the console is opened, simplifying maintenance.

INTERCHANGEABILITY. Program, cueing, and monitor amplifiers all have the same electrical design and construction, and are completely interchangeable. As a result, two backup program amplifiers are provided as part of the console.

HIGH LEVEL, HIGH FIDELITY OUTPUT. The dynamic range of the preamplifiers will accommodate microphone levels to -17 dBm without overload or distortion. The program amplifiers deliver $+32$ dBm output and the monitor amplifiers $+40$ dBm, all with wide frequency response, low distortion and low noise.

STYLING. The Gatesway 80 is handsomely styled with satin-anodized aluminum front panels, and neutral white cabinet with blue trim. The modern design will complement any control room decor.

GATEWAY 80 BLOCK DIAGRAM

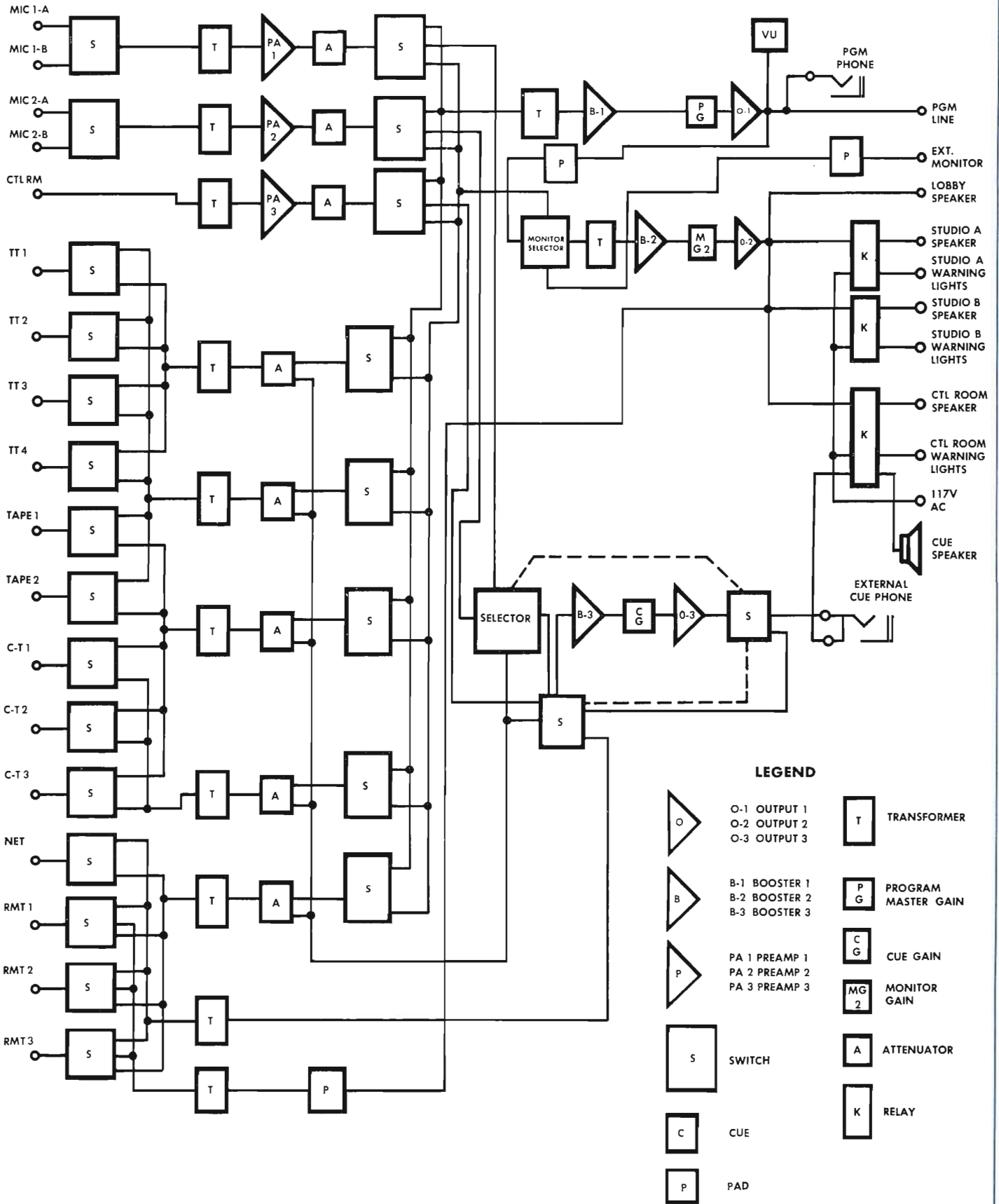

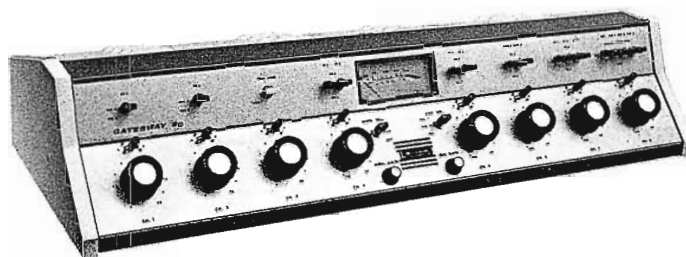

GATESWAY 80 SPECIFICATIONS

OPERATING MODE: Single channel mono with audition positions.

MIXING CHANNELS: Total—8. Three microphones, two turntables, two tapes and one remote/network.

INPUT CIRCUITS: Total—18. Five microphones, four turntables, two tape machines, three cartridge tape machines, three remote lines, one network.

AMPLIFIERS AND POWER SUPPLIES PROVIDED: Three preamplifiers, three boosters, three output modules—program, monitor and cue (interchangeable as supplied). Two power supply modules.

OUTPUT CIRCUITS: One program output @ +8 VU, one monitor speaker output unmuted for lobby, three monitor speakers muted, two headphone outputs.

MONITOR OUTPUT: +40 dBm @ 8 ohm minimum load. Multi-speaker operation should use high-impedance speakers (32-45 ohms) or accessory speaker matching transformer (48/8 ohms) for minimum load of 8 ohms.

GAIN: Microphone to line: 100 dB \pm 2dB. Medium level to line: 60 dB \pm 2 dB.

IMPEDANCES: Microphones: 150/250 ohms balanced. Turntable/tape: 600 ohms balanced. Network/remote: 600 ohms balanced. Monitor output: 8 ohms unbalanced.

RESPONSE: Program: \pm 1.0 dB, 20 Hz to 20 kHz.
Monitor: \pm 1.0 dB, 30 Hz to 15 kHz.

DISTORTION: Program circuits: 0.5% maximum, 20 Hz to 20 kHz @ +18 dBm.
Monitor circuits: 1.0% maximum, 30 Hz to 15 kHz @ +40 dBm (10 watts.)

NOISE: Program circuits: 75 dB below +18 dBm with -50 dBm input (-125 dBm equivalent input noise, measured 20 Hz to 20 kHz). Medium level inputs: (program) 80 dB below +18 dBm with -10 dBm input. Monitor circuits: signal/noise = 80 dB below -40 dBm output.

FINISH: Satin-anodized aluminum panels with lettering in black. Cabinet color . . . neutral white, blue trim.

POWER: 117/234 volts, 50/60 Hz, single-phase. Consumption: 60 watts, maximum.

MECHANICAL SIZE: 39 inches wide, 15 $\frac{3}{4}$ inches deep, 7 $\frac{3}{4}$ inches high. Weight: 88 lbs.

SHIPPING DATA: Packed weight: domestic, 120 lbs.; export, 170 lbs. Cubage: 12.8 cubic feet (domestic).

SPECIFICATIONS SUBJECT TO CHANGE WITHOUT NOTICE

ORDERING INFORMATION

Gatesway 80, eight channel console, complete with three preamplifiers; three boosters; three program/monitor/cue output modules (interchangeable) and two power supplies994-6699-001
Speaker Matching Transformer478-0291-000



HARRIS
COMMUNICATION AND
INFORMATION PROCESSING

MONO 5

Solid-State 5-Channel Audio Control Console

- Thirteen inputs into five mixing channels
- Compact size saves control room space
- Quiet “push-on/push-off” input switches
- Extensive use of integrated circuits
- All solid state . . . silicon transistors
- Great versatility at a modest price

Harris' Mono 5 is a solid-state audio control console that provides a high degree of flexibility through the use of thirteen inputs into five monaural mixing channels. Although compact in size, and economical in price, the Mono 5 offers facilities and performance specifications comparable to many larger, more expensive consoles.





In medium and smaller size AM and monaural FM stations, the Mono 5 is ideal as a main console. In larger stations, the Mono 5 will find application as a production console, or may be used for independent programming from a second facility.

VERSATILE INPUT SWITCHING:

Thirteen inputs can be switched into the five mixing channels in a manner to satisfy most programming requirements. These inputs can include four microphones, three turntables, three cartridge reproducers, one reel-to-reel reproducer, one network and one auxiliary source. The thirteen front panel input switches are of the "push-on/push-off" type for quiet control room operation. There are isolation transformers on all program inputs and outputs.

MICROPHONE CHANNELS (1 & 2):

These two channels are equipped with low-noise preamplifiers for use with low-impedance, broadcast-type microphones. Each of the channels may select from two different input signals by use of front panel switches.

MEDIUM LEVEL CHANNELS (3, 4 & 5): These three channels are designed for medium level inputs and may be used with turntables, cartridge tape machines, or reel-to-reel machines. Remote, network or auxiliary sources may be assigned to any of the nine medium level inputs.

PROGRAM, AUDITION AND CUE SELECTION:

Any of the five mixing channels may be switched to the Program Channel or Audition to permit independent monitoring or recording of incoming sources without disturbing programming. Channels 3, 4 and 5 also have cue positions, which provide signal to the amplified cue system. This signal can be monitored by an internal speaker or external headphones. Switching is by telephone-grade lever-type keys that provide maximum durability and reliability.

PROGRAM CHANNEL: The program channel consists of a summing type booster amplifier, audio output amplifier, VU meter, and a master gain control. The master gain control, an internal adjust-

ment, is preset at the factory to provide 16 dB of reserve gain for the console, and is the optimum setting for providing adequate operating margins of signal-to-noise and "headroom". The 4-inch VU meter is a standard volume indicator, and is used in conjunction with the mixing channel attenuators to establish a reference of "0" VU, which is equivalent to an output level of +8 dBm.

ADDITIONAL FACILITIES:

A three-position monitor selector switches the monitoring amplifier input to (1) program circuit, (2) terminals for an external source, and (3) audition circuit. Front panel controls also include monitor gain and cue gain, and conventional high impedance cue and program headset jacks are provided.

A protective system of warning lights and speaker muting is included in the Mono 5 to prevent acoustic feedback and broadcasting of a cue signal when live microphones are nearby.

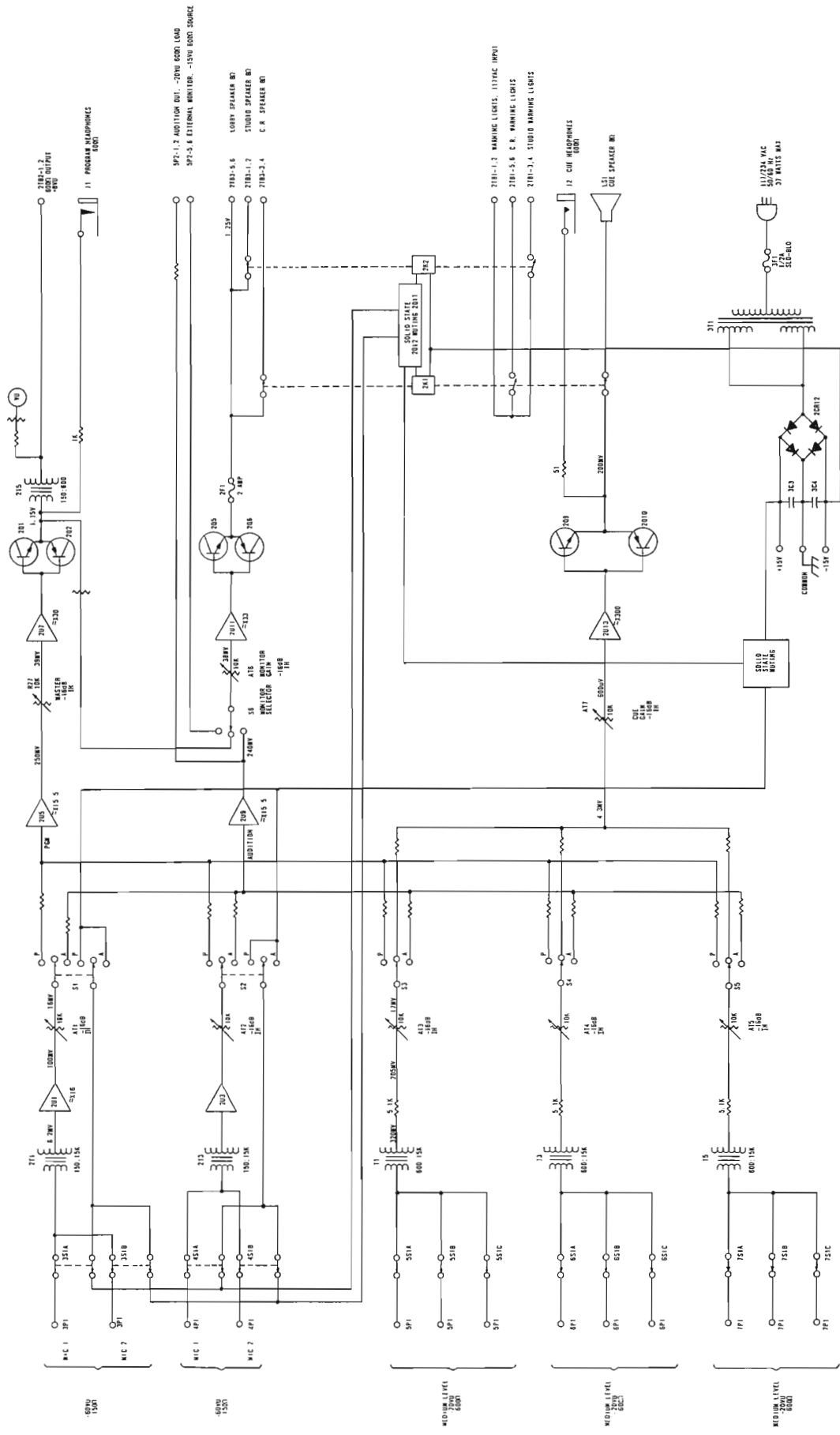

NOTES:
1. AC VOLTAGES SHOWN ARE AT 1,000 HZ.

MONO 5 SPECIFICATIONS

OPERATING MODE: Single channel, monophonic.

MIXING CHANNELS: Total-5. Two microphone channels, three medium level (turntable, tape, remote, network) channels. Cue positions on medium level channel switches.

INPUT CIRCUITS: Total-13. Four microphone inputs, nine medium level (turntable, tape, remote, network) inputs.

OUTPUT CIRCUITS: Total-5. Program, audition, two muted monitor for control room and studio, one unmuted monitor for lobby.

AMPLIFIERS AND POWER SUPPLY: Two pre-amplifiers, one program, one cue and one monitor amplifier. Self-contained power supply.

IMPEDANCES: Microphones: 150/600 ohms, balanced. Medium level: 150/600 ohms, balanced. Program output: 150/600 ohms, balanced. Audition output: 1,400 ohms. Monitor outputs: 8 ohms nominal. Audition and monitor outputs are unbalanced.

GAIN: Microphone input to line output: 100 dB, ± 3 dB. Medium level input to line output: 60 dB, ± 3 dB. Medium level input to monitor output: 80 dB, ± 4 dB.

RESPONSE: Program circuits: ± 1 dB, 30-15,000 Hz. Monitor circuits: ± 1.5 dB, 30-15,000 Hz.

DISTORTION: Program circuits: 0.5% maximum @ +8 dBm; 1.0% maximum @ +18 dBm output level, 30-15,000 Hz. Monitor circuits: 3.0% maximum @ 6 watts output level (lobby output only).

NOISE: Program circuits: at least 70 dB below +18 dBm output with -50 dB input to mic channels or -10 dBm input to medium level channels. Monitor circuits: at least 70 dB below 6 watts output level with same input levels.

POWER: 117/234 volts, $\pm 10\%$, 50/60 Hz, single phase, 37 watts maximum.

FINISH: Beige-gray Pebble-Tex cabinet, natural aluminum front panel.

SIZE: 30 inches long, 8½ inches high, 17½ inches deep (76.2 cm x 21.6 cm x 44.5 cm).

WEIGHT: 41 pounds (18.6 kg).

SHIPPING DATA: Packed weight, domestic, 51 pounds; export, 101 pounds (45.8 kg).

ORDERING INFORMATION

Mono 5, five-channel monaural audio console, complete with preamplifiers, program amplifier, cue amplifier, monitor amplifier, and self-contained power supply..... 994-7699-001



HARRIS
COMMUNICATIONS AND
INFORMATION HANDLING

MSP-100

Audio Processor for AM/FM/TV

- Insures maximum signal power with minimum distortion
- Replaces six to eight separate processors
- Automatic audio processing
- Asymmetrical limiting to achieve 125% positive peak modulation for AM
- Switch selection of all operating parameters for tailoring sound to station format
- Expandable to FM stereo by adding plug-in modules

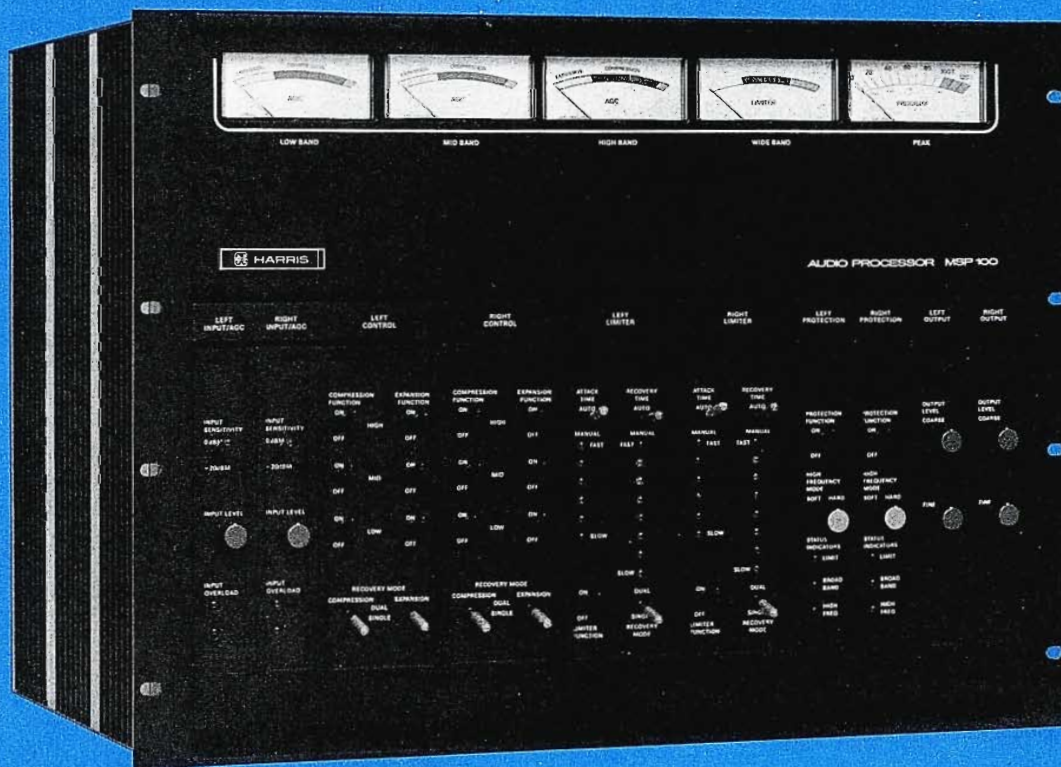

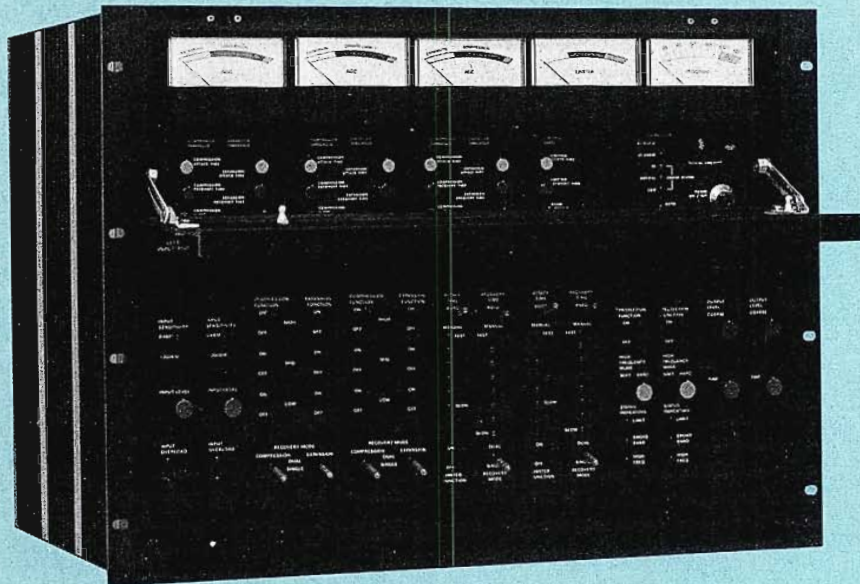

MSP-100, SHOWING METER MODULE CONTROLS.

The Harris MSP-100 Audio Processor is an extremely flexible audio control package offering new control concepts and unequalled versatility. It is designed to allow the highest possible modulation levels, with minimum distortion. This single unit incorporates a tri-band AGC and broadband peak limiter with pre-emphasis compensation to permit unparallelled "tailoring" of sound to station format.

The modular construction assures flexibility in initial installation and in future additions. An FM monaural unit is converted to stereo operation simply by plugging in "right channel" modules. No critical calibration adjustments are required.

All audio circuitry employs linear integrated circuit amplifiers with no discrete transistors, reflecting the state-of-the-art approach to circuit design.

INPUT SELECTION. An active instrumentation-type input circuit permits balanced or unbalanced input without modification. Problems normally associated with transformer inputs relative to frequency response, low-frequency distortion and transients are eliminated.

An input sensitivity switch (20 dB) and a further fine adjustment range of 20 dB allow control of input level to the AGC section over a 40 dB range.

AGC SECTION. Three AGC circuits process separate segments of the audio spectrum independently. Operational parameters, including frequency bandwidths, thresholds and shapes, and attack/recovery times, are variable to user tastes in each band. Variation of parameters directly affects the output spectral distribution—the characteristic "sound" of the processed signal. The AGC module may be quickly set for use as a gentle AGC, spectral equalizer, fast parallel split-band compressor, or anything in between.

Confusion in operational adjustment is minimized by the extensive use of selector switches rather than potentiometers. High and low crossover frequencies are adjustable to any one of seven frequencies each. Attack and recovery times of expansion and compression have five different periods each per band. The dual recovery mode expands the range of recovery times to ten per band. Expansion and compression thresholds may be adjusted in-

dependently in each band. Exclusive crossover compensation assures frequency response free from sharp peaks or dips under both dynamic and static conditions.

The gain controlling element is a monolithic four-quadrant multiplier operating in the two-quadrant mode, assuring optimum noise and distortion performance. Exact tracking between bands and between left and right stereo channels is inherent in the circuits used.

Metering modules are located above the main signal card frame and contain most operating parameter adjustment switches. One module is used per band. Meter circuitry can be switched to monitor left or right band control signal or the greater of the two. In stereo operation, the greater of left or right controls the gain of both sections.

LIMITER SECTION. A broadband fast limiter controls transient peaks and summation errors present in the output of the tri-band AGC. The unit analyzes program content and automatically selects optimum attack and recovery time constants. Automatic attack time selection minimizes transient intermodulation of restricted-bandwidth signals during limiting. Automatic recovery time selection optimizes the degree of dynamic range reduction to the nature of the program signal.

A two-quadrant multiplication technique similar to that employed in the AGC section is used to control limiter gain. Automatic attack circuitry analyzes the signal density in six separate frequency bands and selects faster attack times when significant high frequency energy is present. Automatic recovery is based on the detection of syllabic rate. Pulsing signals, such as voice, have a waveform envelope containing many more pulses per second than smooth signals, such as certain musical selections. Recovery time is selected by a limited bandwidth pulse counter to eliminate extreme recovery selection errors on very rapid pulses such as drum rolls.

Attack and recovery times are monitored by LED status indicators. Manual selection of attack and recovery times is available over a range of five values for each, with dual recovery available in both manual and automatic modes. Stereo strapping of limiters is easily connected and disconnected. An expanded scale meter indicates limiting over a 12 dB range; it can be switched to monitor left limiting, right limiting, or the greater of the two.

FM PROTECTION SYSTEM. High frequency energy can cause significant overdrive conditions in pre-emphasized systems such as FM, TV and SCA broadcasting, and tape recording. Modification of the signal is required to eliminate instantaneous overdrive when high frequencies are present.

A split-spectrum approach is used. Low frequency signal components have little overdrive potential but contribute significantly to signal loudness. High frequency signal components affect overdrive greatly, therefore they are controlled to a far more significant degree than low-frequency signals.

Input signal from the limiter is pre-emphasized and split into two bands above and below 400 Hz. The high frequency band feeds a parallel clamp circuit and fast limiter. The output signal may be adjusted to combine any combination of limited or clamped signal with the unprocessed low-frequency signal. A final broadband clamp circuit controls transient peaks and summation errors. De-emphasis after the clamping sections minimizes audible harmonic distortion. LED's are used to indicate operation of the high frequency limiting and clamping.

AM PROTECTION SYSTEM. To convert from FM to AM, simply replace the FM Protection Module with an AM Protection Module—this is the only change that is needed.

The AM Protection Module works in conjunction with the broadband peak limiter featuring low distortion and low noise. Asymmetrical limiting of the signal is achieved through the use of innovative circuitry to allow 125% positive peak modulation. A polarity reversal circuit,

employing digital detection techniques, reverses polarity only when the program waveform goes through a zero crossing. This assures very rapid, inaudible, switching. Rapid recovery, with minimum low frequency distortion, is provided by a unique integrated circuit which eliminates "holes" produced by conventional delayed recovery distortion reduction techniques.

For operation with transmitters not capable of 125% positive modulation, the positive peak ceiling of the limiter is adjustable from 100% to 133%. LED's are provided on the front panel for readout of polarity and asymmetrical limiting.

OUTPUT AMPLIFIER. State-of-the-art circuitry insures best transient response without the distortion or ringing limitations of transformers. The output amplifier does not use any transformers or transistors whatsoever in providing a 600 ohm balanced output capable of delivering +18 dBm. Integrated circuits are used exclusively. Both coarse and fine output level adjustments are provided.

Output metering circuitry permits observation of peak signal levels both with and without pre-emphasis. Meter sensitivity can easily be changed in precise 2 dB increments. As in the AGC metering modules, left output, right output, or the greater of the two can be switched into the meter.

POWER SUPPLY. The power supply is fully regulated, using a redundant regulation scheme. Failure of a module would not cause the entire unit to cease operation. This is particularly important in stereo broadcasting. Simple integrated-circuit regulators are employed for ease in trouble-shooting. A unique power status monitor indicates deviations in the output of the primary regulators, to quickly locate faults or identify potential problems.

RFI PROTECTION. Since the processor will be located near the transmitter in most installations, special attention has been paid to RFI protection. Each plug-in module has been shielded, grounding of circuitry has been given special attention, extensive use of ground planes on PC boards has been made and filters have been used at critical points.

MECHANICAL. Modular construction allows easy access to all circuit elements. All plug-in modules are easily serviced through the use of an extender card. Metering modules lift out for accessibility and the power supply is easily accessed by removing the top cover. Ease of maintenance and an extremely clean appearance have been achieved through the use of a mother board and plug-in card concept. Most maintenance and service is easily performed without removing the unit from its rack.

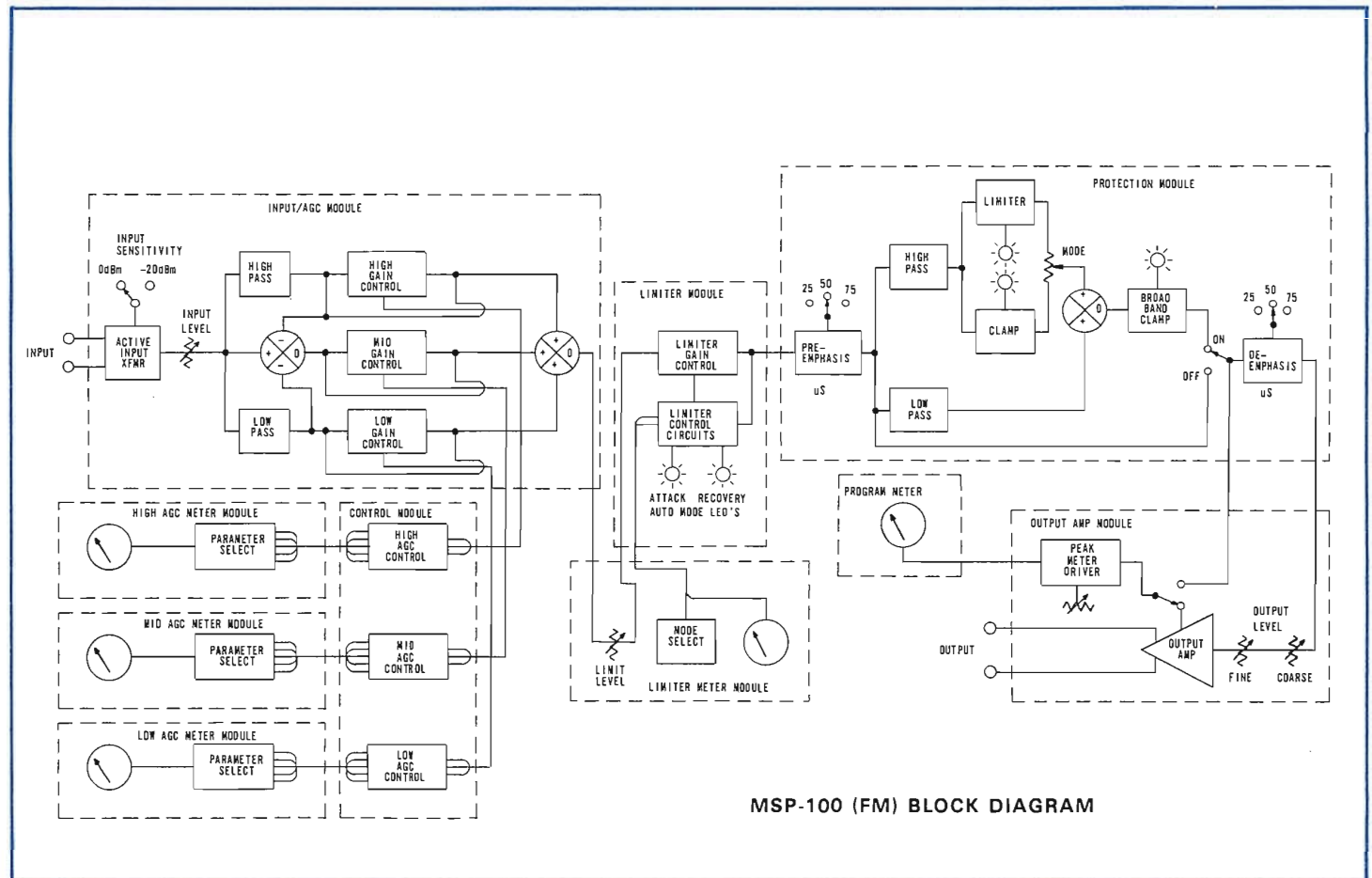

MSP-100 (FM) BLOCK DIAGRAM

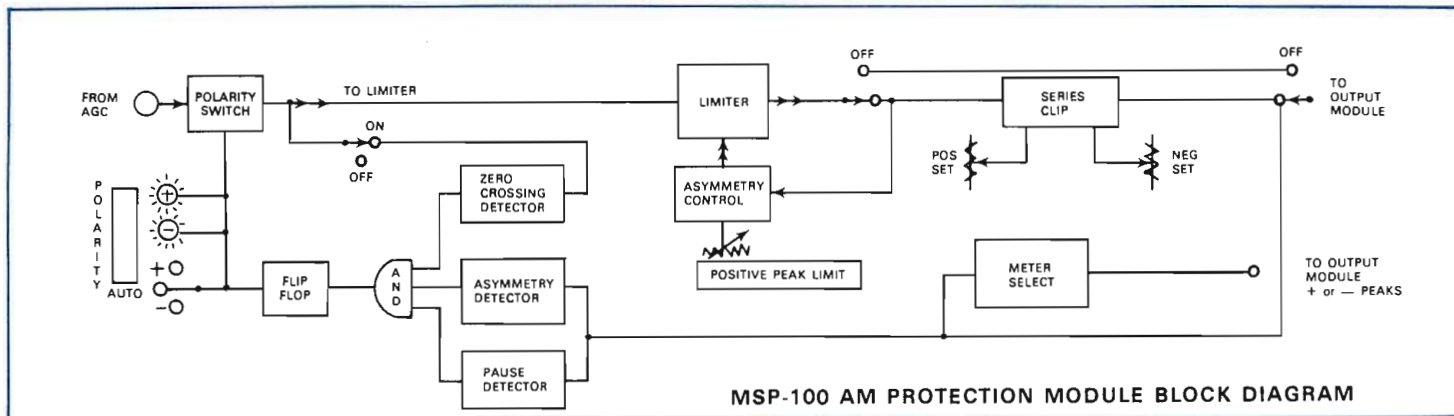

MSP-100 AM PROTECTION MODULE BLOCK DIAGRAM

MSP-100 SPECIFICATIONS

PERFORMANCE SPECIFICATIONS

FREQUENCY RESPONSE: 30 Hz to 15 kHz, ± 1 dB of 1 kHz value at +10 dBm output, control functions disabled.

HARMONIC DISTORTION (TOTAL): 0.25% or less, 20 Hz to 15 kHz at +10 dBm output with control functions disabled.

INTERMODULATION DISTORTION: 0.5% or less, 60 Hz and 7 kHz mixed 4:1 at +10 dBm output with control functions disabled.

NOISE: 65 dB below +10 dBm output over 30 Hz to 15 kHz bandwidth for 0 dBm input with control functions disabled.

GAIN: Switch selected, 23 dB or 43 dB, ± 2 dB (input and output controls allow finer adjustment).

MAXIMUM OUTPUT LEVEL: +18 dBm.

GENERAL

SOURCE LOAD IMPEDANCE: 600 ohms, balanced or unbalanced.

AC INPUT POWER: 115/230 volts, 50/60 Hz, single phase, 40 watts.

TEMPERATURE RANGE: Operating, 0° to +55° C;
storage, -40° to +85° C.

HUMIDITY RANGE: Non-condensing, 5% to 95% relative.

ALTITUDE RANGE: To 10,000 feet A.M.S.L.

DIMENSIONS: 17.6" (44.8 cm) W x 14" (35.5 cm) H x 15.1" (38.4 cm) D.

OPERATIONAL SPECIFICATIONS

AGC Section

CROSSOVER FREQUENCIES: Switch selectable, $\pm 10\%$:
Low: 75, 95, 105, 135, 160, 230, 320 Hz.
High: 1.7, 2.2, 2.5, 3.1, 3.7, 5.3, 7.2 kHz.

ATTACK TIME (Applicable to each of 3 bands): Compression or expansion, switch selected .25, .8, 2.5, 8, 25 milliseconds.

RECOVERY TIME (Applicable to each of 3 bands): Compression or expansion, switch selected 0.4 to 6 seconds; dual recovery mode (when used) dynamically increases period recovery time up to 11 times selected.

COMPRESSION RATIO (Applicable to each of 3 bands): Switch selected, 12:4; 12:2; 12:1, 12:0.5 (dB/dB) at center of range.

EXPANSION RATIO (Applicable to each of 3 bands): Fixed, 12:24 dB/dB.

COMPRESSION THRESHOLD (Applicable to each of 3 bands): Adjustable over 12 dB range.

EXPANSION THRESHOLD (Applicable to each of 3 bands): -30 dB relative, adjustable ± 12 dB.

EXPANSION RANGE (Applicable to each of 3 bands): 12 dB.

COMPRESSION RANGE (Applicable to each of 3 bands): 24 dB.

Limiter Section

ATTACK TIME: Automatic mode, 25 microseconds to 3.6 milliseconds determined by program signal; manual mode, 0.04 to 3.6 milliseconds.

RECOVERY TIME: Automatic mode, 40 milliseconds to 10 seconds determined by program signal; manual mode, 0.4 to 6.5 seconds. Dual recovery mode (when used) dynamically increases recovery time up to 11 times selected period in either mode.

LIMITING RATIO: 12:0.5 (dB/dB), minimum.

LIMITING RANGE: 12 dB.

FM Protection Section

COMPENSATION CURVES: Flat, 25, 50 and 75 microsecond.

ATTACK TIME, H.F. LIMITER: 100 microseconds.

RECOVERY TIME, H.F. LIMITER: 100 milliseconds.

OPERATIONAL MODE: Parallel split-band with H.F. control only. Crossover frequency: 450 Hz. High frequency control: infinitely variable from full clamp to full gain-reduction limiting.

AM Protection Section

ASYMMETRICAL LIMITING: 100% to 133%, continuously variable.

LIMITER ATTACK TIME: Automatic mode, 25 microseconds to 3.6 milliseconds, determined by program signal; manual mode, 0.04 to 3.6 milliseconds.

LIMITER RECOVERY TIME: Automatic mode, 40 milliseconds to 10 seconds, determined by program signal; manual mode, 0.4 to 6.5 seconds. Dual recovery mode (when used) dynamically increases recovery time up to 11 times selected period in either mode.

ASYMMETRICAL SENSITIVITY: 5%.

SWITCHING TIME: Less than 1 microsecond.

SWITCHING ACTIVATOR: Pause detector and zero crossing detector.

PAUSE DETECTOR SENSITIVITY: 10 dB, 20 dB, 30 dB below limiting threshold (switch selectable).

SPECIFICATIONS SUBJECT TO CHANGE WITHOUT NOTICE.

ORDERING INFORMATION

MSP-100 FM/TV Audio Processor (stereo)	994-7967-001
MSP-100 FM/TV Audio Processor (mono)	994-7968-001
MSP-100 AM Audio Processor (mono)	994-8148-001



HARRIS
COMMUNICATION AND
INFORMATION PROCESSING

MSP-90 Audio Processor

- "Tailor" your sound to your format
- AM positive peak modulation adjustable 100% to 130%
- All in 3½ inches of rack space
- Extensive LED metering
- RFI protection...permits use in transmitter room
- Maximum processing flexibility

The Harris MSP-90 is an advanced audio processor that allows you to "tailor" your sound to your station's format. Reflecting today's latest design techniques, the MSP-90 offers unsurpassed audio performance plus convenient modular construction. And, due to the modern manufacturing techniques employed, including computerized testing, Harris is able to offer this audio processing series at surprisingly low prices.

Through its great flexibility, the Harris MSP-90 can be ordered in many configurations: as a mono or a stereo AGC amplifier; an AM limiter; a dual AM limiter; a mono or stereo FM limiter; an AGC amplifier/AM limiter; or an AGC amplifier/FM limiter. The main frame, which includes the power supply, is designed to accept any two of three plug-in modules (AM limiter, FM limiter, AGC amplifier) to provide the various configurations.

Performance specifications of the MSP-90 are excellent in all configurations. As the unit employs the most advanced circuitry available, it allows the highest possible modulation levels with minimum distortion.

The MSP-90 incorporates integrated circuit amplifiers with no discrete transistors. Audio transformers have been eliminated through the use of active instrumentation-type circuits, allowing the flexibility of balanced or unbalanced inputs, and eliminating distortion, ringing and the frequency and transient response problems normally associated with transformers.

Precision LED metering is provided on all modules for accurately measuring gain control and for indicating modulation percentage and output level. Dual regulation has been provided in the power supply for highest reliability. The supply is fully regulated to eliminate problems associated with high line voltages or brown-outs.

Special attention has been given to RFI protection through the use of shielding, filtering, grounding and special circuit design. The main frame utilizes extruded construction for extreme ruggedness, and the modular design allows easy servicing with the use of an optional extender card.



**MSP-90 Audio Processor,
AGC Amplifier/AM Limiter Configuration**

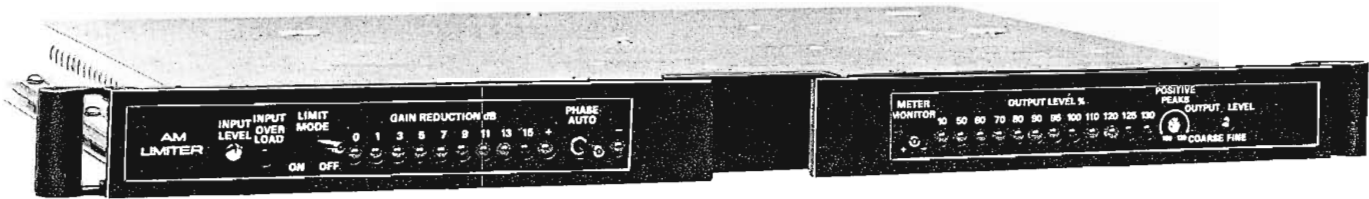

MSP-90 AM LIMITER MODULE

The MSP-90 AM limiter is designed for 125% positive peak modulation performance, allowing the loudest possible signal with minimum distortion. It eliminates the annoying "thumping", "pumping" and "clicks" associated with many low-priced limiters. Gain is controlled by a monolithic integrated circuit, and this modern fast limiter assures excellent noise and distortion specifications. Selectable recovery time is provided for "tailoring" the sound to station needs.

True asymmetrical limiting for 125% positive peak modulation is achieved through innovative circuit design. A polarity reversal circuit, employing digital detection techniques, reverses polarity only when the program waveform goes through a zero crossing. This allows very rapid, inaudible switching. Rapid recovery, with minimum low frequency distortion, is provided by a unique integrated circuit. This eliminates audio "holes" produced by most other techniques.

An input selector allows gain changes in 10 dB steps for up to a 30 dB increase in sensitivity, while a fine adjustment control allows an additional 10 dB range. An LED indicator is provided to show excessive drive into the first instrumentation amplifier. LED's are also provided on the front panel for readout of audio polarity and asymmetrical limiting.

Positive peak modulation is adjustable

from 100% to 130% to match your transmitter's capability.

AM LIMITER SPECIFICATIONS

INPUT: 600 ohms terminating. Maximum input level +15 dBm. 0 dB limiting threshold, +10 dBm to -30 dBm with switching level and input level control.

OUTPUT: 20 ohms for 600 ohm load. Nominal output level +10 dBm. Maximum output level +24 dBm.

GAIN: 20 dB \pm 1 dB with input amp set for 0 dB gain.

FREQUENCY RESPONSE: \pm 1 dB, 20 Hz to 20 kHz.

HARMONIC DISTORTION: (+10 dBm output) 0.15% maximum, 20 Hz to 20 kHz, limiter disabled; 1.0% maximum, 20 Hz to 20 kHz, 10 dB limiting, slow recovery.

INTERMODULATION DISTORTION: [60 Hz and 7 kHz mixed 4:1 at +10 dBm output (P. Eq)] 0.30% maximum, limiter disabled; 0.75% maximum, 10 dB limiting, single recovery.

NOISE: (20 Hz to 20 kHz) Signal-to-noise better than 70 dB below limiting threshold.

LIMITING RANGE: 15 dB.

LIMITING SLOPE: 18:1.

LIMITING ATTACK TIME: Less than 40 microseconds.

LIMITING RECOVERY TIME: Switch selectable from 1.3 seconds to 7.5 seconds.

LIMITING CONTROL: On-Off.

ASYMMETRICAL CONTROL RANGE: 100% to 130%.

PAUSE CONTROL: + AUTO -

PAUSE DETECTOR LEVEL: -10 dB, -20 dB, -30 dB below limiting level.

PHASE SWITCHING TIME: Less than one microsecond.

PHASE ACTIVATION TIME: Minimum of 50 milliseconds, program dependent.

AC INPUT POWER: 117/234 volts \pm 10%, 50/60 Hz, 25 watts.

DC VOLTAGES: Dual series regulation at \pm 20 vdc and \pm 15 vdc.

TEMPERATURE RANGE: Operating: -20° to +55° C. Storage: -40° to +85° C.

HUMIDITY RANGE: Non-condensing, 5% to 90% relative.

ALTITUDE RANGE: To 10,000 feet A.M.S.L. (3048 meters).

DIMENSIONS: 16.6" (42.2 cm) W x 1.2" (3.0 cm) H x 10.3" (26.2 cm) D.

WEIGHT: 3 lbs. 2 oz. (1.42 kg).



MSP-90 FM LIMITER MODULE

The MSP-90 FM limiter is designed to prevent FM overmodulation while retaining maximum loudness with excellent clarity and fidelity. This is accomplished through a split spectrum limiting approach which prevents high frequency overdrive for pre-

emphasized systems such as FM, TV and SCA.

The gain controlling section is a fast limiter, which includes adjustable recovery time. It is designed to minimize noise and distortion.

After this precision high-speed limiter the signal is split into two audio bands, above and below 400 Hz. The high frequency band then feeds a parallel clamp circuit and another fast limiter, and LED's are used to indicate operation of the clamping

and limiting. Adjustable de-emphasis after the clamping sections minimizes audible harmonic distortion. As high frequencies affect overdrive greatly, they are controlled to a far more significant degree than the low frequency audio components, which have little overdrive potential.

The output signal may be adjusted to combine any ratio of limited or clamped high frequency signal with the unprocessed low frequency signal. After combining, a final broadband clamp circuit controls transient peaks and summation errors.

FM LIMITER SPECIFICATIONS

INPUT: 600 ohms terminating. Maximum input level +15 dBm. 0 dB limiting threshold, +10 dBm to -30 dBm with switching level and input level control.

OUTPUT: 600 ohms for 600 ohm load. Nominal output level +10 dBm. Maximum output level +18 dBm.

GAIN: 24 dB \pm 1 dB with input amp set for 0 dB gain.

FREQUENCY RESPONSE: \pm 1 dB, 20 Hz to 20 kHz.

HARMONIC DISTORTION: (+10 dBm output) 0.25% maximum, 20 Hz to 20 kHz, limiter disabled; 1.0% maximum, 20 Hz to 20 kHz, 10 dB limiting, slow recovery.

INTERMODULATION DISTORTION: [60 Hz and 7 kHz mixed 4:1 at +10 dBm output (P. Eq)] 0.25% maximum, limiter disabled.

NOISE: (20 Hz to 20 kHz) Signal-to-noise better than 70 dB below limiting threshold, FM in hard mode.

LIMITING RANGE: 15 dB.

LIMITING SLOPE: 30:1.

LIMITING START TIME: Less than 40 microseconds.

LIMITING RECOVERY TIME: Switch selectable from 1.3 seconds to 7.5 seconds.

LIMITING CONTROL: On-Off.

FM PROTECTION: Split band - dual mode.

PRE-EMPHASIS: 0, 25, 50, 75 microseconds.

DE-EMPHASIS: 0, 25, 50, 75 microseconds.

AC INPUT POWER: 117/234 volts \pm 10%, 50/60 Hz, 25 watts.

DC VOLTAGES: Dual series regulation at \pm 20 vdc and \pm 15 vdc.

TEMPERATURE RANGE: Operating: -20° to +55° C. Storage: -40° to +85° C.

HUMIDITY RANGE: Non-condensing, 5% to 90% relative.

ALTITUDE RANGE: To 10,000 feet A.M.S.L. (3048 meters).

DIMENSIONS: 16.6" (42.2 cm) W x 1.2" (3.0 cm) H x 10.3" (26.2 cm) D.

WEIGHT: 3 lbs. 2 oz. (1.42 kg).

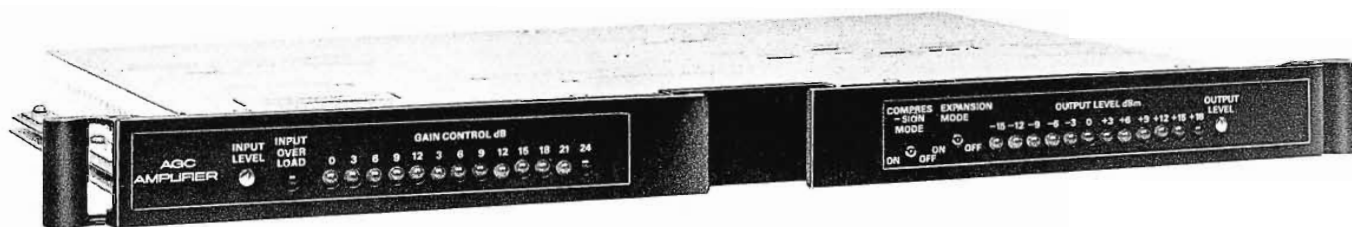

MSP-90 AGC AMPLIFIER MODULE

The Harris MSP-90 AGC amplifier is the most versatile automatic gain control unit available today, with a wide range of controls to ensure maximum processing flexibility. It is designed to ideally complement the MSP-90 AM or FM limiters.

The gain controlling section provides up to 12 dB of expansion and 24 dB of compression. Adjustments include: separate attack and recovery times for the expander and the compressor; a threshold control for expansion; a selector switch for adjusting the expansion level in 3 dB increments; and a four-position slope control. An advanced integrated circuit used for gain control minimizes noise and distortion, and provides **exact** tracking between left and right channels when used for stereo.

An input sensitivity switch allows gain changes in 10 dB steps up to a 30 dB increase in sensitivity, while a fine adjustment control provides an additional 10 dB range.

An overdrive indicator is provided to show excessive drive to the input amplifier, and LED indicators are provided for both gain control and output level. The gain controlling LED's show both expansion and compression operation, while separate LED's show actual output level.

AGC AMPLIFIER SPECIFICATIONS

INPUT: 600 ohms terminating. Maximum

input level +18 dBm. Compression threshold +4 dBm to -36 dBm with switching level and input level control.

OUTPUT: 600 ohms for 600 ohm load. Nominal output level +10 dBm. Maximum output level +18 dBm.

GAIN: 19 dB \pm 1 dB with input amp set for 0 dB gain, expansion and compression functions disabled.

FREQUENCY RESPONSE: \pm 1 dB, 20 Hz to 20 kHz.

HARMONIC DISTORTION: (+10 dBm output) 0.25% maximum, 20 Hz to 20 kHz, AGC disabled; 1.0% maximum, 20 Hz to 20 kHz, AGC on, SLOW.

AGC Amplifier Module (continued)

INTERMODULATION DISTORTION: [60 Hz and 7 kHz mixed 4:1 at +10 dBm output (P. Eq)] 0.25% maximum, AGC disabled; 1.5% maximum, AGC on, SLOW.

NOISE: (20 Hz to 20 kHz) Signal-to-noise better than 75 dB below compression threshold.

EXPANSION RANGE: Selectable at 3 dB, 6 dB, 9 dB or 12 dB.

EXPANSION SLOPE: Approximately 2.5:1.

EXPANSION ATTACK TIME: Selectable at 1 second, 500, 300, 200 or 100 milliseconds.

EXPANSION RECOVERY TIME: Selectable at 15, 5, 2.5 or 1 second(s).

EXPANSION THRESHOLD: ±5 dB.

COMPRESSION RANGE: 24 dB.

COMPRESSION SLOPE: Selectable at 24:1, 12:1, 6:1 or 3:1.

COMPRESSION ATTACK TIME: Selectable at 250 microseconds, 1, 2.5 or approximately 25 milliseconds.

COMPRESSION RECOVERY TIME: Selectable at 3.5 or 1.4 seconds, 750 or 580 milliseconds.

AC INPUT POWER: 117/234 volts ±10%, 50/60 Hz, 25 watts.

DC VOLTAGES: Dual series regulation at ±20 vdc and ±15 vdc.

TEMPERATURE RANGE: Operating: -20° to +55° C. Storage: -40° to +85° C.

HUMIDITY RANGE: Non-condensing, 5% to 90% relative.

ALTITUDE RANGE: To 10,000 feet A.M.S.L. (3048 meters).

DIMENSIONS: 16.6" (42.2 cm) W x 1.2" (3.0 cm) H x 10.3" (26.2 cm) D.

WEIGHT: 3 lbs. 2 oz. (1.42 kg).

MSP-90 MAIN FRAME

Only 3½ inches of vertical 19-inch rack space is required to mount the MSP-90 main frame, which supplies input/output connections and regulated DC power for two MSP-90 modules. Heavy aluminum extruded construction is used throughout for ruggedness and durability. The

conservatively-rated, well-regulated primary power supply will operate on 115V or 230V, while protecting the modules from brownouts and severe overvoltage surges. Well-ventilated aluminum top and bottom covers keep modules cool and dust free. Nylon guide rails and gold-

plated sockets insure excellent mechanical and electrical connections for all modules. Dimensions: 19.0" (48.3 cm) W x 3.5" (8.9 cm) H x 15.5" (39.4 cm) D. Weight: 12 lbs. 13 oz. (5.81 kg).

MSP-90 ORDERING INFORMATION

The MSP-90 may be ordered in the configurations listed below. Optional modules are listed as spares or to allow you to reconfigure a unit. For instance, you could order an FM limiter module,

and use it to turn an MSP-90 mono FM limiter into a stereo unit if your station goes stereo at a later date.

MSP-90 AM Limiter	994-8200-001
MSP-90 Dual AM Limiter	994-8336-001
MSP-90 FM Limiter (Monaural)	994-8201-001
MSP-90 FM Limiter (Stereo)	994-8202-001
MSP-90 AGC Amplifier (Monaural)	994-8203-001
MSP-90 AGC Amplifier (Stereo)	994-8204-001
MSP-90 AGC Amplifier/AM Limiter	994-8205-001
MSP-90 AGC Amplifier/FM Limiter	994-8206-001

NOTE: An extender card is included with each of the above.

MSP-90 OPTIONAL SPARE MODULES

AM Limiter Module	992-5235-001
FM Limiter Module	992-5236-001
AGC Amplifier Module	992-5237-001



HARRIS
COMMUNICATION AND
INFORMATION PROCESSING

MSP-90 TRI BAND AGC Audio Processor

- **MSP-90 Tri Band AGC: A true automatic gain amplifier, not just a compressor**
- **Time averaged true RMS power control**
- **Phase coherent filtering with adjustable band to band crossover frequencies**
- **Program dependent attack time**
- **Front panel output mix controls enable equalization of audio chain for optimum results**
- **Ease of setup and operation**

With the development of the MSP-90 Tri Band AGC, Harris furthers the technical advancement of audio processing and offers the broadcaster an added opportunity to increase his coverage area through a louder signal and improved modulation.

Characterized by outstanding reliability, total flexibility, modular construction, and state-of-the-art circuitry, the Tri Band AGC boasts a performance level previously unattainable in a stand alone unit. In addition, the Tri Band AGC provides high quality and low distortion while maintaining the Harris reputation for cost sensitivity.

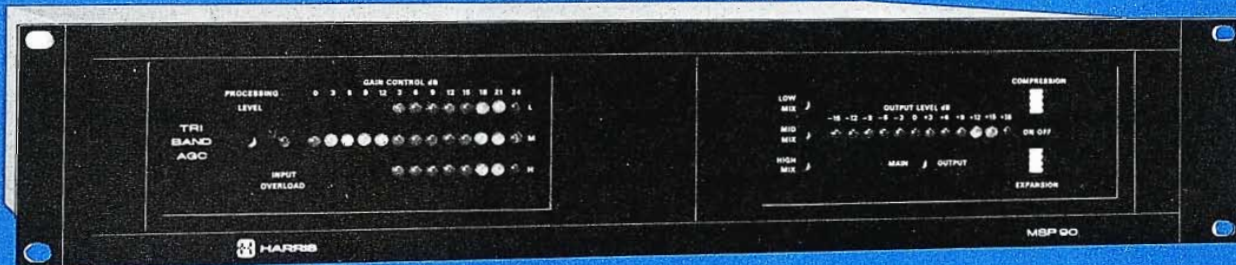

With a performance level far beyond old gated compressor type models, the Tri Band AGC is a true Automatic Gain Control amplifier system based upon complementary expansion and compression which totally eliminate irritating noise swish-up.

The time averaged RMS power control significantly increases signal power without affecting peak levels. Unlike less advanced RMS processors that rely on the use of non-linear LED-PHOTO-CELL combinations, advanced circuitry in the MSP-90 Tri Band AGC amplifier actually CALCULATES the RMS signal power, making it possible to maintain the timbre of musical signals while simultaneously increasing loudness.

Crossover anomalies and dead spots in frequency response, which are common in less sophisticated equipment, have been eliminated in the MSP-90 Tri Band AGC through the use of phase coherent, single pole, band to band filtering with adjustable turnover frequencies. Because the turnover frequencies of the Tri Band AGC are each adjustable over three octaves, the Harris AGC module has become the answer to the broadcasters' needs today and in the future.

Program dependent attack time assures minimum distortion at low frequencies and optimizes crisp, clear highs. The Tri Band processing plus RMS control eliminate the problems normally associated with record pops and clicks, thus guaranteeing the most trans-

parent operation possible.

The front panel output mix controls of the MSP-90 Tri Band AGC provide the broadcaster with the capability of altering the frequency response of the audio chain without the use of external equalizers. Adequate equalization for all formats and transmitting media is assured by the ± 10 dB control range of each band.

The Tri Band AGC amplifier module plugs easily into the rugged MSP-90 main frame to offer today's creative broadcaster unsurpassed audio performance coupled with flexibility and convenience. The conservatively rated, well-regulated primary power supply will operate on 115V or 230V, while protecting the amplifier module from brownouts and severe overvoltage surges.

MSP-90 TRI BAND AGC SPECIFICATIONS

INPUT: 600 ohm terminating. Maximum level +28 dBm. Compression threshold +4 dBm to -26 dBm.

OUTPUT: 600 ohm for 600 ohm load. Nominal output level +10 dBm. Maximum output level +18 dBm.

FREQUENCY RESPONSE: ± 1 dB, 20 Hz to 20 kHz, controls flat.

HARMONIC DISTORTION: (+10 dBm output) 0.25% maximum, 20 Hz to 20 kHz disabled; 0.5% maximum, 20 Hz to 20 kHz, enabled, slow.

INTERMODULATION DISTORTION: (+10 dBm output) 0.25% maximum disabled; 0.5% maximum, enabled, slow; SMPTE.

NOISE: (20 Hz to 20 kHz) Signal-to-noise better than 70 dB below compression threshold.

EXPANSION RANGE: Selectable at 3 dB, 6 dB, 9 dB or 12 dB.

EXPANSION SLOPE: 2:1.

EXPANSION THRESHOLD: ± 5 dB from normal -20 dBm.

EXPANSION ATTACK TIME: 0.1, 0.2, 0.3, 0.5 or 1 second.

EXPANSION RECOVERY TIME: 0.25, 0.5, 1, 2, 4, 8 or 16 second(s).

COMPRESSION RANGE: 24 dB.

COMPRESSION SLOPE: Selectable at 24:1, 12:1, 6:1 or 3:1.

COMPRESSION TYPE: True RMS power control.

COMPRESSION ATTACK TIME: Program dependent, 2.5 m Sec. to 250 m Sec.

COMPRESSION RECOVERY TIME: 0.25, 0.5, 1, 2, 4, 8 or 16 second(s).

OUTPUT MIX: Each band can be varied ± 10 dB from nominally flat.

BAND SPLITTING: Phase linear, selectable; low frequency crossover 75, 95, 105, 135, 160, 230 or 320 Hz; high frequency crossover 1680, 2180, 2450, 3060, 3700, 5300 or 7200 Hz.

ORDERING INFORMATION

MSP-90 TRI BAND AGC with main frame (monaural)	994-8357-001
MSP-90 TRI BAND AGC with main frame (stereo)	994-8358-001
MSP-90 TRI BAND AGC Module.....	992-5603-001



HARRIS
COMMUNICATION AND
INFORMATION PROCESSING

CRITERION 90-1 CRITERION 90-2

Tape Cartridge Systems

- Meet or exceed NAB specifications
- Design simplicity for top reliability
- Superb audio performance
- Very quiet operation
- Hysteresis synchronous direct capstan drive motor for speed accuracy and stability
- Completely solid-state electronics for extra reliability
- Computer testing of components and assemblies
- Individual testing of each unit
- Plug-in printed circuit cards
- Minimum hand wiring
- Heavy steel chassis construction

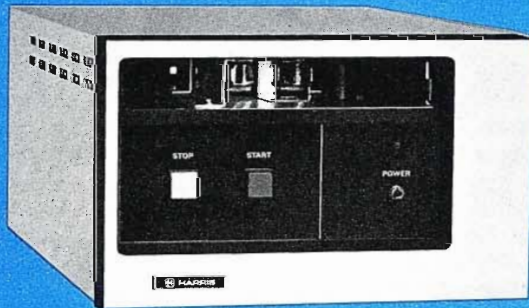

CRITERION 90-1 PLAYBACK

CRITERION 90-2 RECORD/PLAYBACK



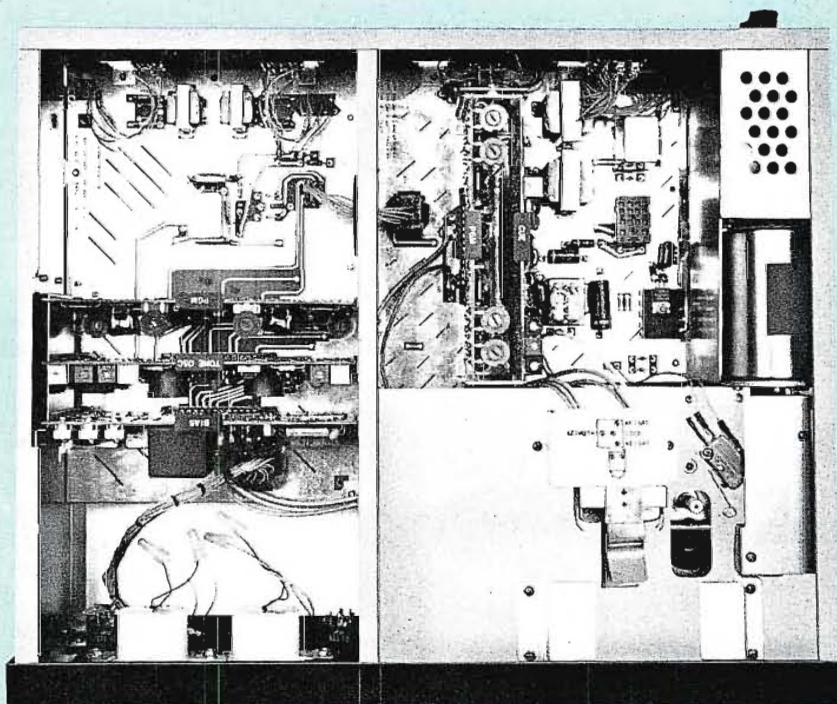

Criterion 90-2 record/playback, top view, cover off, showing modular construction and easy component access.

CRITERION 90-1 AND CRITERION 90-2

With Criterion 90, Harris provides the most reliable, the most rugged, the best performing line of tape cartridge systems ever put on the market. No detail has been overlooked to insure that your Criterion 90 will give you top service, year after year, from the very first day of delivery.

Starting with the heavy steel chassis construction and the half-inch thick aluminum tool plate deck that provides a rugged, warp-resistant, precisely flat base for the Micro-Set head assembly—on through the specially-designed hysteresis synchronous motor with direct capstan drive for unmatched speed accuracy and stability, the Criterion 90 line is precision-built to meet or exceed exacting performance specifications.

The manufacturing process is followed up by rigorous testing of each unit in Harris' laboratories. No Criterion 90 is shipped until it is thoroughly tested—and a qualification sheet with key measurements, signed by a test technician, is enclosed with your unit.

And finally, the Criterion 90 series is regularly undergoing road tests—sample units are put on delivery trucks and allowed to bounce around for days. Then the units are tested to see how well they hold up under typical shipping conditions.

This practical type of testing played a part in the design of Criterion 90, showing what

areas might present problems, and helped us come up with extremely rugged units that can stand up under any type of handling tape cartridge machines might encounter.

In addition, both Criterion 90-1 and Criterion 90-2 have been designed in space-saving sizes for convenient installation in today's crowded studios. For instance, two Criterion 90-1 playbacks may be mounted side by side in a standard 19-inch equipment rack, occupying the same space normally required for a single playback. The Criterion 90-2 record/playback fits handily in only 7 inches of standard rack space.

HYSTERESIS SYNCHRONOUS MOTOR

The heart of Criterion 90-1/90-2 is a hysteresis synchronous motor, with direct capstan drive, built exclusively for Harris, to Harris specifications. This motor assembly, along with the full swing pressure roller, offers speed accuracy and stability comparable to a reel-to-reel machine. Sealed instrument-type ball bearings are used to keep transport wow and flutter to less than 0.15% NAB weighted peak, while full motor shielding helps maintain a greatly improved signal-to-noise ratio.

The motor is precisely located to help insure correct tape path guidance, correct pinch roller pressure and minimum wow and flutter.

HEAD ASSEMBLY AND DECK

The high quality, laminated heads are built with all-metal hyperbolic faces, providing for long wear and low oxide accumulation. These quality heads provide optimum colinearity to assure the best possible stereo phase relationship. Three tape guides further control the tape path guidance to insure constant output quality, and full audio response from cartridge to cartridge. In the playback only units a dummy head replaces the record head to maximize performance.

The Micro-Set head bracket is easily adjustable for accurate height, zenith and azimuth. An air-damped pressure roller solenoid is adjustable from 0.08 to 0.5 seconds for rapid or slow cueing, and the plunger is Teflon® coated for quiet, easy operation.

The head and motor assemblies are mounted on a heavy-duty, precision-machined, half-inch bar stock aluminum deck that helps provide proper cartridge alignment on the Micro-Set head for optimum performance.

ELECTRONICS

Criterion 90 electronics are completely solid state for greatest reliability, and temperature and gain stability. The improved design allows Criterion 90-1 and Criterion 90-2 to achieve better than NAB standards for frequency response, distortion and

signal-to-noise. Audio output capability is +18 dBm (0 dBm nominal) to accommodate losses in complex studio or system installations. Full automatic muting of all audio outputs provides better than -75 dBm noise on standby.

In all Criterion 90 units, a motherboard philosophy has reduced hand wiring to a minimum for long-term reliability and better overall performance. Only two printed circuit cards carry all of the electronic circuitry for mono or stereo playback units, and these plug-in cards are identical for Criterion 90-1 and Criterion 90-2, for card interchangeability. Cards, heads, switches and motor all have provisions for quick, easy access.

A complete remote control capability is standard in all units, and ground switching of external control functions provides protection for equipment and personnel. All Criterion 90 circuits have been RFI proofed to make them highly resistant to strong RF fields.

Primary and secondary cue sensing are standard features in all Criterion 90 playback machines. All Criterion 90-2 record/playback machines have primary and secondary cue generators and sensors as standard features. The tertiary function is added as a standard feature on the -003 and -004 versions of the Criterion 90-1/90-2 units. Logging input and output connections are standard for interfacing with automation systems, in full conformance with NAB standards.

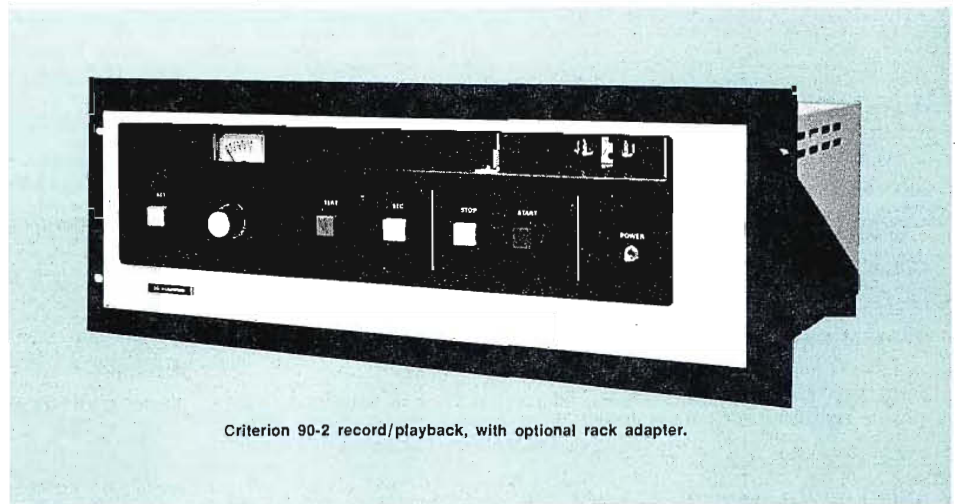

Criterion 90-2 record/playback, with optional rack adapter.

High-reliability, contoured illuminated push-button switches provide visual indication of machine status. Typical bulb life is over 30,000 hours.

TESTING

The most sophisticated computer-controlled test equipment available is used for testing individual printed circuit boards and components. In addition, each Criterion 90 is given individual attention in final tests, and a qualification sheet with key measurements is included with each unit. Extensive road and shake testing is performed regularly on sample units to assure that your Criterion 90 will arrive in top operating

condition, and perform reliably over a long period of time.

MODELS AND TYPES

Criterion 90-1 is available in playback only, and accommodates A, AA, B and BB size cartridges. Criterion 90-2 is available in record/playback or playback only models, and handles A, AA, B, BB, C and CC size cartridges. Both Criterion 90-1 and Criterion 90-2 may be ordered in mono or stereo—and mono models are readily convertible to stereo. All models are mounted in desk top cabinets, with optional rack adapters available.

The Criterion 90 series features modern cabinet styling in an attractive combination of white, brushed aluminum and black.

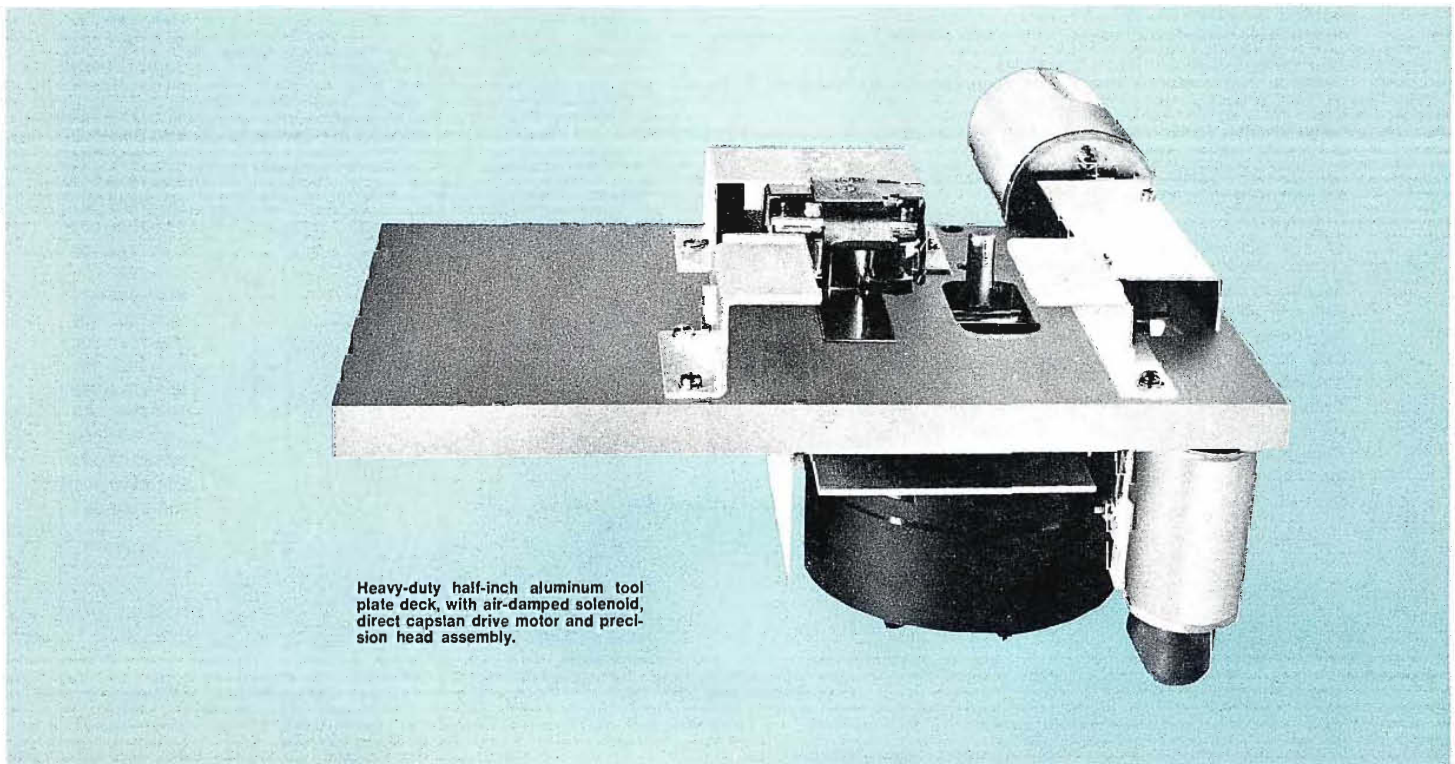

Heavy-duty half-inch aluminum tool plate deck, with air-damped solenoid, direct capstan drive motor and precision head assembly.

CRITERION 90-1 AND CRITERION 90-2 SPECIFICATIONS

POWER: 117 VAC, 60 Hz or 117 VAC, 50 Hz.

FREQUENCY RESPONSE: Record or playback: +1 to -4 dB, 50 to 149 Hz; +1 to -2 dB, 150 to 314 Hz; ±1 dB, 315 Hz to 10 kHz; +1 to -2 dB, 10 kHz to 16 kHz.

SIGNAL-TO-NOISE: Ref 1000 Hz NAB standard level of 160 nW/M: mono, -53 dB minimum, -58 dB typical; stereo, -50 dB minimum, -55 dB typical.

CROSSTALK: Better than 50 dB at 1 kHz.

MUTED NOISE LEVEL: Better than -75 dBm into 600 ohms.

SYSTEM DISTORTION: Less than 1.5% at NAB standard reference level at 1 kHz.

AUDIO OUTPUT: 0 dBm nominal, adjustable to +18 dBm maximum with standard NAB level tapes. Transformer coupled: 600 ohms balanced with 150 ohm optional connection. Independent output for each channel.

AUDIO INPUT: (Record) 600 ohms balanced line, input levels from -22 to +18 dBm, matching; +10 to +40 dBm bridging (20K).

TAPE DRIVE SYSTEM: Hysteresis synchronous motor, direct capstan drive, sealed ball bearings. Vapor blasted capstan.

TAPE SPEED: 19 cm/s (7.5 inches per second).

SPEED ACCURACY: 0.1% or better.

WOW AND FLUTTER: 0.15% or better (NAB weighted peak).

TAPE START TIME: Adjustable from 0.08 seconds to 0.5 seconds.

TAPE STOP TIME: .08 second minimum (adjustable).

EQUALIZATION: NAB or CCIR.

HEADS: Standard NAB stereo or mono with cue track.

CUE SYSTEM: All cue sensing and generation conform to 1976 NAB standards. 1 kHz primary cue tone and 150 Hz secondary cue tone are standard. Also, models are available with the 8 kHz tertiary cue function. All units are capable of reproducing 3.5 kHz logging signals at NAB standard levels.

REMOTE CONTROL: All control functions operated by ground switching. All lamp circuits are also available from the remote sockets.

BIAS OSCILLATOR: 85 kHz balanced push-pull oscillator.

TAPE CARTRIDGE SIZES: (Criterion 90-1) Accepts NAB sizes A, AA, B, BB; (Criterion 90-2) accepts NAB sizes A, AA, B, BB, C, CC.

AMBIENT TEMPERATURE: 4° to 55° C (40° to 130° F).

EXTERNAL CONNECTORS: Latching type. Mating plugs furnished.

MOUNTING: Desk mount standard, rack mount optional.

DIMENSIONS AND WEIGHTS: Criterion 90-1 playback (desk mount): 8.6 inches (21.8 cm) wide, 5.3 inches (13.5 cm) high, 14.1 inches (35.8 cm) deep. Net weight 23 pounds. Criterion 90-2 playback (desk mount): 10.3 inches (26.1 cm) wide, 5.3 inches (13.5 cm) high, 14.1 inches (35.8 cm) deep. Net weight 25 pounds. Criterion 90-2 record/playback (desk mount): 17.3 inches (43.9 cm) wide, 5.3 inches (13.5 cm) high, 14.1 inches (35.8 cm) deep. Net weight 35 pounds.

Specifications subject to change without notice.

ORDERING INFORMATION

HOW TO ORDER: Order optional rack adapters for rack mounting. NAB equalization standard. CCIR equalization on special order.

Criterion 90-1 playback, mono, with 1000/150 Hz cue functions, 60 Hz.....	994-7993-001
As above, except 50 Hz.....	994-7993-002
Criterion 90-1 playback, mono, with 1000/150/8000 Hz cue functions, 60 Hz.....	994-7993-003
As above, except 50 Hz.....	994-7993-004
Criterion 90-1 playback, stereo, with 1000/150 Hz cue functions, 60 Hz.....	994-7994-001
As above, except 50 Hz.....	994-7994-002
Criterion 90-1 playback, stereo, with 1000/150/8000 Hz cue functions, 60 Hz.....	994-7994-003
As above, except 50 Hz.....	994-7994-004
Criterion 90-2 playback, mono, with 1000/150 Hz cue functions, 60 Hz.....	994-7995-001
As above, except 50 Hz.....	994-7995-002
Criterion 90-2 playback, mono, with 1000/150/8000 Hz cue functions, 60 Hz.....	994-7995-003
As above, except 50 Hz.....	994-7995-004
Criterion 90-2 playback, stereo, with 1000/150 Hz cue functions, 60 Hz.....	994-7996-001
As above, except 50 Hz.....	994-7996-002
Criterion 90-2 playback, stereo, with 1000/150/8000 Hz cue functions, 60 Hz.....	994-7996-003
As above, except 50 Hz.....	994-7996-004
Criterion 90-2 record/playback, mono, with 1000/150 Hz cue functions, 60 Hz.....	994-7997-001
As above, except 50 Hz.....	994-7997-002
Criterion 90-2 record/playback, mono, with 1000/150/8000 Hz cue functions, 60 Hz.....	994-7997-003
As above, except 50 Hz.....	994-7997-004
Criterion 90-2 record/playback, stereo, with 1000/150 Hz cue functions, 60 Hz.....	994-7998-001
As above, except 50 Hz.....	994-7998-002
Criterion 90-2 record/playback, stereo, with 1000/150/8000 Hz cue functions, 60 Hz.....	994-7998-003
As above, except 50 Hz.....	994-7998-004
Rack mounting kit for Criterion 90-1 playback unit.....	994-8161-001
Rack mounting kit for Criterion 90-2 playback unit.....	994-8160-001
Rack mounting kit for Criterion 90-2 record/playback unit or two Criterion 90-1 playback units.....	994-8162-001



CRITERION 90-3

Tape Cartridge Playback

- Combines three playback decks in a single unit
- Two Criterion 90-3's may be mounted side by side in a standard rack
- Meets or exceeds NAB specifications
- Design simplicity for top reliability
- Superb audio performance
- Quiet operation
- Hysteresis synchronous direct capstan drive motor for speed accuracy and stability
- Completely solid-state electronics
- Computer testing of components and assemblies
- Individual testing of each unit
- Plug-in printed circuit cards

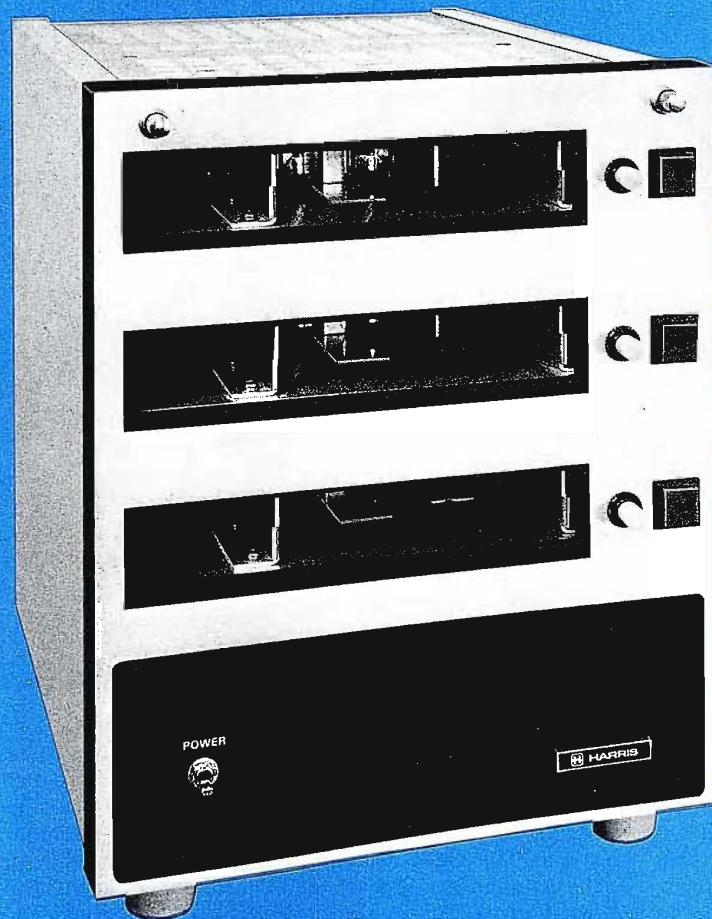

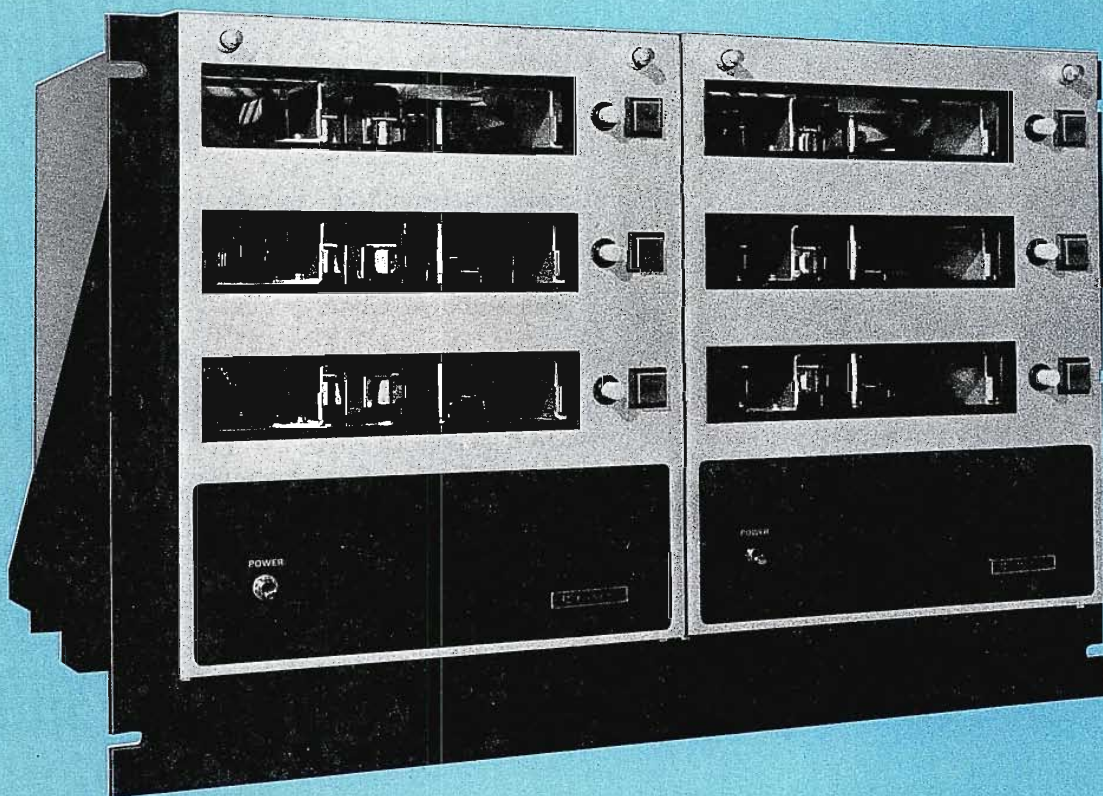

Two Criterion 90-3's may be mounted side by side in a standard rack to provide six playback units in a rack space that will hold only two regular size playbacks.

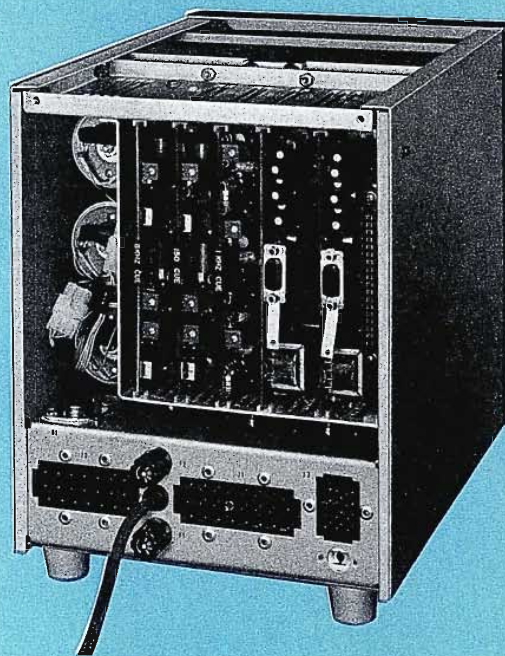

Easy access to rear components is through the removable rear panel.

Harris' Criterion 90-3 combines three playback decks in a single space-saving unit—and offers the very best in audio performance and reliability. No detail has been overlooked to insure that your Criterion 90-3 will give you top service, year after year, from the very first day of delivery.

Starting with the half-inch thick aluminum tool plate decks that provide rugged, warp-

resistant, precisely flat bases for the Micro-Set head assemblies—on through the specially-designed hysteresis synchronous motor with direct capstan drive for unmatched speed accuracy and stability, the Criterion 90-3 is precision built to meet exacting performance specifications.

The manufacturing process is followed up by rigorous testing of each unit in Harris' laboratories. No Criterion 90-3 is shipped

until it is thoroughly tested by sophisticated computer-controlled test equipment. In addition, each Criterion 90-3 is given individual attention in final tests, and a qualification sheet with key measurements, signed by a test technician, is enclosed with your unit.

And finally, the Criterion 90-3 is regularly undergoing road tests—test units are put on delivery trucks and allowed to bounce

around for days. Then the test units are examined to see how well they held up under typical shipping conditions.

THREE DECKS IN ONE UNIT

Each of the three decks of the Criterion 90-3 operates as a separate playback unit, with separate controls. One deck may be operated alone—or two or three decks may be operated at the same time, each feeding a different program input.

The top and center decks slide out for maintenance, and are easily removed by opening the hinged front panel and unplugging head and solenoid connections. Only the motor capstan is common to the three decks, and the Criterion 90-3 may be operated with the top, center or both decks removed without affecting the remaining deck(s).

The motor is precisely located to the lower deck to insure correct tape path guidance, correct pinch roller pressure and minimum wow and flutter.

Top and center decks have vernier adjustment of deck to motor relationships, with a strong center post reference. This is superior to referencing to the front panel. A locking screw, independent of the vernier adjustment screw, permits removal and replacement of the top and center decks without affecting the deck-to-motor relationship.

Head alignment and other adjustments are typically performed first on the lower fixed deck, then on the center deck, and finally on the top deck. However, adjustments can be performed in any sequence.

HYSTERESIS SYNCHRONOUS MOTOR

The heart of the Criterion 90-3 is a hysteresis synchronous motor, with direct capstan drive, built exclusively for Harris, to Harris specifications. This motor assembly, along with the full swing pressure roller, offers speed accuracy and stability comparable to a reel-to-reel machine. Sealed instrument-type ball bearings are used to keep transport wow and flutter to less than 0.2% rms, while full motor shielding helps maintain a greatly improved signal-to-noise ratio.

QUALITY HEAD ASSEMBLIES

The high quality, laminated heads are built with all-metal hyperbolic faces, providing long wear and low oxide accumulation. These quality heads provide optimum colinearity to assure the best possible stereo phase relationship. Three tape guides further control the tape path guidance to insure constant output quality, and full audio response from cartridge to cartridge. With each of the three playback decks, a dummy head

replaces the record head to maximize performance.

The Micro-Set head bracket on each deck is easily adjustable for accurate height, zenith and azimuth. An air-damped pressure roller solenoid is adjustable from 0.08 to 0.5 seconds for rapid or slow cueing, and the plunger is Teflon® coated for quiet, easy operation.

SUPERIOR ELECTRONICS

Criterion 90-3 electronics are completely solid state for greatest reliability, and temperature and gain stability. The improved design allows the Criterion 90-3 to achieve better than NAB standards for frequency response, distortion and signal-to-noise. Audio output capability is +18 dBm (0 dBm nominal) to accommodate losses in complex studio or system installations. Full automatic muting of all studio outputs provides better than -75 dBm noise on standby.

Program, cue, control, status and logging information is available on rear connectors for remote operations and program automation use—and ground switching of external control functions provides protection for equipment and personnel. All

Criterion 90-3 circuits have been RFI proofed to make them highly resistant to strong RF fields.

Cue and program amplifier cards are convenient plug-in design. To detect a secondary cue tone, only one additional cue card is plugged in to handle all three decks. For a third tone, only one tertiary card is added.

A Criterion 90-3 monaural unit may be changed to stereo operation by changing the head assembly in each deck, and adding only one program amplifier card for the entire unit.

MODELS AND TYPES

The Criterion 90-3 is available in mono or stereo playback models. The units are desk mounted, but an optional rack adapter is available for mounting two Criterion 90-3's side by side in a standard 19-inch rack. This gives you six playback decks in only 12¼ inches of rack space! Or the rack adapter may be used to mount one Criterion 90-3 and one optional cartridge storage rack that holds up to twenty size "A" or "AA" cartridges. The Criterion 90-3 accepts "A", "AA", "B" and "BB" cartridges.

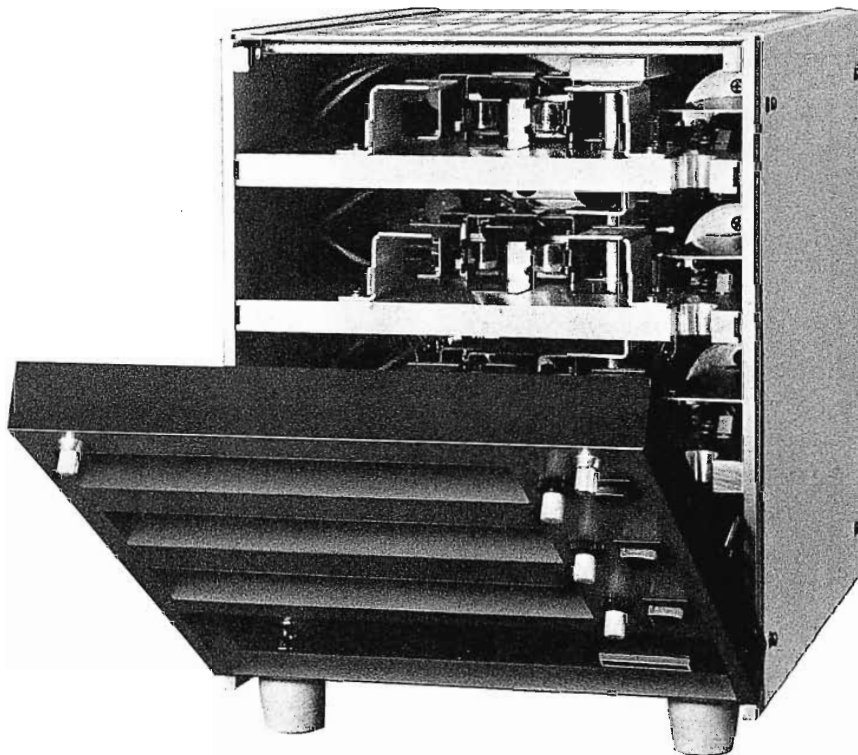

The front panel of the Criterion 90-3 drops down, and the center and top decks slide out for convenient maintenance.

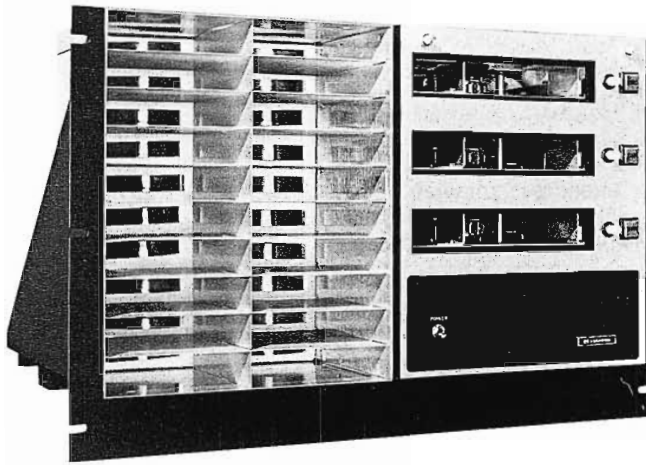

One Criterion 90-3 may be rack mounted with an optional cartridge rack that holds up to 20 size "A" or "AA" cartridges.

CRITERION 90-3 SPECIFICATIONS

POWER: 117 VAC, 60 Hz or 117 VAC, 50 Hz.
FREQUENCY RESPONSE: +3, -2 dB 50 to 300 Hz; ± 2 dB 300 Hz to 15 kHz.
SIGNAL-TO-NOISE: Ref. 1000 Hz NAB standard level of 160 nW/M: mono, -53 dB nominal; stereo, -50 dB nominal.
CROSSTALK: Better than 50 dB at 1 kHz.
MUTED NOISE LEVEL: Better than -75 dBm into 600 ohms.
SYSTEM DISTORTION: Less than 2.0% at NAB standard reference level at 1 kHz (160 nW/M).
AUDIO OUTPUT: dBm nominal, adjustable to +18 dBm maximum. Transformer coupled: 600 ohms balanced with 150 ohm optional connection. Independent output for each channel.
TAPE DRIVE SYSTEM: Hysteresis synchronous motor, direct capstan drive, sealed ball bearings. Vapor blasted capstan.
TAPE SPEED: 19 cm/s (7.5 inches per second).
SPEED ACCURACY: 0.1% or better.
WOW AND FLUTTER: 0.2% RMS or better (unweighted).
TAPE START TIME: Set at 0.1 seconds (adjustable).

EQUALIZATION: NAB or CCIR.
HEADS: Standard NAB stereo or mono with cue track.
CUE SYSTEM: All cue sensing and generation conform to 1976 NAB standards. 1000 Hz primary cue. 150 Hz secondary and 8 kHz tertiary cue sensing cards optional. All units are capable of reproducing 3.5 kHz logging signals at NAB standard levels.
REMOTE CONTROL: All control functions operated by ground switching. All lamp circuits are also available from the remote sockets.
TAPE CARTRIDGE SIZES: Accepts NAB sizes A, AA, B, BB.
AMBIENT TEMPERATURE: 4° to 55°C (40° to 130°F).
EXTERNAL CONNECTORS: Latching type. Mating plugs furnished.
MOUNTING: Desk mount standard, rack mount optional.
DIMENSIONS: Desk mount: 11- $\frac{1}{8}$ inches high, 8- $\frac{1}{8}$ inches wide, 13 $\frac{1}{2}$ inches deep. Standard rack mount (2 units): 12 $\frac{1}{4}$ inches high, 19 inches wide, 13 $\frac{1}{2}$ inches deep.
NET WEIGHT: 38 pounds.

SPECIFICATIONS SUBJECT TO CHANGE WITHOUT NOTICE.

ORDERING INFORMATION

HOW TO ORDER: Order optional cue cards for second and third tones.
 Order rack adapters for rack mounting.

Criterion 90-3 playback, mono, desk mount, 1000 Hz cue, 60 Hz	994-7999-001
As above, except 50 Hz	994-7999-002
Criterion 90-3 playback, stereo, desk mount, 1000 cue, 60 Hz	994-8001-001
As above, except 50 Hz	994-8001-002
Rack mount adapter for two Criterion 90-3 units, or one Criterion 90-3 and one cartridge rack (see below)	994-8045-001
Cartridge rack for one side of rack adapter (holds up to 20 size "A" or "AA" cartridges)	994-7697-001
Secondary cue card to sense 150 Hz cue tone	992-4822-001
Tertiary cue card to sense 8 kHz cue tone	992-4827-001



HARRIS
COMMUNICATION AND
INFORMATION PROCESSING

CB-1201 Precision Professional Turntable

- Stereo rumble better than -45 dB
- Rugged precision construction...only 3 rotating parts
- Full speed in less than 1/16 revolution
- Front panel controls
- Three speeds
- No 45 RPM spindle required
- Speed may be changed with turntable operating
- Unique Teflon® coated sleeve on speed change lever



The Harris CB-1201 offers the ultimate in engineering excellence, and a high standard of accuracy in disc reproduction for on-air use and production work. In addition, operation and maintenance are simplified, as there are only three rotating parts in the unit.

The CB-1201 professional transcription turntable chassis provides both short and long term speed accuracy over a wide temperature and voltage range through the use of an extremely well balanced hysteresis synchronous motor and a low-friction dual oilite center bearing. The rugged motor, the simplified motor mounting, and an advanced shift mechanism all combine to provide top reliability, even with 24-hour-a-day use.

RUMBLE BETTER THAN -45 DB. Exceptionally low rumble has been achieved in the CB-1201 through precision engineering of the drive system. The motor is precision balanced with a ground steel three-step driving surface held to an accuracy of $\pm 0.0003''$. The idler wheel has an exclusive "shear action" to allow maximum drive torque with minimum vibration. The bearing of the idler is oil-impregnated sintered bronze rotating on a 10 micro-inch polished steel shaft held to an accuracy of $\pm 0.00015''$, further reducing rumble and wow and flutter.

The well-balanced platter rotates on a dual sintered, impregnated bronze bearing made with the same high precision as the idler rotating surfaces.

Measured below NAB reference of 1 kHz recorded at 3.54 cm/sec rms velocity, stereo rumble in the CB-1201 is better than -45 dB at 33 $\frac{1}{3}$ rpm, which compares with the best in the industry.

WOW & FLUTTER LESS THAN 0.1% (NAB unweighted). The heavy (6.9 lb.) machined aluminum platter in the CB-1201 provides for optimum flywheel action to help reduce wow and flutter while permitting very tight cueing. The virtually friction-free drive components further reduce the speed variations that also contribute to wow and flutter.

An exclusive innovation, the Teflon-sleeved speed change lever, allows frictionless "breathing" of the idler mechanism, and accounts for the exceptional sound reproduction quality.

SPEED ACCURACY BETTER THAN $\pm 0.3\%$. Because of the sophisticated bearing and drive surfaces, long term speed variations are reduced to a negligible level for the life of the turntable. Short term speed variation, sometimes misinterpreted as wow and flutter, is in the order of 0.001%.

RUGGED, DURABLE CONSTRUCTION. The rugged main frame is constructed of a one-piece machined casting of aluminum alloy. It is attractively styled in off-white, with front die-cast panel and heavy felt platter cover in contrasting blues.

The platter is recessed into the base for maximum protection, and is offset from the center of the base to allow plenty of clearance for arm swing. The platter is also specially designed to play 45's with no accessory spindle.

Specifications, ordering information, accessories on reverse side.

CB-1201 SPECIFICATIONS

TURNTABLE PLATTER: Cast aluminum; diameter, 12"; weight, 6.9 lbs.
CHASSIS SIZE: 16"x16"x2¼". Motor hangs 5½" below bottom of chassis.
FINISH: Base in off-white, with blue front panel. Platter cover in blue heavy felt.
CENTER BEARING: ¾" diameter dual oilite bearings.
MOTOR: Hysteresis synchronous, single phase, 1800 rpm. 117V 60 Hz, 117V 50 Hz, 220V 50 Hz.
CUEING: With dead motor start: at 33½ rpm, less than 1/16 (22.5°) turn; at 45 rpm, 1/10 turn; at 78 rpm, ½ turn.
NOISE OR RUMBLE: Stereo (below NAB reference of 1 kHz recorded at 3.54 cm/sec. rms velocity); -45 dB at 33½ rpm.
WOW AND FLUTTER: Less than 0.1%. NAB unweighted at 33½ rpm.
MOTOR START: By pushbutton switch on front panel.

SPEED CHANGE: To 33½, 45, or 78 rpm by single Teflon sleeved index lever control.
SPEED ACCURACY: Better than ±0.3% at 33½ rpm.
IDLER WHEEL: Shear action, concentric ground Neoprene, self-aligning.
POWER: 115 volts, ±10%, 60 Hz, 35 watts maximum (50 Hz model for 117V or 220 V available).
WEIGHT: 21 lbs. Net. Packed: domestic, 26 lbs; export, 50 lbs. Cubage: 1.3 cubic feet.

ORDERING INFORMATION

CB-1201 Turntable, chassis only, 60 Hz, 117V 994-7866-001
 CB-1201 Turntable, chassis only, 50 Hz, 117V 994-7866-002

TRANSISTORIZED IC TURNTABLE PREAMPLIFIER

Single-channel transistorized turntable preamplifier features low distortion and excellent frequency response. Designed for use in broadcasting, recording and for general sound requirements, Harris' IC preamp's input impedance of 47,000 ohms makes it compatible with virtually all magnetic cartridges (including stereo). It is self-equalized to the standard RIAA/NAB frequency response curve. Special mounting holes have been provided on the top of the preamplifier housing to "piggyback" a second unit for stereo operation.

The preamplifier is completely self-contained in an aluminum housing, and includes an integrated circuit, current booster and associated components, plus the output transformer and power supply.

SPECIFICATIONS

INPUT IMPEDANCE: 47,000 ohms.
MAXIMUM INPUT: 150 mV @ 1 kHz (clip point), 60 mV @ 1 kHz (+15 dBm output).
OUTPUT: -2 dBm with 9 mV input @ 1 kHz (typical cartridge level).
RESPONSE: Within ±1 dB of RIAA/NAB standard curve.
DISTORTION: Less than 0.5% at +15 dBm output, 30-15,000 Hz. Typically less than 0.1%.
NOISE: At least 85 dB below +15 dBm output, 20 Hz to 20 kHz. Typically below 93 dB.
LOAD IMPEDANCE: 600 ohms or 150 ohms, floating for grounded or ungrounded loads.
OPERATING AMBIENT TEMPERATURE RANGE: 0° to +60° C.
POWER: 117/234 volts, 50/60 Hz, 1 watt.
SIZE: 7-7/16" long, 3-½" deep, 2-1/16" high. Net weight, 1 lb.

ORDERING INFORMATION

Monaural IC Turntable Preamplifier 994-6690-003
 Stereo IC Turntable Preamplifier 994-6977-002

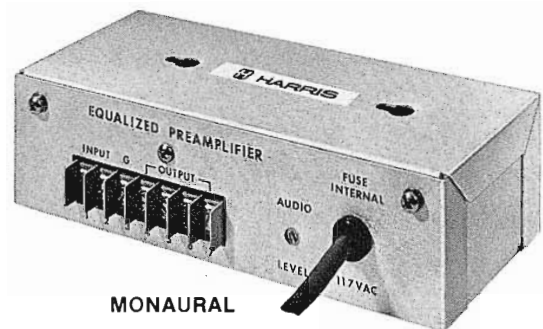

MONAURAL

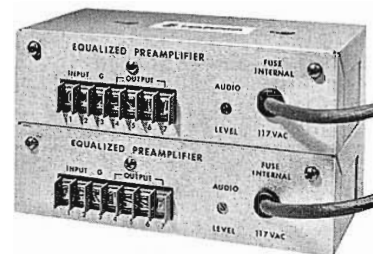

STEREO

12-INCH SYSTEM COMPONENTS

The following components are recommended to make up your 12-inch turntable system.

Monophonic System

CB-1201 turntable 994-7866-001
 303 Micro-Trak tone arm 723-0268-000
 Shure M44-7 stereo dynetic cartridge with .0007" diamond stylus 723-0236-000
 IC turntable preamplifier 994-6690-003

Stereo System

CB-1201 turntable 994-7866-001
 303 Micro-Trak tone arm 723-0268-000
 Shure M44-7 stereo dynetic cartridge with .0007" diamond stylus 723-0236-000
 IC turntable preamplifier 994-6977-002



HARRIS
COMMUNICATION AND
INFORMATION PROCESSING

RACK CABINETS AND ACCESSORIES

- 994-8477-001 RAK-80B Basic Rack, textured black finish 72" high, 25½" deep and 22½" wide with louvered top, louvered rear door, rear top cowling, two (2) sets of panel mounting angles with new EIA standard panel mounting hole spacing and panel mounting hardware. Less front trim and sides. 6¼" panel mounting space.
- 994-8478-001 RAK-80B Side Panel Kit for above, two panel included in kit. (Harris white finish).
- 448-0702-000 Lock w/key
- 994-8444-001 Front Trim Kit for single cabinet**
- 994-8444-002 Front Trim Kit for two (2) cabinets**
- 994-8444-003 Front Trim Kit for three (3) cabinets**
- 994-8444-004 Front Trim Kit for four (4) cabinets**
- 994-8471-001 Louver Closure Panel for rear door.
**Front trim finished in brushed aluminum with Harris blue insert.
- 994-8430-002 * RAK-90 Basic Rack, textured black finish, 78" high, 22" deep, 22½" wide with louvered top, louvered rear door, two (2) sets of panel mounting angles (One set fixed and one set movable) with EIA standard hole spacing and panel mounting hardware. 70" panel mounting space. Less trim and sides.
- 994-8433-001 * RAK-90 side panel kit, two panels and mounting hardware in kit. (Harris white finish).
- 994-8444-001 * Front Trim Kit for single cabinet**
- 994-8444-002 * Front Trim Kit for two (2) cabinets**
- 994-8444-003 * Front Trim Kit for three (3) cabinets**
- 994-8444-004 * Front Trim Kit for four (4) cabinets**
- 994-8471-001 * Rear door louver closure kit, contains two (2) panels and mounting materials.
* **Front trim finished in brushed aluminum with Harris blue insert.
- 448-0648-000 RAK-86 Basic Rack, textured black finish, 78¾" high, 25½" deep and 22½" wide with louvered top, louvered rear door, rear top cowling, two (2) sets of panel mounting angles with new EIA standard panel mounting hole spacing and panel mounting hardware. Less front trim and sides. 70" panel mounting space.
- 448-0649-000 Same as above but with non-louvered rear door.
- 448-0650-000 RAK-86 Side Panel Kit, two panels included in kit (Harris White finish).
- 448-0559-000 Door Handle w/Lock.
- 448-0591-000 Front Trim Kit for single cabinet.**
- 448-0592-000 Front Trim Kit for two (2) cabinets.**
- 448-0593-000 Front Trim Kit for three (3) cabinets.**
- 448-0594-000 Front Trim Kit for four (4) cabinets.**
**Front trim finished in brushed aluminum with Harris blue insert.
- 448-0636-000 RAK-96 Basic Rack, (for mounting 24" wide panels) textured black finish, 69¾" high, 25½" deep and 27" wide with louvered top, louvered rear door, rear top cowling, two (2) sets of panel mounting angles with new EIA standard panel mounting hole spacing and panel mounting hardware. Less front trim and sides 6¼" panel mounting space.

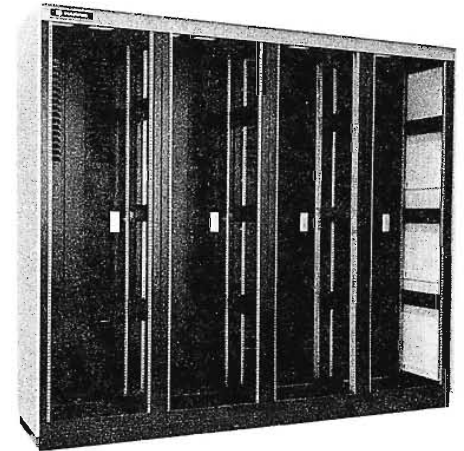
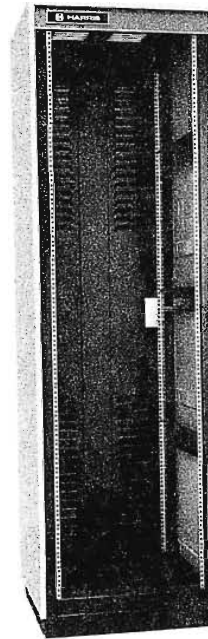

- 448-0637-000 Front Trim Kit for single RAK-96 cabinet**
- 448-0638-000 Front Trim Kit for two (2) RAK-96 cabinets**
- 448-0559-000 Door Handle w/Lock
**Front trim finished in brushed aluminum with Harris blue insert.
- 448-0640-000 RAK-9 Rak Cabinet, 78" high, 22" wide and 18" deep, 71¼" panel mounting space. Complete with sides, non-louvered top, louvered rear door and panel mounting hardware. Standard EIA hole spacing. Black textured finish.
- 994-5527-003 RAK-7 Rak Cabinet, 78" high, 23½" wide and 19½" deep, 71¼" panel mounting space. Complete with sides, non-louvered top, louvered rear door and panel mounting hardware. Standard EIA hole spacing. White textured finish.
- 265-0061-000 Plugmold (10 out.) w/Ent. Fit.
- 432-0214-000 Blower/Panel Assembly (150 CFM)
- 432-0225-000 Blower/Panel/Filter Assembly 150 cfm, panel size 5¼" x 19", 115 VAC, 50/60 Hz
NOTE: Blower/Panel Assemblies are 19" wide, 3½" high and 12½" deep. Finished bright chrome.
- 992-2539-001 Panel Mounting Hardware
- 994-6890-002 * Terminal board mounting kit for RAK series of racks, mounts ADC PJ-100 & Thomas & Betts CB-120 terminal boards.
- 994-6891-001 Pre-wired jack panel and terminal board.

ACCESSORIES

BLANK PANELS

- 831-5483-003 Blank panel, 19" x 1¼" W/HF-88 126 Black Pebbletex Finish
- 831-5483-011 Blank panel, 19 x 3½" W/HF-88 126 Black Pebbletex Finish
- 831-5483-019 Blank panel, 19" x 5¼" W/HF-88 126 Black Pebbletex Finish
- 831-5483-027 Blank panel, 19" x 7" W/HF-88 126 Black Pebbletex Finish
- 831-5483-035 Blank panel, 19" x 8¾" W/HF-88 126 Black Pebbletex Finish
- 831-5483-043 Blank panel, 19" x 10½" W/HF-88 126 Black Pebbletex Finish
- OTHER
- 994-7001-001 * Power Control Panel Provides on-off switching of 110 VAC and/or VAC, 19"x 3½" x 3½"

Chronology of Contents

PDM Pulse Duration Modulation
PSM Progressive Series Modulator

Medium Wave Broadcast Transmitters

VP-100A 100,000 watt
MW-50A 50,000 watt
MW-10 10,000 watt
MW-5A 5,000 watt
MW-1A 1,000 watt

Antenna Phasing Equipment
AM-80 MW modulation monitor
AF-80 MW frequency monitor
MW Transportable completely assembled MW
Transmitting Station

Short Wave Broadcast Transmitters

SW-100 100,000 watt
SW-50 50,000 watt

FM Broadcast Transmitters

FMD-50K 50 kilowatt
FM -40K 40 kilowatt
FM-25K 25 kilowatt
FM-20K 20 kilowatt
FM-10K 10 kilowatt
FM-5K 5 kilowatt
FM-2.5K 2.5 kilowatt
FM 1K 1 kilowatt
FM-300KD/FM-300K 300 watt

MS-15 maximum signal FM exciter
MS-15R FM stereo generator

Circularly Polarized FM Antennas

FMH Super Power
FML low power
FMP self-supporting
FMS Dual Cycloid

Directional Dual Polarized FM Antennas
FM Antenna Accessories/Isolation Transformers
Service & Training
Cyclotron System for CP TV Signal Transmission
Transmitter Powers - AM-FM-TV

VHF Color TV Transmitters

TV-50H/TVD-100H 50 kilowatt/ 100 kilowatt dual high band
TVD-50H 50 kilowatt dual high band
TVD-36H 36 kilowatt dual high band
TV-25H 25 kilowatt high band
TV-18H 18 kilowatt high band
TV-10H 10 kilowatt CCIR Band III
BTD-50L2 50 kilowatt dual low band
BTD-36L2 36 kilowatt dual low band
BT-35L2 35 kilowatt low band
BT-25L2 25 kilowatt low band
BT-18L2 kilowatt low band

MCP-IV VHF-TV Visual Exciter/Modulator

UHF Color TV Transmitters

TV-110U 110 kilowatt
TV-60U 60 kilowatt
TV-55U 55 kilowatt
TV-30U 30 kilowatt

MCP 1U Visual Exciter/Modulator

Circularly Polarized TV Antennas

CPV
CBR cavity backed radiator
Traveling Wave Helical Antenna

Live Color TV Cameras

TC-80A (automatic)
TC-80 add-on triax cable system
TC-50

Digital Video Equipment

Epic computer-aided editing system
CVS 516 digital TBC
CVS 517 digital TBC
CVS 520 digital TBC
CVS 630 digital frame synchronizer

Audio

Harris 9100 facilities control for radio or TV
Harris 9000 program control
M90 modular control console
M90 modular on-air control console
Executive 10-channel stereo control console
Stereo 80 8-channel stereo control console
Stereo 5 solid-state 5 channel control console.
Gateway 80 solid-state 8-channel control console
Mono 5 solid-state 5-channel control console
MSP-100 audio processor for AM-FM-TV
MSP-90 audio processor
MSP-90 tri band AGC audio processor
Criterion 90-1 & 90-2 tape cartridge systems
Criterion 90-3 tape cartridge playback
CB-1201 precision professional turntable

Rack Cabinets and Accessories

The mechanical and electrical design of the equipment described herein is subject to change without notice as deemed necessary by the Broadcast Products Division of Harris Corporation or its suppliers, in the interest of advancing industry requirements or the state of the art.

HARRIS



**COMMUNICATION AND
INFORMATION PROCESSING**

© HARRIS CORPORATION, 1980

**MAIN OFFICE AND MANUFACTURING FACILITIES
QUINCY, ILLINOIS 62301**

P.O. Box 4290
Phone: 217-222-8200
Telex: 404347
Twx: 910-246-3212
Cable: GARCO

DISTRICT OFFICES

CULVER CITY, CALIFORNIA 90230

5839 Green Valley Circle
Suite 200
Phone: 213-642-0052

NEW YORK, NEW YORK 10017

675 3rd Avenue
Phone: 212-986-7600

WASHINGTON, D.C. 20037

2600 Virginia Avenue, NW
8th Floor
Phone: 202-342-3946

HOUSTON, TEXAS 77036

7000 Regency Square Blvd.
Suite 200
Phone: 713-977-2411

CANADIAN SALES

MONTREAL OFFICE

212 Brunswick Blvd.
Pointe-Claire, Quebec, Canada H9R 1A6
Phone: 514-694-3371

TORONTO OFFICE

19 Lesmill Road
Don Mills, Ontario, Canada M3B-2T3
Phone: 416-441-2400

INTERNATIONAL SALES OFFICE

QUINCY, ILLINOIS

P.O. Box 4290
Phone: 217-222-8200

HARRIS CORPORATION Broadcast Products Division
P.O. Box 4290, Quincy, Illinois 62301 U.S.A.

BOUND PRINTED BLK RT
US POSTAGE
PAID
Shawnee Mission, KS
Permit No. 243