

MCMARTIN

**1000/500/250 watt
AM
TRANSMITTER**

BA-1K

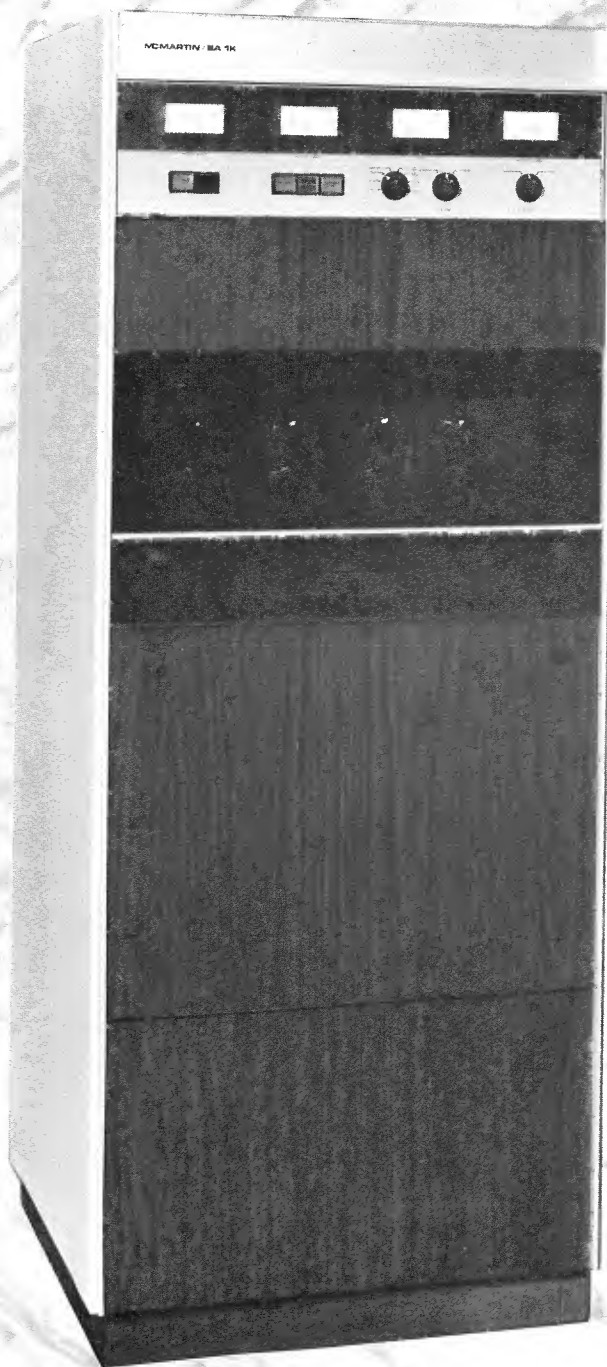

excellent performance specifications for that crisp, clean sound
unique accessibility both front and rear
125% positive peak capability
power driven vacuum variable tuning/loading controls
1200 watts output with pushbutton Hi-Lo power operation
full remote control/metering capability
built-in dummy load
totally solid state except for four 4-500A tubes
that provide rugged, reliable, economic operation

MCMARTIN

DESCRIPTION

The BA-1K delivers outstanding performance and reliability. It sounds clean and crisp... and it stays on the air. Initial investment is reasonable. Operating and maintenance costs, low.

We can't do anything about your programming to attract and hold an audience, but the BA-1K makes your programming sound great... and by selection of quality components and application of conservative design details, the BA-1K delivers reliability.

The BA-1K satisfies technical demands for ease of initial installation, tune-up and maintenance. Access to subassemblies and components is outstanding. By opening the hinge-down front panel, all solid-state low level AF and RF stages and the low-voltage control power supply are easily inspected and adjusted.

The blower assembly is mounted on the inner surface of the hinged rear door for 'out-in-the-open' maintenance.

The RF power amplifier, and the modulator stages each use a pair of highly-reliable, moderately priced 4-500A tubes. During operation these tubes are visible through the cabinet front observation window.

The RF power amplifier output consists of a tuning/matching full pi-T network. Plate tuning is by means of a motor-driven vacuum capacitor. Output loading is adjusted by a motor-driven slug located concentrically in the output T-network inductor. The shunt capacitor in the output T-section, in conjunction with an adjustable tap on the input inductor of the T, permits precise adjustment for maximum second harmonic attenuation.

The BA-1K incorporates a built-in dummy load.

The modulator stage uses a high-quality, oil-filled modulation transformer, capacity-coupled to a modulation reactor to isolate RF power amplifier plate current from the modulation transformer secondary winding.

The RF exciter and AF driver stages are completely solid-state. The crystal oscillator operates in the 2160 to 4320 kiloHertz range. The operating frequency range of 540 to 1600 kHz is established by division of the crystal frequency by four for the range from 540 to 1080 kHz and by two, to cover the 1090 to 1600 kHz range.

The AF driver stages operating Class A are of solid-state design up to the grids of the 4-500A AB1 modulator tubes. Resistor-capacitor feedback networks give sufficient feedback compensation.

The BA-1K is fully metered. Individual, eye-level 4 1/2" panel meters display PA plate current and voltage, RF line current, plus a nine-position multimeter for measurement of secondary operating parameters.

The BA-1K may be operated by remote control. All mechanical drives for plate tuning and output loading as well as on/off/power change switching are terminated for ready interconnection to standard remote control systems.

The BA-1K has 1200-watt output capability, leaving a more-than adequate power reserve. This permits smooth 125% positive peak modulation and reflects the truly conservative design factors which contribute to BA-1K reliability.

The BA-1K is handsomely-styled in an extremely rugged steel cabinet. Removable side panels give ready access to wiring harnesses. Those within the cabinet are housed in protective channelling.

The BA-1K—a pleasure to own—a pleasure to maintain—a pleasure to listen to!

SPECIFICATIONS

FREQUENCY RANGE	540 to 1600 kiloHertz (supplied on one specified frequency)
POWER OUTPUT	1000/500/250 watts May be operated at any two specified power levels. Pushbutton power change standard. Maximum output capability: 1200 watts
OUTPUT IMPEDANCE	50 ohms unbalanced Other impedances available on special order
FREQUENCY STABILITY	±5 Hertz over ambient temperature range
CARRIER AMPLITUDE REGULATION	3% maximum
NOISE LEVEL	60 dB or greater below 100% modulation @ 1000 Hertz
MODULATION CAPABILITY	100% negative peaks 125% positive peaks
AF FREQUENCY RESPONSE	±1.0 dB, 50-10000 Hz 1-kw output, 100% modulation
AF HARMONIC DISTORTION	2.5% or less, 50-1000 Hz 1-kw output, 100% modulation Sine wave input
AUDIO INPUT IMPEDANCE	150/600 ohms, balanced
AUDIO INPUT LEVEL	+10, ±2, dBm
POWER SOURCE	208/230 Vac, 50/60 Hz, single phase three-wire (grounded neutral)
POWER CONSUMPTION	3,000 watts, no modulation 3,500 watts, 100% modulation
AMBIENT TEMPERATURE RANGE	-20 to +45 degrees Celsius
ALTITUDE	up to 7500 feet AMSL
DIMENSIONS	70.5" (179 cm) height 25.75" (65.4 cm) depth 28.25" (71.8 cm) width

ORDERING INFORMATION

MODEL BA-1K	1000/500/250 watt transmitter (Specify operating frequency and power levels desired)
SC-AM	Spare Vacuum Crystal
STA-1K	100% Spare Tube Kit (4 Type 4-500A)
SSC-1K	100% Spare Semiconductor Kit
SR-1K	Filament Voltage Regulator
PT-1K	Line transformer for 220/240 Vac, 10, 2-wire, primary power source (external mounting)

3,000 watt
AM
TRANSMITTER **BA-2.5K**

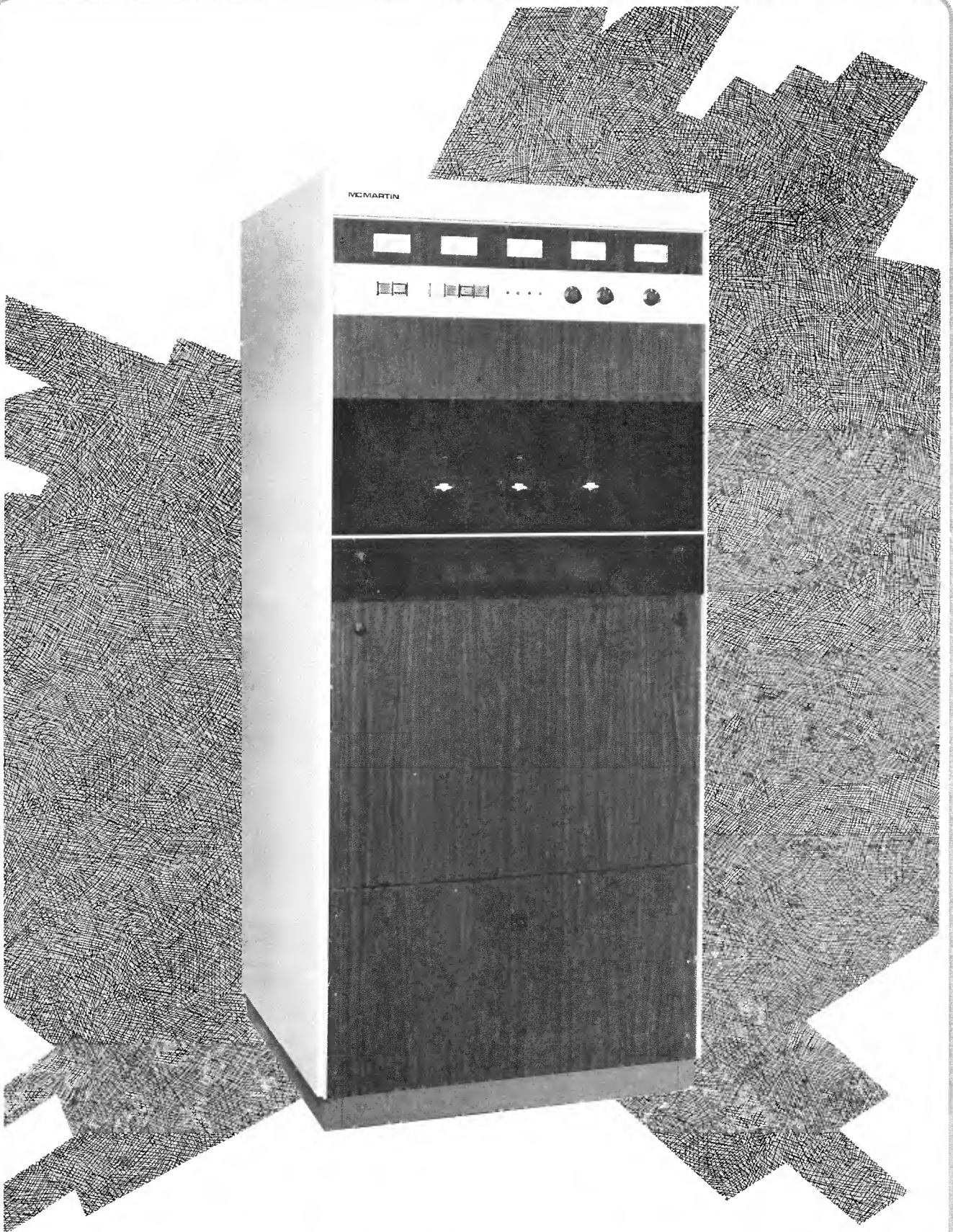

MCMARTIN

the McMARTIN BA-2.5K TRANSMITTER

Designed to meet export requirements for 3,000-watt AM broadcast service, the McMARTIN Model BA-2.5K provides a conservatively-rated transmitter for the new 2.5 KW power output level recently authorized in the U.S. by the Federal Communications Commission.

Completely solid-state, other than the high-powered RF output PA and modulator stages, only one type tube is required, the field-proved, 4-1000A. Two of these tubes are operated in parallel in the RF PA stage and another pair in the Class AB-1 modulator stage.

The BA-2.5K delivers outstanding performance and reliability. Access to sub-assemblies and components is outstanding. Patterned after the well-accepted mechanical configuration introduced in the McMARTIN BA-1K transmitter, the BA-2.5K features a hinge-down front panel by means of which all solid-state low level AF and RF stages are readily inspected and maintained.

The cabinet blower assembly, with maintainable air filters is conveniently mounted on the inside of the hinged rear door for "out-in-the-open" accessibility.

The four 4-1000A's are visible during operation through a cabinet front observation window.

Low harmonic radiation is insured by incorporation of a dual-pi PA output network with provision for independent series resonating of one leg of the network at the second harmonic of the operating frequency. Output tuning and loading is performed by easily-removable motor-driven controls.

The RF exciter and audio driver stages are completely solid-state. The crystal oscillator operates in

the 2,160 to 4,320 kiloHertz range, where the inherent stability of quartz crystals is superior. An output operating frequency between 540 and 1,080 kHz is derived by digital division by four; and between 1,090 and 1,600 kHz by division by two.

The BA-2.5K is fully metered. The operating parameters for RF line current, PA plate voltage and current and AC line voltage are separately shown on large 4½", eye-level meters. In addition, an 8-position multimeter permits selective metering of individual stage/element operation.

Solid-state overload protection circuitry with automatic recycling and status indication is standard. The recycling sequence will automatically replace the BA-2.5K to its normal operating mode for three overload situations occurring within a 30 second time period. The source of the overload condition is stored in memory and displayed on LED indicators which can be reset only manually after a fault occurs.

The BA-2.5K will interface with all standard remote control systems by simple interconnection to the relay-controlled motor-driven mechanisms in the transmitter. Sampling voltages for telemetry of PA plate voltage and current; and RF output line current are terminated in the BA-2.5K for convenient connection to remote control systems.

With its 3000-watt output capability, the McMARTIN BA-2.5K transmitter insures more-than-adequate power reserve, with extremely smooth 125% positive peak modulation and extended-life component reliability.

The McMARTIN BA-2.5K is a pleasure to own, a pleasure to maintain—and most importantly, a pleasure to listen to.

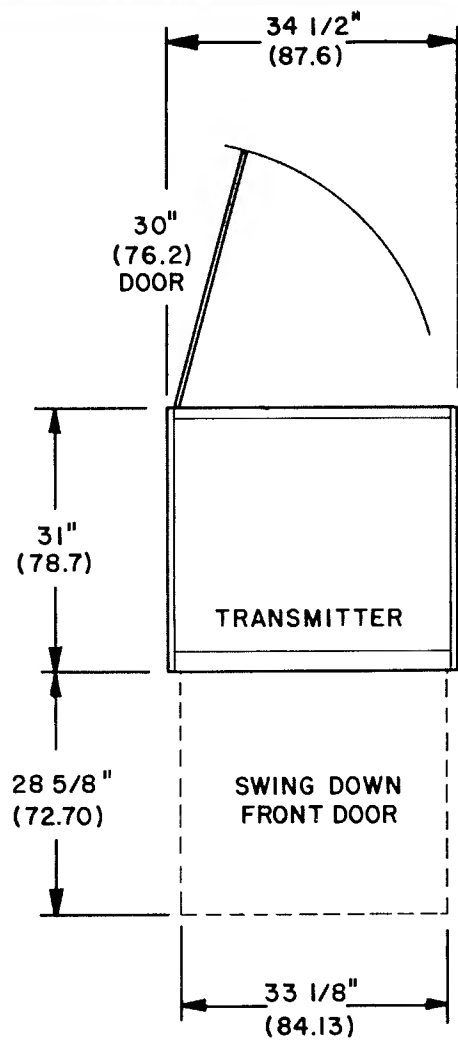
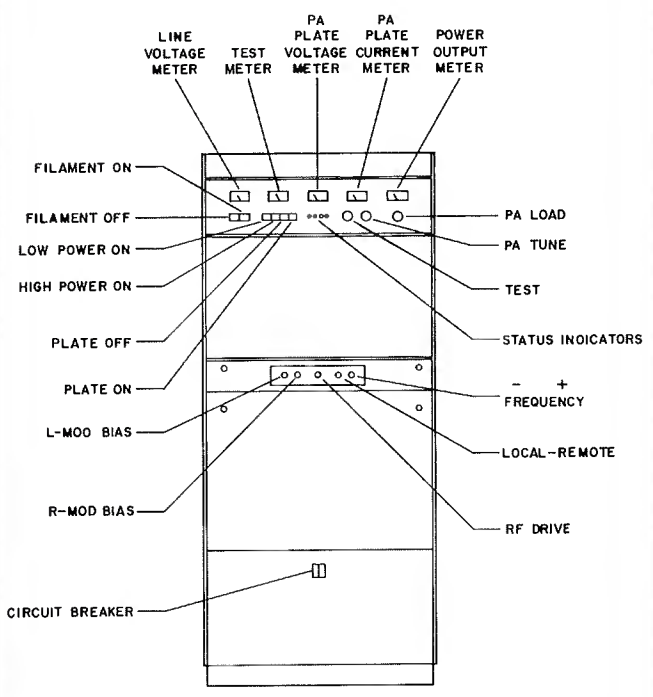
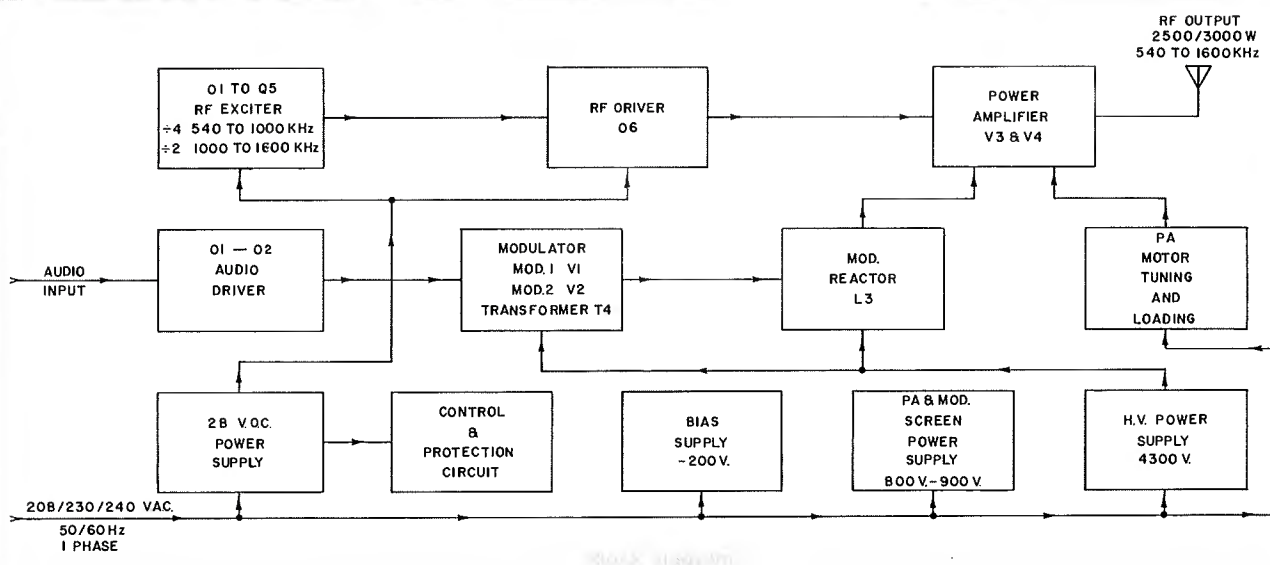

DIMENSIONS IN ()
GIVEN IN CENTIMETERS

SPECIFICATIONS

FREQUENCY RANGE 540 to 1600 kiloHertz (factory tuned & tested on one specified frequency)

POWER OUTPUT 3,000 watts. May be operated at any two specified power levels. Pushbutton power change standard.

OUTPUT IMPEDANCE 50 ohms unbalanced. Other impedances available on special order.

FREQUENCY STABILITY ±5 Hertz over ambient temperature range

CARRIER AMPLITUDE REGULATION 3% maximum

NOISE LEVEL55 dB or greater below 100% modulation @ 1,000 Hertz

MODULATION CAPABILITY 100% negative peaks
125% positive peaks

AF FREQUENCY RESPONSE ±1.5 dB, 50-10,000 Hz, 3.0 KW output, 100% modulation

AF HARMONIC DISTORTION 2.5% or less, 50-10,000 Hz, 3.0 KW output, 100% modulation, Sine wave input

AUDIO INPUT IMPEDANCE 150/600 ohms, balanced

AUDIO INPUT LEVEL +10, ±2, dBm

POWER SOURCE 208/230 Vac, 50/60 Hz, single phase

POWER CONSUMPTION 0% modulation
3,000W output: 8,100W
2,500W output: 6,700W
100% modulation
3,000W output: 10,300W
2,500W output: 8,800W
Power factor: 0.90

LINE VOLTAGE VARIATION ±5%

AMBIENT TEMPERATURE RANGE -20 to +50 degrees Celsius

ALTITUDE up to 7,500 feet AMSL

DIMENSIONS 78.5" H x 31.0" D x 34.5" W
(199 cm x 78.7 cm x 87.6 cm)
Rear door swing: 30" (76.2 cm)

FEB/77

5,000 watt
AM
TRANSMITTER **BA-5K**

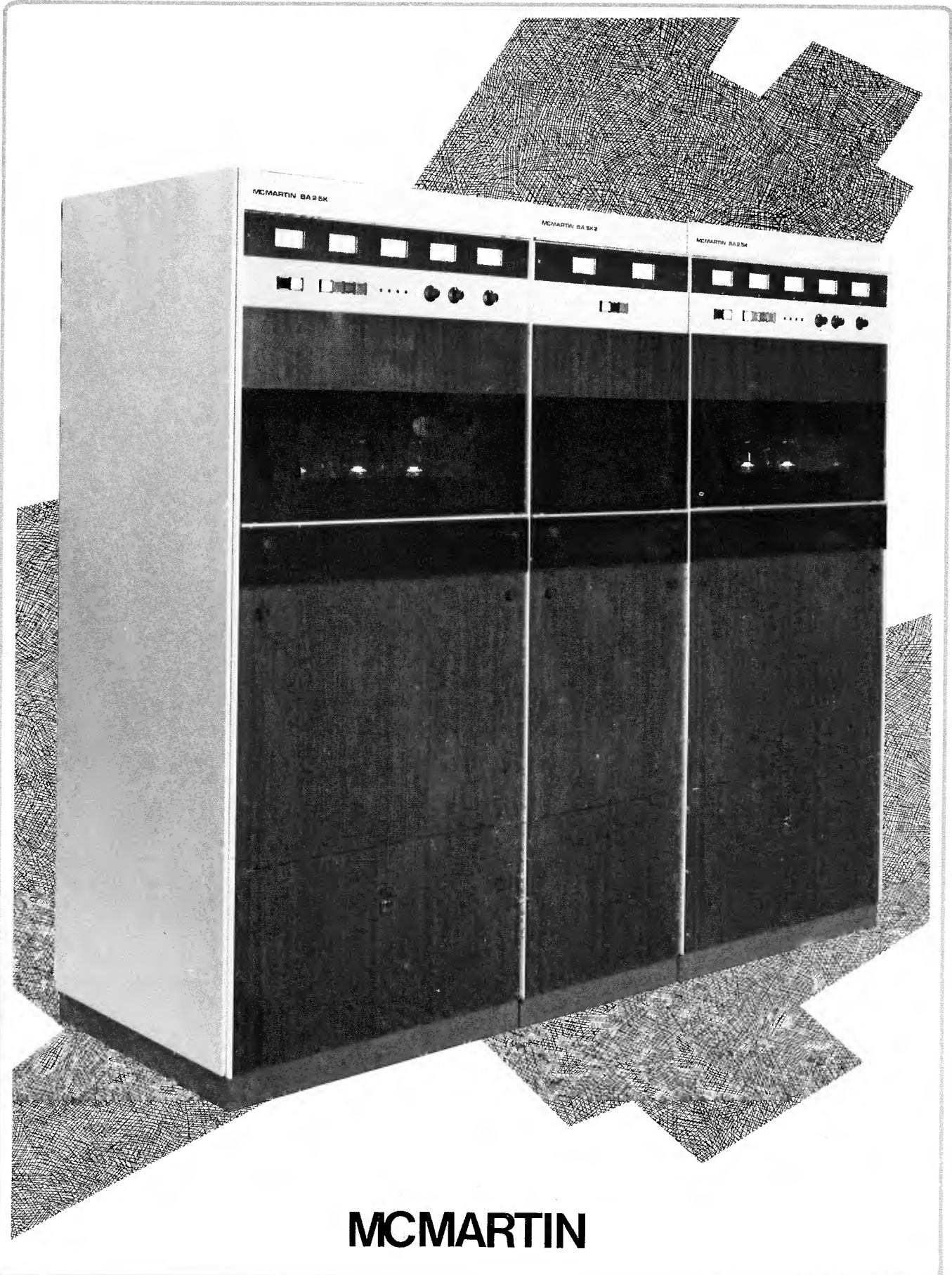

MCMARTIN

the MCMARTIN BA-5K TRANSMITTER

The McMartin BA-5K AM Broadcast Transmitter consists of two BA-2.5K transmitters and a combiner cabinet. The BA-5K delivers up to 6,000 watts of RF output power.

A matching, 19-inch combiner cabinet, located between the two BA-2.5K cabinet assemblies, houses the combining network, reject load, common oscillator, and transfer switching as well as the switching control panel. The self-contained BA-5K equipment occupies floor space approximately 90" wide by 31" deep and is 78.5" high. Power supplies are self-contained.

The redundant BA-2.5K transmitters and combining network assure uninterrupted broadcasting at no less than one-quarter of the normal combined output power in the event of failure, including loss of modulation, of one of the BA-2.5K units. The RF output of both transmitters is fed into the RF power combiner which offers the proper load to both transmitters and the proper source to the transmission line. It also provides complete protection in the event of failure of either transmitter by maintaining the proper load to the remaining unit. Essentially the combiner allows two transmitters to operate in parallel with the proper termination.

The control circuitry allows either transmitter to be operated separately at full or reduced power where dual power operation is a requirement.

For optimum operation and reliability, RF switching of the power combiner is accomplished by means of three vacuum relays of ceramic construction which permits front panel pushbutton full power

combined operation or switching of either transmitter directly to the load. The switching arrangement is such that when one unit is connected to the load, the remaining transmitter is automatically routed to an external dummy load.

Each BA-2.5K unit is driven by split-power output from a common oscillator which is also located in the control panel assembly.

The specifications for the BA-5K are essentially identical to those shown for the BA-2.5K, except for power output, power consumption, and dimensions. Only one tube type is used in the BA-5K. Solid-state circuitry in the low power RF and audio stages and silicon rectifiers in all power supplies assure reliable performance and low operating costs.

The advantages of dual transmitter operation include:

- Uninterrupted transmission at one-quarter power, if a tube fails in either the modulator or final amplifier.
- Faulty transmitter can be repaired while other transmitter is on the air.
- More dollar value, more power, more reliability per watt.
- Single-phase power—no expensive three-phase transformers and components.

The McMartin Model BA-5K transmitter satisfies the most demanding requirements for uninterrupted AM broadcasting service, enhanced by excellent performance characteristics.

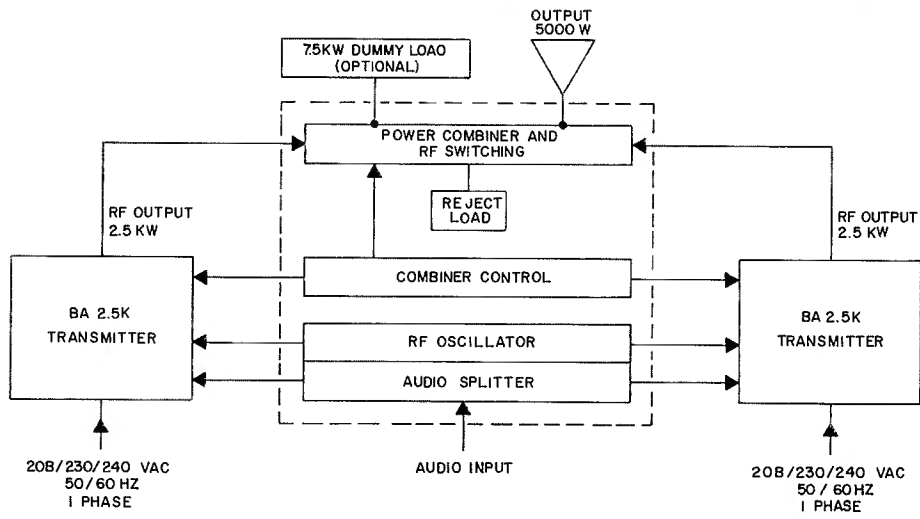

Block diagram

Floor plan dimensions

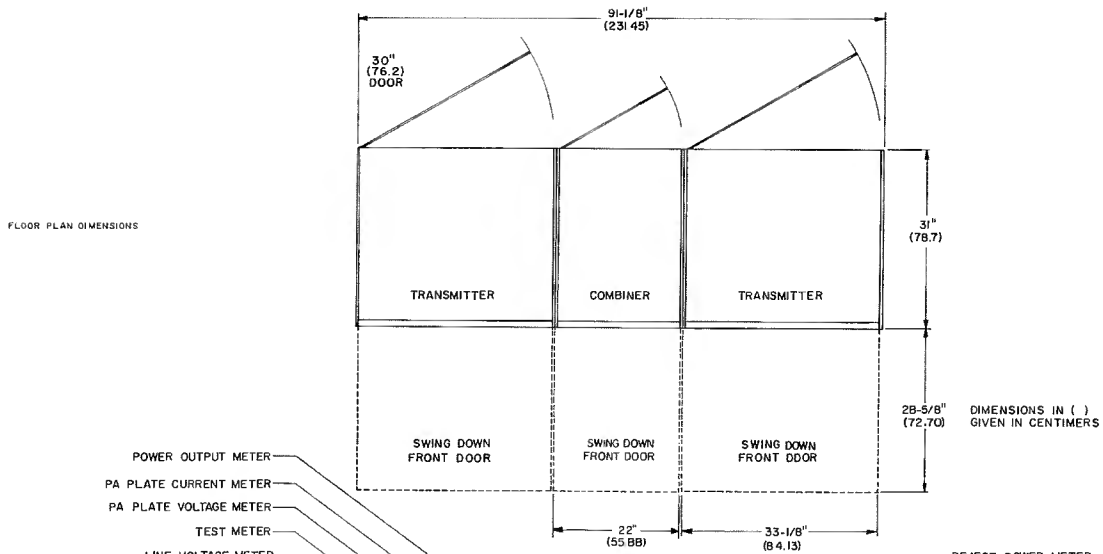

FLOOR PLAN DIMENSIONS

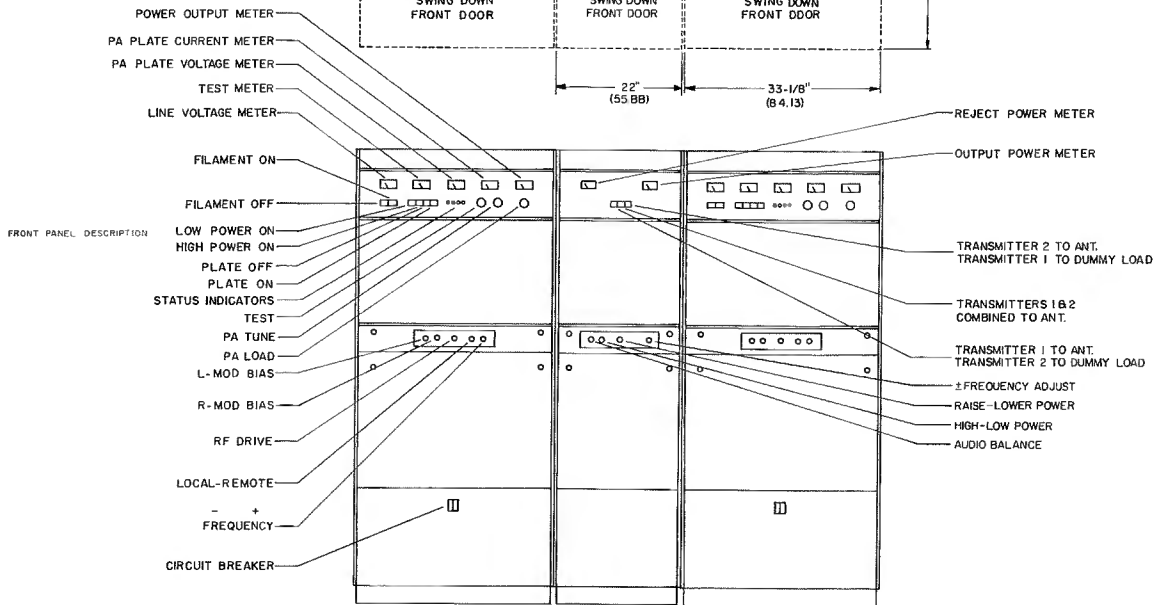

Front panel description

SPECIFICATIONS

TYPE OF EMISSION	A3	MODULATION CAPABILITY	100% negative peaks 125% positive peaks
FREQUENCY RANGE	540-1600 kHz	NOISE LEVEL55 dB or greater below 100% modulation
POWER OUTPUT CAPABILITY6000 Watts. May be operated at any two specified power levels. Pushbutton power change standard.	CARRIER AMPLITUDE REGULATION3% maximum
CUTBACK CAPABILITY2500, 1000, 500 watts	POWER SOURCE208/230/240 VAC, 50/60 Hz, single phase
OUTPUT IMPEDANCE50 ohms, unbalanced	POWER CONSUMPTION AT (5000 WATT)13.6 KW (0% modulation) 14.2 KW (40% modulation) 17.2 KW (100% modulation)
FREQUENCY STABILITY	±5 Hz	LINE VOLTAGE VARIATION	±5%
AUDIO INPUT IMPEDANCE	150/600 ohms, balanced	AMBIENT TEMPERATURE RANGE	-20 to + 45 degrees Celsius
AUDIO INPUT LEVEL	+10, ±2, dBm	ALTITUDE	Up to 7500 feet above sea level
AUDIO FREQUENCY RESPONSE	±1.5 dB, 50-10,000 Hz @ 85% modulation	DIMENSIONS56" (142.2 cm) width 79" (200.7 cm) height 30" (76.2 cm) depth
AUDIO HARMONIC DISTORTION2.5% or less, 50-10,000 Hz @ 100% modulation		

10,000 WATT AM TRANSMITTER

BA-10K

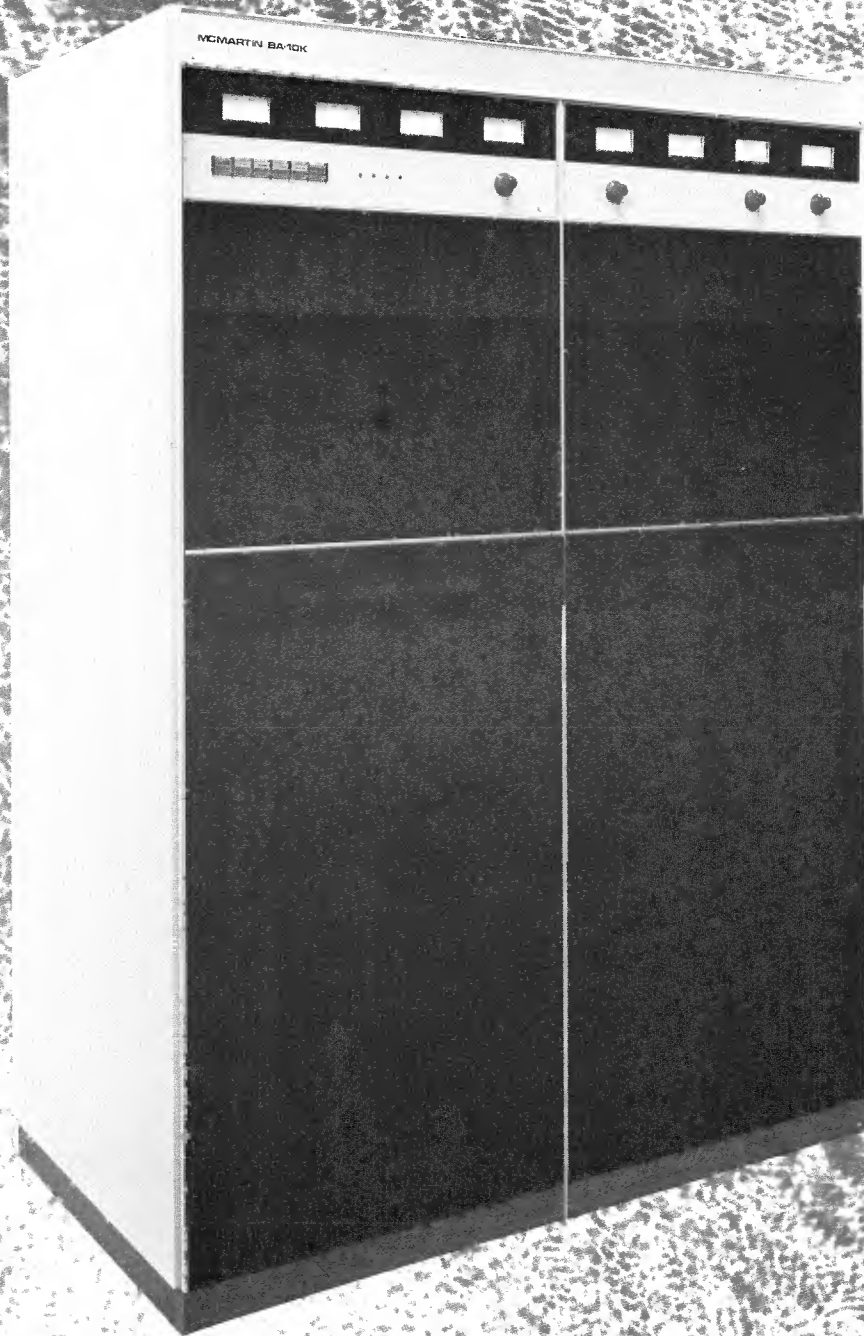

MCMARTIN

MC MARTIN BA-10K TRANSMITTER

LOW OPERATING COSTS

ONLY ONE TUBE TYPE, FOUR TOTAL

SOLID STATE RF DRIVER

SOLID STATE AUDIO DRIVER

DUAL CRYSTAL OSCILLATORS

HIGH PA EFFICIENCY

125% POSITIVE PEAK CAPABILITY

OIL FILLED MODULATION TRANSFORMER

EASY ACCESS FRONT AND REAR

1% RIPPLE POWER SUPPLY—NO FILTER CHOKE

Designed to meet the domestic and export requirements for 10,000 watt AM broadcast service, the McMartin Model BA-10K provides an extremely conservative-rated transmitter. The transmitter was designed to accept and reproduce standard or highly processed audio and deliver the 125% positive peaks demanded by broadcasters today.

The transmitter is completely solid state other than the high-powered RF output power amplifier and modulator stage. Only one tube type is used in these stages, 4CX5000A. Two of these tubes are operated in parallel in the RF power amplifier and another pair in the class AB-1 push-pull modulator.

The BA-10K delivers outstanding performance and reliability. Access to sub assemblies and components is outstanding. Patterned after the well-accepted, mechanical configuration introduced in the McMartin lower-powered AM transmitter, the BA-10K features two hinged-down front panels by means of which all solid-state low level AF and RF stages are readily inspected and maintained.

A pair of high efficiency blowers are used to cool the four high-powered tubes. The rear hinged doors have mounted on them the permanent type air filters with safety guards for "out-in-the-open" accessibility.

Low harmonic radiation is insured by incorporation of a dual-P1 power amplifier, output network with provision for independent series resonating of one leg of the network at the second harmonic of the operating frequency. Output tuning and loading is performed by built-in motor-driven controls with remote control standard.

The RF exciter and audio driver stages are completely solid state. The crystal oscillator operates in the 2 to 4 MHz range where the inherent stability is best then divided to the proper frequency between 540 and 1,600

kHz. A two crystal accessory is available for export use on special request.

The BA-10K is fully metered, enabling the operator to readily observe the operation of numerous circuits normally omitted in similar transmitters: Individual filament voltage, individual PA and modulator cathodes are typical examples. A total of nine meters are provided with a multimeter and 11 position rotary switch. All primary function meters are 4½" eye level meters with flush mounted lenses.

Solid state overload protection circuitry with automatic recycling and status indication is standard. The recycling sequences will automatically replace the BA-10K to its normal operating mode for three overload situations occurring within a 30 second time period. The source of overload condition stored in memory and displayed on LED indicators which can be reset only manually after a fault occurs.

The BA-10K will interface with all standard remote control systems by simple interconnections to the relay-controlled motor-driven mechanism in the transmitter. Tuning is accomplished by a motor-driven vacuum capacitor and loading is accomplished by a motor-driven permeability tuned coil (no sliding contacts).

Sampling voltages for telemetry of PA plate voltage, and current and RF output line current are terminated in the BA-10K for convenient connection to remote control systems.

With 11 kw output capability, the McMartin BA-10K transmitter insures more-than-adequate power reserve, with extremely smooth 125% positive peak modulation and extended-life component reliability.

The McMartin BA-10K is a pleasure to own, a pleasure to maintain, and most importantly, a pleasure to listen to.

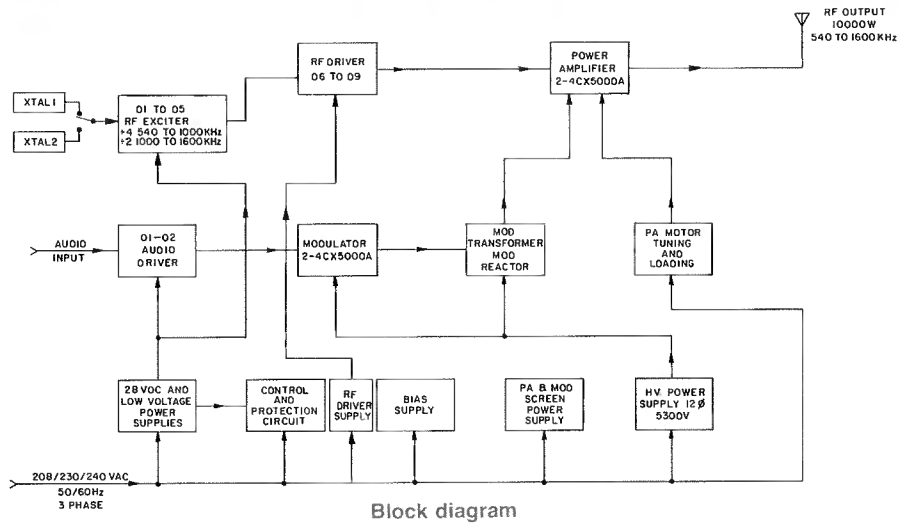

PA tuning—
Permeable tuning,
no moving contacts

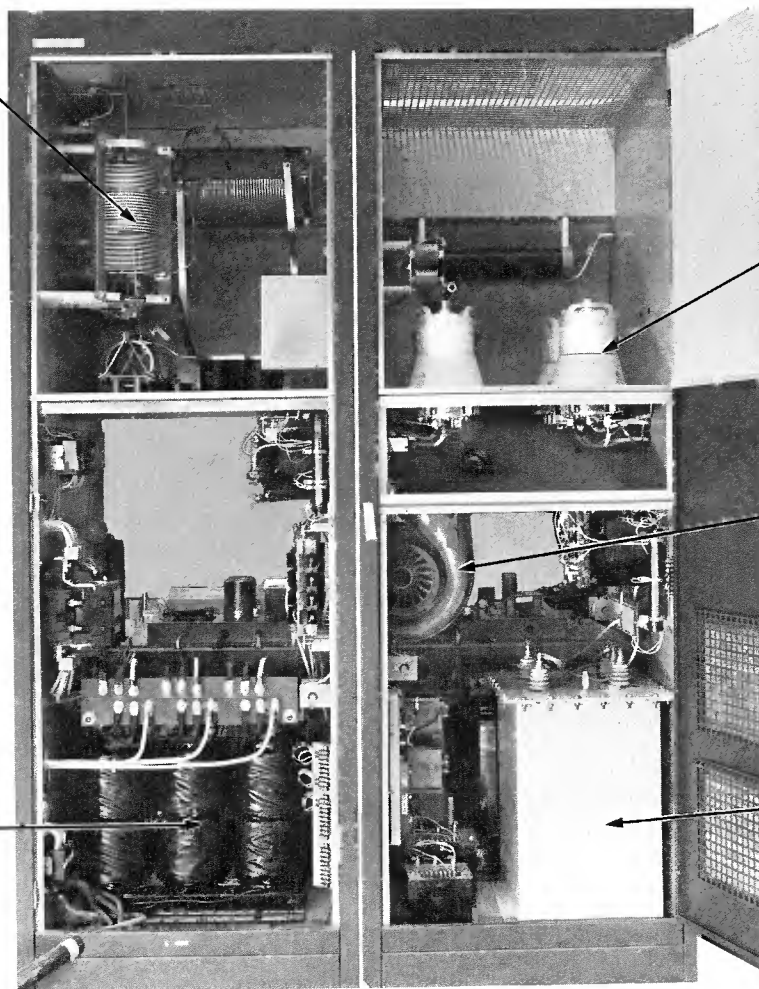

(4) 4CX5000A

(2) P.A.
Blowers

Oil Filled
Modulation XFMR

HV Plate XFMR

Rear view of BA-10K

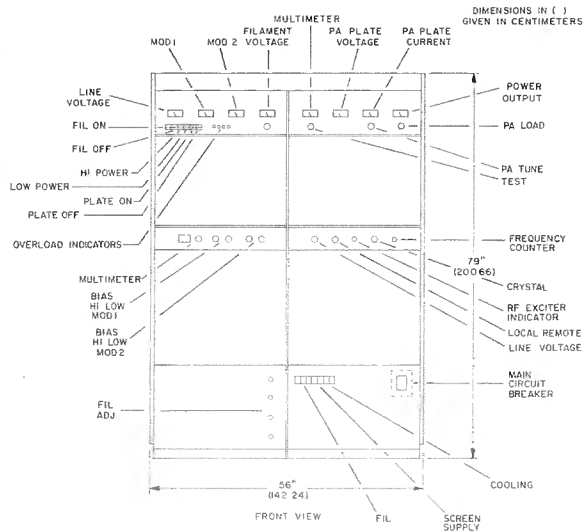

Front panel description

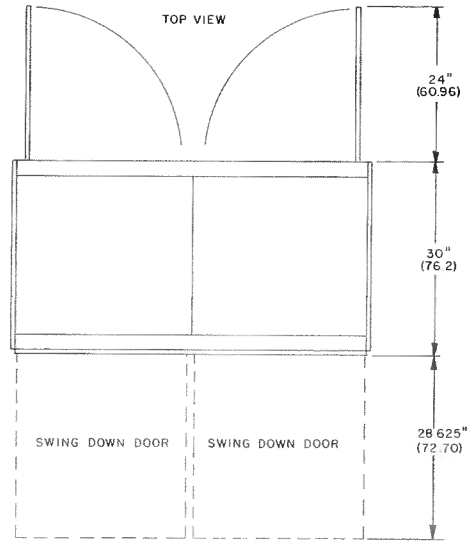

Floor plan

SPECIFICATIONS

TYPE OF EMISSION	A3
FREQUENCY RANGE	540-1600 kHz
POWER OUTPUT CAPABILITY	11,000 w
CUTBACK CAPABILITY	Built-in reduction to 5 kw
FREQUENCY STABILITY	±5 Hz
HARMONIC AND SPURIOUS RADIATION	Exceeds FCC regulations regarding harmonic and spurious radiation.
OUTPUT IMPEDANCE	50 Ω unbalanced
MODULATION CHARACTERISTICS	High level plate modulation
AUDIO INPUT IMPEDANCE	150/600 Ω balanced
AUDIO INPUT LEVEL	10±2 dBm
AUDIO FREQUENCY RESPONSE	Typically ±1.5 dB 50-10,000 Hz
AUDIO HARMONIC DISTORTION	2.5% or less 50-10,000 Hz 95% modulation
NOISE60 dB or better, below 100% modulation
CARRIER AMPLITUDE REGULATION3% maximum at 100% modulation
POWER SOURCE	208/240V, ±5%, 50/60 Hz three phase

POWER CONSUMPTION0% mod, 19 kw; average mod, 21 kw; 100% mod, 27 kw
AMBIENT TEMPERATURE RANGE	-20 +45 degrees celsius
ALTITUDE	Up to 7500 feet above sea level
DIMENSIONS79" (200cm) high 56" (142cm) wide 30" (76cm) depth
TUBES USED	4 type 4C x 5000 A
WEIGHT2100 pounds
CRATED WEIGHT2200 pounds

ORDERING INFORMATION

MODEL	DESCRIPTION	PRODUCT CODE
BA-10K	10,000/5000 or 2500 watt AM transmitter complete with tubes, 208/230/240 Vac, 50/60 Hz, 3 phase	10-01-036
BA-10K	10,000/1000 watt AM transmitter complete as above with cutback to 1,000 watts	Special Order
STA-10K	Spare tube kit for BA-10K 4CX-5000A	10-01-0XX
	Individual spare tube for BA-10K 4CX-5000A	111123
	Spare rectifier diode stack (RS 3.5-24-15S) 6 used	210017

250-1,500 watt
FM
TRANSMITTER

BF-1K



MCMARTIN

the MCMARTIN **BF-1K** TRANSMITTER

Topnotch performance at output levels in the .25 to 1.5 kW range is assured by the McMartin Model BF-1K FM Broadcast transmitter. The BF-1K is FCC Type Accepted at these power ranges.

Designed for operation on any specified frequency from 88 to 108 MegaHertz, the BF-1K, with its grounded grid Class C PA stage, assures excellent bandwidth characteristics essential to the stringent demands of stereophonic and SCA multiplex transmission today—and to the "sound of tomorrow"—quadraphonic broadcasting.

The power amplifier stage uses a ceramic/metal, zero-bias, hi- μ triode—the 3CX1500/A7. As a grounded grid Class C amplifier, this tube requires no neutralization, nor grid bias and screen grid power supplies. The elimination of these many components, required for power tetrode PA stages, contributes both to long-term reliability and stability and a remarkably simple and straightforward power output RF stage design.

The PA tube is driven by a solid-state intermediate power amplifier stage following the field-proven, high-performance McMartin Model B-910 solid state exciter, of modular plug-in design. Stereo or SCA multiplex capability is easily attained by use of the optional modular B-110 stereo and B-113 SCA generator assemblies.

Using modern-day phase-lock-loop techniques, the B-910 solid state exciter employs a direct FM modulation system with ultra-stable, precise center frequency control. Outstanding performance for monaural, stereophonic or SCA broadcasting is assured. For example, frequency response characteristics within 0.5 dB, and total harmonic distortion of 0.3% or less, over the 30 to 15,000 Hz audio spectrum are typical of the full-fidelity operation you can anticipate from the BF-1K transmitter. When the stereo or SCA multiplex generator options are used, stereo separation and crosstalk characteristics are outstanding for the industry. All filters, frequently optional "add-ons" in competitive models, are integral portions of the generator assemblies.

The BF-1K is easy to operate. Simple pushbutton start-stop switching, eye-level metering and con-

venient operating controls emphasize the "designed-for-humans" approach. Maintenance and servicing is simple—all components are readily accessible. Where remote control operation is employed, the BF-1K is ready. Terminations are provided for interface with all standard remote control systems. In addition to start-stop functions and motor driven power output control, telemetry sampling voltages of the major operating parameters, including VSWR indication, are standard.

The BF-1K has an automatic recycling system, backed up by a memory-type LED status indicator panel. Exciter output, IPA and PA overloads and VSWR values are monitored continuously. If a fault occurs, it is displayed on the LED status indicator associated with that portion of the transmitter circuit where it occurred. Three "start" pulses spaced about one second apart are automatically initiated. If the fault is corrected during the three-pulse sequence the BF-1K is returned to its normal operation; however, the status indicator remains energized until manually reset. If the fault persists, the BF-1K reverts to its "standby" condition. The status indicator localizes the fault and remains on until reset manually. The automatic recycling/status indicator combination immediately alerts engineering personnel to intermittent faults which are normally extremely difficult to isolate.

The BF-1K is completely self-contained in an attractively-styled cabinet.

Positive pressure cabinet cooling, coupled with conservative operating levels for all components results in outstandingly cool operation, contributing to excellent, long-term reliability.

Large, eye-level meters display PA plate voltage and current, VSWR, filament and line voltage, plus a ten-position multimeter readout of auxiliary operating voltages and currents.

The BF-1K is delivered to you, pretuned and tested, on your frequency, complete with engineering test data. Installation is strictly a matter of connecting primary power, audio input and monitor cables and the antenna transmission line.

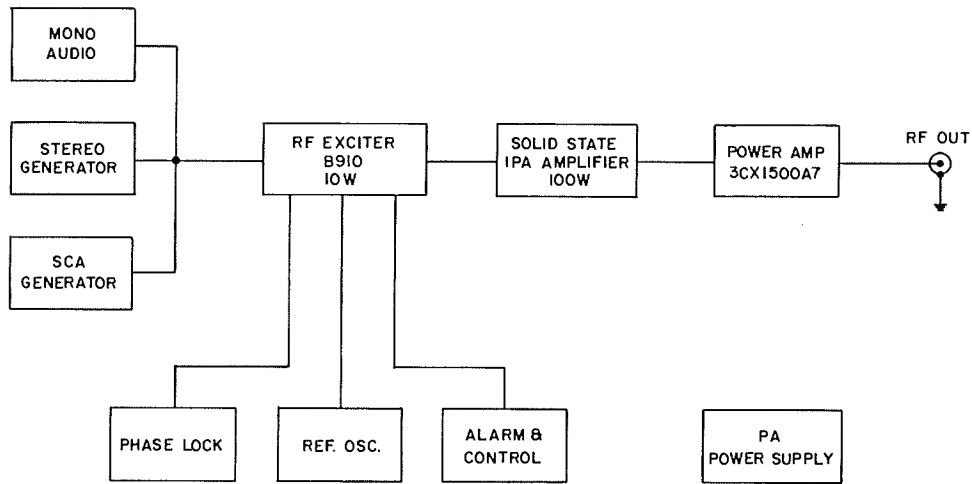

Block diagram

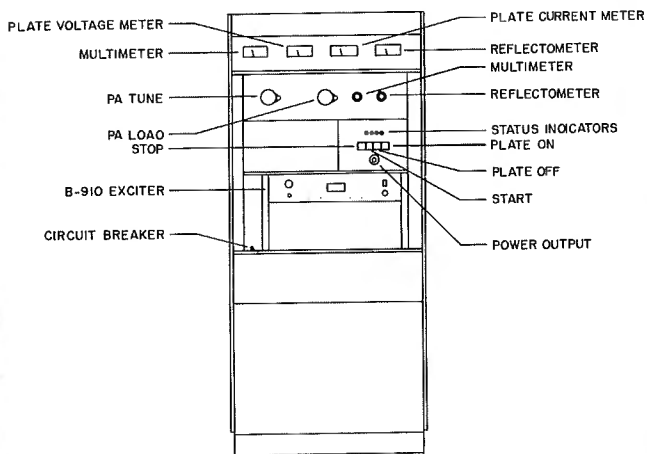

BF-1K

Front panel description

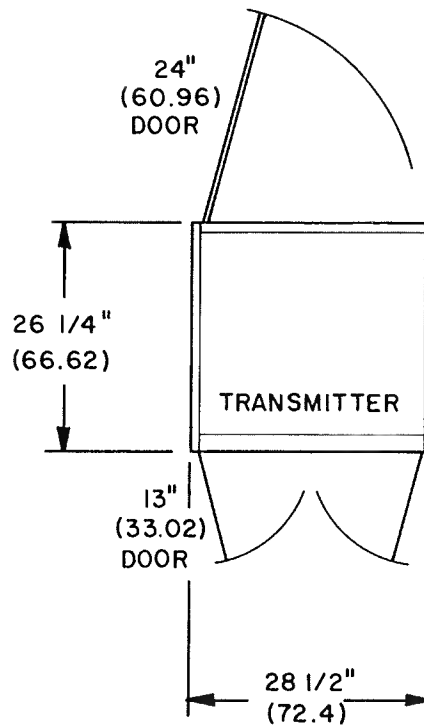

DIMENSIONS IN ()
GIVEN IN CENTIMETERS

Floor plan dimensions

SPECIFICATIONS

OPERATING RANGE88 to 108 MegaHertz
RF POWER OUTPUT	1,500 watts maximum
RF OUTPUT IMPEDANCE	50 ohms
CENTER FREQUENCY STABILITY	±500 Hz
MODULATION CAPABILITY	±150 kHz
AUDIO INPUT IMPEDANCE	600 ohms, balanced
AUDIO INPUT LEVEL	+10, ±2, dBm
AUDIO FREQUENCY RESPONSE	±0.75 dB, 30-15,000 Hz (Std. FCC 75 usec preemphasis)
TOTAL HARMONIC DISTORTION	0.3% or less, 30-15,000 Hz, 100% mod.
IM DISTORTION	0.2% or less 60 Hz/7 KHz, 4:1 ratio
FM NOISE65 dB below 100% modulation (400 Hz)
AM NOISE55 dB below carrier level
POWER REQUIRED	208/230/240 Vac, 50/60 Hz, single phase, 3-wire.
POWER CONSUMPTION	1,500W output, 2,600W 1,000W output, 1,700W 250W output, 850W
OPERATING TEMPERATURE	0° to 50° Celsius
ALTITUDE	7,500 feet above mean sea level
DIMENSIONS28¼" (71.8 cm) width 70½" (179 cm) height 25¾" (65.4 cm) depth 30" (76.2 cm) rear door swing
WEIGHT	700 pounds
FINISH	McMartin beige w/wood-grain trim

FEB/77

STEREO OPERATION (with B-110 Stereo Assembly)

AUDIO INPUT IMPEDANCE	600 ohms balanced, each channel
AUDIO INPUT LEVEL	+10, ±2, dBm
AUDIO FREQUENCY RESPONSE	±0.75 dB, 30-15,000 Hz, Std FCC 75 usec, preemphasis, each channel
TOTAL HARMONIC DISTORTION	0.5% or less, 30-15,000 Hz
IM DISTORTION	0.2% or less 60 Hz/7 KHz, 4:1 ratio
STEREO SEPARATION35 dB or greater, 50-15,000 Hz typically 50 dB or greater at mid-range
FM NOISE60 dB or greater below 100% modulation
PILOT STABILITY	±1.0 Hertz over rated temperature range
SUBCARRIER SUPPRESSION55 dB or greater
CROSSTALK (L+R to L-R, L-R to L+R)42 dB or greater below 90% modulation

SCA OPERATION (with B-113 SCA Generator Module)

AUDIO INPUT IMPEDANCE	600 ohms, balanced
AUDIO INPUT LEVEL	+10, ±2, dBm
CARRIER FREQUENCY41 or 67 KHz standard (others available on request)
CARRIER STABILITY	±500 Hz
MODULATION CAPABILITY	±7.5 kHz
PREEMPHASIS150 usec standard, 50 or 75 usec available on request
FREQUENCY RESPONSE	±1.5 dB, 50-5000 Hz
CROSSTALK (main to sub, sub to main)60 dB or lower
DISTORTION (50-5000 Hz)	0.75% or less with LP output filter 2.5% or less with BP output filter
S/N NOISE60 dB or greater

2000-3500 WATT FM TRANSMITTER

BF-3.5K

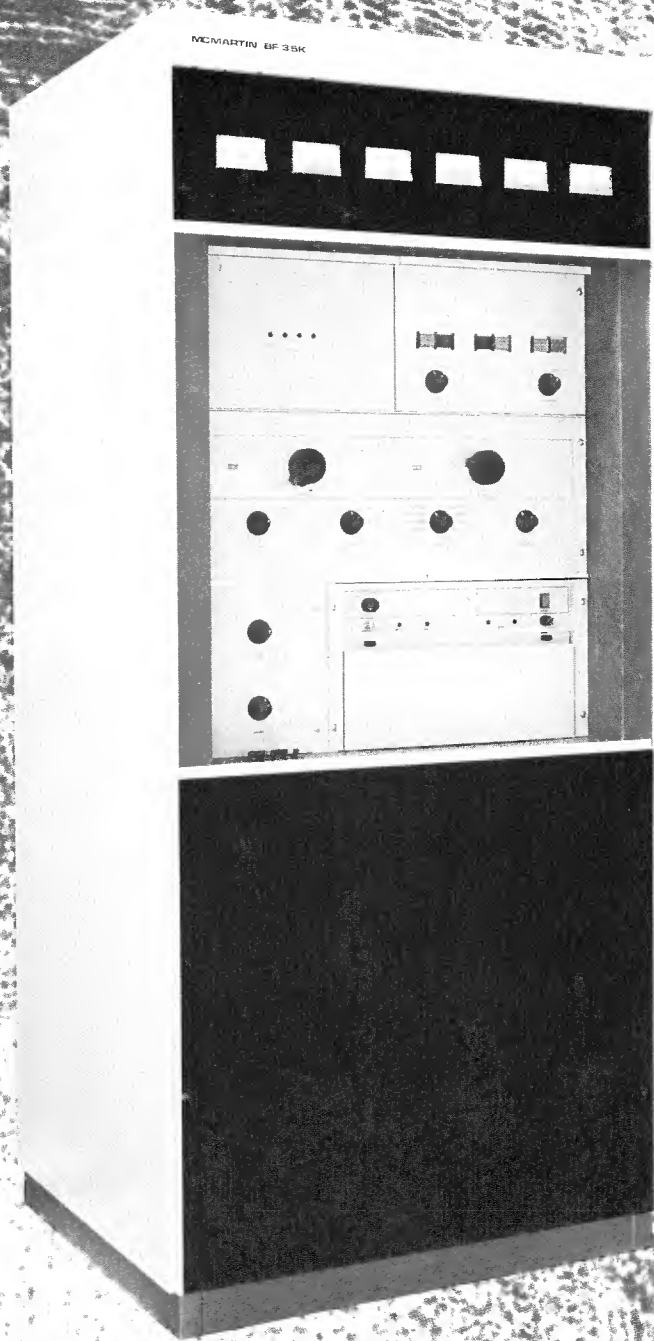

MCMARTIN

McMARTIN BF-3.5K TRANSMITTER

EXCELLENT PA EFFICIENCY—70-80%

VERY STABLE OPERATION—GROUNDED GRID

**CONSERVATIVELY RATED—
USES 40% OF PA DISSIPATION**

**EASILY REMOTE CONTROLLED.
NO INTERFACE ADAPTERS NEEDED**

AUTOMATIC RECYCLING

STATUS LIGHTS BUILT-IN

VSWR SENSING BUILT-IN

NO NEUTRALIZATION REQUIRED

The McMartin BF-3.5K FM Broadcast Transmitter is an extremely stable, high performance unit meticulously designed for many years of reliable service.

stable and reliable operation available to today's FM broadcaster.

The BF-3.5K design is simple and straightforward. It uses only two tube types. To provide the stability and bandwidth characteristics, essential to modern broadcast fidelity requirements, the BF-3.5K power amplifier stage employs a type 3CX3000A7 high mu, zero-bias power triode operating in grounded-grid Class C mode. The need for control grid bias, and screen voltage power supplies is eliminated. No neutralization is required.

The BF-3.5K includes as standard equipment, many features available in competitive models only as add-ons. Automatic recycling, with a memory-type LED fault indicator, forward-reverse reflectometer, plus full remote-control capability are built into the BF-3.5K.

Excellent plate efficiencies, in excess of 70% across the entire 88 to 108 MHz range and at power output levels from 2,000 to 3,500 watts, result in an extremely conservative transmitter. The BF-3.5K is FCC Type Accepted at these power ranges.

A quiet, centrifugal blower maintains positive air pressure through the compartmentized IPA and PA stages, and is supplemented by a cabinet exhaust fan. This air system greatly reduces thermal aging of components.

The intermediate power amplifier stage uses a pair of rugged radial beam power tetrodes, 4CX250B's, operated in parallel. The BF-3.5K power output is adjusted by motor-driven control of screen voltage applied to the IPA stage.

The BF-3.5K satisfies the management, program and technical personnel of today's FM broadcast station. Reasonable initial and operating cost, a high quality sound, trouble-free operating and ease of maintenance are but a few of the design objectives met by the newest—and best—FM broadcast transmitter you can buy!

The solid state McMartin B-910 FM exciter portion of the BF-3.5K, with its plug in modular design and stereo/SCA generator options, insures the finest, most

The electronic integrity is supplemented by rugged mechanical design in a style which is strikingly attractive.

The powerfully proud BF-3.5K is a pleasure to own... a pleasure to maintain... a pleasure to listen to... another new breed of McMartin broadcast products.

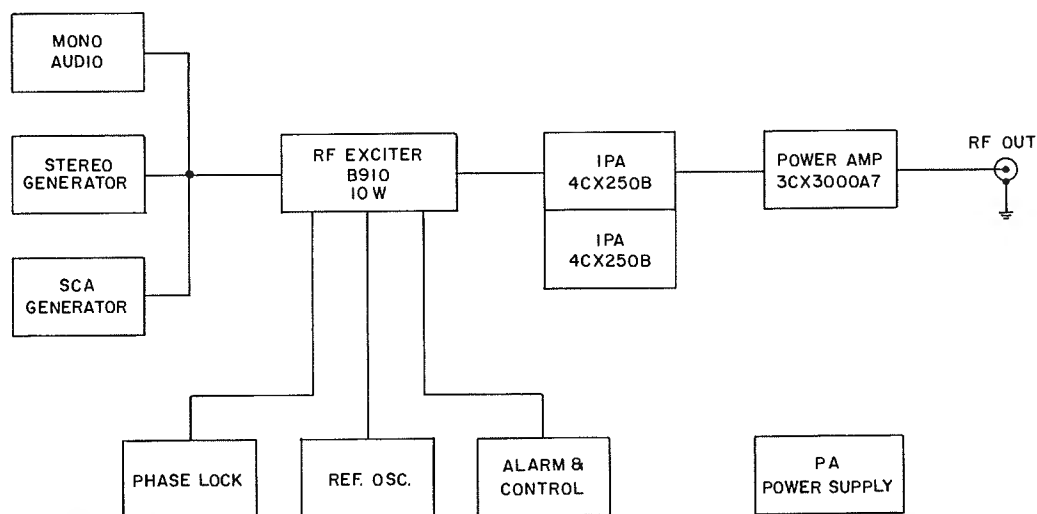

Block diagram

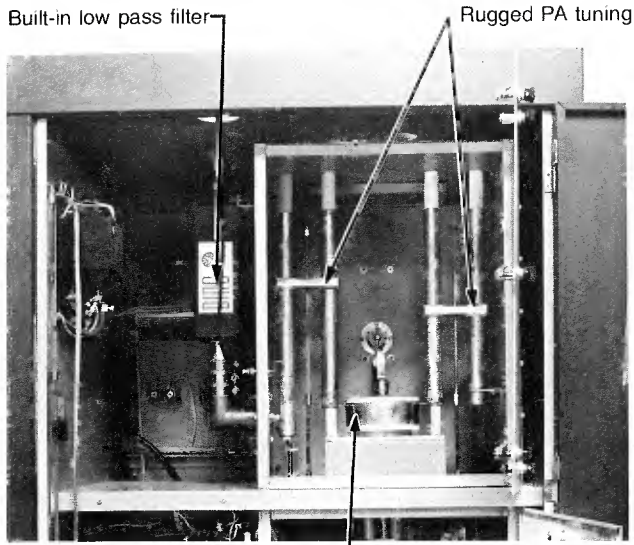

Built-in low pass filter

Rugged PA tuning

Conservative final amplifier tube 3CX3000A7

Rear view, top section of BF-3.5K

All control relays easily accessible

Rectifier diodes individually replaceable. Rated 4 times working voltage

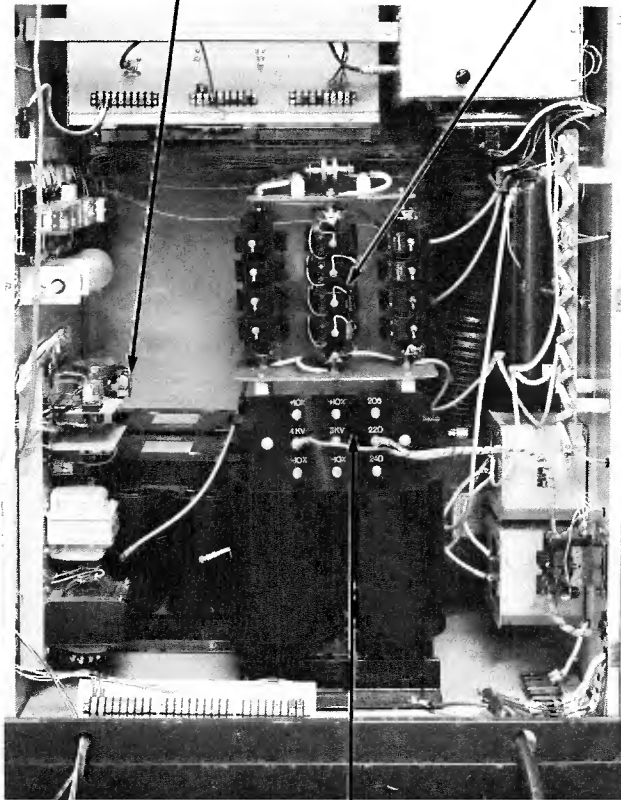

Multi-tap power transformer for any AC input configuration three phase or single phase

Rear view, base section of BF-3.5K

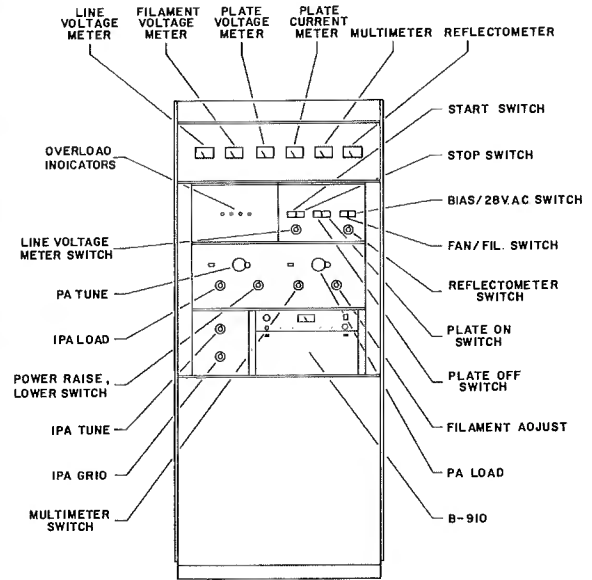

Front panel description

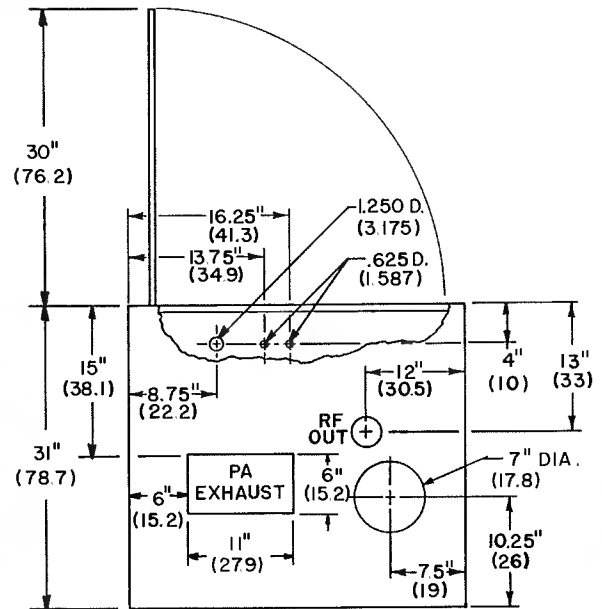

Floor plan

SPECIFICATIONS

OPERATING RANGE88 to 108 MegaHertz
RF POWER OUTPUT	3,500 watts maximum
RF OUTPUT IMPEDANCE50 ohms (Termination Andrew #4861A ungasged field coupling)
CENTER FREQUENCY STABILITY	± 500 Hz
MODULATION CAPABILITY	± 150 kHz
AUDIO INPUT IMPEDANCE600 ohms, balanced
AUDIO INPUT LEVEL	+10, ±2, dBm
AUDIO FREQUENCY RESPONSE	± 0.75 dB, 30-15000 Hz (Std. FCC 75 usec preemphasis)
TOTAL HARMONIC DISTORTION0.3% or less, 30-15,000 Hz, 100% mod.
IM DISTORTION0.2% or less 60 Hz/7KHz, 4:1 ratio
FM NOISE65 dB below 100% modulation (400 Hz)
AM NOISE55 dB below carrier level
POWER REQUIRED208/230/240 Vac, 50/60 Hz, single phase — or — 208/230/240 Vac, 3-phase
POWER CONSUMPTION (Approx.)2000 watt output, 4400 watts 2500 watt output, 5200 watts 3000 watt output, 5900 watts 3500 watt output, 6500 watts
OPERATING TEMPERATURE0° to 50° Celsius
ALTITUDE7,500 feet above mean sea level
DIMENSIONS34½" (87.6 cm) width 85" (219.9 cm) height 31" (78.7 cm) depth 30" (76.2 cm) rear door swing
WEIGHT920 pounds
CRATED WEIGHT1020 pounds
FINISHMcMartin beige w/wood-grain trim

STEREO OPERATION (with B-110 Stereo Assembly)

AUDIO INPUT IMPEDANCE600 ohms balanced, each channel
AUDIO INPUT LEVEL	+10, ±2, dBm
AUDIO FREQUENCY RESPONSE	± 0.75 dB, 30-15000 Hz, Std FCC 75 usec, deemphasis, each channel

TOTAL HARMONIC DISTORTION0.5% or less, 30-15000 Hz
STEREO SEPARATION39 dB or greater, 50-15000 Hz
FM NOISE60 dB or greater below 100% modulation
PILOT STABILITY	± 1.0 Hertz over rated temperature range
SUBCARRIER SUPPRESSION55 dB or greater
CROSSTALK (L+R to L-R, L-R to L+R)42 dB or greater below 90% modulation

SCA OPERATION (with B-113 SCA Generator Module)

AUDIO INPUT IMPEDANCE600 ohms, balanced
AUDIO INPUT LEVEL	+10, ±2, dBm
CARRIER FREQUENCY41 or 67 kHz standard (others available on request)
CARRIER STABILITY	± 500 Hz
MODULATION CAPABILITY	± 7.5 kHz
PREEMPHASIS150 usec standard, 50 or 75 usec available on request
FREQUENCY RESPONSE	± 1.5 dB, 50-5000 Hz
CROSSTALK (main to sub, sub to main)60 dB or lower
DISTORTION (50-5000 Hz)0.75% or less with LP output filter 2.5% or less with BP output filter
S/N NOISE60 dB or greater

ORDERING INFORMATION

BF-3.5K	1.5-3.5KW FM transmitter, complete with exciter and tubes, 208/230/240 Vac, 50/60 Hz, single phase or optional (208/230/240 Vac 3 phase)10-01-026
STF-3.5K	Spare tube kit for BF-3.5K (2) 4CX250B, (1) 3CX3000A710-01-027 Spare Rectifier Diode Stack RS 3.5-24-12S210016 (Requires 4)

5,500 watt
FM
TRANSMITTER **BF-5K**

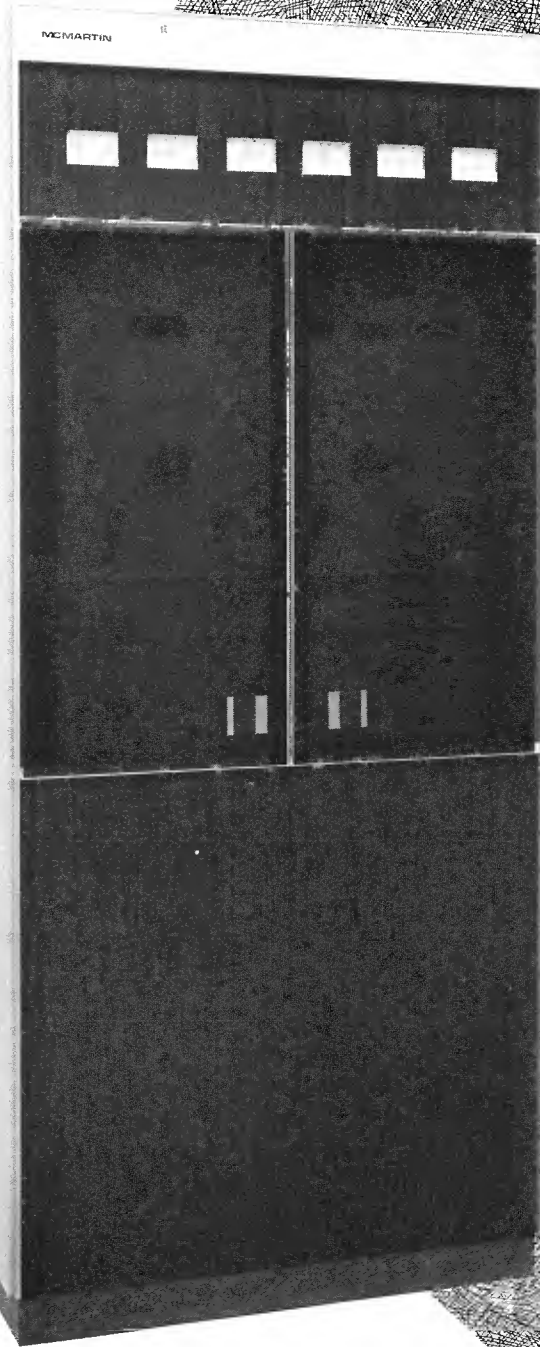

MCMARTIN

the McMARTIN **BF-5K** TRANSMITTER

The McMartin BF-5K transmitter is designed for FM broadcast service, operating on a specific frequency in the range of 88 to 108 MHz, and power output levels from 3.5 to 5.5 KW. The BF-5K is FCC Type Accepted at these power ranges.

The BF-5K utilizes the well-accepted, field-proven, high-performance McMartin B-910 solid state exciter. The RF output of the exciter drives an intermediate power amplifier stage consisting of parallel Type 4CX250B radial beam tetrodes. These supply RF excitation to a ceramic/metal, zero-bias, hi-mu triode tube, Type 3CX3000/A7 operating as a grounded-grid Class C amplifier. This configuration is well-recognized as optimum for the wide-band characteristics essential to superior stereo and SCA multiplex operation today—and for quadrasonic sound, tomorrow.

In addition, the elimination of grid-bias and screen-voltage power supplies and the need for neutralization, essential to transmitter designs using power tetrode output tubes, contributes to long-term, stable operation.

The B-910 solid state exciter, of modular, plug-in design, facilitates optional stereo or SCA multiplex transmission. The B-910 incorporates a unique phase-locked direct FM modulator for ultrastable, precise center-frequency control. Outstanding performance specifications for all transmission modes are assured. For example, frequency response within 0.5 dB and total harmonic distortion of 0.3% or less over the 30 to 15,000 Hertz audio spectrum are typical of the full-fidelity capability of the BF-5K transmitter.

With the B-110 stereo or B-113 SCA plug-in options, stereo separation and crosstalk characteristics are outstanding. All filters necessary for optimum stereo and SCA transmission are integral portions of the generator assemblies, with no hidden "extra costs" when these modes are used.

The BF-5K is controlled by simple pushbutton start-stop switch operation, with terminations provided for interface with standard remote control systems, including telemetry sampling voltages.

Automatic recycling and memory-type LED status indication is standard. The status system senses and displays the source of any carrier interruption. The exciter output; IPA and PA stage overloads; and transmission line VSWR are monitored continuously. Any fault is detected and displayed on the LED indicator panel and can be "cleared" only by manual reset. The recycling circuitry upon a fault occurrence, automatically initiates three "start" pulses, spaced about one second apart. If the fault persists, the BF-5K will revert to its "standby" condition, and the LED status indicator associated with that portion of the transmitter within which the fault occurred will be illuminated.

For output operating levels up to 4KW, the BF-5K is completely self-contained. For 4.0 to 5.5 KW output, an external RF harmonic filter is supplied. This mounts horizontally above the BF-5K cabinet.

Positive-pressure air cooling, in conjunction with conservative operating levels for all components results in unusually cool operation of the BF-5K. This contributes to excellent long-term component reliability.

All major parameters are displayed on large front panel meters, including PA plate voltage and current; VSWR; filament and line voltages and a ten-position multimeter readout. Three-phase primary power is standard. Single phase operation when requested will be supplied at no additional cost.

Where redundant or combined transmitter systems are desired, dual BF-5K units may be used. McMartin will gladly furnish quotations for specialized systems of this type, engineering-tailored to your specifications.

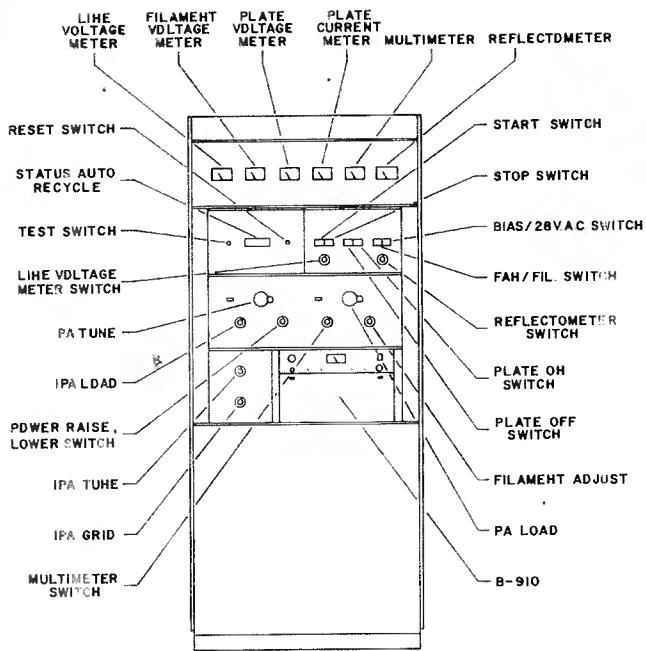
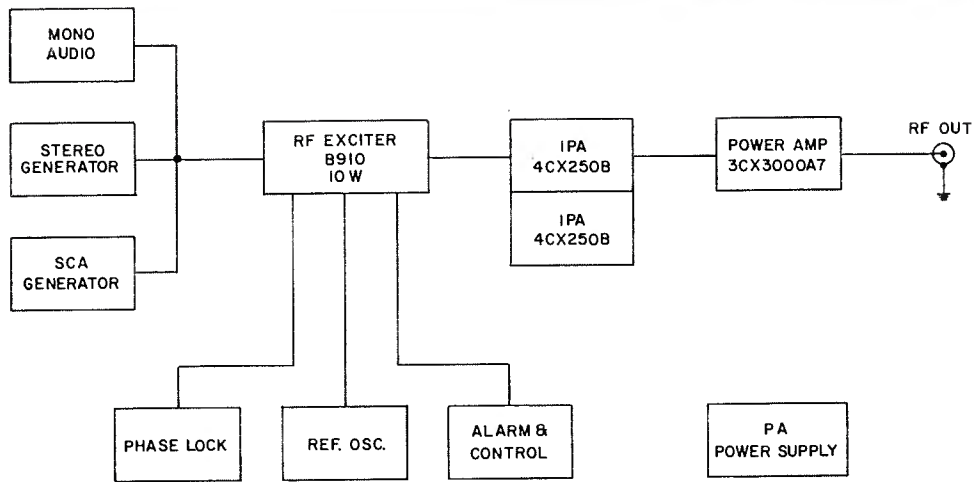

Front panel description

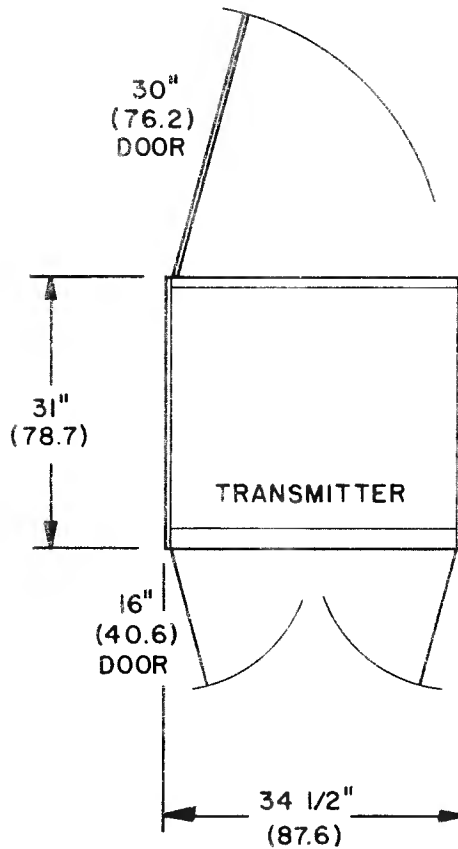

DIMENSIONS IN ()
GIVEN IN CENTIMETERS

Floor plan dimensions

SPECIFICATIONS

OPERATING RANGE88 to 108 MegaHertz
RF POWER OUTPUT5 500 watts maximum
RF OUTPUT IMPEDANCE50 ohms
CENTER FREQUENCY STABILITY	±500 Hz
MODULATION CAPABILITY	±150 kHz
AUDIO INPUT IMPEDANCE600 ohms, balanced
AUDIO INPUT LEVEL	+10, ±2, dBm
AUDIO FREQUENCY RESPONSE	±0.75 dB, 30-15,000 Hz (Std. FCC 75 usec preemphasis)
TOTAL HARMONIC DISTORTION0.3% or less, 30-15,000 Hz, 100% mod.
IM DISTORTION0.2% or less 60 Hz/7 KHz, 4:1 ratio
FM NOISE65 dB below 100% modulation (400 Hz)
AM NOISE55 dB below carrier level
POWER REQUIRED208/230/240 Vac, 3-phase or single phase
POWER CONSUMPTION (Approx.)3500 watt output, 7200 watts 4500 watt output, 10,000 watts 5000 watt output, 11,250 watts 5500 watt output, 12,500 watts
OPERATING TEMPERATURE0° to 50° Celsius
ALTITUDE7,500 feet above mean sea level
DIMENSIONS34½" (87.6 cm) width 78.5" (199 cm) height 31" (78.7 cm) depth 30" (76.2 cm) rear door swing
WEIGHT1,200 pounds
FINISHMcMartin beige w/wood-grain trim

FEB/77

STEREO OPERATION (with B-110 Stereo Assembly)

AUDIO INPUT IMPEDANCE600 ohms balanced, each channel
AUDIO INPUT LEVEL	+10, ±2, dBm
AUDIO FREQUENCY RESPONSE	±0.75 dB, 30-15,000 Hz, Std FCC 75 usec, preemphasis, each channel
TOTAL HARMONIC DISTORTION0.5% or less, 30-15,000 Hz
IM DISTORTION0.2% or less 60 Hz/7 KHz, 4:1 ratio
STEREO SEPARATION35 dB or greater, 50-15,000 Hz typically 50 dB or greater at mid-range
FM NOISE60 dB or greater below 100% modulation
PILOT STABILITY	±1.0 Hertz over rated temperature range
SUBCARRIER SUPPRESSION55 dB or greater
CROSSTALK (L+R to L-P L R to L+R)42 dB or greater below 90% modulation

SCA OPERATION (with TE-117 SCA Generator) Module

AUDIO INPUT IMPEDANCE600 ohms, balanced
AUDIO INPUT LEVEL	+10, ±2, dBm
CARRIER FREQUENCY41 or 67 KHz standard (others available on request)
CARRIER STABILITY	±500 Hz
MODULATION CAPABILITY	±7.5 kHz
PREEMPHASIS150 usec standard, 50 or 75 usec available on request
FREQUENCY RESPONSE	±1.5 dB, 50-5000 Hz
CROSSTALK (main to sub, sub to main)60 dB or lower
DISTORTION (50-5000 Hz)0.75% or less with LP output filter 2.5% or less with BP output filter
S/N NOISE60 dB or greater

5,500-15,000 watt
FM
TRANSMITTER **BF-10K**



MCMARTIN

the McMARTIN **BF-10K** TRANSMITTER

For optimum performance and long-term reliability in FM broadcast installations requiring transmitter power output in the range of 5.5 to 15.0 kW, the McMartin Model BF-10K FM Broadcast Transmitter is the finest choice. The BF-10K is FCC Type Accepted at these power ranges.

The BF-10K meets today's stringent requirements for monaural, stereophonic and SCA multiplex operation—and is ready for the mode of tomorrow—quadraphonic sound.

The excellent wideband characteristics of the BF-10K have been designed into the unit by the use of grounded-grid circuitry in its high-power RF driver and power amplifier stages. Both stages use ceramic/metal, zero-bias, high- μ triodes; a Type 3CX1500/A7 for the driver and a Type 3CX10,000/A7 in the PA stage. Widely-recognized for their broad-band characteristics in the grounded grid configuration, the use of these tube types also eliminates the need for neutralization and the many components required for grid bias and screen voltage power supplies. This results in an outstandingly simple and straightforward design approach in the critical high-power RF stages.

One additional tube, a Type 4CX250B serves as an intermediate power amplifier between the solid-state B-910 exciter and the driver stage. Motor-driven screen voltage adjustment of the 4CX250B screen grid voltage insures extremely smooth control of the BF-10K power output level.

The field-proven, high-performance, solid-state B-910 exciter, of modular, plug-in design, facilitates optional stereo or SCA multiplex operation. The B-910 incorporates a unique phase-locked direct FM modulator for ultra-stable, precise frequency control. Outstanding performance specifications for all transmission modes are assured. For example, frequency response within 0.5 dB over the 30-15,000 Hertz audio spectrum and total harmonic distortion of 0.3% or less are typical of the full-fidelity capabilities of the BF-10K. With the B-110 stereo or the B-113 SCA generator plug-in options, stereo separation and crosstalk characteristics are outstanding. All filters necessary for optimum

stereo and SCA optional modes are supplied as standard, with no hidden "extra costs."

The BF-10K is controlled by simple push-button start-stop switching, with terminations for remote control operation, including telemetry sampling voltages, for interface with all standard remote control systems.

Automatic recycling and memory-type LED status indication is standard. The latter system senses and displays the source of any carrier interruption. The exciter RF output; IPA, driver and PA stage overloads; and transmission line VSWR are continuously monitored. Any fault is detected and displayed on the LED indicator panel and can be "cleared" only by manual reset. The recycling circuitry automatically revert to a standby condition, and the LED status indicator for that portion of the transmitter in which the fault occurred will be illuminated.

The BF-10K is completely self-contained in an attractively-styled dual-section cabinet, with the exception of the RF harmonic filter which is externally mounted above the BF-10K cabinet.

Positive pressure air cooling, in conjunction with conservative operation of the high-power RF stages results in unusually cool operation of the BF-10K. This contributes to excellent long-term component reliability.

All major parameters are monitored on large-size front panel meters. Driver and PA plate voltages and currents are metered separately. In addition VSWR, input line voltages, driver/PA filament voltages and a ten-position multimeter readout occupy the upper front meter panel.

The electrical and mechanical design of the BF-10K provides for easy field installation of optional power output feed at an approximately 1000 watt level directly from the 3CX1500/A7 driver stage.

Dual BF-10K units may be combined for redundant 10 to 13.5 KW, or combined 20 to 27 KW output operation. McMartin will gladly furnish quotations for special systems of this type, engineered and tailored to your specifications.

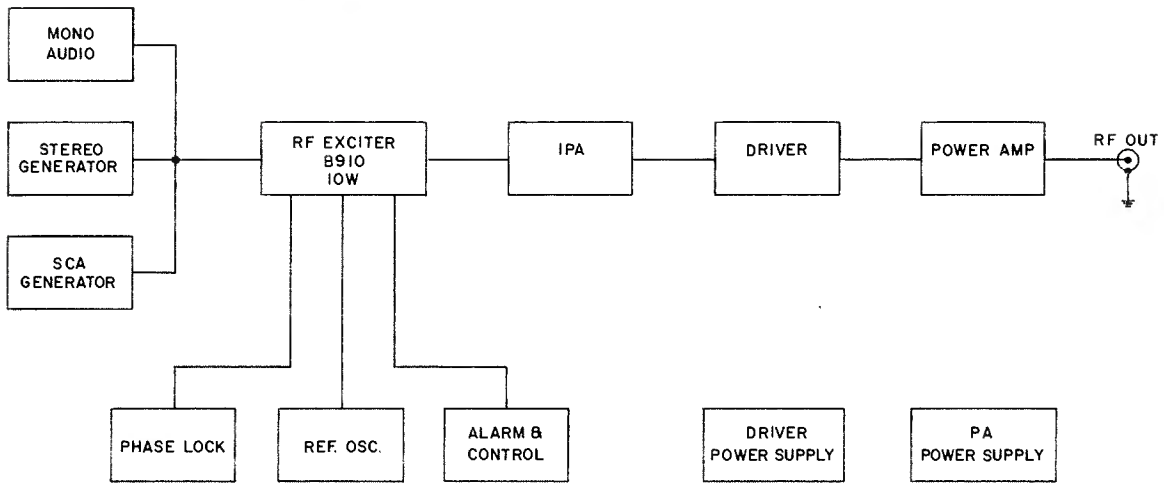

Block diagram

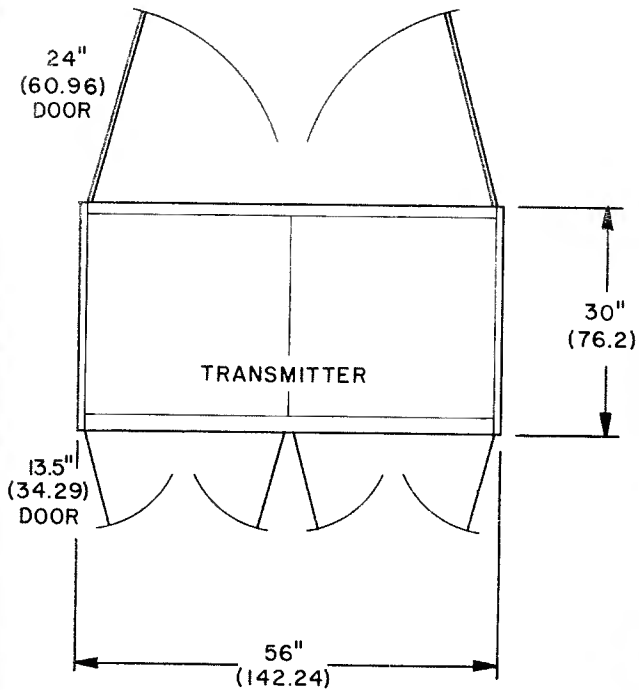

DIMENSIONS IN ()
GIVEN IN CENTIMETERS

Front panel description

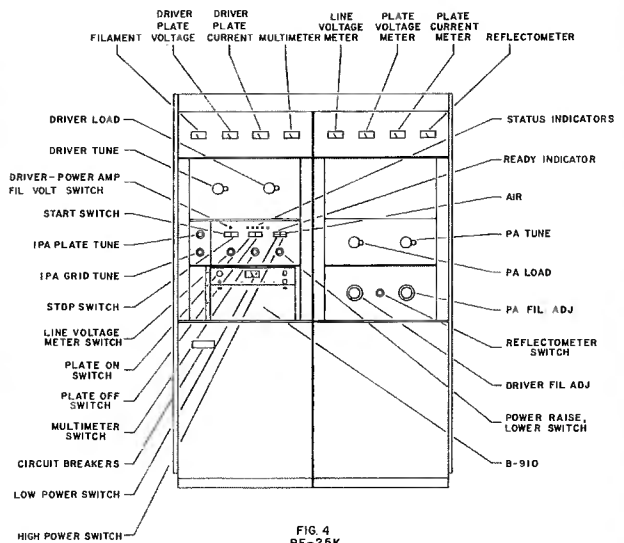

FIG 4
BF-25K

Floor plan dimensions

SPECIFICATIONS

OPERATING RANGE88 to 108 MegaHertz
RF POWER OUTPUT	15.0 kW maximum
RF OUTPUT IMPEDANCE50 ohms
CENTER FREQUENCY STABILITY	±500 Hz
MODULATION CAPABILITY	±150 kHz
AUDIO INPUT IMPEDANCE600 ohms, balanced
AUDIO INPUT LEVEL	+10, ±2, dBm
AUDIO FREQUENCY RESPONSE	±0.75 dB, 30-15,000 Hz (Std. FCC 75 usec preemphasis)
TOTAL HARMONIC DISTORTION0.3% or less, 30-15,000 Hz, 100% mod.
IM DISTORTION0.2% or less 60 Hz/7 KHz, 4:1 ratio
FM NOISE65 dB below 100% modulation (400 Hz)
AM NOISE55 dB below carrier level
POWER REQUIRED208/230/240 Vac, 3-phase
POWER CONSUMPTION (Approx.)	5.5kW output, 12 KVA 7.5 kW output, 15 KVA 10.0 kW output, 18 KVA 15.0 kW output, 27 KVA
OPERATING TEMPERATURE0° to 50° Celsius
ALTITUDE7,500 feet above mean sea level
DIMENSIONS56" (142.2 cm) width 79" (200.7 cm) height 30" (76.2 cm) depth 24" (60.7 cm) rear door swing
WEIGHT1,750 pounds
FINISHMcMartin beige w/wood-grain trim

FEB/77

STEREO OPERATION (with B-110 Stereo Assembly):

AUDIO INPUT IMPEDANCE600 ohms balanced, each channel
AUDIO INPUT LEVEL	+10, ±2, dBm
AUDIO FREQUENCY RESPONSE	±0.75 dB, 30-15,000 Hz, Std FCC 75 usec, preemphasis, each channel
TOTAL HARMONIC DISTORTION0.5% or less, 30-15,000 Hz
IM DISTORTION0.2% or less 60 Hz/7 KHz, 4:1 ratio
STEREO SEPARATION35 dB or greater, 50-15,000 Hz typically 50 dB or greater at mid-range
FM NOISE60 dB or greater below 100% modulation
PILOT STABILITY	±1.0 Hertz over rated temperature range
SUBCARRIER SUPPRESSION55 dB or greater
CROSSTALK (L+R to L-R, L-R to L+R)42 dB or greater below 90% modulation

SCA OPERATION (with B-111 SCA Generator Module):

AUDIO INPUT IMPEDANCE600 ohms, balanced
AUDIO INPUT LEVEL	+10, ±2, dBm
CARRIER FREQUENCY41 or 67 KHz standard (others available on request)
CARRIER STABILITY	±500 Hz
MODULATION CAPABILITY	±7.5 kHz
PREEMPHASIS150 usec standard, 50 or 75 usec available on request
FREQUENCY RESPONSE	±1.5 dB, 50-5000 Hz
CROSSTALK (main to sub, sub to main)60 dB or lower
DISTORTION (50-5000 Hz)0.75% or less with LP output filter 2.5% or less with BP output filter
S/N NOISE60 dB or greater

10,000-27,500 watt
FM
TRANSMITTER **BF-25K**



MCMARTIN

the McMARTIN BF-25K TRANSMITTER

The McMARTIN BF-25K FM broadcast transmitter satisfies FM broadcast station installations requiring transmitter output levels from 10 to 27.5 kW. The BF-25K is FCC Type Accepted at these power ranges.

The BF-25K meets today's stringent requirements for stereo and SCA multiplex operation—and is ready for the mode of tomorrow, quadrasonic sound.

Selected for its widely recognized superior wide band characteristics, McMARTIN has incorporated grounded-grid Class C designs in the high-level driver and PA stages of the BF-25K. Both stages employ ceramic/metal, zero/bias, high- μ triodes; a 3CX3000/A7 for the driver and a 3CX20,000/A7 in the power amplifier output stage. The latter tube, with rated 20,000 watt plate dissipation, when operated at the 27.5 KW maximum BF-25K output level utilizes less than 40% of its plate dissipation capability. This conservative operation is typical of the overall design of the BF-25K. Emphasis has been placed on circuit simplicity, long-term reliability and ease of maintenance.

By the grounded-grid design approach, grid bias and screen-grid power supplies—essential to tetrode-tube type amplifiers, are completely eliminated. The sometimes touchy and troublesome neutralization problems are gone. The BF-25K RF amplifier stages do not require neutralization. The grounded-grid approach delivers another little bonus. A portion of the "drive" power appears in the PA output circuit. This results in outstanding PA efficiency.

One additional tube, a Type 4CX250B, is used as the intermediate power amplifier between the solid-state exciter and the driver stage. Extremely smooth adjustment of the RF power output of the BF-25K is controlled by motor driven adjustment of the screen voltage applied to the 4CX250B tube.

The exciter for the BF-25K is the field-proved, high-performance solid-state Model B-910. With its modular plug-in design, stereo and/or SCA mode options are readily available. The B-910 incorporates a unique phase-lock direct FM modulator for ultra stable and precise frequency control. An alarm/control module is incorporated which automatically

shuts down the BF-25K in the unlikely event that the frequency should vary more than 100 kHz from the assigned operating frequency.

Interlocked control logic permits simple pushbutton switching of all start-stop functions. Termination for remote control operation, including telemetering sampling voltages, permit interface of the BF-25K with all standard remote control systems.

Automatic recycling and a memory-type LED status indicator display, sense and indicate the source of carrier interruptions. The exciter output, IPA, driver and PA stages, high-voltage overload and VSWR are monitored continuously. Any fault is sensed and displayed on the LED indicator panel and can be cleared only by manual reset. The recycling circuitry automatically initiates three "start" pulses, spaced approximately one second apart. If the fault persists, the recycling detection circuit illuminates the LED, indicating that portion of the transmitter system where the fault occurred.

The BF-25K is housed in an attractively styled dual-section cabinet with the power amplifier stage occupying one section and all other circuitry in the other. The two halves of the assembly are individually cooled. The electrical and mechanical design arrangement permits easy field installation of optional antenna transmission line switching to the output of the driver stage at a power level of approximately 2500 watts.

The high-voltage power transformer and associated silicon rectifier stacks for PA plate supply are housed in a separate assembly. The RF harmonic filter mounts horizontally above the main transmitter cabinet.

Driver and PA plate voltages and currents are separately metered. These parameters along with VSWR, line voltage, driver/PA filament voltages and a ten-position multimeter readout, are shown on the upper front-panel meter panel.

Dual BF-25K units are also available for redundant 27.5 or paralleled 55 KW output operation. McMARTIN would be pleased to furnish quotations on systems of this type, engineered and tailored to your specific situations.

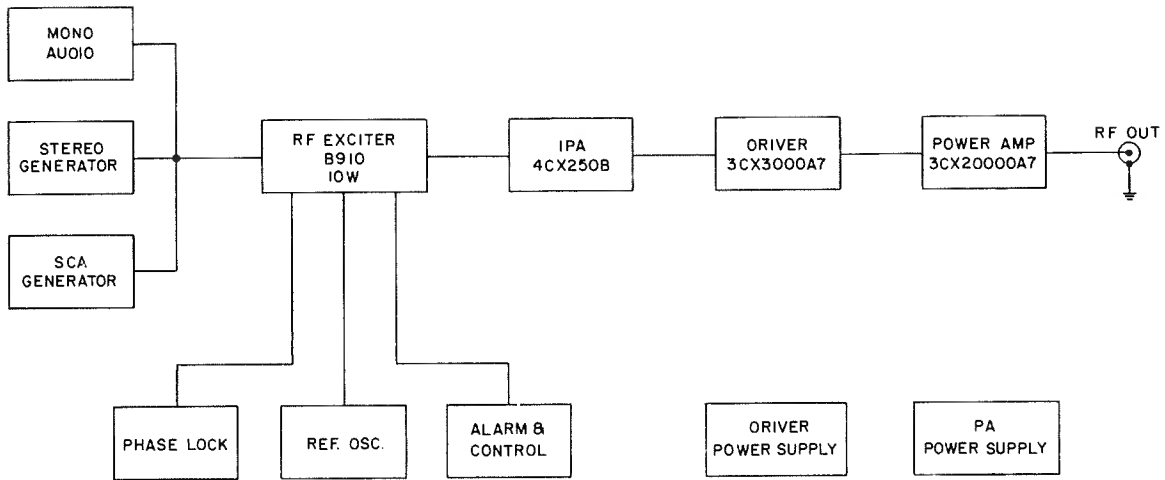

Block diagram

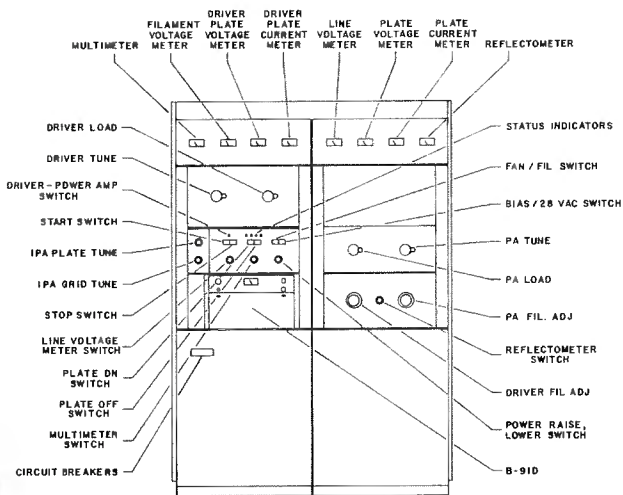
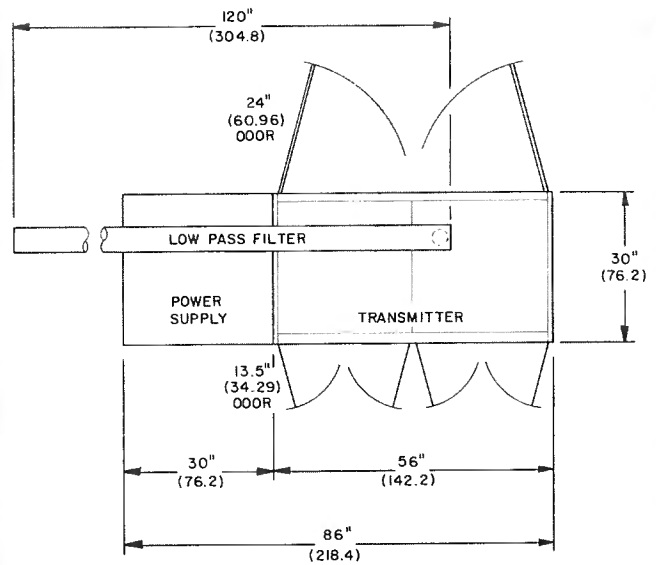

FIG. 3
8F-25K
8F-10K
8F-55K

Front panel description



DIMENSIONS IN ()
GIVEN IN CENTIMETERS

Floor plan dimensions

SPECIFICATIONS

OPERATING RANGE88 to 108 MegaHertz
RF POWER OUTPUT27,500 watts maximum
RF OUTPUT IMPEDANCE50 ohms
CENTER FREQUENCY STABILITY	±500 Hz
MODULATION CAPABILITY	±150 kHz
AUDIO INPUT IMPEDANCE600 ohms, balanced
AUDIO INPUT LEVEL	+10, ±2, dBm
AUDIO FREQUENCY RESPONSE	±0.75 dB, 30-15,000 Hz (Std. FCC 75 usec preemphasis)
TOTAL HARMONIC DISTORTION0.3% or less, 30-15,000 Hz, 100% mod.
IM DISTORTION0.2% or less 60 Hz/7 KHz, 4:1 ratio
FM NOISE65 dB below 100% modulation (400 Hz)
AM NOISE55 dB below carrier level
POWER REQUIRED208/230/240 Vac, 3-phase
POWER CONSUMPTION (Approx.)10,000 watt output, KVA 21 15,000 watt output, KVA 28.5 20,000 watt output, KVA 37 25,000 watt output, KVA 42 27,500 watt output, KVA 46
OPERATING TEMPERATURE0° to 50° Celsius
ALTITUDE7,500 feet above mean sea level
DIMENSIONS:	
Main Cabinet56" (142.2 cm) width 79" (200.7 cm) height 30" (76.2 cm) depth 24" (60.7 cm) rear door swing
Power Supply Assy.30" W x 29" H x 30" D (76.2 x 73.7 x 76.2 cm)
WEIGHT	
Main Cabinet1,500 pounds
Power Supply Assy.700 pounds
FINISHMcMartin beige w/wood-grain trim

FEB/77

STEREO OPERATION (with B-110 Stereo Assembly)

AUDIO INPUT IMPEDANCE600 ohms balanced, each channel
AUDIO INPUT LEVEL	+10, ±2, dBm
AUDIO FREQUENCY RESPONSE	±0.75 dB, 30-15,000 Hz, Std FCC 75 usec, preemphasis, each channel
TOTAL HARMONIC DISTORTION0.5% or less, 30-15,000 Hz
IM DISTORTION0.2% or less 60 Hz/7 KHz, 4:1 ratio
STEREO SEPARATION35 dB or greater, 50-15,000 Hz typically 50 dB or greater at mid-range
FM NOISE60 dB or greater below 100% modulation
PILOT STABILITY	±1.0 Hertz over rated temperature range
SUBCARRIER SUPPRESSION55 dB or greater
CROSSTALK (L+R to L-R, L-R to L+R)42 dB or greater below 90% modulation

SCA OPERATION (with B-113 SCA Generator Module)

AUDIO INPUT IMPEDANCE600 ohms, balanced
AUDIO INPUT LEVEL	+10, ±2, dBm
CARRIER FREQUENCY41 or 67 Khz standard (others available on request)
CARRIER STABILITY	±500 Hz
MODULATION CAPABILITY	±7.5 kHz
PREEMPHASIS150 usec standard, 50 or 75 usec available on request
FREQUENCY RESPONSE	±1.5 dB, 50-5000 Hz
CROSSTALK (main to sub, sub to main)60 dB or lower
DISTORTION (50-5000 Hz)0.75% or less with LP output filter 2.5% or less with BP output filter
S/N NOISE60 dB or greater

100 WATT FM TRANSMITTER

B-9100T



MCMARTIN

MC MARTIN B-9100T TRANSMITTER

FULLY METERED

100 WATTS OUTPUT

DUAL POWER AMPLIFIERS COMBINED

COMPLETELY SOLID STATE

25% POWER MAINTAINED IF ONE POWER AMP FAILS

The McMartin B-9100 is a 100 watt FM power amplifier designed to be coupled with a ten watt exciter to produce a 100 watt FM transmitter. The B-9100 is available with a McMartin B-910, 10 watt exciter, and is then designated "McMartin B-9100T, complete 100 watt transmitter."

The B-9100T provides a 100 watt FM broadcast signal in the 88 to 108 MHz frequency range, and is well-suited to low power broadcast applications and as an emergency standby transmitter for higher powered FM stations.

The B-9100 consists of a basic 100 watt FM power amplifier and internal harmonic filter, and may be used in conjunction with any FM exciter capable of 5 watts output. The unit is designed for standard 19" rack

mounting. The antenna is connected directly to the output jack.

The B-9100 features a completed, solid-state two stage amplifier in which the driver output is coaxially split and used to drive two 50 watt amplifiers, which in turn are coaxially combined by a Hybrid combiner. A resistive reject load is used to absorb excess RF power if one of the final amplifiers should fail. In this situation, one quarter power, i.e. 25 watts, will appear at the antenna terminal.

The use of redundant RF amplifiers provides unusual reliability in a low powered unit, making it an excellent choice for remotely located low power broadcast installations and for use in emergency standby applications.

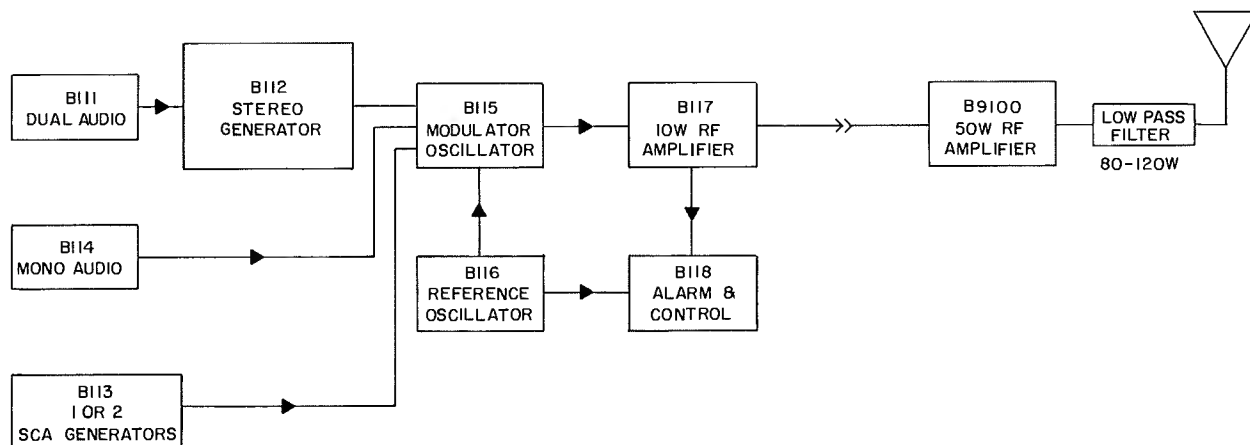

Block Diagram of B-9100T

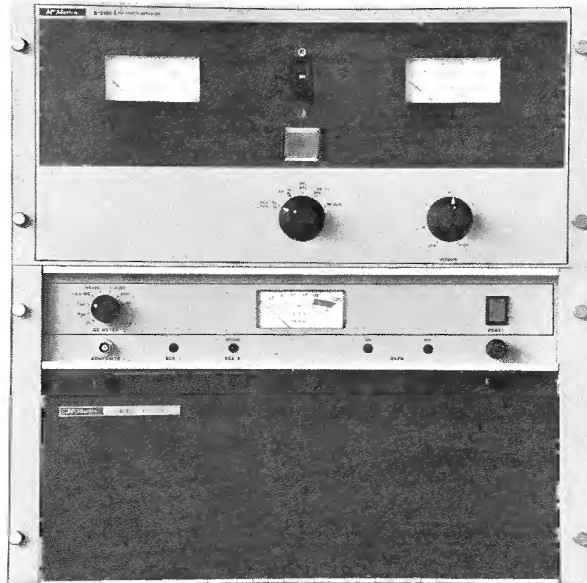

Front View of B-9100T

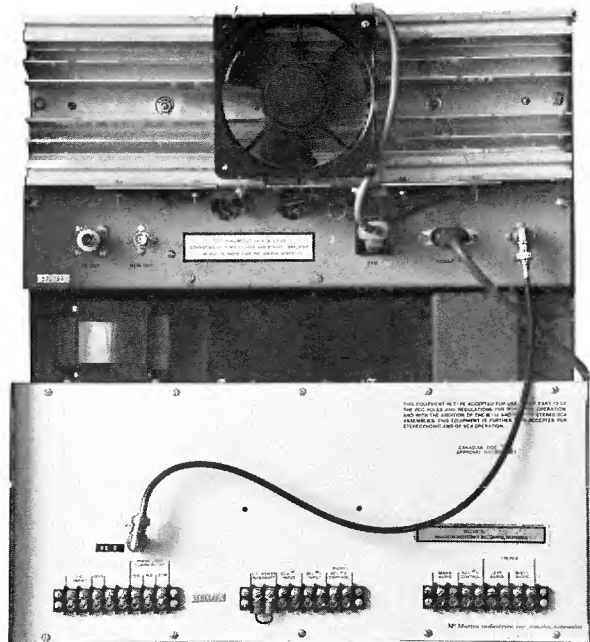

Rear View of B-9100T

B-110 STEREO GENERATOR

The optional B-110 Stereo Generator operates in the B-9100/9100T in conjunction with a B-111 Stereo Audio Amplifier, and provides for the generation of the 19 kHz pilot and the composite stereo signals (L+R and L-R). The stereo generator utilizes a switching mode oscillator employing a temperature stabilized crystal at four times the 19 kHz pilot frequency (76 kHz). This 76 kHz signal is digitally divided to derive the 19 kHz pilot and the 38 kHz square wave signal used to alternately switch between the left and right channel audio signals. Circuitry is precisely designed to assure that 38 kHz subcarrier suppression is 55 dB below the modulated signal. The use of the square wave switching mode eliminates the need for troublesome carrier balance adjustments. This simplifies adjustment, and additionally provides for excellent stereo separation (35 dB through the entire exciter or transmitter). A 53 kHz low-pass filter is employed to assure that no objectionable harmonic content of the 19 kHz pilot exists. This assures that no interference will occur with a 67 kHz SCA channel.

Adjustments for the B-110 Stereo Generator are held to minimum with only Pilot Level and Pilot Phase (for setting proper timing of the pilot and L-R signal) provided on the front panel.

Local and remote stereo/mono mode switching is provided for, with front panel indication provided when in stereo operation, with provision for connection of a remote indicator.

B-113 SCA GENERATOR

The B-113 SCA Generator is optionally available to provide a 67 kHz subchannel in an exciter equipped with a stereo generator. In a monaural exciter a 67 kHz and/or a 41 kHz SCA Generator are available (other frequencies, 20-75 kHz are available on special order).

The B-113 is an ultrastable SCA generator utilizing direct FM modulation providing subcarrier frequency accuracy of ± 500 Hz. Manual or automatic SCA muting is provided and the mute circuitry is adjustable, both modulation level and delay time (which is continuously adjustable $\frac{1}{2}$ to 8 secs).

Unique to the B-113 is the ability to remotely disable the automatic mute. This circuit provides a ready means of obtaining the necessary signal when making measurements at the studio requiring an unmodulated SCA subcarrier.

B-113 SCA Generators are factory equipped for ± 6 kHz deviation with a 7.5 kHz input filter. For ± 4 kHz SCA deviation requirement a 5 kHz input filter is optionally available.

The B-113 also has provision to allow the SCA subcarrier to be switched on and off locally and remotely.

STANDARD SCA FILTER COMBINATIONS			
SCA	INPUT FILTER		OUTPUT FILTER
	4 kHz • DEVIATION • 6kHz		
41 kHz	5 kHz	7.5 kHz	60 kHz LP
67 kHz monaural	5 kHz	7.5 kHz	90 kHz LP
67 kHz stereo	5 kHz	7.5 kHz	67 kHz BP

SPECIFICATIONS

PERFORMANCE:

Type of Emission	F3/F9
Frequency Range88-108 MHz
RF Power Output80-120 watts
RF Output Impedance50 ohms, unbalanced

Carrier Frequency Stability	±500 Hz over rated temperature range
Frequency Deviation for 100% Modulation	±75 kHz
Modulation Capability	±150 kHz
Method of Modulation	Direct FM
Audio Input Impedance600 ohms balanced
Audio Input Level	+10, ±2 dBm
Audio Frequency Response	±0.5 dB 30-15,000 Hz
Pre-Emphasis Network Time Constant75 μ sec pre-emphasis, 50 μ sec avail.
IM Distortion0.2% or less 60 Hz/7KHz, 4:1 ratio
Total Harmonic Distortion	less than 0.3% 30-15,000 Hz
FM Noise65 dB or greater below 100% modulation at 400 Hz
AM Noise65 dB below carrier level

ELECTRICAL:

Power Required	100-135 (200-270), VAC 50/60 Hz
Power Consumption (With Stereo and SCA Generator)270 watts
Ambient Temperature	-20° to 50°C (-4° to 122°F)

DIMENSIONS	19¼" (48.90 cm) High 19" (48.30 cm) Wide
B-9100 Amplifier8¾" (22.23 cm) High 19" (48.30 cm) Wide 14½" (36.83 cm) Depth
B-910 Exciter10½" (26.67 cm) High 19" (48.30 cm) Wide 17¾" (45.09 cm) Depth

FINISH	McMartin beige with wood grain trim front access panel
--------------	--

OUTPUT CONNECTOR

REQUIRED	PL 259
----------------	--------

B-9100T with B-110 STEREO GENERATOR

PERFORMANCE:

Pilot Carrier Stability19 kHz ±1Hz over rated temperature range
Subcarrier Suppression	-55 dB or greater
Audio Input Impedance (Left and right channels into B-111 Stereo Audio Amplifier)600 ohms balanced
Audio Input Level (Left and right channels into B-111 Stereo Audio Amplifier)	+10, ±2 dBm

Audio Frequency Response	±0.5 dB 30-15,000 Hz
Pre-Emphasis Network Time Constant75 μ sec pre-emphasis, 50 μ sec avail.
IM Distortion0.2% or less 60 Hz/7 kHz, 4:1 ratio
Total Harmonic Distortion0.5% or less, 30-15,000 Hz
Stereo Separation (50-15,000 Hz)39 dB or greater through B-112 module. 35 dB or greater. B-9100T typically 50 dB or greater at mid range.
Crosstalk (main channel to sub channel and sub channel to main channel 30-15,000 Hz)40 dB or greater
FM Noise65 dB or greater below 100% modulation
Remote Capability	pilot on/off, pilot on indication
Filtering Provided15 kHz input, 53 kHz low pass output

B-9100T with B-113 SCA GENERATOR

PERFORMANCE:

Type of Modulation	Direct FM
Carrier Frequency67 kHz and 41 kHz standard (20 kHz to 75 kHz available)
Frequency Stability	±500 Hz over rated temperature range
Audio Input Impedance600 ohms balanced
Audio Input Level	+10, ±2 dBm
Audio Frequency Response	±1.5 dB, 50-5,000 Hz
Total Harmonic Distortion	less than 0.6% at 400 Hz (B-113 only)
Mono	less than 0.75%, 50-5,000 Hz
Stereo	less than 2.5%, 50-5,000 Hz
Crosstalk (main channel to SCA and SCA to main channel)60 dB or greater below normal program levels
Modulation Capability	±7.5 kHz
Pre-Emphasis Network Time Constant150 μ sec standard, 75 μ sec or 50 μ sec available
Automatic Mute	Adjustable to any level between 100% and 3% modulation
Mute Delay	0.5 sec to 8 sec (continuously adjustable)
FM Noise60 dB below 100% modulation (±6 kHz deviation) 150 μ sec de-emphasis
Remote Capability	SCA-on/off, Auto-Mute on/off
Filtering Provided	
Monaural Exciter7.5 kHz input, 90 kHz low pass output
Stereo Exciter5 kHz input, 67 kHz band pass output
41 kHz units with Monaural Exciter7.5 kHz input, 60 kHz low pass output

(Other filter combinations are available.)

All specifications for monaural, stereo and SCA operation are for the entire B-9100T.

ORDERING INFORMATION

MODEL	DESCRIPTION	PRODUCT CODE
B-9100T	Transmitter, 100 watt, Rack mount	10-01-020
B-9100	100 watt amplifier only	10-01-002
B-110	Stereo generator, plug-in for B-9100T	10-01-004
B-113	SCA generator, plug-in for B-9100T	10-01-007

15 WATT EXCITER/TRANSMITTER

BFM-15



- DIRECT FM MODULATION**
- PHASE-LOCKED AFC PROVIDES ± 500 Hz STABILITY**
- AVAILABLE WITH OPTIONAL STEREO AUDIO PROCESSOR MODULE**
- SUPERIOR STEREO SEPARATION**
- FULL METERING THAT INCLUDES REFLECTOMETER**
- NOT AFFECTED BY POWER LINE TRANSIENTS**
- OFF-FREQUENCY OPERATION IMPOSSIBLE WITH POSITIVE ACTION FAIL-SAFE ALARM**
- REMOTE CONTROL PROVISIONS**
- SAME UNIT CAN BE USED AS EXCITER OR LOW POWER TRANSMITTER**

MCMARTIN

MC MARTIN BFM-15 EXCITER/TRANSMITTER

The McMartin BFM-15 is designed to function either as an exciter for a higher power FM broadcast transmitter or, as a 10-watt FM broadcast transmitter.

The BFM-15 is fully type accepted by the FCC for use as a monaural exciter, or when it includes a plug-in BFM-1521 Stereo Generator, and/or a plug-in BFM-1531 SCA Generator, for stereophonic and/or SCA broadcasting. The BFM-15 FM exciter is available in models for monaural, with one or two SCA channels; or for stereo, with or without an SCA channel. The BFM-15 additionally will directly accept a composite stereo signal for applications where the stereo generator is located at the studio.

The BFM-15 incorporates, as standard in its design, a unique C-MOS phase-locked direct FM modulator. This provides ultrastable and precise frequency control.

All circuitry for the BFM-15 FM Exciter/Transmitter is housed on front accessible plug-in modules, with a module extender provided. Front panel metering of necessary operating parameters is provided. Monitoring and full remote control provisions are included in the BFM-15.

The BFM-15 has been designed to provide the cleanest, crispest, most usable FM main channel signal, and when so equipped, multiplex stereo and SCA sub-channel signals. Particular care is taken in providing optimum filtering in BFM-15 units equipped with Stereo and/or SCA Generators.

An important feature of the BFM-15 exciter/transmitter system, is the availability of a state-of-the-art **audio processor board**, McMartin module number BFM-1514. This stereo audio processor allows FM broadcasters to achieve the highest possible modula-

tion level without undesirable audio degradation effects such as pumping, overshoot, clipping and thumping.

The BFM-1521 Stereo Generator is equipped with 15 kHz input filters and a 53 kHz low-pass output filter to assure that there is no interference with a 67 kHz SCA channel.

67 kHz BFM-1531 Generators are provided with optimum filtering depending on whether they are used with monaural or stereo exciters. When utilized with a monaural exciter, a 7.5 kHz band pass input filter is used; and a 90 kHz low pass output filter is used (this assures lowest distortion SCA and main channel reception.) This filter combination assures the cleanest monaural and SCA signals, with objectionable interference and "birdies" totally eliminated. When a 67 kHz SCA Generator is used with an exciter equipped with a BFM-1521 Stereo Generator, the SCA generator's output filter is a 67 kHz band pass filter, thus assuring that no interference with the stereo (L-R) signal will occur.

41 kHz BFM-1531 SCA Generators are equipped with 7.5 kHz input filters and a 60 kHz low pass output filter, which assures total non-interference with the main channel and the 67 kHz SCA.

BFM-1531 SCA Generators are factory equipped for ± 6 kHz deviation with the 7.5 kHz input filter. For ± 4 kHz SCA deviation requirement a 5 kHz input filter is optionally available.

This care in providing optimum filtering is just another example of the quality and care that comes with a BFM-15, assuring clean signals with no possible sub-channel to main channel interference.

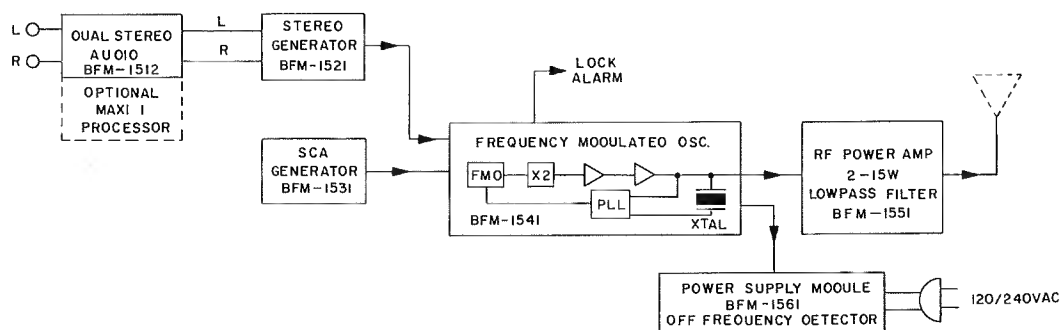

Block diagram

BFM-15 FM TRANSMITTER

The BFM-15 is designed to serve also as a 10 watt transmitter for low power educational FM stations, or as a 2-15 watt STL (studio to transmitter link) or relay transmitter in those countries where the 88 to 108 MHz band is available for such use. The BFM-15 is available housed in an attractive dustproof matching cabinet for use in applications where rack mounting is not desired. It is fully type accepted by the FCC for use as a 10-watt FM transmitter.



BFM-1514 Stereo Audio Processor

BFM-1521 STEREO GENERATOR

The optional BFM-1521 Stereo Generator operates in the BFM-15 in conjunction with a Stereo Audio Amplifier, and provides for the generation of the 19 kHz pilot and the composite stereo signals (L+R and L-R). The stereo generator utilizes a switching mode oscillator employing a temperature stabilized crystal at four times the 19 kHz pilot frequency (76 kHz). This 76 kHz signal is digitally divided to derive the 19 kHz pilot and the 38 kHz square wave signal used to alternately switch between the left and right channel audio signals. Circuitry is precisely designed to assure that 38 kHz subcarrier suppression is 55 dB below the modulated signal. The use of the square wave switching mode eliminates the need for troublesome carrier balance adjustments. This simplifies adjustment, and additionally provides for excellent stereo separation (40 dB through the entire exciter or transmitter).

Adjustments for the BFM-1521 Stereo Generator are held to minimum with only Pilot Level and Pilot Phase (for setting proper timing of the pilot and L-R signal) provided on the front panel.

Local and remote stereo/mono mode switching is provided for, with front panel indication provided when in stereo operation, with provision for connection of a remote indicator.

BFM-1514 AUDIO PROCESSOR

The BFM-1514 dual channel audio processor has been designed to precisely control the modulation of the FM stereo or mono transmission system preventing over-modulation with varying audio input levels.

Pre-emphasis may be switched in or out as desired. The processor is frequency conscious and follows the pre-emphasis curve, thereby assuring that the problems associated with pre-emphasis are controlled. This is accomplished by an extremely fast AGC circuit and not by diode clippers which produce undesired interference problems, especially in stereo transmissions. These circuits provide limiting of overshoot to 2%.

Approximately 20 db of gain reduction at low frequencies, and 30 db gain reduction at high frequencies (pre-emphasis in), produce optimum compression and gain reduction without the use of other signal processing devices.

A front panel **release time** control is adjustable in order to optimize the system for maximum loudness — using the fast setting (counter clockwise) — or for the best quality — using the slow setting (fully clockwise).

The recovery time will always be short for transients regardless of the setting of the control. Under sustained gain reduction, the recovery time will automatically lengthen depending on the program material content.

For complete specifications for the MAXI-I the BFM-1514R which consists of the BFM-1514 Audio Processor, the BFM-1521 Stereo Generator both enclosed in a 3½" rack mount assembly including power supply refer to a copy of the MAXI-I product sheet.

BFM-1531 SCA GENERATOR

The BFM-1531 SCA Generator is optionally available to provide for a 67 kHz subchannel in an exciter equipped with a stereo generator. In a monaural exciter either a 67 kHz and/or a 41 kHz SCA Generator are optionally available (other frequencies 20-75 kHz are available on special order.)

The BFM-1531 is an ultrastable SCA generator utilizing a new internally compensated direct FM oscillator providing for ultra stable operation even over widely varying temperature condition. Manual or automatic SCA muting is provided and the mute circuitry is adjustable, both as to modulation level, and delay time which is continuously adjustable ½ to 8 secs.

Unique to the 1531 is the ability to remotely disable the automatic mute. This circuit provides a ready means of obtaining the necessary signal when making measurements at the studio requiring an unmodulated SCA subcarrier.

BFM-1531 SCA Generators are factory equipped for ±6 kHz deviation with a 7.5 kHz input filter. For ±4 kHz SCA deviation requirement a 5 kHz input filter is optionally available.

The BFM-1531 also has provision to allow the SCA subcarrier to be switched on and off locally and remotely.

PHASE-LOCK DIRECT FM MODULATOR

The heart of the BFM-15 is the Direct FM modulator, with a unique phase-lock AFC circuit providing ±500 Hz frequency stability. The frequency-modulated oscillator itself, as shown on the block functional of the BFM-15, utilizes a free running oscillator at ½ of the operating frequency. This frequency is modulated by both the main and all sub-channel audio signals (stereo and/or SCA), and is then doubled to the operating frequency. This on-carrier frequency signal is then digitally divided, and compared in the reference oscillator with a similarly divided signal from a highly stable temperature controlled crystal oscillator at 1/10 of the operating frequency. The AFC voltage to the Frequency Modulated Oscillator (FMO) is derived from a phase comparator that compares the two signals at 2¹⁴ division of operating frequency (a frequency, dependent on carrier frequency, below 10 kHz). Any phase difference detected between the two signals represents a frequency difference between the two signals, and consequently an off-frequency condition of the FMO. A correction voltage is then derived, which serves as an AFC voltage to maintain the FMO at its precise frequency.

Front panel indication is provided to show if loss of the phaselock condition occurs, with provision for connection of external aural alarms and/or a remote indication. In the unlikely chance of failure of the digital dividing circuitry, which would cause a loss of signal to the phase comparator, provision is made for manually controlling operating frequency.

To assure that the BFM-15 cannot operate beyond the assigned channel, an additional crystal controlled alarm circuit is utilized in a "carrier-loss" circuit. This circuit, in the further unlikely event that the operating frequency goes 100 kHz beyond the operating frequency will cause a loss of VCC to the RF amplifier and turn off the RF output.

EASE OF OPERATION AND MAINTENANCE

The BFM-15 is designed for simple and easy operation with operational controls held to a minimum.

Full front panel metering is provided to allow monitoring of operating voltages total modulation and other parameters.

Tuning the BFM-15 is a very easy procedure and is accomplished in seconds utilizing the front panel meter to give an indication of a phase-lock condition between the frequency modulated oscillator and the reference oscillator. Once phaselock is achieved, no further frequency tuning is required or necessary.

Front accessible plug-in modules are used for all operating circuitry and a module extender is provided.

STANDARD SCA FILTER COMBINATIONS			
SCA	INPUT FILTER		OUTPUT FILTER
	4 kHz • DEVIATION • 6 kHz		
41 kHz	5 kHz	7.5 kHz	80 kHz LP
67 kHz monaural	5 kHz	7.5 kHz	80 kHz LP
67 kHz stereo	5 kHz	7.5 kHz	80 kHz LP

SPECIFICATIONS

BFM-15 EXCITER/TRANSMITTER

PERFORMANCE:

Type of Emission	F3/F9
Frequency Range	88-108 MHz
RF Power Output	2-15 watts continuously adjustable.
RF Output Impedance (Type BNC connector)	.50 ohms, unbalanced
Carrier Frequency Stability	±500 Hz over rated temperature range
Frequency Deviation for 100% Modulation	±75 kHz
Modulation Capability	±150 kHz
Method of Modulation	Direct FM
Audio Input Impedance	.600 ohms balanced
Audio Input Level	+10, ±2, dBm
Audio Frequency Response	±0.5 dB 30-15,000 Hz
Pre-Emphasis Network Time Constant	.75 μ sec pre-emphasis, 50 μ sec avail
IM Distortion Total Harmonic Distortion	.0.2% or less 60 Hz/7 KHz, 4:1 ratio
FM Noise	.65 dB or greater below typically 70db 100% modulation
AM Noise	.65 dB below carrier level
Power Required	100-135 (200-270) VAC 50/60 Hz
Power Consumption (With Stereo and SCA Generator)	.50 watts
Ambient Temperature	-20° to 50° C (-4° to 122° F)

DIMENSIONS

Rack Mount	height	10½" (26.7 cm)
	width	19" (48.3 cm)
	depth	14¼" (36.0 cm)
In B-122 Cabinet	height	11¾" (29.8 cm)
	width	20" (50.8 cm)
	depth	18" (45.7 cm)

WEIGHT

Rack Mount	actual	.34 lbs. (15.4 kg)
	shipping	.44 lbs. (19.3 kg)
In B-122 Cabinet	actual	.39 lbs. (17.7 kg)
	shipping	.49 lbs. (22.2 kg)

FINISHMcMartin Beige

STEREO OPERATION (with BFM-1521 Stereo Assembly)

AUDIO INPUT IMPEDANCE	.600 ohms balanced, each channel
AUDIO INPUT LEVEL	+10, ±2, dBm
AUDIO FREQUENCY RESPONSE	±0.75 dB, 30-15,000 Hz, Std FCC 75 usec, preemphasis, each channel
TOTAL HARMONIC DISTORTION	.0.5% or less, 30-15,000 Hz
IM DISTORTION	.0.2% or less 60 Hz/7 KHz, 4:1 ratio
STEREO SEPARATION	.40 dB or greater, 50-15,000 Hz typically 50 dB or greater at mid-range
FM NOISE	>60 dB or greater below 100% modulation
PILOT STABILITY	±1.0 Hertz over rated temperature range
SUBCARRIER SUPPRESSION	.55 dB or greater
CROSSTALK (L+R to L-R, L-R to L+R)	.40 dB or greater below 90% modulation

ORDERING INFORMATION

Model	Description	Product Code
BFM-15	Exciter, monaural, 15 watt (includes BFM-1561, 1551, 1541, 1511, and 1501 (2) Modules)	10-01-119
BFM-15	Transmitter, 15 watt, rack mount	10-01-119
BFM-15	Transmitter, 15 watt with B-122 cabinet	10-01-119
PLUG-IN MODULES FOR BFM-15		
BFM-1501	Blank panel	10-01-130
BFM-1511	Mono audio amplifier	10-01-128
BFM-1512	Stereo audio amplifier	10-01-129
BFM-1514	Stereo audio processor module	10-01-127
BFM-1521	Stereo generator	10-01-125
BFM-1531	SCA generator	10-01-124
BFM-1541	Modulation oscillator/AFC	10-01-123

SCA OPERATION (with BFM-1531 SCA Generator Module)

AUDIO INPUT IMPEDANCE	.600 ohms, balanced
AUDIO INPUT LEVEL	+10, ±2, dBm
CARRIER FREQUENCY	.41 or 67 KHz standard (others available on request)
CARRIER STABILITY	±500 Hz
MODULATION CAPABILITY	±7.5 kHz
PREEMPHASIS	.150 usec standard, 50 or 75 usec available on request
FREQUENCY RESPONSE	±1.5 dB, 50-5000 Hz
CROSSTALK (main to sub, sub to main)	.60 dB or lower
DISTORTION (50-5000 Hz)	.0.75% or less with LP output filter, 2.5% or less with BP output filter
S/N NOISE	.60 dB or greater

BFM-1551	RF amplifier	10-01-122
BFM-1561	Power supply/Alarm	10-01-121
<i>Note: Stereo operation with audio processor requires both BFM-1514 and BFM-1521. Stereo operation without audio processor requires BFM-1512 and BFM-1521.</i>		
B-122	Cabinet assembly for BFM-15 or B-910	10-01-016
B-123	Cabinet assembly for exciter (BFM-15 or B-910) and B-950 amplifier	10-01-023
SCK-15	100% spare semiconductor kit for BFM-15	10-01-140
CRYSTAL	For reference oscillator (specify transmitter freq.)	90-02-002
CRYSTAL SET	Two crystals; 1 for reference oscillator, 1 for alarm and control module (specify transmitter freq.)	90-02-002

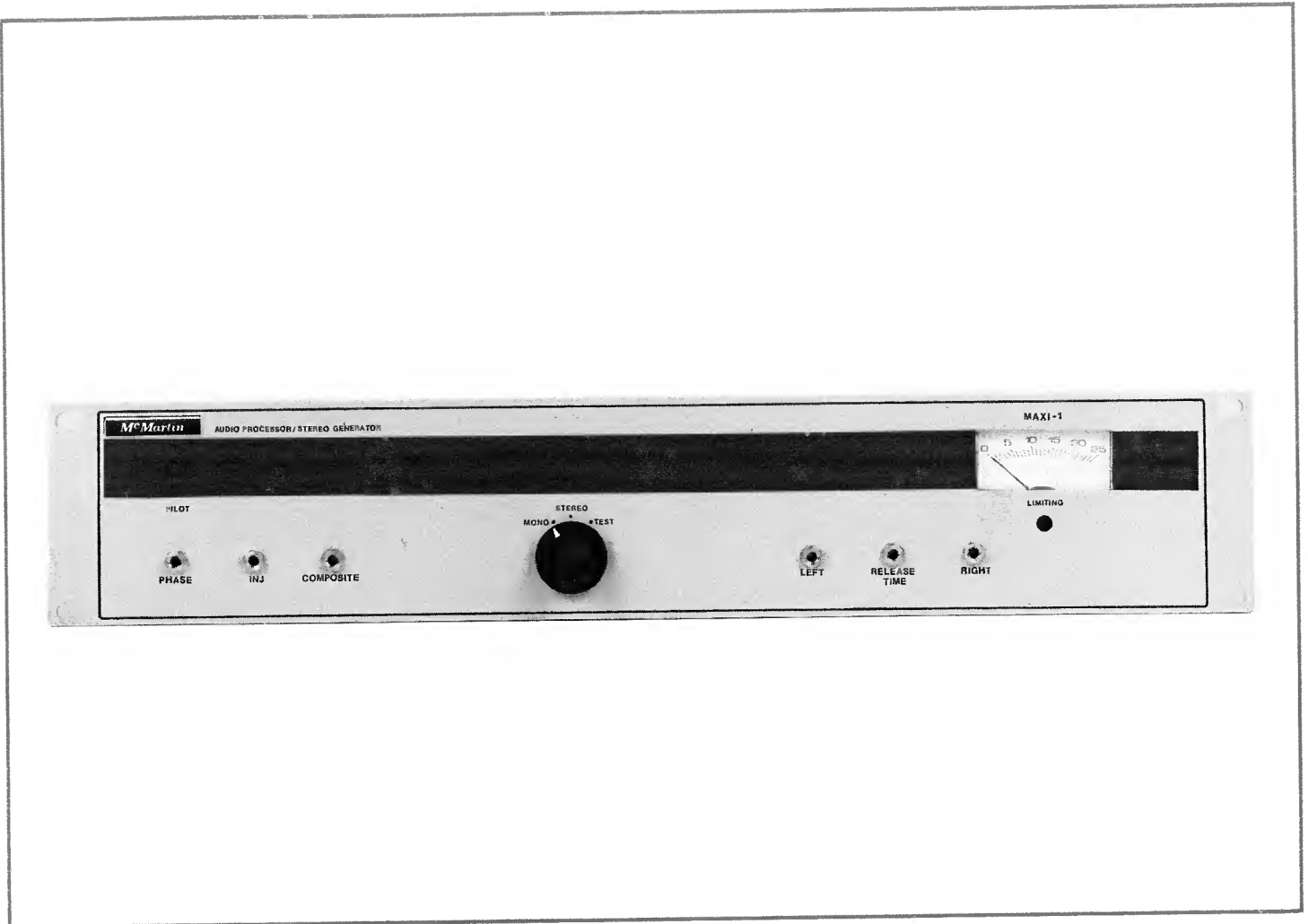

MAXI-1 AUDIO PROCESSOR/STEREO GENERATOR **BFM-1514R**
AUDIO PROCESSOR MODULE **BFM-1514**

MCMARTIN

BFM-1514R MAXI-I AUDIO PROCESSOR/STEREO GENERATOR
BFM-1514 AUDIO PROCESSOR MODULE

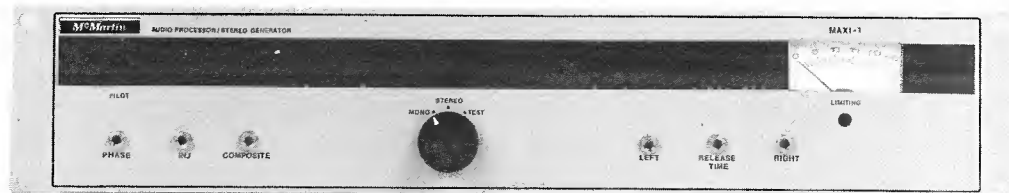

MAXIMUM LOUDNESS FOR FM BROADCAST STATIONS

NATURAL SOUND — NO CLIPPING, THUMPING OR PUMPING EFFECTS

LOW LEVELS OF GAIN REDUCTION DO NOT DESTROY PRE-EMPHASIS

AVAILABLE AS BFM-15 EXCITER MODULE OR AS RACK MOUNTED UNIT

The MAXI-I dual channel audio processor has been designed to precisely control the modulation of the FM stereo or mono transmission system preventing over-modulation with varying audio input levels. This allows broadcasters to realize an increase in overall volume of their transmitted signal. Although various limiting and compression devices have been available for some years, the MAXI-I has been designed to eliminate the unpleasant and annoying distortions frequently associated with these units. The MAXI-I utilizes very sophisticated circuits to provide natural sounding gain control adjustable from front panel controls.

Pre-emphasis may be switched in or out as desired. The processor is frequency conscious and follows the pre-emphasis curve, thereby assuring that the problems associated with pre-emphasis are controlled. This is accomplished by an extremely fast AGC circuit and not by diode clippers which produce undesired interference problems, especially in stereo transmissions.

Approximately 20 db of gain reduction at low frequencies, and 30 db gain reduction at high frequencies (pre-emphasis in), produce optimum compression and gain reduction without the use of other signal processing devices.

A front panel **release time** control is adjustable in order to optimize the system for maximum loudness — using the fast setting (counter clockwise) — or for the best quality — using the slow setting (fully clockwise).

The recovery time will always be short for transients

regardless of the setting of the control. Under sustained gain reduction, the recovery time will automatically lengthen depending on the program material content.

The MAXI-I audio processing is available in two ways.

1) The BFM-1514R MAXI-I is a rack mounted stereo audio processor and stereo generator combined, suitable for use with virtually any FM exciter. In addition to the MAXI-I features, the BFM-1514R uses a stereo generator electronically similar to that used in the BFM-15 to provide generation of the 19 kHz pilot and the composite stereo signals (L+R and L-R).

2) The BFM-1514 is a plug-in module for use in the McMartin BFM-15 complete FM Exciter/Transmitter. The BFM-15 is capable of providing standard FM exciter functions plus SCA and Stereo generation, **as well as MAXI-I audio processing**, within a single package.

The stereo generator utilizes a switching mode oscillator employing a temperature stabilized crystal at four times the 19 kHz pilot frequency (76 kHz). This 76 kHz signal is digitally divided to derive the 19 kHz pilot and the 38 kHz square wave signal used to alternately switch between the left and right channel audio signals. Circuitry is precisely designed to assure that 38 kHz subcarrier suppression is 55 dB below the modulated signal. The use of the square wave switching mode eliminates the need for troublesome carrier balance adjustments. This simplifies adjustment, and additionally provides for excellent stereo separation (40 dB or greater through the entire exciter or transmitter).

Visible Proof of MAXI-I Performance!

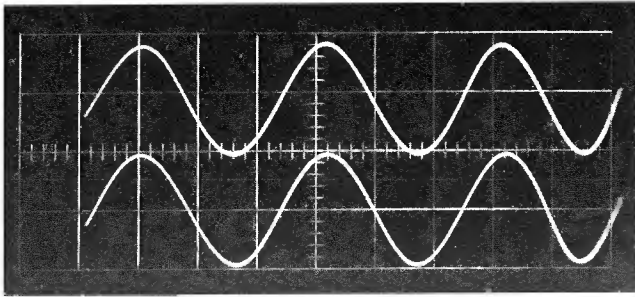

In each of the oscilloscope photographs, the top trace displays the output of the MAXI-I audio processor, and the bottom trace shows the same signal as output from a McMartin TBM-3500B base band monitor.

Figure 1: 1000 Hz sine wave input at 100% modulation, 10 dB compression.

Figure 2: 1000 Hz triangular wave input with the input signal amplitude held constant, 10 dB compression. As indicated in the photo, the modulation does not exceed 100%.

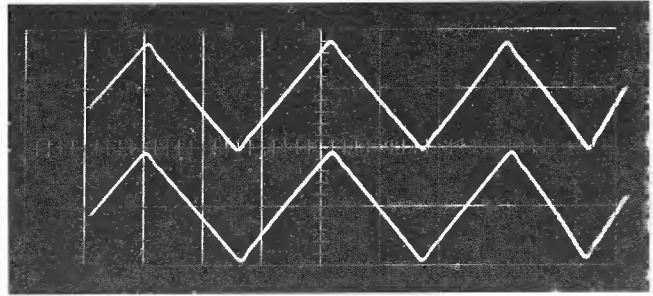

Figure 3: 1000 Hz square wave input, 10 dB compression, with the input signal amplitude held constant. The trace shows the overshoot, or ringing, of the 15 kHz low pass filter. The fast attack time of the AGC amplifier is evident on the first overshoot pulse.

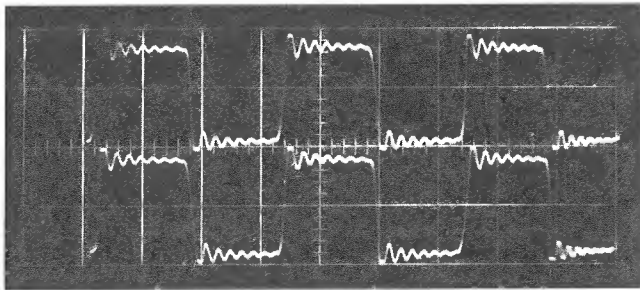

Figure 4: Input signal is a 100 Hz square wave. Compression is 10 dB. In the output waveform shown, the leading edges have spikes not indicated in the photograph. However, the spikes do not exceed 100% modulation. Defeating the pre-emphasis will remove the high frequency spikes completely.

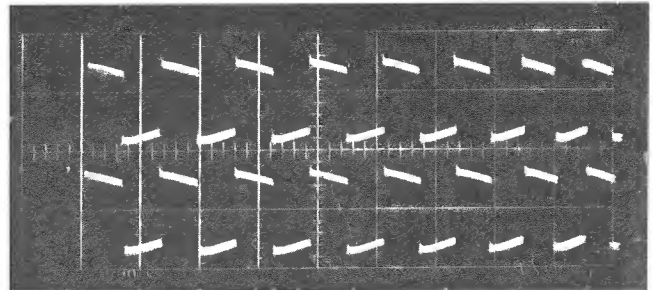

Figure 5: A 15 kHz sine wave input signal is pulse modulated with a pulse duration of 5 milliseconds and a repetition rate of 1.5 seconds. The pre-emphasis circuit is in; compression is 10 dB. The indicated overshoot is less than 2%. The leading edge indicates the extremely fast rise time of the AGC system.

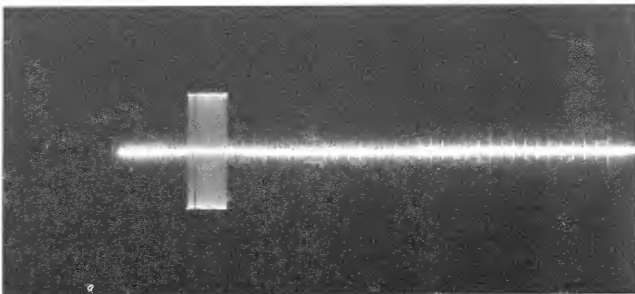
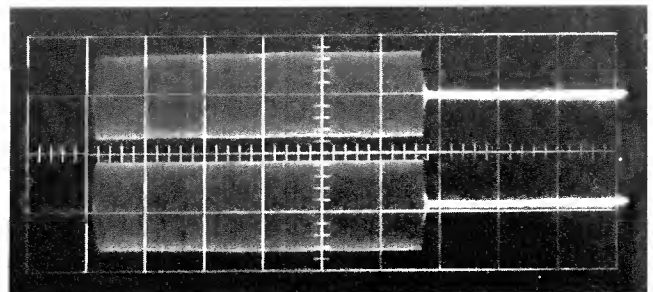

Figure 6: Same input as in Figure 5, but with time base expanded to show the compression ripple more clearly.



SPECIFICATIONS

McMartin BFM-1514R, "MAXI-I", Audio Processor/Stereo Generator BFM-1514 Audio Processor Module

INPUT IMPEDANCE 600 Ohms, balanced

INPUT LEVEL -10dBm for low frequency limiting threshold; both channels adjustable for degree of limiting

OUTPUT IMPEDANCE 1K Ohms, unbalanced

OUTPUT LEVEL Right and Left adjusted separately

GAIN REDUCTION RANGE Greater than 20 dB, typically 26 dB

LIMITER CONTROL SYSTEM Variable gain cell driven from a DC control voltage; utilizes a distortion cancelling circuit with temperature compensation

AGC ATTACK TIME Wide band limiter: 20 microseconds
Pre-emphasis limiter: 50 microseconds

RELEASE TIME Low frequency: Variable with front panel control. Also memory controlled utilizing a multiple time constant. 20-250 milliseconds

Pre-emphasis: Dual memory controlled time constant which varies with program content

OVERSHOOT2% or less

AGC CONTROL VOLTAGE Ripple free at 30 Hz for low distortion audio

FREQUENCY RESPONSE Tracks standard 75 microsecond pre-emphasis curve within ± 1 dB (below limiting threshold)

SEPARATION BETWEEN CHANNELS Greater than 65 dB (50-15,000 Hz) (processor only) >40 dB stereo generator, see BFM-1501 stereo generator

HARMONIC DISTORTION 0.3% for the processor —
0.6% for the MAXI-I (processor and stereo generator) 50-15,000 Hz at any degree of gain reduction up to 20 dB. 0.15% typical below threshold of limiting (measured through a 75 microsecond de-emphasis network)

IM DISTORTION Less than .25%

SIGNAL TO NOISE RATIO 70 dB or greater through a 75 microsecond de-emphasis network

19 KHZ PILOT PROTECTION A 15 kHz low overshoot, lowpass filter provides 65 dB attenuation at 19 kHz

METERING Illuminated meter, calibrated 0-20 dB Maximum. High speed attack time and slow decay controlled by front panel *release time* control.

FRONT PANEL CONTROLS Left Channel Modulation
Right Channel Modulation
Flat/Pre-emphasis switch
Release Time

POWER REQUIRED 100 ma. +24 volts DC

OPERATING TEMPERATURE RANGE 0-50° C

DIMENSIONS
Plug-in Module: height 8½" (21.6 cm)
width 2½" (6.4 cm)
depth 10½" (26.7 cm)

Self Contained Unit: height 3½" (8.9 cm)
width 19" (48.3 cm)
depth 8½" (21.6 cm)

WEIGHT
Plug-in Module: actual 4.25 lbs. (1.9 kg)
shipping 6 lbs. (2.7 kg)

Self Contained Unit: actual 6.5 lbs. (2.9 kg)
shipping 8.5 lbs. (3.9 kg)

ORDERING INFORMATION

Model	Description	Product Code
BFM-1514	MAXI-I stereo audio processor module for BFM-15	10-01-127
BFM-1514R	MAXI-I stereo processor, self-contained, rack mount	10-01-134 (Consists of BFM-1514, and BFM-1521 in a single 3½" rack mount package including power supply)

McMartin.

price schedule

Effective December 31, 1977

BROADCAST EQUIPMENT

REMOTE PICK-UP EQUIPMENT, TRANSMITTER & RECEIVERS

Model	Description	Product Code	Price
RPU-1103	McMartin portable, 3 watt battery operated remote pickup transmitter 150.87 to 170.15 MHz. Bands K1, K2, L and M. Includes battery and antenna without microphone.	10-01-086	\$ 595.00
RPU-1403	McMartin portable, 3 watt battery operated remote pickup transmitter 450 MHz band. Includes battery and antenna without microphone. (Specify frequency)	10-01-087	695.00
RPU-1150	50 watt 150 MHz remote pickup transmitter. Includes mobile mount, requires 13.5 volt DC @ 10 amps transmit. (Specify frequency)	10-01-088	975.00
RPU-1330	30 watt 300 MHz remote pickup transmitter. Includes mobile mount, requires 13.5 volt DC @ 10 amps transmit. (Specify frequency)	10-01-077	1,345.00
RPU-1430	30 watt 450 MHz remote pickup transmitter. Includes mobile mount, requires 13.5 volt DC @ 10 amps transmit. (Specify frequency)	10-01-089	1,145.00
TBM-1100R	Receiver, 150 MHz, rack mount, single frequency. For second frequency, add \$10.00.	10-03-021	550.00

RPU ACCESSORIES

FOR RPU-1103 & RPU-1403			
RPU/BAT	Replacement battery, 12 volts Nicad		36.00
RPU/BC	Battery charger		40.00
RPU/ANT	Rubber duck antenna 150 MHz		17.00
RPU/ANT	Rubber duck antenna 450 MHz		17.00
RPU/2CH	Second Channel frequency module (specify frequency) for RPU-1103, 1403, 1150, 1430, and 1330.		85.00
RPU/MIC	Turner push-to-talk microphone model 350D		40.00
FOR RPU-1150, RPU-1330, & RPU-1430			
RPU/PS	AC power supply	10-01-095	200.00
RPU/RmCc	Rack mount and carrying case provides convenient carrying case and rack mounting for both the power supply and 50 or 30 watt transmitter. (Not required for mobile installations)	10-01-096	65.00
RPU/MC	Mobile control head for use when unit is trunk mounted. Includes cable from control head to transmitter.	10-01-098	100.00

RPU ANTENNAS

MOBILE (150 MHz)			
DB-702-100	2.5 dB Gain - Roof mount, includes 15' RG/58U cable and PL-259 connector.		30.00
DB-702-102	Same as above with "no holes" trunk mount.		35.00
BASE (150 MHz)			
DB-264	6 dB circular to 9 dB offset consists of 4 vertical folded dipoles, enclosed feed system, with type N male connector. Length 25R" top mounted. (Specify frequency)		216.00

RPU ANTENNAS (cont'd)

Model	Description	Product Code	Price
DB-5001	Side mount kit for DB-224.		58.00
DB-230	3 element YAGI - 7 dB Gain - Type N male connector supplied.		96.00
DB-230-2	2-DB-230's stacked -10 dB Gain harness and type N male connector supplied.		226.00
DB-230-4	4-DB-230's stacked -13 dB Gain harness and type N male connector supplied.		490.00
MOBILE (450 MHz)			
DB-705-201	5 dB Gain - Roof mount, includes 15' RG/58U cable and PL-259 connector.		28.00
DB-705-203	Same as above with "no holes" trunk mount.		35.00
BASE (450 MHz)			
DB-408	4 bay collinear array 6.6 dB Gain type N male connector supplied, length 9'5". (Specify frequency)		168.00
DB-410	8 bay version of DB-408 above 9.2 dB Gain, length 18'1". (Specify frequency)		270.00
DB-5012	Side mount kit for DB-408 or 410.		58.00
DB-436	6 element YAGI antenna 10 dB Gain type N male termination.		84.00
DB-436-2	2-DB-436 stacked 13 dB Gain.		184.00
DB-436-4	4 DB-436 stacked 16 dB Gain.		384.00

MINIMUM ORDER \$15.00

ALL ORDERS MUST USE PRODUCT CODE NUMBERS.

ALL PRICES FOB FACTORY AND SUBJECT TO CHANGE WITHOUT NOTICE

AM TRANSMITTERS

Model	Description	Product Code	Price
BA-1K	1000/500/250 watt AM transmitter, 208/230 Vac, 50/60 Hz, single phase, 3-wire (grounded neutral)	10-01-061	\$ 8,995.00
SR-1K	Sola filament regulator for BA-1K	10-01-062	220.00
STA-1K	100% spare tubes for BA-1K	10-01-063	420.00
	Spare Rectifier Diode Stack RS 1.5 - 12 - 12M (Requires 4)	210015	32.70
SC-AM	Spare vacuum crystal	10-01-064	93.00
PT-1K	Line transformer for 220/240 Vac, single-phase, 2-wire (for BA-1K)	10-01-065	245.00
SCK-A1K	Spare semi conductor kit (Audio and RF exciter transistor and diodes only)	10-01-093	50.00
BA-2.5K	2.5KW AM broadcast transmitter, 208/230 Vac, 50/60 Hz, single phase, 3-wire (grounded neutral)	10-01-066	13,850.00
SR-2.5K	Sola filament regulator for BA-2.5K	10-01-068	330.00
STA-2.5K	100% spare tubes for BA-2.5K	10-01-069	884.00
	Spare Rectifier Diode Stack RS 3.5 - 24 - 12S (Requires 4)	210016	74.50
SC-AM	Spare vacuum crystal	10-01-064	93.00
BA-5K	5KW AM broadcast transmitter (combined BA-2.5K), 208/230/240 Vac, 50/60 Hz, single phase, 3-wire (grounded neutral)	10-01-070	30,000.00
	Spare Rectifier Diode Stack RS 3.5 - 24 - 12S (Requires 8)	210016	74.50
BA-10K	10KW AM broadcast transmitter	10-01-036	31,000.00

FM TRANSMITTERS

BF-1K	.25 - 1.5KW FM broadcast transmitter, complete with exciter and tubes, 208/230/240 Vac, 50/60 Hz, single phase, 3-wire (grounded neutral)	10-01-090	11,500.00
STF-1K	Spare tube kit for BF-1K	10-01-094	260.00
	Spare Rectifier Diode Stack RS 1.5 - 12 - 12M (Requires 2)	210015	32.70
BF-3.5K	1.5 - 3.5KW FM transmitter, complete with exciter and tubes, 208/230/240 Vac, 50/60 Hz, single phase - or - optional (208/230/240 Vac 3 phase)	10-01-026	14,500.00
STF-3.5K	Spare tube kit for BF-3.5K	10-01-027	436.00
	Spare Rectifier Diode Stack RS 3.5 - 24 - 12S (Requires 4)	210016	74.50
BF-5K	3.5 - 5.5KW FM broadcast transmitter, complete with exciter and tubes, 208/230/240 Vac, 50/60 Hz, 3 phase - or - optional (208/230/240 Vac, single phase)	10-01-040	18,000.00
STF-5K	Spare tube kit for BF-5K	10-01-027	436.00
	Spare Rectifier Diode Stack RS 3.5 - 24 - 12S (Requires 4)	210016	74.00
BF-10K	5.5 - 15KW FM broadcast transmitter, complete with exciter and tubes, 208/230/240 Vac, 50/60 Hz, 3-phase	10-01-045	25,500.00
STF-10K	Spare tube kit for BF-10K	10-01-048	1,103.00
	Spare Rectifier Diode Stack, Low Voltage RS 1.5 - 12 - 12M (Requires 4)	210015	32.70
	Spare Rectifier Diode Stack, High Voltage RS 3.5 - 24 - 15S	210017	109.50
BF-25K	10 - 27.5KW FM broadcast transmitter, complete with exciter and tubes, 208/230/240 Vac, 50/60 Hz, 3-phase	10-01-046	35,950.00
STF-25K	Spare tube kit for BF-25K	10-01-047	1,461.00
	Spare Rectifier Diode Stack, Low Voltage RS 1.5 - 12 - 12M (Requires 4)	210015	32.70

McMartin.

FM TRANSMITTERS (cont'd)

Model	Description	Product Code	Price
	Spare Rectifier Diode Stack, High Voltage RS 3.5 - 24 - 15S (Requires 6)	210017	\$ 109.50
BF-55K	20 - 55KW FM broadcast transmitter, complete with one exciter (combined output of two BF-25K transmitters), 208/230/240 Vac, 50/60 Hz, 3 phase	10-01-071	79,250.00
Accessories			
AES	Automatic exciter switching for dual FM systems	10-01-072	6,900.00
AOS	Automatic RF output switching for dual FM systems	10-01-073	10,890.00
APC	Automatic power control for FM transmitter	10-01-074	330.00
AS-3	Three phase AC detector with auto restart	10-01-075	300.00
TCP-1	Transmitter control panel for remote control for AM/FM transmitter	10-01-076	425.00

FM EXCITER, LOW POWER 10 - 100 WATT TRANSMITTERS, ACCESSORIES

B-910	Exciter, monaural, 10 watt	10-01-001	2,650.00
Plug-in Modules			
B-110	Stereo generator assembly; plug-in module (includes B-111, 112, and filter)	10-01-004	1,675.00
B-111	Dual Audio Amplifier (used with B-112 stereo generator)	10-01-005	500.00
B-112	Stereo generator (includes 53 kHz filter)	10-01-006	1,160.00
B-113	SCA generator	10-01-007	600.00
B-114	Mono audio amplifier	10-01-008	236.00
B-115	Modulated oscillator	10-01-009	315.00
B-116	Reference oscillator	10-01-010	365.00
B-117	RF power amplifier	10-01-011	400.00
B-118	Alarm and control module	10-01-012	400.00
B-119	Power supply regulator	10-01-013	180.00
B-120	Harmonic filter	10-01-014	240.00
B-122	Cabinet assembly for B-910	10-01-016	250.00
B-123	Cabinet assembly for B-910 and B-950 amplifier	10-01-023	350.00
SCK-910	100% spare semiconductor kit	10-01-019	350.00
CRYSTAL	For reference oscillator (specify transmitter frequency)		45.00
CRYSTAL SET	Two crystals; 1 for reference oscillator, 1 for alarm and control module (specify transmitter frequency)		61.00
B-910T	Transmitter, 10 watt, rack mount	10-01-028	2,850.00
B-910T	Transmitter, 10 watt, with cabinet (as above; includes B-122)		3,025.00
B-110R	Stereo generator, self-contained, rack mount	10-01-017	1,790.00
B-113R	SCA generator, self-contained, rack mount	10-01-018	850.00
B-950	50 watt amplifier only	10-01-025	1,150.00
B-950T	Transmitter, 50 watts, rack mount (includes B-910 exciter and B-950 amplifier)	10-01-024	3,850.00
B-950T	Transmitter, 50 watts, as above with cabinet, B-123		4,100.00
B-9100	100 watt amplifier only		2,200.00
B-9100T	Transmitter, 100 watt, rack mount	10-01-002	4,850.00

AM MONITORS

RF-85B	AM RF amplifier	10-03-104	650.00
--------	-----------------	-----------	--------

McMartin

price schedule

Effective December 31, 1977

BROADCAST EQUIPMENT

1000 SERIES AUDIO CONSOLES			
Model	Description	Product Code	Price
1052V	5 Channel Stereo Vertical Attenuators CH 1 Microphone Input CH 2, 3, 4 HI Level Unbalanced Input CH 5 HI Level Balanced Input	10-02-146	\$ 2,385.00
1081	8 Channel Mono Rotary Attenuators CH 1, 2 Microphone Input CH 3, 4, 5, 6, 7 HI Level Unbalanced Input CH 8 HI Level Balanced Input	10-02-120	2,850.00
1081V	8 Channel Mono Vertical Attenuators CH 1, 2 Microphone Input CH 3, 4, 5, 6, 7 HI Level Unbalanced Input CH 8 HI Level Balanced Input	10-02-119	2,990.00
1082	8 Channel Stereo Rotary Attenuators CH 1, 2 Microphone Input CH 3, 4, 5, 6, 7 HI Level Unbalanced Input CH 8 HI Level Balanced Input	10-02-118	3,595.00
1082V	8 Channel Stereo Vertical Attenuators CH 1, 2 Microphone Input CH 3, 4, 5, 6, 7 HI Level Unbalanced Input CH 8 HI Level Balanced Input	10-02-117	3,750.00
REPLACEMENT PRINTED CIRCUIT CARDS for 1000 SERIES CONSOLES			
	Cue/Talkback Amplifier	10-02-124	135.00
	Program Amplifier	10-02-125	150.00
	Monitor Amp Stereo	10-02-126	160.00
	Monitor Amp Mono	10-02-134	100.00
	SANKEN Hybrid Module for use with MONITOR AMPS. Requires 1 Mono, 2 Stereo		25.00
	Stereo Mic PreAmp	10-02-130	140.00
	Mono Mic PreAmp	10-02-135	70.00
	Headphone Amplifier	10-02-129	100.00
	Stereo HI Level Balanced Input	10-02-131	86.00
	Mono HI Level Balanced Input	10-02-136	45.00
	Mono or Stereo HI Level Unbalanced Input	10-02-132	6.50
500 SERIES AUDIO CONSOLES			
B-501	5 mixer, monaural, 1 mic, 4 hi-bal	10-02-041	1,075.00
B-501SA	B-501 with step attenuators	10-02-044	1,350.00
B-502	5 mixer, stereo, 1 mic, 4 hi-bal	10-02-042	1,515.00
B-502SA	B-502 with step attenuators	10-02-045	2,010.00

AM/FM MONITOR AND EBS EQUIPMENT

Model	Description	Product Code	Price
AMR-1	AM monitor receiver, single channel	10-04-003	\$ 100.00
FMR-1D	FM monitor receiver, single channel	10-04-012	125.00
FMR-5	FM monitor receiver, five channel, first channel operation. For each additional channel, add \$10.00.	10-04-006	135.00
EBS-2	EBS decoder for AMR-1 and FMR-1D/FMR-5 (Two-tone system)	10-04-002	100.00
TG-2/EBS	Precision two-tone EBS generator	10-04-011	225.00

FM MONITORS

TBM-3700	Frequency and monaural modulation monitor	10-03-049	1,725.00
RM-37T	Remote metering plug-in card	10-03-052	80.00
RM-37R	Remote metering rack mount panel	10-03-051	220.00
TBM-2200A	Stereo modulation and pilot frequency adaptor	10-03-034	1,525.00
RM-22T	Remote metering plug-in card	10-03-037	110.00
RM-22R	Remote metering rack mount panel	10-03-036	245.00
TBM-2000B	SCA modulation and frequency adaptor	10-03-027	1,525.00
RM-20T	Remote metering plug-in card	10-03-030	80.00
RM-20R	Remote metering rack mount panel	10-03-029	210.00
TBM-3500B	Modulation monitor	10-03-029	1,590.00
RM-35B	Remote metering rack mount panel	10-03-045	150.00
LL-35B	Low level input module	10-03-044	225.00
TBM-2500C	RF amplifier	10-03-041	620.00

FM REBROADCAST RECEIVERS

TBM-1100R	Receiver 150 MHz	10-03-021	550.00
TBM-1005D	Five channel relay receiver (88-108 MHz) with one crystal.	10-03-009	485.00
	Each additional channel crystal		15.00
TBM-1003D	Aural TV channel 2-13 receiver		600.00
STE-1D	Plug-in stereo demod card for relay receiver	10-03-012	165.00
SCA-2D	Plug-in SCA demodulator card 41 kHz	10-03-010	110.00
	67 kHz	10-03-011	110.00

RELATED FM ANTENNAS

A-72-SF-3	3 element Yagi Antenna cut to band (2 per carton)		17.00
A-72-SF-5	5 element Yagi Antenna cut to band		29.00
AS-1	Stacking harness (for A-72-SF-3/SF-5)		26.00

MINIMUM ORDER \$15.00

ALL ORDERS MUST USE PRODUCT CODE NUMBERS

ALL PRICES FOB FACTORY AND SUBJECT TO CHANGE WITHOUT NOTICE

REPLACEMENT PRINTED CIRCUIT CARDS for 500 SERIES CONSOLES

Model	Description	Product Code	Price
Plug-In Cards			
5MP1	Microphone preamplifier (B501)	10-02-056	\$ 34.00
5MP2	Microphone preamplifier (B-502)	10-02-060	72.00
5BH1	High level balanced input (B501)	10-02-054	33.00
5BH2	Dual high level balanced input (B-502)	10-02-058	61.00
5BA1	Booster amplifier (B501)	10-02-055	22.00
5BA2	Dual booster amplifier (B-502)	10-02-059	28.00
5PG1	Program amplifier (B-501)	10-02-057	27.00
5PG2	Dual program amplifier (B502)	10-02-061	39.00
5PS1	Power regulator (All models)	10-02-053	28.00
Wire-in Cards			
5QA1	Cue amplifier	10-02-051	33.00
5MA1	Monitor amplifier	10-02-052	35.00
Accessories			
5RY1	Speaker muting relay (All Models)	10-02-064	17.00

REMOTE, PRODUCTION CONSOLES, PHONO PREAMP, TUNER, & MIXERS

ACCU-FIVE	5 channel rack mount mini console	10-02-080	700.00
BR-400	4 channel remote mixer amplifier	10-02-081	380.00
B-200B	Mono/stereo equalized phono preamplifier, balanced 600 ohm output	10-02-076	160.00
MX-5B	5-channel mixer/preamplifier	10-02-084	160.00
MRP-7B	Rack mount adaptor, beige, for MX-5	10-02-085	12.00
MXR-4	5 channel mixer/amplifier	20-04-046	88.00
MRP-6B	Rack mount adaptor for MXR-4	30-02-029	12.00
AF-200	AM/FM stereo tuner	30-01-013	150.00

BROADCAST MONITOR AMPLIFIERS

LT-80C/B	12-watt universal amplifier with one mic, 1 program input	10-05-001	91.00
LT-252B/B	25-watt universal amplifier with two mic, 2 program input	10-05-003	150.00
LT-250C/B	25-watt power amplifier	10-05-002	144.00
LT-500C/B	50-watt power amplifier	10-05-004	201.00
LT-750C/B	75-watt power amplifier	10-05-005	230.00
LT-1000C/B	100-watt power amplifier	10-05-006	288.00
LT-2000C/B	200-watt power amplifier	10-05-007	403.00
LT-3500C/B	350-watt power amplifier	10-05-008	680.00
MT-3B	Plug-in balanced/bridging transformer	10-05-009	13.00
MS-105	50-watt amplifier	20-04-105	53.00

MINIMUM ORDER \$15.00

ALL ORDERS MUST USE PRODUCT CODE NUMBERS.

ALL PRICES FOB FACTORY AND SUBJECT TO CHANGE WITHOUT NOTICE.

MCMARTIN

**10 watt
FM exciter
transmitter** **B-910** *series*

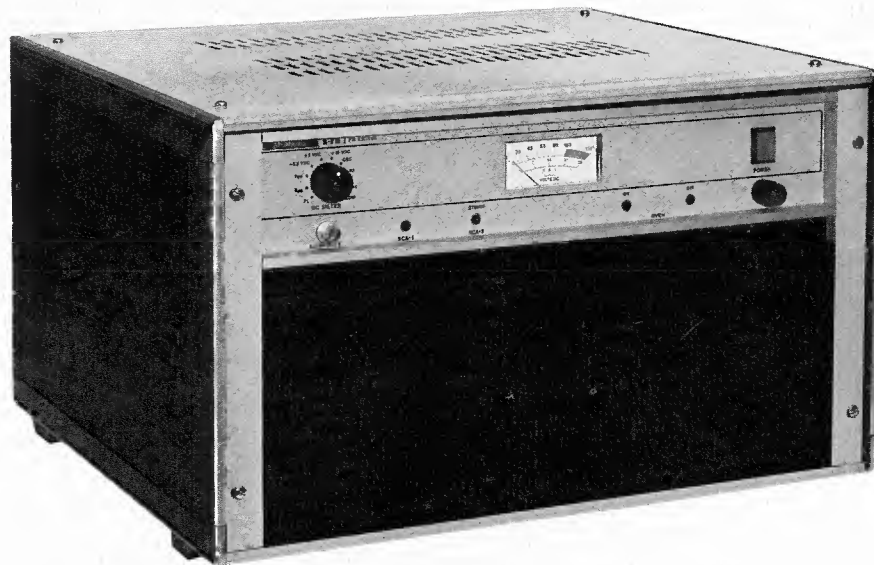

- Direct FM Modulation
- Unique Phase-Lock AFC Provides ± 500 Hz Stability
- Plug-In Modular Design
- Outstanding Performance
- Full Metering
- Off-Frequency Operation Impossible with unique Fail-Safe,
Positive Action Alarm Circuit
- Remote Control Provisions
- Available As Exciter/Or 10-Watt Transmitter
- Available Monaural Or Stereo – With or Without SCA
- Optimum Filtering For Stereo/SCA Combinations

GENERAL DESCRIPTION

The B-910/B-910T 10-watt Exciter/Transmitter is designed to function either as an exciter for a higher power FM broadcast transmitter or, as a Model B-910T, as a 10-watt FM broadcast transmitter. The B-910 and the B-910T differ only in that the B-910T incorporates a low-pass output filter and is housed in an attractive matching cabinet.

The B-910 is fully type accepted by the FCC for use as a monaural exciter, or when it includes a plug-in B-110 Stereo Generator, and/or a plug-in B-113 SCA Generator, for stereophonic and/or SCA broadcasting. The B-910 FM Exciter is available in models for monaural, with one or two SCA channels; or for stereo, with or without an SCA channel. The B-910 additionally will directly accept a composite stereo signal for applications where the stereo generator is located at the studio.

The B-910 incorporates, as standard in its design, a unique phase-locked direct FM modulator. This provides for ultra-stable and precise frequency control, offering frequency stability not previously available in an FM Exciter/10-watt FM Transmitter.

All circuitry for the B-910/B-910T FM Exciter/Transmitter, with the exception of heavy power supply components, is housed on front accessible plug-in modules, with a module extender provided. Front panel metering of necessary operating parameters is provided. Monitoring and full remote control provisions are included in the B-910/B-910T.

The B-910/B-910T has been designed to provide the cleanest, crispest, most usable FM main channel signal, and when so equipped, multiplex stereo and SCA subchannel signals. Particular care is taken in providing optimum filtering in B-910 units equipped with Stereo and/or SCA Generators.

The B-110 Stereo Generator is equipped with 15 kHz input filters and a 53 kHz low-pass output filter to assure that there is no interference with a 67 kHz SCA channel.

67 kHz B-113 SCA Generators are provided with optimum filtering depending on whether they are used with monaural or stereo exciters. When utilized with a monaural exciter, a 7.5 kHz band pass input filter is used; and a 90 kHz low pass output filter is used (this assures lowest distortion SCA and main channel reception). This filter combination assures the cleanest monaural and SCA signals, with objectionable interference and "birdies" totally eliminated. When a 67 kHz SCA Generator is used with an exciter equipped with a B-110 Stereo Generator, the SCA generator's output filter is a 67 kHz band-pass filter, thus assuring that no interference with the stereo (L-R) signal will occur.

41 kHz B-113 SCA Generators are equipped with 7.5 kHz input filters and a 60 kHz low pass output filter, which assures total non-interference with the main channel and the 67 kHz SCA.

B-113 SCA Generators are factory equipped for ± 6 kHz deviation with the 7.5 kHz input filter. For ± 4 kHz SCA deviation requirement a 5 kHz input filter is optionally available.

This care in providing optimum filtering is just another example of the quality and care that comes with a B-910/B-910T, assuring clean signals with no possible sub-channel to main channel interference.

PHASE-LOCK DIRECT FM MODULATOR

The heart of the B-910/B-910T is the Direct FM modulator,

with a unique phase-lock AFC circuit providing ± 500 Hz frequency stability. The frequency-modulated oscillator itself, as shown on the block functional of the B-910/B-910T, utilizes a free running oscillator at $\frac{1}{2}$ of the operating frequency. This frequency is modulated by both the main and all sub-channel audio signals (stereo and/or SCA), and is then doubled to the operating frequency. This on-carrier frequency signal is then digitally divided, and compared in the reference oscillator with a similarly divided signal from a highly stable temperature controlled crystal oscillator at $\frac{1}{10}$ of the operating frequency. The AFC voltage to the Frequency Modulated Oscillator (FMO) is derived from a phase comparator that compares the two signals at $\frac{1}{10,000}$ of operating frequency (a frequency, dependent on carrier frequency, between 8.8 kHz and 10.8 kHz). Any phase difference detected between the two signals represents a frequency difference between the two signals, and consequently an off-frequency condition of the FMO. A correction voltage is then derived, which serves as an AFC voltage to maintain the FMO at its precise frequency.

Front panel indication is provided to show if loss of the phaselock condition occurs, with provision for connection of external aural alarms and/or a remote indication. In the unlikely chance of failure of the digital dividing circuitry, which would cause a loss of signal to the phase comparator, provision is made for manually controlling operating frequency.

To assure that the B-910/B-910T cannot operate beyond FCC permitted frequency tolerances, an additional phase-lock comparator is utilized in a "carrier-loss" circuit. This circuit, in the further unlikely event that the operating frequency goes 100 kHz beyond the operating frequency will cause a loss of B+ to the RF amplifier and turn off the RF output.

B-910T 10-WATT FM TRANSMITTER

The B-910T 10-watt FM Transmitter is available for low-power non-commercial Educational FM stations and also for use as an STL (Studio to Transmitter Link) or Relay Transmitter in those areas where the 88 MHz to 108 MHz band is available for such use. The B-910T 10-watt FM Transmitter consists of a B-910 FM Exciter equipped with a harmonic filter and is available housed in an attractive dustproof matching cabinet (rack mount B-910T units are also available). It is fully type accepted by the FCC for use as a 10-watt FM transmitter.

EASE OF OPERATION AND MAINTENANCE

The B-910/B-910T is designed for simple and easy operation with operational controls held to a minimum.

Full front panel metering is provided to allow monitoring of operating voltages, total modulation and other parameters.

Tuning the B-910/B-910T is a very easy procedure and is accomplished in seconds utilizing the front panel meter to give an indication of a phase-lock condition between the frequency modulated oscillator and the reference oscillator. Once phase-lock is achieved, no further frequency tuning is required or necessary.

Front accessible plug-in modules are used for all operating circuitry with a hinged protective front cover and a module extender provided.

B-910/B-910T COMPLETE WITH STEREO AND SCA GENERATORS
(Front cover opened showing Plug-In Modules and Simplified Controls)

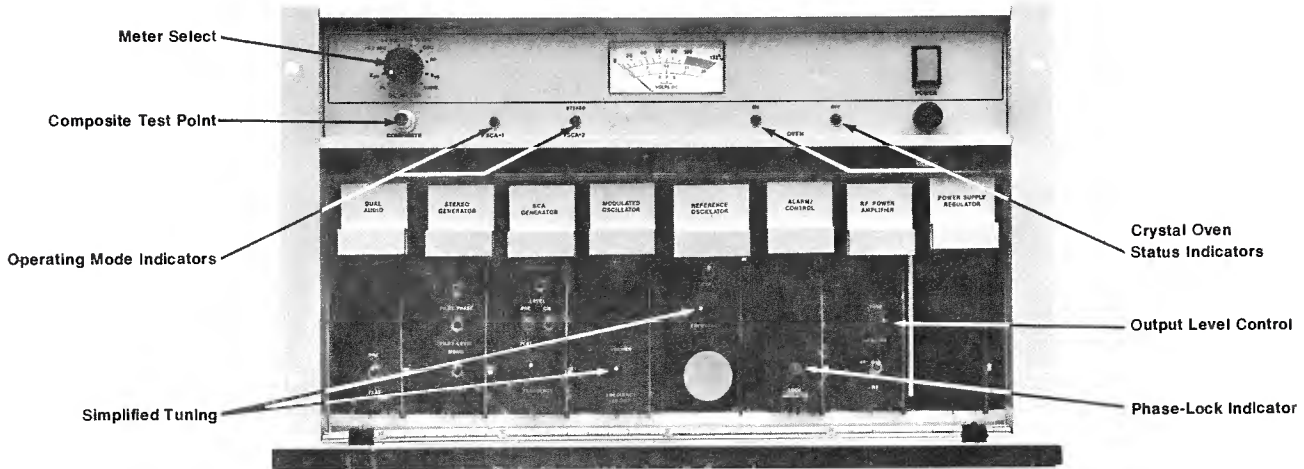

B-110 STEREO GENERATOR

B-113 SCA GENERATOR

The optional B-110 Stereo Generator operates in the B-910/B-910T in conjunction with a B-111 Stereo Audio Amplifier, and provides for the generation of the 19 kHz pilot and the composite stereo signals (L+R and L-R). The stereo generator utilizes a switching mode oscillator employing a temperature stabilized crystal at four times the 19 kHz pilot frequency (76 kHz). This 76 kHz signal is digitally divided to derive the 19 kHz pilot and the 38 kHz square wave signal used to alternately switch between the left and right channel audio signals. Circuitry is precisely designed to assure that 38 kHz subcarrier suppression is 55 dB below the modulated signal. The use of the square wave switching mode eliminates the need for troublesome carrier balance adjustments. This simplifies adjustment, and additionally provides for excellent stereo separation (35 dB through the entire exciter or transmitter). A 53 kHz low-pass filter is employed to assure that no objectionable harmonic content of the 19 kHz pilot exists. This assures that no interference will occur with a 67 kHz SCA channel.

Adjustments for the B-110 Stereo Generator are held to minimum with only Pilot Level and Pilot Phase (for setting proper timing of the pilot and L-R signal) provided on the front panel.

Local and remote stereo/mono mode switching is provided for, with front panel indication provided when in stereo operation, with provision for connection of a remote indicator.

The B-113 SCA Generator is optionally available to provide for a 67 kHz subchannel in an exciter equipped with a stereo generator. In a monaural exciter either a 67 kHz and/or a 41 kHz SCA Generator are optionally available (other frequencies 20-75 kHz are available on special order).

The B-113 is an ultrastable SCA generator utilizing direct FM modulation providing for a subcarrier frequency accuracy of ± 500 Hz. Manual or automatic SCA muting is provided and the mute circuitry is adjustable, both as to modulation level, and delay time which is continuously adjustable $\frac{1}{2}$ to 8 secs.

Unique to the B-113 is the ability to remotely disable the automatic mute. This circuit provides a ready means of obtaining the necessary signal when making measurements at the studio requiring an unmodulated SCA subcarrier.

B-113 SCA Generators are factory equipped for ± 6 kHz deviation with a 7.5 kHz input filter. For ± 4 kHz SCA deviation requirement a 5 kHz input filter is optionally available.

The B-113 also has provision to allow the SCA subcarrier to be switched on and off locally and remotely.

STANDARD SCA FILTER COMBINATIONS

SCA	INPUT FILTER		OUTPUT FILTER
	4 kHz • DEVIATION • 6kHz		
41 kHz	5 kHz	7.5 kHz	60 kHz LP
67 kHz monaural	5 kHz	7.5 kHz	90 kHz LP
67 kHz stereo	5 kHz	7.5 kHz	67 kHz BP

System Block Diagram of B-910/B-910T FM Exciter/10 Watt FM Transmitter

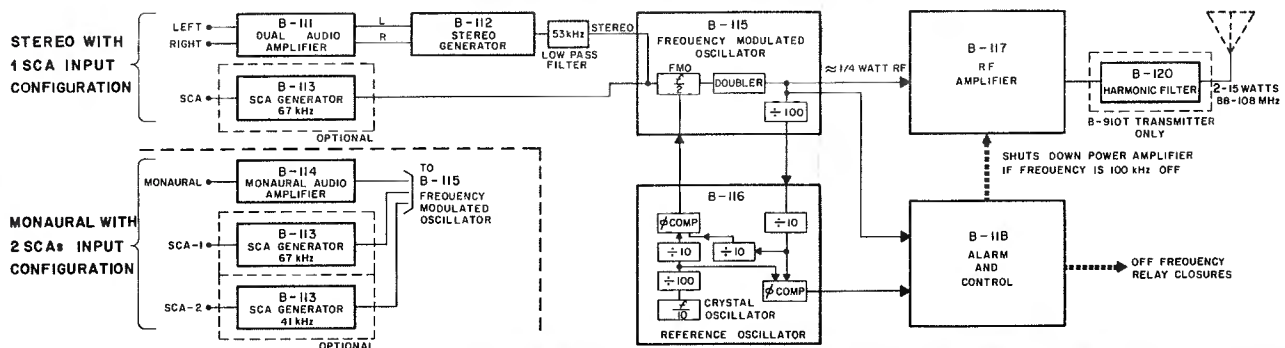

SPECIFICATIONS

B-910T 10-WATT FM TRANSMITTER

PERFORMANCE:

TYPE OF EMISSION.....	F3/F9
FREQUENCY RANGE.....	88-108 MHz
RF POWER OUTPUT.....	B-910 Exciter 2-15 watts continuously adjustable. B-910T 10-watt transmitter; 10 watts nominal
RF OUTPUT IMPEDANCE..... (Type BNC connector)	50 ohms, unbalanced
CARRIER FREQUENCY STABILITY.....	±500 Hz over rated temperature range
FREQUENCY DEVIATION FOR 100% MODULATION.....	±75 kHz
MODULATION CAPABILITY.....	±150 kHz
METHOD OF MODULATION.....	Direct FM
AUDIO INPUT IMPEDANCE.....	600 ohms balanced
AUDIO INPUT LEVEL.....	+10, ±2, dBm
AUDIO FREQUENCY RESPONSE.....	±0.5 dB 30-15,000 Hz
PRE-EMPHASIS NETWORK TIME CONSTANT.....	75 μ sec pre-emphasis, 50 μ sec avail
IM DISTORTION.....	0.2% or less 60 Hz/7 KHz, 4:1 ratio
TOTAL HARMONIC DISTORTION.....	less than 0.3%, 30-15,000 Hz
FM NOISE.....	68 dB or greater below 100% modulation at 400 Hz
AM NOISE.....	65 dB below carrier level
ELECTRICAL:	
POWER REQUIRED.....	100-135 (200-270) VAC 50/60 Hz
POWER CONSUMPTION..... (With Stereo and SCA Generator)	50 watts
AMBIENT TEMPERATURE.....	-20° to 50° C (-4° to 122° F)
MECHANICAL:	
DIMENSIONS.....	Rack Mount 10½" (26.7cm) High 19" (48.3cm) Wide 17¾" (45.1cm) Deep
	in B-122 cabinet 11¾" (29.8cm) High 20" (50.8cm) Wide 18" (45.7cm) Deep
WEIGHT.....	Rack Mount 25 lbs. (11.3kg) shipping weight 30 lbs. (13.6kg)
	in B-122 Cabinet 30 lbs. (13.6kg) shipping weight 35 lbs. (15.9kg)
FINISH.....	McMartin beige with wood grain trim front access panel

B-110 STEREO GENERATOR

PERFORMANCE:

PILOT CARRIER STABILITY.....	19 kHz ± 1 Hz over rated temperature range
SUBCARRIER SUPPRESSION.....	-55 dB or greater
AUDIO INPUT IMPEDANCE..... (Left and right channels into B-111 Stereo Audio Amplifier)	600 ohms balanced
AUDIO INPUT LEVEL..... (Left and right channels into B-111 Stereo Audio Amplifier)	+10, ±2, dBm
AUDIO FREQUENCY RESPONSE.....	±0.5 dB 30-15,000 Hz
PRE-EMPHASIS NETWORK TIME CONSTANT.....	75 μ sec pre-emphasis, 50 μ sec avail
IM DISTORTION.....	0.2% or less 60 Hz/7 KHz, 4:1 ratio
TOTAL HARMONIC DISTORTION.....	0.5% or less, 30-15,000 Hz
STEREO SEPARATION..... (50-15,000 Hz)	39 dB or greater through B-112 module 35 dB or greater through B-910/B-910T typically 50 dB or greater at mid range

FEB/77

CROSSTALK..... (main channel to sub channel and sub channel to main channel 30-15,000 Hz)	47 dB or greater, less 15 kHz LP filters; 50 dB (30-5,000 Hz); 45 dB (5-10 kHz); 40 dB (10-15 kHz); with filters.
FM NOISE.....	65 dB or greater below 100% modulation
REMOTE CAPABILITY.....	pilot on/off, pilot on indication
FILTERING PROVIDED.....	15 kHz input, 53 kHz low pass output

B-113 SCA GENERATOR

PERFORMANCE:

TYPE OF MODULATION.....	Direct FM
CARRIER FREQUENCY.....	67 kHz and 41 kHz standard (20 kHz to 75 kHz available)
FREQUENCY STABILITY.....	±500 Hz over rated temperature range
AUDIO INPUT IMPEDANCE.....	600 ohms balanced
AUDIO INPUT LEVEL.....	+10, ±2, dBm
AUDIO FREQUENCY RESPONSE.....	±1.5 dB, 50-5,000 Hz
TOTAL HARMONIC DISTORTION.....	less than 0.6% at 400 Hz (B-113 only) less than 0.75% 50-5,000 Hz (through B-910/B-910T Monaural 67 kHz SCA) less than 2.5% 50-5,000 Hz (through B-910/B-910T Stereo 67 kHz SCA)
CROSSTALK.....	60 dB or greater below normal program levels
MODULATION CAPABILITY.....	±7.5 kHz
PRE-EMPHASIS NETWORK TIME CONSTANT.....	150 μ sec standard, 75 μ sec or 50 μ sec available
AUTOMATIC MUTE.....	Adjustable to any level between 100% and 3% modulation
MUTE DELAY.....	0.5 sec to 8 sec (continuously adjustable)
FM NOISE.....	60 dB below 100% modulation (±6 kHz deviation) 150 μ sec de-emphasis
REMOTE CAPABILITY.....	SCA-on/off, Auto-Mute on/off
FILTERING PROVIDED:	
Monaural Exciter.....	7.5 kHz input, 90 kHz low pass output
Stereo Exciter.....	5 kHz input, 67 kHz band pass output
41 kHz units with Monaural.....	7.5 kHz input, 60 kHz low pass output Exciter

(Other filter combinations are available.)

All specifications for monaural, stereo and SCA operation are for the entire B-910/B-910T system and not just through a single part of the system.

ORDERING INFORMATION

B-910/910T FM Exciter units are available in the following configuration as original purchase options:

Monaural Operation:	B-910 Monaural FM Exciter (specify main channel frequency)
SCA Operation:	B-910 Monaural FM Exciter with single B-113 SCA Generator (specify main channel and SCA Frequencies) B-910 Monaural FM Exciter with two B-113 SCA Generators (specify main channel and SCA Frequencies)
Stereo Operation:	B-910 FM Exciter with B-110 Stereo Generator Assembly (specify main channel frequency)
Stereo/SCA Operation:	B-910 FM Exciter with B-110 Stereo and B-113 SCA Generator (specify main channel and SCA frequencies)
10-Watt FM Transmitter:	B-910T 10-Watt FM Transmitter (in B-122 cabinet) B-910T 10-Watt FM Transmitter (rack mount)

All B-910/B-910T monaural units may be field converted to stereo operation by adding B-110 Stereo Generator Assembly.

Add-On Options:	B-110 Stereo Generator Assembly Includes: B-111 Stereo Audio Amplifier (replaces B-114 Monaural Audio Amplifier) B-112 Stereo Generator
	B-113 SCA Generator (specify frequency 41 kHz and 67 kHz standard) (other frequencies 20-75 kHz available)

STEREO GENERATOR

B-110R

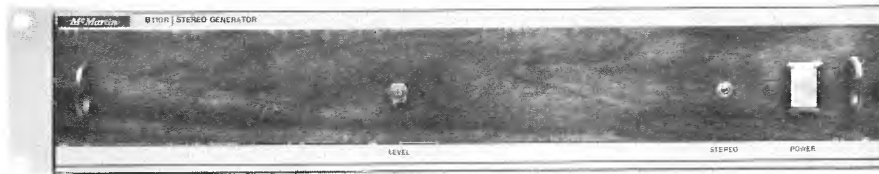

**BUILT-IN 15 KHZ LP FILTERS
SEPARATION—39 dB OR GREATER**

**3½" RACK MOUNT
SWITCHING METHOD SIGNAL GENERATION**

DESCRIPTION

The B-110R is a completely self-contained, rack-mount unit capable of generating a high-quality stereo composite signal. It is intended primarily for stereophonic mode broadcasting where the composite stereo signal originates at a studio location and aural STL equipment is used for relaying the program material to a remote transmitter site.

The B-110R includes local mono/stereo operating mode switching with provision for remote control.

Each channel includes built-in 15 kiloHertz low pass filtering.

Separate dual-audio and stereo generator plug-in modules are accessible from the front of the unit through a hinge-down panel.

SPECIFICATIONS

FREQUENCY RESPONSE	±0.5 dB, 30-15000 Hz
HARMONIC DISTORTION	0.5% or less, 30-15000 Hz
SEPARATION	39 dB or greater, 30-15000 Hz
CROSSTALK	50 dB, 30-15000 Hz 45 dB, 5-10 kHz 40 dB, 10-15 kHz
FM S/N RATIO	65 dB or greater
PREEMPHASIS	75 microseconds
PILOT STABILITY	±1.0 Hz over rated temperature range
19 KHZ SUPPRESSION	55 dB min.

AF INPUT IMPEDANCE	600 ohms, balanced (each channel)
AF INPUT LEVEL	+10, ±2 dBm
OUTPUT IMPEDANCE	600 ohms, unbalanced
OUTPUT LEVEL	0-2.5 volts, P/P
POWER REQUIRED	115/230 VAC, 50/60 Hz
OPERATING TEMPERATURE	-20° to 50° C
DIMENSIONS	EIA standard rack mount 19" (48.3 cm) wide 3½" (8.9 cm) high 15½" (39.4 cm) deep

MAR/75

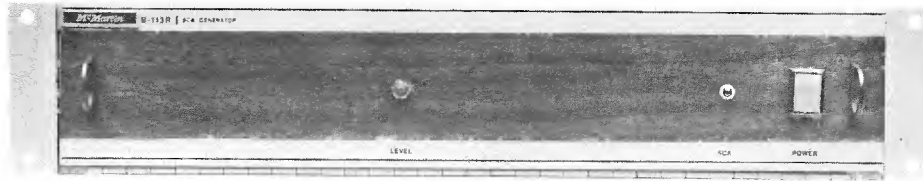

AUTOMATIC MUTING
VARIABLE MUTE DELAY

RACK MOUNT, SELF-CONTAINED
INTEGRAL INPUT/OUTPUT FILTERS

DESCRIPTION

The B-113R SCA Generator is a completely self-contained unit designed for the generation of high quality subchannel information for use in FM broadcast SCA applications.

The B-113 is available with input/output filter combinations to insure optimum compatibility with either monaural or stereophonic main channel operation.

Electronic muting, adjustable to respond to levels from 3 to 100% modulation and muting delay from 1/2 to 5 seconds are featured.

Local/remote switching is provided with front panel level control.

The B-113R is designed for rack mounting with access to the generator plug-in module by means of a hinge-down front panel.

SPECIFICATIONS

CARRIER FREQUENCY41 or 67 kHz standard other frequencies on special order
CARRIER STABILITY±500 Hz
AF RESPONSE±1.5 dB, 50-5000 Hz
DISTORTION0.75% maximum, 50-5000 Hz (LP output filter) 2.5% maximum, 50-5000 Hz (BP output filter)
AF INPUT LEVEL+10, ±2 dBm
AF INPUT IMPEDANCE600 ohms, balanced
OUTPUT LEVEL0-10V P/P, adjustable
PREEMPHASIS150 microseconds (50 or 75 microseconds special order)
MODULATION CAPABILITY±12% of subchannel carrier frequency

S/N RATIO60 dB or greater
MUTE DELAY0.5 to 5.0 seconds
OPERATING TEMPERATURE-20° to +50°C
POWER REQUIRED115/230 Vac, 50/60 Hz
DIMENSIONSEIA standard rack mount 19" (48.3 cm) wide 3½" (8.9 cm) high 15½" (39.4 cm) deep

ORDERING INFORMATION

MODEL	INPUT FILTER	OUTPUT FILTER	MAIN CHANNEL MODE
B-113R/5/41	5 kHz LP	41 kHz LP	Mono
B-113R/7/41	7.5 kHz LP	41 kHz LP	Mono
B-113R/5/67	5 kHz LP	67 kHz LP	Mono
B-113R/7/67	7.5 kHz LP	67 kHz LP	Mono
B-113R/5/67B	5 kHz LP	67 kHz BP	Stereo

50 WATT FM TRANSMITTER

B-950T

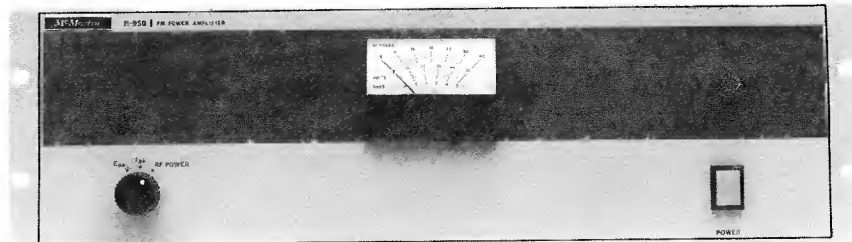

SINGLE TRANSISTOR

INCLUDES B-910 FM EXCITER

AVAILABLE MONO OR STEREO WITH OR WITHOUT SCA

FULL METERING

DESCRIPTION

The McMartin B-950T 50 Watt FM transmitter consists of a B-910 FM exciter with accompanying 50 watt solid-state power amplifier. The 50 watt power amplifier utilizes a single high reliability solid state RF power transistor and easily achieves the required 50 watts of output power when driven by the 10-watt exciter.

The B-950T by using a single stage solid-state power amplifier reduces power supply requirements. A single +28 volt dc supply is utilized. The B-950T is highly efficient. Designed for 70-watt output capability, the B-950T operates very conservatively at its rated 50-watt output level.

Front panel metering on the B-950T power amplifier displays power supply voltage PA collector current and RF power output indication. No tuning controls are required or necessary for the power amplifier is drive limited and broadbanded. All tuning and power control is accomplished in the B-910 FM exciter portion.

The B-950T occupies 15¾ inches of rack space, 10½ inches for the B-910 FM exciter, 5¼ inches for the 50 watt power amplifier.

The power transistor requires no VSWR protection. It is capable of sustaining either open or direct short circuit conditions.

The B-950T includes an internally mounted harmonic filter with a female type N output RF connector (types BNC or UHF available as alternate options).

The B-950T system performance specifications are the same as those for the B-910T 10-Watt FM transmitter, differing only in power consumption.

The B-950 is optionally available without the B-910 FM exciter as a separate FM power amplifier.

JAN/77

MC MARTIN B-9100T TRANSMITTER

FULLY METERED

100 WATTS OUTPUT

DUAL POWER AMPLIFIERS COMBINED

COMPLETELY SOLID STATE

25% POWER MAINTAINED IF ONE POWER AMP FAILS

The McMartin B-9100 is a 100 watt FM power amplifier designed to be coupled with a ten watt exciter to produce a 100 watt FM transmitter. The B-9100 is available with a McMartin B-910, 10 watt exciter, and is then designated "McMartin B-9100T, complete 100 watt transmitter."

The B-9100T provides a 100 watt FM broadcast signal in the 88 to 108 MHz frequency range, and is well-suited to low power broadcast applications and as an emergency standby transmitter for higher powered FM stations.

The B-9100 consists of a basic 100 watt FM power amplifier and internal harmonic filter, and may be used in conjunction with any FM exciter capable of 5 watts output. The unit is designed for standard 19" rack

mounting. The antenna is connected directly to the output jack.

The B-9100 features a completed, solid-state two stage amplifier in which the driver output is coaxially split and used to drive two 50 watt amplifiers, which in turn are coaxially combined by a Hybrid combiner. A resistive reject load is used to absorb excess RF power if one of the final amplifiers should fail. In this situation, one quarter power, i.e. 25 watts, will appear at the antenna terminal.

The use of redundant RF amplifiers provides unusual reliability in a low powered unit, making it an excellent choice for remotely located low power broadcast installations and for use in emergency standby applications.

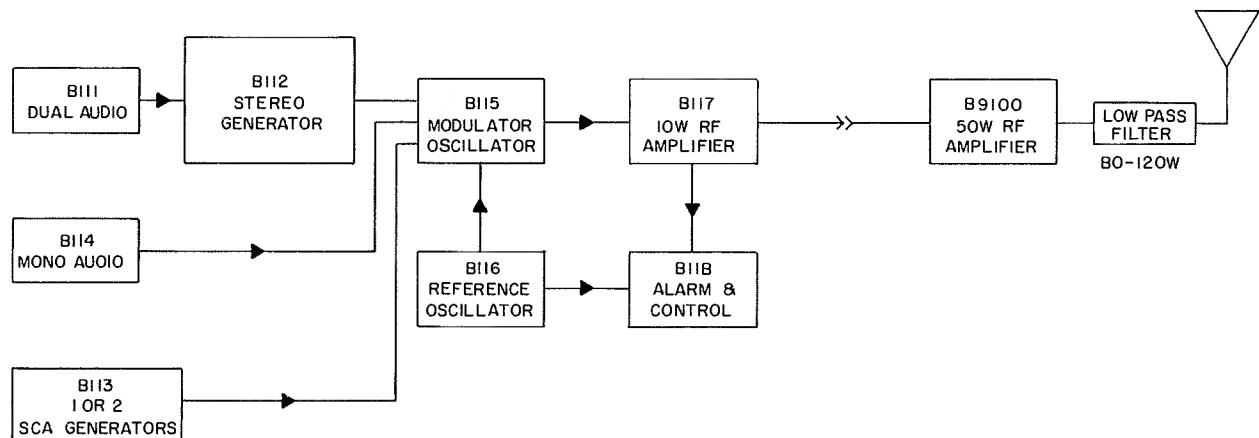

Block Diagram of B-9100T

SPECIFICATIONS

PERFORMANCE:

Type of Emission	F3/F9
Frequency Range	88-108 MHz
RF Power Output	50 watts
RF Output Impedance	50 ohms, unbalanced
Carrier Frequency Stability	±500 Hz over rated temperature range
Frequency Deviation for 100% Modulation ..	±75 kHz
Modulation Capability	±150 kHz
Method of Modulation	Direct FM
Audio Input Impedance	600 ohms balanced
Audio Input Level	+10, ±2, dBm
Audio Frequency Response	±0.5 dB 30-15,000 Hz

Pre-emphasis Network Time Constant	75 u-sec pre-emphasis
Total Harmonic Distortion	less than 0.3%, 30-15,000 Hz
FM Noise	65 dB or greater below 100% modulation at 400 Hz
AM Noise	60 dB below carrier level

ELECTRICAL:

Power Required	100-135 (200-270) Vac 50/60 Hz
Power Consumption	120 watts
Ambient Temperature	-20° to 50° C (-4° to 122°F)

MECHANICAL:

Dimensions	Rack Mount 15¾" (40 cm) H 19" (48.3 cm) W 17¾" (45.1 cm) D
Cabinet	19" (48.3 cm) H 20" (50.8 cm) W 22" (55.9 cm) D
Finish	McMartin beige with wood grain trim front access panel

100 WATT FM TRANSMITTER

B-9100T

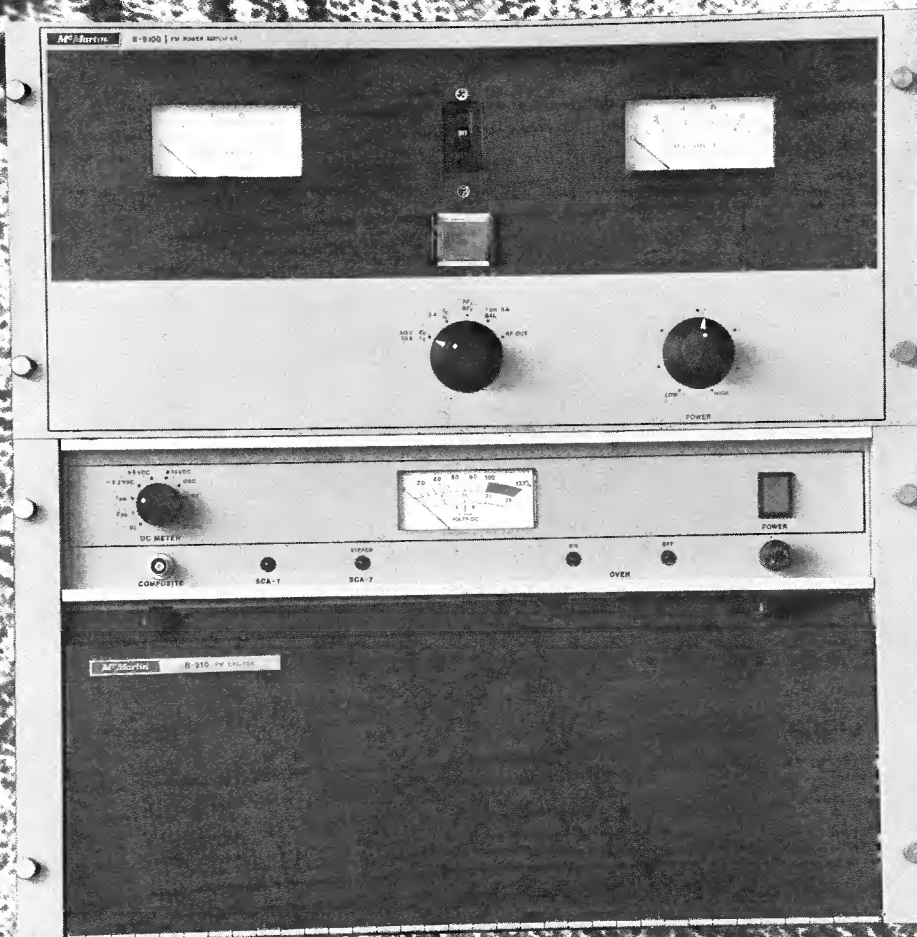

MCMARTIN

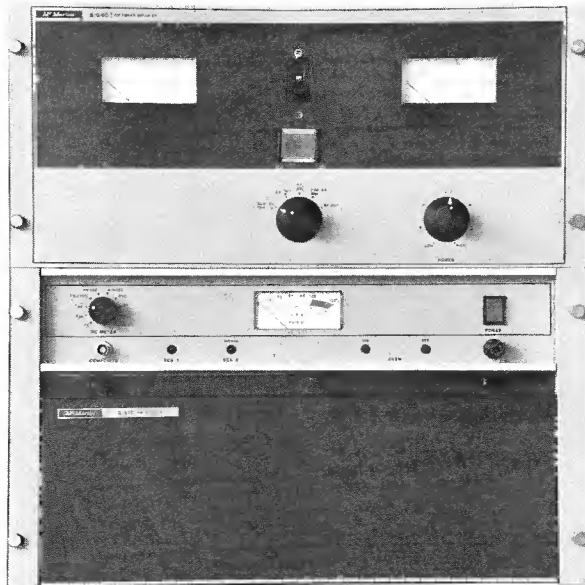

Front View of B-9100T

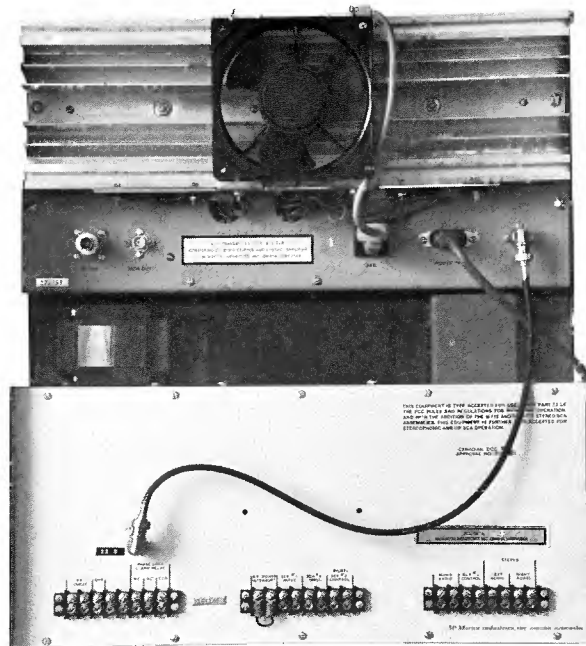

Rear View of B-9100T

B-110 STEREO GENERATOR

The optional B-110 Stereo Generator operates in the B-9100/9100T in conjunction with a B-111 Stereo Audio Amplifier, and provides for the generation of the 19 kHz pilot and the composite stereo signals (L+R and L-R). The stereo generator utilizes a switching mode oscillator employing a temperature stabilized crystal at four times the 19 kHz pilot frequency (76 kHz). This 76 kHz signal is digitally divided to derive the 19 kHz pilot and the 38 kHz square wave signal used to alternately switch between the left and right channel audio signals. Circuitry is precisely designed to assure that 38 kHz subcarrier suppression is 55 dB below the modulated signal. The use of the square wave switching mode eliminates the need for troublesome carrier balance adjustments. This simplifies adjustment, and additionally provides for excellent stereo separation (35 dB through the entire exciter or transmitter). A 53 kHz low-pass filter is employed to assure that no objectionable harmonic content of the 19 kHz pilot exists. This assures that no interference will occur with a 67 kHz SCA channel.

Adjustments for the B-110 Stereo Generator are held to minimum with only Pilot Level and Pilot Phase (for setting proper timing of the pilot and L-R signal) provided on the front panel.

Local and remote stereo/mono mode switching is provided for, with front panel indication provided when in stereo operation, with provision for connection of a remote indicator.

B-113 SCA GENERATOR

The B-113 SCA Generator is optionally available to provide a 67 kHz subchannel in an exciter equipped with a stereo generator. In a monaural exciter a 67 kHz and/or a 41 kHz SCA Generator are available (other frequencies, 20-75 kHz are available on special order).

The B-113 is an ultrastable SCA generator utilizing direct FM modulation providing subcarrier frequency accuracy of ± 500 Hz. Manual or automatic SCA muting is provided and the mute circuitry is adjustable, both modulation level and delay time (which is continuously adjustable $\frac{1}{2}$ to 8 secs).

Unique to the B-113 is the ability to remotely disable the automatic mute. This circuit provides a ready means of obtaining the necessary signal when making measurements at the studio requiring an unmodulated SCA subcarrier.

B-113 SCA Generators are factory equipped for ± 6 kHz deviation with a 7.5 kHz input filter. For ± 4 kHz SCA deviation requirement a 5 kHz input filter is optionally available.

The B-113 also has provision to allow the SCA subcarrier to be switched on and off locally and remotely.

STANDARD SCA FILTER COMBINATIONS			
SCA	INPUT FILTER 4 kHz • DEVIATION • 6kHz		OUTPUT FILTER
41 kHz	5 kHz	7.5 kHz	60 kHz LP
67 kHz monaural	5 kHz	7.5 kHz	90 kHz LP
67 kHz stereo	5 kHz	7.5 kHz	67 kHz BP

SPECIFICATIONS

PERFORMANCE:

Type of Emission F3/F9
 Frequency Range88-108 MHz
 RF Power Output80-120 watts
 RF Output Impedance50 ohms, unbalanced

Carrier Frequency Stability ±500 Hz over rated temperature range
 Frequency Deviation for 100% Modulation ±75 kHz
 Modulation Capability ±150 kHz
 Method of Modulation Direct FM
 Audio Input Impedance600 ohms balanced
 Audio Input Level +10, ±2 dBm
 Audio Frequency Response ±0.5 dB 30-15,000 Hz
 Pre-Emphasis Network Time Constant75 μ sec pre-emphasis, 50 μ sec avail.
 IM Distortion0.2% or less 60 Hz/7KHz, 4:1 ratio
 Total Harmonic Distortion less than 0.3% 30-15,000 Hz
 FM Noise65 dB or greater below 100% modulation at 400 Hz
 AM Noise65 dB below carrier level

ELECTRICAL:

Power Required100-135 (200-270), VAC 50/60 Hz
 Power Consumption (With Stereo and SCA Generator)270 watts
 Ambient Temperature -20° to 50°C (-4° to 122°F)

DIMENSIONS

B-9100 Amplifier19¼" (48.90 cm) High
 19" (48.30 cm) Wide
8¾" (22.23 cm) High
 19" (48.30 cm) Wide
 14½" (36.83 cm) Depth
 B-910 Exciter10½" (26.67 cm) High
 19" (48.30 cm) Wide
 17¾" (45.09 cm) Depth

FINISH

..... McMartin beige with wood grain trim front access panel

OUTPUT CONNECTOR REQUIRED

..... PL 259

B-9100T with B-110 STEREO GENERATOR

PERFORMANCE:

Pilot Carrier Stability19 kHz ±1Hz over rated temperature range
 Subcarrier Suppression -55 dB or greater
 Audio Input Impedance (Left and right channels into B-111 Stereo Audio Amplifier)600 ohms balanced
 Audio Input Level (Left and right channels into B-111 Stereo Audio Amplifier) +10, ±2 dBm

Audio Frequency Response

..... ±0.5 dB 30-15,000 Hz
Pre-Emphasis Network Time Constant75 μ sec pre-emphasis, 50 μ sec avail.
IM Distortion0.2% or less 60 Hz/7 kHz, 4:1 ratio
Total Harmonic Distortion0.5% or less, 30-15,000 Hz
Stereo Separation (50-15,000 Hz)39 dB or greater through B-112 module. 35 dB or greater. B-9100T typically 50 dB or greater at mid range.
Crosstalk (main channel to sub channel and sub channel to main channel 30-15,000 Hz)40 dB or greater
FM Noise65 dB or greater below 100% modulation
Remote Capability pilot on/off, pilot on indication
Filtering Provided15 kHz input, 53 kHz low pass output

B-9100T with B-113 SCA GENERATOR

PERFORMANCE:

Type of Modulation Direct FM
 Carrier Frequency67 kHz and 41 kHz standard (20 kHz to 75 kHz available)
 Frequency Stability ±500 Hz over rated temperature range
 Audio Input Impedance600 ohms balanced
 Audio Input Level +10, ±2 dBm
 Audio Frequency Response ±1.5 dB, 50-5,000 Hz
 Total Harmonic Distortion Mono less than 0.6% at 400 Hz (B-113 only)
 Stereo less than 0.75%, 50-5,000 Hz
 Stereo less than 2.5%, 50-5,000 Hz
 Crosstalk (main channel to SCA and SCA to main channel)60 dB or greater below normal program levels
 Modulation Capability ±7.5 kHz
 Pre-Emphasis Network Time Constant150 μ sec standard, 75 μ sec or 50 μ sec available
 Automatic Mute Adjustable to any level between 100% and 3% modulation
 Mute Delay 0.5 sec to 8 sec (continuously adjustable)
 FM Noise60 dB below 100% modulation (±6 kHz deviation)
 150 μ sec de-emphasis
 Remote Capability SCA-on/off, Auto-Mute on/off
 Filtering Provided Monaural Exciter7.5 kHz input, 90 kHz low pass output
 Stereo Exciter5 kHz input, 67 kHz band pass output
 41 kHz units with Monaural Exciter7.5 kHz input, 60 kHz low pass output

(Other filter combinations are available.)

All specifications for monaural, stereo and SCA operation are for the entire B-9100T.

ORDERING INFORMATION

MODEL	DESCRIPTION	PRODUCT CODE
B-9100T	Transmitter, 100 watt, Rack mount	10-01-020
B-9100	100 watt amplifier only	10-01-002
B-110	Stereo generator, plug-in for B-9100T	10-01-004
B-113	SCA generator, plug-in for B-9100T	10-01-007

AM RF AMPLIFIER

RF-85B

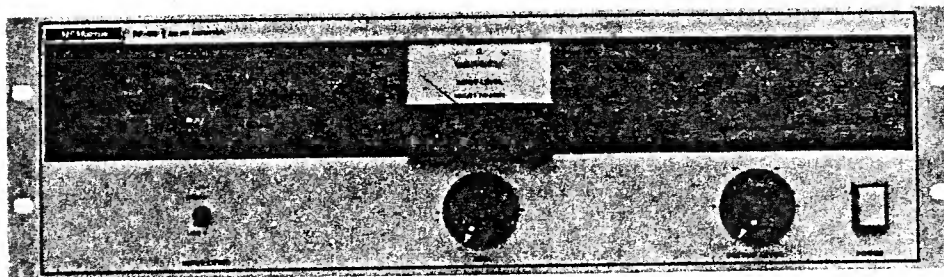

MINIMUM ENVELOPE DISTORTION
AUTOMATIC GAIN CONTROL
REMOTE/LOCAL POWER CHANGE SWITCHING

1.0 MILLIVOLT SENSITIVITY
CARRIER FAILURE ALARM
MOD/FREQ MONITOR OUTPUT

DESCRIPTION

The McMartin Model RF-85B AM RF amplifier is intended for off-air operation of FCC Type Approved AM modulation/frequency monitors.

Special attention has been placed on amplifying the incoming signal with minimum disturbance of the modulation envelope. This includes consideration of providing adequate reserve amplification to accommodate signals with positive modulation peaks in excess of 100%.

The RF-85B uses Class A amplification through the modulation monitor drive circuitry. The frequency monitor output is heavily limited to strip the modula-

tion and produces an approximately square wave output.

The AGC is effective over a 30 dB input signal range and maintains the output level within 0.5 dB for this wide variation in input level.

A high-low panel switch, remotable through an external contact closure, accommodates dual power situations. The RF-85B is equipped with a carrier-failure relay which operates on carrier interruptions of one second or longer duration. The relay contacts are terminated for connection of external visual or aural alerting devices.

SPECIFICATIONS

FREQUENCY RANGE:540-1600 kHz

INPUT SENSITIVITY:1.0 millivolts, minimum

INPUT IMPEDANCE:50 ohms unbalanced, nominal

SELECTIVITY:down 1.0 dB or less, ± 10 kHz
down 40.0 dB or greater, ± 40 kHz

S/N RATIO:50 dB or greater below 100% modulation (with 1.0 millivolt input signal)

AGC RANGE: 30 dB variation in input level produces less than 0.5 dB output level change

OUTPUTS

Modulation Monitor: ...0 to 0.5 watts, unmodulated carrier, 50 ohms

Frequency Monitor: ...5 volts, peak-to-peak, square wave, 1K-ohm

TEMPERATURE

RANGE:0° to 50° Celsius

REAR CHASSIS

TERMINATIONS:1. Input (BNC)
2. Mod. Mon. out (BNC)
3. Freq. Mon. out (BNC)
4. Carrier failure alarm
5. Remote power level switching

POWER REQUIRED:117 Vac, 50/60 Hz

DIMENSIONS:EIA standard rack,
19" (48.3 cm) width
5¼" (13.3 cm) height
10" (25.5 cm) depth

WEIGHT:10 pounds

FINISH: McMartin Beige with woodgrain trim

MAR/75

AM/FM FIXED-FREQUENCY TUNERS

single channel **AMR-1**

five channel **FMR-5**

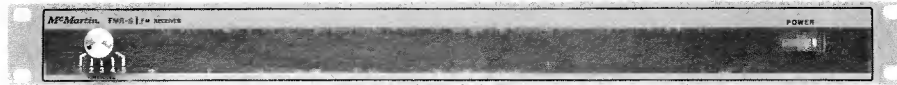

The McMartin AMR-1 and FMR-5 are low cost, high performance, AM or FM broadcast tuners. The AMR-1 is a single channel AM tuner and the FMR-5, a five-channel FM tuner. These professional tuners insure high-reliability, fixed-frequency signal sources for use with sound distribution systems and they are ideally suited for EBS receivers as well.

The AMR-1 contains a MOSFET RF amplifier and a monolithic silicon integrated circuit from which the mixer, low-drift tunable oscillator, 445 kHz IF amplifier, and AGC detector are constructed.

The RF amplifier stages of the FMR-5 uses a dual-gate diode-protected MOSFET in conjunction with four high-Q tuned circuits, resulting in minimum cross-modulation and overload effects. AGC over a 30 dB range is applied to the input MOSFET device.

The FMR-5 provides for 5 crystal-controlled channels. Selectivity is established by a 4-pole 10.7 MHz IF filter. A monolithic silicon IC, featuring three stages of amplification/limiting; a doubly-balanced quadrature detector; delayed AGC voltage output; and audio pre-amplification is used.

Each model delivers rear chassis termination of both 0 dBm, 600 Ω balanced, and 1.0 volt unbalanced audio output.

Each model occupies 1 $\frac{3}{4}$ " of vertical space. An illuminated front panel power switch is provided.

SPECIFICATIONS

	AMR-1	FMR-5
FREQUENCY RANGE (specify operating frequency)	540-1620 kHz	88-108 MHz
ANTENNA INPUT (BNC type conn.)	75 ohms	50/75 ohms
SENSITIVITY	30 μ V/20 dB S/N @ 30% mod.	2.0 μ V/30 dB quieting
SELECTIVITY	6 dB point: \pm 10 kHz	3 dB point: 280 kHz 50 dB point: 950 kHz
HARMONIC DISTORTION	3.0% or less @ 90% mod.	0.75% or less
S/N RATIO	45 dB below 100% mod. w/10 mV input	60 dB below 100% mod. w/full limiting
AF RESPONSE	\pm 1.0 dB, 50-5000 Hz; \pm 3.0 dB 5-10 kHz	\pm 1.0 dB, 30-15000 Hz
AUDIO OUTPUTS	0 dBm, 600 ohms bal., and 1.0 V, 600 ohms unbal.	
POWER REQUIRED ..	120 Vac, 50/60 Hz, 6 watts	
DIMENSIONS 1.9" (48.3 cm) width 1 $\frac{3}{4}$ " (4.45 cm) height 6" (12.7 cm) depth	
REAR CHASSIS TERMINATIONS	Antenna (BNC); Balanced audio out; unbal. audio out; Relay contacts (n.o.)	
FINISH McMartin beige with woodgrain trim	
ORDERING INFORMATION		
AMR-1	AM Monitor Receiver	10-04-003
FMR-5	FM Monitor Receiver	10-04-006
FMR-XTAL	Crystal for FMR-5	





NEW PTD (PRECISE TRACKING DECODER)

IMPROVED SENSITIVITY

50db LINEAR AGC

BALANCED 600 OHM OUTPUT (+8dbm)

ADJUSTABLE NOISE SQUELCH CONTROL

REAR PANEL RELAY CONTACTS (NO) OR (NC)

The McMartin FMR-1D is a low cost, high performance, crystal controlled broadcast tuner. This tuner insures high reliability, high quality audio signal for station or studio monitoring or for use in sound distribution systems.

The RF front end of the FMR-1D is crystal controlled and utilizes a diode protected dual gate D-MOS (FET) field effect RF amplifier and a dual gate MOS-FET mixer. The D-MOS (FET) provides greater than 50db linear AGC control resulting in an overall tuner dynamic range of over 100db with minimum cross modulation. The AGC does not produce any skewing or detuning of the high "Q" RF tuned circuits.

The FMR-1D utilizes a new concept in tuner design providing space age technology in which the tuner actually tracks the modulated signal from the transmitter. The PTD will "lock on" and accurately recover the main channel signal identical to those originally transmitted. No multisection LC filters are used to disturb the original phase relationship of the transmitted signal reducing distortion. This system also tracks the original signal and reduces the effects of multipath.

An entirely new IF system has been designed eliminating the multisection 10.7 MHz IF band-pass filter. The

system has been encapsulated within a specially designed hybrid chip. The FMR-1D provides better selectivity to reject unwanted signals and still provide high quality audio signals. Provisions are provided for the addition of an optional filter for exceptional high selectivity.

A specially designed mute circuit is incorporated in the chip to provide noise free muting and is a function of RF noise rather than RF input level. A relay circuit will provide either contact closure or open contacts in the absence of an RF carrier. The relay threshold is also adjustable from 3-15 microvolts.

An audio (1C) integrated circuit is used to drive a transformer providing a balanced 600 ohm output at a level of +8dbm at 100% modulation @ 400 Hz. A 15 kHz low-pass filter is used to eliminate the troublesome 19 kHz stereo pilot signal from the audio output when used for rebroadcast or recording.

The number of components have been greatly reduced due to the use of the hybrid chip IF system. 1C's are also used in the audio system; fewer components means greater reliability.

The FMR-1D utilizes only 1 3/4" of vertical rack space. An illuminated front panel power switch is provided.

McMartin

EBS TWO-TONE MONITOR

EBS-2

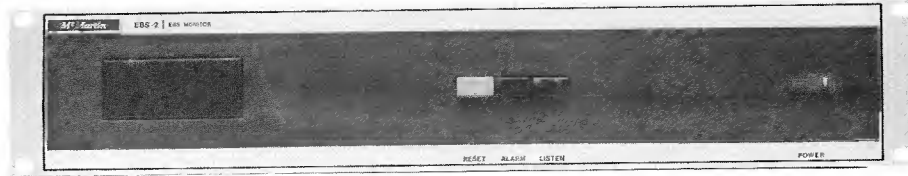

STABLE ± 3 Hz RESPONSE

DUAL RECEIVER INPUTS

STRAIGHT-FORWARD OPERATION

MONITORS NEW 2-TONE EBS SYSTEM

EXTERNAL ALARM CIRCUITRY

REMOTE RESET CAPABILITY

DESCRIPTION

The McMartin Model EBS-2, EBS Monitor is FCC certified and satisfies the need for a reliable, trouble-free method of monitoring the new two-tone Emergency Broadcast Service (EBS). In use, its operation is simple and readily understood by non-technical personnel.

The EBS-2 requires an audio input level of 300 millivolts to 6.0 volts, rms. It is designed primarily for use with the McMartin FMR-1 (FM) or AMR-1 (AM) fixed frequency receivers. Since the EBS-2 contains its own power supply, it may be used with other receiving equipment which can provide proper audio output level. Two EBS receivers may be connected simultaneously to the EBS-2 audio input.

By using precision tuning-fork techniques, the EBS-2 responds only to the two designated EBS tones of precise frequency tolerances. For example, the transmitted audio tone frequencies are 853 and 960 Hertz, plus or minus 0.5 Hertz.

When the proper tones are transmitted and received on the AMR-1 or FMR-1 the EBS-2 decodes the information and automatically switches the transmitted EBS message to its loudspeaker output. The EBS-2 has three front-panel pushbutton switches. Interlocked LISTEN/OPERATE switches and a momentary RESET switch. When the OPERATE switch is depressed, the EBS-2 is in its normal, muted, operating condition.

Depressing the LISTEN button by-passes the automatic speaker muting for checking purposes. After an EBS transmission has been received, depressing the RESET momentary switch restores the unit to its normal operating condition.

Audio output level from the loudspeaker is preset by an internal control to avoid loss of speaker output due to tampering or inadvertent misadjustment. Provision is made for the connection of external alarm devices and for remote reset of the EBS-2.

SPECIFICATIONS

AUDIO

tone condition:

Response	853 and 960 Hz, ± 3 Hz
Input level range ...	300 millivolts to 6.0 volts, rms
Response Time	8-16 seconds (factory adjusted for 12 secs.)

FRONT

PANEL CONTROLS:

- Interlocked LISTEN/OPERATE;
- Momentary RESET;
- Power on/off, illuminated.

REAR CONNECTIONS: Rear chassis screw terminals

- (1) receiver input #1
- (2) receiver input #2
- (3) ext. alarm relay closure

REAR CONNECTIONS (cont)

(4)	remote reset
(5)	ext. speaker

POWER REQUIRED:

- 120 Vac, 50/60 Hz,
- 6 watts

DIMENSIONS:

- EIA standard rack 19" (48.3 cm) width
- 3½" (8.9 cm) height
- 6" (15.3 cm) depth

FRONT PANEL FINISH:

- McMartin beige with woodgrain trim

SEPT/75

PRECISION TWO-TONE EBS GENERATOR

TG2/EBS

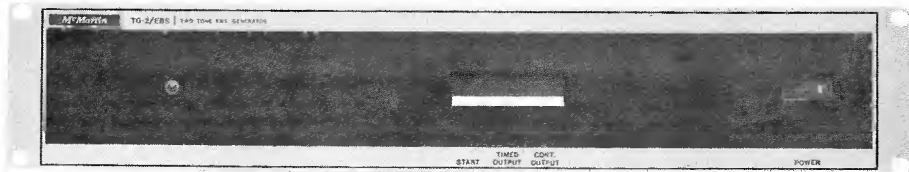

MANUAL OR AUTO TIMING

INDEPENDENT TONE LEVEL CONTROLS

CRYSTAL-DERIVED TONE BASE

REMOTE START

DESCRIPTION

The McMartin Model TG-2/EBS Precision Two Tone EBS Generator is FCC Type-Accepted to produce the Two-Tone Attention Signal for the new Emergency Broadcast System (EBS) effective for all AM, FM and TV stations on April 16, 1976.

The regulations specify the two tone frequencies as 853 and 960, ± 0.5 , Hertz. This stability is provided in the TG-2/EBS by digital logic division from a highly-stable crystal oscillator. The derived audio tones are filtered and combined, with individual level controls to produce a minimum +8 dBm, balanced 600-ohm output for feeding the two-tone information through normal program channels.

The individual tone level controls permit presetting of the output level to meet the 40%, $\pm 5\%$ modula-

tion requirement of the new rules.

The TG-2/EBS also incorporates an automatic duration timing device. The two tones may be initiated either by manual operation of a front panel CONTINUOUS OUTPUT pushbutton, or may be preset by a TIMED OUTPUT pushbutton switch with automatic transmission of 22 seconds duration by operation of a momentary-action front panel START pushbutton. The latter operation may also be initiated remotely. A front panel LED indicator shows the presence of tones.

The TG-2/EBS includes a self-contained power supply and regulator. It is finished in beige with woodgrain trim.

SPECIFICATIONS

OUTPUT FREQUENCIES: 853 and 960 Hertz

FREQUENCY STABILITY: ± 0.2 Hertz

OUTPUT LEVEL: +8 dBm min (each tone level independently adjustable)

OUTPUT IMPEDANCE: 600 ohms, balanced

HUM & NOISE: 65 dB below +8 dBm output

DISTORTION: less than 1.5%

TIMED OUTPUT DURATION: 22.5, ± 2.5 seconds

DIMENSIONS: EIA Standard rack mount
19" (48.3 cm) width
3 1/2" (8.9 cm) height
6" (15.3 cm) depth

FINISH: McMartin beige with woodgrain trim

SEPT/75

FM FREQUENCY/MODULATION MONITOR

TBM-3700

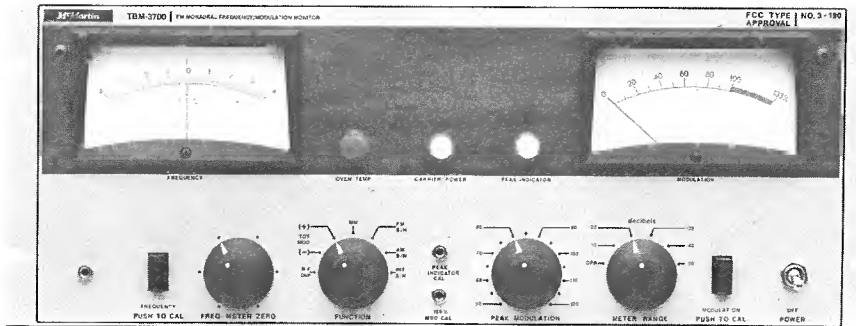

DIRECT READING AM & FM S/N
REAR ACCESS PLUG-IN CARDS
REMOTE METERING AVAILABLE

INDEPENDENT FREQUENCY/MODULATION SECTIONS
BUILT-IN FREQUENCY/MODULATION CALIBRATION
STEREO/SCA ADD-ON CAPABILITY

DESCRIPTION

The McMartin TBM-3700 combines the frequency deviation and modulation percentage functions in a single rack mount unit.

The TBM-3700 uses silicon solid-state semiconductors. Most circuits are mounted on plug-in, glass epoxy base printed circuit boards accessible from the rear.

The frequency deviation and modulation monitoring functions are independent of each other. Frequency measurements and calibration switching may be performed without interruption of the modulation monitoring or audio feed to house monitor systems. Audio output is automatically muted when RF feed to the TBM-3700 is not present.

The TBM-3700 incorporates circuitry permitting precise calibration of the modulation percentage meter and measurement of inherent internal FM noise of the monitor (typically -75 dB below 100% modulation). Direct reading of AM and FM signal-to-noise ratios is also featured.

Provision is made for remote metering of both frequency deviation and modulation percentage. Accessory kits for this purpose are available.

Two isolated composite signal outputs are provided for driving the McMartin TBM-2200 Stereo Modulation Monitor and/or TBM-2000A SCA Frequency/Modulation Monitor.

The TBM-3700 conforms in all respects with FCC Rules (Approval #3-190).

MAY/78

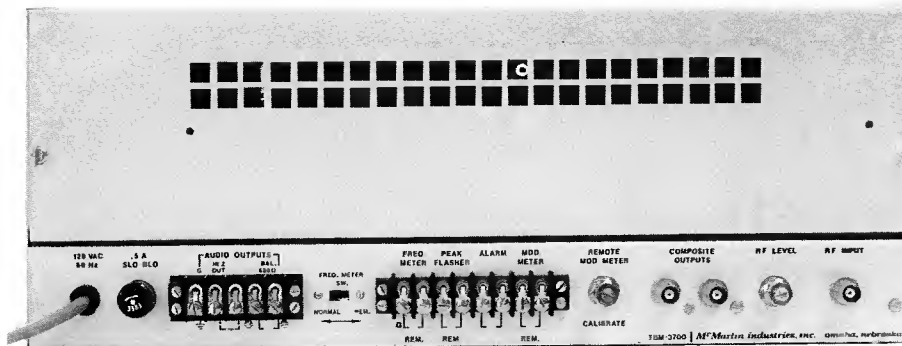

Rear view of TBM-3700

SPECIFICATIONS

OPERATING RANGE 88-108 MHz

INPUT 50 ohms, unbal. 0.1 to 1.0 W. level

OUTPUTS:

Audio monitoring . 600 ohms balanced; +2dBm (100% modulation-400Hz) Distortion: less than 0.5% (50-15,000 Hz)

Distortion measurement ... 10K ohms impedance, unbalanced; 5 volts (100% modulation @ 400 Hz) Distortion: 0.25% (30-15,000 Hz) SNR: 66dB below 100% modulation @ 400 Hz

Composite output . Two rear chassis BNC connectors—300 ohms unbalanced; 1.0 volt peak-to-peak ± 0.2 dB (50-100,000 Hz)

MODULATION METER:

Main channel position Accuracy, ± 0.5 dB; Freq. Response: ± 0.5 dB (30-15,000 Hz)

Total modulation position Accuracy, ± 0.5 dB; Freq. Response: ± 0.5 dB (30-75,000 Hz)

Range ± 75 kHz deviation, 100% modulation; ± 100 kHz deviation, 133% modulation (full scale)

FREQUENCY METER:

Scale ± 4 kHz, 100Hz increments

Accuracy Better than ± 500 Hz

REMOTE METERING:

Modulation up to 2,500 ohms external loop resistance may be accommodated. Requires RM-37T accessory plug-in card and RM-37-R remote meter panel kit

Frequency can accommodate up to 3,000 ohms external loop resistance. Remote meter panel kit available

CARRIER ALARM ... Monitor automatically mutes at preset muting control level. Rear panel terminals available for external alarm interconnection

POWER REQUIRED 105-125 VAC, 50/60 Hz, 45W

AMBIENT TEMPERATURE RANGE 10° to 50° C

DIMENSIONS 19" width (EIA) standard rack mount) 7" height, 13" depth

FINISH Beige with wood grain trim

ORDERING INFORMATION

MODEL	DESCRIPTION	PRODUCT CODE
TBM-3700	Frequency and monaural modulation monitor	10-03-049

STEREO MODULATION/FREQUENCY MONITOR

TBM-2200A

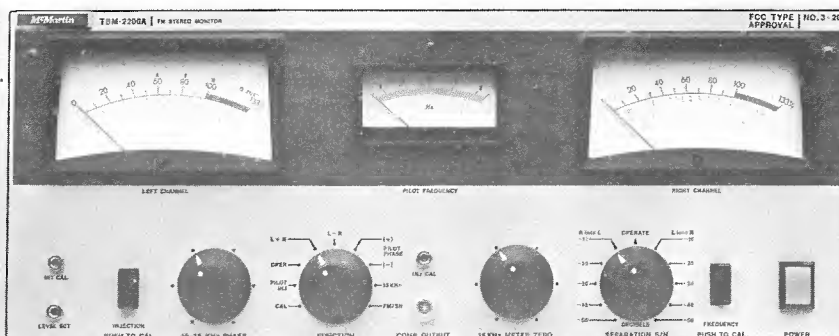
**PLUG-IN MODULAR DESIGN****19 kHz FREQUENCY METERING****19-38 kHz PHASING ADJUSTMENT****LEFT AND RIGHT MODULATION METERS****FULL REMOTE METERING OPTIONS****INTERNAL 19 kHz CALIBRATION****DESCRIPTION**

The McMartin TBM-2200A solid state stereo modulation and frequency monitor is designed to operate in conjunction with McMartin base band monitors, TBM-3700, TBM-4000A, TBM-3500A, or TBM-3500B, to provide all stereo monitoring requirements. Three meters are used for simultaneously monitoring the left and right stereo channels and the center frequency deviation of the 19 kHz pilot carrier. The right and left meters are also used as audio voltmeters, which serve a secondary function of measuring separation between right and left channels, crosstalk between main and subchannels, 38 kHz carrier suppression and stereo S/N of each channel.

The various meter functions are incorporated in one switch. Functions read on the left meter are as follows: Calibrate level, pilot injection level, operate, L+R, 19-38 kHz phasing, 38 kHz suppression and stereo signal-to-noise ratio. L-R information is read on the right meter. When the function switch is in the stereo S/N position, the audio is automatically de-emphasized.

A precise 19 kHz signal and additional circuitry are used to accurately calibrate the 19 kHz pilot injection measuring circuits. This allows

daily verification of the accuracy of the monitor and frequency of the 19 kHz pilot.

The metering circuits used in the TBM-2200A are peak-indicating devices capable of accurately measuring composite signals. The meter driving circuits are designed to go into saturation slightly above full scale deflection to protect the meters against severe overload.

An indicator light displays the presence of the 19 kHz pilot carrier. A phasing control, located on the front panel allows adjustments of the 19 and 38 kHz circuits for exact phase coincidence.

A switched front panel termination permits viewing of the pilot carrier, L+R and L-R signals. All critical circuits are on plug-in cards, removable from the rear of the chassis for ease of servicing. The power supply design includes short circuit protection. A squelch circuit disables the 19 kHz frequency metering in the absence of the pilot carrier.

The TBM-2200A has complete facilities for optional remote monitoring of the 19 kHz pilot carrier level, left and right stereo modulation and frequency deviation of the pilot carrier.

MAR/'74

The FCC type approval number is 3-201.

SPECIFICATIONS

COMPOSITE INPUT

Impedance: 5K ohms
Sensitivity: 0.9 to 1.5 volts peak to peak

OUTPUTS (left and right)

AUDIO OUTPUT FOR MONITORING CIRCUITS

Source
impedance: 600 ohms balanced
Level: +2 dBm at 100 percent modulation
at 400 Hz
Distortion: Less than 0.5 percent
(50-15,000 Hz)

AUDIO OUTPUT FOR DISTORTION MEASUREMENT

Impedance: 10K ohms or greater
Level: 5 volts at 100 percent at 400 Hz
Frequency
response: ± 0.5 dB, 30-15,000 Hz

DISTORTION

STEREO: 0.35 percent, 30-15,000 Hz
STEREO NOISE
LEVEL: -66 dB below 100 percent modulation
at 400 Hz

COMPOSITE OUTPUT

SOURCE
IMPEDANCE: 1000 ohms
LEVEL: 0.3 volts rms
FREQUENCY
RESPONSE: ± 0.2 dB, 50-75,000 Hz

PILOT INJECTION CIRCUIT

ACCURACY: ± 0.5 percent
METER INDICATION: 6-12 percent (pilot injection scale)
INDICATOR: Pilot lamp (operates at 5 percent or
greater injection level)

INTERNAL PILOT CALIBRATE

ACCURACY: ± 0.5 percent

MODULATION METERS (left or right)

ACCURACY: ± 0.5 dB
FREQUENCY
RESPONSE: ± 0.5 dB, 30-15,000 Hz

SEPARATION

LEFT and
RIGHT CHANNELS: -45 dB or better (50 to 10,000 Hz)
-40 dB or better (10,000-15,000 Hz)

NOTE: Separation can be measured internally down to 30 dB

MEASUREMENT OF SUPPRESSED 38 kHz CARRIER

MODULATED 100%
WITH FREQUENCIES
ABOVE 5 kHz: Better than 50 dB
NO MODULATION: Better than 60 dB

CROSSTALK

MAIN INTO STEREO
SUB CHANNEL: 50 dB or better
STEREO
SUBCHANNEL INTO
MAIN CHANNEL: 50 dB or better
67 kHz INTO
MAIN OR
STEREO CHANNEL: 66 dB or better

PILOT CARRIER FREQUENCY METER

DEVIATION RANGE: ± 2.5 Hz
ACCURACY: ± 0.25 Hz

REMOTE MONITORING FACILITIES

MODULATION: ... Optional RM-22 T/R kit available.
Left and right meter may be remotely
monitored with 2500 ohm external
loop resistance. Remote meters are
completely independent of internal
meters.

PILOT CARRIER

FREQUENCY: Frequency deviation may be remotely
monitored with 2500 ohms ex-
ternal loop resistance.

POWER REQUIRED: 105-125 volts AC

AMBIENT TEMPERATURE RANGE: 10-50 degrees C

DIMENSIONS: (w) 19" (EIA Standard rack mount)
(h) 7"
(d) 13" overall

WEIGHT: 15 lbs.

FINISH: McMartin beige with wood grain trim

SCA FREQUENCY/MODULATION MONITOR

TBM-2000B

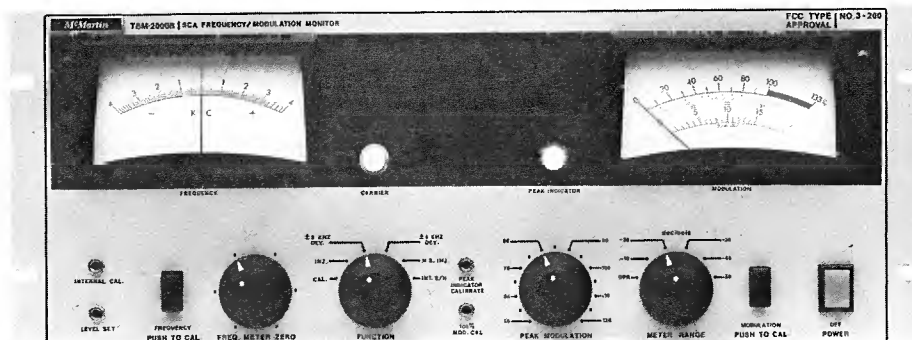

**INTERNAL CALIBRATION
MODULAR PLUG-IN CARD DESIGN**

**REMOTE METERING OPTION
CARRIER-OFF MUTING**

DESCRIPTION

The McMartin TBM-2000B silicon solid-state SCA monitor, in conjunction with the McMartin TBM-3700, TBM-3500B, TBM-3500A, TBM-4000A or TBM-4500A monitors, will monitor all the characteristics of the SCA transmission. The TBM-2000B features the measurement of injection level, modulation, frequency of the SCA carrier, SCA FM signal-to-noise, and crosstalk.

For simplicity of operation, the various metering functions are incorporated in one switch. The functions read on the right meter as follows: Set level-cal., injection level, ± 6 kHz deviation, ± 4 kHz deviation, narrow band injection, and internal signal-to-noise of the monitor. In addition, the TBM-2000B features push-button calibration of the frequency meter, injection level, and modulation meter.

The modulation meter is a peak indicating device capable of measuring true peak value. The meter is also used as an audio voltmeter to measure the FM signal-to-noise of the sub-channel, main to sub-channel crosstalk, crosstalk between two sub-channels and the inherent FM S/N of the monitor. When the meter range switch is in the 'operate' position, the meter ballistics conform to the FCC requirement.

A crystal reference oscillator is used to calibrate the frequency meter. This oscillator and addi-

tional circuitry are used to accurately calibrate the modulation meter and the internal calibrate system. The internal FM noise of the TBM-2000B is typically 70 dB below 100% modulation.

The frequency meter is automatically protected against severe overload. A carrier light indicates presence of the sub-channel. The audio is automatically muted and the frequency meter de-activated in the absence of the subcarrier. The mute threshold is adjustable.

The TBM-2000B has complete facilities for remote monitoring of the modulation, carrier frequency deviation, peak modulation indicator and sub-carrier presence indicator.

Two rear-chassis composite output terminations are available for viewing the wide band output.

A relay is activated when the SCA carrier is muted or falls below a predetermined level. One pair of relay closures are available on the rear chassis for operation of an external signal system for indication of carrier 'On' or 'Off' condition.

All critical circuits have double regulation for added stability. All solid state devices are operated far below their rated voltage for greater reliability.

MAR/74

The FCC type approval number is 3-200.

SPECIFICATIONS

OPERATING RANGE: 67 kHz standard (26, 41, 42 and 65 kHz frequencies optional)

MODULATION

RANGE: ± 6 kHz deviation—100 percent modulation
 ± 4 kHz deviation—100 percent modulation
 Selection is made by front panel function switch

COMPOSITE INPUT

Impedance: 2000 ohms
Level adjustable by front panel level set: 0.3 volts rms or greater

MODULATION METER

Accuracy: ± 0.5 dB
Frequency response: 30 - 7500 Hz ± 1 dB (67 kHz)
 30 - 5000 Hz ± 1 dB (41 kHz)

PEAK FLASHER INDICATOR:

Peak light adjustable to read modulation peaks from 50 to 120 percent. Responds to modulation peaks of 0.1 millisecond duration and remains on for 2 to 4 seconds as required by the FCC.

INTERNAL MODULATION CALIBRATION ACCURACY:

..... $\pm 2\%$

SCA FREQUENCY METER

Deviation range: ± 4000 Hz, center zero
Accuracy: Better than ± 50 Hz at 67 kHz
Stability: Maintained by crystal with 0.005 percent tolerance

SCA INJECTION CIRCUIT

Accuracy: ± 0.5 percent
Meter indication: 0-15 percent in 1 percent increments
 0-30 percent in 1 percent increments

Internal injection calibrator accuracy: ± 0.5 percent

OUTPUTS—SCA SUB-CHANNEL

AUDIO OUTPUT FOR MONITORING CIRCUITS

Source impedance: 600 ohms balanced
Level: $+2$ dBm at ± 6 kHz deviation (100 percent modulation -400 Hz)
Distortion: Less than 1 percent (400 Hz)

AUDIO OUTPUT FOR DISTORTION MEASUREMENTS

Impedance: 10K ohms or greater
Level: 4 volts at ± 6 kHz deviation (100 percent modulation -400 Hz)
Frequency response: 30-7500 Hz ± 1 dB (67 kHz)
Distortion: 1.0 percent, or less -400 Hz
Noise level: 66 dB or greater below ± 6 kHz deviation (100 percent modulation -400 Hz)

CROSSTALK (front panel range control measures down to -70 dB)

Main channel (30-15000 Hz) into SCA sub-channel: 66 dB or better
Stereo (23-53 kHz) into SCA sub-channel (67 kHz): 55 dB or better

SCA-1 channel into SCA-2 channel: 66 dB or better

POWER REQUIRED: 105-125 volts AC, 50/60 Hz 35 watts

FUSE: 0.5 amp slo-blo

AMBIENT TEMPERATURE RANGE:

..... 10-50° C

DIMENSIONS:

(w) 19" (EIA standard rack mount)
 (h) 7"
 (d) 13" overall

WEIGHT: 20 pounds

FINISH: McMartin beige with wood grain trim

REMOTE MONITORING FACILITIES

Modulation: (optional) RM-37 T/R kit available. Modulation may be remotely monitored with 2,500 ohm external loop resistance plus remote meter resistance. Remote meter is completely independent of internal meter

Frequency: Subcarrier frequency may be remotely monitored with remote line resistance up to 3,000 ohms

Peak flasher: Termination provided for remote peak flasher installation

Subcarrier presence indicator: Termination provided of relay closure for remote "Subcarrier On" indicator or external carrier failure alarm devices

FM MODULATION MONITOR

TBM-3500B

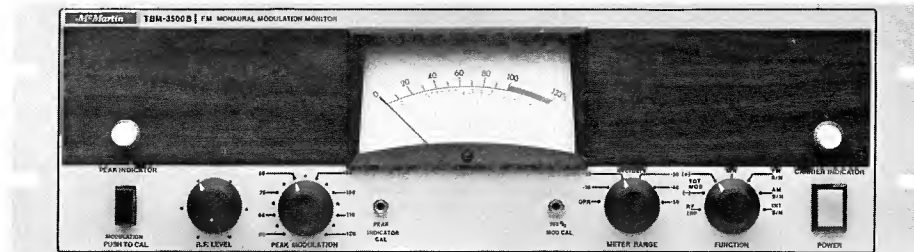

DIRECT READING AM & FM S/N
MODULAR PLUG-IN CONSTRUCTION
OPTIONAL PLUG-IN LOW LEVEL INPUT

INTERNAL CALIBRATION
CARRIER FAILURE ALARM
REMOTE METERING AVAILABLE

The McMartin TBM-3500B monitors the modulation of main-channel FM broadcast stations, and when used with a) the TBM-2200A, all parameters of stereophonic transmission; and/or b) the TBM-2000B, all parameters of SCA multiplex operation.

The TBM-3500B permits metering of total positive and negative modulation and measurement of FM and AM signal-to-noise ratios as low as -70 dB. A peak flasher independent of meter switching indicates the highest positive or negative peak encountered. Threshold is adjustable from 50% to 120%.

The meter functions as a semi-peak reading voltmeter for modulation. When used to read AM or FM noise the meter is damped to improve readability in the presence of noise. Meter positions are provided to read the inherent internal noise (typically -75 dB below 100% modulation) of the monitor and internal calibration. When reading AM, FM or internal noise 75 microsecond de-emphasis is automatically inserted into the measuring circuit.

With the optional plug-in LL-35B low level input card

installed the TBM-3500B will operate with RF signals as low as 350 microvolts. This permits operation from an antenna-derived input signal in most situations and eliminates the need for an external RF amplifier.

Should RF input be interrupted or fall below a preset level, a front panel carrier presence lamp is extinguished, audio output is automatically muted, and a carrier-off relay operates. External alarm devices may be activated by the latter.

The optional Model RM-35B provides for rack-mount remote modulation metering and peak flasher indication. Up to 2,500 ohms of loop and meter resistance can be accommodated in the remote meter circuit.

High impedance audio output for connection of external distortion measurement equipment, and a 600-ohm balanced output for audio monitoring are rear-chassis terminated.

Designed for rack mounting, the TBM-3500B is attractively styled in McMartin beige with wood grain trim.

The FCC type approval number is 3-219

JAN / 79

SPECIFICATIONS

OPERATING RANGE88-108 MHz

MODULATION RANGE75 kHz deviation-100% modulation
100 kHz deviation-133% modulation

RF INPUT (standard)
Impedance50 ohms unbalanced
Sensitivity0.1 to 1 watt

RF INPUT (with optional LL-35B low level input card)
Impedance50 ohms unbalanced
Sensitivity350 microvolts minimum

OUTPUTS
Audio output for monitoring circuits
Source
Impedance600 ohms balanced
Level+2 dBm at 100% modulation at 400 Hz
Distortionless than 0.5%, 50 to 15,000 Hz

Audio output for distortion measurement
Impedance10K ohms or greater
Level5 volts at 100% modulation at 400 Hz

Frequency response±0.5 dB, 30-15,000 Hz

Distortion
Monaural0.2%, 30 to 15,000 Hz
Noise level-75 dB below 100% modulation at 400 Hz

Composite Output (2)
Source
Impedance300 ohms
LevelApproximately 1.0 volt peak-to-peak

Frequency response±0.2 dB, 30 to 100,000 Hz
3 dB down at 180 kHz

75 microsecond deemphasis or flat response selectable for measurement purposes.

MODULATION METER (Ballistics meet FCC Requirements)
Main Channel Position±0.5 dB
Accuracy
Frequency response±0.25 dB, 30 to 15,000 Hz at 100% modulation

PEAK FLASHER (Peak Flasher Meets FCC Requirements) ... Peak light adjustable to read positive and negative peaks from 50% to 120% modulation

Total Modulation (+) or (-) Positions Accuracy±0.5 dB
Frequency response±0.25 dB, 30 to 75,000 Hz

INTERNAL CALIBRATION Accuracy2% of 100% modulation

REMOTE FACILITIES MODULATIONRM-35 meter panel optionally available. Modulation may be remotely monitored with 2,500 ohm external loop resistance plus remote meter resistance. Remote meter is completely independent of internal meter.

PEAK INDICATORThe peak light may be remotely monitored.

ALARM INDICATOR AND MUTERelay contact closures are available on the rear terminals when the RF carrier fails or falls below a preset value. Audio output from the monitor is muted.

POWER REQUIRED105 to 125 volts AC, 50/60 Hz, 35 watts

AMBIENT TEMPERATURE RANGE10° to 50° C (50° F to 122° F)

DIMENSIONS19" (48.2 cm) width
5 1/4" (13.3 cm) height
13" (33 cm) depth

WEIGHT20 lbs (9.0 kgms)
Shipping weight 23 lbs (10.4 kgms)

FINISHMcMartin beige with wood grain trim

ORDERING INFORMATION

Model	Description	Product Code
TBM-3500B	FM Modulation Monitor	10-03-029
RM-35B	Remote metering rack mount panel	10-03-045
LL-35B	Low level input module	10-03-044

SOLID STATE RF AMPLIFIER

TBM 2500-C series



TBM-2500-C: FM BAND

TBM-2500-CL: TV-CH 2-6

TBM-2500-CH: TV-CH 7-13

FULLY METERED

ULTRASTABLE OPERATION

AGC LEVEL CONTROL

DESCRIPTION

The TBM-2500-C, -CL and -CH are designed to amplify off-air signals in the FM and VHF-TV frequency ranges to a level suitable for driving FCC Type-Approved frequency and modulation monitoring equipment located at sites remote from the transmitter.

Utilizing essentially identical circuitry, the three models perform this function with minimum degradation of the transmitted signal and its sidebands.

Excellent passband and skirt selectivity characteristics of a special IF filter insure optimum response to the desired signal and rejection of interfering signals. A sum and difference oscillator injection technique is used so that a zero operating-frequency error results.

The models incorporate AGC circuitry to maintain constant output signal with input signal variations over a 45 dB range. This, in conjunction with excellent limiter action, minimizes signal amplitude variations resulting from propagation effects or "flutter" generated by signal reflections caused by passing aircraft.

Metering of injection voltage, AGC bus voltage, RF drive and RF output is provided.

0.5 watts output (0.2 for the TBM-2500-CH) is developed with a 500-microvolt input signal, with complete limiting.

Although designed for specific use with the complete McMartin line of FM and VHF-TV FCC Type Approved monitoring equipment, the TBM-2500-C series RF amplifier will drive any of the current monitors regardless of manufacture.

SPECIFICATIONS

OPERATING RANGES:

TBM-2500-C	88-108 MHz
TBM-2500-CL	TV Channels 2-6
TBM-2500-CH	TV Channels 7-13

SELECTIVITY: 290 kHz @ 3 dB points . . 60 dB down at 800 kHz

SENSITIVITY:

TBM-2500-C	500 microvolts at antenna input produces 0.5 watts output and full limiting
TBM-2500-CL	Same as TBM-2500-C
TBM-2500-CH	500 microvolts at antenna input produces 0.2 watts output and full limiting

LEVEL,

Input Overload 100,000 microvolts

LEVEL,

Maximum Output	
TBM-2500-C	0.5 watts
TBM-2500-CL	0.5 watts
TBM-2500-CH	0.2 watts

IMPEDANCES:

Input	50 ohms, unbalanced (BNC connector)
Output	50 ohms, unbalanced (BNC connector)

AGC RANGE: 45 dB

POWER REQUIRED 115/230 VAC, 50/60 Hz, 15 watts

DIMENSIONS: 19 (W) x 5¼" (H) x 10 (D)

WEIGHT: 10 pounds

CONTROLS, FRONT PANEL: Power on/off; output level; Metering, (1)OSC; (2)AGC; (3)Drive; (4)Output



FM RELAY RECEIVER

FM range **TBM-1005D**

TV (VHF only) **TBM-1003D**

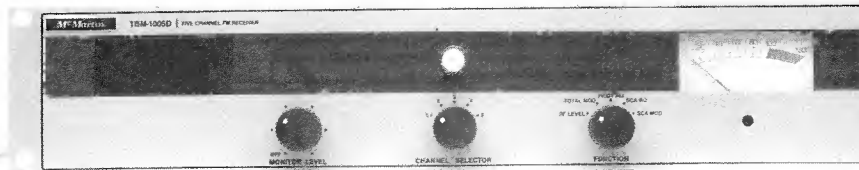

NEW PTD (PRECISE TRACKING DECODER)

IMPROVED SENSITIVITY

GREATER RF DYNAMIC RANGE

STEREO/SCA PLUG-IN OPTIONS

1-5 CHANNEL CAPABILITIES

IMPROVED LINEARITY

FULLY METERED

PANEL MOUNTED MONITORING SPEAKER

The McMartin TBM-1005D is a 1-5 channel crystal controlled FM relay receiver which supercedes the performance proved TBM-1000B series. The McMartin TBM-1003D is available for operation in the VHF-TV aural channels. Channel 2 through 6 and channel 7 through 13 only.

The McMartin TBM-1005D is a high performance FM relay receiver with an accurate wide band composite signal output. The receiver also provides stereo and/or SCA outputs by simple insertion of optional plug-in cards. Two cards may be accommodated. The optional STE-1D stereo plug-in card provides a left and right channel output at a level of +8dbm (600 ohms), and provides accurate measurement of the stereo pilot injection level.

The optional SCA-2-67D or SCA-2-41D SCA plug-in cards will provide an SCA audio output of +8dbm (600 ohms) and provide measurement of the SCA injection level plus monitoring of the modulation level, selectable by the front panel function switch. Two SCA plug-in cards may be used simultaneously with the second SCA card inserted in the mono or stereo socket.

The standard mono card incorporates a 15 kHz low-pass filter to remove the troublesome 19 kHz stereo signal from the audio which can otherwise create problems if the signal is used for rebroadcast or recording.

The TBM-1005D utilizes a new concept in receiver design providing space age technology in which the receiver actually tracks the modulated signal from the

FM transmitter providing accurate composite signals identical to what was originally transmitted.

The front end of the TBM-1005D is crystal controlled and utilizes a diode protected dual gate D-MOS field effect RF amplifier. This device has very linear AGC control providing greater than 50db gain reduction resulting in an overall tuner dynamic range of over 100db with minimum of cross modulation. The AGC does not produce any skewing or detuning of the RF circuits. All RF circuitry switching and tracking is performed by using Varactor tuning techniques. No switch contacts are used in RF circuits and each channel is tuned by a trimpot potentiometer controlled by the front panel function switch.

An entirely new IF system has been designed eliminating the multisection 10.7 mHz IF band-pass filter. The system has been encapsulated within a specially designed hybrid chip. The TBM-1005D provides better selectivity to reject unwanted signals and still provide accurate composite signals. Provisions are provided for the addition of an optional filter for exceptional high selectivity.

Adjustable squelch control of main channel and two SCA channels are provided. The two SCA squelch controls are mounted on the rear chassis and are adjustable from 3% to 10% injection levels

The TBM-1005D and 1003D are rack mounted and styled in beige with wood grain trim.

JAN/78

SPECIFICATIONS

MAIN CHANNEL

ANTENNA INPUT
IMPEDANCE50/72 ohm unbalanced

RANGE—
TBM-1005D88-108 mHz
TBM-1003D VHF-TV channels 2-13
 aural carriers

SENSITIVITY—
TBM-1005D1 microvolt for 30db quieting
(MONAURAL)3 microvolts for 50db quieting

TBM-1003D (CH. 2-6)1.5 microvolt for 30db quieting
(CH. 7-13)3 microvolts for 30db quieting

SELECTIVITY—
TBM-1005D50db alternate channel (Standard)
70db with optional filter

CAPTURE RATIO1db or less (wide band)
 1.5db or less (with optional filter)

COMPOSITE OUT-PUT1.5v (P-P) adjustable

COMPOSITE FREQUENCY RESPONSE ±0.3db 10-75000 Hz

PROGRAM AUDIO OUTPUTS

MONAURAL PLUG-IN CARD (standard)
Audio output impedance600 ohm balanced

Output level +8dbm @ 100% mod. 400 Hz

Frequency response ±0.5db 30-15000 Hz

De-emphasis75 microsecond standard
 25 or 50 microsecond available

S/N ratio Typically 65db or greater below
 100% mod. 400 Hz

Distortion THD 0.5% or less (30-15000 Hz)

19 kHz pilot carrier rejection65db or greater

STEREO PLUG-IN CARD STE-1D (optional)

Audio output impedance600 ohm balanced right and left channel

Output level +8dbm right and left channel

Frequency response +0.5db 30-15000 Hz

De-emphasis75 microsecond standard
 25 or 50 microsecond available

S/N ratio55db or greater below 100%
 Modulation 400 Hz left or right Ch.

Distortion THD 1% or less 30-15000 Hz

Channel separation40db 30-10000 Hz
 30db 10000-150000 Hz

Pilot injection metering ±1% accuracy when receiver is
 completely limited.

SCA rejection65db or greater

SCA PLUG-IN CARD SCA-2-67D (optional)

Audio output impedance600 ohm balanced

Output level +8dbm 100% modulation (±6 kHz
 deviation) @ 200 Hz

Frequency response ±3db—30-6000 Hz with modified
 150 microsecond de-emphasis

S/N ratio Typical 60db below 100% modulation
 referenced @ 200 Hz

Distortion1% or less 30-6000 Hz—Typically
 0.5% at 400 Hz

SCA injection metering ±1% accuracy when receiver is
 completely limited

SCA modulation metering Meter is semi-peak reading and
 referenced at ±6 kHz deviation
 for 100% modulation

SCA—PLUG-IN CARD SCA-2-41D (optional)

Specifications are generally the same as for the SCA-2-67 kHz
 plug-in card excepting the 100% modulation is referenced at ±4
 kHz deviation. *NOTE: Other SCA frequencies are available.*

METERING FUNCTIONS: Relative RF level, total modulation,
 pilot injection, SCA injection and
 SCA modulation

POWER REQUIRED:120/240 VAC 50/60 Hz—25 watts

DIMENSIONS:19" (48.26 cm) width
 standard EIA rack mount.
 3½" (8.89 cm) height
 12" (30.48 cm) depth

FINISH: McMartin beige with woodgrain trim

PLUG-IN ACCESSORIES:

STE-1D: Stereo demodulator card

SCA-2-67D:67 kHz SCA demodulator card

SCA-2-41D:41 kHz SCA demodulator card

*NOTE: Other SCA frequencies available.
 The TBM-1005D and 1003D are
 normally supplied with the plug-in
 mono card.*

NB-1: Optional band-pass filter

REAR CHASSIS TERMINATION: Antenna (BNC), composite output
 (BNC) monaural or stereo left, SCA-2
 or stereo right, SCA-1 and carrier
 relay contacts (NO) or (NC)

Relay contacts rating:0.5 amp. @ 24 volts

ORDERING INFORMATION:

MODEL	DESCRIPTION	PRODUCT CODE
TBM-1005D	5 Channel Relay Runner 88 to 108 mHz (with one crystal) Additional Crystals (specify frequency)	10-03-009
TBM-1003D	TV Aural Receiver Channel 2-13	
STE-1D	Stereo Plug in Demodulator Card	10-03-012
SCA-2-41D	SCA Plug in Demodulator Card 41KH2	10-03-010
SCA-2-67D	SCA Plug in Demodulator Card 67KH2	10-03-011

PORTABLE REMOTE PICK-UP TRANSMITTER

RPU-1103



150 MHz 3W PORTABLE REMOTE PICKUP TRANSMITTER

ALL SOLID STATE

DUAL FREQUENCY OPERATION (ONE SUPPLIED)

RUGGED LIGHTWEIGHT CONSTRUCTION

DESIGN EXCEEDS ALL NEW F.C.C. REQUIREMENTS

RECHARGEABLE 8 HOUR BATTERY

The McMartin RPU-1103 Portable Remote Pick-up Transmitter is a completely self-contained 150 MHz, three watt battery operated transmitter. The transmitter is designed to be used by today's on-the-go newsmen. When carrying the unit on the shoulder strap, the RPU-1103 allows instant viewing of the controls and indicators. Along with the unique styling, the transmitter provides a degree of audio and RF performance never before available in a portable RPU. The transmitter incorporates the latest in solid state circuit technology. The use of only the highest quality circuit components, silver mica and tantalum capacitors, are used wherever possible.

Optional two-frequency operation is available from the factory or can be added later in the field simply by plugging in the second channel element. Two channel operation with up to 1 MHz separation will not deteriorate performance.

Two high-quality audio inputs are provided. The microphone input, located on the front panel, offers 25 dB of compression along with an L.E.D. indicator to display proper operation. A front panel switch is provided to

key the transmitter when using the rear mounted line input. This eliminates the live microphone condition if the "push-to-talk button" were used to key the transmitter while using the line input. The audio compressor functions on both the line and microphone, allowing simple talk over line operation.

A rear compartment is provided to allow quick easy access to the 2.5 amp-hour battery. A charger jack is located on the rear of the RPU-1103 to allow charging of the battery while mounted in the transmitter. The battery will provide up to 10 hours of reporting at a 30% duty cycle. Exchanging the battery is quickly accomplished by means of a quarter turn fastener and an in-line battery power plug.

The microphone input jack mates with either a GC-18-092 or Amphenol 88-870 or equivalent, one of which is included with each unit. The standard whip antenna provides increased gain and transmitting range over the optional rubber duck type antenna.

The durable aluminum construction complimented by the small size offers an extremely attractive portable transmitter weighing only 6 pounds, including battery.

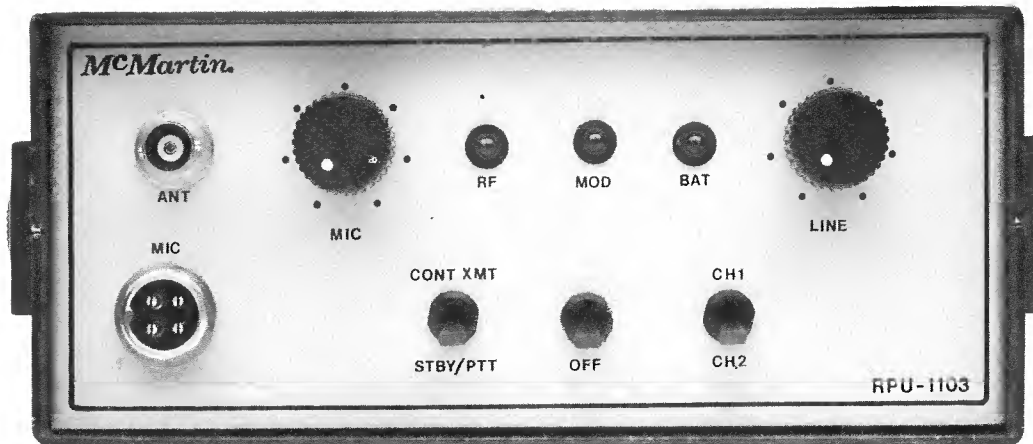

Control panel (top view) of RPU-1103

SPECIFICATIONS

FREQUENCY 150-172 MHz

CRYSTAL MULTIPLICATION Times 12

FREQUENCY STABILITY0005% standard

DUAL FREQUENCY OPERATION Front panel switch selectable (crystal optional)

SPURIOUS EMISSIONS >60 dB below rated output

RF Output 3W nominal

VSWR PROTECTION No damage incurred by excessive VSWR

RF OUTPUT CONNECTION Type BNC

TEMPERATURE RANGE -20°-50°C
0°-120°F

MODULATION30F3 adjusted for ±5 kHz deviation

NOISE >50 dB below 100% modulation

AUDIO INPUTS 2 provided, 1 mic input push-to-talk,
1 unbalanced high level input

AUDIO RESPONSE .. ±.75 dB 50-7500 Hz
(75 μs pre-emphasis)

DISTORTION 1.5% 100-7500 Hz, 1% typical

AUDIO INPUT LEVEL Microphone -65 dBm to -30 dBm
Line -20 dBm to +18 dBm

AUDIO INPUT IMPEDANCE Mic 50/150/600, Line 8 ohm/600 ohm

MIC INPUT CONNECTOR Amphenol 4 pin type 80-871

LINE INPUT CONNECTOR RCA type Phono Jack

POWER REQUIREMENTS2.5 AH battery, 10-13 volt battery internally mounted for quick change. Battery drain 80 MA standby, 600 MA transmit

DIMENSIONS9¼" (24.77 cm) height
7" (17.78 cm) width
3" (7.62 cm) depth

ORDERING INFORMATION

RPU/BAT Battery 12 volts, replacement
RPU/BC Battery Charger
RPU/ANT Antenna, Duck-1-BNC (rubber duck)
RPU/ZCH Second Channel Module
RPU/MIC Microphone 350D, push to talk

PORTABLE REMOTE PICK-UP TRANSMITTER

RPU-1403-40F3
RPU-1403-20F3



RECHARGEABLE 8 HOUR BATTERY
DUAL FREQUENCY OPERATION (ONE SUPPLIED)
DESIGN EXCEEDS ALL NEW F.C.C. REQUIREMENTS
450 MHz 3W PORTABLE REMOTE PICK-UP TRANSMITTER
AVAILABLE FOR BOTH WIDE AND NARROW F.C.C. RPU CHANNELS

The McMartin RPU-1403 Portable Remote Pick-up Transmitter is a completely self-contained 450 MHz, three watt battery operated transmitter. The transmitter is designed to be used by today's on-the-go newsman. When carrying the unit on the shoulder strap, the RPU-1403 allows instant viewing of the controls and indicators. Along with the unique styling, the transmitter provides a degree of audio and RF performance never before available in a portable RPU. The transmitter incorporates the latest in solid state circuit technology. The use of only the highest quality circuit components, silver mica and tantalum capacitors, are used wherever possible.

Optional two-frequency operation is available from the factory or can be added later in the field simply by plugging in the second channel element. Two channel operation with up to 2 MHz separation will not deteriorate performance.

Two high-quality audio inputs are provided. The microphone input, located on the front panel, offers 25 dB of compression along with an L.E.D. indicator to display proper operation. A front panel switch is provided to

key the transmitter when using the rear mounted line input. This eliminates the live microphone condition if the "push-to-talk button" were used to key the transmitter while using the line input. The audio compressor functions on both the line and microphone, allowing simple talk over line operation.

A rear compartment is provided to allow quick easy access to the 2.5 amp-hour battery. A charger jack is located on the rear of the RPU-1403 to allow charging of the battery while mounted in the transmitter. The battery will provide up to 8 hours of reporting at a 30% duty cycle. Exchanging the battery is quickly accomplished by means of a multiturn fastener and an in-line battery power plug.

The microphone input jack mates with an Amphenol 88-870 plug, or equivalent, which is included with each unit. A 6" "Rubber Duck" antenna is furnished, however a whip or fixed mounted external antenna can be used.

The durable aluminum construction complimented by the small size offers an extremely attractive portable transmitter weighing only 6 pounds, including battery.

MAR/78

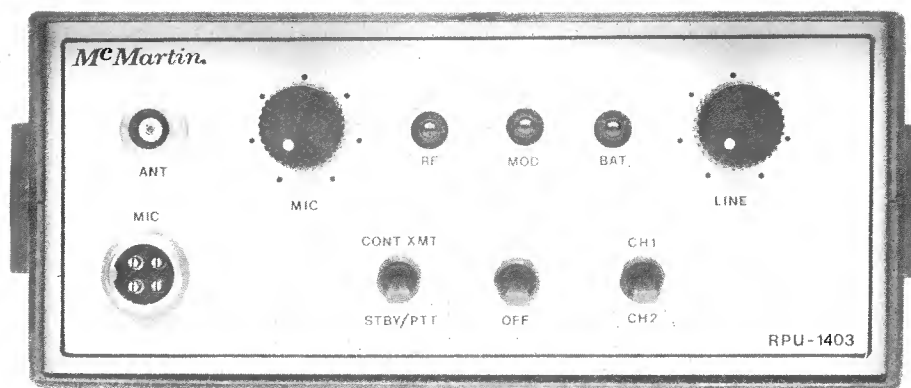

Control panel (top view) of RPU-1403

SPECIFICATIONS

FREQUENCY RANGE450-456 MHz
OSCILLATOR MULTIPLICATION Times 36
FREQUENCY STABILITY0005%
DUAL FREQUENCY OPERATION Front Panel Switch Selectable, max. separation 2 MHz. (Second crystal optional)
SPURIOUS EMISSIONS >60 dB below rated output
RF OUTPUT3W nominal
VSWR PROTECTION No damage incurred by excessive VSWR
RF OUTPUT CONNECTIONType BNC
TEMPERATURE RANGE-30 to +50° C -20 to +120° F
AUDIO INPUT IMPEDANCE Mic 50/150/600 Balanced Line 8 ohm/600 Unbal.
MIC INPUT CONNECTOR Amphenol 4 pin type 80-871 (Push-to-Talk)
LINE INPUT CONNECTOR RCA type Phono Jack
AUDIO INPUT LEVEL Microphone -65 dBm to -30 dBm Line -20 dBm to +18 dBm
FM NOISE >50 dB below 100% modulation -55 dB typical
DISTORTION Less than 1.5% within audio bandpass; 0.75% typical

	RPU-1403-40F3	RPU-1403-20F3
Channel Desig.	N1, R (50 KHz)	N2 (25 KHz)
Audio Response	30-10 KHz ±1 dB	30-5 KHz ±1dB
Carrier Dev.	±10 KHz	±5 KHz

PRE-EMPHASIS75 microsecond, standard

LED INDICATORS Rectified RF output
3 dB audio 'Peak Flasher'
Battery Condition

POWER REQUIRED 2.5 AH battery, 10-13 volt battery internally mounted for quick change.
Battery drain 80 MA standby,
800 MA transmit

DIMENSIONS 9³/₄" (24.77 cm) height
7" (17.78 cm) width
3" (7.62 cm) depth

FINISH McMartin beige and bronze with simulated leather exterior.
Rugged shoulder strap.

WEIGHT7.7 lbs. (3.5 kg)

ORDERING INFORMATION

MODEL	DESCRIPTION	PRODUCT CODE
RPU-1403	Portable Remote Pick-up Transmitter10-01-087
RPU/BAT	Battery 12 volts, replacement10-01-115
RPU/BC	Battery Charger10-01-111
RPU/ANT 450 MHz	Antenna (rubber duck), replacement10-01-118
RPU/2CH	Second Channel Module10-01-114
RPU/MIC	Microphone 350D, push to talk10-01-113

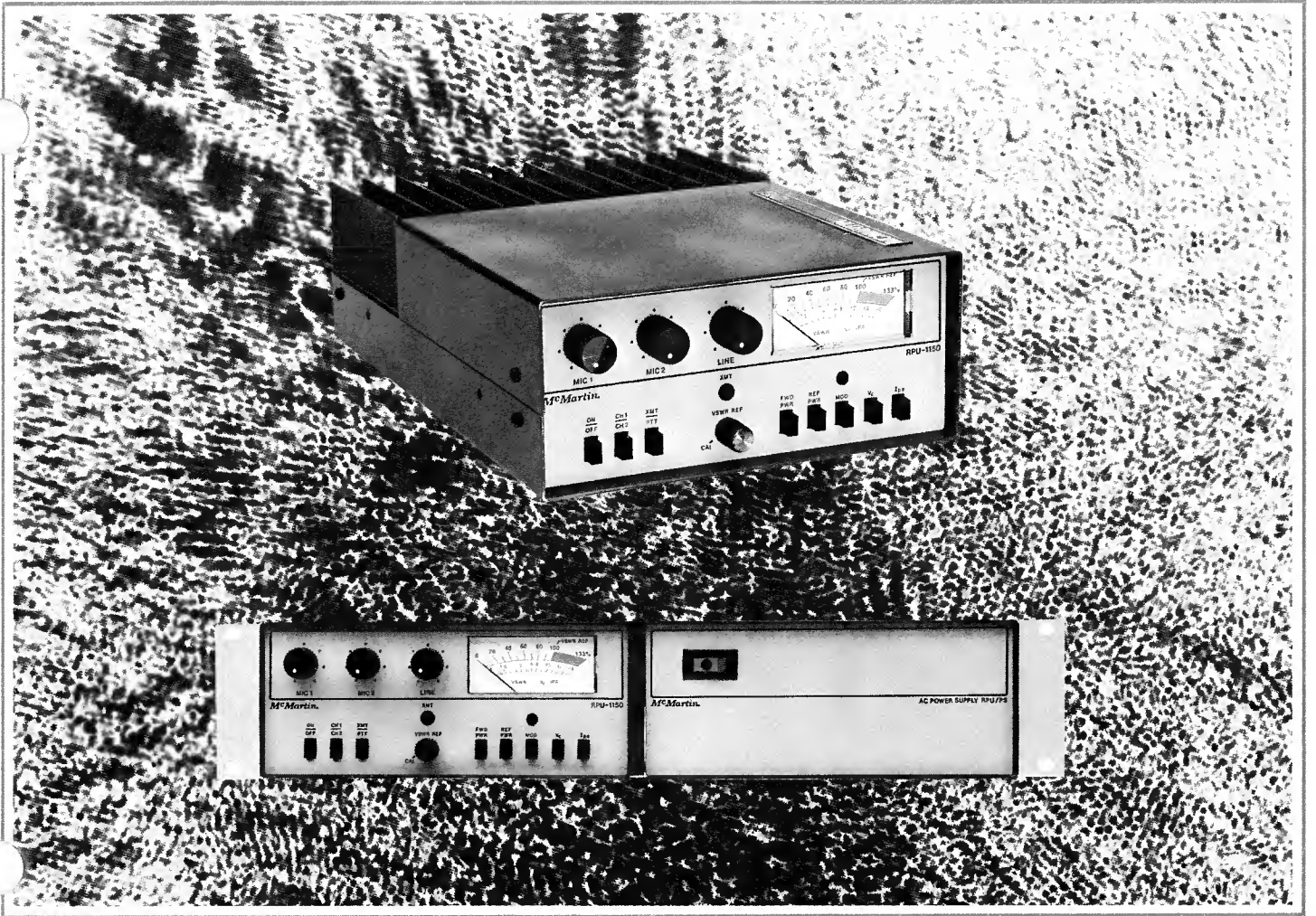

150 MHz / 450 MHz remote broadcast transmitters

150-170 MHz and 450-455 MHz broadcast quality remote pick-up transmitters.

Mobile or Fixed Base Operation.

**Front panel multimeter indicates modulation, fwd., and Ref power, Vc, IPA
Dual frequency operation (one oscillator supplied, 1 MHz maximum spacing)**

Microphone and line transformer inputs.

Compressor limiter operates on both line and mic inputs.

Talk over line input capability.

Latest design exceeds all new F.C.C. requirements.

Rugged lightweight construction (weighs only 8 lbs.).

All solid state; High VSWR and Thermal Overload protected.

Use of highest quality components.

**Full-line of accessories available including 120/240 VAC power supply, rack mount
frame, antennas, etc.**

Super serviceability.

The McMartin RPU-1150 and RPU-1430 Remote Broadcast transmitters incorporate the latest in FM solid state technology and are designed for high audio quality remote broadcast program origination. The RPU-1150 operates on a specified frequency in the range of 150-170 MHz with a continuous power output rating of 50 watts.

The RPU-1430 operates on a specified frequency in the 450-455 MHz range with a continuous power output of 30 watts. The units are identical in size and appearance and utilize the same accessories except for antennas.

The basic unit is designed for 13.5 VDC mobile power sources but can also be operated from 115 or 230 VAC, 50-60 Hz with an optional companion power supply. The supply can be mounted separately or side-by-side with the transmitter in an optional rack-mount cabinet. By removing the de-mountable rack ears and attaching a carrying handle (supplied), the cabinet doubles as a smart portable carrying case.

The unit is equipped with a full complement of front panel-mounted controls and has provisions for a remote control head. A combination under-dash/floor mount cradle is furnished as standard for mobile operation.

A switch-selected multimeter allows the user to read forward and reflected RF power, modulation level, supply voltage and power amplifier current.

The RPU-1150 and RPU-1430 employ a direct FM modulation process employing a crystal oscillator operating at 1/12 or

1/36 the output frequency. The transmitter has built-in two channel capability. All that is required to expand the operation to two channels is install the second plug-in channel element. The frequency is then determined by the front panel or remote channel select switch. Both frequencies must be in the same FCC channel grouping.

The audio processing circuitry provides excellent limiting characteristics with minimum distortion. Excellent overload and dynamics range characteristics are ensured by the use of two section microphone gain controls. This permits the use of either high performance or close talking microphones with nominal output levels over the range of -60 to -30 dBm.

The RF power amplifier is a completely solid state design, conservatively rated for continuous RF output. It is capable of withstanding infinite VSWR conditions at rated supply voltage and drive levels and is the most statically protected against long-term mismatch or overload conditions.

All interstage and output impedance matching is accomplished with broadband microstrip techniques and there are no amplifier tuning adjustments to be made.

A convenient built-in VSWR bridge enables the user to check or adjust the antenna system for a favorable match to effect maximum radiated power.

The transmitters utilize harmonic and spurious suppression techniques that attenuate all undesired signals well below present FCC and international standards.

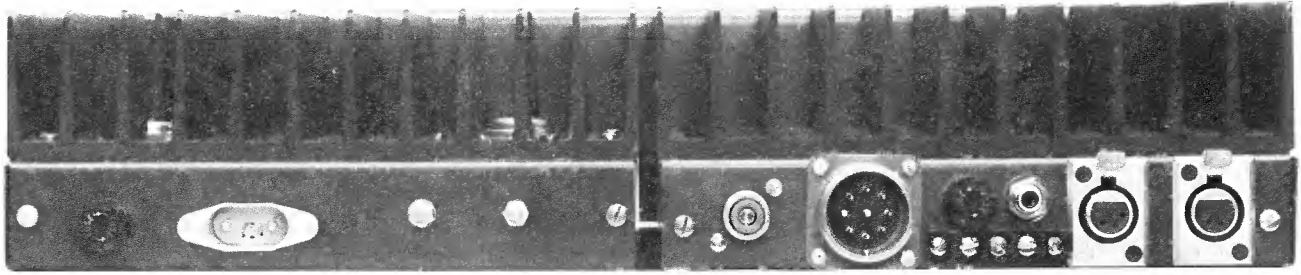

Rear View of RPU 1150 with Power Supply (RPU/PS)

EMISSION/FREQUENCY AVAILABILITY

RPU-1150

GROUP	FREQUENCY MHz	EMISSION DESIG.	AUDIO B.W.	FREQUENCY DEVIATION
K ₁	152.87-153.35 (9 ch.)	25F3	7.5 kHz	±5 kHz
K ₂	161.64-161.76 (5 ch.)	25F3	7.5 kHz	±5 kHz
L	166.25 (1 ch.)	20F3	5.0 kHz	±5 kHz
M	170.15 (1 ch.)	20F3	5.0 kHz	±5 kHz

RPU-1430

N ₁	450 (6 ch.) 455 (6 ch.)	50F3	10.0 kHz	±10 kHz
N ₂	450 (12 ch.) 455 (12 ch.)	25F3	5.0 kHz	±5 kHz
R	450 (5 ch.) 455 (6 ch.)	50F3	10.0 kHz	±10 kHz

- NOTE:**
- Standard carrier frequency stability required is ±.0005% except 450 MHz base stations require ±.00025%.
 - Group N₁ and R channels may only be used for program material and cues. All other groupings listed can be used for program, cues and communications.

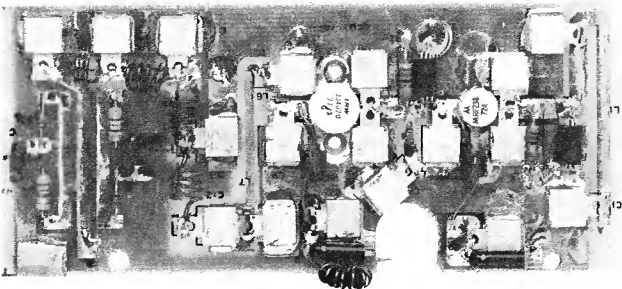

Strip-line RF Amplifier—150 MHz



RPU/MC Mobile Control Head

SPECIFICATIONS

	RPU-1150	RPU-1430
OPERATING FREQUENCY RANGE	148-172 MHz	450-456 MHz
RF OUTPUT POWER	50 watts (Minimum continuous @ 13.5 VDC into 50 ohms.)	30 watts
POWER REQUIRED	10 ADC transmit 100 MADC receive @ 13.5 VDC, (12.5 to 14.5 VDC operating range)	6 ADC transmit 100 MADC receive @ 13.5 VDC, (12.5 to 14.5 VDC operating range)
OSCILLATOR MULTIPLICATION	X12	X36
TEMPERATURE RANGE	-20 to 120° F. (-30 to 50° C)	
SPURIOUS EMISSIONS	Greater than 65 dB below rated output	
MODULATION	Direct FM VCXO; See table for licensed frequencies and bandwidths.	
FREQUENCY STABILITY	±.0005% STD ±.00025% for 450 MHz fixed stations.	
FM and AM NOISE	Greater than 65 dB below 100% modulation, 55 dB typical	
FREQUENCY RESPONSE*	30 Hz to 5 kHz, 7.5 kHz, or 10 kHz ±1 dB depending on licensed channel BW. 75 microsecond pre-emphasis is standard on all units.	
* see NOTE		
AUDIO DISTORTION	.08% typical 1.5% maximum, 50-7500 Hz	
MODULATION CONTROL	By means of audio filter and compressor-limiter	
AUDIO LIMITING	.25 dB at 2 millisecond attack time. 300 millisecond delay	
AUDIO INPUTS	3 independent, 2 mic input push-to-talk, 1 high level line input	
AUDIO INPUT LEVEL	Microphone -65 dBm to -30 dBm. Line -20 dBm to +18 dBm	
AUDIO INPUT IMPEDANCE	Mic 50/150/600 balanced, Line 8 to 600 ohm balanced or unbalanced.	
MIC INPUT CONNECTORS	Amphenol 4 pin type XLR-31	
LINE INPUT CONNECTION	Phone Jack, unbalanced; term strip, balanced	

RF OUTPUT CONNECTION	Type SO-239
DIMENSIONS	3½" (9 cm) height 8½" (20 cm) width 13" (33 cm) depth
WEIGHT	7.7 lbs. (3.5 Kg) NET
FINISH	McMartin Beige & Bronze, on heavy-duty aluminum cabinet

NOTE: Unless otherwise specified, unit will be supplied with audio filter and carrier deviation adjusted as follows:

CHANNEL GROUP	AUDIO BANDWIDTH	CARRIER DEVIATION	EMISSION DESIG.
K1, K2	7.5 kHz	±5 kHz	25F3
L, M	5.0 kHz	±5 kHz	20F3
N2	5.0 kHz	±5 kHz	25F3
N1, R	10.0 kHz	±10 kHz	50F3

75 microseconds Pre-emphasis is standard in all units.

ORDERING INFORMATION

MODEL	DESCRIPTION	PRODUCT CODE
RPU-1150	50 watt 150 MHz remote pickup transmitter. Includes mobile mount, requires 13.5 volt DC @ 10 amps transmit. (Specify frequency)	10-01-088
RPU-1430	30 watt 450 MHz remote pickup transmitter. Includes mobile mount, requires 13.5 volt DC @ 10 amps transmit. (Specify frequency)	10-01-089
RPU/PS	AC power supply	10-01-095
RPU/RmCc	Rack mount and carrying case provides convenient carrying case and rack mounting for both the power supply and 50 or 30 watt transmitter. (Not required for mobile installations)	10-01-096
RPU/MC	Mobile control head for use when unit is trunk mounted. Includes cable from control head to transmitter.	10-01-098

RPU-1150R / RPU-1450R RECEIVERS

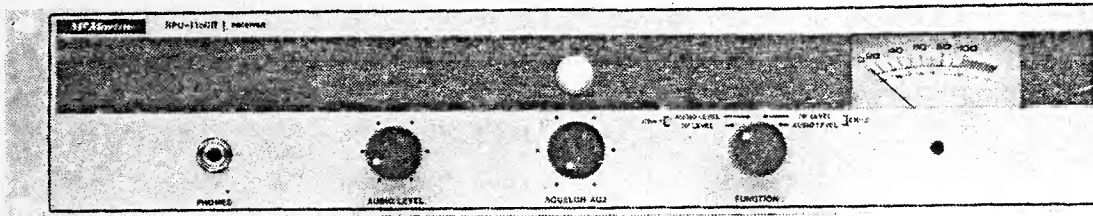

150-175 MHz & 450-470 MHz RPU RECEIVER

FULLY METERED

BALANCED 600 OHM OUTPUT

HIGH SENSITIVITY

6 HIGH "Q" TUNED RF CIRCUITS

4 BANDWIDTH AVAILABLE

ALL SOLID STATE

IMPROVED NOISE SQUELCH

PROVISION FOR DUAL FREQUENCY
OPERATION WITHIN 1 MHz

CARRIER OPERATED RELAY

The McMartin RPU-1150R (150-175 MHz) and RPU-1450R (450-470 MHz) are rack mounted, dual channel, crystal-controlled receivers with high sensitivity and selectivity.

The receiver utilizes dual conversion. The RF signal is amplified and converted to a 10.7 MHz, first IF frequency to provide good image frequency rejection. The 10.7 MHz signal is converted to the second IF frequency of 455 kHz where the signal is amplified hard limited and demodulated with the new PTD, precise tracking demodulator.

The front end of the RPU-1150R and RPU-1450R utilized diode protected dual gate D MOS-FET RF amplifier. This device has a very linear AGC control providing greater than 50 dB gain reduction without any detuning effect of the high "Q" RF tuned circuits.

A noise squelch is used to mute the receiver at the desired S/N output and controlled by the recessed front panel control.

A carrier-operated relay provides either normally open or normally closed contacts in the absence or presence of an RF carrier. This is independently controlled and not related to the noise squelch circuit but RF input level.

The selectivity can be tailored to the desired bandwidth by inserting the proper bandpass filter.

A front panel meter is used to indicate the relative RF input and audio modulation levels. The front panel function switch selects the desired channel, RF input and modulation levels. The sensitivity of the RF metering circuitry allows indication of RF as low as 1 microvolt or less.

RPU-1150R

RPU-1450R

CARRIER FREQUENCY RANGE	150-175 MHz	450-470 MHz
DUAL FREQUENCY OPERATION	Two frequency operation with 1 MHz spacing. Second channel operation optional.	Two frequency operation with 2 MHz spacing. Second channel operation optional.
INPUT IMPEDANCE	50 ohm BNC connector	50 ohm BNC connector
SENSITIVITY	0.3 microvolts for 30 dB quieting referenced from ± 5 kHz deviation @ 400 Hz	0.5 microvolts for 30 dB quieting referenced from ± 5 kHz deviation @ 400 Hz
SELECTIVITY	± 20 kHz @ 6 dB ± 40 kHz @ 60 dB. Optional filters available.	± 35 kHz @ 6 dB ± 60 kHz @ 60 dB. Optional filters available.
S/N RATIO	55 dB below 100%, 60 dB typical	55 dB below 100%, 60 dB typical
SPURIOUS RESPONSE	At least -65 dB	At least -65 dB
AUDIO OUTPUT	Balanced 600 ohm +10 dBm	Balanced 600 ohm +10 dBm
SQUELCH	Adjustable up to -50 dB S/N	Adjustable up to -50 dB S/N
RF FILTERING	Double shielding of RF and oscillator circuits	Double shielding of RF and oscillator circuits
METERING	2 Channels - RF input level and modulation	2 Channels - RF input level and modulation
POWER REQUIREMENTS	120 VAC 50/60 Hz, 25 watts	120 VAC 50/60 Hz, 25 watts
DIMENSIONS	Standard rack mount: Width - 19" (48.3 cm) Height - 3½" (8.9 cm) Depth - 11" (27.9 cm)	Standard rack mount: Width - 19" (48.3 cm) Height - 3½" (8.9 cm) Depth - 11" (27.9 cm)
WEIGHT	10 pounds	10 pounds
FINISH	McMartin beige with woodgrain trim	McMartin beige with woodgrain trim

RPU-1150Q & RPU-1450Q

**150 & 450 MHz CUE RECEIVERS ADAPTABLE TO RPU-1103 and RPU-1403,
3 WATT PORTABLE TRANSMITTERS**

**FOUR CHANNEL,
TWO BAND CAPABILITY**

SWITCHING DIODE TR SWITCH STANDARD

**ADDITIONAL CHANNELS FOR POLICE,
FIRE, & COMPETITION**

PIGGY-BACK TO RPU TRANSMITTER

McMartin's New Breed, the RPU cue receiver, is a piggy-back receiver which can be added to McMartin's RPU transmitters, the RPU-1103 and RPU-1403. These receivers come in two basic versions, one a 150 MHz unit with two channels and the other, a 450 MHz unit with two channels. The second channel is an additional cost item.

Provision has been made to incorporate into either version an additional front end circuit board which will

extend coverage by two channels to four channels. You may order either version with four channels, and it is possible to have cross band operation with two channels on 150 and two channels on 450. This allows the ENG crew to monitor any one of four different frequencies in either low band or high band channels. You can monitor local police, fire department channels, and competitor's RPU channels as well. This greatly adds to the versatility of the RPU transmitters with the addition of the RPU cue receiver.

SPECIFICATIONS

APPLICATION Sensitive, crystal controlled dual-conversion receiver with excellent voice quality and high audio output power intended for on-the-scene cueing (not for program material). An add-on piggy-back receiver for McMartin 3 watt transmitters.
FREQUENCY RANGE	RPU-1150Q: 150-172 MHz with 2 channel capability. RPU-1450Q: 450-456 MHz with 2 channel capability.
SENSITIVITY.....	.3 μ v for 20 dB quieting 150 MHz .5 μ v for 20 dB quieting 450 MHz
SELECTIVITY.....	... 6 dB @ \pm 10 kHz, 45 dB @ \pm 20 kHz; 1 volt on adjacent channel will not produce interference.
IF STAGES..... 10.7 MHz and 455 kHz with 455 kHz limiter and bandpass ceramic ladder filter.
AUDIO RESPONSE.... 50-5000 Hz \pm 2 dB (75 microsecond de-emphasis standard)
SQUELCH..... Smooth but positive acting RF level squelch with hysteresis to prevent jitter; no noise bursts
AGC.....	.. D-MOS FET RF amplifier provides the ultimate in low noise reception and provides 50 dB AGC range. Accommodates signal levels from .3 μ v to greater than one (1) volt without overloading.

AUDIO OUTPUT..... 2 watts into internal speaker; external 8 ohm output jack provided for phones or external speaker.
DISTORTION.....	Less than 5% @ 5 kHz deviation and 1 watt audio output.
POWER REQUIREMENT..... 35 MADC at 12 volts idle, 100 MADC average at normal listening levels derived from RPU transmitter battery pack.
ANTENNA..... Uses transmitter antenna by means of a solid-state pin-diode antenna switching network.
CIRCUITRY.....	3 IC's, 5 transistors (including 2 MOS FET's)
CONTROLS..... Volume, squelch, channel select, external output jack.
WEIGHT.....	.. Adds approximately 10 ounces to the RPU transmitter.
DIMENSIONS..... Replaces top cover of the RPU-1103 or 1403, adding 1" depth to the transmitter. Easy to field install on existing units

TVR-1/TV SCA RECEIVER

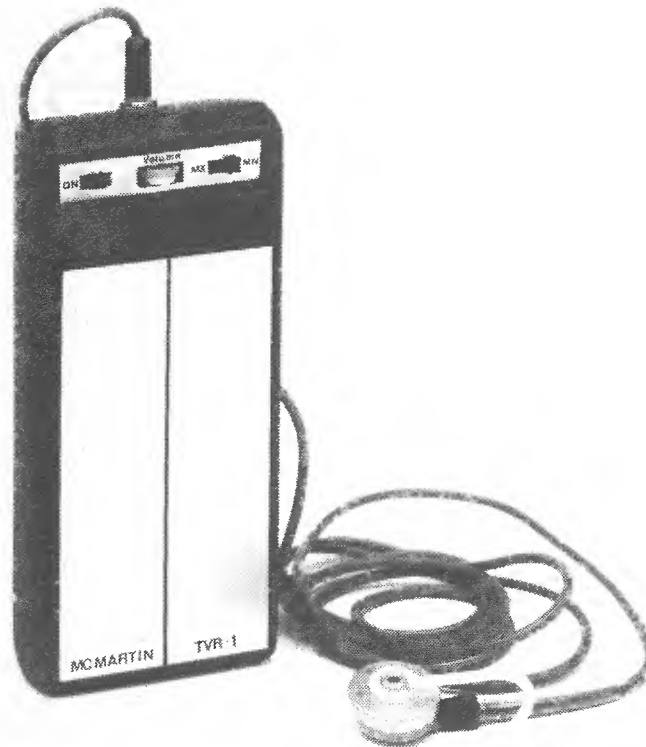

- HIGH SENSITIVITY**
- MAIN OR SCA OUTPUT**
- EARPHONE CORD ANTENNA**
- EXTREMELY RUGGED PLASTIC CASE**
- NEW PTD, PRECISE TRACKING DECODER**
- OPERATION ON CHANNEL 2-6 AND CHANNEL 7-13**
- CRYSTAL CONTROLLED ON DESIRED CHANNEL**

The new McMartin TVR-1, TV SCA pocket receiver is a high performance unit designed for cueing, paging, monitoring, etc., utilizing an SCA carrier on the aural TV carrier. The earphone cord has been RF isolated and designed as an integral part of the antenna system providing high RF pick up and good SCA reception under difficult conditions.

The TVR-1 receiver utilizes a new concept in receiver design providing space age technology in which the receiver actually tracks the modulated signal from the TV aural transmitter providing greater recovery of weak RF signals.

The RF section of the TVR-1 utilizes a diode protected dual gate D-MOS field effect transistor with a

very low noise figure. This device has very linear AGC control providing greater than 50 dB gain reduction resulting in an overall dynamic range of 100 dB which is very important as this receiver may be used in very close proximity to the TV transmitter.

An adjustable SCA squelch control is provided to quiet the receiver in the absence of the SCA carrier. A main or SCA slide switch is provided; also an adjustable volume control is used to set the level of the earphone audio to suit individual requirements.

The TVR-1, TV SCA receiver is designed to be readily attached around the waist by means of a cloth strap supplied.

TV AURAL CHANNEL

OPERATING FREQUENCY .. Channel 2-6 TV Aural Carrier. Channel 7-13 TV Aural Carrier.

SENSITIVITY:

Channel 2-6 0.5 microvolts for 20 dB quieting
Channel 7-13 1.6 microvolts for 20 dB quieting

ANTENNA Headphone cable RF isolated above ground and audio and tuned to desired channel.

SCA CHANNEL

FREQUENCY
DEVIATION 39.5 kHz or 67 kHz
39.5 kHz, +4 kHz deviation
67 kHz, ±6 kHz deviation
OUTPUT LEVEL Adjustable up to 1 volt across 600 ohm earphones

FREQUENCY
RESPONSE 100 to 3500 Hz
DISTORTION Less than 2%
DE-EMPHASIS Modified 150 microsecond

SENSITIVITY CHANNEL 2-6

39.5 kHz SCA CARRIER:
10% injection (±2.5 kHz dev. of aural carrier) 10 microvolts for 20 dB quieting.
20% injection (±5 kHz dev. of aural carrier) 5 microvolts for 20 dB quieting.

67 kHz SCA CARRIER:

10% injection (±2.5 kHz dev. of aural carrier) 13 microvolts for 20 dB quieting.
20% injection (±5 kHz dev. of aural carrier) 7.5 microvolts for 20 dB quieting.

SENSITIVITY CHANNEL 7-13

39.5 kHz SCA CARRIER:

10% injection (±2.5 kHz dev. of aural carrier) 18 microvolts for 20 dB quieting.
20% injection (±5 kHz dev. of aural carrier) 9.5 microvolts for 20 dB quieting.

67 kHz SCA CARRIER:

10% injection (±2.5 kHz dev. of aural carrier) 24 microvolts for 20 dB quieting.
20% injection (±5 kHz dev. of aural carrier) 12 microvolts for 20 dB quieting.

POWER SUPPLY REQUIREMENTS

BATTERY OPERATED 9.6 volts (standard transistor radio battery)

BATTERY DRAIN No signal 60 ma
High signal 45 ma

DIMENSIONS Height - 5" (12.7 cm)
Width - 2-3/16" (5.5 cm)
Depth - 1" (2.54 cm)

WEIGHT 6 ounces

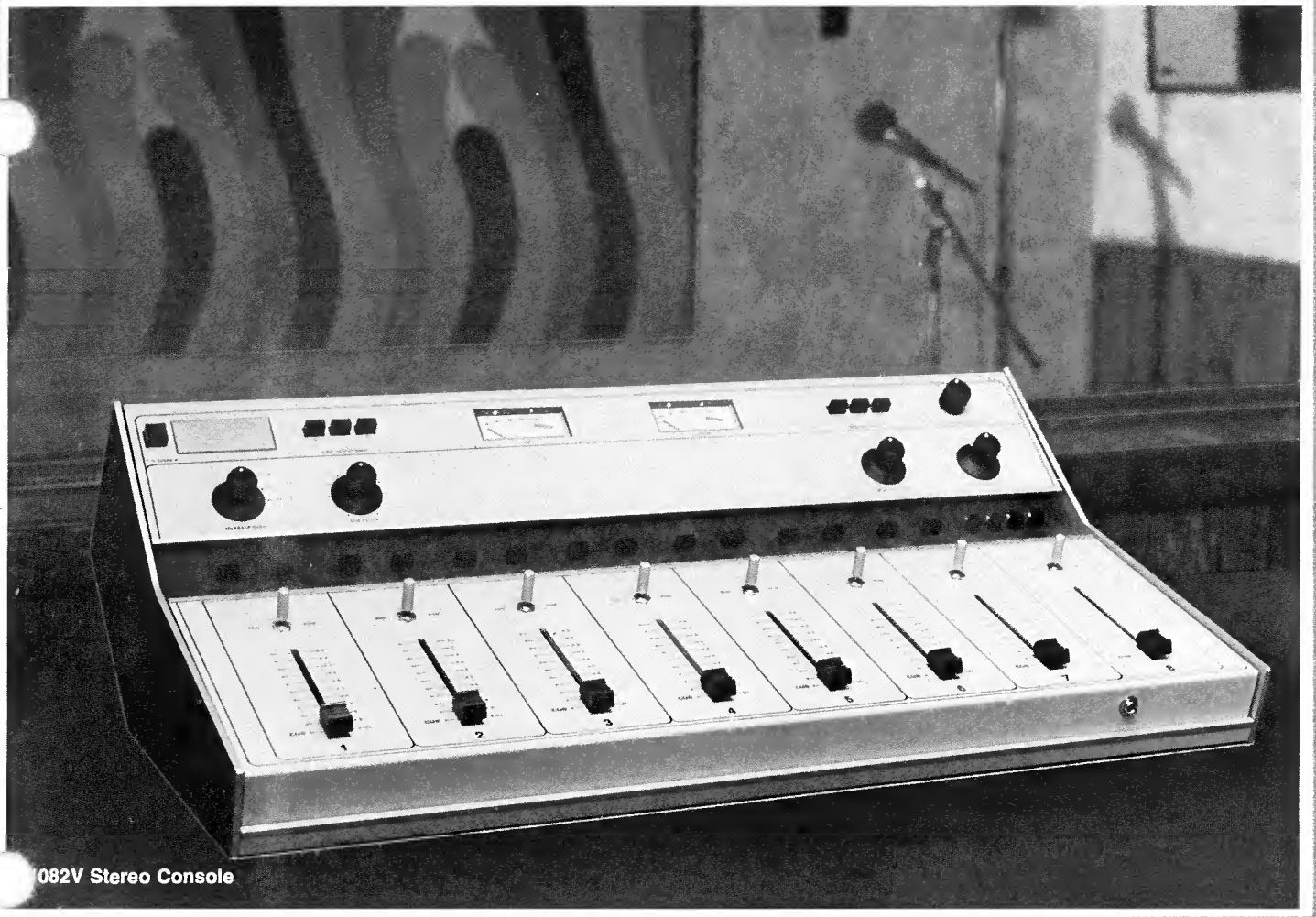

1082V Stereo Console

1000 series audio consoles

MCMARTIN

- 5 Channel Stereo / vertical attenuators**
- 8 Channel Stereo or Mono / vertical attenuators**
- 8 Channel Stereo or Mono / rotary attenuators**
- Gold plated PCB contacts**
- All channels convertible to MIC or HI level inputs**
- 15 watts • Monitor amplifier output**
- Headphone amplifier with volume control**
- Cue amplifier**
- External power supply**
- 10 inputs into 5 mixer (5 channel consoles)**
- 18 inputs into 8 mixer (8 channel consoles)**
- Audition output usable as 2nd program output**
- Cassette Input Jack 8-Channel Models**

The McMartin B-1000 Series of audio consoles is a new breed of human-engineered, easy-to-live-with consoles that last and last. Clean design keeps board operations tight and accurate. Clean construction and internal lay-out makes service, when required, fast and easy. Clean engineering assures you of a clean signal.

FIVE OR EIGHT CHANNELS

Plenty of inputs are provided for a variety of broadcast production needs. The eight channel models have 18 inputs while the five channel models provide for 10. This affords sufficient input selection for most of today's broadcast requirements.

VERTICAL OR ROTARY ATTENUATORS

Both mono and stereo versions come with either vertical, recording studio type slide attenuators or the more commonly used rotary attenuators. Because of the simplicity of design, if you want to switch from one attenuator type to the other, at a later date, it is easily accomplished.

ALL CHANNELS CONVERTIBLE

All channel positions can be converted to mic. or line inputs, the line inputs either balanced or unbalanced. Check the ordering information for the standard configuration of mic. and line inputs.

STEREO OR MONO

The design of the B-1000 Series was conceived with stereo performance in mind. Mechanically both stereo and mono units are the same. Many components, even in the mono models are stereo, such as switches, terminal strips and printed circuit card connectors. The enterprising station engineer, with little difficulty could convert a mono unit to stereo with little more than the purchase of stereo printed circuit cards.

HEADPHONE AMPLIFIER WITH VOLUME CONTROL

Headphone amplifier can be switched to monitor several console functions. Check the picture for the versatility provided.

FIFTEEN WATT MONITOR OUTPUT AMPLIFIER

Enough power for almost any monitor speaker is provided without requiring the use of an external monitor amplifier. The hybrid amplifier modules easily provide up to 15 watts per channel output.

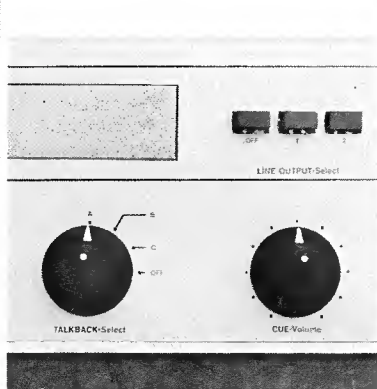

Cue and talkback controls

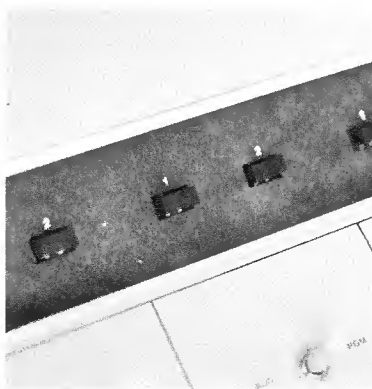

Pushbutton input select switches

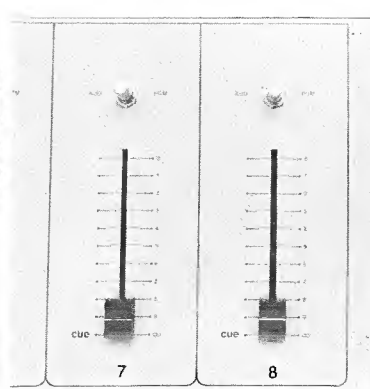

Slide attenuators, rotaries also available

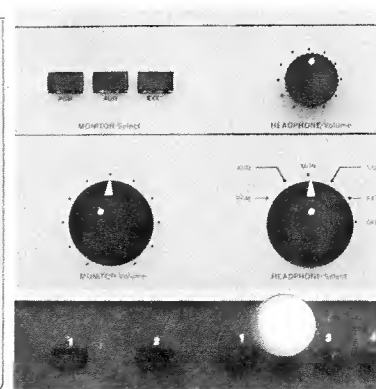

Monitor and headphone select controls

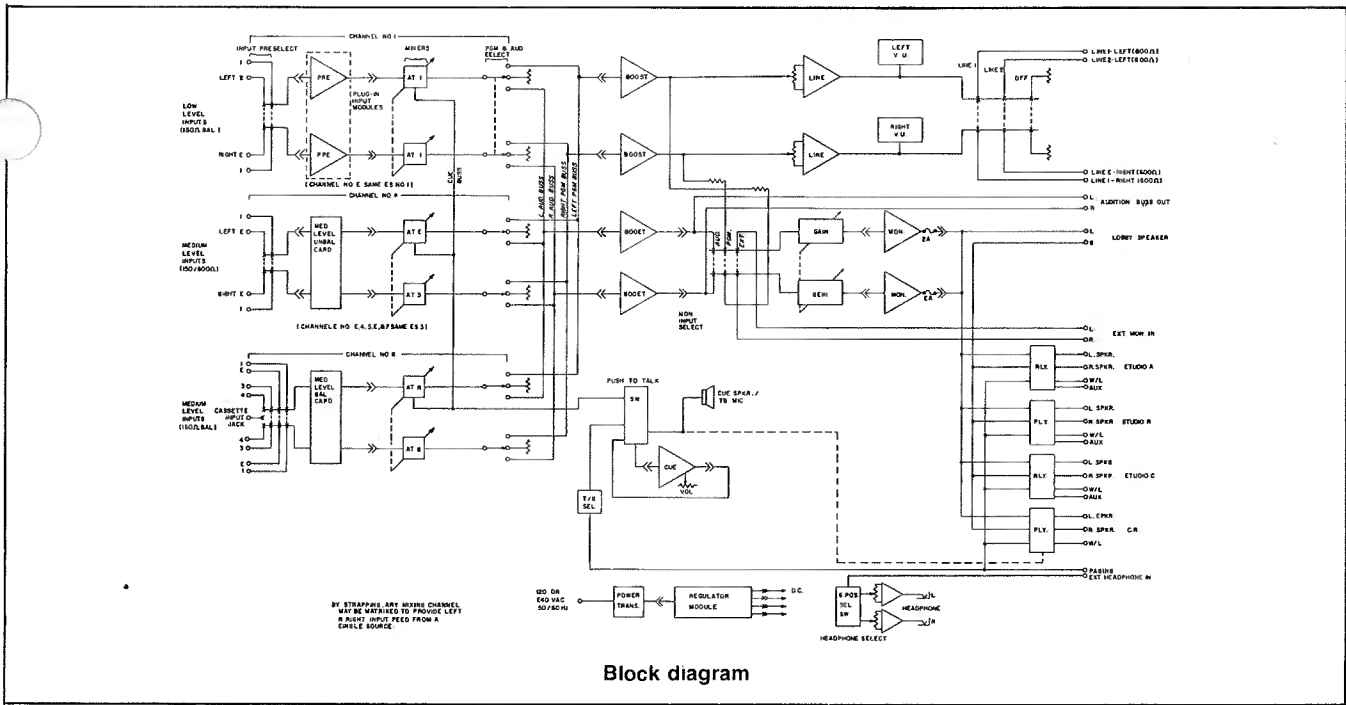

McMartin's B-1000 Series consoles offer plain and simple performance and reliability, but without gadgets, complexity or exotic appearance. The McMARTIN plain and simple philosophy makes McMARTIN consoles more versatile, easier to learn, and faster to service. They become a total tool for effective broadcasting, not a machine to be reckoned with. You don't have to worry about performance or reliability. McMARTIN engineering is state-of-the-art, plain and simple.

CUE AMPLIFIERS

Built in cue amplifier provides adequate volume for cueing purposes and cue is available on all channels.

AUDITION OUTPUT USEABLE AS SECOND PROGRAM OUTPUT

The audition output could be used as a program amplifier in an emergency situation. This makes your McMARTIN console more versatile.

PUSH-BUTTON INPUT SWITCHING

Pre-select from two input sources on each channel (channel eight has four inputs). On channels one, two and three, push-buttons can also assign control of speaker muting/warning light relays to the correct studio.

LOW PROFILE DESIGN

The industrial design of the B-1000 was conceived with the operator in mind. It is both attractive and yet easy to see and work with.

SIMPLE MODULAR DESIGN

Plain and simple design makes servicing simple and fast. Easy inter-changeability can keep you on the air.

GOLD PLATED CONTACTS AND TANTALUM CAPACITORS USED WHERE IT COUNTS

McMartin has chosen to use high quality components throughout the B-1000 Series. Gold plated contacts on printed circuit board plugs and sockets and tantalum capacitors show that this unit has been designed with quality in mind.

EXTERNAL POWER SUPPLY

The heavy duty external power supply has five separate fused lines. One AC primary line fuse, the four other separately fusing individual circuit groups. Should a failure occur in the monitor or cue amplifiers, program circuits will continue to function.

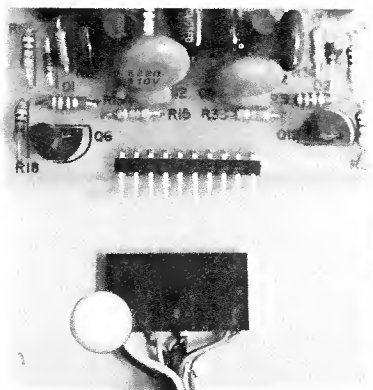

Quality components—
gold plated plug & sockets

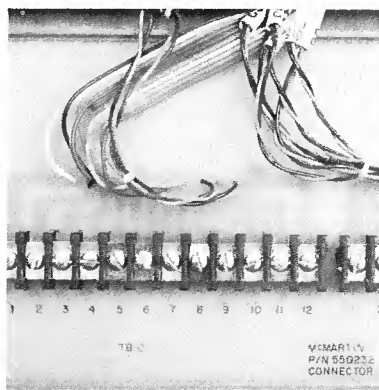

Terminal strip wiring of all inputs

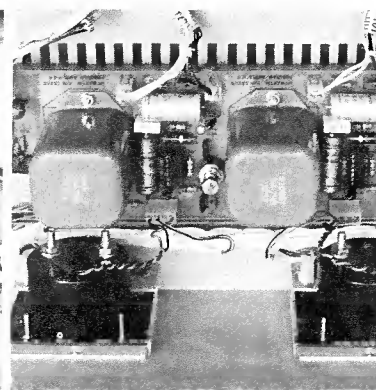

Program amplifier—
IC amplifiers quality transformers

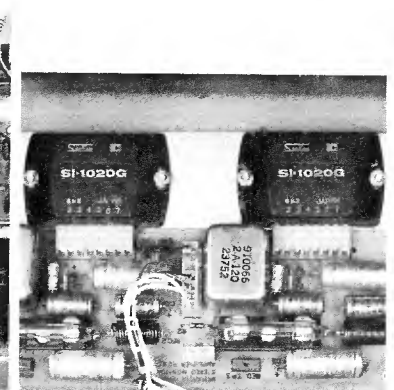

15 watt per channel
monitor amplifier

SPECIFICATIONS

PROGRAM CHANNELS (Mono, Left or Right)

FREQUENCY RESPONSE: ± .5 dB, 30 to 15,000 Hz
 ± 1 dB, 20 to 20,000 Hz

DISTORTION: 0.5% or less, 30 to 15,000 Hz
 1.0% or less 20 to 20,000 Hz @
 +18 dBm Output, produced by a -50
 dBm signal fed to any microphone input.

S/N RATIO:74 dB or greater below +18 dBm output,
 produced by a -50dBm signal fed to
 any microphone input with channel
 mixer and master gain control each
 set for approx. 12 dB attenuation.

OVERALL GAIN:95 dB±3 dB microphone input to
 line output

OUTPUT LEVEL: +8 dBm nominal, +28 dBm maximum

OUTPUT IMPEDANCE: 600 ohms balanced

INPUT LEVELS: MICROPHONE CHANNELS; -60 dBm
 nominal, -22 dBm maximum
 MEDIUM LEVEL CHANNELS; -15 dBm
 nominal, +20 dBm maximum

INPUT IMPEDANCES: MICROPHONE CHANNELS: 150 ohms
 balanced (50 or 600 ohms available
 by strapping) Unbalanced medium
 level channels: 600 ohms Balanced
 Medium Level Channels: 150 ohms
 balanced (600 ohms by strapping)

CROSSTALK: Below noise level

AUDITION BUS OUTPUT: +10 dBm unbalanced 600 ohms

MONITOR CHANNEL (Mono, Left or Right)

FREQUENCY RESPONSE: ± .5 dB, 50 to 15,000 Hz

HARMONIC DISTORTION: 0.5% or less 50 to 20,000 Hertz
 at full 15 watt output

S/N RATIO:80 dB below full output

OUTPUT IMPEDANCE: 4/8/16 ohms unbalanced

OUTPUT LEVEL: 15 watts rms

HEADPHONE AMP: 1 watt, 0.25% Distortion,
 Mono/Stereo

CUE AMPLIFIER: 1 watt - Mono only

FINISH: Upper and lower control panels are
 textured McMartin beige; center control
 panel and aluminum end panels have
 dark brown leather trim.

DIMENSIONS

8 Channel:30" (76.2 cm) width
 19½" (49.53 cm) depth
 10" (25.4 cm) height

5 Channel:19½" (49.53 cm) width
 19½" (49.53 cm) depth
 10" (25.4 cm) height

Power Supply:8" (20.32 cm) width
 13" (33.02 cm) depth
 5¼" (13.3 cm) height

SHIPPING WEIGHT

8 Channel:50 pounds (22.5 kg)

5 Channel:35 pounds (15.75 kg)

Power Supply:10 pounds (4.5 kg)

ORDERING INFORMATION

Model	Description	Product Code
1052V	5 Channel Stereo Vertical Attenuators CH 1, Microphone Input CH 2, 3, 4, HI Level Unbalanced Input CH 5, HI Level Balanced Input	10-02-146
1081	8 Channel Mono Rotary Attenuators CH 1, 2, Microphone Input CH 3, 4, 5, 6, 7 HI Level Unbalanced Input CH 8, HI Level Balanced Input	10-02-120
1081V	8 Channel Mono Vertical Attenuators CH 1, 2, Microphone Input CH 3, 4, 5, 6, 7, HI Level Unbalanced Input CH 8, HI Level Balanced Input	10-02-119
1082	8 Channel Stereo Rotary Attenuators CH 1, 2, Microphone Input CH 3, 4, 5, 6, 7, HI Level Unbalanced Input CH 8, HI Level Balanced Input	10-02-118
1082V	8 Channel Stereo Vertical Attenuators CH 1, 2, Microphone Input CH 3, 4, 5, 6, 7, HI Level Unbalanced Input CH 8, HI Level Balanced Input	10-02-117

REPLACEMENT PRINTED CIRCUIT CARDS for 1000 SERIES CONSOLES

Cue/Talkback Amplifier	10-02-124
Program Amplifier	10-02-125
Monitor Amp Stereo	10-02-126
Monitor Amp Mono	10-02-134
SANKEN Hybrid Module for use with MONITOR AMPS. Requires 1 Mono, 2 Stereo	
Stereo Mic PreAmp	10-02-130
Mono Mic PreAmp	10-02-135
Headphone Amplifier	10-02-129
Stereo HI Level Balanced Input	10-02-131
Mono HI Level Balanced Input	10-02-136
Mono or Stereo HI Level Unbalanced Input	10-02-132

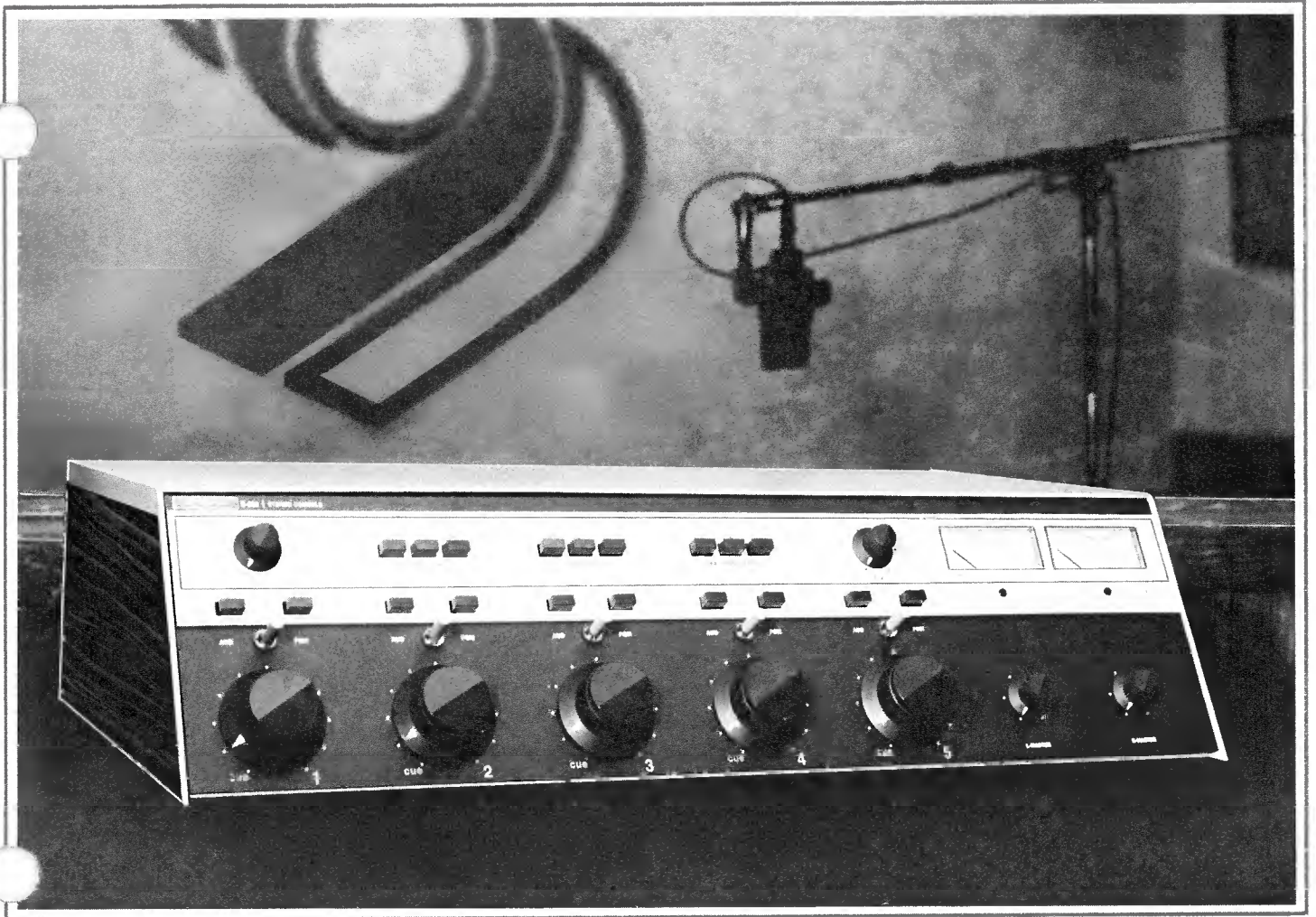

500 series audio consoles

MCMARTIN

**Compact Design Ideal for Production and
Small On-Air Studios As Well As Mobile Units**

Excellent Performance Specifications

Plug-in Modular Design

**Input Modules Available for:
Microphone and Balanced High-Level**

Standard Configuration One Microphone, Four Balanced High Level Inputs

Other Input Combinations by Simple Plug-in Module Substitution

Two Preselect Inputs Per Mixer

Four Watt rms Monitor Amplifier

Cue on All Mixers

Built-in Cue-Amplifier and Speaker

Speaker Muting for One Studio, Muting for Second Studio Optional

Functional, Large, Well Located Controls

Monaural, and Stereo Models

The McMartin B-500 series five-mixer audio consoles have been designed to provide for audio mixing and control for production and broadcasting application. Two models in the B-500 series are available, the B-501 monaural console and the B-502 stereo console.

B-500 series consoles provide five mixing channels, with switch selection of two inputs per mixer (a total of 10 inputs are provided). Each mixer output may be switched to the program or the audition busses of the console. Each mixer is provided with a detented counter-clockwise cue switch, to allow aural monitoring of any input channel by means of an integral 2-watt cue amplifier and built-in cue speaker. A front panel cue gain control is provided.

The five mixers are precision molded composition triple wiper attenuators which will typically operate for over 5 million operations without mechanical or electrical degradation. B-500 series five mixer consoles are available with step attenuators. These are identified by the basic model number plus the suffix "SA" for the step attenuator models.

Plug-in modules are used in the program and audition channels of the B-500 consoles. Input cards are available for microphone and for balanced high level inputs.

The use of these plug-in cards permits the user to tailor the console to his specific operating requirement. The standard models are supplied with one microphone preamplifier and four balanced high level input modules. Numerous other combinations are available as original purchase options or may be changed in the field at any time simply by unplugging one card, and plugging in the desired type input card.

The microphone preamplifiers accept low impedance balanced microphones of 150 ohm or 250 ohm impedance.

Balanced high level input cards are factory wired to accept 600 ohm balanced line inputs. Additional transformer taps accommodate 150 ohm or 50 ohm balanced inputs.

Each console is provided with a speaker muting/warning light relay for one location that operates in conjunction with the A input of mixer #1. Switching of that input to either the audition or the program bus will activate the relay. A prewired socket accepts an optional second relay for an additional location. It is connected to operate in conjunction with the B input of mixer #1. Spare contacts are available on all channel lever key switches, and on input select pushbuttons to allow extension of the muting/warning light relay control wiring to any or all other mixing channels.

All wiring connections to B-500 consoles are by means of rear panel mounted barrier type screw terminal strips. Space and cutouts are provided to allow field installation of two XLR-3 microphone connectors.

Convenient headphone jacks for monitoring are provided on both models, with front panel switch selection of the program, audition or cue busses.

The console outputs may be switched to two output lines or to an internal terminating load.

Program outputs are for 600 ohm balanced lines, and are at a + 8 dBm output level. Audition output levels, available to feed recording equipment, are 1.5V rms and can feed unbalanced 2.5K ohm loads.

B-500 series consoles represent the ultimate in flexibility, in a compact and attractive cabinet. They reflect the extensive professional-quality, audio experience of McMartin in the design and manufacture of broadcast audio consoles.

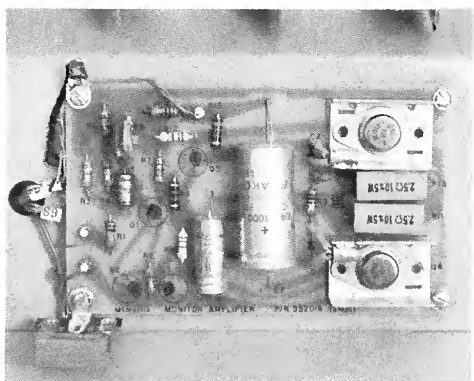
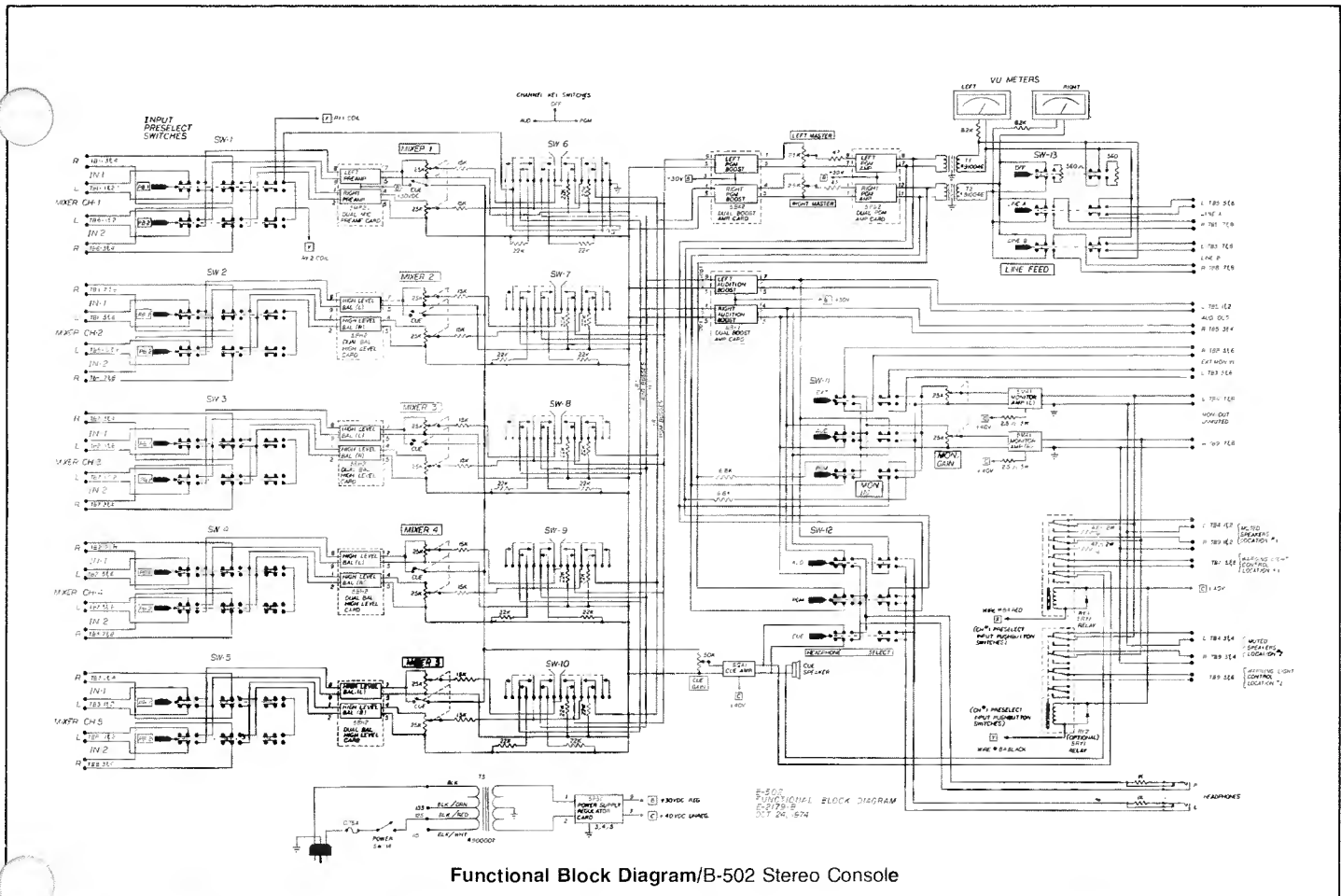

Monitor amplifier

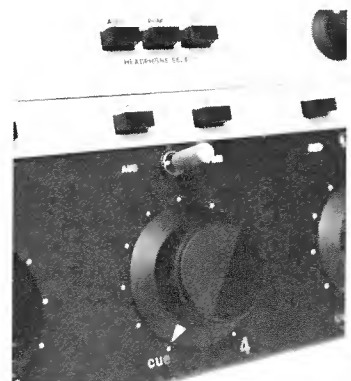

Attenuator, input and program audition select switches

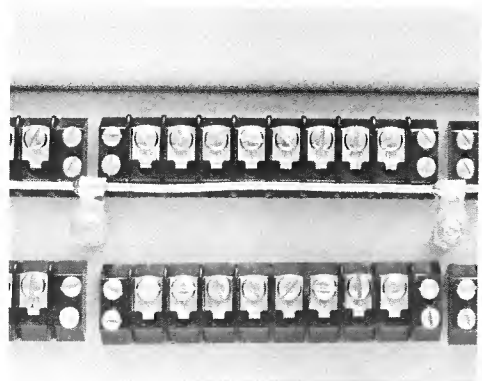

Screw terminal wiring of all inputs—no solder connections

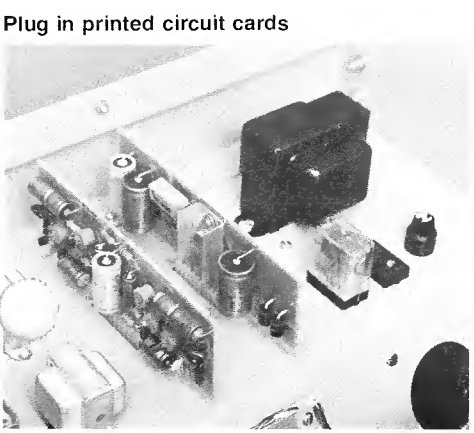

Plug in printed circuit cards

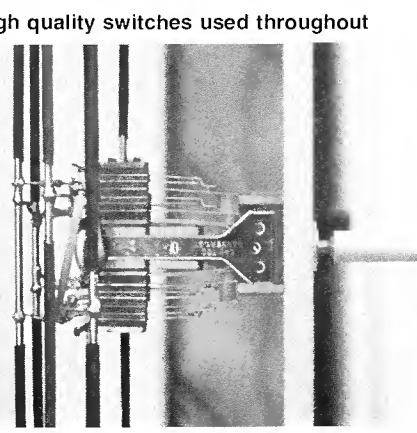

High quality switches used throughout

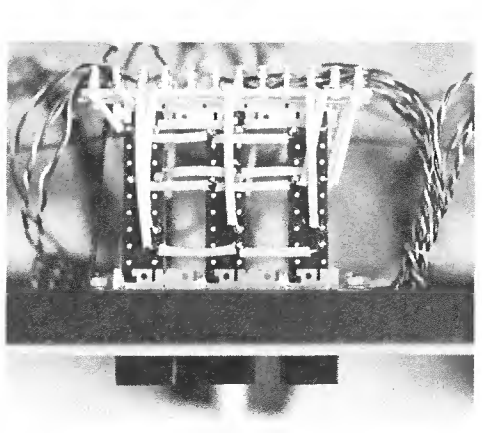

SPECIFICATIONS

PROGRAM CHANNEL(S)

Frequency response ±0.5 dB, 30-15,000 Hz
 Harmonic Distortion 0.5% or less, 30-15,000 Hz @ +18 dBm output
 S/N Ratio72 dB or greater below +18 dBm output with -50 dBm signal fed to microphone input

Crosstalk B501
 Monaural (audition to program) below noise level

B-502

Stereo (left channel to right channel to audition channel) below noise level
 Overall Gain 100 ± 2 dB
 Output Level +8 dBm for 0 VU meter reading +18 dBm capability

Input Levels

Microphone channels -60 dBm nominal, -34 dBm maximum
 High level channels -15 dBm nominal, +10 dBm maximum

Input Impedances

Microphone channels 150/250 ohms balanced
 High level50/150/600 ohms balanced
 Output Impedances 600 ohms balanced

AUDITION CHANNEL(S)

Output Impedance 2,500 ohms unbalanced
 Level 1.5 volts rms

MONITOR CHANNEL(S)

Frequency Response 1.0 dB, 30-15,000 Hz
 Harmonic Distortion 1.0% or less, 30-15,000 Hz @ 4 watts rms output
 S/N60 dB below 4 watts rms output (through program input)
 Output Level4 watts rms continuous; 8 watts normal program content

Output Impedance 4-16 ohms unbalanced

TERMINATIONS

Barrier screw terminals on rear; space and cutouts to mount two XLR-3 microphone connectors, McMartin Part Number 173003

POWER REQUIRED

.115/125/135 VAC 50/60 Hz (230 VAC on special order)
 B-501 40 watts, B-502 50 watts

DIMENSIONS

16" (40.6 cm) deep
 7" (17.8 cm) high
 27" (68.6 cm) wide

WEIGHT

.64 lbs.
 Shipping Weight 67 lbs.

FINISH

McMartin beige with matte black in mixer control area, wood grain end panels

ORDERING INFORMATION

- B-501** 5 Mixer Monaural Audio Console (one mic, four hi-bal input cards standard) **10-02-041**
- B-501SA** B-501 equipped with step attenuators **10-02-044**
- B-502** 5 Mixer Stereophonic Audio Console (One dual mic, four dual hi-bal input cards standard) **10-02-042**
- B-502SA** B-502 equipped with step attenuators **10-02-045**

Plug-in Input Cards for B-501;

- 5MP1** Plug-in Microphone Preamplifier **10-02-056**
- 5BH1** Plug-in Balanced High Level Input Card **10-02-054**

Plug-in Input Cards for B-502:

- 5MP2** Plug-in Balanced High Preamplifier **10-02-060**
- 5BH2** Plug-in Dual Balanced High Level Input Card **10-02-058**
- 5RY1** Speaker Muting Relay **10-02-064**

FIVE MIXER AUDIO CENTRAL CONTROL UNIT

ACCU-FIVE

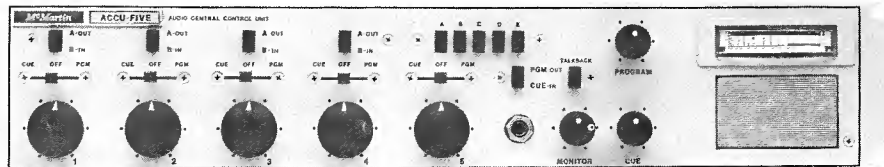

**FULL PROGRAM, MONITOR & CUE FACILITIES
ACCOMMODATES UP TO 13 MICROPHONE INPUTS
HIGH/LOW LEVEL INPUT SWITCHING ON 3 CHANNELS**

**ALL INPUTS TRANSFORMER ISOLATED
COMPLETELY SILICON SOLID STATE
CUE/TALKBACK CAPABILITY**

DESCRIPTION

The McMartin "Accu-Five" five channel mini-console is completely self-contained in a 3½-inch rack-mount unit.

Mixers 1 and 2 are designed to control low level microphone inputs with panel selection of two sources per channel. Loudspeaker muting associated with channel switching for these two mixers is provided.

Mixers 3 and 4 may accommodate either microphone or high level (as from tape devices, turntables, etc.) inputs by means of rear chassis switching. Mixer 5 accommodates five similar type inputs through pre-select pushbutton selection.

All input sources may be previewed by cue bus switching for each channel without disturbing the mixer control positions. A panel mounted cue speaker is driven by the internal cue amplifier. The latter also performs a second function. It serves as a talkback amplifier, permitting communication between the control room and studio. Provision is made for headphone monitoring of program or cue material. When the latter function is used, the cue speaker is muted.

The "Accu-Five", in spite of its compactness, retains truly professional operating parameters. Program output capability is +18dBm with ±1.0dB response and 0.5% or lower harmonic distortion, 30-15000Hz.

The monitor amplifier delivers 4.0 watts rms into an 8-ohm load with ±1.5dB response and 1.0% or less THD at full output, 50-15000Hz.

XL type microphone connectors are used for one each of the two microphone-level inputs to Mixers 1 & 2. All remaining input and output connections are made to screw-type terminals on the rear of the unit.

An illuminated VU meter calibrated for zero-VU deflection when +8dBm appears at the program channel output terminals, permits visual monitoring of the program material.

The "Accu-Five" is ideally suited for broadcast remote or production applications, educational broadcast or training purposes or as the audio complement to closed circuit TV operations.

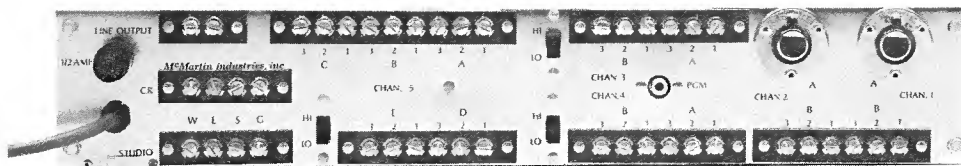

Rear View of ACCU-FIVE

SPECIFICATIONS

PROGRAM CHANNEL

Frequency response: ± 1.0 dB, 30-15,000 Hz

Harmonic distortion: 0.5% or less, 30-15,000Hz @ +18 dBm output and -50dBm signal to any low-level input

S/N ratio: 60dB below +8dBm output produced by -50dBm signal to any low-level input

Overall gain: 100, ± 2 dB

Input impedances: Low level mode: 150-ohms, balanced
High level mode: 600-ohms, balanced

Input levels: Low level mode: -60dBm nom; -35dBm max.
High level mode: -20dBm nom; +5dBm max.

Output: 600-ohms balanced (transformer isolated) +8dBm nom; +18dBm max.

CROSSTALK

(Cue to Program Channels): Below system noise

MONITOR CHANNEL:

Frequency response: ± 1.5 dB, 50-15,000 Hz

Harmonic distortion: 1.0% or less, 50-15,000 Hz @ full output

Output level: 4 watts, rms

Output impedance: 8 ohms, unbalanced

GENERAL:

Power requirements: 120/240 VAC, 60 Hz, 30 Watts

Dimensions: (W) EIA Standard 19" rack mount, (H) 3 1/2", (D) 10" overall

Weight: 12 pounds

Finish: McMartin Beige

ORDERING INFORMATION

Model	Description	Product Code
ACCU-FIVE	5 Channel rack mount mini-console	10-02-080
DTC-1	Cabinet for desk mounting	30-02-026

4-CHANNEL REMOTE AMPLIFIER

BR-400

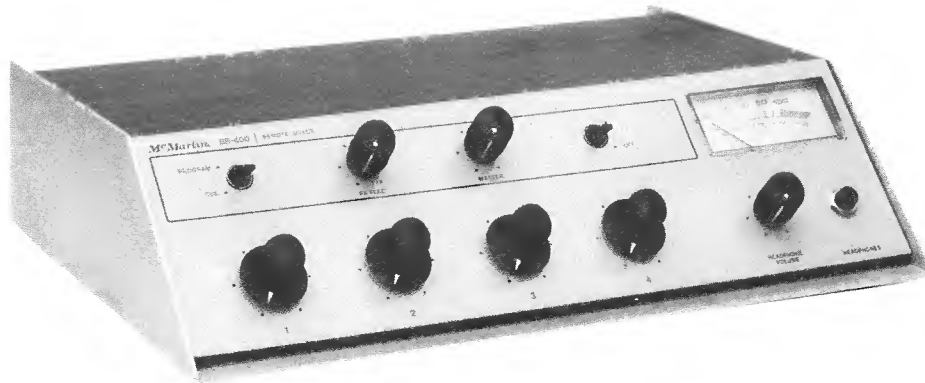

AC LINE/BATTERY OPERATION
RIAA PHONO OPTION — MIXERS #3 & #4
INBUILT TONE GENERATOR

PA FEED
COMPACT, LIGHTWEIGHT
HEADPHONE AMPLIFIER

DESCRIPTION

The McMartin Model BR-400 four-channel broadcast remote amplifier incorporates extreme flexibility in a lightweight portable package and meets today's stringent requirements for high quality remote broadcasting.

Basically, a four-channel, balanced low-impedance microphone mixer, two of the mixing channels are field convertible to RIAA equalized phono operation, or alternatively, to accommodate balanced line-level inputs. In addition to +8 dBm 600-ohm balanced output, visually-monitored by a front panel VU meter, a PA feed output with independent level control is provided. The BR-400 includes an internal 1000 Hz tone generator for presetting levels.

An isolated headphone amplifier with independent level gain control will accommodate low- as well as high-impedance headphones. This amplifier is

switchable to the incoming telephone line where used for remote "cueing" purposes.

The BR-400 is normally powered from 115 Vac power; however, it is designed to house an internal battery power supply with automatic changeover to battery operation in the event of a power line failure. The BR-400 dc supply consists of nine readily-available D-type cells. When rechargeable types are used, the BR-400 provides the means of recharging these by switch operation. Battery life permits approximately 100 hours of continuous operation, with half this time if the VU meter lamp, which may be switched off, is used continuously.

The complete assembly is housed in a durable aluminum enclosure. Ready access to batteries and circuitry is afforded by the hinged top cover/front panel construction.

MAR/76

SPECIFICATIONS

FREQUENCY RESPONSE	± 2.0 dB, 20-20,000 Hz (mic or line level input) (± 2.0 dB RIAA curve phono service)
TOTAL HARMONIC DISTORTION	0.5% or less, 20-20,000 Hz @ +8 dBm output
INPUT IMPEDANCES	150/250 ohms, balanced. Mixers #3 and #4 switchable to 47K-ohm RIAA mag. phono or 600 ohm balanced input.
INPUT LEVELS	- 60 dBm (microphone input) - 20 dBm (line input) 2.0 mV, equalized phono input
OUTPUTS	
Line out	+ 8 dBm nominal (+ 18 dBm max) 600 ohms balanced
PA Feed	0.5 volts rms max (adjustable) 5K-ohms unbalanced. (1.0 V into 25K-ohm or higher-Z load)
Headphone	+ 8 dBm max (adjustable) 600 to 20K-ohms unbalanced
HUM & NOISE	62 dB or greater below +8 dBm output (equivalent input noise -122 dBm)
OVERALL GAIN	90, ± 2, dB

POWER REQUIREMENTS	115 Vac, 50/60 Hz -or- 13 Vdc, 30 milliamperes, (80 ma with meter illuminated), from internal battery pack (nine D-type cells) or external supply
---------------------------------	---

FRONT PANEL CONTROLS	A. Mixer #1 through Mixer #4 B. Master gain control C. PA feed gain control D. Headphone level control E. Cue/program switch F. Power switch
-----------------------------------	---

REAR PANEL CONTROLS	A. Tone generator on/off B. RIAA Eq./flat response (Mixers #3 & #4) C. Mic/Line impedance (Mixers #3 & #4) D. Battery on/off charge E. Meter lamp on/off F. Battery test button
----------------------------------	--

DIMENSIONS	14" W x 3.5" H x 10.5" D (35.6 x 8.9 x 26.7 cm)
-------------------------	--

WEIGHT	6.5 pounds, 8.0 pounds with batteries
---------------------	---------------------------------------

FINISH	McMartin beige with woodgrain trim
---------------------	------------------------------------

ORDERING INFORMATION	
Model BR-400	4-channel remote amplifier (Supplied less D-cell batteries which are readily available in the field)

RIAA EQUALIZED PHONO PREAMP

B-200B



- MONO OR STEREO
- HI/LO FILTERS

- BALANCED OUTPUT

DESCRIPTION

The McMartin B-200 turntable preamplifier for use with either mono or stereo magnetic phono cartridge inputs is suitable for professional, high-performance applications.

The B-200 is completely self-contained. Its frequency response characteristics conform, within 1 dB, with the standard RIAA curve.

Its excellent stereo crosstalk performance is such

that a single B-200 unit may be used for preamplification of two separate mono sources. Both "high" and "low" filters may be switch selected. The "high" filter produces 15 dB attenuation at 20 kHz. The "low" filter attenuates 20 Hz signals by 10 dB.

Individual RCA phono input jacks are provided, with individual channel preset level controls. The outputs are terminated on barrier-type screw terminals.

SPECIFICATIONS

FREQUENCY RESPONSE	±1.0 dB of RIAA curve
DISTORTION	less than 0.25% at +8 dBm output; (20-20,000 Hz)
NOISE LEVEL	-108 dBm equivalent input noise at 1,000 Hz
CROSSTALK	-55 dB @ 15,000 Hz -65 dB or greater @ 1,000 Hz
INPUT IMPEDANCE47 K-ohms, resistive
INPUT SENSITIVITY	2.5 mV @ 1,000 Hz for +8 dBm output (overload: -20 dBV @ 1,000 Hz)
OUTPUT IMPEDANCE	600 ohms, balanced

OUTPUT LEVEL	+18 dBm, max.
HIGH FILTER ATTENUATION	-15 dB @ 20,000 Hz
LOW FILTER ATTENUATION	-10 dB @ 20 Hz
POWER REQUIREMENTS	115 Vac, 50/60 Hz, 5 watts
DIMENSIONS23 ³ / ₈ " H x 4 ¹ / ₈ " W x 11 ¹ / ₂ " D (6 x 10.5 x 29.2 cm)
SHIPPING WEIGHT4 pounds



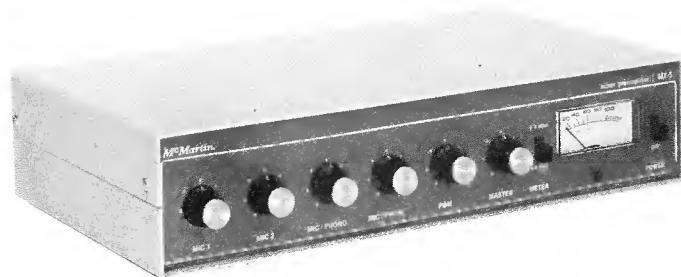

FOUR MICROPHONE & ONE PROGRAM INPUT CHANNEL

BUILT IN TONE GENERATOR

The McMartin Model MX-5 five-channel mixer/pre-amplifier is a high-quality, high performance unit offering excellent flexibility in the choice of input mixing functions required either for subsequent amplification in sound distribution systems, or for premixing for recording equipment with "line-level" input requirements.

Four balanced, low-level, low impedance inputs, terminated in female, XL-type connectors accommodate 150 ohm microphones. Any of these inputs, by change in internal jumper-plug orientation, may be modified to accept high-impedance, unbalanced microphones. In addition, two of the inputs may be modified for magnetic phono, RIAA equalized, service. By operation of a rear-panel slide switch, the first microphone input channel is converted to a 1000-Hertz tone generator. This permits prechecking of overall system operating levels.

The program-level input mixer accepts either low impedance balanced sources through rear-chassis screw terminals, or unbalanced 25K-ohm input through an RCA phono jack.

The level of the premixed inputs is controlled by a front-panel Master gain control. Output level from the MX-5 is monitored by an illuminated VU meter,

JUN/78

OPERABLE FROM EXTERNAL DC SUPPLY

TWO MIC CHANNELS CONVERTIBLE TO RIAA MAG PHONO SERVICE

with front-panel switching for "zero VU" meter indication of either +4 dBm or +8 dBm line level output levels.

600-ohm, transformer-isolated, balanced line output appears on rear-panel screw terminals. In addition, microphone level, at nominally -40 dBm, is terminated in a male XL-type connector; unbalanced 5K-ohm output appears on an RCA phono jack; and an isolated +18 dBm signal is brought out to a rear, standard 1/4-inch phone jack for headphone monitoring. Where desired, the MX-5 may be powered from a 36-volt 70-milliampere, external dc power supply—in lieu of the normal built-in MX-5 power supply which operates from a 120 Vac, 60 Hz power source.

The versatility of the MX-5 operation is enhanced by its compact packaging. The MX-5 is completely self-contained in an attractively-finished blue and silver gray, aluminum housing which is only 12 3/4" wide, 7 1/2" deep, with a low 2 3/4" profile.

The MX-5 is a quality instrument, using high-grade, long-life components, most of which are mounted on a single grade G-10, glass epoxy base, printed circuit board for ease of maintenance and servicing.

The MX-5 satisfies the requirement for professional, high quality and reliability sound installations.

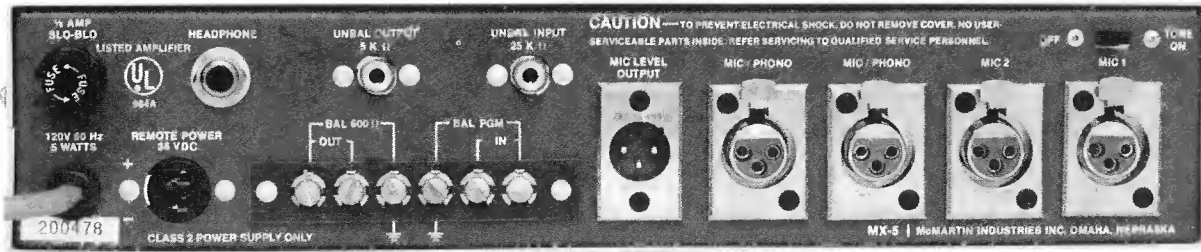

Rear View of MX-5

SPECIFICATIONS

INPUTS

Microphone Four (4) Total: Channel #1 switchable to operate as 1 kHz tone generator. Channels #3 and #4 switchable to RIAA equalized magnetic phono service, by simple internal plug reversal

Program One

INPUT IMPEDANCES

Mic Channels 50-150 ohms balanced; switchable to 25K-ohms unbalanced by internal jumper plug. Channels #3 and #4 switchable to 47K-ohms for magnetic phono service by internal plug reversal

Program Channel .. 600 ohms, balanced (matching) 10K-ohms, balanced (bridging); or 25K-ohms, unbalanced (bridging)

INPUT LEVELS

Mic Channels -60 dBV balanced; -28 dBV overload point; -55 dBV, unbalanced. Channels 3 & 4 in magnetic phono mode: 2 millivolts @ 1 kHz

Program Channel .. 600 ohms matching; or 10K-ohm bridging; or 100 millivolts, 25K-ohms, unbalanced

FREQUENCY RESPONSE

Mic Channels ±1.0 dB, 50-20,000 Hz, ±2.0 dB, 20-20,000 Hz; Channels #3 & 4 in magnetic phono mode: within 2.0 dB of RIAA curve

Program Channel .. ±0.5 dB, 50-20,000 Hz; ±1.0 dB, 20-20,000 Hz

NOISE

Mic Channels65 dB (wide band) and 72 dB (with 15 kHz low pass filter) below +8 dBm output, with 3.0 mV input signal. Equivalent Input Noise: -122 dBm. Channels #3 & 4 in magnetic phono mode: -55 dB.

Program Channel .. .80 dB (wide band) and 85 dB (w/15 kHz LP filter) below +18 dBm output.

OUTPUT IMPEDANCES & LEVELS

A) 600 ohms balanced: +4 dBm or +8 dBm nominal by front panel switching; +18 dBm maximum into 600-ohm load.
B) 5K-ohms, unbalanced (isolated) @ 3.0 volts. rms
C) 50/150 balanced: -45 dBm
D) Headphone jack: 600 ohms, unbalanced (isolated) @ +18 dBm

TOTAL HARMONIC & INTERMODULATION DISTORTION

..... 0.5% or less, 20-20,000 Hz @ +8 dBm output level; 1.0% or less, 20-20,000 Hz @ +18 dBm output level

FRONT PANEL CONTROLS

..... Mic #1/tone generator, Mic #2 level, Mic #3 & 4/equalized phono levels, Program level and Master gain

FRONT PANEL SWITCHES

..... Output level, +4 or +8 dBm; power on/off.

REAR PANEL SWITCHES:

..... Mic #1/Tone generator.

REAR PANEL TERMINATIONS

..... Channel #1 to #4 inputs, C1F connectors; Mic Level Output, C1M connector; Balanced program input and balanced 600-ohm output, screw terminals; unbalanced program input and 5K-ohm unbalanced output, RCA phono jack; 36-volt dc external power, two-pin Cinch Jones socket.

POWER REQUIREMENTS

..... 105/125 Vac, 50/60 Hz, 3 watts (Fuse: 1/8 ampere, slow-blow)

DIMENSIONS

..... 12 3/4" (32.4 cm) wide
2 3/4" (7.0 cm) height
7 3/4" (19.7 cm) deep

SHIPPING WEIGHT

..... .6 pounds

FINISH

..... McMartin blue and silver gray

ORDERING INFORMATION

Model Description Product Code
MX-5 5 channel mixer/preamplifier .. 20-04-045

MAP Multiple Access Processing

System Products

MCMARTIN

DISTRIBUTE AUDIO and DATA SIGNALS over INTERNAL AC POWER WIRING

- High Signal Quality
- Up to Six Channels of Simultaneous Communications
- Can be used for Audio and Data (computer) Signals
- Connects through Standard AC Wall Outlets

System Description

Multiple Access Processing, MAP, is a system developed by McMartin Industries for distributing high quality audio and data signals within a building using only the existing AC power distribution lines. MAP allows up to six channels to be used simultaneously (the exact number depends on conditions within the building). Each channel is suitable for background music, paging or emergency signals, or for digital data after it has been processed by a standard communications modem.

The MAP system utilizes four pieces of hardware. A *modulator* (CM-1) generates the basic frequency modulated RF signal and feeds it into the AC system of a building. A *demodulator* (CD-3), used at each receiving point, retrieves the audio or data signal. In many buildings *modulator/demodulator* units, (ABP-2)—which receive a signal at one frequency then reinsert it at another—or passive *By-pass Units*, may be required to maintain signal strength and to get around transformers, (which will not pass the RF signal.)

The MAP modulators and demodulators are connected to the AC system simply by being plugged into standard AC wall sockets. Each is designed to operate at any one of three switch selectable frequencies: 150 kHz, 200 kHz, or 250 kHz. Up to two different frequencies, separated by 100 kHz, may be injected into *each phase* of the power line. In a building with three phase wiring it is possible to distribute as many as six separate channels of audio or data information, although conditions within the electrical system of the building may reduce this number somewhat.

The excellent signal quality and multiple channel capability of MAP represents a major breakthrough in communications technology, and makes possible low-cost signal distribution even in large high-rise buildings.

MAP is perfect for background music, public address and paging systems, computer terminal hookup, emergency annunciators, etc. Scores of applications for high rise office and apartment buildings, schools, factories, nursing homes, hospitals. Already in use by one of the country's largest business information services.

CM-1 Modulator

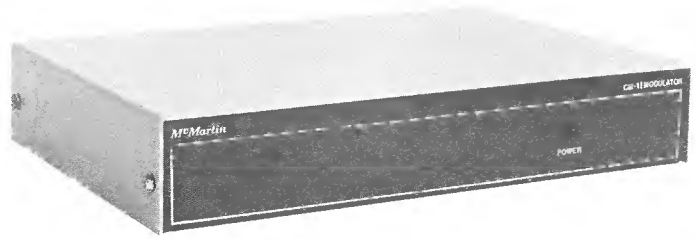

The CM-1 modulator is designed to accept audio or logic signals and transmit the processed information via a frequency modulated (FM) carrier through the AC distribution system of a building. The CM-1 need only be plugged into a standard AC wall socket.

The modulator is designed for continuous operation at full RF power output. The RC carrier level is adjustable so that the RF power is maintained at a level that does not exceed FCC radiation requirements.

SPECIFICATIONS

OPERATING FREQUENCY 150-200-250 kHz Switch selectable — 3 channels
FREQUENCY STABILITY ± 1 kHz, -10° to $+50^{\circ}$ C
TYPE OF MODULATIONFM modulation ± 20 kHz dev. — ref. 100% mod.
RF POWER OUTPUT Adjustable .1 to 5V RMS
FREQUENCY RESPONSE30-5000 Hz ± 2 dB (15,000 Hz optional)
INPUT LEVEL -10 dBm to $+10$ dBm for 100% modulation
FM SIGNAL TO NOISE RATIO -65 dB below 100% modulation
POWER REQUIREMENT 120 VAC, 60 Hz, 20 watts
DIMENSIONS Width 10.5" (26.6 cm) Height 1 $\frac{7}{8}$ " (5.0 cm) Depth 7" (17.8 cm)
Finish McMartin Blue and Grey

CD-3 Demodulator

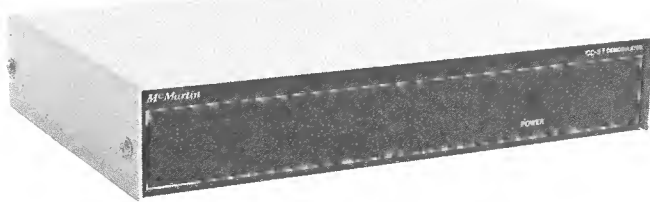

The CD-3 demodulator is designed to extract the small FM modulated signal super-imposed on the 60 Hz AC power distribution system. The demodulator receives, amplifies, hard limits, and demodulates the very low level carrier in the presence of normal 120 VAC (RMS) and line transient interference — sometimes as high as several hundred volts peak — and provides a signal output with low noise.

The input circuit has been designed to extract the FM signal from the AC power line with the minimum possibility of the AM components phase modulating the FM carrier.

The output signal is internally adjusted to the desired output level and can be set for any level from zero to +10 dBm. A rear chassis phone jack can be used to monitor the output signal with headphones of 500 ohm, or greater, impedance.

SPECIFICATIONS

OPERATING FREQUENCY150-200-250 kHz Switch selectable — 3 channel
FREQUENCY STABILITY(PLL) will track the desired carrier ± 20 kHz
AM REJECTION65 dB referenced from ± 20 kHz deviation of the carrier frequency
FM S/N RATIO65 dB or greater
FREQUENCY RESPONSE30-5,000 Hz ± 2 dB (15,000 Hz optional)
OUTPUT IMPEDANCEBalanced or unbalanced 600 ohm
OUTPUT LEVELAdjustable from zero to +10 dBm
RF CARRIER LEVEL TEST POINT Determines RF carrier input level zero — 2 VDC — complete limiting
POWER SUPPLY120 VAC 60 Hz, 5 watts
DIMENSIONSWidth 10.5" (26.6 cm) Height 1 $\frac{7}{8}$ " (5.0 cm) Depth 7" (17.8 cm)
FINISHMcMartin Blue and Grey

CR-1 "Desk-MAP" Receiver

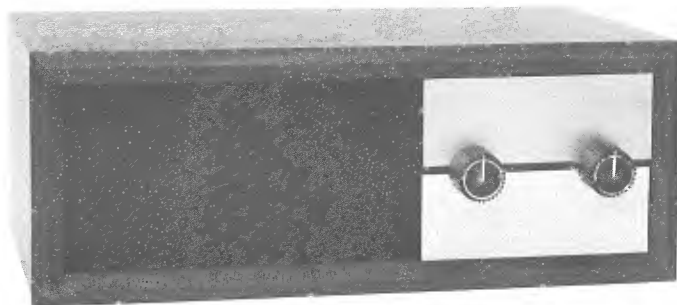

The CR-1 "Desk-MAP" Receiver is a combination demodulator-loudspeaker built into an attractive wooden desk top cabinet.

The unit is electronically similar to the CD-3 Demodulator and features a one-watt output amplifier and a three inch by five inch speaker. The front panel includes a combination on/off switch and volume control. The Desk-MAP is perfect for many applications in nursing homes, hospitals, and smaller offices where built-in speakers are not practical and where individual volume adjustments are desired.

SPECIFICATIONS

OPERATING FREQUENCY150-200-250 kHz Switch selectable — 3 channel
FREQUENCY STABILITY(PLL) will track the desired carrier ± 20 kHz
AM REJECTION65 dB referenced from ± 20 kHz deviation of the carrier frequency
FM S/N RATIO65 dB or greater
FREQUENCY RESPONSE30-5,000 Hz ± 2 dB (15,000 Hz optional)
OUTPUT IMPEDANCEBalanced or unbalanced 600 ohm
OUTPUT LEVELAdjustable from zero to +10 dBm
RF CARRIER LEVEL TEST POINT Determines RF carrier input level zero — 2 VDC — complete limiting
POWER SUPPLY120 VAC 60 Hz, 5 watts
DIMENSIONSWidth 10.5" (26.6 cm) Height 1 $\frac{7}{8}$ " (5.0 cm) Depth 7" (17.8 cm)
FINISHMcMartin Blue and Grey

ABP-2 Modulator/Demodulator

The APB-2 Modulator/Demodulator is designed to extract an FM modulated signal superimposed on the 60 Hz AC power distribution system and modulate another carrier of a different frequency which can be fed to another phase of the AC distribution system. The performance capabilities of the individual modulator and demodulator sections are similar to those of the CM-1 Modulator and CD-3 Demodulator, respectively.

The APB-2 carrier system modulator section is plugged into one phase of the AC distribution system through a standard wall socket, and the demodulator section is plugged into another phase. Two power cords are used.

SPECIFICATIONS

DEMODULATOR SECTION

OPERATING FREQUENCY150-200-250 kHz
FREQUENCY STABILITY(PLL) will track the desired carrier ± 20 kHz
AM REJECTION65 dB referenced from ± 20 kHz deviation of the carrier frequency
FM S/N RATIO65 dB or greater
FREQUENCY RESPONSE30-5000 Hz, ± 2 dB (15,000 Hz optional)
OUTPUT IMPEDANCEBalanced or unbalanced 600 ohm
OUTPUT LEVELAdjustable from zero to +10 dBm
RF CARRIER LEVEL TEST POINTDetermines RF carrier input level zero-2VDC — complete limiting

MODULATOR SECTION

OPERATING FREQUENCY150-200-250 kHz Switch selectable — 3 channels
FREQUENCY STABILITY ± 1 kHz, -10° to $+50^\circ\text{C}$
TYPE OF MODULATIONFM Modulation ± 20 kHz dev. — ref. 100% modulation
RF POWER OUTPUTAdjustable .1 to 6V RMS
FREQUENCY RESPONSE30-5000 Hz, ± 2 dB (15,000 Hz optional)
INPUT LEVEL-10 dBm to +10 dBm for 100% modulation
FM S/N RATIO-65 dB below 100% modulation
POWER REQUIREMENT120 VAC, 60 Hz, 20 watts
DIMENSIONSWidth 10.5" (26.6 cm) Height 1 $\frac{7}{8}$ " (5.0 cm) Depth 8" (20.3 cm)
FINISHMcMartin Blue and Grey

BP-2 By-Pass Unit

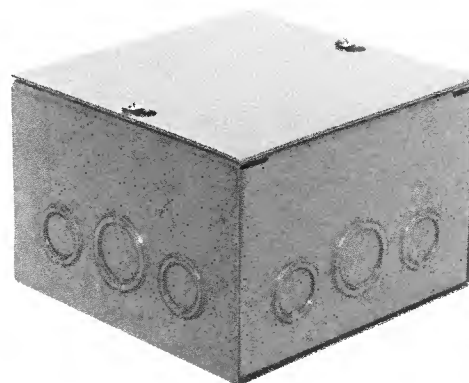

The BP-2 AC by-pass is designed to feed an RF carrier throughout a building by allowing the RF to be fed to the two or three phases in the AC distribution system in a building. The RF impedance is very low while the AC impedance is very high and does not disturb the AC system in any way.

The BP-2, AC by-pass can also be used to break up standing waves that can occur in large buildings where at the null point of the standing wave, the RF signal is zero. Simple insertion of the by-pass at several points will break up the phenomenon.

Unlike the other MAP system components, the BP-2 is packaged in a UL approved conduit box and is designed to be hard wired into the AC system.

SPECIFICATIONS

IMPEDANCE AT 200 kHzLess than 5 ohms
IMPEDANCE AT 60HzOver 200K ohms
PACKAGINGUL approval box with conduit knockouts
DIMENSIONSWidth 6" (15.2 cm) Height 4" (10.2 cm) Depth 6" (15.2 cm)

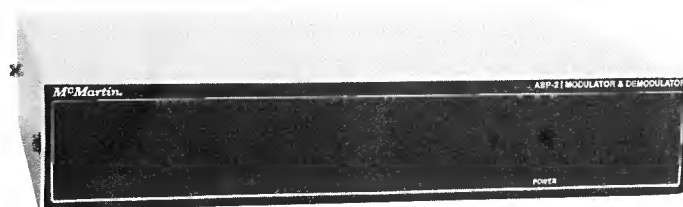

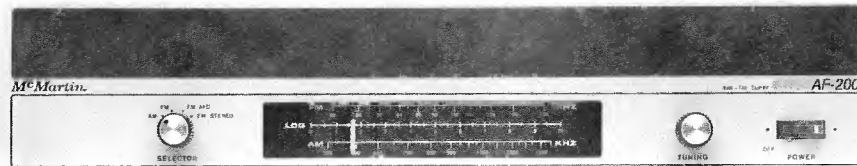

FM AFC
BETWEEN STATION FM SQUELCH
INDEPENDENT MONO/STEREO OUTPUTS
INTEGRATED CIRCUIT FM STEREO DECODER
INTEGRATED CIRCUIT FM IF AND DETECTOR WITH 10.7 MHz BLOCK FILTER

The AF-200 is a high performance, AM/FM/FM stereo, tuner. All silicon transistor and integrated circuit design insures long life and trouble-free performance over a wide range of ambient operating conditions. The FM AFC, regulated power supply and wide-range AGC circuits provide long term stability without readjustment regardless of signal, temperature, or line voltage variations.

The RF amplifier front-end on both the AM and FM sections of the tuner provides excellent selectivity, sensitivity, and rejection of spurious signals.

The high quality, 10.7 MHz IF filter, together with the integrated circuit 10.7 MHz IF amplifier and quadrature detector, provides not only excellent selectivity but also a very linear passband. This results in true high fidelity audio and excellent stereo separation.

The FM and AM mono signal audio output from the tuner board is fed through an additional amplifier and emitter follower stage to provide a high level 600 ohms output. The FM stereo audio outputs are fed through a 38 KHz LC filter after de-emphasis to eliminate any residual switching components from the stereo composite signal.

The AF-200 is attractively packaged in an all-aluminum chassis with 3½" E.I.A. standard rack mount front panel. The front panel is finished in McMartin beige textured enamel, with vinyl leather grain trim.

The AF-200 may also be housed in the McMartin DTC-1 cabinet for desk top mounting.

Front panel controls consist of an illuminated "on-off" rocker switch, function selector, tuning control, and a calibrated slide rule dial with logging and AM /FM frequency scales.



Rear view of AF-200

SPECIFICATIONS

	FM	AM
TUNING RANGE	88-108 MHz	540-1605 KHz
ANTENNA INPUT	300 ohms balanced (screw terminals)	High Impedance, unbalanced (screw terminals)
SENSITIVITY	3 μ V/30dB quieting	30 μ V/20dB S/N @ 30% modulation
SELECTIVITY	-3dB @ 200 KHz -35dB min @ 400 KHz	-10dB @ \pm 10 KHz
IMAGE REJECTION	-55dB	-35dB
SPURIOUS RESPONSE	-60dB	-30dB
HARMONIC DISTORTION	1% or less @ 100% modulation	3% or less @ 90% modulation 400 Hz
S/N RATIO	-55dB below 100% modulation with full limiting	-40dB below 30% modulation 5000 μ V input
AF RESPONSE	\pm 1dB 100-15,000 Hz	\pm 2dB 20-5000 Hz
AF OUTPUT (Mono)	1V rms @ 100% modulation 600 ohm load	0.5V rms @ 90% modulation 600 ohm load

	FM	AM
MUTE DEPTH (Squelch)	-50dB	—

	FM	AM
AF OUTPUT (Stereo)	0.15V rms @ 100% modulation 5000 ohm load	—

	FM	AM
STEREO SEPARATION	30dB minimum @ 1 KHz	—

	FM	AM
POWER REQUIRED	120V 50/60Hz, 5 watts	—

	FM	AM
DIMENSIONS	19 inches (48.3 cm) wide 3 1/2 inches (8.9 cm) high 8 1/2 inches (21.5 cm) deep	—

	FM	AM
REAR CHASSIS TERMINATIONS	Audio pin jacks Antennas screw terminals	—

	FM	AM
FINISH	McMartin beige with vinyl leather grain trim	—

	FM	AM
SHIPPING WEIGHT	5 pounds (2.2 kilograms)	—

ORDERING INFORMATION

AF-200	AM/FM/FM Stereo Tuner (Rackmount)	30-01-013
DTC-1	Desk Top Cabinet	30-02-026

TRANSISTOR AMPLIFIERS, 10-15 watts

**LT-80C
LT-108C**



LT-80C shown

10-15 WATTS RMS POWER OUTPUT

LOW PROFILE 3½" HIGH

BALANCED LOW Z MICROPHONE INPUT

MICROPHONE/PROGRAM INPUTS

BUILT-IN ELECTRONIC MUTING (LT-80C)

ELECTRONIC SHORT CIRCUIT PROTECTION

ALL SILICON DESIGN

SINGLE/DUAL RACK MOUNT OPTIONS



The LT-80C and 108C are conservatively rated wide power-bandwidth 10-15 watt rms audio amplifiers. They are designed for system sound applications requiring one microphone and one program source. As many as twenty speakers (tapped ½ watt) may be driven from the 25 or 70.7 volt balanced output, or a single four-ohm speaker system may be driven to a full 15 watts rms from the unbalanced output.

The microphone input is standard balanced low impedance 50/150 ohms with -60 dBm input sensitivity and 30 dB dynamic range. The microphone input is also convertible to high impedance unbalanced input. A three pin XL female connector is provided for microphone termination on the LT-80C. Screw terminal input connection is provided on the 108C.

The LT-80C features a fully electronic page mute system. Actuation of a simple single pole, single-throw switch closure at the microphone location automatically mutes the program channel and energizes the microphone channel for paging purposes. This switching operation is completely free of clicks and pops.

The program channel input is unbalanced 25K ohms with 300 millivolt sensitivity. An optional plug-in trans-

former card, Model MT-3, provides for balanced bridging input with sensitivity of -10 dBm. Input termination is either screw terminals or pin connector for the unbalanced inputs, and screw terminals for balanced input.

A 20 dB treble-cut tone control is provided for high-end roll off of the program channel. The microphone input is wired for 10 dB bass roll-off for crisp voice quality and may be field modified for flat response. On the LT-80C, the tone control is on the front panel and in the 108C, it is a front access, recessed screwdriver adjusted control. An optional gain limit control may be field installed to limit the range of the front panel controls.

Screw terminal output termination allows for connection of unbalanced loads from 4 to 16 ohms. Balanced 25 volt (62.5 ohm) and 70.7 volt (500 ohm) outputs are also provided. Continuous short circuit operation of any output will not damage transistors or the power supply.

Attractive, low profile packaging, with the capability of single or dual-unit optional rack mounts, make the LT-80C and 108C even more flexible in application.

MAR/78



Rear View, LT-80C

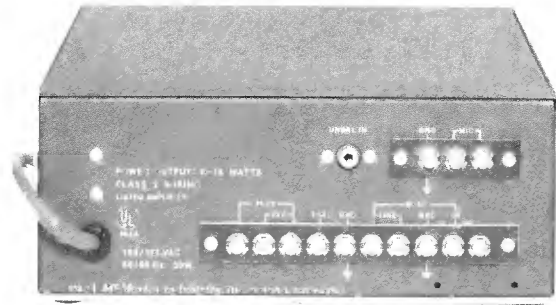

Rear View, 108C

SPECIFICATIONS

POWER OUTPUT:	10 watts rms—16 ohms unbalanced; 25/70.7 volt balanced line
.....	12.5 watts rms—8 ohms unbalanced
.....	15 watts rms—4 ohms unbalanced
FREQUENCY RESPONSE:	±1 dB, 50-15,000 Hz
DISTORTION:	1% or less, 50-20,000 Hz at 12.5W output
HUM & NOISE:	
MIC:60 dB below 10 watts output
PGM:70 dB below 10 watts output
OUTPUTS:4/8/16 ohms unbalanced; 25/70.7 volt balanced line
PROGRAM/LINE INPUT:25K-ohm unbalanced, 600 ohms balanced with optional MT-3 plug-in card
PROGRAM/LINE SENSITIVITY:300 millivolts, 25K ohm unbalanced input. -10 dBm (balanced 10K ohm bridging with MT-3 plug-in card.) 0 dBm (balanced 600-ohm matching with MT-3 plug-in card.)
OPERATING TEMPERATURE:	to 150°F (66°C)
OVERLOAD PROTECTION:	Solid state protection circuit samples output stage current and disables input signal during excessive loading condition
POWER REQUIRED:	120 Vac, 50/60 Hz, 30 watts (Primary taps for 105 and 125 Vac)
MIC INPUT:	150 ohms balanced
MIC TERMINATION:	
LT-80C	XL Connector
108C	Screw terminals

MUTING:	
LT-80C	Electronic muting of microphone and program circuits
108C	None

RESPONSE EQUALIZATION:	
LT-80C	Front panel treble cut tone control (-20 dB at 20 kHz) Microphone bass cut (-10 dB at 50 Hz). Flat response possible by change of one capacitor.
108C	Front panel screwdriver adjustment treble cut tone control (-20 dB at 20 kHz); Microphone bass cut (-10 dB at 50 Hz). Flat response possible by change of one capacitor.

DIMENSIONS:	8½"W x 7¼"D x 3½"H (21.6 cm W x 18.4 cm D x 8.9 cm H)
--------------------------	--

FINISH:	McMartin Blue and gray
----------------------	------------------------

SHIPPING WEIGHT:4 pounds (1.81 kg)
-------------------------------	---------------------

OPTIONAL ACCESSORIES:

MT-3	Plug-in program channel matching/bridging line input card
MRP-3	Single unit rack mounting kit 3½" x 19" EIA standard rack (8.8 cm H x 48.3 cm W)
MRP-4	Dual unit rack mounting kit (two units may be rack mounted, side by side) 3½" x 19" EIA standard rack (8.8 cm H x 48.3 cm W)

ORDERING INFORMATION

MODEL	DESCRIPTION	PRODUCT CODE
<input type="checkbox"/> LT-80C	10/15 watt amplifier	20-04-008
<input type="checkbox"/> LT-108C	10/15 watt amplifier	20-04-001
<input type="checkbox"/> MT-3	line input card	20-04-043
<input type="checkbox"/> MRP-3	single rack mounting kit	30-02-023
<input type="checkbox"/> MRP-4	dual rack mounting kit	30-02-024

All tests conducted in accordance with EIA Standard SE-101-A where applicable.

McMartin

25 WATT UNIVERSAL AMPLIFIER

LT-252B

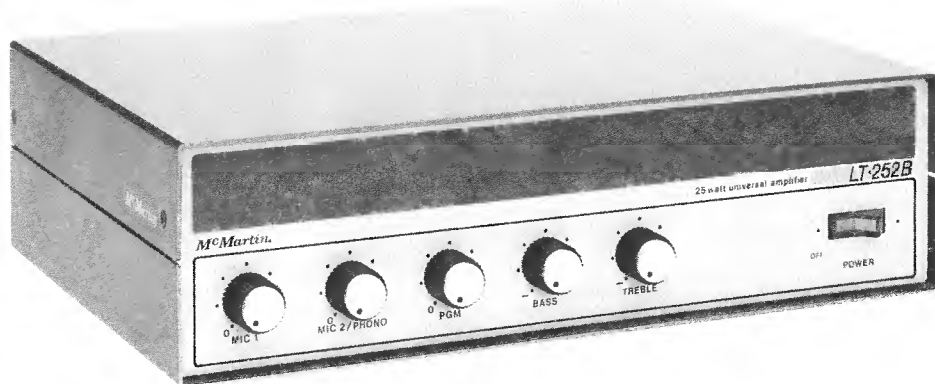

ONE LOW-Z MIC INPUT
ONE LOW-Z MIC/MAG PHONO INPUT
ONE HI-Z UNBALANCED PROGRAM INPUT
CONVERTIBLE TO LOW-Z BALANCED

TONE COMPENSATION
DESK MOUNT
EXCELLENT PERFORMANCE

DESCRIPTION

The McMartin LT-252B is a 25-watt rms silicon solid state amplifier designed for multiple input applications. It is completely self-contained and housed in an attractive cabinet suitable for desk top use.

The LT-252B accommodates two 150-ohm balanced microphone inputs through XLR type connectors and a medium level 25K ohm unbalanced program input. One of the microphone inputs may be converted to RIAA equalized magnetic phono service by simple insertion of the EPK-1 plug-in equalized phono kit. The program input can accommodate medium level, 600 ohm matching or 10K ohm bridg-

ing signal sources by addition of the optional plug-in MT-3 module.

Front panel tone compensation controls permit ± 15 dB treble and bass boost or cut.

The LT-252B is designed to feed 25- or 70.7-volt balanced; or 4- or 8-ohm unbalanced loads. Where applicable, direct coupled 4-ohm loads by-passing the output transformer provide ± 1.0 dB frequency response from 50 to 20,000 Hertz.

The LT-252B is conservatively designed to provide highly-reliable continuous service.

NOV/75

SPECIFICATIONS

POWER OUTPUT25 Watts rms 35 Watts music 50 Watts peak
FREQUENCY RESPONSE	
Microphone inputs ± 2.0 dB, 200-20,000 Hz, with 10 dB controlled low frequency roll-off. Convertible to ± 2 dB response, 40-20,000 Hz.
Program input ± 1.0 dB, 50-10,000 Hz; ± 1.0 dB, 50-20,000 Hz with 4-Ohm direct-coupled output.
Tone controlsTreble: ± 15 dB @ 15,000 Hz. Bass: ± 15 dB @ 50 Hz.
DISTORTIONLess than 1.0%, 50-10,000 Hz @ 25 W rms output and below
HUM AND NOISE	
Microphone inputs60 dB or greater below RPO with 3.0 millivolt reference input signal
Program input70 dB or greater below RPO
INPUT SENSITIVITY	
Microphone inputs-60 dBm
Program input0.4 volts unbalanced. With optional MT-3 plug-in card: 0 dBm, 600 ohms matching; or -10 dBm, 10K ohms bridging.
INPUTS	
MicrophoneTwo (2) 150 ohms balanced. One (1) input convertible to 47K ohm unbalanced RIAA equalized phono input (with optional EPK-1 Kit).

ProgramOne (1), 25K ohm unbalanced. Convertible to 600 ohm balanced matching, or 10K ohm balanced bridging (with optional MT-3 card).
OUTPUTS25- and 70.7-volts balanced; 4 or 8 ohms unbalanced. Unbalanced 4 ohm direct coupled output available on terminal strip.
CONTROLSTwo microphone gain; one program gain; one bass boost/cut; one treble boost/cut; illuminated power switch.
OPERATING TEMPERATUREFull performance specifications to 150° F. (65° C.).
POWER REQUIRED105-115/115-125 Vac, 50/60 Hz, 75W
DIMENSIONS3.5" (8.9 cm) high 12" (30.5 cm) wide 8.75" (22.3 cm) deep
WEIGHT7.5 lbs. Shipping weight, 10 lbs.
FINISHPanel, McMartin beige with leather grain trim. Cabinet, color — bronze metallic.

ORDERING INFORMATION

LT-252B25 watt rms universal amplifier
ACCESSORIES	
MT-3Plug-in 600 ohm/10K ohm transformer card
EPK-1Plug-in RIAA phono kit

ARCHITECTS' & ENGINEERS' SPECIFICATIONS

The amplifier shall be a McMartin LT-252B, or approved equal. It shall be of all silicon, solid state design and be capable of 25 watts rms, 35 watts music or 50 watts peak power output. Only amplifiers meeting all three wattage ratings will be accepted. The amplifier shall have a 1.0% or less total harmonic distortion when operated at rated power output level, or below. Frequency response through the microphone inputs shall be ± 2.0 dB or less over the range of 200 to 20,000 Hertz with provision by simple field alteration of extending the frequency range to cover 40 to 20,000 Hertz. One of the microphone channels, shall by installation of a simple plug-in adaptor, be converted to operation as an RIAA-equalized magnetic phono preamplifier. The frequency response of the program input channel shall be within ± 1.0 dB over the spectrum from 50 to 10,000 Hertz. The hum and noise level shall be 60 dB or greater below rated power output produced by a 3.0

millivolt reference input signal through either of the microphone channels. The hum and noise through the program input channel shall be 70dB or greater below the rated power output level. The amplifier shall permit ± 15 dB boost/cut at 15,000 Hz and 50 Hz by means of treble/bass front panel controls respectively. The amplifier shall have outputs of 4- and 8-ohms unbalanced and 25- and 70.7-volts balanced configuration. Rear panel termination of a 4-ohm direct coupled output shall be provided.

The amplifier shall be listed by Underwriters Laboratories and the Canadian Standards Association.

The amplifier front panel shall be finished in McMartin beige with leather grain trim, self-contained in an aluminum enclosure of bronze metallic finish, suitable for desk top use.

25 WATT POWER AMPLIFIER

LT-250C



- **LESS THAN 1% DISTORTION**
- **40 - 20,000 Hz FULL POWER FREQUENCY RESPONSE**
- **CURRENT SENSING OVERLOAD PROTECTION**
- **BALANCED 70.7 & 25 VOLT OUTPUTS**
- **BASS CUT SWITCH FOR HORN SPEAKER USE**
- **UNBALANCED 4, 8, & 16 OHM OUTPUTS**

DESCRIPTION

The LT-250C is a 25 watt rms silicon solid-state transistorized amplifier designed for low distortion output over a full power bandwidth of 40-20,000 Hz. The low frequency response of the amplifier can be extended to 20 Hz when operated with the field convertible direct coupled output.

This basic amplifier utilizes plug-connected circuit board construction, with power transistors and power supply components mounted and placed for maximum accessibility. Computer grade capacitors, and conservatively-rated transformers contribute to maximum performance and reliability.

The LT-250C accommodates either an unbalanced high impedance or a 600 ohm balanced program input. The balanced input utilizes a transformer, factory wired for 600 ohms matching. It is easily field modified for 10K ohms bridging without additional components.

The front panel program gain control may be transferred to the rear panel where that location is preferred.

The LT-250C amplifier features an overload protection, fast-acting current-limiting electronic circuit that automatically disables amplifier drive should a potentially harmful overload occur.

The LT-250C amplifier has 70.7 V and 25 V balanced outputs, plus 4, 8, and 16 ohm unbalanced outputs. Input and output connections are on convenient screw terminals.

The amplifier output may be directly coupled to an 8 ohm load. When so operated, the low-end frequency response is extended to 20 Hz.

A rear-panel mounted bass cut switch tailors the amplifier response (14 dB down at 100Hz) in installations where horn speakers are utilized.

The LT-250C, styled in McMartin beige with complementary leather grain accent, is designed for direct mounting in a 19" rack. An attractive desk top cabinet is available.

LT-250C — continuing the excellence in solid-state amplifiers pioneered by McMartin Industries.

NOV/75

SPECIFICATIONS

POWER OUTPUT25 watts rms 35 watts music 50 watts peak
FREQUENCY RESPONSE ± 1 dB 40-20,000 Hz ± 1 dB 20-20,000 Hz direct coupled output
DISTORTIONLess than 1% (40-20,000 Hz) at RPO and below
HUM AND NOISE (Program)85 dB below RPO
PROGRAM INPUTUnbalanced 25K ohms, and balanced 10K ohms bridging or balanced 600 ohms matching
INPUT SENSITIVITY0.4 volts unbalanced 0 dBm 600 ohms matching -10 dBm 10K ohms bridging
OUTPUTSBalanced 70.7 volts and 25 volts; Unbalanced 4, 8, and 16 ohms; Unbalanced 8 ohm direct output
CONTROLSProgram gain; power on/off

POWER REQUIRED105-115 Vac or 115-125 Vac 50/60 Hz 75 watts
DIMENSIONS3½" (8.9 cm) high 19" (48.3 cm) wide 5¾" (14.5 cm) deep
WEIGHT11 lbs. Shipping weight 13 lbs.
OPERATING TEMPERATUREFull performance to 150° F (65° C)
FINISHMcMartin beige with leather grain trim

ORDERING INFORMATION

LT-250C.....25 watt rms basic amplifier

ACCESSORIES

DTC-1 Desk top cabinet; 3½" (8.9 cm) high
19¼" (48.9 cm) wide
9¼" (23.5 cm) deep

All tests conducted in accordance with EIA Standard SE-101-A where applicable.

ARCHITECTS' & ENGINEERS' SPECIFICATIONS

The amplifier shall be a McMARTIN LT-250C, or approved equal. It shall be of all silicon solid-state construction and capable of 25 watts rms, 35 watts music, 50 watts peak power output. Only amplifiers meeting all three wattage ratings will be accepted. The amplifier shall have less than 1% distortion at rated output and below. The frequency response shall be ± 1 dB 40-20,000 Hz with a transformer output, and ± 1 dB 20-20,000 Hz with a field strappable direct 8-ohm output. The amplifier noise shall be at least 85 dB below signal at the rated power output. The amplifier shall be designed to operate continuously on line voltages of 105 to 125 Volts, 50/60 Hz over a temperature range of 0° to 150° F. (-18° C to 65° C). The amplifier shall be equipped with a current sensing overload protection circuit that will remove audio drive from the amplifier should an overload or short circuit develop. This protection circuit shall restore the amplifier in one millisecond when the short or overload is removed.

Only amplifiers offering this type of protective circuits shall be acceptable.

The amplifier shall be capable of accepting either a balanced or unbalanced program input without the installation of additional equipment. A transformer shall be permanently installed in the amplifier to accommodate 10K ohm and 600 ohm balanced line inputs, both matching and bridging shall be available. Screw terminals shall be provided for balanced inputs.

The amplifier shall have outputs of 4, 8, and 16 ohms unbalanced, and 70.7 V and 25 V balanced. The balanced circuits shall be capable of being balanced to ground, or floating balanced. A bass cut switch shall be provided that shall attenuate the bass in the output. A 14 dB cut at 100 Hz will be required. Screw type terminals shall be provided for all outputs. A direct coupled 8 ohm output shall be available by strapping the rear panel connector, and the direct coupled output shall provide extended low frequency response down to 20 Hz.

The amplifier shall be equipped with a program gain control, and an illuminated power on/off switch.

The amplifier shall have an unswitched 115 volt 3 wire grounded accessory outlet.

The amplifier shall be listed by Underwriters Laboratories and the Canadian Standards Association.

The amplifier shall be McMartin beige with a leather grain trim.

The amplifier shall be capable of being directly mounted in a 19" relay rack, and shall be supplied with, capable of being housed in a complementary appearing desk top housing.

50 WATT POWER AMPLIFIER

LT-500D

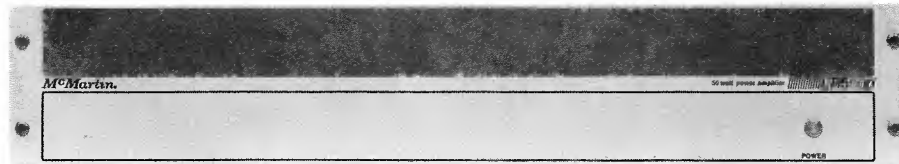

- 65 WATT RMS EIA RATING**
- 50 WATT RMS CONTINUOUS RATING**
- DUAL SLOPE LOAD LINE PROTECTION**
- CONSTANT CURRENT AND THERMAL BIAS STABILIZATION**
- LESS THAN 0.25% THD AT RATED OUTPUT 20-20,000 Hz ON DIRECT OUTPUT**
- LESS THAN 1% THD AT RATED OUTPUT 30-20,000 Hz ON 70.7 V LINE.**
- FULL PERFORMANCE OVER -40°C TO $+65^{\circ}\text{C}$ TEMPERATURE RANGE**
- SIMPLE, RUGGED CONSTRUCTION FOR LONG TERM RELIABILITY**
- LOW PROFILE $3\frac{1}{2}$ " PANEL HEIGHT**

The McMartin LT-500D is a professional quality power amplifier rated for continuous 50 watt rms output. This new D version amplifier is equipped with dual slope load line protection to protect the driver-output components and power supply during output shorts and overload, or input overdrive.

A low-cut filter provides a low frequency roll-off of 10 dB at 100 Hz to protect horn drivers from low frequency transients. Input provisions include a built-in balanced line input transformer for 600 ohm matching input or 10 K ohm bridging input.

Sufficient gain is provided to drive the amplifier to full output from a -20 dBm line level input. A 25 K ohm (nominal) unbalanced input is also provided for direct drive from unbalanced sources. A unique input pad configuration also permits balanced bridging input from balanced line sources up to 100 volts rms. This provides cascading of amplifiers for system expansion as a "booster" amplifier from the 70.7 volt system feed of another amplifier. Sound systems may therefore be expanded as buildings are enlarged without adding a "home run" line back to the central feed point, and without increased loading of the existing system. Removal of the front panel without exposure to live circuitry also permits easy mounting of the LT-500D

amplifier to a structure or enclosure other than a standard E.I.A. rack cabinet. Computer grade electrolytic capacitors and oversized transformers provide safe, full performance operation over a temperature range of -40°C to $+65^{\circ}\text{C}$.

Circuit design of the power amplifier section is also all new. The use of an integrated circuit predriver and dual slope load line protection network together with a conjugate full complimentary output section provides the ultimate in simplicity, ruggedness, and performance. The constant current biasing used in the predriver also maintains absolute AB_2 bias stabilization over extreme variations in power line voltage and temperature.

Installation and servicing of all "D" version amplifiers provides the ultimate in simplicity. The removable front panel provides ease of handling of the chassis assembly during rack mounting even if other units or panels are installed directly above and below the rack opening. This also provides access to the power supply components and output devices. Removal of the rear panel provides access to the circuit board, input transformer and other circuit components. This panel may be opened and locked in place for tests and servicing.



Rear View of LT-500D

SPECIFICATIONS

POWER OUTPUT

Direct Output	.50 watts rms 20-20,000 Hz at less than 0.25% THD (0.15% or less typical)
70.7 V Output	.50 watts rms 30-20,000 Hz at less than 1% THD (0.5% or less typical)

FREQUENCY RESPONSE:

Direct Output	±1 dB 20-20,000 Hz
70.7 V Output	±1 dB 30-20,000 Hz

INPUT SENSITIVITY

Unbalanced	.80 MV for RPO
Balanced 600 ohms or 10 K bridging	-20 dBm

HUM AND NOISE -80 dB below RPO
(-90 dB typical)

I.M. DISTORTION Less than 0.5% 100 MW to RPO

LOW CUT FILTER -3 dB @ 300 Hz
-10 dB @ 100 Hz
-20 dB @ 40 Hz

REGULATION:
70.7 V Output2 dB or less NL to FL
(1 dB typical)

OPERATING TEMPERATURE -40°C to +65°C

POWER REQUIRED .. .120 VAC nominal 50/60 Hz
90 W @ RPO, 20 W idle

INPUTS:

Unbalanced	.25 K ohms nominal
Balanced	.600 ohms matching or 10 K ohms bridging

OUTPUTS:

Unbalanced	.4 and 8 ohms
Balanced	.25 & 70.7 V

CONTROLS:

External	Input level
Internal	Lo Filter In-Out Bias Adjust

INDICATORS Power "on"

PROTECTION Electronic and 1.5 amp fuse

DIMENSIONS3.5" (8.9 cm) high
19" (48.3 cm) wide
8" (20.4 cm) deep

SHIPPING WEIGHT ... 15 lbs. (6.8 Kgms)

FINISH Beige front panel with leather
grain trim; caustic etched
aluminum chassis

ORDERING INFORMATION

MODEL	DESCRIPTION	PRODUCT CODE
LT-500D	50 Watt Power Amplifier	.30-01-014

All tests conducted in accordance with EIA Standard SE-101-A and SE-104 where applicable.

ARCHITECTS AND ENGINEERS SPECIFICATIONS

The power amplifier shall be a McMartin model LT-500D or approved equal, all silicon type, solid state amplifier. The amplifier shall have a continuous power output rating of 50 watts rms at less than 1% THD over the frequency range of 30 to 20,000 Hz with all components operating within safe limits. Reserve power shall be available to produce 65 watts rms from 50 to 15,000 Hz at less than 5% THD for use in commercial and industrial paging applications. The amplifier shall have a frequency response of ±1 dB 30-20,000 Hz and an input sensitivity of 80 MV unbalanced and -20 dBm balanced. Hum and noise shall be at least 80 dB below rated output. Intermodulation distortion from 100 MW to RPO shall be less than 0.5%. A low-cut filter shall provide at least 10 dB attenuation at 100 Hz and 20 dB at 40 Hz. Input impedance shall be unbalanced 25 K ohm and balanced 600 or 10,000 ohm bridging with built-in line

transformer. Output regulation shall be less than 2 dB no load to full load at RPO on the 70.7 V output. Controls for gain, low filter "IN-OUT" and a power "on" indicator shall be provided. Power requirements shall be 105 to 130 VAC, 50/60 Hz single phase and the amplifier shall draw no more than 20 watts with no input signal and 90 watts at 50 watts rms output. Outputs shall be 4 and 8 ohms unbalanced, and 25 and 70.7 volts balanced. Protection shall be load line limiting electronic protection and an AC line fuse for power supply protection. The shipping weight shall be 15 lbs. (6.8 Kgms). The amplifier shall be a standard 19 inch (48.3 cm) rack panel mounted, having a height of 3.5 inches (8.9 cm) and a depth of 8 inches (20.9 cm). Finish shall be McMartin beige with leather grain trim. Access to all components shall be available through removal of the front panel and rear chassis terminal cover.

75 WATT POWER AMPLIFIER

LT-750C

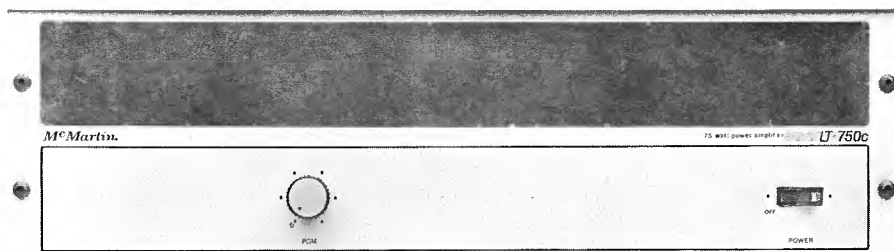

LESS THAN 1% DISTORTION
40 - 20,000 Hz FULL POWER
FREQUENCY RESPONSE
UNBALANCED 4, 8, & 16 OHM OUTPUTS

CURRENT SENSING OVERLOAD PROTECTION
BASS CUT SWITCH FOR
HORN SPEAKER USE
BALANCED 70.7 & 25 VOLT OUTPUTS

DESCRIPTION

The LT-750C is a 75 watt rms solid-state transistorized amplifier designed for low distortion output over a full power bandwidth of 40-20,000 Hz. The low frequency response of the amplifier can be extended to 20 Hz when operated with the field convertible direct coupled output.

The amplifier utilizes plug-connected printed circuit board construction, with power transistors and power supply components mounted and placed for maximum accessibility. Computer grade capacitors, conservatively-rated transformers and heat sinks contribute to maximum performance and reliability.

The LT-750C accommodates either an unbalanced high impedance or a balanced 600 ohm program input. The balanced input utilizes a transformer, factory wired for 600 ohms matching. It is easily field modified for 10K ohms bridging without additional components.

The front panel program gain control may be transferred to the rear panel where that location is preferred.

The LT-750C amplifier features an overload protection, fast-acting current-limiting electronic circuit that automatically disables amplifier drive should a potentially harmful overload occur. An

optional M-GUARD EF-3 electronic fuse is available to supplement the standard current sensing protective circuit. The M-GUARD upon sensing a fault, shuts down the amplifier power supply protecting the output devices in the amplifier. M-GUARD action is instantaneous and rapidly restores the amplifier to operation when the short or overload is removed.

The LT-750C amplifier has 70.7 V and 25 V balanced outputs, plus 4, 8, and 16 ohm unbalanced outputs. Input and output connections are on convenient screw terminals.

The amplifier output may be directly coupled to an 8 ohm load. When so operated, the low-end frequency response is extended to 20 Hz.

A bass cut switch tailors the amplifier response (14 dB down at 100 Hz) in installations where horn speakers are utilized.

The LT-750C amplifier, styled in McMartin beige with complementary leather grain accent, is designed for direct mounting in a 19" rack. An attractive desk top cabinet is available.

LT-750C — continuing the excellence in solid-state amplifiers pioneered by McMartin Industries.

NOV/75

SPECIFICATIONS

POWER OUTPUT75 watts rms 112 watts music 150 watts peak
FREQUENCY RESPONSE±1 dB 40-20,000 Hz ±1 dB 20-20,000 Hz direct coupled output
DISTORTIONLess than 1% (40-20,000 Hz) at RPO and below
HUM AND NOISE (Program)85 dB below RPO
PROGRAM INPUTUnbalanced 25K ohms and balanced 10K ohms bridging or balanced 600 ohms matching
INPUT SENSITIVITY0.4 volts unbalanced 0 dBm 600 ohms matching -10 dBm 10K ohms bridging
OUTPUTSBalanced 70.7 volts and 25 volts unbalanced 4, 8, and 16 ohms. Unbalanced 8 ohm direct output
CONTROLSProgram gain; power on/off
POWER REQUIRED105-115 Vac or 115-125 Vac or 125-135 Vac 50/60 Hz 200 watts

DIMENSIONS:..... 5¼" (13.3 cm) high
19" (48.3 cm) wide
9¼" (23.5 cm) deep

WEIGHT..... 24 lbs. Shipping weight 26 lbs.

OPERATING TEMPERATURE..... Full performance to 150° F (65° C)

FINISH..... McMartin beige with leather grain trim

ORDERING INFORMATION

LT-750C..... 75 watt rms basic amplifier

ACCESSORIES

EF-3..... M-GUARD electronic fuse

DTC-2..... Desk top cabinet; 5¼" (13.3 cm) high
19¼" (48.9 cm) wide
13½" (34.3 cm) deep

All tests conducted in accordance with EIA Standard SE-101-A where applicable.

ARCHITECTS' & ENGINEERS' SPECIFICATIONS

The amplifier shall be a McMARTIN LT-750C or approved equal. It shall be of all silicon solid-state construction and capable of 75 watts rms, 112 watts music, 150 watts peak. Only amplifiers meeting all these wattage ratings will be accepted. The amplifier shall have distortion less than 1% at rated output and below. The frequency response shall be ±1 dB 40-20,000 Hz with transformer output, and ±1 dB 20-20,000 Hz with field strappable direct output. The amplifier noise shall be at least 85 dB below signal at the rated power output. The amplifier shall be designed to operate continuously on line voltages of 105 to 125 Volts, 50/60 Hz over a temperature range of 0° to 150 F. (-18° C to 65° C). The amplifier shall be equipped with a current sensing overload protection circuit that will remove audio drive from the amplifier should an overload or short circuit develop. This protection circuit shall restore the amplifier in one millisecond when the short or overload is removed. The amplifier shall optionally accommodate an all solid-state electronic protection circuit that will shut down the amplifier power supply should an overload or short circuit occur. This optional protective circuit will rapidly restore the amplifier to operation after the short or overload is removed. Only amplifiers offering the capability of both types of protective circuits shall be acceptable.

The amplifier shall be capable of accepting either a balanced or unbalanced program input without the installation of additional equipment. A transformer shall be permanently installed in the amplifier to accommodate 10K ohm and 600 ohm bal-

anced line inputs, both matching and bridging shall be available. Screw terminals shall be provided for balanced inputs.

The amplifier shall have outputs of 4, 8, and 16 ohms unbalanced, and 70.7 V and 25 V balanced. The balanced circuits shall be capable of being balanced to ground, or floating balanced. A bass cut switch shall be provided that shall attenuate the bass in the output. A 14 dB cut at 100 Hz will be required. Screw terminals shall be provided for all outputs. A direct coupled 8 ohm output shall be available by strapping the rear panel connector, and the direct coupled output shall provide extended low end frequency response down to 20 Hz.

The amplifier shall be equipped with a program gain control, and an illuminated on/off switch.

The amplifier shall have an unswitched 115 Volt 3 wire grounded accessory outlet.

The amplifier shall be listed by Underwriters Laboratories and the Canadian Standards Association.

The amplifier shall be McMartin beige with a leather grain trim.

The amplifier shall be capable of being directly mounted in a 19" relay rack, and shall be supplied with, capable of being housed, in a complementary appearing desk top housing.

100 WATT POWER AMPLIFIER

LT-1000D

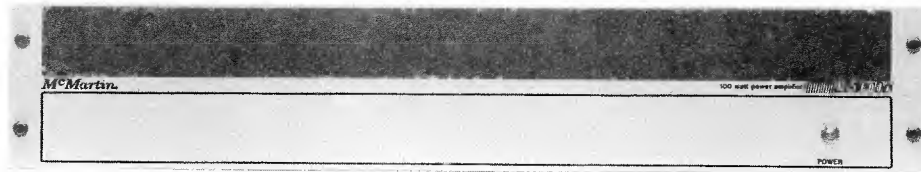

- 125 WATT RMS EIA RATING**
- 100 WATT RMS CONTINUOUS RATING**
- DUAL SLOPE LOAD LINE PROTECTION**
- CONSTANT CURRENT AND THERMAL BIAS STABILIZATION**
- LESS THAN 0.25% THD AT RATED OUTPUT 20-20,000 Hz ON DIRECT OUTPUT**
- LESS THAN 1% THD AT RATED OUTPUT 30-20,000 Hz ON 70.7 V LINE.**
- FULL PERFORMANCE OVER -40°C TO +65°C TEMPERATURE RANGE**
- SIMPLE, RUGGED CONSTRUCTION FOR LONG TERM RELIABILITY**
- LOW PROFILE 3½" PANEL HEIGHT**

The McMartin LT-1000D is a professional quality power amplifier rated for continuous 100 watt rms output. This new D version amplifier is equipped with dual slope load line protection to protect the driver-output components and power supply during output shorts and overload, or input overdrive.

A low-cut filter provides a low frequency roll-off of 10 dB at 100 Hz to protect horn drivers from low frequency transients. Input provisions include a built-in balanced line input transformer for 600 ohm matching input or 10 K ohm bridging input.

Sufficient gain is provided to drive the amplifier to full output from a -20 dBm line level input. A 25 K ohm (nominal) unbalanced input is also provided for direct drive from unbalanced sources. A unique input pad configuration also permits balanced bridging input from balanced line sources up to 100 volts rms. This provides cascading of amplifiers for system expansion as a "booster" amplifier from the 70.7 volt system feed of another amplifier. Sound systems may therefore be expanded as buildings are enlarged without adding a "home run" line back to the central feed point, and without increased loading of the existing system. Removal of the front panel without exposure to live circuitry also permits easy mounting of the LT-1000D

amplifier to a structure or enclosure other than a standard E.I.A. rack cabinet. Computer grade electrolytic capacitors and oversized transformers provide safe, full performance operation over a temperature range of -40°C to +65°C.

Circuit design of the power amplifier section is also all new. The use of an integrated circuit predriver and dual slope load line protection network together with a conjugate full complimentary output section provides the ultimate in simplicity, ruggedness, and performance. The constant current biasing used in the predriver also maintains absolute AB₂ bias stabilization over extreme variations in power line voltage and temperature.

Installation and servicing of all "D" version amplifiers provides the ultimate in simplicity. The removable front panel provides ease of handling of the chassis assembly during rack mounting even if other units or panels are installed directly above and below the rack opening. This also provides access to the power supply components and output devices. Removal of the rear panel provides access to the circuit board, input transformer and other circuit components. This panel may be opened and locked in place for tests and servicing.

CT/78

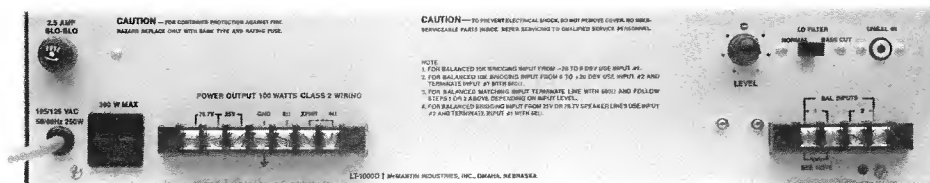

Rear View of LT-1000D

SPECIFICATIONS

POWER OUTPUT		INPUTS:		
Direct Output	100 watts rms 20-20,000 Hz at less than 0.25% THD (0.15% or less typical)	Unbalanced25 K ohms nominal	
70.7 V Output	100 watts rms 30-20,000 Hz at less than 1% THD (0.5% or less typical)	Balanced600 ohms matching or 10 K ohms bridging	
FREQUENCY RESPONSE:		OUTPUTS:		
Direct Output	±1 dB 20-20,000 Hz	Unbalanced4 and 8 ohms	
70.7 V Output	±1 dB 30-20,000 Hz	Balanced25 & 70.7 V	
INPUT SENSITIVITY		CONTROLS:		
Unbalanced80 MV for RPO	External	Input level	
Balanced 600 ohms or 10 K bridging	-20 dBm	Internal	Lo Filter In-Out Bias Adjust	
HUM AND NOISE		INDICATORS	Power "on"	
-80 dB below RPO (-90 dB typical)		PROTECTION	Electronic and 2.5 amp fuse	
I.M. DISTORTION		DIMENSIONS	3.5" (8.9 cm) high 19" (48.3 cm) wide 8" (20.4 cm) deep	
Less than 0.5% 100 MW to RPO		SHIPPING WEIGHT20 lbs. (9.2 Kgms)	
LOW CUT FILTER		FINISH	Beige front panel with leather grain trim; caustic etched grain aluminum chassis	
-3 dB @ 300 Hz -10 dB @ 100 Hz -20 dB @ 40 Hz		ORDERING INFORMATION		
REGULATION:		MODEL	DESCRIPTION	PRODUCT CODE
70.7 V Output2 dB or less NL to FL (1 dB typical)	LT-1000D	100 Watt Power Amplifier	.30-01-015
OPERATING TEMPERATURE		<i>All tests conducted in accordance with EIA Standard SE-101-A and SE-104 where applicable.</i>		
-40°C to +65°C				
POWER REQUIRED				
120 VAC nominal 50/60 Hz 190 W @ RPO, 25 W idle				

ARCHITECTS AND ENGINEERS SPECIFICATIONS

The power amplifier shall be a McMartin model LT-1000D, or approved equal, all silicon type, solid state amplifier. The amplifier shall have a continuous power output rating of 100 watts rms at less than 1% THD over the frequency range of 30 to 20,000 Hz with all components operating within safe limits. Reserve power shall be available to produce 125 watts rms from 50 to 15,000 Hz at less than 5% THD for use in commercial and industrial paging applications. The amplifier shall have a frequency response of ±1 dB 30-20,000 Hz and an input sensitivity of 80 MV unbalanced and -20 dBm balanced. Hum and noise shall be at least 80 dB below rated output. Intermodulation distortion from 100 MW to RPO shall be less than 0.5%. A low-cut filter shall provide at least 10 dB attenuation at 100 Hz and 20 dB at 40 Hz. Input impedance shall be unbalanced 25K ohm and balanced 600 or 10,000 ohm bridging with built-in line

transformer. Output regulation shall be less than 2 dB no load to full load at RPO on the 70.7 V output. Controls for gain, low filter "IN-OUT" and a power "on" indicator shall be provided. Power requirements shall be 105 to 130 VAC, 50/60 Hz single phase and the amplifier shall draw no more than 25 watts with no input signal and 190 watts at 100 watts rms output. Outputs shall be 4 and 8 ohms unbalanced, and 25 and 70.7 volts balanced. Protection shall be load line limiting electronic protection and an AC line fuse for power supply protection. The shipping weight shall be 20 lbs (9.2 Kgms). The amplifier shall be a standard 19 inch (48.3 cm) rack panel mounted, having a height of 3.5 inches (8.9 cm) and a depth of 8 inches (20.9 cm). Finish shall be McMartin beige with leather grain trim. Access to all components shall be available through removal of the front panel and rear chassis terminal cover.

200 WATT POWER AMPLIFIER

LT-2000D

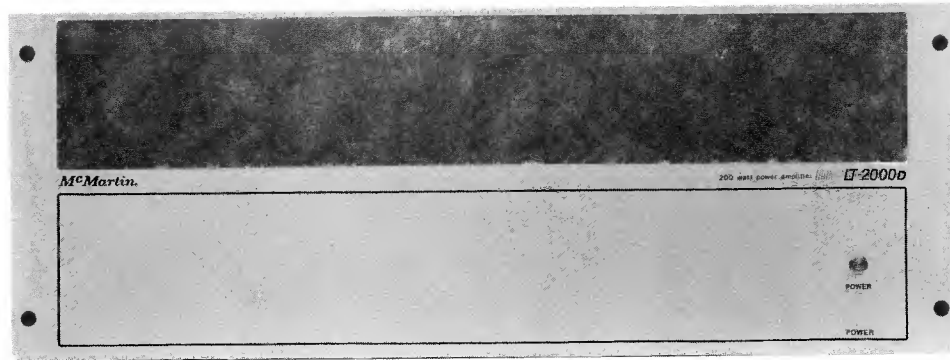

250 WATT rms E.I.A. RATING

200 WATT rms CONTINUOUS RATING

FAILSAFE ELECTRONIC PROTECTION

CONSTANT CURRENT AND THERMAL BIAS STABILIZATION

LESS THAN 1% THD AT RATED OUTPUT 50-10,000 Hz ON 70.7 V LINE

FULL PERFORMANCE OVER -40°C TO +65°C TEMPERATURE RANGE

MODULAR CONSTRUCTION WITH REMOVABLE REAR CIRCUIT ASSEMBLY

The McMartin LT-2000D is a professional quality power amplifier rated for continuous 200 watt rms output. The "D" version amplifiers are all equipped with a new improved instantaneous shutdown, automatic reset, all electronic M-Gard protection network. This circuit prevents damage to the driver-output components and power supply during output shorts and overload or input overdrive.

A low-cut filter provides a low frequency roll-off of 10 dB at 100 Hz to protect horn drivers from low frequency transients. Input provisions include a built-in balanced line input transformer for 50/150/600 ohm matching input or 10K ohm bridging. Sufficient gain is provided to drive the amplifier to full output from a -20 dBm line level input. A 25K ohm (nominal) unbalanced input is also provided for direct drive from unbalanced sources. Computer grade electrolytic capacitors and oversized

transformers provide safe, full performance operation over a temperature range of -40°C to +65°C.

Installation and servicing of all "D" version amplifiers provides the ultimate in simplicity. The removable front panel provides ease of handling of the heavy chassis assembly during rack mounting, even if other units or panels are installed directly above and below the rack opening. This also provides access to the power supply components for servicing. The entire amplifier circuit assembly is mounted on the removable rear panel. The rear panel contains the driver and protection circuit board input-output terminations, and the output stage heatsinks and devices. This panel may either be opened and locked in place for tests and field servicing, or it may be completely unplugged and removed for bench servicing without removing the heavy power supply assembly from the rack installation.

MAR/78

SPECIFICATIONS

POWER OUTPUT:	
Continuous rms @ less than 1% THD:	
Direct Output	200 watts 50-15,000 Hz
70.7 Volt Output	200 watts 50-10,000 Hz
E.I.A. Rating less than 5% THD	250 watts 50-10,000 Hz
FREQUENCY RESPONSE:	
Direct Output	±1 dB, 30-20,000 Hz
70.7 Volt Output	±1 dB, 30-15,000 Hz
INPUT SENSITIVITY:	
Unbalanced	80 MV for Rated Power Output
Balanced 600 ohms or 10K bridging	-20 dBm
HUM & NOISE	-80 dB below RPO
I.M. DISTORTION	Less than 0.5% 100 MV to RPO
LOW CUT FILTER	-3 dB @ 300 Hz -10 dB @ 100 Hz -20 dB @ 40 Hz
REGULATION	
70 V OUTPUT	2 dB or less
OPERATING TEMPERATURE	
	-40°C to +65°C

POWER REQUIRED	120 VAC nominal, 50/60 Hz 500 watts @ RPO 45 W idle	
INPUTS:		
Unbalanced	25K ohms	
Balanced	50/150/600 ohm matching 10K ohm bridging	
OUTPUTS:		
Unbalanced	1.5 and 8 ohms	
Balanced	25 and 70.7 V	
CONTROLS:		
External	Input level Lo filter "IN-OUT"	
Internal	Input gain limit Current trip level	
INDICATORS	Power on	
PROTECTION	Electronic and 6.2 amp fuse	
DIMENSIONS	7"(17.8 cm) High 19"(48.3 cm) wide 11"(27.9 cm) depth	
SHIPPING WEIGHT	60 lbs. (27.2 kgms)	
FINISH:	Beige front panel with leather grain trim; Caustic-etched aluminum chassis	
ORDERING INFORMATION:		
Model	Description	Product Code
LT-2000D	200 Watt Power Amplifier	30-01-016

All tests conducted in accordance with E.I.A. Standard SE-101-A and SE-104 where applicable.

ARCHITECTS AND ENGINEERS SPECIFICATIONS

The power amplifier shall be a McMartin model LT-2000D, or approved equal, all silicon type, solid state amplifier. The amplifier shall have a continuous power output rating of 200 watts rms at less than 1% THD over the frequency range of 50 to 10,000 Hz with all components operating within safe limits. Reserve power shall be available to produce 250 watts rms from 50 to 10,000 Hz at less than 5% THD for use in commercial and industrial paging applications requiring only intermittent duty operation. The amplifier shall have a frequency response of 30 to 15,000 Hertz ±1 dB and an input sensitivity of 80 MV unbalanced and -20 dBm balanced. Hum and noise shall be at least 80 dB below rated output. Intermodulation distortion from 100 MW to RPO shall be less than 0.5%. A low-cut input filter shall provide at least 10 dB attenuation at 100 Hz and 20 dB at 40 Hz. Input impedance shall be unbalanced 25K ohm and balanced 50/

150/600 or 10,000 ohm bridging with built-in line transformer. Regulation shall be better than 2 dB. Controls for gain, filter "IN-OUT" and a power "ON" indicator shall be provided. Power requirements shall be 105 to 130 VAC, 50/60 Hz single phase and the amplifier shall draw no more than 45 watts with no input signal and 500 watts at 200 watts rms output. Outputs shall be 1.5 and 8 ohms unbalanced and 25 and 70.7 V volts balanced. Protection shall be self-resetting electronic shutdown and an AC line fuse for power supply protection. The shipping weight shall be 60 pounds (27 Kgms). The amplifier shall be a standard 19 inch (48.3 cm) rack panel mounted, having a height of 7 inches (17.8 cm) and a depth of 11 inches (48.3 cm). Finish shall be McMartin beige with leather grain trim. Access to all components shall be available through removal of the front panel and rear chassis assembly.

350 WATT POWER AMPLIFIER

LT-3500D

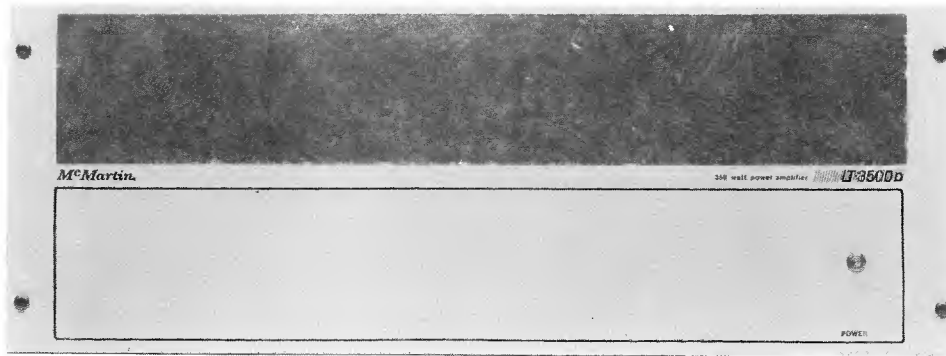

425 WATT rms E.I.A. RATING

350 WATT rms CONTINUOUS RATING

FAILSAFE ELECTRONIC PROTECTION

CONSTANT CURRENT AND THERMAL BIAS STABILIZATION

LESS THAN 1% THD AT RATED OUTPUT 50-10,000 Hz ON 70.7 V LINE

FULL PERFORMANCE OVER -40°C TO +65°C TEMPERATURE RANGE

MODULAR CONSTRUCTION WITH REMOVABLE REAR CIRCUIT ASSEMBLY

The McMartin LT-3500D is a professional quality power amplifier rated for continuous 350 watt rms output. The "D" version amplifiers are all equipped with a new improved instantaneous shutdown, automatic reset, all electronic M-Gard protection network. This circuit prevents damage to the driver-output components and power supply during output shorts and overload or input overdrive.

A low-cut filter provides a low frequency roll-off of 10 dB at 100 Hz to protect horn drivers from low frequency transients. Input provisions include a built-in balanced line input transformer for 50/150/600 ohm matching input or 10K ohm bridging. Sufficient gain is provided to drive the amplifier to full output from a -20 dBm line level input. A 25K ohm (nominal) unbalanced input is also provided for direct drive from unbalanced sources. Computer grade electrolytic capacitors and oversized

transformers provide safe, full performance operation over a temperature range of -40°C to +65°C.

Installation and servicing of all "D" version amplifiers provides the ultimate in simplicity. The removable front panel provides ease of handling of the heavy chassis assembly during rack mounting, even if other units or panels are installed directly above and below the rack opening. This also provides access to the power supply components for servicing. The entire amplifier circuit assembly is mounted on the removable rear panel. The rear panel contains the driver and protection circuit board, input-output terminations, and the output stage heatsinks and devices. This panel may either be opened and locked in place for tests and field servicing, or it may be completely unplugged and removed for bench servicing without removing the heavy power supply assembly from the rack installation.

MAR/78

SPECIFICATIONS

POWER OUTPUT:

Continuous rms @
less than 1% THD:

Direct Output	350 watts
	50-15,000 Hz
70.7 Volt Output	350 watts
	50-10,000 Hz

E.I.A. Rating less
than 5% THD

	425 watts
	50-10,000 Hz

FREQUENCY RESPONSE:

Direct Output	±1 dB, 30-20,000 Hz
70.7 Volt Output	±1 dB, 30-15,000 Hz

INPUT

SENSITIVITY:

Unbalanced	80 MV for Rated Power Output
Balanced 600 ohms or 10K bridging	-20 dBm

HUM & NOISE

-80 dB below RPO

I.M. DISTORTION

Less than 0.5% 100 MV to RPO

LOW CUT FILTER

-3 dB @ 300 Hz
-10 dB @ 100 Hz
-20 dB @ 40 Hz

REGULATION

70 V OUTPUT

±2 dB or less

OPERATING

TEMPERATURE

-40°C to +65°C

POWER REQUIRED

120 VAC, nominal 50/60 Hz
800 watts @ RPO 45 W idle

INPUTS:

Unbalanced	25K ohms
Balanced	50/150/600 ohm matching 10K ohm bridging

OUTPUTS:

Unbalanced	1.5 ohms
Balanced	70.7V

CONTROLS:

External	Input level Low filter "IN-OUT"
Internal	Input gain limit Current trip level

INDICATORS

Power on

PROTECTION

Electronic and 10 amp fuse

DIMENSIONS

7"(17.8 cm) high
19"(48.3 cm) wide
11"(27.9 cm) depth

SHIPPING WEIGHT

70 lbs. (32K gms)

FINISH

Beige front panel with leather grain
trim; Caustic-etched aluminum chassis

ORDERING INFORMATION:

Model	Description	Product Code
LT-3500D	350 Watt Power Amplifier	30-01-017

ARCHITECTS AND ENGINEERS SPECIFICATIONS

The power amplifier shall be a McMartin model LT-3500D, or approved equal, all silicon type solid state amplifier. The amplifier shall have a continuous power output rating of 350 watts rms at less than 1% THD over the frequency range of 50 to 10,000 Hz with all components operating within safe limits. Reserve power shall be available to produce 425 watts rms from 50 to 10,000 Hz at less than 5% THD for use in commercial and industrial paging applications requiring only intermittent duty operation. The amplifier shall have a frequency response of 30 to 15,000 Hertz ±1 dB and input sensitivity of 80 MV unbalanced and -20 dBm balanced. Hum and noise shall be at least 80 dB below rated output. Intermodulation distortion from 100 MW to RPO shall be less than 0.5%. A low-cut input filter shall provide at least 10 dB attenuation at 100 Hz and 20 dB at 40 Hz. Input impedance shall be unbalanced 25K ohm and balanced 50/150/600 or

10,000 ohm bridging with built-in line transformer. Regulation shall be better than 2 dB. Controls for gain, filter "IN-OUT" and a power "ON" indicator shall be provided. Power requirements shall be 105 to 130 VAC, 50/60 Hz single phase and the amplifier shall draw no more than 45 watts with no input signal and 800 watts at 350 watts rms output. Outputs shall be 1.5 ohms unbalanced and 70.7 volts balanced. Protection shall be self resetting electronic shutdown and an AC line fuse for power supply protection. The shipping weight shall be 70 pounds (32 Kgms). The amplifier shall be standard 19 inch (48.3 cm) rack panel mounted, having a height of 7 inches (17.8 cm), and a depth of 11 inches (27.9 cm). Finish shall be McMartin beige with leather grain trim. Access to all components shall be available through removal of the front panel and rear chassis assembly.

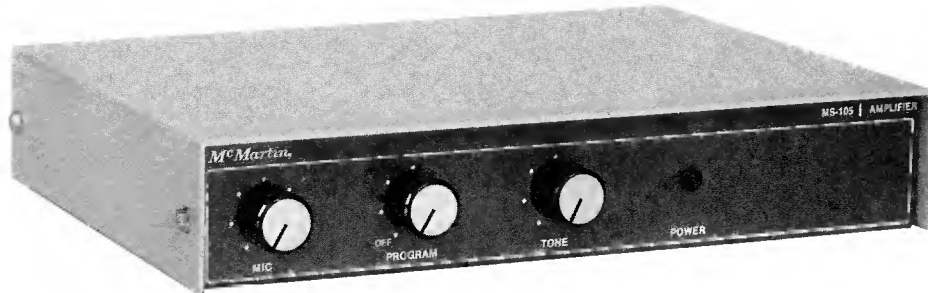

5.6 WATTS MUSIC POWER

LOW PROFILE 1 $\frac{7}{8}$ HIGH

LOW Z MICROPHONE INPUT

MICROPHONE/PROGRAM INPUT

BUILT-IN DUAL ELECTRONIC MUTE

INTERNAL THERMAL LIMITING

DUAL BALANCED IC OUTPUT STAGES

POWER SUPPLY LIMITING TO PROTECT IC'S

The MS-105 is a utility amplifier designed for small sound systems requiring one microphone and one program source. As many as ten speakers (tapped at $\frac{1}{2}$ W) may be driven from the 70.7 volt output or a single 8 ohm speaker may be driven to 5 watts.

The microphone input will accept any standard low Z 50/150 ohm microphone connected in an unbalanced configuration with an output of -30 to -60 dBm without clipping. A three terminal screw connector is provided for the microphone input.

The MS-105 features a dual electronic mute. It is actuated by a simple single pole, single throw switch closure. This may be at the microphone location. The program channel is automatically muted and the microphone channel is energized for paging or other uses. The switching operation is completely free of clicks and pops. The microphone channel is completely muted when the amplifier is in the normal condition. Thus no microphone channel noise can get into the program channel, if the microphone channel is turned wide open.

The program channel input is unbalanced 25K ohms

with 100 millivolt sensitivity. A 20 dB treble cut tone control is provided for high end roll off of the program channel. The tone control does not affect the microphone channel. The microphone channel is wired for a 15 dB bass roll off at 50Hz for crisper voice quality but may be field modified for flat response.

Screw terminal output termination allows for connection of 8 ohms, 25 and 70 volt outputs.

The output stage utilizes two intergrated circuits connected in a balanced bridge configuration to distribute the heat uniformly over two output devices.

The integrated circuits are protected with thermal cut out and will shut down if the temperature exceeds a safe upper limit. They will return to operation after temperature is reduced.

The power supply also limits the output stage dissipation and protects the output IC's if the system is overloaded. The MS-105 features an auxiliary AC outlet on the rear chassis rated at 1 amp and 120V AC. A rack panel is available for rack mounting the MS-105 amplifier.

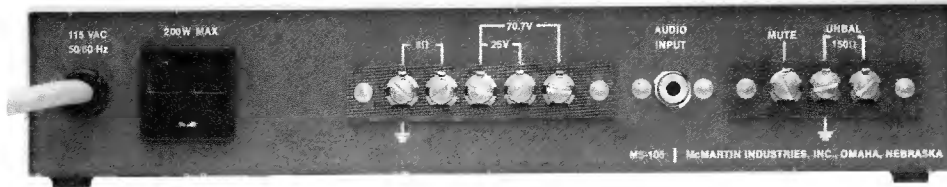

Rear View of MS-105

SPECIFICATIONS

POWER OUTPUT5.6 watts (music power) 4 watts (RMS)
FREQUENCY RESPONSE	±2dB, 50-15,000Hz
DISTORTION	Less than 1%, 100-15,000Hz Less than 2%, 50-15,000Hz
HUM AND NOISE:	
PROGRAM70dB below full output
MICROPHONE (-50 dBm INPUT) ..	.60dB below full output
PROGRAM INPUT IMPEDANCE25K ohm unbalanced
PROGRAM INPUT SENSITIVITY100 millivolts for full output
MICROPHONE INPUT IMPEDANCE50 to 250 ohms
MICROPHONE SENSITIVITY	-.30 to -.60dBm for full output

OUTPUT8 ohms, 25 volt and 70 volt balanced output
OPERATING TEMPERATUREto 150°F (66°C)
POWER REQUIRED120V ac, 60Hz, 15 watts
FINISHMcMartin blue and gray
DIMENSIONS1 1/8" (4.76 cm) height 10 1/8" (25.72 cm) width 6 1/4" (15.88 cm) depth

ORDERING INFORMATION

MS-105	5 watt Universal amplifier	20-09-011
MRP-8	Rack adapter	30-02-032

MCMARTIN

BROADCAST EQUIPMENT

Effective September 1, 1978 • DOMESTIC PRICE SCHEDULE



AM TRANSMITTERS

Model	Description	Product Code	Price
BA-1K	1000/500/250 watt AM transmitter, 208/230 VAC, 50/60 Hz, single phase, 3-wire (grounded neutral) For PSA powers below 250 watts, add \$200.00	10-01-061	\$9,750.00
SR-1K	Sola filament regulator for BA-1K	10-01-062	295.00
STA-1K	100% spare tubes for BA-1K Spare Rectifier Diode Stack RS 1.5 - 12 - 12M (Requires 2)	10-01-063 210015	458.00 54.00
SC-AM	Spare vacuum crystal (Specify frequency) for all AM transmitters	10-01-064	99.00
PT-1K	Line transformer for 220/240 VAC, single-phase, 2-wire (for BA-1K)	10-01-065	290.00
SCK-A1K	Spare semi conductor kit (Audio and RF exciter transistor and diodes only)	10-01-093	55.00
BA-2.5K	2500/1000/500 watts AM broadcast transmitter, 208/230 VAC, 50/60 Hz, single phase, 3-wire (grounded neutral)	10-01-066	14,500.00
SR-2.5K	Sola filament regulator for BA-2.5K	10-01-068	425.00
STA-2.5K	100% spare tubes for BA-2.5K Spare Rectifier Diode Stack RS 3.5 - 24 - 12S (Requires 4)	10-01-069 210016	1,020.00 83.60
BA-5K	5000/2500/1000/500 AM broadcast transmitter (combined BA-2.5K), 208/230/240 VAC, 50/60 Hz, single phase, 3-wire (grounded neutral)	10-01-070	31,000.00
BA-10K	10,000/5000 or 2,500 watt AM transmitter complete with tubes, 208/230/240 VAC, 50/60 Hz, 3 phase 10,000/1,000 watt AM transmitter complete as above with cutback to 1,000 watts	10-01-036 Special	32,000.00 33,000.00
STA-10K	Spare tube kit for BA-10K, 4CX-5000A Individual spare tube for BA-10K, 4CX-5000A Spare rectifier diode stack RS 3.5 - 24 - 12S (6 used)	10-01-037 111123 210016	2,820.00 705.00 83.60

FM TRANSMITTERS

Model	Description	Product Code	Price
BF-1K	.25 - 1.5KW FM broadcast transmitter, complete with exciter and tubes, 208/230/240 VAC, 50/60 Hz, single phase, 3-wire (grounded neutral)	10-01-090	\$12,075.00
STF-1K	Spare tube kit for BF-1K Spare Rectifier Diode Stack RS 1.5 - 12 - 12M (Requires 2)	10-01-094	260.00
		210015	54.00
BF-3.5K	1.5 - 3.5KW FM transmitter, complete with exciter and tubes, 208/230/240 VAC, 50/60 Hz, single phase - or optional (208/230/240 VAC 3 phase)	10-01-026	15,500.00
STF-3.5K	Spare tube kit for BF-3.5K Spare Rectifier Diode Stack RS 3.5 - 24 - 12S (Requires 4)	10-01-027	488.00
		210016	83.60
BF-5K	3.5 - 5.5KW FM broadcast transmitter, complete with exciter and tubes, 208/230/240 VAC, 50/60 Hz, 3-phase - or - optional (208/230/240 VAC, single phase)	10-01-040	19,500.00
STF-5K	Spare tube kit for BF-5K Spare Rectifier Diode Stack RS 3.5 - 24 - 12S (Requires 4)	10-01-027	488.00
		210016	83.60
BF-10K	5.5 - 15KW FM broadcast transmitter, complete with exciter and tubes, 208/230/240 VAC, 50/60 Hz, 3-phase	10-01-045	27,500.00
STF-10K	Spare tube kit for BF-10K Spare Rectifier Diode Stack, Low Voltage RS 1.5 - 12 - 12M (Requires 2) Spare Rectifier Diode Stack, High Voltage RS 3.5 - 24 - 12S (Requires 6)	10-01-048	1,196.50
		210015	54.00
		210016	83.60
BF-25K	10 - 27.5KW FM broadcast transmitter, complete with exciter and tubes, 208/230/240 VAC, 50/60 Hz, 3-phase	10-01-046	37,700.00
STF-25K	Spare tube kit for BF-25K Spare Rectifier Diode Stack, Low Voltage RS 1.5 - 12 - 12S (Requires 4) Spare Rectifier Diode Stack, High Voltage RS 3.5 - 24 - 15S (Requires 6)	10-01-047	1,531.50
		210016	83.60
		210017	109.50
BF-55K	20 - 55KW FM broadcast transmitter, complete with one exciter (combined output of two BF-25K transmitters), 208/230/240 VAC, 50/60 Hz, 3 phase	10-01-071	83,200.00
ACCESSORIES			
AES	Automatic exciter switching for dual FM systems	10-01-072	7,245.00
AOS	Automatic RF output switching for dual FM systems	10-01-073	11,434.00
APC	Automatic power control for FM transmitter	10-01-074	400.00
AS-3	Three phase AC detector with auto restart	10-01-075	350.00
TCP-1	Transmitter control panel for remote control for AM/FM transmitter	10-01-076	450.00

FM EXCITER, Low Power 10 - 100 Watt Transmitters, Accessories

Model	Description	Product Code	Price
B-910	Exciter, monaural, 10 watt	10-01-001	\$ 2,995.00
PLUG-IN MODULES			
B-110	Stereo, generator assembly; plug-in module (includes B-111, 112, and filter)	10-01-004	1,725.00
B-113	SCA generator	10-01-007	650.00
B-114	Mono audio amplifier	10-01-008	266.00
B-115	Modulated oscillator	10-01-009	356.00
B-116	Reference oscillator	10-01-010	412.00
B-117	RF power amplifier	10-01-011	452.00
B-118	Alarm and control module	10-01-012	452.00
B-119	Power supply regulator	10-01-013	203.00
B-120	Harmonic filter	10-01-014	270.00
B-122	Cabinet assembly for B-910	10-01-016	300.00
B-123	Cabinet assembly for B-910 and B-950 amplifier	10-01-023	400.00
SCK-910	100% spare semiconductor kit	10-01-019	375.00
CRYSTAL	For reference oscillator (specify transmitter frequency)		50.00
CRYSTAL SET	Two crystals; 1 for reference oscillator, 1 for alarm and control module (specify transmitter frequency)		66.00
B-910T	Transmitter, 10 watt, rack mount	10-01-028	3,265.00
B-910T	Transmitter, 10 watt, with cabinet (as above; includes B-122)		3,565.00
B-110R	Stereo generator, self-contained, rack mount	10-01-017	1,890.00
B-113R	SCA generator, self-contained, rack mount	10-01-018	900.00
B-950	50 watt amplifier only	10-01-025	1,300.00
B-950T	Transmitter, 50 watts, rack mount (includes B-910 exciter and B-950 amplifier)	10-01-024	4,565.00
B-950T	Transmitter, 50 watts, as above with cabinet, B-123		4,965.00
B-9100	100 watt amplifier only		2,480.00
B-9100T	Transmitter, 100 watt, rack mount only, includes B-910 exciter	10-01-002	5,745.00

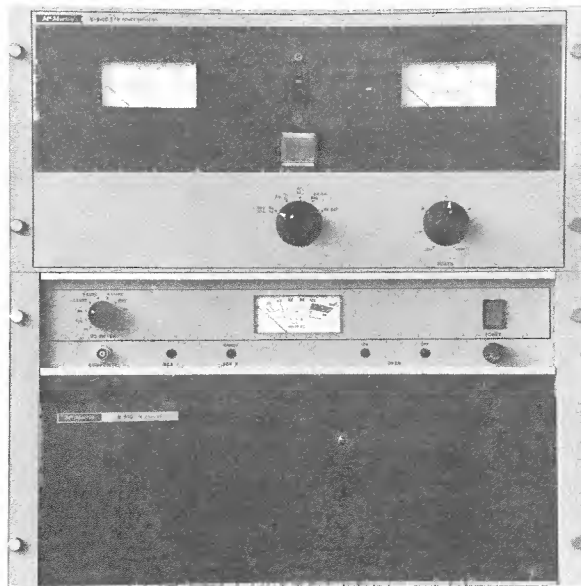

B-9100T 100 watt Transmitter

REMOTE PICK-UP EQUIPMENT, TRANSMITTER & RECEIVERS

Model	Description	Product Code	Price
RPU-1103	McMartin portable, 3 watt battery operated remote pickup transmitter 150.87 to 170.15 MHz. Bands K1, K2, L and M. Includes battery and antenna without microphone.	10-01-086	\$ 650.00
RPU-1403	McMartin portable, 3 watt battery operated remote pickup transmitter 450 MHz band. Includes battery and antenna without microphone. (Specify frequency)	10-01-087	765.00
RPU-1150	50 watt 150 MHz remote pickup transmitter. Includes mobile mount, requires 13.5 volt DC@10 amps transmit. (Specify frequency)	10-01-088	1,070.00
RPU-1430	30 watt 450 MHz remote pickup transmitter. Includes mobile mount, requires 13.5 volt DC@10 amps transmit. (Specify frequency)	10-01-089	1,250.00
	For base station use, .0002 frequency tolerance, add \$200.00		
RPU-1150R	Receiver, 150 MHz, rack mount, 2 channels (for second channel, add \$25.00)	10-03-032	580.00
RPU-1450R	Receiver, 450 MHz, rack mount, 2 channels (for second channel, add \$25.00)	10-03-033	640.00
RPU-1150Q	150 MHz Cue receiver 1 Channel 2 Channel	10-03-054	250.00 300.00
RPU-1450Q	450 MHz Cue receiver 1 Channel 2 Channel	10-03-055	300.00 350.00
150 MHz FE	Additional front end 150 MHz 1 Channel 2 Channel	10-03-056	150.00 200.00
450 MHz FE	Additional front end 450 MHz 1 Channel 2 Channel	10-03-057	175.00 225.00

NOTE: The "Cue" receivers mount on the RPU-1103 or RPU-1403 transmitters and work off the transmitter power supply only.

RPU ACCESSORIES

Model	Description	Product Code	Price
FOR RPU-1103 & RPU-1403			
RPU/BAT	Replacement battery, 12 volts Nicad	10-01-115	\$ 40.00
RPU/BC	Battery charger	10-01-111	45.00
RPU/ANT	Rubber duck antenna 150 MHz	10-01-112	19.00
RPU/ANT	Rubber duck antenna 450 MHz	10-01-118	19.00
RPU/2CH	Second Channel frequency module (specify frequency) for RPU-1103, 1403, 1150, 1430, and 1330. (450 MHz base station \$200.00)	10-01-114	90.00
RPU/MIC	Turner push-to-talk microphone model 350D	10-01-113	45.00
FOR RPU-1150, RPU-1330, & RPU-1430			
RPU/PS	AC power supply	10-01-095	250.00
RPU/RmCc	Rack mount and carrying case provides convenient carrying case and rack mounting for both the power supply and 50 or 30 watt transmitter. (Not required for mobile installations)	10-01-096	70.00
RPU/MC	Mobile control head for use when unit is trunk mounted. Includes cable from control head to transmitter.	10-01-098	110.00

FIXED BASE

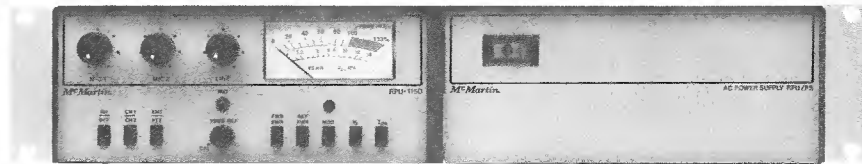

RPU-1150 and RPU/PS Rack mount

PORTABLE

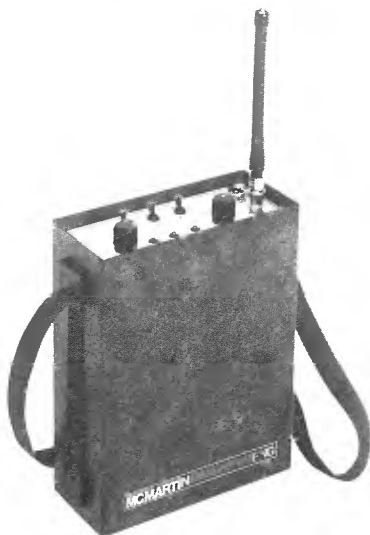

RPU-1103 3 watt portable transmitter

MOBILE

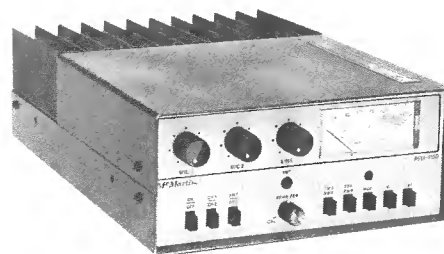

RPU-1150 as for trunk mounting



RPU/MC Mobile control head

RPU ANTENNAS

Model	Description	Product Code	Price
	MOBILE (150 MHz)		
DB-702-100	2.5 dB Gain - Roof mount, includes 15' RG/58U cable and PL-259 connector.		\$ 30.00
DB-702-102	Same as above with "no holes" trunk mount.		35.00
	BASE (150 MHz)		
DB-264	6 dB circular to 9 dB offset consists of 4 vertical folded dipoles, enclosed feed system, with type N male connector. Length 258" top mounted. (Specify frequency)		228.00
DB-5001	Side mount kit for DB-224.		58.00
DB-230	3 element YAGI - 7 dB Gain - Type N male connector supplied.		98.00
DB-230-2	2-DB-230's stacked -10 dB Gain harness and type N male connector supplied.		230.00
DB-230-4	4-DB-230's stacked -13 dB Gain harness and type N male connector supplied.		498.00
	MOBILE (450 MHz)		
DB-705-201	5 dB Gain - Roof mount, includes 15' RG/58U cable and PL-259 connector.		28.00
DB-705-203	Same as above with "no holes" trunk mount.		35.00
	BASE (450 MHz)		
DB-408	4 bay collinear array 6.6 dB Gain type N male connector supplied, length 9'5". (Specify frequency)		176.00
DB-410	8 bay version of DB-408 above 9.2 dB Gain, length 18'1". (Specify frequency)		284.00
DB-5012	Side mount kit for DB-408 or 410.		58.00
DB-436	6 element YAGI antenna 10 dB Gain type N male termination.		88.00
DB-436-2	2-DB-436 stacked 13 dB Gain.		192.00
DB-436-4	4 DB-436 stacked 16 dB Gain.		398.00

1000 SERIES AUDIO CONSOLES

Model	Description	Product Code	Price
1052V	5 Channel Stereo Vertical Attenuators	10-02-146	\$ 2,600.00
	CH 1 Microphone Input		
	CH 2,3,4 Hi Level Unbalanced Input		
	CH 5 Hi Level Balanced Input		
1052SA	As above but with rotary step attenuators	10-02-045	2,550.00
1052	As above but with carbon potentiometers	10-02-144	2,300.00
1081	8 Channel Mono Rotary Attenuators	10-02-120	3,000.00
	CH 1,2 Microphone Input		
	Ch 3,4,5,6,7 Hi Level Unbalanced Input		
	CH 8 Hi Level Balanced Input		
1081V	8 Channel Mono Vertical Attenuators	10-02-119	3,150.00
	CH 1,2 Microphone Input		
	CH 3,4,5,6,7 Hi Level Unbalanced Input		
	CH 8 Hi Level Balanced Input		
1082	8 Channel Stereo Rotary Attenuators	10-02-118	3,775.00
	CH 1,2 Microphone Input		
	CH 3,4,5,6,7 Hi Level Unbalanced Input		
	CH 8 Hi Level Balanced Input		
1082V	8 Channel Stereo Vertical Attenuators	10-02-117	3,950.00
	CH 1,2 Microphone Input		
	CH 3,4,5,6,7 Hi Level Unbalanced Input		
	CH 8 Hi Level Balanced Input		

REPLACEMENT PRINTED CIRCUIT CARDS for 1000 Series Consoles

Cue/Talkback Amplifier	10-02-124	145.00
Program Amplifier	10-02-125	165.00
Monitor Amp Stereo	10-02-126	175.00
Monitor Amp Mono	10-02-134	110.00
SANKEN Hybrid Module for use with MONITOR AMPS. Requires 1 Mono, 2 Stereo		28.00
Stereo Mic PreAmp	10-02-130	155.00
Mono Mic PreAmp	10-02-135	80.00
Headphone Amplifier	10-02-129	110.00
Stereo Hi Level Balanced Input	10-02-131	95.00
Mono Hi Level Balanced Input	10-02-136	50.00
Mono or Stereo Hi Level Unbalanced Input	10-02-132	7.50

500 SERIES AUDIO CONSOLES

Model	Description	Product Code	Price
B-501	5 mixer, monaural, 1 mic, 4 hi-bal	10-02-041	\$ 1,125.00
B-501SA	B-501 with step attenuators	10-02-044	1,415.00
B-502	5 mixer, stereo, 1 mic, 4 hi-bal	10-02-042	1,590.00
B-502SA	B-502 with step attenuators	10-02-045	2,110.00

REPLACEMENT PRINTED CIRCUIT CARDS for 500 Series Consoles**PLUG-IN CARDS**

5MP1	Microphone preamplifier (B-501)	10-02-056	38.00
5MP2	Microphone preamplifier (B-502)	10-02-060	80.00
5BH1	High Level balanced input (B-501)	10-02-054	37.00
5BH2	Dual high level balanced input (B-502)	10-02-058	67.00
5BA1	Booster amplifier (B-501)	10-02-055	25.00
5BA2	Dual booster amplifier (B-502)	10-02-059	31.00
5PG1	Program amplifier (B-501)	10-02-057	30.00
5PG2	Dual program amplifier (B-502)	10-02-061	43.00
5PS1	Power regulator (All models)	10-02-053	31.00

WIRE-IN CARDS

5QA1	Cue amplifier	10-02-051	37.00
5MA1	Monitor amplifier	10-02-052	39.00

ACCESSORIES

5RY1	Speaker muting relay (All Models)	10-02-064	20.00
------	-----------------------------------	-----------	-------

REMOTE, PRODUCTION CONSOLES, PHONO PREAMP, TUNER, & MIXERS

ACCU-FIVE	5 channel rack mount mini console	10-02-080	735.00
BR-400	4 channel remote mixer amplifier	10-02-081	425.00
B-200B	Mono/stereo equalized phono preamplifier, balanced 600 ohm output	10-02-076	180.00
MX-5B	5-channel mixer/preamplifier	10-02-084	180.00
MRP-7B	Rack mount adaptor, beige, for MX-5	10-02-085	15.00
AF-200/B	AM/FM stereo tuner	10-05-018	180.00

BROADCAST MONITOR AMPLIFIERS

LT-80C/B	12-watt universal amplifier with one mic, 1 program input	10-05-001	102.00
LT-252B/B	25-watt universal amplifier with two mic, 2 program input	10-05-003	171.00
LT-250C/B	25-watt power amplifier	10-05-002	156.00
LT-500C/B	50-watt power amplifier	10-05-004	215.00
LT-750C/B	75-watt power amplifier	10-05-005	259.00
LT-1000D/B	100-watt power amplifier	10-05-006	288.00
LT-2000D/B	200-watt power amplifier	10-05-007	432.00
LT-3500D/B	350-watt power amplifier	10-05-008	615.00
MT-3B	Plug-in balanced/bridging transformer	10-05-009	14.00
MS-105/B	5-watt amplifier	10-05-017	66.00

AM MONITORS

Model	Description	Product Code	Price
RF-85B	AM RF amplifier	10-03-104	\$ 685.00

AM/FM MONITOR AND EBS EQUIPMENT

AMR-1	AM monitor receiver, single channel	10-04-003	115.00
FMR-1D	FM monitor receiver, single channel	10-04-012	150.00
FMR-5	FM monitor receiver, five channel, first channel operation. For each additional channel, add \$17.00	10-04-006	160.00
EBS-2	EBS decoder for AMR-1 and FMR-1D/FMR-5 (Two-tone system)	10-04-002	140.00
TG-2/EBS	Precision two-tone EBS generator	10-04-011	245.00

FM MONITORS

TBM-3700	Frequency and monaural modulation monitor	10-03-049	1,800.00
RM-37T	Remote metering plug-in card	10-03-052	90.00
RM-37R	Remote metering rack mount panel	10-03-051	250.00
TBM-2200A	Stereo modulation and pilot frequency adaptor	10-03-034	1,600.00
RM-22T	Remote metering plug-in card	10-03-037	120.00
RM-22R	Remote metering rack mount panel	10-03-036	260.00
TBM-2000B	SCA modulation and frequency adaptor	10-03-027	1,600.00
RM-20T	Remote metering plug-in card	10-03-030	90.00
RM-20R	Remote metering rack mount panel	10-03-029	225.00
TBM-3500B	Modulation monitor	10-03-029	1,670.00
RM-35B	Remote metering rack mount panel	10-03-045	160.00
LL-35B	Low level input module	10-03-044	275.00
TBM-2500C	RF amplifier	10-03-041	650.00

FM REBROADCAST RECEIVERS

TBM-1005D	Five channel relay receiver (88-108 MHz) with one crystal. Each additional channel crystal	10-03-009	510.00 17.00
TBM-1003D	Aural TV channel 2-13 receiver		630.00
STE-1D	Plug-in stereo demod card for relay receiver	10-03-012	175.00
SCA-2D	Plug-in SCA demodulator card 41kHz 67 kHz	10-03-010 10-03-011	120.00 120.00
TVR-1	TV/SCA receiver, 39.5/67 kHz	40-02-011	350.00
TR-E7	TV/SCA receiver, 39.5/67 kHz	40-02-010	150.00

RELATED FM ANTENNAS

A-72-SF-3	3 element Yagi Antenna cut to band (2 per carton)	20-03-001	18.00
A-72-SF-5	5 element Yagi Antenna cut to band	20-03-002	31.00
AS-1	Stacking harness (for A-72-SF-3/SF-5)	20-03-003	28.00

This is your price list for McMartin Broadcast products. All prices and specifications are subject to change without notice. Firm quotations are available for specific time periods. All prices are F.O.B. Omaha, Nebraska or point of shipment.

TERMS AND CONDITIONS OF SALE

1. PRICE: Prices of equipment are based on a cash transaction and are FOB Omaha, Nebraska, or point of shipment. McMartin may adjust the price of any of the equipment covered by this order to McMartin's current price in effect immediately prior to shipment except that, in the case of equipment manufactured by McMartin, if this order is accompanied by a down payment of at least 25% of the total price of the equipment described herein and shipment is made within 90 days after McMartin's acceptance of this order.

2. ORDERS: All orders must be signed by an officer of the purchasing corporation, partnership, or company, or his designate. All orders, down payment agreements and terms are subject to final acceptance of McMartin in the Omaha, Nebraska, office; and the banking, negotiation, or other use of down payment shall not constitute an acceptance by McMartin.

3. TERMS OF PAYMENT: Terms of payment are cash with order, unless other terms are offered within. Orders are accepted from customer with an established credit rating with a 25% down payment and the balance due in 30 days of shipping date. The prompt payment discount is one percent 10th and 25th, net 30 days. Payment made beyond the 30-day period is subject to a finance charge of 1 ½ percent per month (equivalent to an annual percentage rate of 18 percent). Customers wishing to establish 30-day terms should furnish trade and bank references and current financial information for review by McMartin's Credit Department. Equipment is available through a lease/purchase option plan. Contact McMartin's Sales Department for details.

4. WARRANTY: McMartin products are warranted to be free from defects in materials and workmanship for a period of one year after shipping date, when subjected to normal usage and service. All warranties are void if (a) equipment has been altered or repaired by others without McMartin's specific prior authorization; or (b) equipment is operated under environmental conditions or circumstances other than those specifically described in McMartin literature or instruction manuals.

Upon notification within the applicable warranty period, McMartin agrees without charge, to repair, replace, or supply replacement parts for any properly maintained equipment or parts that are defective as to design, materials or workmanship and that are returned in accordance with McMartin's instructions to the Buyer. At McMartin's sole discretion, the Buyer may be requested to return the defective part of equipment to McMartin, FOB Omaha, Nebraska. Parts or equipment may be returned only with McMartin's prior authorization and must be identified by a return authorization number previously issued by McMartin's Customer Service Department. All merchandise so returned must be sent transportation prepaid, at Buyer's risk. Full details of the failure or malfunction should be included so as to expedite repair or replacement. Repair parts or repaired or replaced equipment will be returned to the Buyer, FOB factory.

The above warranty does not extend to other equipment, such as tubes, transistors, I.C.'s lamps or fuses manufactured by others, which are subject to only such adjustment as McMartin may obtain from the suppliers thereof. McMartin shall not be liable for consequential damages resulting from the use of, or the inability to use, the equipment; nor for any loss, damage or expense incurred thereby; nor from any other cause.

Except as set forth herein, and except as to title, there are no warranties, or any affirmations of fact or promises by McMartin, with reference to the equipment, or to merchantability, fitness, for particular application, signal coverage, infringement, or otherwise, which extend beyond the description of the equipment on the face hereof.

5. REPAIR OR REPLACEMENT: If a McMartin product fails during the applicable warranty period, replacement or repair parts will be furnished free of charge. Upon request, and at the discretion of McMartin, the customer may return the defective part or equipment to McMartin, FOB, Omaha, Nebraska. Parts or equipment may be returned only with McMartin's prior authorization and must be accompanied by return authorization number issued by McMartin's Customer Service Department. All merchandise returned for service must be sent freight prepaid at owner's risk, and with appropriate insurance coverage. Full details of the circumstances of the failure or malfunction should be included to expedite repair or replacement. Repaired equipment will be shipped to the customer, FOB, factory.

6. RETURNS: Merchandise manufactured and shipped upon order is not returnable for credit. Merchandise may be exchanged if McMartin Industries in its sole discretion determines that circumstances warrant such concession. Merchandise for exchange must be of current design and in unopened factory cartons and is subject to a 20 percent restocking charge, plus a \$30.00 retuning charge for receiver and monitor products with tuned RF stages. McMartin assumes no responsibility for unauthorized returns.

7. PRODUCT CHANGES: McMartin reserves the right without advance notice to make engineering and production changes including substitution of vendor sources for components which may modify the design or specifications of its products, provided said modification will not materially affect the performance of the product.

8. GENERAL:

- A. The preferred shipping method should be specified in your order. When not specified, shipment will be made by a common carrier selected by McMartin. Generally, shipments will be made transportation charges collect. All materials are shipped F.O.B. Omaha or point of origin and the Purchaser is responsible for any and all damaged goods except shipments by U.P.S.
- B. Claims for damage incurred in transit must be made by the customer directly with the carrier, except for shipments handled by United Parcel Service (U.P.S.). U.P.S. claims must be filed at the point of origin. In either case, McMartin must be immediately notified of damage details, dates and McMartin invoice numbers involved.
- C. In no event is McMartin liable for consequential damages resulting from late or non-delivery, or malfunction or failure of its products, and in no event shall either party be liable to the other for consequential or special damages.
- D. We reserve the right to correct clerical or typographical errors at any time without penalty.

MCMARTIN

SEP 78 • Printed in U.S.A.



ALL PRICES FOB FACTORY AND SUBJECT TO CHANGE WITHOUT NOTICE
ALL ORDERS MUST USE PRODUCT CODE NUMBERS
MINIMUM ORDER \$100.00

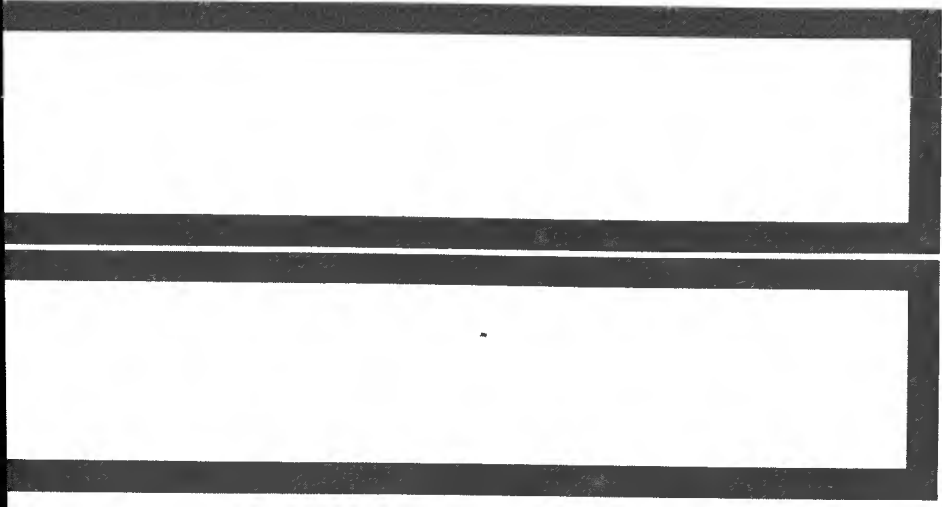

MCMARTIN

a presentation by

Leonard Hedlund

Vice President and Director
of
Research and Development
before

the FM Clinic
Madison, Wisconsin

TOMORROW'S FM MONITORS - TODAY

THEORY OF DESIGN

The new generation of FM monitors consists of a base band modulation monitor, the TBM-3500B, a baseband frequency and modulation monitor, the TBM-3700, a TBM-2200A stereo monitor, and the TBM-2000B SCA monitor. The TBM-3700 or TBM-3500B is used for the measurement of all the modulation parameters of the baseband RF carrier. The TBM-3700 also measures carrier center frequency deviation. The add-on TBM-2200A stereo monitor and TBM-2000B SCA monitor are driven from the wide band composite outputs of the TBM-3700, or the TBM-3500B.

The new generation monitors utilize plug-in cards rather than plug-in modules used in the previous generation. The advantage is easier servicing as all components are accessible on the plug-in cards. The plug-in cards can be removed from the rear of the monitor without the unit being removed from the rack. Tantalum rather than aluminum electrolytic interstage capacitors are used for coupling insuring longer, trouble-free operation.

Electronic equipment experiences losses due to aging of components, such as change in characteristics of coils and filters, loss in meter amplifier gain, diodes, etc. We have also experienced loss of modulation meter sensitivity after a period of time, evidently due to loss of flux density. The changes, though small, can easily add up to over 0.5 dB error. This error in broadcast audio equipment is negligible but is serious in a monitor. A 0.5 dB error is equal to a modulation error of 5 percent in the base band monitor. Errors can also accumulate in the stereo monitor section. Especially in the 19 kHz band pass filters that are used to measure the 19 kHz pilot level. These filters must have high selectivity to reject 15 kHz audio signals that are nine times greater in amplitude than the 19 kHz pilot carrier. This requires high Q circuits. All present day monitors use high grade core material with a slow aging rate for the inductors and temperature compensating capacitors in the tuned circuits for stable operation over a wide temperature range. However, they are still subjected to amplitude losses due to slight detuning etc. over a period of time and can lead to serious error in the measurement of pilot injection. The same holds true for the measurement of SCA injection.

All four of the new monitors have built-in calibration facilities which allow simple daily checks to insure that the monitors are operating correctly and giving accurate measurements of all transmission parameters. The built-in calibration feature also insures that if a plug-in card is replaced in the field, it can be adjusted to the internal standard for continued accuracy, without

TBM-3700 FREQUENCY MODULATION MONITOR

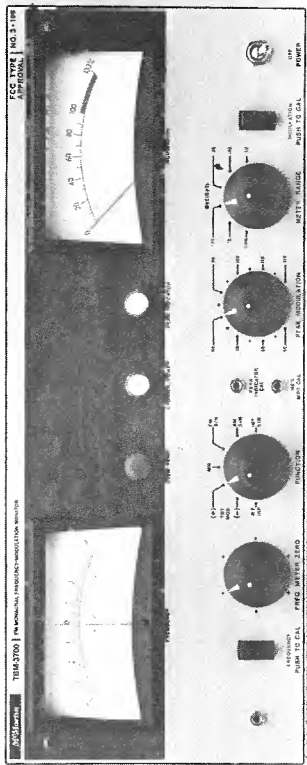

returning the unit to the factory. The TBM-3700 frequency and modulation monitor utilizes completely separate circuitry for modulation and frequency circuits without affecting the accuracy of the modulation measurements, and vice versa. The frequency meter discriminator is very stable and from many field reports seldom requires adjustment of the meter zero control.

Another advantage separate circuitry gives is the ability to check the frequency meter zero calibration while the station is programming without interrupting monitor audio output. This can be important if you are using the monitor as a source of 'off air' house monitoring.

Although the FCC has relaxed the requirement for FM station frequency monitors, I personally feel that a frequency monitor is still necessary in monitoring the carrier frequency. Some may argue that you are simply comparing a crystal in the transmitter against a crystal in the monitor and the crystal in the transmitter may be as stable as in the monitor. True, this is very possible, but should a serious frequency error be indicated by the frequency monitor it will alert the station engineer to the fact that possibly the error may be in the transmitter. He can immediately take steps to insure that his station frequency is correct. Without any type of frequency monitoring, the engineer would be unaware if the transmitter frequency control system would suddenly malfunction and change frequency to another channel. I have known of several cases where this has happened involving transmitters using the phase-lock technique of frequency control, where the exciter locked to a sub multiple of the divider chain. One station received calls from listeners saying they were receiving their station at another place on the dial. The station engineer said this was impossible as his exciter showed that it was in proper phase lock condition, however in further checking he found that the listeners were right and the unit had accidentally locked to another frequency. This can occur if the exciter is severely overmodulated or subjected to a high DC transient.

Even though the FCC does not require a frequency monitor, it is still the responsibility of the licensee to maintain the station frequency within the specified limits at all times.

For those stations who wish to rely on the inherent frequency stability of their transmitter, or those who have accurate frequency counters available to them as a separate instrument, McMartin has developed the TBM-3500B which monitors modulation percentage only. The basic circuitry of the TBM-3500B is similar to that used in the modulation monitoring portion of the TBM-3700. A very important improvement has been incorporated into the TBM-3500B design. This is the ability to increase the input sensitivity to 350 microvolts by insertion of an optional plug-in card, the LL-35B. Where adequate field intensity exists this makes it practical to drive the TBM-3500B from antenna-derived 'off air' signals. When practical caution is exercised in the antenna installation to eliminate external noise and interference and maintain phase linearity, the off-air performance of the TBM-3500B is identical to its performance when fed directly from a transmitter output.

I have a block diagram of the TBM-3700, Figure 1, and will explain the method used to produce the internal calibration voltage for calibration of the modulation measuring circuits.

TBM-3700

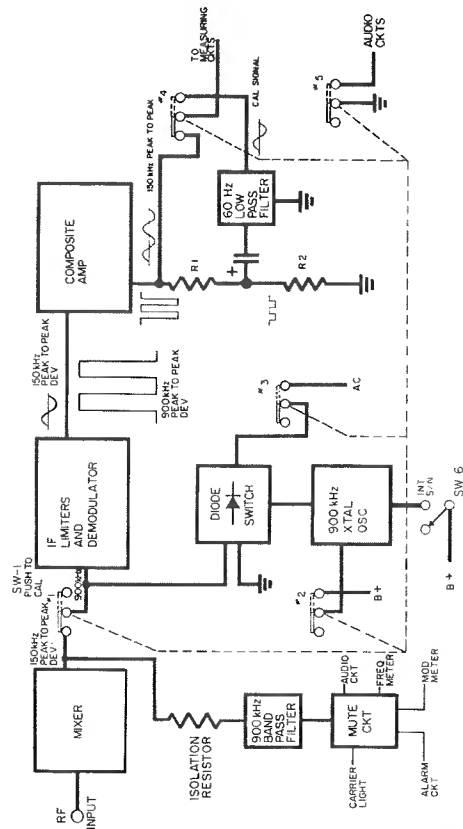

Figure 1

The local crystal control oscillator operates 900 kHz above the incoming RF signal producing a 900 kHz IF frequency. In normal operation the 900 kHz signal is deviated ± 75 kHz which is equivalent to 150 kHz P-P for 100 percent modulation. This signal is fed to the IF limiters and demodulator.

When the 'Mod Push to Cal' switch on the TBM-3700 is depressed, the following 5 events occur simultaneously: (Note: the 5 sections of the switch shown in Figure 1 are in the 'depressed' position.)

1. The signal from the mixer is removed by switch No. 1.
2. The 900 kHz crystal oscillator is activated by switch No. 2.
3. Switch No. 3 feeds an AC signal to a diode switch (note diode block) which short circuits the 900 kHz signal to ground 60 times per second. This in effect produces an IF frequency deviated from 0-900 kHz. This is equivalent to a signal deviated 900 kHz P-P. The audio output from the demodulator under this condition consists of a signal which is now six times greater in amplitude than the normal 150 kHz P-P, 100 percent modulated signal. This signal is fed to the composite amplifier, the emitter follower output of which feeds the voltage divider R1 and R2. NOTE: this voltage divider, consisting of $\frac{1}{4}$ percent tolerance resistors, reduces the audio signal by a factor equivalent to a signal produced by a 150 kHz P-P deviation or 100 percent modulation. This signal is a 60 Hz square wave signal and is fed to a 60 Hz low pass filter which removes all harmonics and restores the 60 Hz signal to a pure sine wave with distortion of less than 0.1 percent. We now have an accurate internal signal for calibrating the rest of the measuring circuits.
4. This low distortion 60 Hz signal is fed through switch No. 4 to the phase splitter and measuring circuitry. This signal is ideal as a signal with negligible distortion as required for accurately adjusting equal negative and positive peaks on the modulation meter.
5. Switch No. 5 short circuits the audio output signal preventing an annoying 60 Hz signal from being fed to the house monitoring system.

The generation of this calibrating signal is accurate as the maximum IF peak deviation of 900 kHz is controlled by a 900 kHz crystal oscillator with an accuracy in excess of ± 50 Hz. Percentage wise this would produce an unmeasurable error. The diode switch is completely saturated by the AC signal to insure that the signal goes to ground or zero. The only possible error is produced by the voltage divider and low pass filter. The two resistors used are of $\frac{1}{4}$ percent tolerance. The maximum additive error cannot exceed 0.5 percent. The low pass filter has a cutoff frequency of 140 Hz, far removed from the 60 Hz signal, thus has negligible loss and is unaffected by temperature variation. Two recessed front panel vernier controls with a range of ± 2 dB are used to calibrate the modulation meter and peak flasher to 100 percent modulation against this internal standard. The recessed controls are adjusted with a small screwdriver. These rarely have to be adjusted as the monitor calibration normally will stay within ± 2 percent. The monitor internal calibration accuracy is specified as ± 2 percent modulation accuracy. If the modulation meter or peak flasher cannot be calibrated to 100 percent with the recessed front panel control, a malfunction has occurred and immediate servicing should be done.

When doing the annual proof of performance, the question frequently arises as to whether the monitor or the transmitter equipment is at fault if an FM S/N reading of 60 dB cannot be met. The TBM-3700 has provision for verifying

the inherent noise characteristics of the monitor. By switching the function switch to the 'Int-S/N Noise' position, the signal from the transmitter is activated by Switch No. 6 (Figure 1) and fed to the mixer input. This will verify the inherent FM noise of the monitor which should be in excess of -70 dB below 100 percent modulation when the unit is performing properly. This internal noise measurement may be made at any time, with or without modulation.

A 900 kHz band pass filter with a bandwidth of 90 kHz at the 3 dB points and extremely sharp skirts that will reject adjacent and other signals outside the assigned channel frequency of the monitor is incorporated. This signal is fed to a mute circuit which will positively mute all functions when the station carrier is off the air. This prevents annoying noise from being fed to the house system. The carrier indicator light will also go off. A relay contact closure occurs and may be used to activate an external alarm. Note that the filter is completely isolated from the modulation measuring circuits as this filter would otherwise create serious modulation errors due to disturbance of the sidebands produced by modulation. Severe overmodulation will also mute the monitor.

Optional remote monitoring facilities are available for frequency and modulation measurement as well as peak flasher operation.

TBM-3500B MODULATION MONITOR

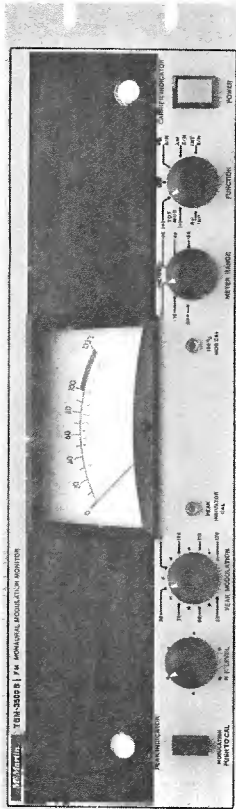

A recent addition to the McMartin monitor line is the new FCC type approved TBM-3500B base-band monitor. The TBM-3500B is used for the measurement of all the wide band modulation parameters of the RF carrier. Two composite outputs feature flat frequency response beyond 100 kHz with accurate duplication of the original modulation signal. As with the TBM-3700, the TBM-3500B may be used for stereo and/or SCA monitoring when used with the TBM-2200A and TBM-2000B.

The TBM-3500B also features an optional A1-A plug in, low level card to allow operation of the monitor with RF input signal level as low as 350 microvolts obtained from an antenna, with minimal degradation of composite signals and frequency response extending to 100 kHz. The standard A-1 RF card requires operation directly from the transmitter pickup with an input level of .01 to 1 watt. The RF attenuator is located on the front panel for setting the RF level to the correct value.

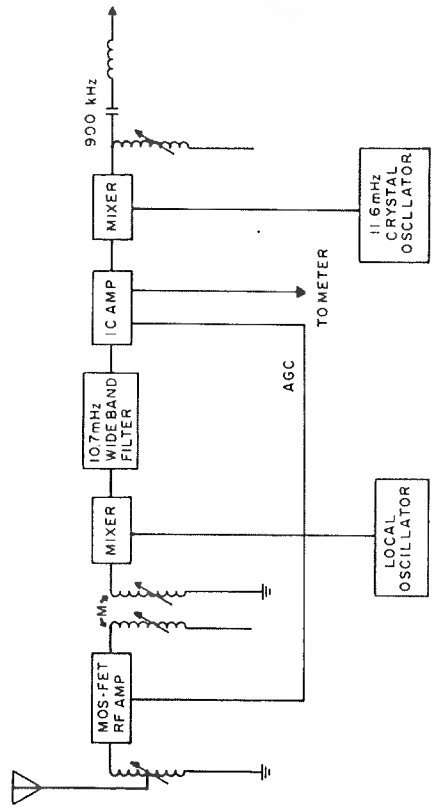

Figure 2

I have a block diagram of the low level A1-A card, figure 2.

The input signal is fed through a preselector coil to a low noise MOS FET RF amplifier. This is followed by two high Q coils feeding an integrated circuit (IC) mixer operating in a differential mode. The local oscillator operates at 10.7 MHz below the carrier frequency thus producing an IF frequency of 10.7 MHz. The 10.7 MHz signal is fed to a special 10.7 MHz bandpass filter with a bandwidth of 530 kHz at the 3 dB points and extremely sharp skirts with a 50 dB bandwidth of only 850 kHz. Thus giving good rejection to alternate channels.

The linearity is such that minimal degradation occurs and excellent distortion exists at frequencies up to 100 kHz measured with a wide band distortion meter.

The signal from the filter is fed to an IC amplifier with a gain of at least 70 dB and exceptionally hard limiting. This hard limited signal is fed to a second bipolar mixer. An 11.6 MHz crystal oscillator is mixed with the 10.7 MHz signal producing a 900 kHz IF signal which is fed into the 900 kHz amplifier, limiter, and demodulator identical to the demodulator card used in the TBM-3700. Thus, the same internal calibration scheme is used in the TBM-3500B as in the TBM-3700.

The integrated circuit used following the wideband 10.7 MHz filter has provision for supplying AGC voltage to the RF amplifier providing excellent RF gain control and allowing operation of the monitor with signals as high as one volt without creating phase error in the recovered composite signal.

The integrated circuit also supplies a squelch signal. The squelch point is purposely set at 350 microvolts as signals below this level are subject to noise which can cause erroneous modulation readings due to the wide band width of the composite signal.

The modulation meter will indicate the RF level when the function switch is in the RF level position. Any signal over 85 percent indicates adequate RF input for proper operation of the low level card.

The circuitry following the demodulator is identical to the modulation portion of the TBM-3700.

TBM-2200A STEREO MONITOR

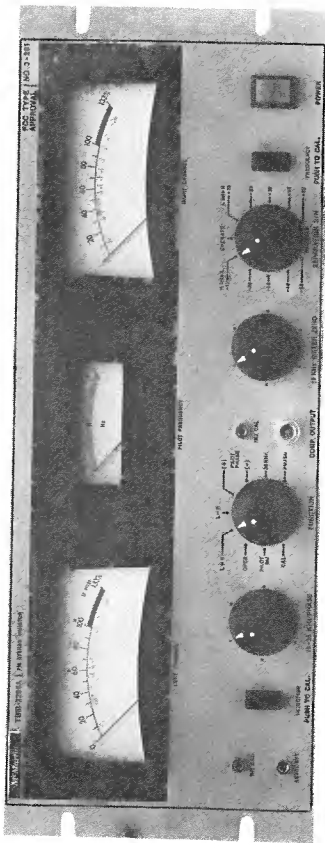

The new TBM-2200A stereo monitor has the capability of measuring the frequency deviation of the 19 kHz pilot carrier within ± 2 Hz, in increments of 0.1 Hz, as well as all other parameters of the stereo signal. Two modulation meters are used. The left meter indicates pilot injection, left channel modulation, L+R modulation and 38 kHz carrier suppression. The right meter indicates right channel modulation and L-R modulation.

Figure 3 on the following page explains the operation of the internal calibration facilities for measuring the 19 kHz pilot injection level of the TBM-2200A stereo monitor.

The proper operating level is determined by the 60 Hz internal calibration signal from the TBM-3700.

With the 'Push to Cal' switch depressed on the TBM-3700/TBM-3500B base band unit, the internal 60 Hz calibrate signal is fed via a coaxial interconnecting cable to the input of the stereo monitor. The front panel recessed 'level set' control A of the TBM-2200A is adjusted to give a reading of exactly 100 percent on the left meter with the function switch in the 'Cal' position. This sets the operating level with a signal equal to 100 percent modulation.

Tracing the signal in Figure 3, note that the 60 Hz signal from the 'level set' control is fed through the No. 1 section of the 'Push to Cal' switch SW-1. This signal then continues to the 'Calibrate' position of the function switch and is routed through a meter amplifier (not shown) to the left modulation meter.

When the 'Push to Cal' switch on the TBM-2200A is depressed, the following events occur simultaneously: NOTE: The 3 sections of the switch are now in the 'C' position.

A 190 kHz crystal oscillator and ± 10 circuitry is activated by switch No. 3. The stable 190 kHz oscillator frequency error is divided by 10 producing a very accurate 19 kHz square wave signal which is fed through a 19 kHz low pass filter. This removes all harmonics, resulting in a very low distorted 19 kHz signal fed to the recessed 'Internal Cal': Control B. The 19 kHz signal from this control is fed through the center arm of switch No. 1 directly to the function switch 'Cal Position' through a meter amplifier (not shown) to the left modulation meter. The 'Internal Cal' control B is adjusted for a reading of 100 percent on the left meter. This adjusts the 19 kHz signal to a level equal to 100 percent modulation. Voltage divider R-1 and R-2 divide this 19 kHz signal to a level of exactly 10 percent modulation. This signal is fed through the center arm of switch No. 2 to the selective 19 kHz amplifier feeding the recessed 'Inj. Cal. Control C.'

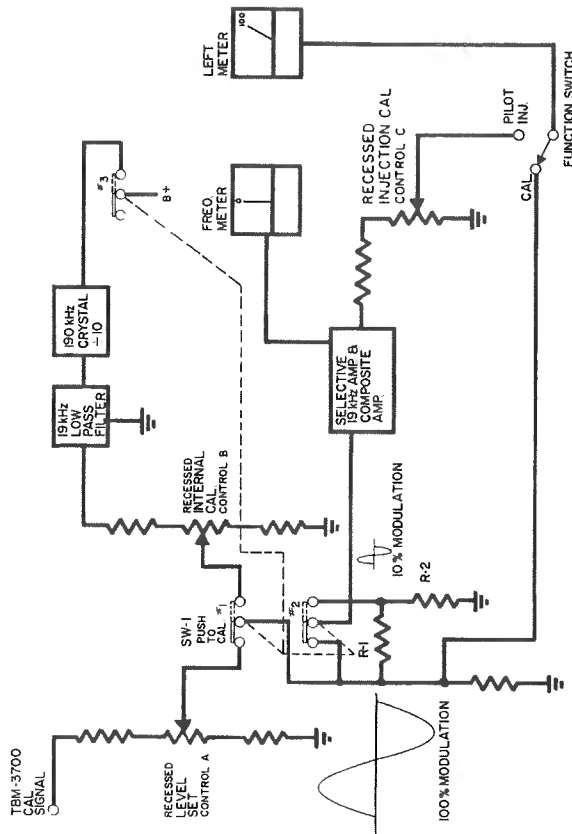

Figure 3

With the function switch in the 'Inj. Position' and with the 'Push to Cal' switch SW-1 depressed, the 10 percent calibrate voltage is now routed through the highly selective 19 kHz measuring circuits and through the function switch to the meter amplifier and left meter. The recessed 'Inj. Cal' control C is adjusted for a reading of 10 percent injection on the meter. The pilot injection accuracy is specified as ± 0.2 percent error.

The 'Push to Cal' switch serves an additional function, that of calibrating the zero center of the 19 kHz frequency meter.

Another method of calibrating the zero center of the frequency is incorporated. This is accomplished by depressing the 'Freq. Push to Cal' switch located on the right side of the monitor. This operation allows checking the frequency meter zero calibrate at any time without interrupting any other function or program material.

Simultaneous monitoring of the total left and right channel modulation is possible with the TBM-3700/TBM-3500B and TBM-2200A combination. Complete remote monitoring facilities of the left and right modulation and pilot frequency are available.

TBM-2000B SCA MONITOR

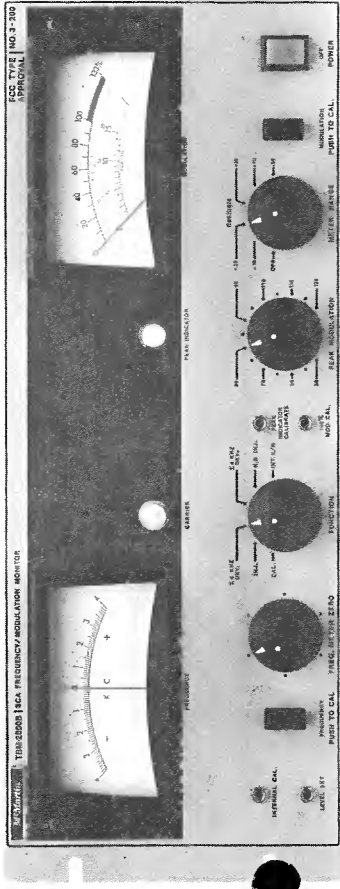

The TBM-2000B SCA add-on monitor has built-in facilities for calibration of the SCA injection and modulation measuring circuits, identical to the TBM-2200A.

The desired SCA channel crystal oscillator is used to calibrate the frequency discriminator, the internal injection measuring circuits, and the modulation meter.

With the 'Push to Cal' switch depressed on the TBM-3700/TBM-3500B base band unit, the internal 60 Hz calibrate signal is fed via a coaxial interconnecting cable to the input. The front panel recessed 'Level Set' control is adjusted for a reading of exactly 100 percent modulation.

The calibration system of the SCA injection measuring circuits in the TBM-2000B differs from that used in the TBM-2200A only in that a 67 kHz or other specified SCA channel calibration frequency is used.

One special feature of this monitor is the use of a dual bandwidth filter. This filter compares a narrow band section that is used to accurately measure the injection level of subcarriers separated by only 5 kHz. The second section is a wide band, phase linear filter used for audio recovery of the FM modulated signal. It also permits accurate monitoring of injection level at any time with full SCA modulation. The narrow band filter is useful only in measuring an unmodulated carrier as the injection level will vary considerably when modulation sidebands are produced which extend beyond the restricted bandwidth characteristic of the filter.

A crystal reference oscillator and circuitry similar to the TBM-3700/TBM-3500B are used for establishing 100 percent modulation. 100 percent modulation, equivalent to ± 6 kHz or ± 4 kHz frequency deviation, is switch selectable by the operator.

A crystal reference oscillator and circuitry similar to the TBM-3700/TBM-3500B are used for establishing 100 percent modulation. 100 percent modulation, equivalent to ± 6 kHz or ± 4 kHz frequency deviation, is switch selectable by the operator.

The 67 kHz reference oscillator is gated to produce a P-P deviation of 67 kHz. This deviation is divided down to a P-P deviation of either 12 or 8 kHz for internal reference level.

The TBM-2000B, like the TBM-3700 or TBM-3500B, has provision for verifying the inherent noise characteristics of the monitor. An internal crystal oscillator is substituted for the incoming signal. Typically the noise level is greater than 70 dB below 100 percent modulation, reference from ± 6 kHz deviation.

The TBM-2000B has remote monitoring facilities of the frequency, modulation, and peak flasher.