

Station Speech Input Equipment

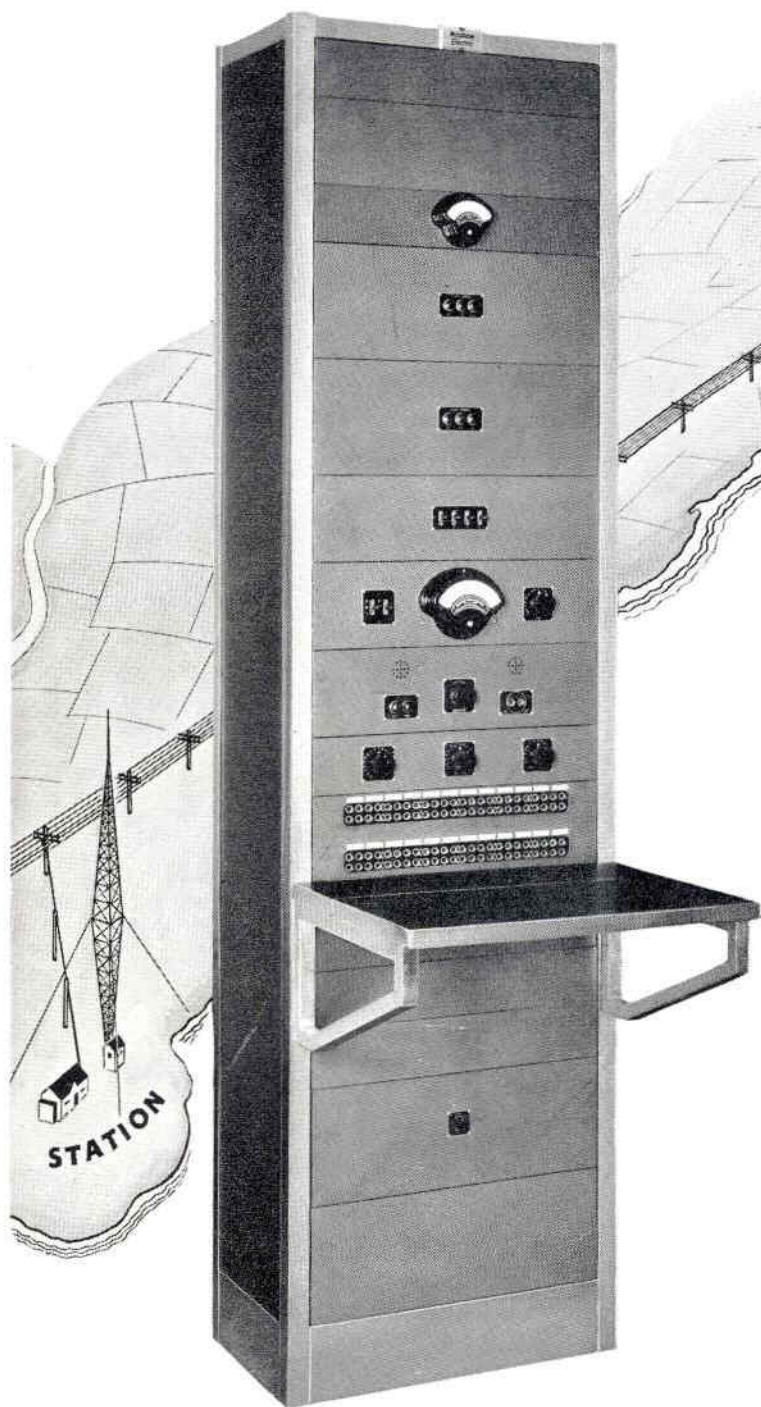

No. 15A

Western Electric

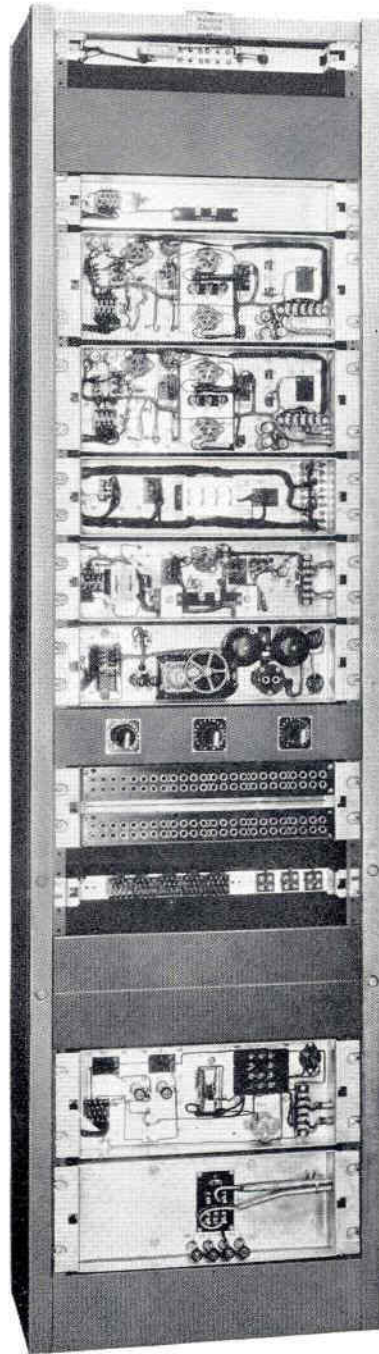

*No. 15A Speech Input Equipment
Front view with mats removed*

STATION SPEECH INPUT
EQUIPMENT

No. 15A

READ THESE REQUIREMENTS

before choosing Speech Input Equipment for your station.

1. FREQUENCY CHARACTERISTICS

The frequency characteristic of a speech input system should be such that the output is a faithful electrical copy of the sound input. This requires that the frequency response of the successive stages of amplification be uniform over the entire audible frequency range.

2. PROGRAM ENERGY RANGE

There is wide difference between the quantities of program energy produced by the softest and the loudest passages in the same program. It is desirable, therefore, that the entire amplifier system be capable of accommodating a wide range of sound levels without distortion or the introduction of spurious harmonics.

3. CIRCUIT FLEXIBILITY AND CONTROL

Modern program broadcasting demands flexibility in control facilities. It must be possible not only to handle programs with facility during normal operation but also to switch with absolute precision in emergencies.

4. POWER SUPPLY

Speech input equipment should be operated entirely from the commercial AC power mains to eliminate the time and expense of battery maintenance and increase the over-all dependability of the equipment.

5. APPEARANCE

Broadcasting stations are showrooms—they help to convince customers of a station's ability to handle programs satisfactorily. Equipment should be substantial, up to date and attractive in appearance. It must create the impression of efficiency and dependability.

6. ECONOMY

To save time and expense, assembling, wiring and testing should be done at the factory before shipment. The equipment should occupy little space and require minimum of maintenance and supervision during operation.

Western Electric 15A Speech Input Equipment meets these requirements and provides many other advantages.

Western Electric
Station Speech Input
Equipment

No. 15A

A development of Bell Telephone Laboratories, the research laboratories of the American Telephone and Telegraph Company and the Western Electric Company

THE Western Electric 15A Speech Input Equipment is a self-contained unit for use with a radio transmitter situated at a distance from the studios.

The equipment consists principally of the 700A Speech Input Bay, see frontispiece, which is an assembly of the amplifiers, volume indicator, potentiometers, meter panels, jacks and other circuit accessories for one amplifier channel. This apparatus is assembled on a series of panels, mounted in a steel cabinet, completely wired and tested before leaving the factory. A block schematic of the equipment is shown on page 9.

The 15A Speech Input Equipment is designed to accommodate four incoming program circuits and two telephone order wire circuits. Due to the quietness of the program channel, noise is below the threshold of audibility when the gain is adjusted for normal operation.

Unequal transmission losses which may be encountered in a non-loaded cable program circuit are compensated for by a line equalizer. This equalizer will compensate for a much wider band of frequencies than has been utilized heretofore in program transmission circuits. The equalizer is associated normally with program circuit No. 1 but it may be connected to any of the other incoming circuits by the use of patching cords. Space and wiring are provided for the addition of a second equalizer.

Terminals for two outgoing circuits are furnished; one for the regular transmitter and the other for a standby radio transmitter.

A number of spare jacks and circuit terminations permit additions to or modification of the input and output circuits should these become necessary.

STATION SPEECH INPUT EQUIPMENT, NO. 15A

Complete switching facilities are provided by four three-position lever-type keys. These control the program circuits, announcing microphone, monitoring circuit and output lines to the radio transmitters.

Program energy levels throughout the system are controlled by means of a master gain control potentiometer associated with the line amplifier. A second gain control potentiometer is associated with the monitoring amplifier. A potentiometer also is provided for the radio transmitter monitor circuit to adjust the level from the radio transmitter monitor output so that a direct comparison of the input and the output of the transmitter can be obtained readily. The entire equipment is controlled manually by means of these three potentiometers, the four switching keys and the master power switch of the rectifier.

Jacks at the necessary locations permit access to any part of the circuit. Patching cords and plugs are not required in the normal operation of the equipment, as the circuits are continuous through the jack contacts.

The high level line amplifier and the associated master gain control potentiometer are identical electrically to the monitoring amplifier and its gain control potentiometer and may be interchanged by means of patching cords in emergencies. The use of separate amplifiers for the monitoring circuit and for the radio transmitter circuit completely isolates the monitoring system from the transmitter feed. This eliminates danger of short circuits or grounds in the monitoring system causing similar trouble on the transmitter line. It also prevents noise from being introduced in the transmitter circuits due to switching or other disturbances in the monitoring system.

Space is available for the addition of a low level amplifier and its associated filter when there is a studio at the radio station or when electrical transcriptions are to be used.

The 15A Speech Input Equipment is a distinct improvement in appearance over equipment used in the past. The cabinet is finished in dark gray with satin-finished chromium plated trim and baseboard. Dark gray mats are used as front covers. Mounting screws and holes are completely eliminated from the face of the equipment by fastening the mats to the apparatus panels from the rear.

The terminal strips and internal wiring for each panel are in the depressed part of the panel and may be exposed easily by removing the mat. All of the apparatus on the backs of the panels is completely enclosed and protected from dust and mechanical injury. The various panels are mounted

STATION SPEECH INPUT EQUIPMENT, NO. 15A



*15A Speech Input Equipment
(700A Speech Input Bay)*

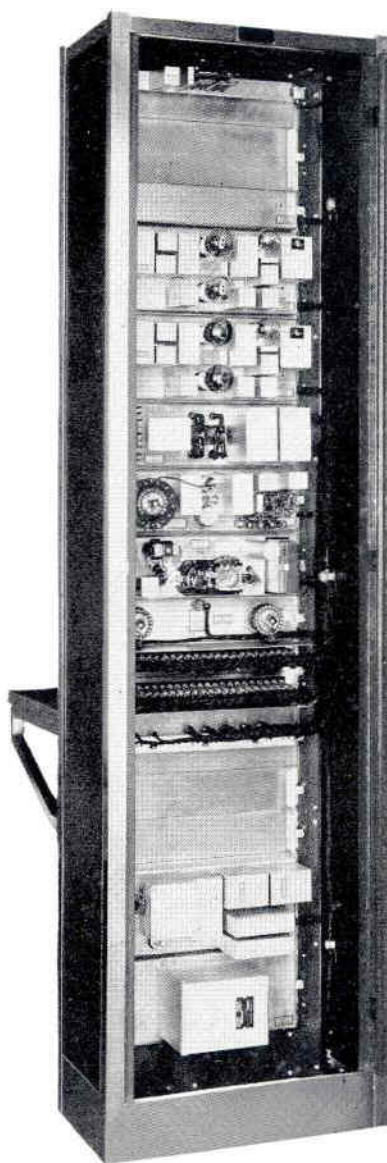

*Rear view with door open showing
major components on panels*

STATION SPEECH INPUT EQUIPMENT, NO. 15A

in the cabinet in a manner which provides maximum convenience of operation. At the rear of the cabinet is a steel door with a locking device and a safety switch. The apparatus on the backs of the panels is accessible through the rear of the cabinet. When the door is opened the safety switch automatically shuts off the main power supply and so protects the operator from contact with high voltage.

The power supply system consists of a rectifier with self-contained filters and a voltage regulating transformer which operates from the commercial 105-125 volt, 60 cycle AC power supply. If desired, the equipment may be arranged to operate from a 50 cycle line. The power system functions automatically to maintain the proper voltages for the vacuum tube filaments. It is designed for the constant loads required by the two high level amplifiers and the volume indicator and may be used also with a filter to furnish power to the low level amplifier, when the latter is added to the equipment.

The power drawn from the supply line by the 700A Speech Input Bay is indicated by the following typical values:—

<i>Line Voltage</i>	<i>Watts</i>	<i>Volt Amperes</i>
105	160	270
115	168	345
125	176	447

In addition to the units comprising the 700A Speech Input Bay, the equipment includes the following:

- Moving coil microphone for emergency station announcements.
- Table mounting, cord and outlet for use with the microphone.
- Monitoring loud speaker.
- Vacuum tube and fuse for the plate supply rectifier.
- 4½ volt battery for the telephone panel.
- Patching cords equipped with plugs for special switching and for testing purposes.
- Vacuum tubes for the amplifiers and volume indicator.

DESCRIPTION OF APPARATUS UNITS

262A Meter Panel

The 262A Meter Panel contains a milliammeter for measuring the plate currents of the vacuum tubes in the 82A and 81A Amplifiers. Push button keys are provided on the amplifiers for the purpose of making these measurements.

Western Electric

[9]

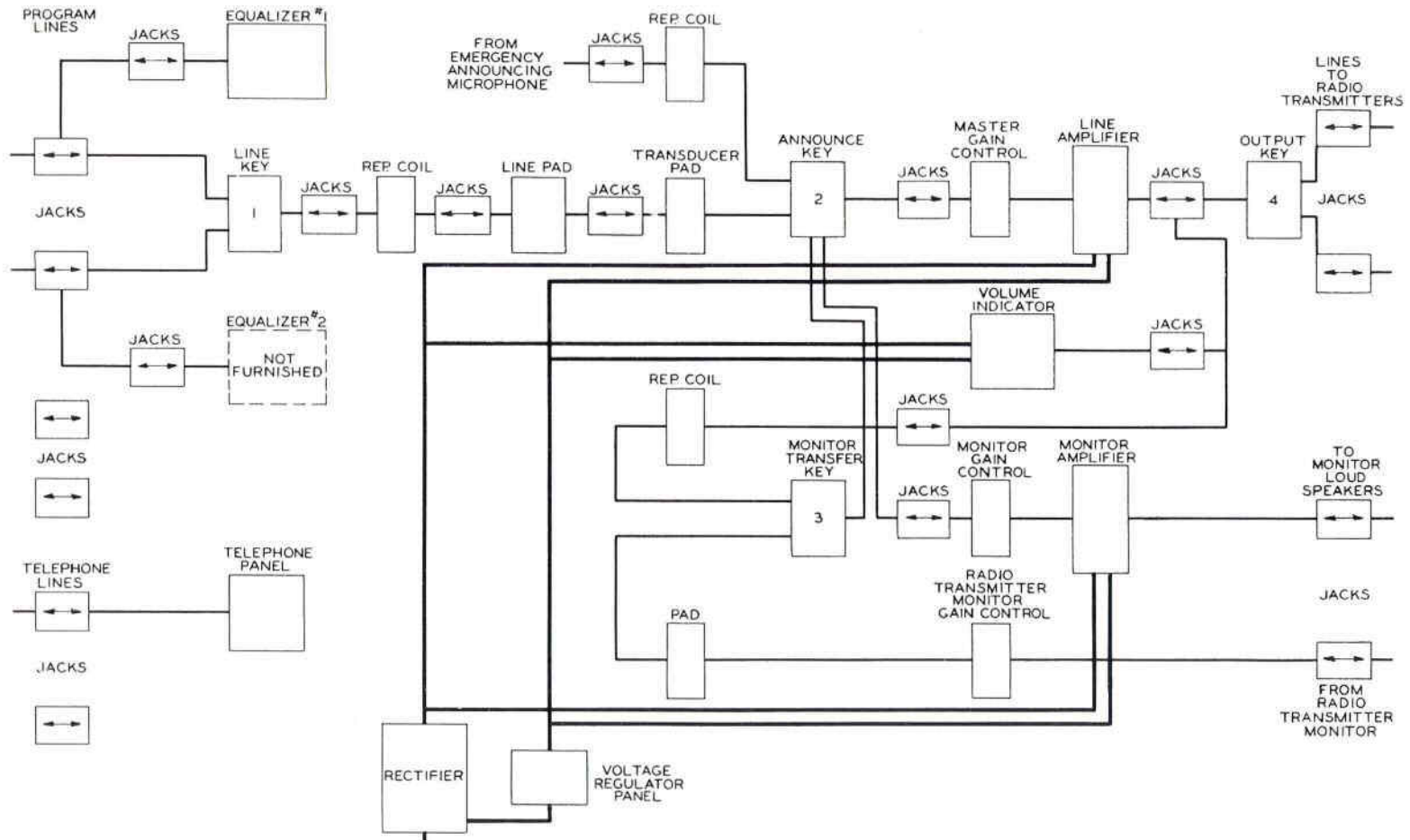

FROM 105-125 VOLTS A.C. 50~ OR
60~ POWER SUPPLY

A.C. OPERATED

Block Schematic 15A Speech Input Equipment

STATION SPEECH INPUT EQUIPMENT, NO. 15A

STATION SPEECH INPUT EQUIPMENT, NO. 15A

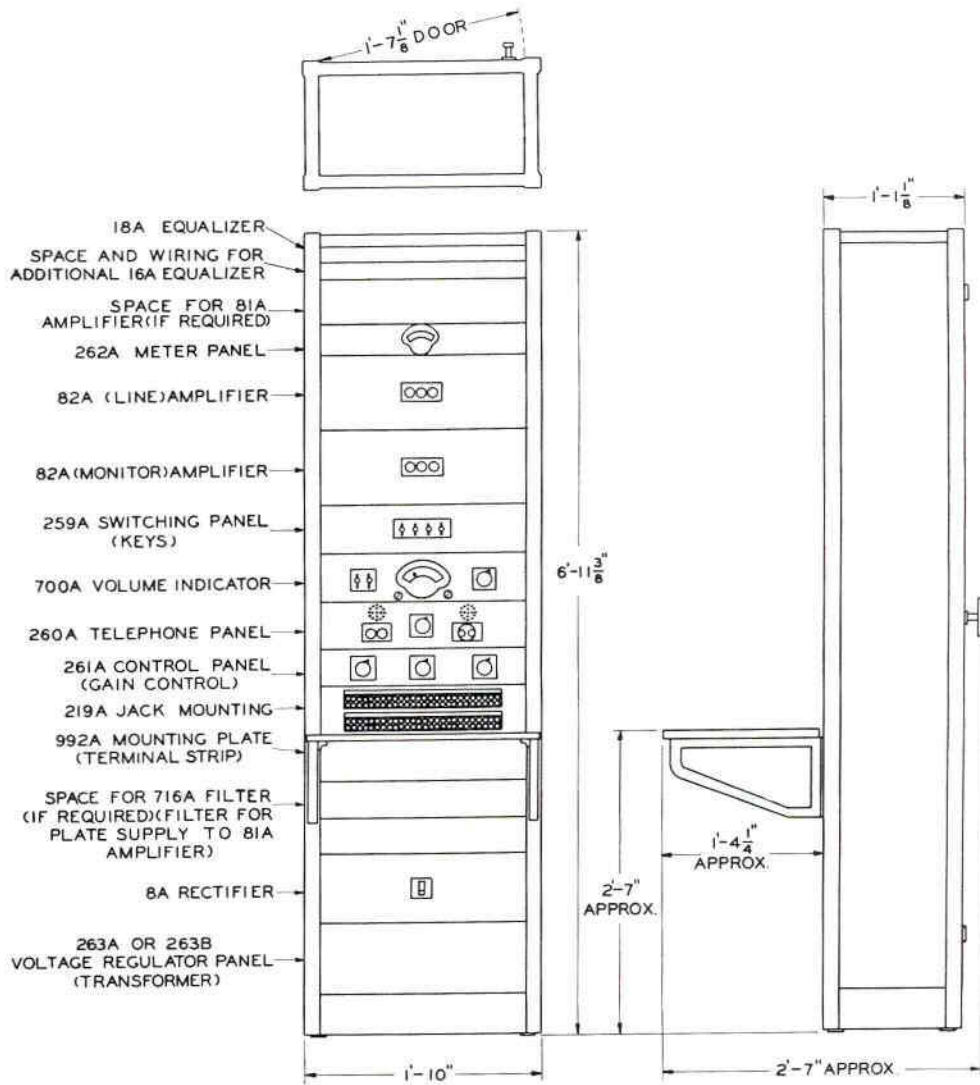

Dimensional Drawing of 15A Speech Input Equipment

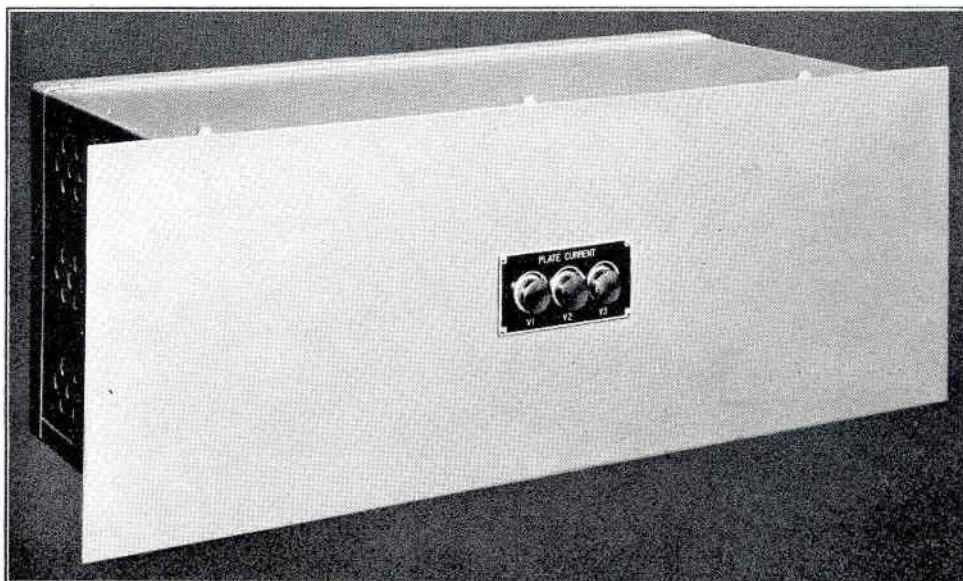

82A Amplifier

82A Amplifier (High Level)

The 82A Amplifier is a two-stage, fixed gain, transformer-coupled amplifier capable of producing an output energy level of approximately +24 db with less than 1% total harmonic introduced by the amplifier. It is designed to operate from the associated circuits in the 700A bay and into an impedance of 500 ohms with a gain of approximately 61 db and a frequency response characteristic which is uniform within approximately 1 db from 30 cycles to 10,000 cycles per second. The output transformer is tapped so that an output impedance of 250 ohms may be obtained when desired.

259A Switching Panel

On this panel are the four three-position, lever-type keys which are used in switching the program circuits, announcing transmitter, monitoring circuit and the output lines to the radio transmitter. The panel also contains the compensating and artificial line resistances used in the equipment as well as the three repeating coils which are parts of the complete system.

700A Volume Indicator

The 700A Volume Indicator is a single stage, voltage amplifier and copper oxide rectifier unit which, with its calibrated meter, is capable of registering energy levels from -18 to +42 db in 2 db steps with mid-scale indication. Including the meter scale calibration, the extreme range of energy levels measurable with this equipment is from -25 db to +45 db.

Western Electric

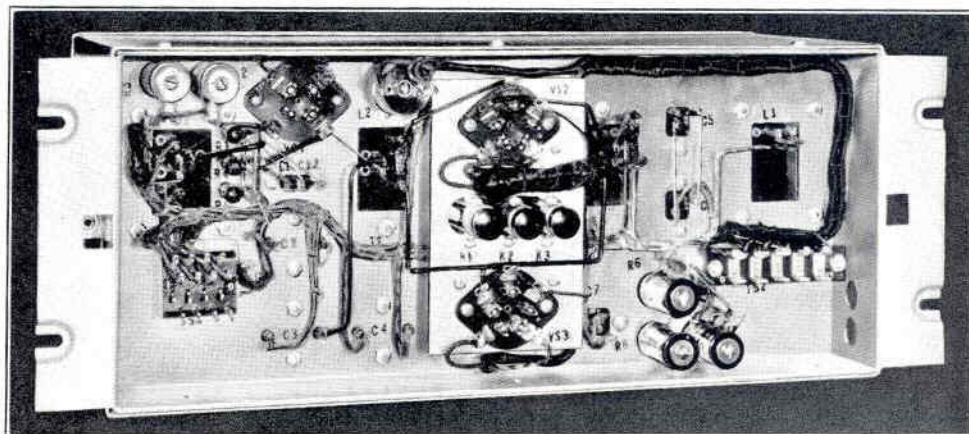

82A Amplifier with mat removed

The meter has a large and easily readable scale. It is of the highly damped type so designed that in following the envelope of the instantaneous peaks and valleys of sound, its indications correspond more closely to the action of the human ear than do those of previous design. The indication given is, therefore, a true picture of the program level as a listener would hear it.

The meter scale is calibrated to indicate energy levels from 7 db below to 3 db above the mid-scale reference level. In other words the scale is marked from -7 db to +3 db with 0 (reference level) at mid-scale and with the interval from -2 db to +2 db divided in $\frac{1}{2}$ db steps. Like the 82A Amplifier, this apparatus is capable of responding uniformly to all frequencies within the range from 30 cycles to 10,000 cycles per second.

The inherent accuracy of indication may be checked from the 10-volt AC filament power supply. Two potentiometers are provided to make adjustments if necessary. This has not been possible with volume indicators in the past, but is particularly important as the full realization of the modulation capabilities of the associated radio transmitter are dependent largely on the accurate determination of the audio input level to the transmitter.

The 700A Volume Indicator is a distinct improvement over other devices for the same purpose because it includes a vacuum tube amplifier between the rectifier and the program circuit. Because of this, the instrument is capable of indicating a wider range of energy levels than other

Western Electric

STATION SPEECH INPUT EQUIPMENT, NO. 15A

volume indicators now in use. The comparatively high impedance of the input transformer results in a low bridging loss in the circuit being measured. The vacuum tube amplifier also obviates the possibility of any modulation in the program circuit due to the characteristic of the rectifier.

260A Telephone Panel

The 260A Telephone Panel provides terminal facilities for telephone communication between the radio transmitting station and a remote studio. This panel may be used with a 206A Hand Telephone Set, an operator's telephone set, or both simultaneously, if desired. It contains a mounting space for a 4½ volt dry battery for the transmitter current and terminals for connecting a 12-volt external battery if it is desired to use this instead of the dry battery. A hand-operated generator is used to signal the distant station. A ringer responds to incoming signals. A ringer control key is provided but in the 15A Speech Input Equipment the key normally is strapped and the bells are in circuit at all times. If desired, the key may be placed in service for disconnecting and reconnecting the bells by cutting the strap.

261A Control Panel

219A Jack Mounting

992A Mounting Plate

The 261A Control Panel contains the three potentiometers which are used to control the energy levels in the several parts of the system. One is the master gain control for the line amplifier. Another is the gain control for the monitoring amplifier and the third is associated with the radio

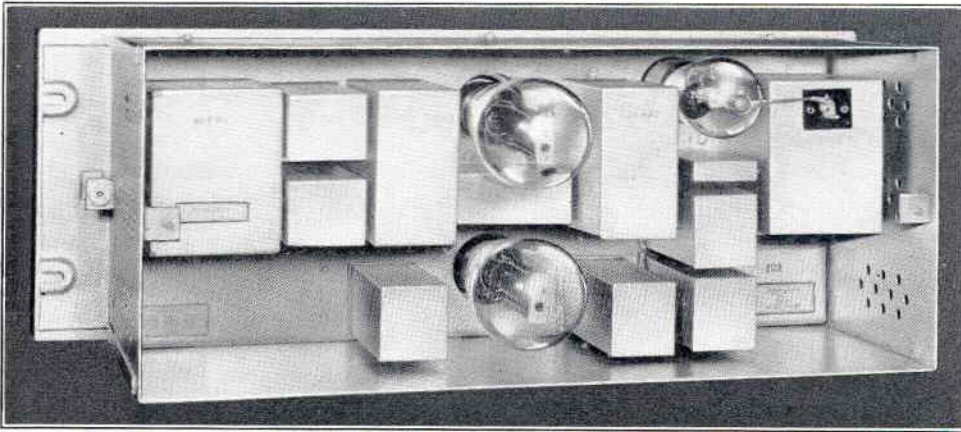

82A Amplifier with rear cover removed

STATION SPEECH INPUT EQUIPMENT, NO. 15A



700A Volume Indicator

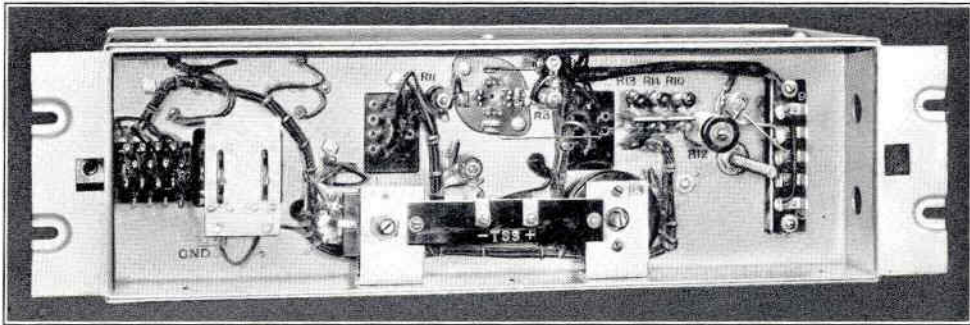

700A Volume Indicator with mat removed

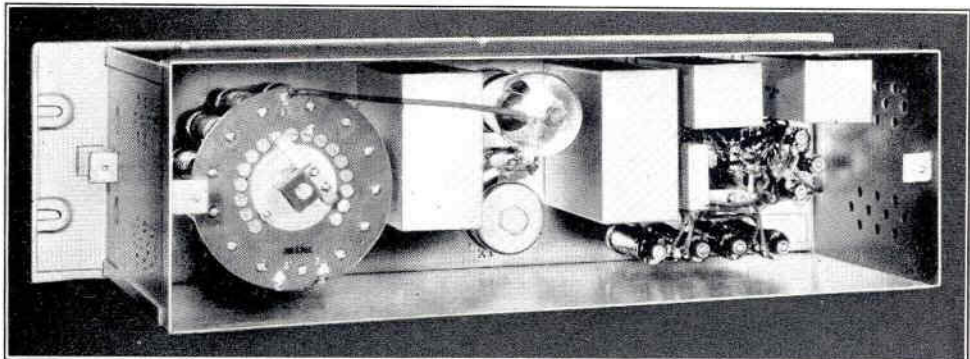

700A Volume Indicator with rear cover removed

transmitter monitoring circuit to adjust the transmitter monitoring level to the input level for ready comparison.

The 219A Jack Mounting occupies the space immediately above the removable writing shelf and contains the jacks necessary for testing and patching connections.

The 992A Mounting Plate serves as a mounting for terminal strips to which is connected the external wiring, such as the program lines and the monitoring loud speakers. The internal wiring of the 700A Speech Input Bay is done at the factory.

8A Rectifier

The 8A Rectifier is a full wave rectifier which contains two filter circuits. Plate power is supplied through one filter to the first 82A Amplifier and through the other filter to the second 82A Amplifier and the 700A Volume Indicator. In addition, terminals are provided for connection to a 716A Filter required when an 81A Amplifier is added to the equipment. The 8A Rectifier unit includes a time delay relay which automatically delays the operation of the 274A (rectifier) Vacuum Tube until the filaments of the vacuum tubes in the amplifiers and the volume indicator have reached their normal operating temperatures.

263A Type Voltage Regulator

This panel contains a voltage regulating transformer for supplying alternating current, at a constant 10-volt potential, to the vacuum tube filaments of the amplifiers. The 263A Voltage Regulator is standard in the 15A Speech Input Equipment and is designed to operate from 105-125 volt, 60 cycle AC supply. Where 105-125 volt, 50 cycle AC supply is to be used the 263B Voltage Regulator is required and will be substituted if specified at the time of ordering.

Moving Coil Microphone and Accessories

A 618 Type Moving Coil Microphone is provided for emergency announcing. The microphone is placed in circuit by operating the "Announce" key which also renders the incoming program circuits and the monitoring circuit inoperative.

The microphone is of the same type as that used in high quality studio work. It has a diaphragm which carries a moving coil suspended in the field of a permanent magnet. The rugged simplicity of its construction insures long and satisfactory life. The diaphragm is protected by a per-

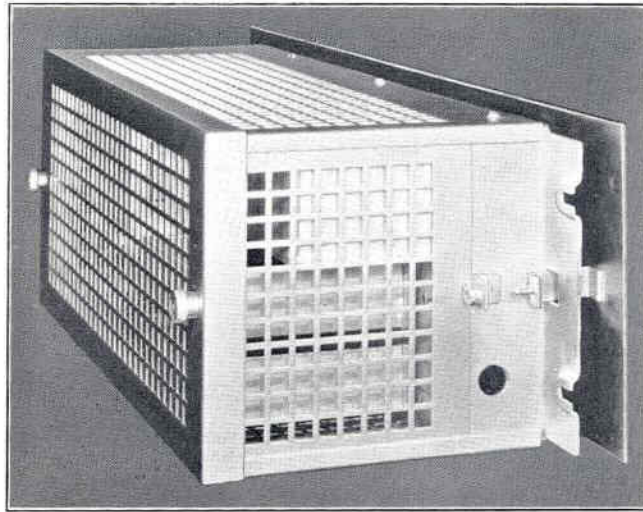

8A Rectifier, Assembly

forated metal grid, covered with silk and held in place by a threaded ring. The grid and the metal shell, which form the housing of the instrument, are insulated from the moving coil and constitute a shield which may be connected to ground.

The desk type mounting has a fixed height of approximately 12 inches. The microphone is held in the mounting by means of an insulating collar and a clamping ring.

The plug associated with the microphone is plugged into a microphone outlet external to the 700A Bay but connected to it through the terminal strip on the 992A Mounting Plate. A 5 foot 2-conductor shielded cord (M3K) is standard equipment. It is equipped with a plug on one end for connecting to the jack on the microphone, and a jack on the other end for connecting to a second plug which is suitable for mounting in a single unit switchbox.

The microphone, mounting, plugs and jacks are finished in oxidized bronze.

Monitoring Loud Speaker

A dynamic type loud speaker is used for monitoring. As previously noted the monitoring amplifier is capable of delivering to a matched load (500 ohms) a +24 db level with less than 1% total harmonics introduced by the equipment.

STATION SPEECH INPUT EQUIPMENT, NO. 15A

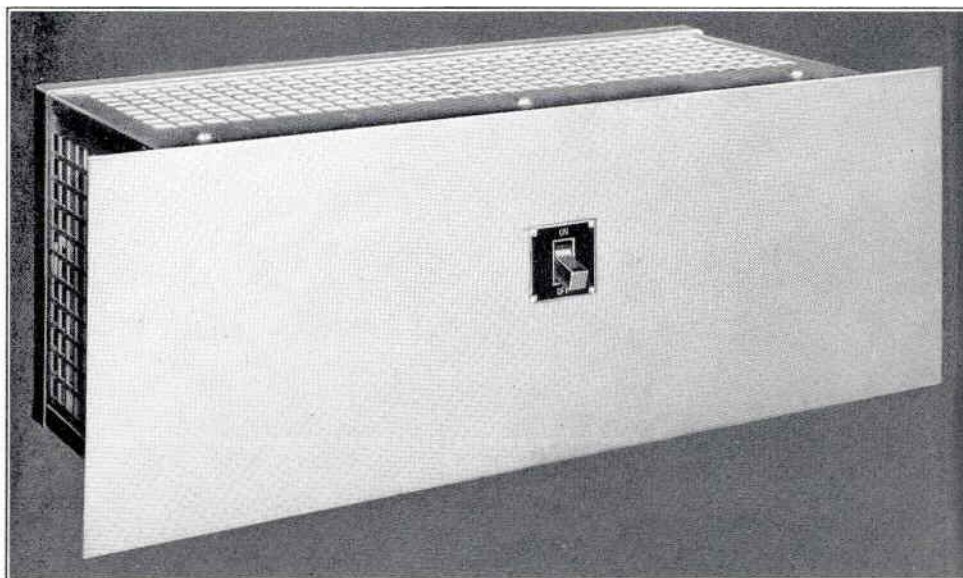

SA Rectifier

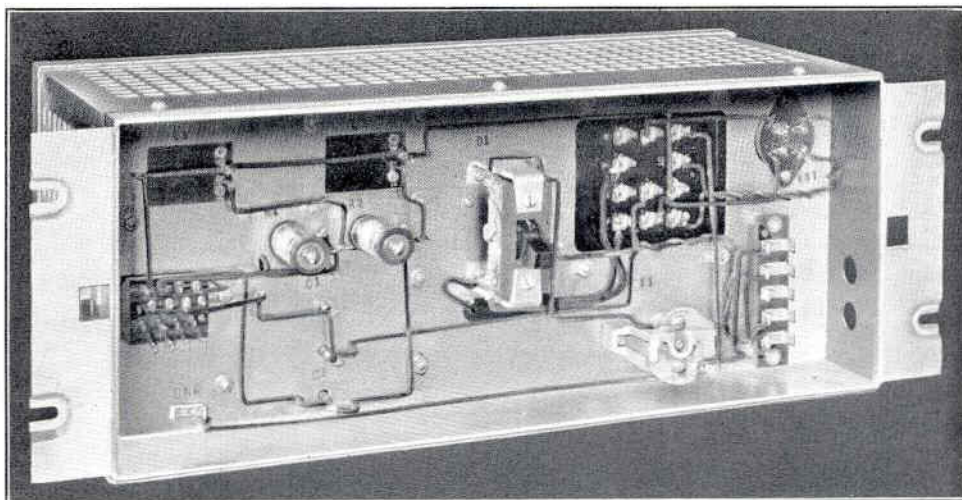

SA Rectifier with mat removed

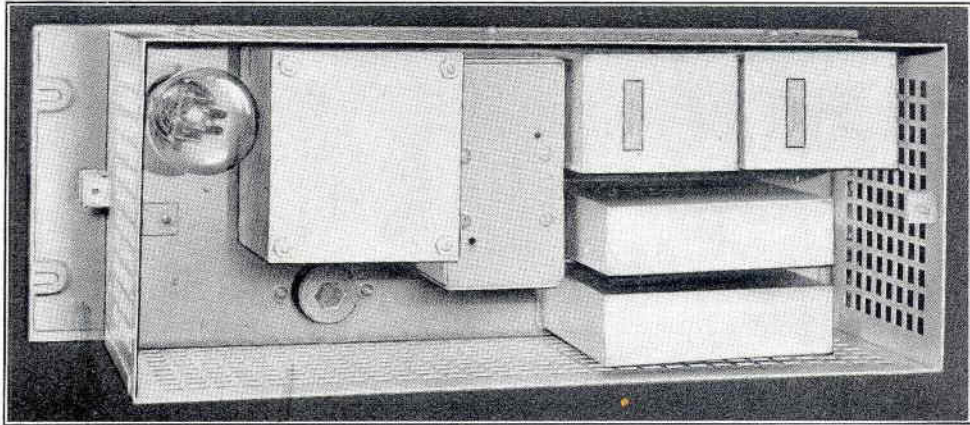

8A Rectifier with rear cover removed

Patching Cords and Plugs

Vacuum Tubes

Western Electric cords, each equipped with two plugs, are furnished as standard equipment. These cords are available in white, red and green colors and in 1, 2, 3, 4 and 6 foot lengths. Plugs are available in black or red shells. Unless specified otherwise, three one foot white cords and three two foot white cords, each equipped with two black shell plugs, will be furnished at the time the order is placed.

One complete set of Western Electric vacuum tubes is furnished for the amplifiers and the rectifier, together with a plug fuse for the commercial power supply to the rectifier.

81A Amplifier (Low Level)

The 81A Amplifier is not furnished with the 15A Speech Input Equipment but may be made a part of the equipment together with a 716A Filter when a studio or electrical transcription equipment is maintained at the transmitter location. The 81A Amplifier is a two stage resistance coupled amplifier having a single frequency output capacity of zero level without distortion. For program material a -10 db energy level may be obtained with less than one per cent. total harmonic. It is designed to operate from a 200 ohm input circuit with a gain of 30 db, 40 db or 50 db, as determined by the position of the flexible connector which is soldered to one of three resistance taps located behind the mat. The frequency response characteristic of this amplifier is uniform within 1 db from 30 cycles to 10,000 cycles per second. Western Electric 262A Vacuum Tubes are employed in this unit with the result that a very low noise level is obtained with complete AC operation as in the case of the 82A Amplifier.

SUMMARY

The Western Electric 15A Speech Input Equipment is the result of many years of experience in providing better equipment for the radio broadcasting industry. Among many features embodied in the new equipment are:

- Complete AC operation from the commercial power main.
- High quality amplifiers with uniform response from 30 to 10,000 cycles per second.
- Greater available undistorted signal output power.
- Greater circuit flexibility and control.
- Improved appearance.
- Unit assembly of the major apparatus components, wired and tested in the factory.
- Required floor space only 22 inches wide by 13 $\frac{1}{8}$ inches deep.
- Moving coil microphone for emergency announcing.
- Low installation, first costs and maintenance.

In addition to the increased flexibility of the circuit and its adaptability to the various possible requirements of a station speech input equipment, the amplifiers and other essential parts embody the latest design features which result in extremely low noise level and the practical elimination of distortion under the rated operating conditions.

The assembling, wiring and testing of the apparatus before shipment from the factory result in reduced installation and first costs. The single rack mounting and careful arrangement of wiring and apparatus greatly facilitate maintenance. Due to its neat appearance, enhanced by chromium trim, the apparatus will make an attractive addition to the equipment of any radio broadcasting station.

FOR FURTHER INFORMATION

For additional information regarding the 15A Station Speech Input Equipment, you are requested to address any Western Electric distributor who is listed on the last page of this bulletin.



DISTRIBUTOR IN THE UNITED STATES

Graybar

ELECTRIC COMPANY

Akron
Albany
Asheville
Atlanta
Baltimore
Beaumont
Birmingham
Boston
Brooklyn
Buffalo
Charlotte
Chicago
Cincinnati
Cleveland
Columbus

Dallas
Davenport
Dayton
Denver
Detroit
Duluth
Durham
Flint
Fort Worth
Grand Rapids
Hammond
Harrisburg
Hartford
Houston
Indianapolis

Jacksonville
Kansas City
Knoxville
Los Angeles
Louisville
Memphis
Miami
Milwaukee
Minneapolis
Mount Vernon
Nashville
Newark
New Haven
New Orleans
New York (2)

Norfolk
Oakland
Oklahoma City
Omaha
Philadelphia
Pittsburgh
Portland
Providence
Reading
Richmond
Roanoke
Rochester
St. Louis
St. Paul

Salt Lake City
San Antonio
San Francisco
Savannah
Seattle
Spokane
Syracuse
Tacoma
Tampa
Toledo
Washington
Wichita
Worcester
Youngstown

A NATIONAL ELECTRIC SERVICE

DISTRIBUTOR FOR CANADA AND NEWFOUNDLAND

Northern Electric Company Limited

General Sales Offices: 1261 Shearer Street, Montreal, P. Q.

Branch Houses

Halifax
Saint John, N. B.
Quebec
Montreal

Ottawa
Toronto
Hamilton
London

Windsor
New Liskeard
Sudbury
Winnipeg

Regina
Calgary
Edmonton
Vancouver

FOREIGN DISTRIBUTORS

International Standard Electric Corporation

67 Broad Street

New York, U. S. A.

Associated, Allied or Affiliated Companies

ARGENTINA

Cia Standard Electric Argentina, Casilla de Correo 49, (Street Address, Defensa 143), **Buenos Aires**

AUSTRALIA

Standard Telephones and Cables (Australasia) Ltd., 71 York Street (P. O. Box 525-B), **Sydney, N. S. W.**

AUSTRIA

United Telephone and Telegraph Works, Ltd., Dresdner Strasse No. 75, **Vienna, XX/2**

BELGIUM

Bell Telephone Manufacturing Co., 4 Rue Boudewyns, P. O. Box 526, **Antwerp**

BRAZIL

International Standard Electric Corp., Caixa Postal 430, (Street Address, Rua Visconde de Inhauma, 64), **Rio de Janeiro**

CHINA

China Electric Co., Ltd., 240 Kiangse Road, (P. O. Box 289), **Shanghai**

CZECHOSLOVAKIA

Standard Electric Doms a Spolecnost, Samova, U 1, 664, **Prague**

DENMARK

Standard Electric A/S., Gyldenlovesgade 1, **Copenhagen, V.**

EGYPT

Standard Telephones and Cables, Ltd., Cozzika Buildings, Sharifa Soliman Pasha, **Cairo**

FRANCE

Le Materiel Telephonique, 46-47 Quai de Boulogne, **Boulogne-Billancourt (Seine)**

GERMANY

Standard Elektrizitäts Gesellschaft A/G., Genest Strasse 5, **Berlin-Schöneberg**

GREAT BRITAIN

Standard Telephones and Cables, Ltd., Connaught House, 63 Aldwych, **London, W. C. 2**

HOLLAND

Bell Telephone Manufacturing Co., Scheldestraat 160-162, **The Hague**

HUNGARY

Standard Electric Co., Ltd., Ujpest 4, n. **Budapest**

INDIA

Standard Telephones and Cables, Ltd., Block C2, Clive Buildings, 8 Clive Street, **Calcutta**

ITALY

Standard Elettrica Italiana, Via Vittoria Colonna No. 9, **Milan, 125**

JAPAN

Nippon Electric Co., Ltd., 2 Mita Shikokumachi, Shiba-Ku, **Tokyo**

JAVA

Bell Telephone Manufacturing Co., Bureau in Nederlandsch Oost Indie Riouwstraat, 85, **Bandoeng**

NEW ZEALAND

Standard Telephones & Cables (Australasia) Lt., 24-26 Ballance Street, P. O. Box 638, **Wellington**

NORWAY

Standard Electric Aktieselskap, Hovind, Ostre Akre, **Oslo**

POLAND

Standard Electric Co. W. Polsee, Sp. Z.O.O. Wspolna 53, **Warsaw**

PORTUGAL

Standard Electrica, S.A. Praca Dos Restauradores 47-1, **Lisbon**

RUMANIA

Standard Electric Romana, S. A. 37 Calea Victoriei, **Bucharest, 1**

SOUTH AFRICA

Standard Telephones and Cables, Ltd., Locarno House, Loveday Street, (P. O. Box 1571), **Johannesburg**

SPAIN

Standard Electrica, S/A., Calle Ramirez de Prado (Post Office Box 7040), **Madrid**

STRAITS SETTLEMENTS

Standard Telephones and Cables, Ltd., 57 Robinson Road, (P. O. Box 553), **Singapore**

SWITZERLAND

Bell Telephone Manufacturing Co., 10 Bubenberplatz, **Berne**