

# Audio Facilities

\*\*\* by Western Electric



## INDEX

CUSTOM BUILT STUDIO			
CONTROL DESK .....	24	REPRODUCING GROUP .....	33
25B SPEECH INPUT EQUIPMENT ..	26	LOUDSPEAKERS .....	35
23C SPEECH INPUT EQUIPMENT ..	28	MICROPHONES .....	36
22D SPEECH INPUT EQUIPMENT ..	29	VOLUME INDICATORS .....	38
AMPLIFIERS .....	30	RECTIFIERS .....	38
		COMPONENTS .....	39

# CUSTOM BUILT STUDIO CONTROL DESK

The Custom Built Consoles, now being application-engineered to the customers' requirements by the Western Electric Company, are keynoted by their versatility, utility and attractive appearance. They are as modern as tomorrow and have been designed for application-plus.

Network centers and stations large or small can benefit by the unique performance features that can be engineered into the Custom Built Consoles. Bell Telephone Laboratories' engineers and broadcast equipment specialists of Western Electric and Graybar, working in close cooperation with the engineers of the customer's station, can arrange a combination of standard components into efficient Custom Built Console Assemblies which will enable the operating personnel to produce and dispatch programs of all types with maximum smoothness and professional touch. Problems of studio control or dispatching operations are made easier by the well-rounded planning of this team of engineers.

Large or theatre-type studios where multiple microphone pickups must be used for variety shows, those used for special event broadcasts in which fast switching is imperative, and multiple studio operation are only a few of the difficult assignments for which these consoles are ideally adapted.

Since a major factor in high fidelity broadcasting is the smooth functioning of the studio control equipment, too much emphasis cannot be placed upon the advisability of using flexible, convenient, high quality equipment at this point.

## Controls Conveniently Located

In a typical Custom Built Console the controls most frequently used are located at arm-rest height. No fatiguing arm-twisting movements are required to operate them. Volume indicators are located to facilitate the engineer's observation both of the program level and the studio action. Patching panels, which increase flexibility of operation, are located where they can be used most conveniently. The cabinet of the Custom Built Console can be blended into contemporary designs of studio architecture. These are only a few of the outstanding features of this equipment.

A typical Custom Built Console, illustrated schematically at the right, includes facilities for the connection of 16 microphones, 2 transcription reproducers, 8 incoming remote lines, and 6 program trunks. Eight pre-mixing amplifiers are provided and are connected through jacks to mixer volume controls to provide high level, noiseless mixing. Thus, a 10-channel

A typical Custom Built Studio Control Desk is shown on the cover of this Audio Facilities Section — Page 23.

mixer circuit will provide normally, 6 microphone inputs, 2 transcription turntable inputs, and 2 line inputs, individually or simultaneously in any combination to blend one program. Patching jacks will allow further combinations. (For example, if necessary for special shows, up to 10 microphones could be patched up for simultaneous operation.)

Three of the microphone mixers feed through a single submaster volume control so that the level of three inputs may be adjusted simultaneously by a single control.

A two-input reverberation mixer for patching in ahead of the regular mixer controls is provided as is one set of high and low pass sound-effects filters. Accessory inputs are also provided such as utility level controls, transfer keys, repeating coils, and jack multiples.

Beyond the regular microphone mixer and submaster volume controls, the transmission path goes through a single key identified as the microphone key which serves to connect or disconnect between the regular microphone circuits and the main amplifier channels in a single operation. This key also controls the studio loud-speaker cutoff. Two transcription inputs feed directly into the main amplifier without passing through this key, so that programs not originating through the studio microphones do not cut off the studio loud-speaker.

The two line circuits are regularly nomaled through their own equalizers and repeating coils, each having its own line keys so as to switch between regular and check amplifier circuits.

Each main amplifier channel consists of a pre-amplifier, master volume control, a main amplifier, and an output network feeding an individual volume level indicator meter and into a channel transfer key. The check channel provides means for

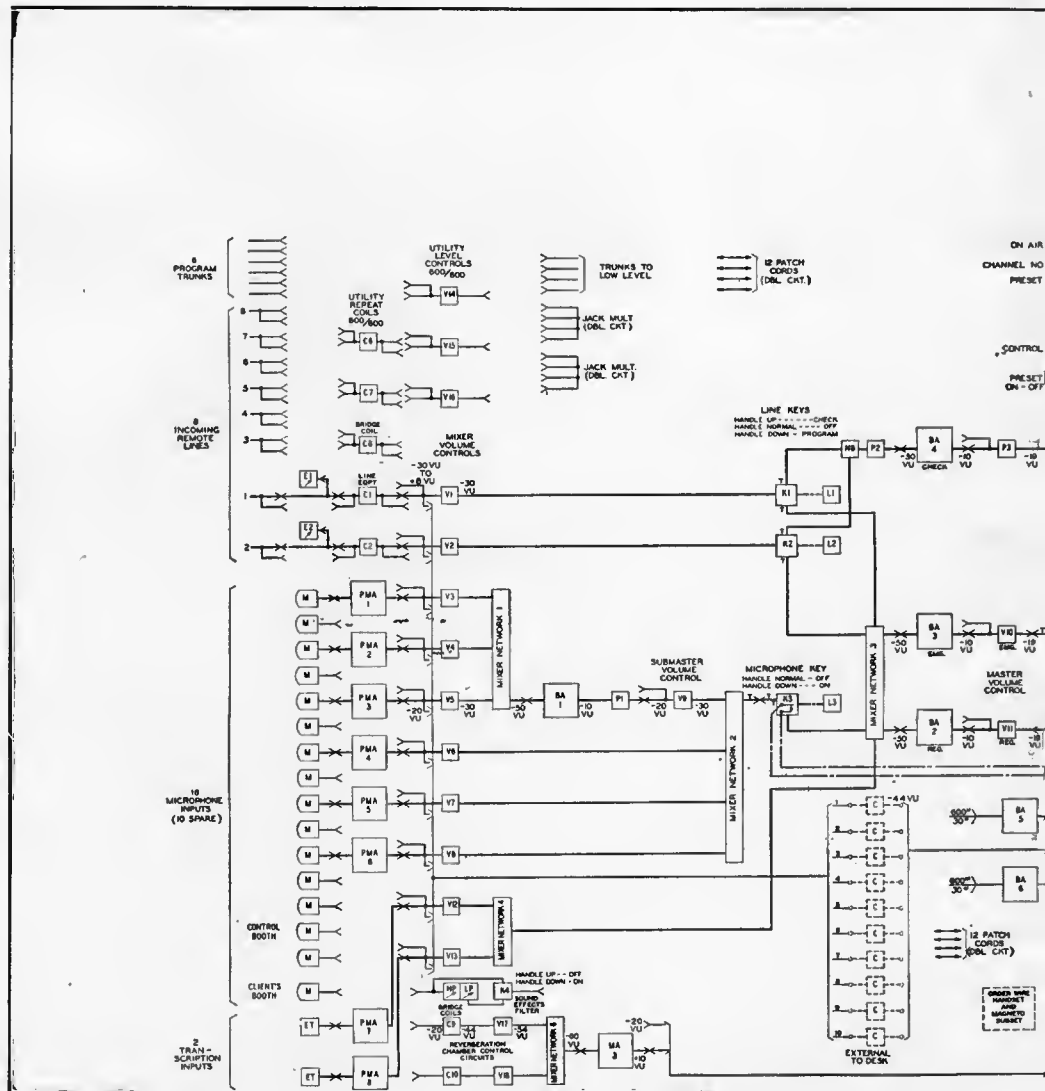

# CUSTOM BUILT STUDIO CONTROL DESK

checking incoming remote line circuits prior to programming.

An output key follows the channel transfer key and has three positions respectively "Rehearsal", "Standby", and "Program" with corresponding indicating lamps.

A cue selector key provides cue monitoring from the master control, and pre-set keys and lamps on the main control panel give visual indication of what is being fed from the studio at any given time.

Located on the main control panel directly in front of the studio control booth operator, a single large bull's eye lights to indicate when the studio line is cut through to the outgoing transmission line by master control. Monitoring circuits are provided for the inputs ahead of the output key as well as the additional three outputs for recording, house monitor, and audience sound reinforcement.

A tube checking circuit is incorporated to allow routine checks on the condition of all tubes, so that they can be removed before the end of their useful life and thus

the highest quality and continuity of transmission can be maintained.

## Maximum Accessibility

The equipment layout and cabinet construction have been planned to provide a maximum of accessibility to all of the equipment for inspection and maintenance. The upper portion of each cabinet contains the jack panels, secondary controls, repeating coils, and like apparatus; the lower portion houses all of the amplifiers which are mounted in tiers and preferably arranged for plug-in connection. Thus, for replacement and maintenance, they can be easily withdrawn from within the operating space through removable panels. There is no necessity of moving the console or of tying up the studio facilities for more than short maintenance intervals. This unique feature reduces the studio "out of service" time for equipment maintenance to an absolute minimum.

The main control panel, mounting the

mixers and switching controls, swings upward on hinges for easy accessibility.

Desk frameworks are of metal and are normally finished in attractive aluminum gray colors with a narrow, bright chromium strip around the front and sides of the desk at shelf level. However, they can be finished to harmonize with any studio color scheme specified by the architect.

A separate cabinet, for wall mounting, contains the rectifier units supplying the plate and heater power to the amplifiers and the rectifier for the signal supply. Also, located in this cabinet are the switches, circuit breakers, relays, and pilot lights for operation and control of the power supply equipment, as well as relays for loud-speaker and studio sign control.

Progressive AM broadcasters cannot afford to overlook the application-plus engineering incorporated in these Custom Built Consoles. Western Electric quality, built into all of the program carrying units, also provides the best that is available for the FM broadcaster.

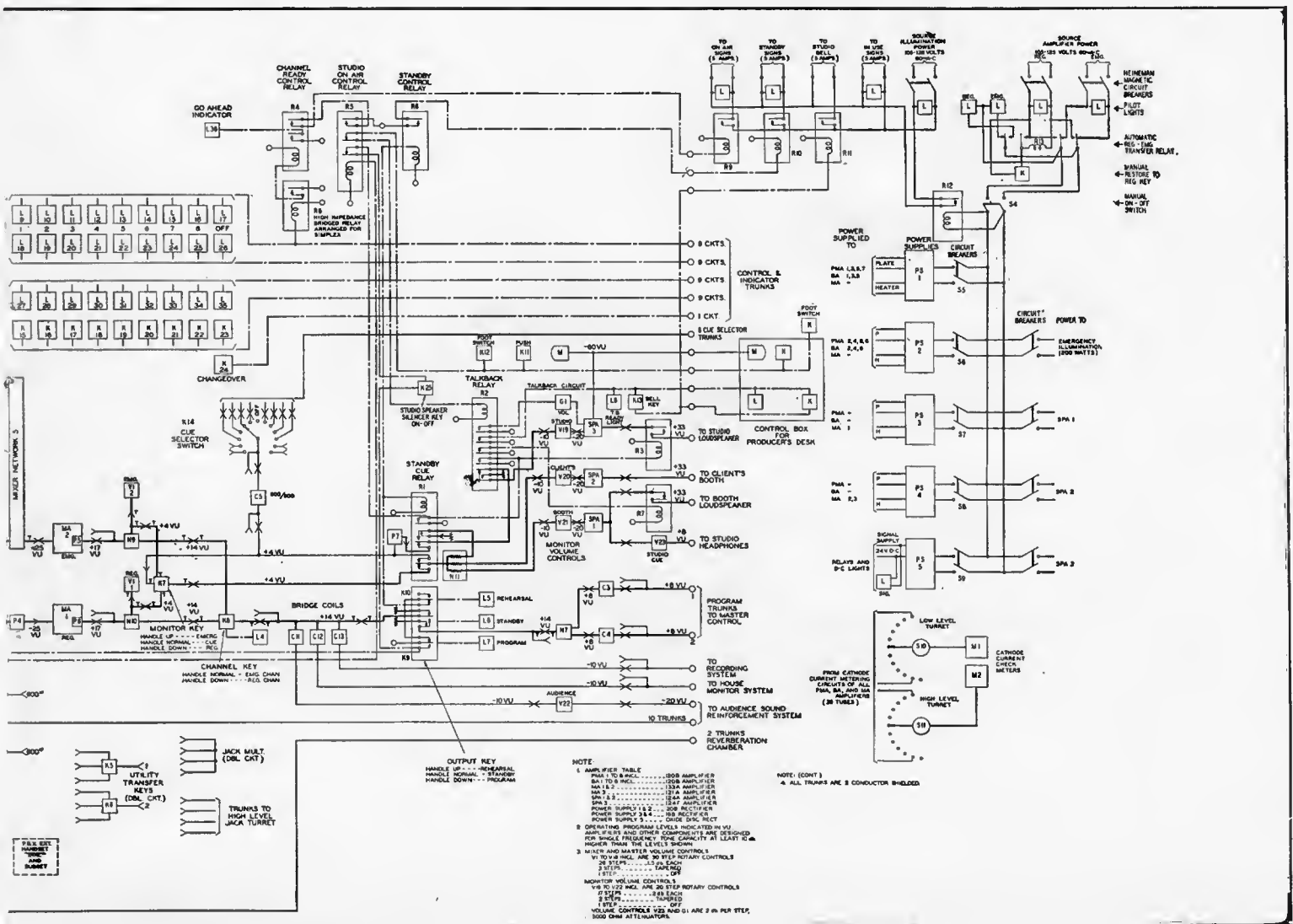

# 25B SPEECH INPUT EQUIPMENT

A console type program production unit which incorporates a number of basically new ideas in design and operation. Designed particularly for broadcasters using FM transmission, or for AM stations planning for FM at some future date, the 25B provides uniform, noise-free and distortionless operation over a 15,000 cycle range. It provides dual program channels capable of simultaneous operation on different programs.

Quiet but attractive styling and harmonious blending of dark blue table top, dark gray cabinet and stainless steel trim results in a thoroughly practical and colorful design. The 25B will enhance the appearance of even the most luxurious studio. Every part of the console is made accessible for inspection or maintenance by simply lifting the hinged upper section, or lowering the units below the table—as easy as opening the covers of a book.

The console houses two complete high quality main amplifier channels, capable of simultaneous operation on different programs without interference or crosstalk. Also within the console is a third high level amplifier for loudspeaker monitoring and cueing operations. This arrangement is especially valuable to stations operating



both AM and FM transmitters or simultaneously originating both local and network programs.

On the control panel there is a seven channel mixer circuit and two master level controls. The console provides terminals for eight microphone or low level transcription input circuits and four pre-amplifiers, with switching keys for selection of either of two low-level inputs for each pre-

amplifier. Four of these circuits can be used simultaneously, with four in reserve available at a moment's notice. Three additional simultaneous microphone inputs (total of seven) can be had by using the line mixers as described below.

Three remote line input circuits, with repeating coils, feed incoming line programs to three separate line mixer controls. Selection of remote or network pro-

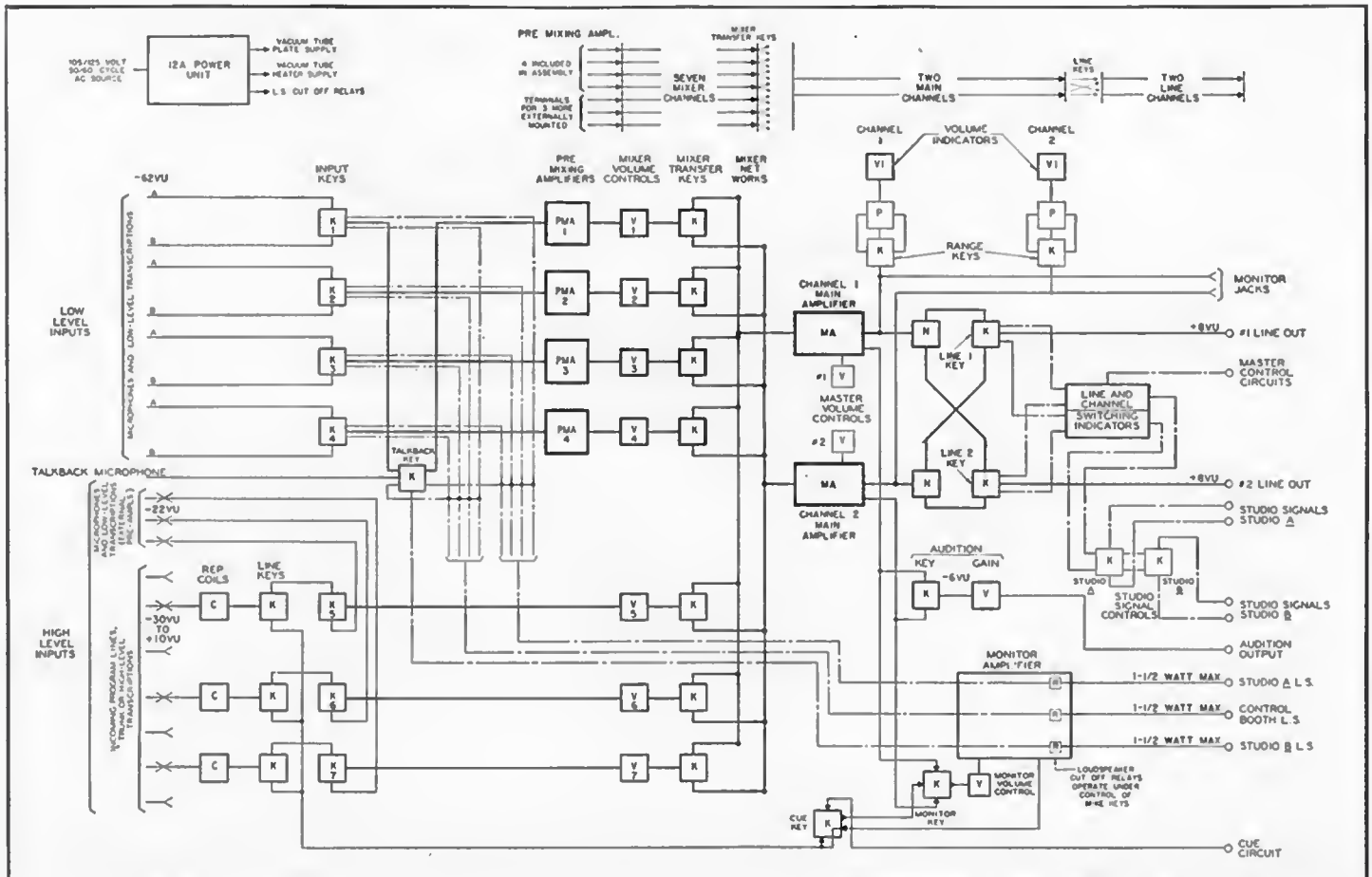

# 25B SPEECH INPUT EQUIPMENT



Operator at 40A Console mounted in KS-10284 Table. Controls are grouped functionally with frequently used controls nearest operator and all controls within convenient reach. Low over-all height and location of console contribute to increased operator efficiency and reduced operating strain. Over-all height is 3 feet from floor and 8½ inches from writing surface. Over-all length of table is 54½ inches and control panel 48 inches. From front to rear it is 28½ inches and from control panel to rear 13½ inches.

grams is speeded by three remote line switching keys, usable for selecting any one of three lines for monitoring incoming programs, or for connecting to the associated mixer input. Patching jacks, with which four additional remote lines can be substituted on a line-for-line basis, make available a total of seven input lines or trunks.

Each of the line mixer inputs is provided with a transfer key to switch a transcription source or microphone pre-amplifier output in place of a line program source. Thus three additional microphone or transcription sources (a total of seven simultaneously) can be accommodated by

providing externally mounted pre-amplifiers. Seven mixer potentiometers for individual adjustment of these input circuits operate on either of the two main amplifier circuits through a seven channel mixer circuit with individual mixer transfer keys.

Two volume indicators and two headphone jacks provide for simultaneous visual and aural monitoring when necessary. A built-in monitor amplifier may be switched to either channel. The cue transfer key switches between the conditions of monitoring on the remote lines, receiving cue from master control, or feeding cue to remote lines. Loudspeaker cut-off relays as well as contacts for operating

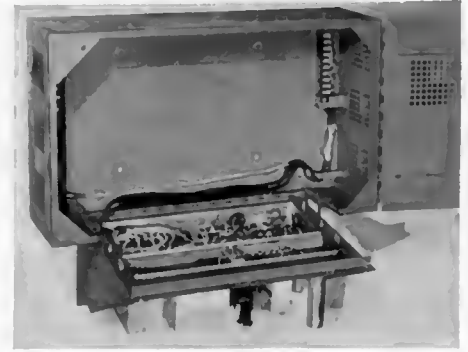

12A Power Unit supplies plate and filament power to all vacuum tubes. View shows equipment swung down to expose wiring. For details see page 39.

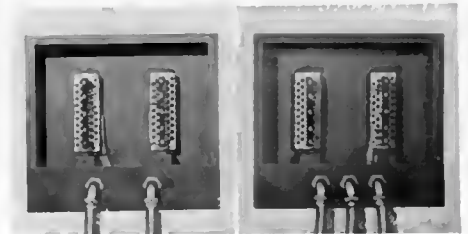

7A Junction Box (left) and 7B Junction Box (right) with cover plates removed. The flexible cables, carrying all connections between studio wiring and console, terminate in multi-contact plugs which plug into the 40A Console. This allows movement of equipment.

warning signs, buzzer cut-offs and other auxiliaries, are provided.

An additional circuit with a gain control and a channel switching key will feed either main channel into a separate local amplifier system external to this equipment for audition circuits, sound reinforcement in large audience studios and similar applications.

Normal operating of the amplifier tubes can be checked quickly by the plate metering circuit with a meter and rotary tap switch for individual plate current measurement.

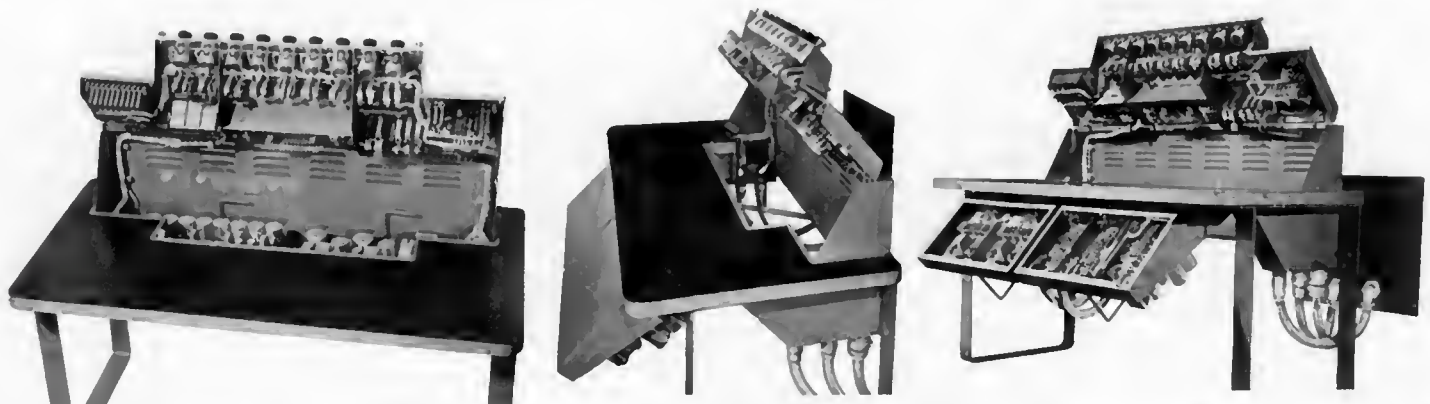

Three views of the 25B showing the 40A Console and the KS-10284 Table with control panel raised and amplifier racks lowered. View at left shows the control panel lifted for access to all keys, jacks, potentiometers and control apparatus and wiring in 40A Console. Lifting this panel also exposes tube side of all amplifiers. Center photograph shows the control panel raised and the amplifier racks

swung forward with dust covers in place, and the flexible cables leading to the 7A and 7B Junction Boxes. At the right the control panel is raised and both amplifier racks swung forward into convenient position for servicing the wiring side of the amplifier. Note clean assembly and wiring and accessibility of all terminals and parts. Table and console together form a practical and colorful unit.

# 23C SPEECH INPUT EQUIPMENT

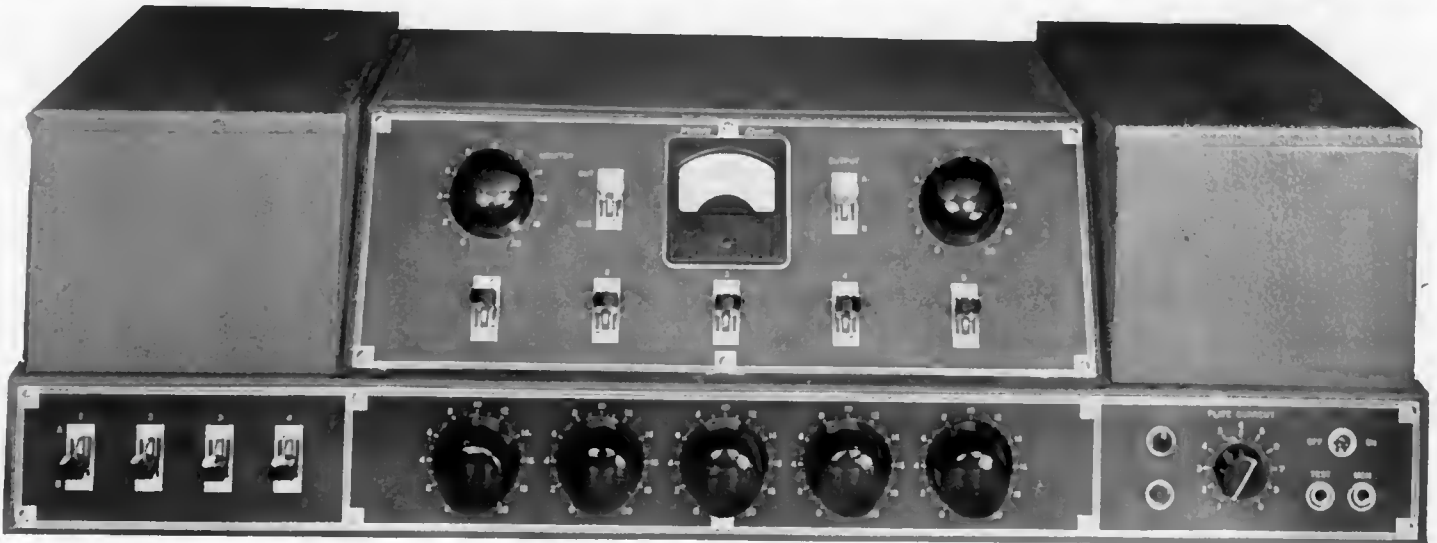

Provides at low cost a complete ac operated amplifier and control console assembly suitable for AM or FM radio broadcasting service. It is a complete studio program production unit capable of serving either one or two studios. It can be used alone or as part of a system incorporating additional program production units whose outputs are coordinated and switched at a common point such as a Master Control Room.

The 23C Console provides complete technical facilities for control of program production and monitoring for studio and transcribed programs as well as for programs originating on incoming lines. It has terminal and switching facilities for permanent connection of eight studio microphones or transcription reproducing equipments, one control room announce and talkback microphone, and four remote lines or program trunk inputs.

The 23C contains a five channel high level mixing circuit, for blending and controlling level on four microphone input circuits, and one input circuit for incoming program lines. The four microphone input circuits each have pre-mixing amplifiers. Following the mixer is a three stage main amplifier with master level control. This main amplifier amplifies the signals to the level required for outgoing program lines or output switching systems in master control rooms. Terminals are provided with the volume indicator meter for an extension meter. Aural monitoring and program cueing is provided by the self contained monitor amplifier which will operate the booth and two studio loudspeakers. Cut-off relays operated from contacts on the microphone keys control loudspeaker circuits.

Other valuable features are: Self contained power equipment (except cut-off

relay supply) for operation from 105-125 volt 50-60 cycle ac source; jack and rotary switch for checking plate current of vacuum tubes with external meter; jack for headphone monitoring of main channel; and key and lamp for signalling use.

## TECHNICAL DATA

**MAXIMUM GAIN:** 96 db from microphone or transcription to outgoing line. 64 db from incoming line or trunk to outgoing line. 51 db from incoming line or trunk to terminals for connecting loudspeaker. 18 db from outgoing line to terminals for connecting loudspeaker.

**MIXER LEVEL CONTROLS:** 20 steps. 17 steps of 1½ db each, tapering to cut-off on last three steps.

**MASTER LEVEL CONTROL:** 20 steps. 17 steps of 2 db each, tapering to cut-off on last three steps.

**MONITOR LEVEL CONTROL:** 20 steps. 19 steps of 2 db, last step cut-off.

**SOURCE IMPEDANCE:** 30 or 250 ohms for microphone or low level transcription circuits; 600 ohms

for program line or trunk circuits.

**OPERATES INTO:** Main amplifier 600 ohm line. Monitor amplifier 750 ohms (three 250-ohm loudspeakers in series.)

**OUTPUT POWER:** Main amplifier: +18 dbm (60 milliwatts) with less than 1 per cent harmonic distortion. Monitor amplifier (divided among three loudspeakers or compensating resistors): 2.5 watts with approximately 5 per cent harmonic distortion; 1.5 watts with approximately 1 per cent harmonic distortion.

**OUTPUT NOISE:** Under normal operating conditions, the noise level is at least 60 db unweighted below normal program level at the output.

**POWER SUPPLY:** 105 to 125 volts, 50 to 60 cycles ac. Approximately 90 watts. Power for relay and signal light operation (12 volts dc, 0.25 ampere) must be supplied from external source. Western Electric KS-7593 Rectifier is recommended.

**DIMENSIONS:** 34" long, 14½" wide and 9¾" high.

**WEIGHT:** Approximately 110 pounds.

**CONSTRUCTION:** Console type cabinet designed to be set on top of a table or desk.

**FINISH:** Chassis and covers — Dark gray crinkled lacquer. Control panels — Black photo-etched.

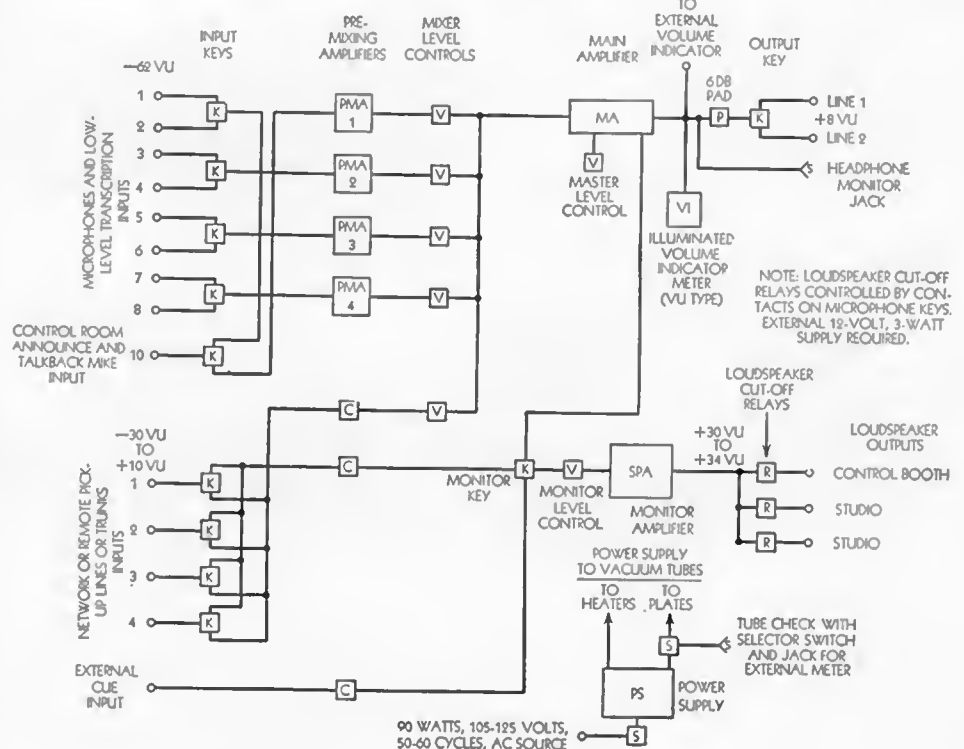

# 22D SPEECH INPUT EQUIPMENT

A compact portable speech input system, light in weight and designed to provide complete pick up facilities for remote broadcast programs. Equipment consists of a combination amplifier and control unit with a carrying case, and either a rectifier unit for ac operation or a battery holder for battery operation or both, as specified, with a carrying case and power supply cord.

The 22D includes a four-channel parallel mixing circuit designed to work with 30-ohm dynamic microphones or other sources of comparable impedance. Master gain control, indirectly illuminated volume indicator, binding posts for two program lines, jacks for two monitoring headsets and both binding posts and a jack for an order wire telephone set are provided.

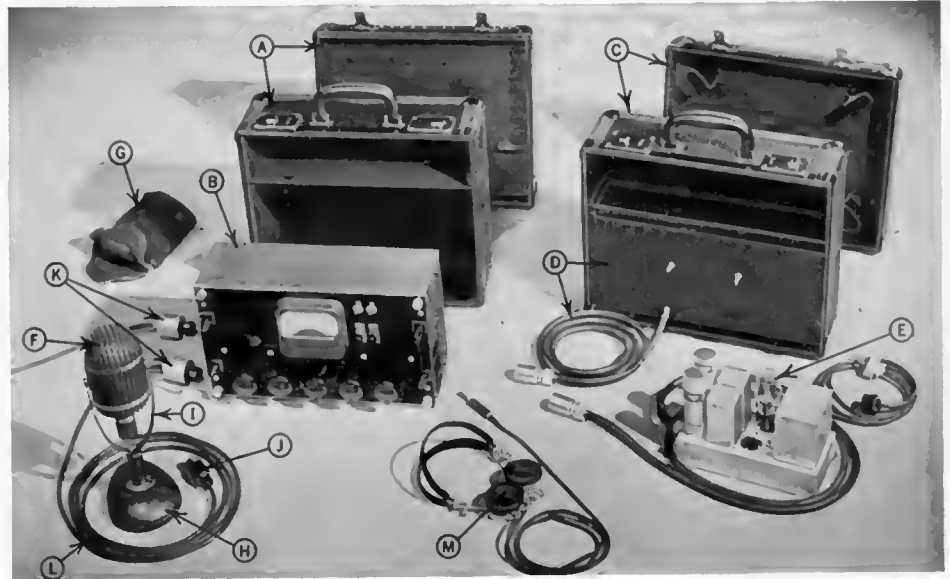

(A) Amplifier-Control Unit carrying case with cover. (B) Amplifier-Control Unit. (C) Power supply carrying case with cover. (D) Battery rack assembly with cord and plug. (E) AC power unit with cord and plug. (F) 639 Type Microphone. (G) KS-12000 Transmitter Cover. (H) 24A Transmitter Mounting. (I) 11A Transmitter Attachment. (J) 442A Jack and 712A Adapter. (K) Microphone plugs. (L) KS-7133 Cordage. (M) 1002F Headset.

## TECHNICAL DATA

**GAIN:** Maximum 92 db.

**MIXER CONTROLS:** 45 db in 20 steps. 12 steps of 1½ db each increasing on the last eight steps to cut-off.

**SOURCE IMPEDANCE:** 30 ohms. (Use 172A Repeating Coil in cord for 250-ohm microphones.)

**LOAD IMPEDANCE:** 150 or 600 ohms.

**OUTPUT POWER:** +28 dbm (600 milliwatts) with less than 1 per cent harmonic distortion. +18 vu maximum program level with 10 db peak factor.

**OUTPUT NOISE:** Noise level is 48 db unweighted and 60 db weighted (normal ear sensitivity curve) below normal program level measured at the output.

**FREQUENCY RESPONSE:** Uniform within ±1 db from 30 to 10,000 cycles.

**POWER SUPPLY:** AC operation—110-120 volts, 56-60 cycles. Power consumption is 28 watts at 115 volts. Battery operation — Filament 1.4 amperes at 6 volts and plate 21 ma at 180 volts.

**DIMENSIONS AND WEIGHT:** Total weight of two units and full equipment 50-60 pounds. Amplifier-control unit 9" high, 15" long and 5" deep; weight approximately 15 pounds. Battery Rack Assembly (equipped)—7" high, 15" long and 5" deep; weight approximately 14 pounds. AC Power Unit—7" high, 12" long and 5" deep; weight approximately 9½ pounds. Carrying Cases (two required)—14" high,

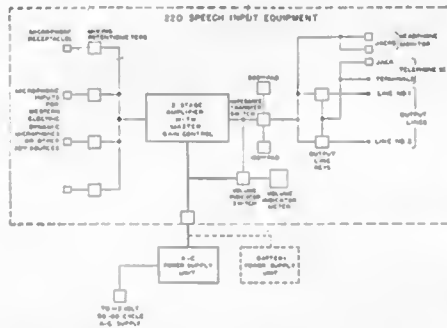

Block schematic of 22D Speech Input Equipment

16¾" long and 7¾" deep; weight approximately 12 pounds each.

**ACCESSORIES:** 633 or 639 Type Microphones, and the 1002F Headset for monitoring purposes, are recommended for use with this equipment.

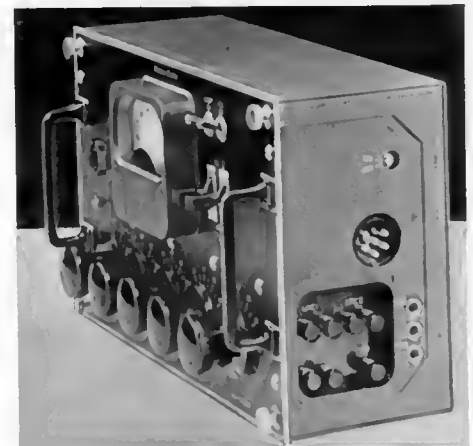

Conveniently placed on the right end of the amplifier control unit are line terminals, telephone binding posts and plug, plug for monitoring headset and the multi-pronged socket for the power supply plug.



Each case is divided into two compartments, providing space for accessories. The lower compartment of the power supply carrying case holds the batteries when battery operation is desired. On top is ac power supply.

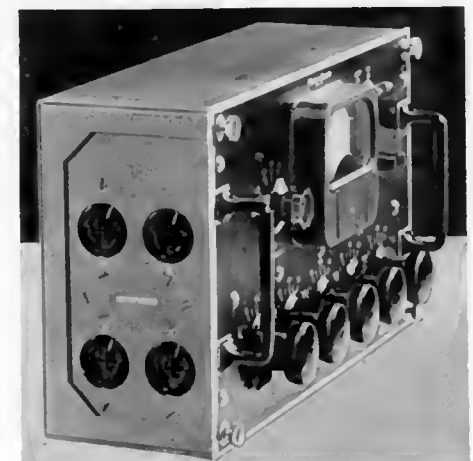

Four plug-in type microphone receptacles are located on the left end of the compact amplifier-control unit.

# AMPLIFIERS

## 106A LINE AMPLIFIER

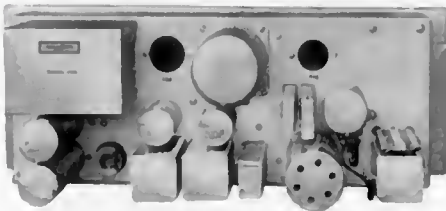

A two-stage unit for line bridging or matching service complete with self-contained power apparatus for operation from external power source. Furnishes isolation between outgoing program lines fed from the same source, and compensates for output switching circuit and line equalization losses. Can also be used as a general purpose amplifier for applications where its gain and power level are adequate.

### TECHNICAL DATA

**GAIN:** 45 db maximum (600 ohm matching connection). 20 db maximum (10,000 ohm bridging connection).  
**GAIN CONTROL:** 38 db in 20 steps (2 db each plus "off" position).  
**SOURCE IMPEDANCE:** 600 ohms (matching or bridging connection).  
**LOAD IMPEDANCE:** Main output 600 ohms. Monitor output 40 ohms (approximately).  
**OUTPUT POWER:** Main output +28 dbm (600 milliwatts) with less than 1 per cent harmonic distortion. Monitor output 20 db less than main output (isolation between main and monitor output 20 db). +18 vu maximum program level with 10 db peak factor.  
**OUTPUT NOISE:** Main output at maximum gain setting -52 dbm unweighted, -68 dbm weighted (normal ear sensitivity curve). Signal to noise ratio 70 db with normal +18 dbm signal output.  
**FREQUENCY RESPONSE:** Flat within 1 db over range 30 to 15,000 cycles.  
**POWER SUPPLY:** 105-125 volts, 50-60 cycles ac, 0.4 amperes, 48 watts maximum.  
**DIMENSIONS:** 19½" wide, 7" deep, 8" high.  
**WEIGHT:** 22 pounds.  
**FINISH:** Chassis, bright aluminum lacquer. Mat, dark aluminum gray or black japan.

## 120B PRE-MIXING AMPLIFIER

A compact, two-stage 40 db fixed gain amplifier unit for either pre-mixing or booster amplifier applications and adaptable as a "no gain" bridging isolation amplifier.

### TECHNICAL DATA

**MAXIMUM GAIN:** 40 db.  
**SOURCE IMPEDANCE:** 30, 250 or 600 ohms matching (For bridging add proper pad).  
**LOAD IMPEDANCE:** 600 ohms.  
**OUTPUT POWER:** Single frequency output power for less than 1 per cent total harmonics: 0.038 watt (+16 dbm), at fundamental frequency of 400 cycles;

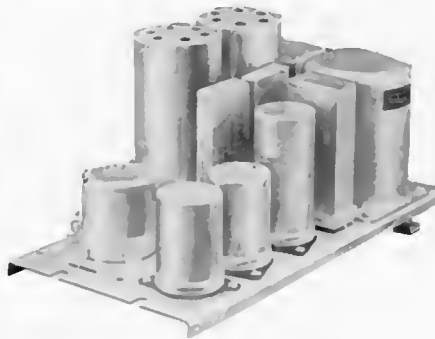

0.02 watt (+13 dbm) at fundamental frequency of 50 cycles.  
**OUTPUT NOISE:** -82 dbm unweighted; -87 dbm weighted. (Normal ear sensitivity curve.) Signal to noise ratio for -20 vu program level output 62 db unweighted, 67 db weighted.  
**FREQUENCY RESPONSE:** Flat within ±1 db over the range 30 to 15,000 cycles; flat within ±0.5 db over the range 50 to 10,000 cycles.  
**POWER SUPPLY:** Filament 6.3 volts, 0.8 ampere; plate 275 volts, 7 milliamperes. (18 or 20 Type Rectifiers recommended for power supply.)  
**DIMENSIONS:** 10 3/16" wide, 5 7/32" deep and 6 3/16" high.  
**WEIGHT:** Approximately 6½ pounds.  
**MOUNTING:** Designed for console mounting; also for rack mounting on a 177 Type Mounting Plate. (Capacity three 120B Amplifiers.)  
**FINISH:** Bright aluminum gray lacquer.

## 121A LINE AMPLIFIER

An adaptable three-stage 78 db fixed gain amplifier unit for use as an intermediate or microphone-to-line level main amplifier in speech input systems.

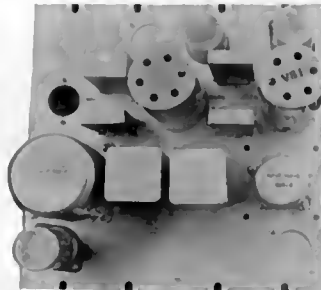

### TECHNICAL DATA

**MAXIMUM GAIN:** 78 db; 70 db by internal connection; 45 db by eliminating first stages.  
**SOURCE IMPEDANCE:** 30, 250 or 600 ohms matching (for bridging add proper pad).  
**LOAD IMPEDANCE:** 600 ohms.  
**OUTPUT POWER:** Single frequency output power for less than 1 per cent total harmonics: 0.6 watt (+28 dbm) for fundamental frequency of 400 cycles; 0.3 watt (+25 dbm) for fundamental frequency of 50 cycles.  
**OUTPUT NOISE:** (Weighting follows normal ear sensitivity curve).

Gain	78 db	70 db	45 db
Noise level:			
Unweighted	-42 dbm	-50 dbm	-75 dbm
Weighted	-52 dbm	-60 dbm	-85 dbm
At +18 vu program level output signal to noise ratio:			
Unweighted	60 db	68 db	53 db
Weighted	70 db	78 db	103 db

**FREQUENCY RESPONSE:** Flat within ±1 db over the range 30 to 15,000 cycles. Flat within ±0.5 db over the range 50 to 10,000 cycles.

**POWER SUPPLY:** Filament 6.3 volts, 2 amperes; plate 275 volts, 30 milliamperes. (18 or 20 Type Rectifier recommended for power supply.)

**DIMENSIONS:** 10 3/16" wide, 10 15/32" deep and 6 3/16" high.

**WEIGHT:** Approximately 10 pounds.

**MOUNTING:** Designed for console mounting; also for rack mounting on a 177 Type Mounting Plate. (Capacity one 121A Amplifier and one 18A Rectifier per plate.)

**FINISH:** Bright aluminum gray lacquer.

## 124A AND 124E MONITOR AND AUDITION AMPLIFIERS

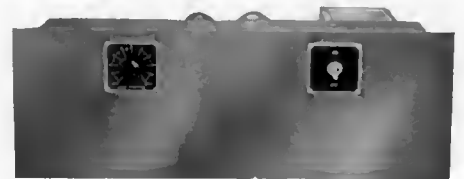
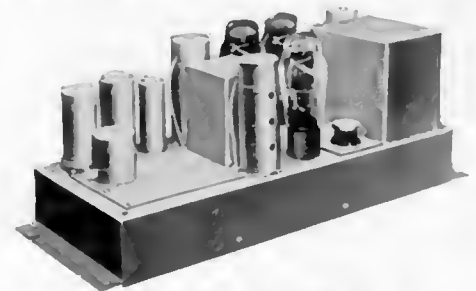

Two-stage rack or cabinet mounted units with a push-pull beam power output stage providing up to 20 watts capacity for driving high quality loudspeakers, line or modulator circuits. They are complete units with inputs for bridging or matching input service, 50 to 63 db gain, and incorporating power supply apparatus for operation from commercial ac power source. Nevertheless the amplifiers are compact, occupying only seven inches of standard rack space, or being especially quiet in operation, may be placed in a loudspeaker cabinet without causing interference. A multi-tapped output coil allows matching load impedances over the wide range of 1 to 1,200 ohms and can be arranged, for example, to feed a low impedance loudspeaker and a 600-ohm line simultaneously.

The 124A and 124E Amplifiers are identical except that the 124E has a gain control and power switch mounted on the face mat and two extra fixed pads in the input circuit for a wider range of input level adjustment.

### TECHNICAL DATA

**MAXIMUM GAIN:** High gain input connection 63 db; bridging input connection 50 db.  
**GAIN CONTROL (124A AMPLIFIER):** None.  
**GAIN CONTROL (124E AMPLIFIER):** 38 db in 2 db steps.  
**SOURCE IMPEDANCE:** 600 ohms nominal impedance.



# AMPLIFIERS

**LOAD IMPEDANCE:** 1 to 1,200 ohms nominal impedance.

**OUTPUT POWER:** 12 watts (+41 dbm) with less than 2 per cent total harmonics as shipped, 20 watts (+43 dbm) with less than 5 per cent total harmonics available with a simple reconnection of taps for higher plate voltage and use of Western Electric tubes.

**OUTPUT NOISE:** -37 dbm unweighted with maximum gain. Signal to noise ratio for 12 watt program level output 78 db unweighted.

**FREQUENCY RESPONSE:** Uniform within  $\pm 1$  db over the range 30 to 15,000 cycles.

**POWER SUPPLY:** 105-125 volts, 50-60 cycles ac, 1.25 amperes, 125 watts maximum.

**DIMENSIONS:** 19 5/32" wide, 7" deep and 7" high.

**WEIGHT:** Approximately 20 pounds.

**MOUNTING:** Standard 19" relay rack occupying 7" of panel space.

**FINISH:** Chassis — Bright aluminum lacquer. Face mat — Choice of dark aluminum gray or black japan.

**FREQUENCY RESPONSE:** Uniform within  $\pm 1$  db over the range 35 to 15,000 cycles.

**POWER SUPPLY:** 105-125 volts, 50-60 cycles ac, 1.25 amperes, 125 watts maximum.

**DIMENSIONS:** 19 5/32" wide, 7" deep and 7" high.

**WEIGHT:** Approximately 20 pounds.

**MOUNTING:** Standard 19" relay rack occupying 7" of panel space.

**FINISH:** Chassis — bright aluminum lacquer. Face mat — dark aluminum gray or black japan.



116B Pre-amplifier — Used in 124F, 124G and other amplifiers. Employs dc bias gain control.

## 124F MONITOR AND TALKBACK AMPLIFIER

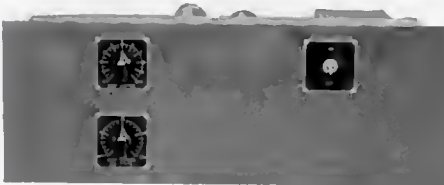
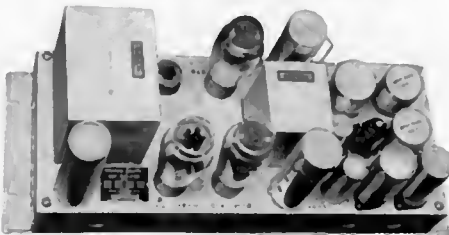

Like the 124E Amplifier except that it has separate line level and microphone level input circuits each with its own gain control. Microphone input includes one 116B Pre-amplifier. In addition to the other features described for the 124E the 124F provides a means of feeding programs to booth and studio loudspeakers, as well as cue-feeding to remote lines, either from low level sources or from line or bus level sources. The low level circuit allows talkback and cue to performers in an associated studio.

### TECHNICAL DATA

**MAXIMUM GAIN:** Line level input 60 db (600 ohm matching connection); 45 db (20,000 ohm bridging connection). Low level input 104 db.

**GAIN CONTROL:** Line input 20 db in 1 db steps. Low level input 35 db continuously adjustable.

**SOURCE IMPEDANCE:** Line input 600 ohms matching or bridging. Low level input 15 to 250 ohms.

**LOAD IMPEDANCE:** 1 to 1,200 ohms nominal impedance.

**OUTPUT POWER:** 12 watts (+41 dbm) with less than 2 per cent total harmonics as shipped, 20 watts (+43 dbm) with less than 5 per cent total harmonics available by a simple reconnection of taps for higher plate voltage and use of Western Electric tubes.

**OUTPUT NOISE:** -8 dbm unweighted, under maximum gain conditions (signal approximately 50 db above noise).

## 124G MONITOR AND AUDITION AMPLIFIER

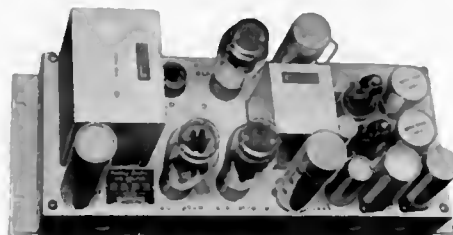

Like the 124E Amplifier except that it has two separate microphone level input circuits each with its own gain control and 116B Pre-amplifier. In addition to the other features described for the 124E, the 124G provides a means for program blending of two inputs from microphone or reproducer sources at the same time and enables the operator to monitor through a booth loudspeaker and at the same time feed other loudspeakers and lines or program busses. It can be adapted as an economical emergency standby system for larger program production systems as its over-all gain and output power are high enough to cover the entire range between input and output network levels.

### TECHNICAL DATA

**MAXIMUM GAIN:** Approximately 104 db.

**GAIN CONTROL:** 35 db continuously adjustable — separate control for each input.

**SOURCE IMPEDANCE:** 15 to 250 ohms.

**LOAD IMPEDANCE:** 1 to 1,200 ohms nominal impedance.

**OUTPUT POWER:** 12 watts (+41 dbm) with less than 2 per cent total harmonics as shipped, 20 watts (+43 dbm) with less than 5 per cent total harmonics available by a simple reconnections of taps for higher plate voltage and use of Western Electric tubes.

**OUTPUT NOISE:** -8 dbm unweighted, under maximum gain conditions. (Signal approximately 50 db above noise.)

**FREQUENCY RESPONSE:** Uniform within  $\pm 1$  db over the range 35 to 15,000 cycles.

**POWER SUPPLY:** 105-125 volts, 50-60 cycles ac, 1.25 amperes, 125 watts maximum.

**DIMENSIONS:** 19 5/32" wide, 7" deep and 7" high.

**WEIGHT:** Approximately 20 pounds.

**MOUNTING:** Standard 19" relay rack occupying 7" of panel space.

**FINISH:** Chassis — bright aluminum lacquer. Face mat — dark aluminum gray or black japan.

## 129A PRE-MIXING AMPLIFIER

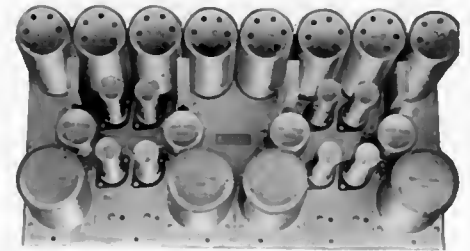

Composed of four identical two-stage amplifiers, with fixed gain, mounted on common chassis. Provides four electrically separate channels in which the inputs from four low level sources (microphones or reproducers) are simultaneously prepared for entry into a mixing network. Ideal for use in combination pre-mixing or booster circuit applications or can be adapted as a group of "no gain" bridging isolation amplifiers.

### ELECTRICAL CHARACTERISTICS OF EACH AMPLIFIER UNIT

**MAXIMUM GAIN:** 40 db.

**SOURCE IMPEDANCE:** 30, 250 or 600 ohms matching. (For bridging add proper pad)

**LOAD IMPEDANCE:** 600 ohms.

**OUTPUT POWER:** Single frequency output power for less than 1 per cent total harmonics: .038 watt (+16 dbm) at fundamental frequency of 400 cycles; .02 watt (+13 dbm) at fundamental frequency of 50 cycles.

**OUTPUT NOISE:** -82 dbm unweighted; -87 dbm weighted. (Normal ear sensitivity curve.) Signal-to-noise ratio for -20 vu program level output 62 db unweighted, 67 db weighted.

**FREQUENCY RESPONSE:** Flat within  $\pm 1$  db over the range 30 to 15,000 cycles.

**POWER SUPPLY (FOR COMPLETE AMPLIFIER):** Filament 6.3 volts 3.2 amperes. Plate 275 volts, 30 milliamperes, dc. (Pre-amplifiers A and B can be supplied from one source while C and D are supplied from another); 1.6 amperes filament and 15 milliamperes plate required for each half of amplifier. 20 Type Rectifier recommended for power supply.

### APPARATUS DESCRIPTION

**DIMENSIONS:** 17 7/8" wide, 10 5/16" deep and 6 3/4" high.

**WEIGHT:** 20 1/4 pounds.

**MOUNTING:** Designed for console mounting; also for rack mounting on 177 Type Mounting Plate (one per plate).

**FINISH:** Bright aluminum gray lacquer.

# AMPLIFIERS

## 130A MAIN AMPLIFIER

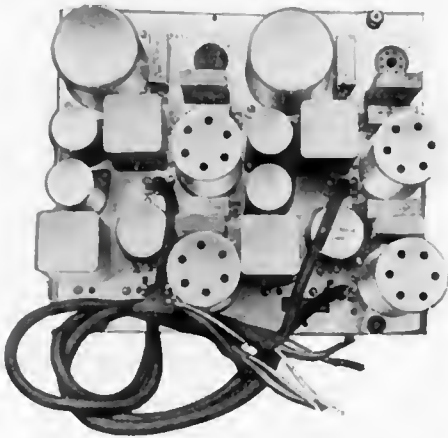

Has two identical, electrically separate, three-stage amplifiers mounted on a common chassis. Recommended for use in audio systems where it is desirable to feed two programs through a single program production unit simultaneously. May also be used to provide one regular and one emergency transmission channel. Each amplifier element is arranged for its own interstage gain control, which is intended as the master gain control for that channel.

In operation, cross talk between the two channels is held below audible levels through careful circuit design and expert selection of components. By the same means a high signal-to-noise ratio and low harmonic distortion characteristic, comparable to that featured in units of the single channel type, have been achieved in this equipment.

### ELECTRICAL CHARACTERISTICS OF EACH AMPLIFIER UNIT

**MAXIMUM GAIN:** 77 db.  
**GAIN CONTROL:** Requires two (one for each amplifier unit) 100,000 ohm potentiometers mounted externally within a maximum distance of 20 inches from the chassis. This is a high impedance interstage gain control requiring low capacity wiring of definite value for each amplifier.  
**SOURCE IMPEDANCE:** 30, 250 or 600 ohms matching (for bridging add proper pad).  
**LOAD IMPEDANCE:** Main output 600 ohms. Monitor output 40 ohms (approximately).  
**OUTPUT POWER:** Normal 0.25 watt (+24 dbm). Maximum 0.6 watt (+28 dbm) with less than 1 per cent harmonic distortion. Monitor output 20 db less than main output. (Isolation between main and monitor output is 20 db.)  
**OUTPUT NOISE:** Main output with maximum gain setting -37 dbm unweighted -47 dbm weighted (normal ear sensitivity curve). Signal to noise ratio with normal +24 dbm output 61 db unweighted 71 db weighted.  
**FREQUENCY RESPONSE:** Flat within  $\pm 1$  db over the range 30 to 15,000 cycles.  
**POWER SUPPLY FOR COMPLETE AMPLIFIER** (2 amplifier units): Filament 6.3 volts, 3.6 amperes (dc or ac). Plate 275 volts, 65 milliamperes, dc. (18 or 20 Type Rectifier recommended for power supply.)

### APPARATUS DESCRIPTION

**DIMENSIONS:** 12" wide, 10 5/16" deep and 6 13/16" high.  
**WEIGHT:** Approximately 17 1/4 pounds.  
**MOUNTING:** Designed for console mounting; also for rack mounting on a 177 Type Mounting Plate

(Capacity One 130A Amplifier).  
**FINISH:** Bright aluminum lacquer.

## 131A MONITOR AMPLIFIER

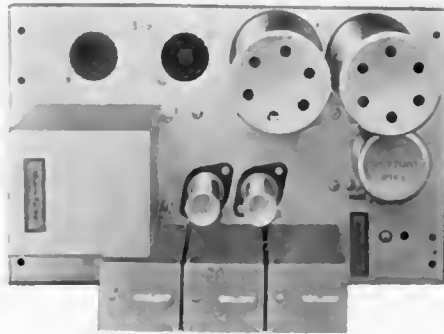

A single unit, two-stage, push-pull amplifier for booth and studio monitoring. One booth and two studio loudspeakers, plus line cue-feeding circuits, can be powered from its output network. Each of the three loudspeaker branch circuits is provided with a cut-off relay which may be connected to operate from microphone or talk-back keys. The 131A has sufficient gain to operate either from the output of a single pre-amplifier, or to be bridged across the output of a main amplifier.

### TECHNICAL DATA

**MAXIMUM GAIN:** 50 db.  
**SOURCE IMPEDANCE:** 600 ohms matching (for bridging add proper pad).  
**LOAD IMPEDANCE:** Tapped output transformer provides for operation into any impedance from 1 to 1,200 ohms.  
**OUTPUT POWER:** 5 watts (+37 dbm) with 5 per cent harmonic distortion; 3.2 watts (+35 dbm) with 1 per cent harmonic distortion.  
**OUTPUT NOISE:** -55 dbm unweighted, with maximum gain. Signal to noise ratio over 90 db under conditions of normal gain and output level.  
**FREQUENCY RESPONSE:** Flat within  $\pm 1$  db over the range 30 to 15,000 cycles.  
**POWER SUPPLY:** Filament 6.3 volts, 3 amperes ac or dc; plate 275 volts, 75 milliamperes, dc. (18 or 20 Type Rectifiers recommended for power supply.)  
**DIMENSIONS:** 10 5/16" wide, 6 3/8" deep and 6 3/4" high.  
**WEIGHT:** Approximately 7 3/4 pounds.  
**MOUNTING:** Designed for console mounting; also for rack mounting on 177 Type Mounting Plate (capacity one per plate).  
**FINISH:** Bright aluminum lacquer.

## 132A MAIN AMPLIFIER

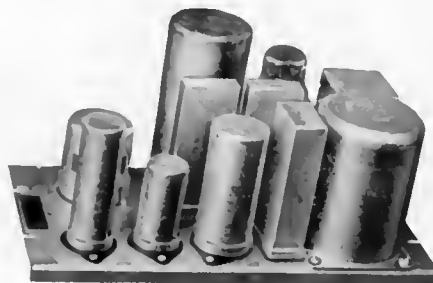

A two-stage amplifier with enough gain and output power to provide a suitable

margin above line level to allow for energy drains to coupling and equalizing devices. Will operate either from the output of a booster amplifier serving a large mixer circuit, or directly from mixer circuits, if the number of branches is limited.

### TECHNICAL DATA

**MAXIMUM GAIN:** 48 db.  
**SOURCE IMPEDANCE:** 30, 250 or 600 ohms matching (for bridging add proper pad).  
**LOAD IMPEDANCE:** 600 ohms.  
**OUTPUT POWER:** 0.6 watt (+28 dbm) with 1 per cent total harmonic distortion.  
**OUTPUT NOISE:** -65 dbm unweighted; -75 dbm weighted (normal ear sensitivity curve). Signal to noise ratio for +8 vu program level output 73 db unweighted, 83 db weighted.  
**FREQUENCY RESPONSE:** Flat within  $\pm 1$  db over the range 30 to 15,000 cycles.  
**POWER SUPPLY:** Filament 6.3 volts, 1.5 amperes; plate 275 volts, 31 milliamperes. (18 or 20 Type Rectifiers recommended for power supply.)  
**DIMENSIONS:** 10 1/2" wide, 5 1/4" deep and 7" high.  
**WEIGHT:** Approximately 6 1/2 pounds.  
**MOUNTING:** Designed for console mounting; also for rack mounting on a 177 Type Mounting Plate. (Capacity three 132A Amplifiers per plate.)  
**FINISH:** Bright aluminum lacquer.

## 133A LINE AMPLIFIER

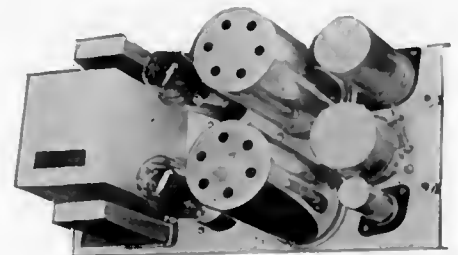

A three-purpose amplifier with greater output power than most line amplifiers and less harmonic distortion than many lower-powered units of this type. As a line amplifier, it contains apparatus to either match or bridge 600 ohm impedances. As an isolation amplifier it can be bridged on main circuits without noticeably affecting the main line transmission. For general monitoring, it has sufficient power for many studio applications.

### TECHNICAL DATA

**MAXIMUM GAIN:** 47 db with 600 ohm matching input; 21.5 db with bridging input.  
**SOURCE IMPEDANCE:** 600 ohms nominal matching or high impedance (20,000 ohms) bridging.  
**LOAD IMPEDANCE:** 1 to 1,200 ohms nominal.  
**OUTPUT POWER:** 8 watts (+39 dbm) with 2 per cent total harmonics; 4 watts (+36 dbm) with 1 per cent harmonics.  
**OUTPUT NOISE:** -65 dbm unweighted with maximum gain. -70 dbm unweighted with 5.2 db output pad connected.  
**FREQUENCY RESPONSE:** Flat within  $\pm 1$  db over the range 30 to 15,000 cycles.  
**POWER SUPPLY:** Filament 6.3 volts, 3 amperes; plate 275 volts, 66 milliamperes. (18 or 20 Type Rectifiers recommended for power supply.)  
**DIMENSIONS:** 10 1/4" wide, 5 1/4" deep and 7" high.  
**WEIGHT:** Approximately 6 1/2 pounds.  
**MOUNTING:** Designed for horizontal or vertical desk mounting or for rack mounting on a 177 Type Mounting Plate.  
**FINISH:** Bright aluminum lacquer.

# AMPLIFIERS

## 1126B PEAK LIMITING PROGRAM AMPLIFIER



Consists of 126B three-stage push-pull amplifier, 298A Control Panel and 20B Rectifier. Gain in amplifier is automatically reduced when input rises to a pre-determined level, is increased when input falls below that level. Compresses excessive peaks of modulation, protects against over-modulation and suppresses "monkey chatter." Has an extremely short attack time (approximately 1/10,000 second) and eliminates such results of overloading by peaks as (1) splash or short interval adjacent channel interference due to in-

stantaneous overmodulation of AM transmitter; (2) overswing in FM transmission which may cause the guard band to be overridden and also distortion to occur in the receiver; and (3) instantaneous overload and consequent distortion of other transmission systems. The self-contained, automatically regulated power supply operates instantaneously and stabilizes the operation of the amplifier for a wide range of power supply conditions.

### TECHNICAL DATA

**MAXIMUM GAIN:** 53.5 db maximum with all input and output fixed attenuators omitted (37 db as shipped with 10 db input and 6.5 db output attenuators connected) when working from 600 ohms and into 600 ohms, both adjustable attenuators at zero. **SOURCE IMPEDANCE:** 600 ohms (circuit not balanced to ground).

**LOAD IMPEDANCE:** 600 ohms (circuit not balanced to ground).

**OUTPUT POWER:** +17 dbm single frequency (as shipped and with adjustable output attenuator at zero) when gain reduction starts. (+23.5 db, maximum, with all output fixed attenuators omitted.)

**OUTPUT NOISE:** -45 dbm unweighted. 69 db below output level available when gain reduction starts.

**INPUT LEVEL RANGE:** -30 dbm to -20 dbm (single frequency tone).

**OUTPUT LEVEL RANGE:** -6 dbm to -17 dbm (single frequency tone).

**PROGRAM LEVEL RANGE:** Deduct 6 to 10 db from input and output level to allow for peak factor.

**OUTPUT DISTORTION:** For program - less than 1 per cent for all operating conditions up to 5 db compression. For single frequency tone - (a) below compression, less than 1 per cent; (b) for 5 db compression, less than 1 per cent for frequencies above

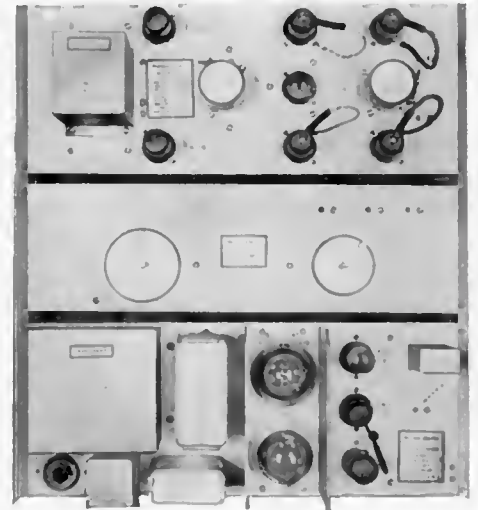

200 cycles and not more than 1.75 per cent for frequencies as low as 50 cycles.

**FREQUENCY RESPONSE:** Flat within  $\pm 1$  db over the range 30 to 15,000 cycles.

**COMPRESSION RATIO:** 10:1 (10 db input increase results in 1 db output increase above point at which gain reduction starts).

**RECOVERY TIME:** Variable in 5 steps of .2 second each from .2 second to 1 second. Optional adjustment permits variation from .1 second to .5 second.

**POWER SUPPLY:** 105 to 125 volts, 0.7 ampere, 50-60 cycles ac current.

**DIMENSIONS:** 19 1/4" wide, 19 1/4" high and 6 3/4" deep.

**WEIGHT:** 49 pounds.

**MOUNTING:** Recessed panel type for 19" relay rack. Occupies 19 1/4" of vertical rack space.

**FINISH:** Chassis - Bright aluminum lacquer; mat - black japan or dark aluminum gray.

# REPRODUCING GROUP

## 109 TYPE REPRODUCING GROUP

A professional combination of the versatile single element 9 Type Reproducer with its supporting arm and equalizer equipment. Used for most faithful reproduction of vertical cut and lateral cut disc

type recordings. When combined with a high-grade, constant speed turntable capable of playing records up to 16" in diameter and an amplifier and loudspeaker system of equally high quality the performance will be worthy of the best of modern electrical transcriptions.

The 109AA Reproducing Group con-

sists of: 9A Reproducer (favors transcription records), 5A Reproducer Arm, KS-13386 Equalizer and Cable Assembly, 171A Repeating Coil and 711A Bracket.

The 109B Reproducing Group includes the same equipment except that the 9B Reproducer (favoring phonograph records) replaces the 9A.



# REPRODUCING GROUP

## 9 TYPE REPRODUCER

A dynamic (moving coil) type reproducer with the generating assembly arranged to move vertically for reproducing from hill-and-dale records and transversely for reproducing from lateral cut records. This instrument is capable of discriminating between the two different types of groove modulation. The signal and noise always present in the bottom of lateral record grooves, as vertical modulation, is suppressed when the reproducer is switched for lateral reproduction. Correspondingly unwanted lateral modulation, inherent in the sides of vertical record grooves, is reduced to a minimum heretofore attainable only under scientific laboratory conditions when the reproducer is switched for vertical reproduction. The 9 Type Reproducer and associated 5A Arm have been designed so that their natural period lies below the audio frequencies usually reproduced in any system. This coupled with the low mechanical impedance of the 9 Type Reproducer minimizes vibratory pick-up. The practically permanent jewel stylus tip, together with the extremely light weight of the generating element (35 grams) assure long record life.

There are two codes of 9 Type Reproducer differing only in stylus tip material and radius.

The 9A Reproducer has a stylus tip of diamond with a nominal 2 mil tip radius. It gives superior performance and long life on transcription type records made of non-abrasive material and with narrow or medium groove cross section.

The 9B Reproducer has a stylus tip of sapphire with a nominal 2½ mil tip radius. It should be used for records containing abrasive in the record material (phonograph records) and having medium to wide groove cross section. With abrasive records the stylus should not be expected to give good performance for more than 1000 to 1500 playings without renewal.



## 5A REPRODUCER ARM

This arm has a four pin jack in its end into which the 9 Type Reproducer plugs. The arm supports and counterbalances the reproducer and provides leads for connection to the KS-13386 Equalizer and Cable Assembly. The arm is sturdily constructed, attractively finished in bright aluminum crackle to match the reproducer and has sufficient mass to offer the inertia essential to good low frequency reproduction. The arm bearings allow the desirable freedom of motion.

## 711A AND 712A SUPPORTING BRACKETS

The 711A Bracket is a simple T shaped arm rest supplied as part of the 109 Type Reproducing Group to support the reproducer end of the arm and reproducer when



it is not resting on the record.

By means of the 712A Bracket (not included in the code 109 type but available as an extra when ordered) the reproducer and arm can be adapted to cabinet types of transcription turntables which lack sufficient area on the table top to accommodate the base of the arm at the proper distance from the center of the turntable platter. This bracket has a guard which protects the rear or weighted end of the arm from accidental contact.

## REPEATING COIL AND EQUALIZER ASSEMBLY

The KS-13386 Equalizer and Cable Assembly and the 171A Repeating Coil form the equalizing, switching and impedance matching portion of the 109 Type Reproducing Groups.

The Equalizer Switch has seven reproducing positions, two for vertical and five for lateral. The seven reproducing characteristics are based on two fundamental frequency response characteristics which a recent survey of the field indicates are currently used for record production.

CURVE A is the conjugate of the frequency response curve in general use for vertical transcriptions.

CURVE B is the conjugate of the frequency response curve in general use for lateral transcriptions and phonograph records.

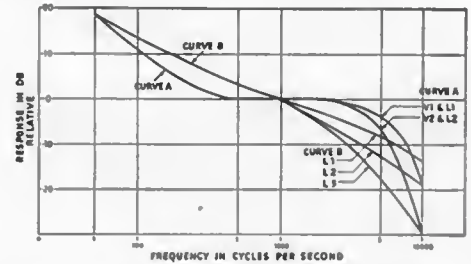

Curve	Position	Type	Over-all Response
A	V1	Vertical	Flat 50 to 10,000 cycles
A	V2	Vertical	Flat 50 to 2,500 with roll off to 15 db down at 10,000
A	L1	Lateral	Same as V1
A	L2	Lateral	Same as V2
B	L1	Lateral	Same as V1
B	L2	Lateral	Flat 50 to 1,000 with roll off to 5 db down at 10,000
B	L2	Lateral	Flat 50 to 1,000 with roll off to 17 db down at 10,000

The repeating coil provides taps for feeding pre-amplifier input impedances of 30, 250 or 500/600 ohms.

### ELECTRICAL CHARACTERISTICS

#### 109 Type Reproducing Group

OPERATES FROM: Vertical or Lateral cut disc records up to 16" diameter.

OPERATES INTO: 30, 250, or 500/600 ohm stabilized pre-amplifier input.

OUTPUT LEVEL: Representative program level — 62 vu (corresponds to output of high quality microphone).

OUTPUT NOISE: Representative signal to noise ratio at output for transcription 45 db, for phonograph records 20 db.

FREQUENCY RESPONSE: Representative transmission from input to recorder filter to output of reproducer group — for new transcriptions V1 or L1 positions — flat 50 to 10,000 cycles.

For old or worn transcriptions V2 or L2 positions — flat 50 to 1000 or 2500 and down 5 to 15 db at 10,000.

For phonograph records L2 or L3 positions — flat 50 to 1000 with roll off to 5 db to 17 db down at 10,000.

### APPARATUS DESCRIPTION

#### 9 Type Reproducer and 5A Arm

DIMENSIONS: Length 18½", width 7/8" to 2". Height — Adjustable ¾" to 2". Overall height 4". Base 3" in diameter.

WEIGHT: Reproducer ½ lb; Arm 3½ lbs; Total 4 lbs.

MOUNTING: Flat panel pivot center 13¾" from platter center.

FINISH: Bright aluminum crackle.

#### KS 13386 Equalizer

DIMENSIONS: Length — body 3¾", shaft 1¾" and cable 3 ft. Diameter — body 3", shaft ¼".

MOUNTING: Mount on back of panel with shaft and two mounting screws through panel.

FINISH: Bright aluminum. Black photo etched dial plate. Black knob.

#### 171A Repeating Coil

DIMENSIONS: Approximately 2 9/16" by 3¾" by 3¾".

MOUNTING: Base mounted on flat surface.

FINISH: Bright aluminum.

# LOUDSPEAKERS

In the selection of a "high fidelity" loudspeaker naturalness of reproduction should govern and the choice will depend on a number of factors including the service to which the speaker will be put, the character of the program material and the acoustics of the "listening space" or room in which it is to be located.

In normal radio station usage few studios, transcriptions or loudspeaker locations offer the perfect acoustic conditions necessary for true reproduction of sound or music above 10,000 cycles. It has therefore been found desirable to "roll off" the frequency spectrum above 10,000 cycles at a gradual rate resulting in about 6 db reduction at 15,000 cycles. By this compromise between "straight line" frequency response and imperfect acoustic conditions we offer to the ear the most "lifelike" reproduction of the original sound.

## 728B LOUDSPEAKER



For use in broadcast studios and sound and music distribution systems where the very highest quality reproduction is desired. Its special design gives a fidelity of tone unsurpassed by any other loudspeaker of the direct radiator type. Its life-like reproduction has an "emotional" characteristic which eliminates the consciousness that the program is coming through a loudspeaker.

### TECHNICAL DATA

FREQUENCY RANGE: 60 to 10,000 cycles.

IMPEDANCE: 4 ohms.

EFFICIENCY: At a distance of 100 feet on axis the 728B will produce a level of 81 db above 10<sup>-16</sup> watt per sq. cm. at 30 watts. This level is on a basis of a warble frequency covering a range from 500 to 2,500 cycles per second.

COVERAGE ANGLE: 50 per cent.

POWER CAPACITY: 30 watts continuous.

DIMENSIONS: Diameter 12 23/32"; depth 4".

WEIGHT: Approximately 16 pounds.

BAFFLE HOLE DIAMETER: 11 3/32".

MOUNTING: An enclosure with not less than 2½ cubic feet of space is required. Six mounting holes on 11.710" diameter circle spaced at 60 degrees.

## 753B AND 753C LOUDSPEAKERS

A two-band system with high and low frequency units, for high quality broadcast monitoring and sound system use. 753C consists of a KS-12004 Speaker (18" dynamic) for the lower frequencies, a 713A Receiver and 32A Horn for the higher frequencies, and a D-173048 Network, all mounted in a walnut finish cabinet of attractive design. The 753B has the same electrical and physical characteristics as the 753C except that it employs a 722A Receiver in place of the 713A Receiver and has less frequency range.

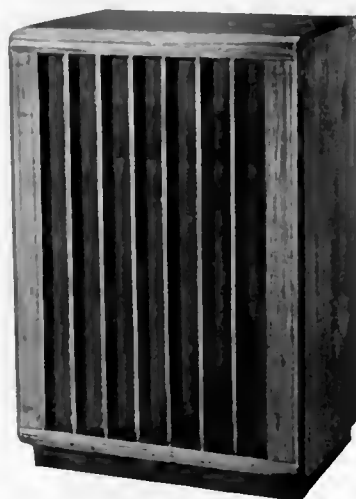

### TECHNICAL DATA

FREQUENCY RANGE: 753C — flat 60 to 10,000 cycles; 6 db down at 15,000 cycles. 753B — 60 to 6,500 cycles.

IMPEDANCE: 16 ohms.

EFFICIENCY: With full speech power of a 25 watt amplifier, the 753C will produce an intensity level of 74 db above 10<sup>-16</sup> watt per sq. cm. at a distance of 100 feet on the axis of the loudspeaker. Under the same conditions, the intensity level of the 753B is 73 db above 10<sup>-16</sup> watt per sq. cm.

COVERAGE ANGLE: Substantially uniform in frequency and intensity over an angle of 90° horizontally and 60° vertically.

POWER CAPACITY: Will handle speech or music with peak powers of 25 watts.

DIMENSIONS AND MOUNTING: Mounted in a walnut finished cabinet approximately 20" wide by 30" high by 13½" deep.

## 750A AND 751B LOUDSPEAKERS

Intended for use in public address and music reproduction systems, and for radio monitoring of speech or music over limited areas where high quality reproduction and low cost are essentials. The 750A is a per-

manent magnet, direct radiator type of speaker. The 751B consists of one 750A Speaker mounted in a specially constructed box. These speakers have a moderate power handling capacity and are capable of covering a frequency range that heretofore required a multiple device.

### ELECTRICAL CHARACTERISTICS

FREQUENCY RANGE: The 751B has a frequency range of 60 to 10,000 cycles.

IMPEDANCE: 8 ohms.

EFFICIENCY: With the full speech power of a 20 watt amplifier, it will produce an intensity level of 88 db above 10<sup>-16</sup> watt per sq. cm. at a distance of 10 feet on the axis.

COVERAGE ANGLE: 30° for highest quality. 45° for good quality.

POWER CAPACITY: The 751B will safely handle speech or music with a peak power of 20 watts.

### APPARATUS DESCRIPTION

#### 750A Loudspeaker

DIMENSIONS: 9½" diameter and 3¼" depth.

WEIGHT: Approximately 9 pounds.

MOUNTING: It should be mounted in a rigidly constructed box with an enclosed volume of 2½ to 3 cubic feet with a depth of at least 9" and not more than 24" for width or height. Inside surfaces should be lined with sound absorbing material 1" thick.



750A Loudspeaker

#### 751B Loudspeaker

DIMENSIONS: 24" high, 17" wide and 13½" deep.

WEIGHT: Approximately 42 pounds.

FINISH: The box has a plain gray lacquer finish which may be decorated to harmonize with its surroundings.

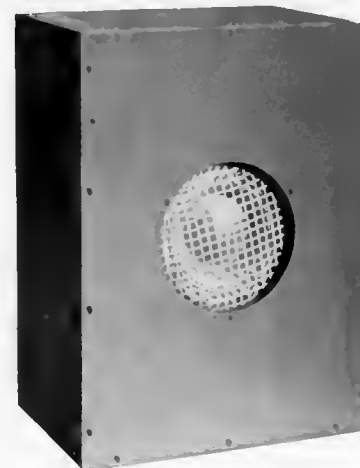

751B Loudspeaker

# MICROPHONES

## 639 TYPE MICROPHONE

A high quality microphone which features an adjustable sensitivity pattern secured by combining in one unit a dynamic moving coil pressure element and an improved ribbon type velocity element. This adjustable sensitivity enables the studio engineer to select a pick-up pattern to fit the requirements of studio or program. Difficult conditions, such as excessive echo or audience noise are discriminated against by the directional qualities of this versatile microphone.

The 639A Microphone offers patterns R, D and C (shown below) while the 639B offers these three plus patterns 1, 2 and 3. The C, or cardioid pattern, after which the microphone is named, presents a single null, or area in rear of the microphone in which pick-up is attenuated by as much as 20 db. Dual nulls of like degree are offered by patterns 1, 2 and 3.



### TECHNICAL DATA

**RESPONSE:** Essentially uniform throughout range of 40 to 12,000 cycles.

**DIRECTIVITY:** Six patterns R, D, C, 1, 2 and 3 selectable through six position screwdriver operated switch. At the angle of minimum response the average discrimination with respect to the 0° response is 20 db over the range from 40 to 10,000 cycles. In the range from 70 to 7,000 cycles the minimum discrimination at any frequency is 15 db.

**SENSITIVITY:** Open circuit terminal voltage 84 db below 1 volt/dyne/ sq. cm. which is equivalent to 64 db below 1 volt/10 dynes/ sq. cm. When terminated by a resistance of 35 ohms, the power output level is -76 vu (0 level calibration 1 milliwatt).

**IMPEDANCE:** The impedance varies somewhat throughout the frequency range, but has an average value of 35 ohms which will operate satisfactorily with equipment rated in impedance from 25 to 50 ohms.

**SIGNAL TO NOISE RATIO:** The signal for 1 dyne/sq. cm. sound pressure is 58 db above the thermal agitation noise generated within the microphone.

**DIMENSIONS:** Height 7½" including the plug terminal, length 4 7/16", width 3 7/16".

**WEIGHT:** 3¼ pounds.

**MOUNTING:** The 639 Type Microphone may be mounted on a floor or desk type stand or on a boom, with either a swivel or fixed mounting.

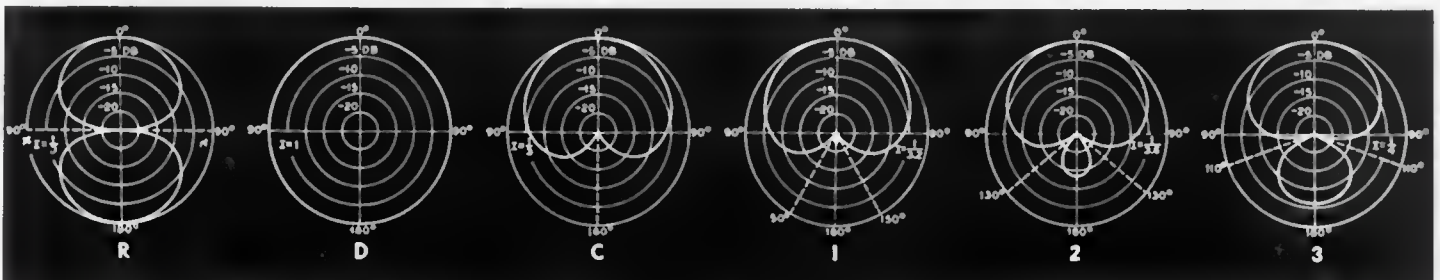

### ACCESSORIES FOR 639 TYPE MICROPHONE

A variety of mounting arrangements are available for the 639 Type Microphone. Either the attractive floor stand or desk stand may be used with a fixed or swivel mounting. For use with a microphone boom or other type of suspension mounting the swivel attachment (11A Transmitter Attachment) is recommended.

Photograph at top of page shows 639 Type Microphone on a 24A Transmitter Mounting.

In each arrangement a standard Cord Assembly is used. This consists of the 442A Jack, 712A Adapter and KS-7133 Cordage. In use the Jack and Adapter are usually hidden by the plug shell of the microphone.



639 Type Microphone (left) on 11A Transmitter Attachment and 24A Transmitter Mounting. At right suspended from 11A Transmitter Attachment. 442A Jack and 712A Adapter concealed by plug shell.



At upper left is 712A Adapter, used with 442A Jack (right) to give greater mounting security. 713A Adapter (center) permits cordage to run outside stand when microphone is mounted on 22A Floor Stand.



Floor Stand Weights (per ES-764305-2) may be used in base of 22A Floor Stand to give added stability.



22A Transmitter Mounting (floor stand) and close-up showing 442A Jack, 712A and 713A Adapters.

# MICROPHONES

## 640AA MICROPHONE



Developed as a laboratory instrument for testing sound pick-up and reproducing devices this tiny microphone is gaining wide use in broadcasting. With its associated RA-1095 Amplifier, it provides a means for ultra-faithful pick-up, especially in auditoriums or large studios where the remote single microphone pick-up technique can be used. It is particularly effective for pick-up of pipe organs, orchestras, choral groups and similar large program sources. Suspended by its cord at 8 to 12 ft. from the floor it serves admirably as a dialog mike—accommodating a group of ten or twelve persons without discrimination. The microphone-amplifier combination has an improved signal to noise ratio when used with standard studio equipment since normally a net gain of 45 to 50 db will raise its output to a line level of +8 dbm.

The small size of the microphone diaphragm is a decided advantage in that physically it approaches the ideal of a "point pick-up" device, eliminating possible phase distortion due to sound waves striking simultaneously against different portions of the diaphragm. Its small size minimizes the disturbances in the sound field caused by the presence of the pick-up element.

640AA Microphone and its associated RA-1095 Amplifier.



### TECHNICAL DATA

**OUTPUT IMPEDANCE:** Essentially that due to its capacitance, which is approximately 50 to 60 mmf.  
**OPERATES INTO:** Grid circuit of the RA-1095 Amplifier.  
**OUTPUT LEVEL:** Approximately 52 db below 1 volt (open circuit) per dyne per sq. cm. with 200 volts dc polarizing potential.  
**POLARIZING VOLTAGE:** 200 volts.  
**DIMENSIONS:** Cylindrical shape approximately 1" in diameter and 1" long.  
**WEIGHT:** Approximately 1½ ounces.  
**MOUNTING:** Screwed into associated RA-1095 Amplifier.

## RA-1095 AMPLIFIER

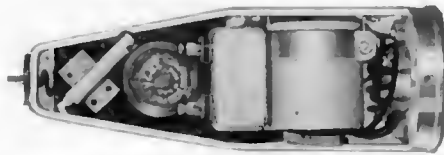

A small, single stage unit developed especially for use with the 640AA Microphone. The output level of the combination is about 26 db higher than that of a standard high quality studio microphone, hence a high initial signal to noise ratio is produced.

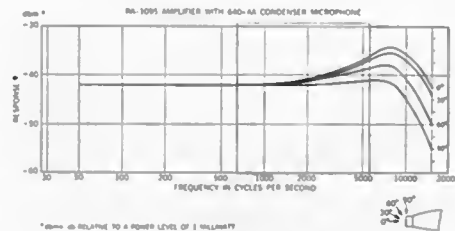

### TECHNICAL DATA

**OPERATES FROM:** 640AA Condenser Microphone.  
**OPERATES INTO:** 30-50 or 200-250 ohms.  
**OUTPUT LEVEL:** Approximately -42 dbm.  
**FREQUENCY RESPONSE:** See curve.  
**POWER SUPPLY:** Filament 6.3 volts, 150 ma, dc; plate 180 volts, 3 ma, dc.  
**DIMENSIONS:** 7¾" long, 2½" diameter.  
**WEIGHT:** Approximately 1¾ pounds.  
**MOUNTING:** Requires shock mounting hanger to fit microphone boom or other suspension mounting.

## 633A MICROPHONE

A rugged, dependable, high quality dynamic type microphone, well suited to radio broadcasting, announcing and sound distribution. The 633A "Salt Shaker" is intended for use with amplifiers nominally rated at 30 ohms input and because of this low impedance it may be used at considerable distances from associated amplifiers.

For sound arriving at an angle of 90° to the front of the microphone, the 633A performs the function of a non-directional instrument. For sound arriving at other angles the response varies until at 0° the high frequency response is a minimum. The "in-between" characteristics or directional effects may be utilized by tilting the microphone at the desired angle, using the



9A Swivel Joint. The use of the 8B Baffle, a 3¼" disc which fits snugly around the face of the microphone accentuates the directional effect.

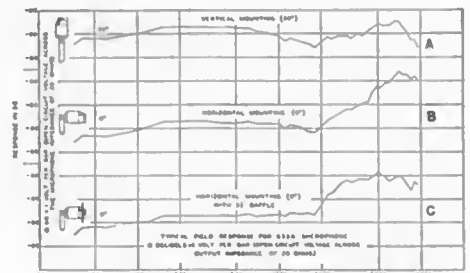

### TECHNICAL DATA

**OPERATES INTO:** 30 to 50 ohms.  
**OUTPUT LEVEL:** -60 vu for conversational level 3 ft. from mike.  
**FREQUENCY RESPONSE:** 40 to 15,000 cycles.  
**SENSITIVITY:** Open circuit terminal voltage 90 db below 1 volt per dyne per sq. cm. which is equivalent to 70 db below 1 volt per 10 dynes per sq. cm.  
**DIMENSIONS:** 2" in diameter and 3½" long.  
**WEIGHT:** 10 ounces.  
**MOUNTING:** Mounts on 23A Transmitter Mounting, either desk or floor stand type.

# VOLUME INDICATORS - RECTIFIERS

## 754A VOLUME INDICATOR



A volume level indicating device which is direct reading when bridged on a 600 ohm circuit. It includes a switch for adjusting sensitivity over a range from +4 to +26 vu at the 0 vu or 100 mark on the scale (about two-thirds full scale). Choice of meters for use with the 754A includes the KS-8218 Meter in which the 0 to 100 scale is emphasized and the vu scale subordinated, and the KS-8208 Meter in which the two scales are transposed.

### TECHNICAL DATA

**INPUT IMPEDANCE:** Approximately 7,500 ohms.  
**BRIDGING LOSS:** Approximately 0.3 db on circuits of 600 ohms. Substantially constant over the frequency range 35 to 10,000 cycles.  
**RANGE MEASUREMENT:** Volume levels from +4 vu to +26 vu in 600-ohm circuits may be measured. These values are for a deflection to the 0 vu or 100 mark on the meter. Using whole meter scale, these ranges are extended 20 vu lower and 3 vu higher.  
**FREQUENCY RESPONSE:** Uniform to within 0.2 db for all frequencies between 35 and 10,000 cycles.  
**DIMENSIONS AND MOUNTING:** Assembled on 5 1/4" x 19" panel for relay or cabinet mounting.  
**FINISH:** Aluminum gray on the front, a bright aluminum on the rear.

## 754B VOLUME INDICATOR

The same circuit and utility as the 754A but in addition, it has a key by means of which the volume indicator circuit is changed to terminate a circuit in 600 ohms and give an increased sensitivity of 10 db. With this key operated to give increased sensitivity, the volume indicator should not be bridged across a line but will terminate it. The mechanical design and finish of the 754B are the same as that of the 754A. Other than sensitivity, the electrical characteristics are also the same.

## KS-8218 METER

A volume level indicator designed to the specifications agreed upon by Bell Telephone Laboratories and the major broadcasting networks and incorporating the standard "vu" reference level. It employs a full wave, copper oxide rectifier contained within the meter case. Its response is uniform to within 0.2 db for all frequencies between 35 and 15,000 cycles. Among its features are remarkable accuracy, temperature stability, and easy readability.

The KS-8218 is provided with the type B scale in which the 0 to 100 scale is emphasized and the vu scale subordinated. It is 4 1/4" wide, 3 15/16" high and 2 1/2" deep.

## 18A AND 18B RECTIFIERS

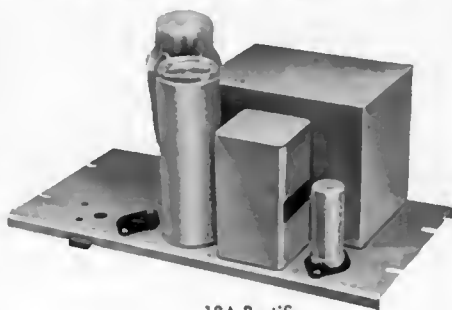

18A Rectifier



18B Rectifier

Rectifier type power units for supplying plate and filament power to speech input and sound system amplifiers. Incorporate a full wave vacuum tube rectifier for plate supply and a transformer winding to supply filament power. Normally used to supply power for Western Electric Types 120, 121, 129, 130, 131, 132, 133 and similar amplifiers. The 18A is designed for mounting on a 177 Type Mounting Plate with additional rectifiers or other plate mounted units. The 18B is designed for direct mounting on a relay rack or equipment cabinet.

### TECHNICAL DATA

**INPUT:** 105-125 volts, 50 or 60 cycles ac. Approximately 100 watts for full load.

**OUTPUT:** Plate supply maximum .075 amperes at approximately 250 volts dc. Taps on high voltage winding or transformer to maintain voltage between 320 and 250 volts dc for loads between .007 amperes and .075 amperes. Filament supply maximum 8 amperes at approximately 6.3 volts ac.

**DIMENSIONS:** (18A) 10 3/16" wide, 5 7/32" deep and 6 11/16" high. (18B) 19 5/32" wide x 3 15/32" high x 6 27/32" deep.

**WEIGHT:** (18A) 9 pounds. (18B) 12 pounds.

**MOUNTING:** (18A) Designed for mounting on 177 Type Mounting Plate (Capacity 3 rectifiers per plate). (18B) Designed for mounting on standard 19" relay rack or equipment cabinet. Occupies 3 1/2" of rack space.

**FINISH:** (18A) Bright aluminum gray lacquer on zinc plated steel. (18B) Bright aluminum gray lacquer chassis. Face mat finished in choice of dark aluminum gray or black japan.

## 20B RECTIFIER

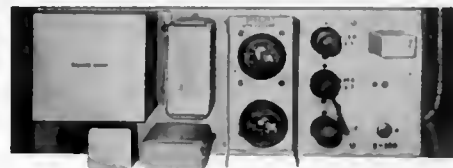
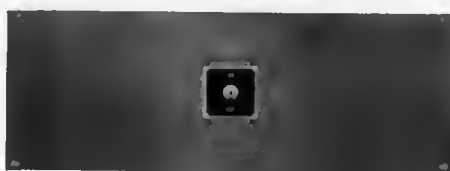

A full-wave vacuum-tube rectifier incorporating a vacuum tube voltage-regulating circuit which is ultra rapid in operation and which is designed to prevent the plate voltage supply from rising above its final value during the warm-up period of the voltage-regulator tube. Due to its ultra rapid feature it has negligible internal impedance and therefore, practically eliminates coupling between amplifiers which might otherwise be caused by the use of a common plate supply source.

### TECHNICAL DATA

**INPUT:** 100-130 volts, 50 to 60 cycles. Power consumption approximately 55 watts, 0.7 amperes at 115 volts for no load and 196 watts, 1.7 amperes for rated load.

**OUTPUT:** Rated load — plate supply 110 milliamperes at 275 volts dc and filament supply 10 amperes at 6.3 volts ac.

**PLATE SUPPLY REGULATION:** 3 volts maximum voltage change from no load and +10 per cent line voltage to rated load and -10 per cent line voltage.

**PLATE SUPPLY RIPPLE:** Approximately 5 millivolts rms at rated load.

**DIMENSIONS:** Mat — 19 5/32" x 6 31/32". Chassis—overall including mounting flanges, 18 15/16" wide, 6 11/16" high and 2" deep.

**WEIGHT:** 26 pounds.

**MOUNTING:** Designed to mount on standard 19" relay rack or cabinet, where it occupies 7" of panel space.

**FINISH:** Chassis bright aluminum lacquer. Mat — choice of dark aluminum gray or black japan.

## KS-7593 RECTIFIER

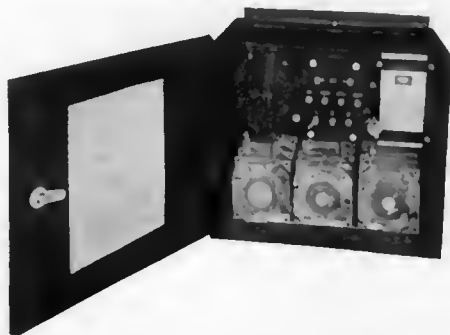

A copper-oxide rectifier used as a 12-volt dc power source for operating relays and signal lamps in speech input equipment.

### TECHNICAL DATA

**INPUT:** 105 to 125 volts, 60 cycle ac.

**OUTPUT:** 1.2 ampere dc full load. No load voltage 14 volts. Full load voltage 10 volts.

**DIMENSIONS:** 14" wide, 13 3/4" high and 9 1/2" deep.

**WEIGHT:** 40 pounds.

**MOUNTING:** Assembled in a steel cabinet with hinged front cover, arranged for wall mounting.

**FINISH:** Black crinkle lacquer.



# COMPONENTS

## 271A OUTPUT SWITCHING PANEL

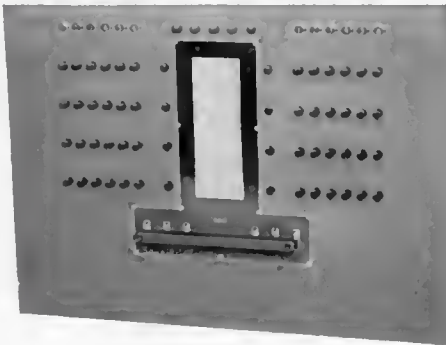

A selective master control switching or program dispatching unit in which any four of six studios or amplifier channel outputs may be connected to four outgoing line circuits. Duplicate banks of selector keys allow presetting of studio amplifier channels for the next scheduled program. A master key switches between the banks of selector keys and a monitor switch transfers a monitoring amplifier or a volume indicator to any one of the outgoing circuits.

The 271A is designed to operate from input circuits of 30 ohms impedance and requires step down repeating coils (119B or equivalent) between 500 ohm amplifier channels and the input circuits to this panel.

### TECHNICAL DATA

**INPUT IMPEDANCE:** 30 ohms.  
**OUTPUT IMPEDANCE:** Each of the four output circuits is 330 ohms. Output circuits contain balanced networks of 32 db attenuation with straps which may be changed and the attenuation increased to 42 db each for use with incoming amplifier channels of 0 db or +10 db power level, respectively.  
**POWER SUPPLY:** 12 volts dc required for the amplifier channel designation lamps.  
**DIMENSIONS:** 14" high, 19" wide and 3 3/8" deep.  
**WEIGHT:** Approximately 18 pounds.  
**MOUNTING:** Designed to mount in a standard relay rack or equipment cabinet.  
**FINISH:** Dark gray or black mat.

## 12A POWER UNIT

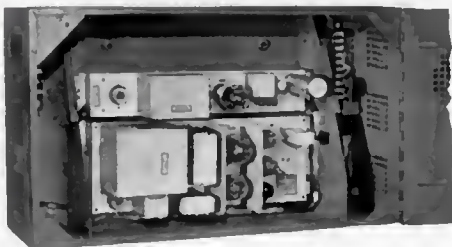

A complete, compact power supply unit consisting essentially of an 18B Rectifier and a 20B Rectifier mounted in a 21A Cabinet. Developed as the power supply for the 25B Speech Input Equipment but useful for other like applications, the 12A contains power supply units for plate and filament power to vacuum tubes.

The 21A Cabinet, which can be ordered separately, provides 14" of rack space for the mounting of equipment normally mounted on standard 19" racks.

### TECHNICAL DATA

**INPUT:** 110 to 120 volt, 50 to 60 cycle ac.  
**OUTPUT:** See data on the 18B Rectifier and the 20B Rectifier on page 38.  
**DIMENSIONS:** (21A Cabinet) approximately 28" wide, 16 1/2" high and 9 1/2" deep.  
**WEIGHT:** Approximately 60 pounds.  
**MOUNTING:** Designed for wall mounting near the main unit but separate from it.  
**FINISH:** The 21A Cabinet is aluminum gray finished metal.

## REPEATING COILS

### 111C AND 119C REPEATING COILS

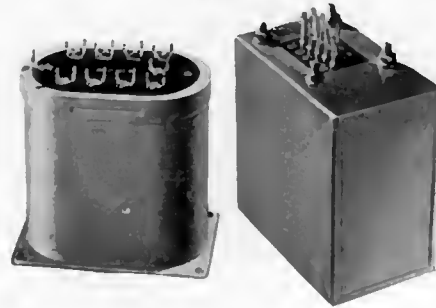

111C

119C

111C AND 119C REPEATING COILS

IMPEDANCE RATIO  
 111C 800<sup>Ω</sup> 800<sup>Ω</sup>  
 119C 520<sup>Ω</sup> 800<sup>Ω</sup>

IMPEDANCE RATIO  
 111C 150<sup>Ω</sup> 800<sup>Ω</sup>  
 119C 130<sup>Ω</sup> 800<sup>Ω</sup>

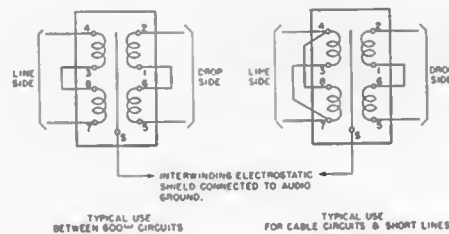

## 153A REPEATING COIL

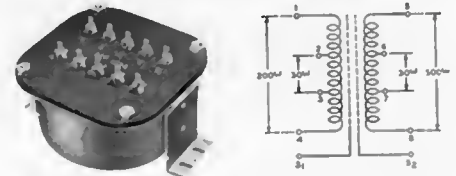

A flat type toroidal coil with permalloy core, potted in a heavy iron case. Designed for general use in microphone or line level circuits to match impedances. Shielding is provided by two electrostatic shields between windings—used separately to segregate grounds or strapped to form a single shield. Transmission loss less than 1/2 db.

### APPARATUS DESCRIPTION

**DIMENSIONS:** 4 7/8" x 3 15/16" x 2 5/16".  
**WEIGHT:** 2 pounds, 10 ounces.  
**MOUNTING:** Flat base for board or panel.  
**FINISH:** Bright aluminum lacquer.

## 154C REPEATING COIL

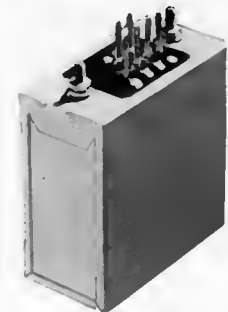

IMPEDANCE RATIO  
 55400 500  
 LOSS THROUGH COIL, 24 db

IMPEDANCE RATIO  
 30400 500  
 LOSS THROUGH COIL, 18 db

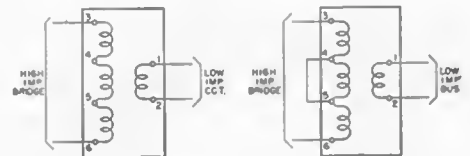

LOSS IN CIRCUIT BRIDGED NEGLIGIBLE IF COIL IMPEDANCE IS AT LEAST 5 TIMES THAT OF CIRCUIT BRIDGED

Toroidal type line repeating coils designed to provide dependable impedance matching and line isolation at line circuit transfer points. They are intended for use with repeater amplifiers for program transmission over long or short cable or open wire circuits equipped with proper loading. Transmission loss less than 1/2 db.

### APPARATUS DESCRIPTION

#### 111C Repeating Coil

**DIMENSIONS:** 2 9/16" x 4 3/16" x 4 17/32".  
**WEIGHT:** 4 1/2 pounds.  
**MOUNTING:** Flat base for board or panel mounting. Mounting holes tapped for 8-32 screws.  
**FINISH:** Bright aluminum gray lacquer.

#### 119C Repeating Coil

**DIMENSIONS:** 2 9/16" x 4 9/32" x 5 1/8".  
**WEIGHT:** 4 pounds.  
**MOUNTING:** Single side stud mounting using 993A or 993C Mounting plate.  
**FINISH:** Bright aluminum lacquer.

A high quality repeating coil for bridging service. It has a shell type chrome permalloy core and is potted in a rectangular metal case arranged for single side stud mounting. Has an impedance ratio of 55,400 to 500 ohms between windings (3-4) (5-6) and (1-2). When bridged on a 600 ohm circuit it has no effect on the circuit bridged. Transmission loss through the coil under this condition is 24 db with terminals 4 and 5 unstrapped or 18 db with terminal 4 connected to terminal 5.

### APPARATUS DESCRIPTION

**DIMENSIONS:** 3 9/32" x 1 11/16" x 3 7/16" (4 3/16" overall).  
**WEIGHT:** 2 1/4 lbs.  
**MOUNTING:** Single side stud mounting using 993B or 993C Mounting Plate.  
**FINISH:** Bright aluminum lacquer.

# COMPONENTS

## 170B REPEATING COIL

A shell type line repeating coil with a permalloy core enclosed in a metal case of unusually small size. Designed to provide dependable impedance matching and line isolation at line circuit transfer points with complete assurance that the highest program quality is being maintained. It has an impedance ratio of 600:600 ohms. Transmission loss less than 1/2 db.

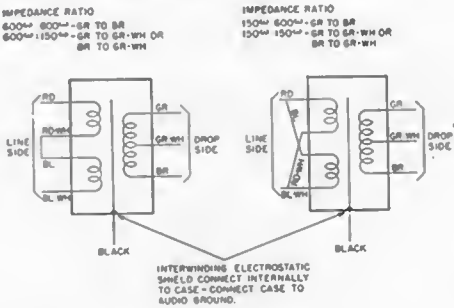
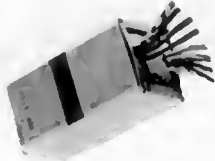

### APPARATUS DESCRIPTION

**DIMENSIONS:** 1 3/4" x 1 3/4" x 3 1/2".  
**WEIGHT:** 1 1/4 pound.  
**MOUNTING:** Flat base for chassis mounting. Two threaded mounting holes take screws 1/2" x 8-32.  
**FINISH:** Bright aluminum lacquer.

## 172A REPEATING COIL

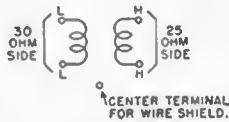

An exceptionally high quality impedance matching device for use in low level circuits particularly between a microphone and amplifier. It is adaptable for connection in the microphone cordage or it may be mounted on the associated amplifier. A cover, illustrated above, protects and relieves the strain on the terminals and terminal plate. The 172A has an impedance ratio of 30:250 ohms and will transmit equally well in either direction. Transmission loss less than 1/2 db.

### APPARATUS DESCRIPTION

**DIMENSIONS:** 1 3/4" diameter x 2 25/32" long.  
**WEIGHT:** 12 ounces.  
**MOUNTING:** Use connected in microphone cord or mount on flat surface by means of loop bracket.  
**FINISH:** Black plastic case.

## EQUALIZERS

### 23A EQUALIZER

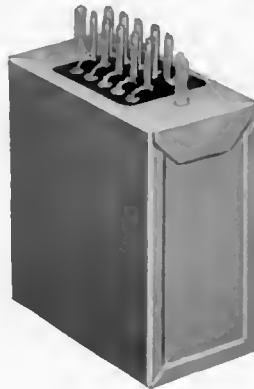

Used to correct the non-uniformity of transmission in the range from 25 to 8,000 cycles of non-loaded telephone cable employed for the transmission of program material. It is intended for use on program lines which are employed frequently enough to justify the permanent association of an equalizer. The 23A is of the shunt type consisting of an inductance and a capacity in parallel and a tapped series resistance the value of which is determined at the time of installation from the transmission characteristic of the circuit. Seven resistance units provide a total of 322.5 ohms, sufficient to meet practically all line conditions.

By use of the 23A Equalizer, non-loaded cable circuits consisting entirely of one gauge can be equalized up to the following approximate lengths with a maximum deviation of 1 db: 16 gauge—21.5 miles; 19 gauge—10 miles; 22 gauge—6.5 miles. The following lengths can be equalized with a maximum deviation of 2 db: 16 gauge—25 miles; 19 gauge—11.5 miles; 22 gauge—7 miles.

### APPARATUS DESCRIPTION

**DIMENSIONS:** 11 1/16" wide, 3 9/32" high and 4 3/16" deep.  
**WEIGHT:** Approximately 3 pounds.  
**MOUNTING:** Mounts on equipment panel such as Western Electric 993B Mounting Plate  
**FINISH:** Aluminum gray.

### 279A EQUALIZER PANEL



Covers the same equalization range as the 23A Equalizer and is designed for use on lines which do not warrant the permanent association of a fixed equalizer. This adjustable equalizer may be patched to any program line and the equalization and pro-

gram level quickly adjusted to meet the characteristics of the line.

It employs three adjustable series resistances, connected in place of the resistance elements of the 23A, to facilitate rapid equalization of the line. It also incorporates a separate 600:600 ohm dial type attenuator having maximum attenuation of 50 db adjustable in 5 db steps, useful in controlling line levels.

### APPARATUS DESCRIPTION

**DIMENSIONS:** 3 1/2" high and 19" wide.  
**WEIGHT:** 8 1/2 pounds.  
**FINISH:** Aluminum panel with dark gray mat or with black mat.  
**MOUNTING:** Standard 19" relay rack or equipment panel.

## AUTO TRANSFORMERS

### 18A AND 19A AUTO TRANSFORMERS

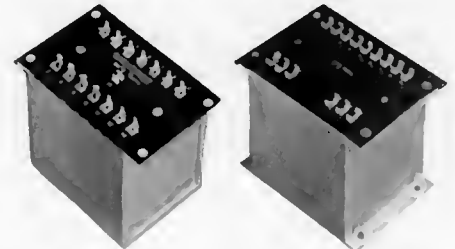

Designed to provide impedance matching between amplifiers and loud speakers over a wide range of applications. These two transformers have the same impedance ratios and cover the same frequency range, but differ in size and power handling capacity.

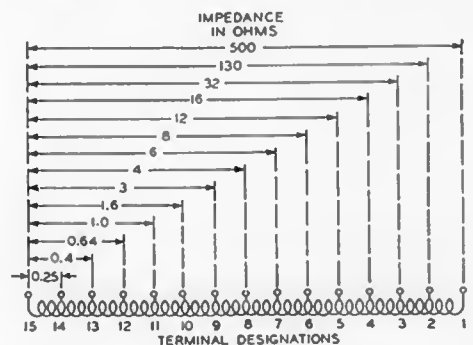

### TECHNICAL DATA

**FREQUENCY RANGE:** 15 to 15,000 cycles.  
**AVERAGE LOSS:** 0.35 db for the 18A; 0.1 db for the 19A.  
**POWER CAPACITY:** 18A is 50 watts continuous; 19A is 200 watts continuous, 500 watts on speech or music from 100 to 15,000 cycles. (These power ratings hold only to tap 10. For lower taps reduce ratings 2 db or 0.631 per cent per tap.)  
**INSULATION:** 18A — 2,000 volts ac; 19A — 3,000 volts ac.  
**IMPEDANCE RATIO:** See Diagram.  
**DIMENSIONS:** 18A — 5 1/2" long, 3 1/2" deep and 4 3/8" high; 19A — 7 7/8" long, 5 3/8" deep and 6 3/4" high.  
**WEIGHT:** 18A — 9 pounds 3 ounces; 19A — 27 pounds.

# COMPONENTS

## PANELS-MOUNTING PLATES

### 288A TERMINAL PANEL



Consists of a mounting plate equipped with 16 P-250833 Terminal Units, of 10 terminals each, a total of 160 terminals. Approximate overall dimensions are 19" long, 1 3/4" high and 4 1/8" deep. The terminal panel, however, will require 5 1/2" instead of 1 3/4" of mounting space in standard rack or cabinet in order to provide space for making connections to the terminal unit. A blank panel must be ordered separately for use as a face mat.

### 221A AND 222A JACK MOUNTING



Consist of one or two jack mounting strips and a metal face mat equipped with a designation strip. The mounting strips are made of hard rubber reinforced with metal strips on top and bottom. The 221A uses one mounting strip with a capacity of 48 jacks (218 or similar type) and occupies 3 1/2" of mounting space on a standard 19" rack or cabinet. The 222A employs two mounting strips with a capacity of 96 jacks and occupies 5 1/4" of 19" rack mounting space.

### 177A AND 177B MOUNTING PLATES



Chassis for supporting plate-mounted amplifiers and similar apparatus. Designed primarily for mounting 120 and 121 Type and like amplifiers and 18A Rectifiers. It is made of 1/16" furniture steel with knockouts provided for all necessary acces-

sory leads. The 177A Mounting Plate uses the 296A Panel as a mat and is fastened to the panel from the rear, eliminating screw holes in the panel. The 177B Mounting Plate, using the 296B panel as a mat, is first secured to the rack or cabinet and the panel is fastened over it from the front with four flush-head screws.

#### APPARATUS DESCRIPTION

WIDTH: 18 15/16".  
HEIGHT: 10 1/4" (occupies 10 1/2" of mounting space).  
WEIGHT: 4 pounds.  
FINISH: Mat (296 Type Panel) finished in black japan or aluminum gray.

### 993A, 993B and 993C MOUNTING PLATES

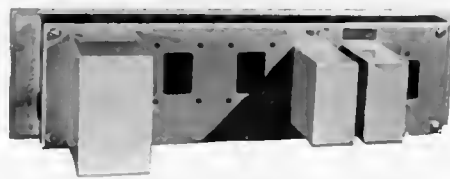

993C Mounting Plate with 23A Equalizer, 154C and 119C Repeating Coils.

Depressed relay rack type mounting plates equipped with face mats. The 993A has a mounting capacity of six 119 Type Repeating Coils. The 993B has a mounting capacity of eight 23A Equalizers or 154C Repeating Coils. The 993C has a mounting capacity of three 119 Type Repeating Coils and either three 23A Equalizers or three 154 Type Repeating Coils.

#### APPARATUS DESCRIPTION

DIMENSIONS: Occupies 5 1/4" of mounting space on standard 19" rack or cabinet.  
FINISH: (Mat) dark aluminum gray or black japan.

### 296A AND 296B PANELS

Blank mats for chassis type apparatus having bent up flanges. Designed primarily for use with 177 Type Mounting Plate. Made of finished furniture steel, they may be drilled or punched for any desired arrangement of controls, meters, etc.

#### APPARATUS DESCRIPTION

DIMENSIONS: 19 5/32" wide, 3/32" thick and 10 15/32" high.  
(Occupies 10 1/2" of vertical space in standard rack or cabinet.)  
WEIGHT: 5 1/2" pounds.  
FINISH: Dark aluminum gray or black japan.

### BLANK PANELS



Detail of Bracket

For use on standard 19" equipment racks or bay cabinets. Panels are finished furniture steel 3/32" thick with a matte finish in either dark aluminum gray or black japan, and fasten to rack or cabinet with screw-held clips on the rear surface. Length is the standard 19 3/16", and widths are standard multiples of 1 3/4". The following widths are available: 3 1/2", 5 1/4", 7", 8 3/4", 10 1/2", 12 1/4", 14", 15 3/4", 17 1/2".

## HEADSETS

### 1002F and 1002H HEADSETS

Useful and durable monitoring headsets familiar to most broadcast operators. They are recommended for use with the 22D Portable Speech Input Equipment and in control room monitoring. Consist of a cloth-covered wire headband carrying two non-adjustable receivers (509W) connected in series by means of a Y cord (768). The 1002F (illustrated on page 29) has a two-conductor (47B) plug at the opposite end while the 1002H terminates in pin tips.

When it is desirable to use either of these headsets with the 241 Type Plug, the R2ET Cord and the proper plug should be ordered and the corresponding items replaced.

## JACKS

### 218A AND 218J JACKS

Singly mounted, electrically welded frame type jacks with contacts of rare metal alloy. Terminals are arranged to accommodate two No. 19 or smaller B & S gauge wires. The 218J has a nickel finished sleeve while the 218A has a plain brass sleeve. They are used with 47, 165 and 241 Type Plugs, and mount in 221 and 222 Type Jack Mountings.



### 225CE JACK

A singly mounted, electrically welded frame type jack equipped with platinum contacts and a nickel silver sleeve. Terminals of all springs are arranged to accommodate two No. 16 or smaller B & S gauge wires. It is used with 47, 165 and 241 Type Plugs and mounts in the 221 and 222 Type Jack Mountings.



# COMPONENTS

## 410D JACK

A twin jack consisting of a single frame equipped with two sleeves. The tip strings are gold plated at the lip end. The 410D is used with the 241 Type Plug and mounts in 221 and 222 Type Jack Mountings.

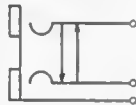

## PLUGS

### 47A AND 47B PLUGS

For use with a two-conductor cord (P2A) and 218 and 225 Type Jacks. The 47A has a red shell and the 47B has a black shell.

### 241A AND 241B PLUGS

Twin type plugs with the brass frames of the two plugs electrically connected to the two plug sleeves. Used with the P2AA and P3J cords and 410 Type Jack. The 241A has a black shell and the 241B has a red shell.

## CORDS

### P2A AND P2AA CORDS

Moisture proof, long life, two-conductor patching cords, with rubber insulated tinsel conductors. Available in 1, 2, 3, 4 or 6 foot lengths. The P2A is equipped with cord tips for 47 Type Plugs and the P2AA for 241 Type Plugs.

### P3J CORD

A three-conductor moisture proof patching cord with rubber insulated tinsel conductors. Available in 1, 2, 3, 4 or 6 foot lengths. Arranged for 241 Type Plugs.

## KEYS

### 92 TYPE KEY

A singly mounted, mechanically locking type key equipped with a variety of "make" and "break" contacts, up to a capacity of four transfers (twelve springs).

### 498A KEY

A singly mounted, rotating button type key intended for switching. Arranged to rotate 90 degrees clockwise and 90 degrees counter-clockwise from normal. Closes a "make" contact in each position, except normal. Other 498 Type

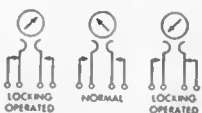

Keys have a single 90 degree rotation and have various contact arrangements up to six springs.

### 547A AND 547B KEYS

Non-locking push button type keys interchangeable with and mounting like the 218 Type Jack. The 547A closes one "make" contact while the button is pressed and 547B operates two sets of "break before make" contacts when the button is pressed.

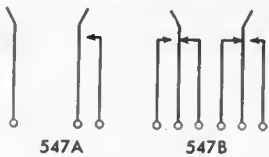

### 552A KEY

A turn button locking type key arranged to rotate 90 degrees clockwise from normal. The 552A closes two "break before make" contacts upon rotation of the button. It is interchangeable with and mounts like the 218 Type Jack.

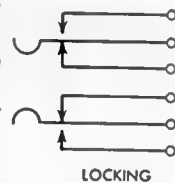

### 553A KEY

A reliable five button, mechanically interlocking key used for program switching. All plungers lock in the operated position, but operation of any one plunger releases any other operated plunger. This key is used in the 271 Type Output Switching Panel.

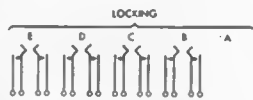

### 554A KEY

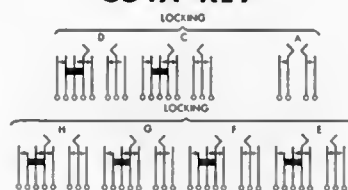

A reliable seven button, mechanically interlocking key used for program switching. All plungers lock in the operated position, but operation of any one plunger releases any other operated plunger. This key is used in the 271 Type Output Switching Panel.

## LAMPS-SOCKETS-CAPS

### 47B AND 49B LAMP SOCKETS

Singly mounted sockets arranged to take the 2 Type Lamp and the 2 or 72 Type Lamp Cap. The 47B mounts interchangeably with the 218 Type Jack. The 49B mounts on a key shelf or panel 7/8" thick.

### 2 TYPE LAMP

A high quality carbon filament switchboard lamp with long life and high illuminating power. It is a tipless, clear glass bulb 1 3/4" in length and approximately 5/16" in diameter, and mounts in 47 and 49 Type Lamp Sockets. The approximate current consumption of the lamps normally used in broadcasting equipment is as follows: 2F— .12 amperes at 12 volts; 2G— .11 amperes at 24 volts; 2J— .03 amperes at 24 volts; 2U— .04 amperes at 24 volts; 2Y— .03 amperes at 48 volts.

### 2 TYPE LAMP CAP

Made from specially selected and treated glass, the lens of this cap is thick and substantial. The cap case is slotted to give a spring fit in the socket. It is available in a variety of surface treatments and colors including red, white, blue, green and amber opalescent, jeweled red, blue and green, and clear amber. The 2 Type Lamp Cap mounts in the 47 and 49 Type Lamp Sockets.

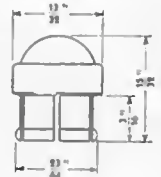

### 72 TYPE LAMP CAP

Similar to the 2 Type Lamp Cap except that the lens has a flat top with translucent numbers engraved on a black background (single characters) or black characters on white, red or green backgrounds (up to four characters). Mounts in the 47 and 49 Type Lamp Sockets.



## KNOB-KEY HANDLE

### KS-10088 KNOB

A black phenol plastic mushroom type knob with skirts and raised pointers to facilitate fingertip control and eliminate cramped hands. It has a chromium bar on the pointer and a chromium indicator line inset in the top of the knob to show at a glance the knob setting. Used on 25, 23 and 22 Type Speech Input Equipments. The depth of the knob is 1 5/16" and the skirt diameter for List 1 is 1 5/8" and for List 2 is 1 3/8".

### KS-10011 KEY HANDLE

A decorative and functional flat type key handle with convex finger surfaces for fingertip control of lever type keys. Available in black, red, white, blue or green.

