

the  
**CORNELL-DUBILIER**  
**Capacitor**



The Radiart Corp.  
 Cleveland, Ohio  
 4 Plants



C-D Sanford  
 North Carolina

C-D

Hope Valley, R.I.

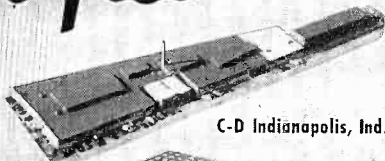

C-D Indianapolis, Ind.



C-D

Providence, R.I.



C-D Fuquay Springs, N.C.

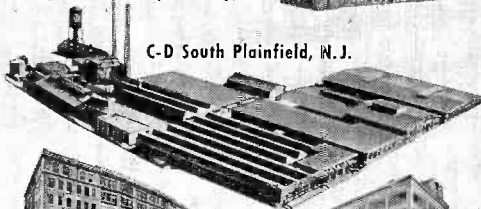

C-D South Plainfield, N.J.

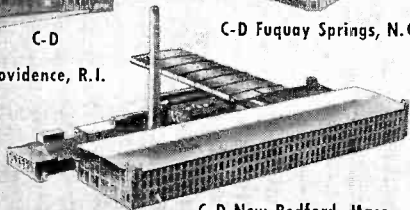

C-D New Bedford, Mass.



C-D Worcester, Mass.



C-D Cambridge, Mass.

Vol. 20

JUNE, 1955

No. 6

CORNELL-DUBILIER ELECTRIC CORP.  
 Hamilton Boulevard, South Plainfield, N. J.

POSTMASTER: If undeliverable for any reason,  
 notify stating reason, on Form 3547 postage for  
 which is guaranteed.

Sec. 34.66 P.L.&R.  
 U. S. POSTAGE  
**PAID**  
 So. Plainfield, N. J.  
 Permit No. 1

MR. MARSHALL W. COLE  
 R. R. 1, BOX 257  
 FORTVILLE, IND.

# C-D's CUB

## BEST-BAR NONE

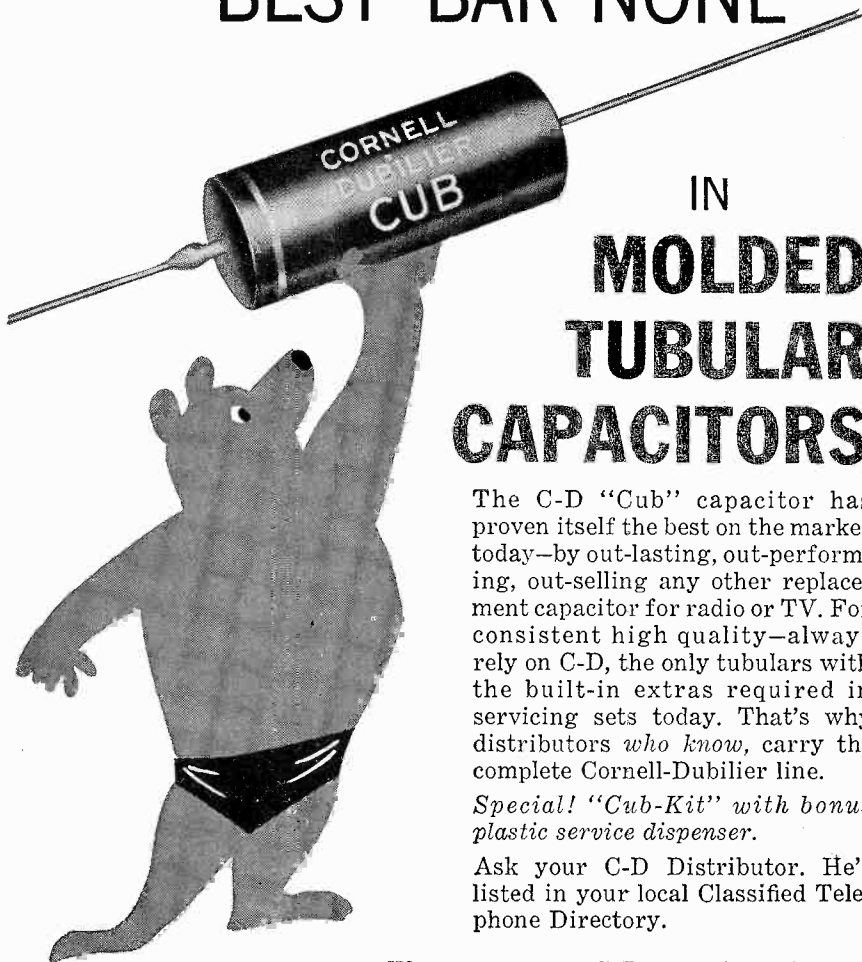

### IN MOLDED TUBULAR CAPACITORS

The C-D "Cub" capacitor has proven itself the best on the market today—by out-lasting, out-performing, out-selling any other replacement capacitor for radio or TV. For consistent high quality—always rely on C-D, the only tubulars with the built-in extras required in servicing sets today. That's why distributors *who know*, carry the complete Cornell-Dubilier line.

*Special! "Cub-Kit" with bonus plastic service dispenser.*

Ask your C-D Distributor. He's listed in your local Classified Telephone Directory.

*There are more C-D capacitors in use today than any other make*



CONSISTENTLY DEPENDABLE  
**CORNELL-DUBILIER CAPACITORS**

Plants in South Plainfield, N. J.; New Bedford, Worcester and Cambridge, Mass.; Providence and Hope Valley, R. I.; Indianapolis, Ind.; Sanford and Fuquay Springs, N. C.; Venice, Calif.; subsidiary, The Radiart Corp., Cleveland, Ohio.

Printed in U.S.A.

# MODERN PHOTOCELLS

It was 116 years ago when Becquerel discovered that illuminating one of two electrodes immersed in an electrolyte causes a voltage to appear between them, the voltage disappearing during darkness. Thirty-four years later, Willoughby Smith found the conductivity of selenium to increase under illumination. Still thirty-seven years later, Adams and Day noticed that light causes a voltage across a junction of selenium and iron. This effect was rediscovered in 1884 by Fritts, and again in 1930 by Lange. Forty-nine years after Becquerel, Hallwacks found that ultraviolet light will slowly discharge a zinc plate previously charged negatively but that a positively-charged plate is unaffected. Later investigators found a number of metals and non-metals to exhibit the Hallwacks effect. Some historians credit Hertz with making this discovery the year before Hallwacks.

From this chronology, one sees that the development of photoelectric devices has spanned more than a century. On this basis, the "electric eye" may be considered older than the organized science of electronics, its natural homeground. Always fascinating in its promise ultimately to convert sunlight into useful amounts of electrical energy, the photoelectric principle was for many decades little more than the basis of a curious demonstration of the generation of electricity.

The development of photoelectric devices has proceeded on two fronts, characterized by their single end-

products: photoconductive and photovoltaic devices. The photoconductive device, acting like a light-controlled resistor, modifies the flow of current in a local circuit. The photovoltaic (self-generating) device sets up a voltage under the influence of light. Each device often exhibits some of the properties of the other. Knowledge of photoconductivity is thought to date back to Willoughby Smith's observation on selenium (1873), while the photovoltaic phenomenon has been our legacy since Becquerel's discovery (1839).

Becquerel's electrolytic prototype inspired a commercial application during the 1930's in the form of the Rayfoto cell. This self-generating device was composed of a copper oxide and a lead electrode immersed in lead nitrate solution. The oxide electrode was illuminated. The output of this cell was of the order of 150 d-c microamperes per lumen. Other electrolytic photocells also were introduced around the same time, but all have given way now to dry types.

The early selenium photoconductive cell (quite different in construction and application from present-day selenium photocells) perhaps was the one type with the longest history of limited exploitation. The relatively low sensitivity of this cell, its sluggishness, and the unavailability of sensitive relays at the time for use with it probably were the main reasons why the original selenium photoconductive cell never won full commercial success.

During the late 1920's, commercial dry-disc photocells made their appearance. While they may be used either as photoconductive or photovoltaic devices, it is in the latter category that they attracted most attention — and still do. The first such successful commercial cells used a thin layer of copper oxide on a plate or disc of copper, but these have been supplanted

## CORRECTION

In the circuit diagram on page 8 of the April, 1955, issue of the Capacitor, terminal 1 of the type 1U4 tube and terminal 5 of the 3S4 tube should be grounded.

completely by the type composed of a selenium film on iron or aluminum. The basic structure of these cells is the same as that of a copper oxide or selenium rectifier plate, but a curious fact is that electrons released by light travel through the plate in the opposite direction to those that move during use of the plate as an a-c rectifier.

Parallel development of phototubes took place about the same time the dry-disc photocell first was being exploited. Because the photocell disc has such a high value of inherent self-capacitance, its frequency response is limited, and the phototube out-

stripped it in such applications as sound-on-film reproduction. The result is that until more recently, this type of cell was pushed aside completely by the phototube in all applications except photographic exposure meters and similar light-measuring instruments where the low d-c output of this cell was enough to get along with and its ability to operate without a power supply was a paramount feature. Even in such commonplace equipment as burglar alarms, the phototube maintained its leadership.

Modern photocells, all made with semiconductor materials, are now available in several types. These in-

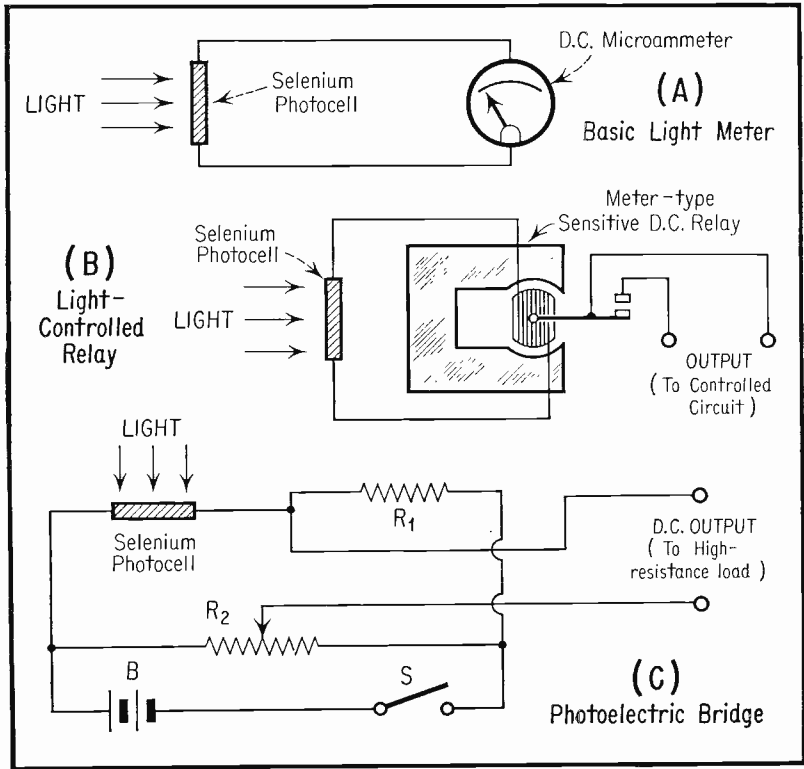

Fig. 1. Selenium Cell Circuits.

clude both photoconductive and photovoltaic types, although each method of operation is afforded to some degree by all types.

### Selenium Cells

Modern techniques have produced commercial selenium cells which are not paralyzed easily by excessive light intensities as were the early types. These single-plate cells are available in a number of sizes and shapes for individual applications.

The smaller units, because of their reduced areas, have less internal capacitance. However, the inherently higher capacitance of the dry-plate type of cell still restricts high-frequency operation. The larger sizes (active area of approximately  $1\frac{1}{4}$  inch) are limited to a maximum frequency in the vicinity of 5000 cycles (chopped or modulated light), although this figure will vary with similar cells from different manufacturers. D-C outputs likewise will vary with manufacture, but values of 0.05 to 0.1 volt across 100-ohm resistive load, at 100 foot candles, are typical of the units with  $1\frac{1}{4}$  to  $1\frac{1}{2}$ -inch active area.

The modern selenium cell is typified by the cell used in photographic exposure meters. There is no difficulty in deflecting a 0-100 d-c microammeter to full scale with the output of such a cell, as is done in these meters (See Figure 1A). The scale of the meter may be graduated conveniently in arbitrary units, exposure figures, lumens or foot candles.

The present availability of high-sensitivity d-c relays makes it possible to set up a light-operated relay requiring no standby power nor any attention. This type of circuit is shown in Figure 1B. The relay is of the d'Arsonval meter type (example, Weston Sensitrol) and may be obtained to close on a few microamperes. A small amount of light will pick up the relay. The advantage of this circuit is its complete freedom from power supplies, either battery or power-line type.

Where higher-voltage d-c output is required, the photoconductive proper-

ty of the selenium cell may be utilized. Figure 1C shows a d-c bridge, for example, in which one arm is the internal resistance of the photocell. The battery polarity is such that the cell is reverse-biased. That is, the cell offers its high (back) resistance. The bridge is balanced initially, with the cell darkened, by adjustment of potentiometer  $R_2$ . When the cell subsequently is illuminated, the bridge unbalances and the output voltage can be one-half the battery voltage or higher, provided this output is presented to a high-resistance load. Typical circuit constants are:  $R_1$  20,000 ohms,  $R_2$  25,000 ohms, B  $2\frac{1}{2}$  to 45 volts, and output voltage under illumination 10 v dc.

### Germanium Photodiode

Prominent among modern photocells is the germanium photodiode. This unit grew out of the early observation by workers with crystal diodes that illumination of the point-contact area causes a change in current flowing through the diode. A small photovoltaic effect also can be obtained.

Aside from its extremely small size, the main advantage of the point-contact type of germanium photodiode is its small internal capacitance (less than 1 uufd). This enables operation at frequencies up to 100 kc. Although the self-generating ability of this type of cell is slight, its photoconductivity may be utilized readily. A simple basic circuit is shown in Figure 2B. Here,  $R_L$  may be a load resistor, as shown, or some working device such as a d-c relay or current meter. The d-c bias polarity is such that the reverse current path of the diode is utilized.

For the Sylvania 1N77 point-contact photodiode, dark reverse current is less than 500 microamperes at -50 v dc. This type of photocell is active over the entire visible spectrum but its response peaks in the infrared region at a wavelength of approximately 1.7 microns. Figure 2A gives static operating characteristics for various values of load resistance and reverse voltage.

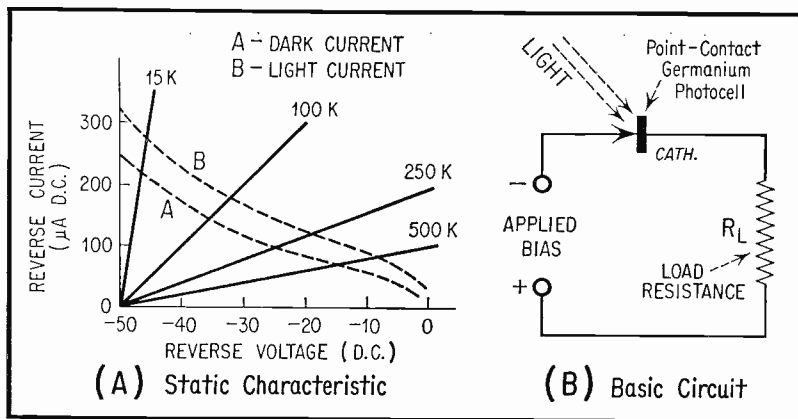

Fig. 2. Point-Contact Germanium Photocell.

Lately, junction-type photodiodes have become available commercially. Typical of this group is the Sylvania Type 1N77A which, though tiny in size, has a built-in lens. Despite the junction nature of its active element and the resulting higher inherent self-capacitance than found in the point-contact type, the 1N77A response is only 2 db down at 10 kc.

Working as a photovoltaic cell, a peak output power of 1.4 microwatt can be developed by a light intensity of 1200 lumens per square foot. Like the point-contact type, this photodiode has a response peak in the infrared region, at a wavelength of approximately 15,000 Angstrom units.

The junction type has been recommended for such modern applications as reading punched cards or tape in high-speed electronic computers and data processing machines, and in motion picture sound pickup. It can be used also in the basic circuits, such as Figures 1A, 1C, and 2B and in variations of these circuits. In d-c circuits, the cathode lead is connected to the point of positive bias for reverse-current flow, and applied d-c voltages up to  $-50$  v maximum are common. At this voltage, the dark reverse current is 200 micro-

amperes maximum. At  $-10$  v, it is 50 ua maximum.

#### Cadmium Sulphide Photocell

Cadmium sulphide is another semiconductor used as the active material in modern photocells. The miniature cadmium sulphide photocell (typified by Clairex CL-1) has a sensitivity of 100 microamperes at 100 volts and 2 foot candles. Its 100-volt dark current is only 0.05 microampere, and this cell can be operated with applied voltages as high as 250 v ac or dc at a power dissipation of 50 milliwatts. When operated with chopped

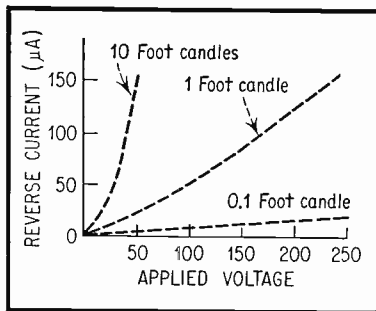

Fig. 3. Cadmium Sulphide Photocell Characteristics.

or modulated light, the response falls off at the rate of 6 db per octave. Figure 3 shows tentative static characteristics of the Type CL-1 cadmium sulphide cell.

At high light intensities, this photoconductive cell will operate a 1-ma d-c relay. Its high sensitivity also enables it to drive vacuum tubes and gaseous trigger tubes at low light levels.

This type of cell may be employed in the circuits shown in Figures 1C and 2B. Two power-operated relay circuits, recommended by Clairex, are shown in Figure 4.

The relay circuit in Figure 4A is operated from a 250-volt d-c power

supply. It employs a 6C4 or 12AT7 tube, V. The d-c relay is a 10,000-ohm unit. Sensitivity of 0.1 foot candle may be obtained with the CL-1 photocell when the photocell load resistor,  $R_1$ , is a 10-megohm potentiometer. The current-limiting resistor,  $R_2$ , is included for overload protection and is 0.18 megohm. The cathode resistor ( $R_3$ , 10,000 ohms) and cathode bypass capacitor, C, determine the time constant of the circuit. A capacitance of 100 ufd is recommended for 0.1 foot-candle operation, and 10 ufd for 1 foot candle.

The relay circuit in Figure 4B is operated directly from the a-c power line. Here, the cadmium sulphide

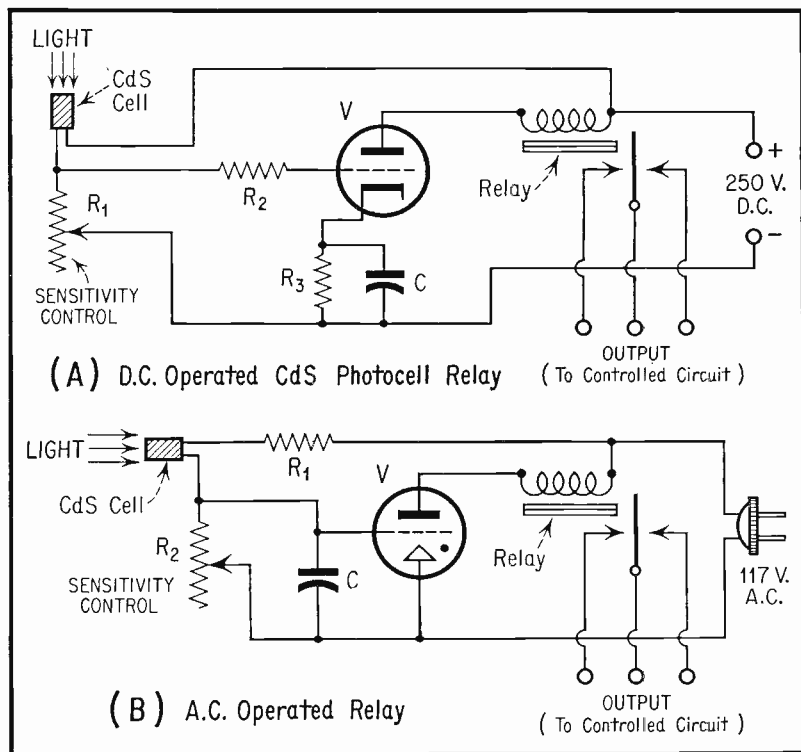

Fig. 4. Cadmium Sulphide Photocell Circuits.

photocell is operated in conjunction with a cold-cathode gas tube, V, such as Type 5823. As in the preceding circuit,  $R_2$  is a 10-megohm potentiometer. The current-limiting resistor,  $R_1$ , is 0.15 megohm. Bypass capacitor C is 270 uufd. A 110-volt a-c relay is employed.

A line of high-output, linear-response, miniature cadmium sulphide photocells is manufactured by Standard Piezo Company. These cells are capable of output currents in excess of 1 ampere at 100 foot-candles illumination at 100 volts dc, and of more than 1 microampere at 1 foot candle at 5 volts dc.

The high output and the high sensitivity (1 to 10 amperes per lumen) of these particular CdS photocells adapt them to many circuits where amplifiers must be eliminated. For example, sensitive relays may be operated at extremely low light levels without tubes or transistors, and less-sensitive relays ordinarily used with amplifiers may be operated directly (with the cell as a photoconductor) at moderate light levels. Figure 5, for example, shows a tubeless, light-sensitive relay circuit which can be operated from the a-c power line for

use with Standard Piezo Types CdS-1, CdS-2, and CdS-3 cells.

### Lead Sulphide High-Intensity Cell

Lead sulphide has been used before as the active medium in photoconductive cells. Recently, however, Eastman Kodak Company has introduced a new cell known as the Ektron Detector. Consisting basically of lead sulphide on glass, these cells respond to radiations from ultraviolet through the visible spectrum, but have a pronounced peak in the infrared region.

A particular feature of the Ektron detector is its high infrared sensitivity which suits this cell to the detection of warm objects at great distances. Very slightly warm objects can be detected at close range. The hot ash on the end of a cigarette and a flashlight bulb operated from batteries so weak that the filament scarcely glowed have been used to obtain useful output from this cell. In an intrusion alarm, which itself defies detection, the Ektron detector makes possible operation of the lamp at so low a level that no glow is visible. Lamp drain under these conditions is exceedingly low and lamp life is almost unlimited.

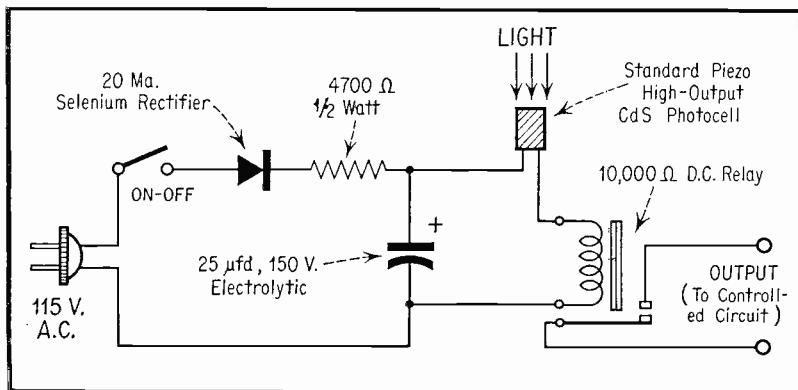

Fig. 5. High-Output CdS Photocell Relay.



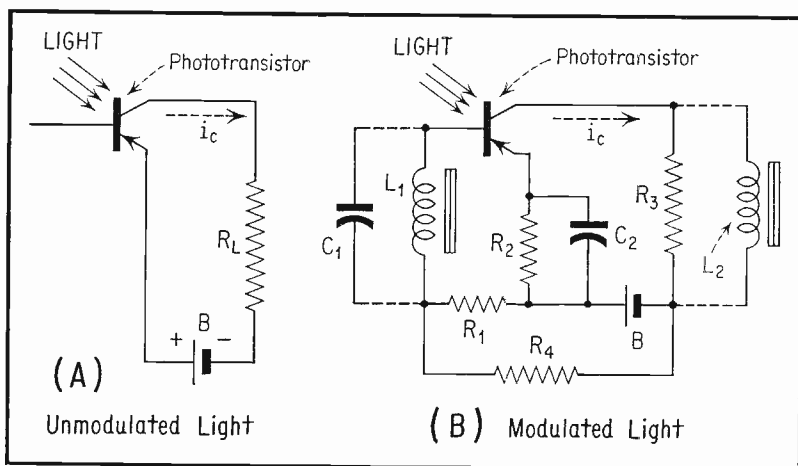

Fig. 6. Phototransistor Circuits.

Typical performance of an Ektron detector with 10-mm by 10 mm surface, operated with a polarizing voltage of 100 v, is: dark impedance 0.25 to 0.75 megohm, signal level 1.2 millivolts, light chopping frequency 90 cps, signal-to-noise ratio 80:1, time constant 200 to 300 microseconds.

#### Phototransistor

The phototransistor is a miniature, light-sensitive, junction transistor. The Radio Receptor Type RR66 is typical of this new photoelectric device. Intended primarily for use in automobile headlight dimmers, this phototransistor also finds application in many industrial and domestic light-operated devices. Its output level is sufficient to operate a relay.

When used with unmodulated light, as shown in Figure 6A, the base connection of the transistor floats. Fig. 6B shows a circuit for use with chopped or modulated light. The inductance,  $L_1$ , shown in the base circuit of the transistor, can be tuned to the light-modulation frequency by capacitor  $C_1$  for increased sensitivity of the circuit. The collector output circuit can contain resistance ( $R_2$ ) or inductance

( $L_2$ ). Resistors  $R_1$  and  $R_4$  form a voltage divider for the development of d-c base bias.

Typical modulated-light operation with a battery (B) voltage of 12 v,  $R_1$  1000 ohms,  $R_2$  1000 ohms,  $R_3$  10,000 ohms, and  $R_4$  20,000 ohms is: sensitivity 160 millivolts per foot candle at a collector current ( $i_c$ ) of 500 microamperes dc. Spectral response peaks at a wavelength of about 1.6 microns.

#### Silicon Photocells

Plate-type photocells in which the active semiconductor element is silicon have been applied recently as high-output units in conjunction with conversion of sunlight into relatively large amounts of electrical energy.

This so-called solar battery has been publicized in recent months as a result of successful experiments with it at Bell Telephone Laboratories. At this writing, however, no data are available on the performance of individual plates. No resume of modern photocells would be complete, however, without some mention of this silicon plate.



This CORNELL-DUBILIER Advertising Service is FREE to "Capacitor" readers. If there is anything of general interest or appeal in the line of electronic equipment or service that you want to BUY — SELL — or SWAP . . . if you want a job or need help, these columns are at your service.

Please PRINT or TYPE your Ad clearly and limit it to 40 words including your name and address. Because of space limitations — only one Ad at a time — please.

Ads are published in the order received and as space permits.

CORNELL-DUBILIER ELECTRIC CORP. reserves the right to edit your Ad to conform to its policies and is the final judge of its suitability for publication. We do not assume any liability or responsibility for any transaction that results. Make your deal direct with the advertiser listed in the Ad.

If you have a "CHANGE OF ADDRESS" — give both your OLD and NEW and mark your request "For C-D Capacitor Mailing List."

IF YOU ARE RECEIVING DUPLICATE COPIES FOR WHICH YOU HAVE NO USE, PLEASE ADVISE YOUR LETTER CARRIER STATING — "DUPLICATE — NOT WANTED".

**SELL OR TRADE** — Hallicrafter S-76 with built-in 100 kc. standard, \$100; Pentron 93TCM basic recording unit. Harry N. Cohen, 1177 Anderson Ave., Bronx 52, N. Y.

**SELL OR TRADE** — Heath condenser and bridge, \$21.50; Heath sig. tracer, \$22. Both 1. n., postpaid. W. F. Onder, Route 2, Box 193, Arnold, Mo.

**FOR SALE** — Mobile trans. Stancor 203-A, now on 75 meters, built-in VFO, 6146 final, 20 w., dual vibropack power supply, Shure push-to-talk mike, Master mobile antenna, complete, \$50. P. Hnat, 78 Hedley St., Buffalo 6, N. Y.

**WANTED** — National SW-3 receiver in exc. cond. Albert Kaiser, 1331 Dayton St., Camden 4, N. J.

**WANTED** — Tape recorder in good working order, small FM tuner and Alliance automatic antenna rotator. Will swap top quality intercom system or misc. radio and TV parts, equip., and hardware. L. Buddine, Box 62, Haddon Heights, N. J.

**WANTED** — HQ-140X rcvr. State price and cond. Charles H. Moore, Box 64, Nunica, Mich.

**FOR SALE** — Unused Heath V-7 printed circuit VTVM, assembled, \$37.50; Hallicrafters S-38, exc. cond., \$27; RCA MI-4288-J 50 w. PA amplifier, \$35; two Remler 50 w. reproducers, \$30. R. L. Evans, Jr., Box 28, Ambler, Pa.

**WANTED** — Zenith AM-FM radio model H-1086R, H-1083E, H-1087R, and Zenith FM radio, model 7M918. George A. Cahill, East Dennis, Mass.

**FOR SALE** — \$75 takes factory wired 10 meter Stancor xmitter, hardly used, with tubes, triband converter, Carter dynamotor, 6 v. 41 amp input, 400 v. 375 MA output, all in perf. cond. with instructions. Vincent Giangregorio, 140-17 Poplar Ave., Flushing, L. I., N. Y.

**SWAP OR SELL** — Model O1 Heathkit scope, converted to model O8, guaranteed exc. cond., for 2 1/4" x 2 1/4" 300 or 500 w. slide projector, or \$45. J. H. Ross, 2406 Lincoln Ave., St. Albans, W. Va.

**FOR SALE** — West. Elec. model 227B ship-to-shore radiophone, complete with xtals, Continental Motors 15 v. DC gas eng. gen., TBY transceiver. All guaranteed. R. H. Ives, Route 2, Box 32, Lynnhaven, Va.

**WANTED** — Test equip., must be cheap. State price, model, age, and cond. in first letter. R. B. Johnson, 3922 West 108th St., Inglewood, Calif.

**FOR SALE** — Tape recorder Brush Sound-mirror BK-414 portable, with service manuals and extra tape in A-1 cond., \$50, local preferred. Edward B. Schofield, 9031 Fort Hamilton Parkway, Brooklyn 9, N. Y.

**WANTED** — Arovox L-C checker mod. 95, in usable or repairable cond. Cash or swap. Laidley and Bammes Radio, 1280 Court St., Redding, Calif.

**FOR SALE** — Webster wire recorder with extra reels, wire, phones, and mike, \$25 in exc. cond. Sosville Recording Studio, 712 E. St., Marysville, Calif.

**SELL OR TRADE** — Magnetic wire recorder RCA, MI 12875. Good cond., but needs cartridge. Roy Goodwin, North. Dr., R. 1, Ben Hill, Ga.

**WILL BUY** — All kinds of test equipment Eico, Heathkit, or Precise. State model numbers, price and cond. Hohlfield Elec. Co., Greenleaf, Kan.

**WANTED** — Roll Chart tube tester in working order. Will pay reasonable cash or swap tubes, parts, or NRI comm. course. X-Perit Radio Service, Box 794, Wausau, Wis.

**SWAP** — Motorola Portable Model 48L11 for good 78 rpm record player, or ?? Kenneth D. Purdy, Cisne, Ill.

**SELL** — Riders manuals 8, 10, 11, 13, 14, \$7 each. Want converter, 110 v. AC to 6 v. DC. Melvin Saur, Kent City, Mich.

**FOR SALE** — All l. n.: Weston ohmmeter model 689, \$10; Simpson, AC, 2" volt-meters, 0-150 v., \$3 each; Eico, 360 K, FM-TV sweep gen. with instruction, \$15, prices less shipping costs. Freedman, 144-34 72 Drive, Flushing 67, L. I., N. Y.

**SWAP** — MN-26A radio compass rcvr. 150-1500 KC 14 v. DC, similar to MN-31 described in Jan., '44 Electronics. Will take firearms, photo or optical equip., tools or what have you? James N. Gilbert, 621 Mississippi Ave., Silver Spring, Md.

**FOR SALE** — McGraw Electronics magazine, March, May to Sept., 1951; August 1950. \$2 prepaid. Victor Kozma, 3104 Wilkinson Ave., New York 61, N. Y.

**SWAP** — Triplett tube tester, BC454 rcvr., AM-FM rcvr., 12" weighted turntable, Mark II transceiver, old 2 v. tubes. Want 3 x 5 printing press, all band tuner, plate xformer, 28 v. gear. A. B. Hall, Ider, Ala.

**SELL OR TRADE** — Meissner analyst, \$30; Eico sig. gen., \$20; Heath vibrator tester, \$15; Riders, VOLS. 1, 2, 4-6, 9, 10, \$5 ea. Eico scope, needs work, \$17. P. Ferrina, 4309 Kansas Ave., NW, Washington 11, D. C.

**WANTED** — Scintillator, Geiger counter (A.E.C. specifications); metal locator; uranium and precious metals test outfit. J. J. Swiatek, General Delivery, Newark, N. J.

**SELL OR SWAP** — L. N. model 504-A Supreme tube and set tester, natural maple portable case. Want ham gear. Eddie Gigliotti, 249 South Main St., Bangor, Pa.

**FOR SALE** — General Industries phono motors: 115 v., 60 cycle: 6 model DR, each \$19.50; 5 model D, each \$27.42; 3 model CX, each \$13.25; also RC 130 automatic record changer and recorder, \$26.76. Harry J. Anderson, 166 Lenox Ave., Horseheads, N. Y.

**WANTED** — 16 mm sound movie projector, late model; Spectrograph, over 20,000 lines for cash. Ed Sablin, 1727 Sunset Ave., Seattle 16, Wash.

**FOR SALE** — Riders manuals 1-5 and 6 to 14, complete and in good cond., \$80. R. E. Wheaton, 614 E. Third St., Hobart, Ind.

**WANTED** — Stevens 15" speaker model 103LX; Rekokut turntable LP743, high frequency driver with horn. Will sell or trade National NC109R FM tuner rack panel with monitor speaker, microvolt meter; National SW54 comm. rec. J. R. Halchak, 12 Essex St., Stoneham, Mass.

**WANTED** — Good used Hickok test equip. Send list and lowest cash price. Thornhill Radio and TV, Roschton, Ga.

**WANTED** — Simpson 260 v ohmmeter, not roll case type; Greenlee or Pioneer chassis punches sizes 1 1/2", 3/8", 7/8", and 1/2". Don Jensen, 3529 Dunn Ave., Cheyenne, Wyo.

**WANTED** — Riders, 16 up; Photofacts, Heathkits, Acrosound Actput, Scott Radios, 15" Hi-Fi speaker, test instruments. Cardona Radio, GZB-10, Puerto Nueva, Puerto Rico.

**FOR SALE** — DuMont 245 scope complete with instrument book; RCA sig. gen., 153 with instruction book, both for \$50. Lou Smith, 726 Rutherford Ave., Lyndhurst, N. J.

**WANTED** — Complete Radio TV course, with or without kits if priced low enough. Send full particulars on price, cond. etc. in first letter. Thomas Barni, 5331 Pattison Ave., St. Louis 10, Mo.

**WANTED** — Code equip, code records for novice, also Hallicrafter, S53A rcvr. G. A. Robinson, 79 Beaver St., Salem, Mass.

**TRADE** — 35 mm Argus "21" with case, pocket rangefinder, and SVE model AK 300 w. projector for Sprague Tel-Ohmike TO-4 or Simpson 289 meter. C. C. Westing, 3816 6th Ave., Des Moines, Iowa.

**FOR SALE** — Meissner 150B xmitter and deluxe signalshifter and matching crystal oscillator; Astatic AT1 TV booster; RME Boomerang BK-IN large UTC cathode mod. xformer; BC-375 tuning units; small prop pitch motor. Make offer. C. Lohner, 157 Logan, Bedford, Ohio.

**FOR SALE** — Webster 56-1 changer, 78 rpm, used very little; wire recorder mechanism with phono arm, 78 rpm; NRI VTVM w/o batteries from lesson kit. First reasonable offer. W. D. Glenn, 25 Sunset Rd., Massapequa, L. I., N. Y.

**SELL OR TRADE** — Unused Mallory UHF converter with channel 49 antenna and coupler, \$20. Trade for small used TV or what have you? W. D. Parsons, Rt. 3, Box 278, Charleston, W. Va.

**SWAP** — Mobile xmitter, 10 or 20 meter, 50 w. phone, illuminated meter, relay, commercially built, 1. n.; also Leece-Neville for test gear, photo equipment or fixed station equipment. Robert J. Siegel, 130-18 223 St., Springfield Gardens 13, N. Y.

**WANTED** — Log Log Vector Hyperbolic slide rule, Pickett No. 4, or equivalent. Will pay cash or swap two RCA 813 tubes. R. Levy, 68 Thayer Hall, Cambridge 38, Mass.

**FOR SALE** — 8" Craftsman bench saw with dado blades, 2 combination blades, adapter, carbide tipped blade; also metal stand with switch. All for \$90. John J. Lore, 11 Forest St., Iselin, N. J.

**WANTED** — Used or new 71P4's or 8BP4. State cond. and price. Louis Ventenelli, 224 1/2 21st St., Brooklyn 32, N. Y.

**SELL OR TRADE** — Radio, TV, ham parts, tubes, 807's, supplies, books, manuals, Emerson FM 7 tubes. Make offer. Want good FM or FM-AM set. Seymour Genser, 2236-82 St., Brooklyn 14, N. Y.

**SELL OR SWAP** — Police alarm FM rcvr. PR-9 152-174 mc., \$35 or swap for PR-31 30-50 mc., exc. cond. Prefer local. Walter L. Snow, 2 Beckford St., Salem, Mass.

**WANTED** — 6 & 12 v. battery eliminator; also vibrator tester. Will swap TV FM sweep sig. gen., Masco 2-stage booster; misc. radio TV parts. Walt's and Ben's TV Service, 178 Intervale Ave., Burlington, Vt.

**WANTED** — Riders TV manuals 1-13; also 6-12 v. battery eliminator. State price and cond. Louis Greenblatt, 144-40 77th Rd., Flushing 67, N. Y.

**WANTED** — Anyone owning a Superior Instruments Co. tube checker model 450-A with CRT adaptor, please write: Thompson's Radio-TV, 403 Smith St., Bay City, Mich.

**FOR SALE** — Philco batt. osc.; 301 Weston meters; AC-DC and AC MIG sets; batt. port.; small pix TV's; all FOB want Sear's gas welder. Corwe Radio-TV, 2708 Westbrook Dr., Franklin Park, Ill.

**WANT** — Manual for diagram for McMurdo-Silver 904 resistance capacitance bridge. Cash, or swap radio parts. B. Gallina, 380-N 7th St., Newark, N. J.

**WANTED** — Control box BC 602; 2 PL-P169 or PL-Q169. Will trade ham gear or pay cash. Also need pilots jack box BC 629B and 2 PL-P167 plugs. Henry A. Galbraith, 1214 South Alford Blvd., Evansville 14, Ind.

**FOR SALE** — Late S-77 rcvr., good reception on both ham and short-wave bands. Exc. cond., \$60. Will ship anywhere in U. S. Dare Corsair, 53 Seymour Ave., Newark 8, N. J.

**FOR SALE** — Sams Photofacts 1-110 in ten binders, complete, \$125; Zenith Cobra-matic conversion record changer kit No. S-17758, \$25. E. L. Sly, 6512 E. 6th St., Spokane, Wash.

**FOR SALE** — Mahogany console cabinet up to 16" picture for 630 or 830 chassis. Exc. cond., \$25; DuMont 16TP4 picture tube, used but exc. cond., \$13. Walter Isbert, 37 Birchwood Dr., North Arlington, N. J.

**FOR SALE** — Riders 1 to 3 abridged and 4 to 16, plus Riders TV 1 and 2, \$175, FOB Phila. George Greenberg, 821 Porter St., Philadelphia 48, Pa.

**TRADE** — Granco UHF converter with VHF booster 1. n., for capacitor-resistor checker. Will consider other trades. Thomas J. Lorek, 3048 Livingstone Ave., Niagara Falls, N. Y.

**WANTED** — FM mobile communications equip. R. Phillips, Box 8138, Plaza Station, Kansas City, Mo.

**FOR SALE** — Eico 5' scope model 425, \$35. H. Spilger, 1001 Anderson Ave., Bronx 52, N. Y.

**TRADE OR SELL** — Ikoiflex 3.5 Zeiss Ikon for Eico 425-K scope, or \$35; Binoculars 10 x 50 coated Rainier for Eico 625-K tube tester and pic. tube adaptor, or \$35. Interested in good used tape recorder. Joseph J. Yamin, U. A. C., 303 River St., Waterbury 75, Conn.

**FOR SALE** — Regency RC-600 and Sutco 22B UHF converters, less tubes; 2 sets 17Q strips; make offer; 500 ft. UHF tubular 20 GA lead in wire, \$15 or make offer. Ben Mueller, Box 401, Sanborn, N. Y.

**FOR SALE** — NRI model 69 tube tester; model 33 NRI professional signal tracer. Both in good cond., instruction sheets included. Russell Service, Ensign, Kan.

**WANTED** — Vol. I, RCA television Pict-O-Guide needed for instructions. State price. Lester E. Thompson, 101½ West Ave., Lenoir, N. C.

**FOR SALE** — Automatic car radio for 1953-1954 Dodge, looks and plays 1. n., \$29 COD. J. B. Zocchi, 10 Marlboro St., Exeter, N. H.

**SELL OR TRADE** — RCA 7JP4 picture tube, A-1 cond., Sylvania 12LP4 weak but usable; Jerrold all-channel TV booster. Want good sig. gen., Heath TS-3 or equiv., C. R. McLaughlin, 801 Kingston Rd., Baltimore 12, Md.

**FOR SALE** — Sam's Photofacts 1-120 in 12 Sam's hard-cover binders, \$75. Ben Barron, 340 N. Hayworth Ave., Los Angeles 48, Calif.

**FOR SALE** — Precision E-200C AM-FM sig. gen. in good cond., only \$35; Eico resistor-condenser checker 950A, \$12. George, General Delivery, Clarendon, Ark.

**FOR SALE** — Johnson all-band mobile antenna loading coil, 1. n., \$15; Gonset 2-meter mobile converter, good cond., \$25; NC-46, \$50; CW xtal control xmitter, 35. Herbert Greenberg, 821 Rutgers Rd., Franklin Square, N. Y.

**SELL OR TRADE** — Type NE 12 industrial time delay relay worth \$30 for \$10 or trade for recording or photo equip. Also have speedy sprayer for paint with new motor. Floyd Fellows, 45-27 170th St., Flushing 58, N. Y.

**FOR SALE** — Old type tubes, electronic books, TV and radio diagrams. William Conrad, 900 Dorking Rd., Glen Burnie, Md.

**SWAP** — Unused tube checker model No. 101C. Want tubes: 76, 42, 6AF4, 6D6, 5Z3. John Gibson, 19 Crestview Apt, Greenville, S. C.

**SELL OR TRADE** — General Radio 687A electronic oscillograph; Sweep Circuit serial No. 135, for cash or rcvr. Want 1936 or 1937 ARRL License Manual. Chas. T. Fernandez, 81 Warren St., Foxbury 19 Mass.

**FOR SALE** — Newly built and working 630 TV chassis with 20CP4A picture tube and mask, \$75; Cascode tuner with tubes, \$10; Eicor tape Recorder, exc. cond. with tape, \$75. Robert G. Lancello, 325 Plainville Ave., Unionville, Conn.

**FOR SALE** — Superior tester model 50, in good cond., \$10. Lowe E. Smith, Rt. 1, Trion, Ga.

**WANTED** — Manual for army surplus 1D-60/APA-10 Panadaptor. Have for trade: TA12, MP28BA, AN/AIC-2, IE-19A, TA-2J-24, MN-26A and B, SCR242B, 53B, TA6A and B, SCR269C, MTS1C. John Geczi, 12901 Forest Ave., Cleveland 20, Ohio.

**FOR SALE** — Weston meter 301 round 150 v. AC, 150 Ma. DC, 10 Ma. DC, 1.5 Ma. DC, \$3.95; W. E. 15 Ma. type-NR34, \$3; 2 Millen angle drives, 1. n., \$3.50 ea. M. Marshall, 455 Washington Ave., Dumont, N. J.

**SELL OR TRADE** — PA systems; Bud amp.; Wilcox-Gay recorder; portable radio-phonograph with changer, portable phono and amp. Grey Mather, 722 Charlotte St., Utica 2, N. Y.

**WANTED** — All band rcvr. prefer Hammarlund, H. E. Staples, 263 Bowers St., Jersey City 7, N. J.

**FOR SALE** — Eico model 950 capacitor checker A-1 cond., \$25; Heathkit TV alignment gen. TS3, 1. n., \$40. Robert Abbott, 25 Margareta Court, Staten Island 14, N. Y.

**FOR SALE** — 115 w. rack and panel xmitter 40-20-10, best of components; Meissner deluxe sig. shifter, all coils; BC221 freq. meter. Best offer. All schematics and charts included. John J. Dwyer, Box 76, Eddington, Pa.

**WANTED** — 15" speaker or high quality 12"; also Hi-Fi 6V6 output trans. Walter Smith, Rt. 2, Charlotte, Mich.

**WANTED** — Heath V-6, VTVM and 0-9 oscilloscope with all probes. No printed circuits! For cash. C. de Grijze, 25 Bogart St., Brooklyn 6, N. Y.

**TRADE** — AC Electronic Flash unit, exc. cond., complete with power supply, tube, and reflector for late model tube checker in A-1 cond. Bernard Arkenau, 23 Berwyn St., East Orange, N. J.

**FOR SALE** — Transvision CRT tester and reactivator, 1. n., with instructions, \$15, check or money order and sent pre-paid insured. L. Mick, 202 N. Peoria Ave., Dixon, Ill.

**TRADE** — 4.5 Graflex perfect with flash and accessories for short wave rcvrs. in perfect shape (name brand) will pick up within 100 miles of Long Island. John Runyon, 1350 Brooklyn Blvd., Bay Shore, N. Y.

**FOR SALE** — One man TV Service Business, doing \$950 mo. gross. Well stocked with tubes, resistors, condensers, shelves, up-to-date equipment, \$6,000; \$24,000 with brick front split level home. C. V. Singnorello, Box 333, Lodi, N. J.

**WANT** — 3-6L7 and 6HL metal tubes. Have other tubes and output xformers for trade. Send for list. Leon J. Bilyk, 121 Freeman St., Brooklyn 22, N. Y.

**FOR SALE** — Gonset deluxe tri-band converter, \$27.50; xmitter Motorola T69-20A, 30 w., includes 4-40 meter crystals, mike cables ant. relay, control box, operates 10 meter. Marvin S. Altschuler, 2703 Dobinson St., Los Angeles 33, Calif.

**POSITION WANTED** — Operator or serviceman for radio, TV, or radio telegraph. E.E. degree and F.C.C. radiotelephone and radiotelegraph first class licenses. A. W. Nevers, 402 S. Main St., Mt. Pleasant, Iowa.

**SWAP** — Radio-TV tubes; Shure model 55 dynamic mike with variable impedance; Carter dynamotor 420 v., 280 mils, 1. n.; Gonset converter 152 to 162 Mc. Want photo gear. D. Hamill, 1843 South Allport St., Chicago, Ill.

**TRADE OR SELL** — Sentinel 7" TV set for Radio-TV late model course complete with kits, or make offer. Jerome Wooley, 325 East 56th St., New York 22, N. Y.

**FOR SALE** — Sam's 1-40 in binders; also 41-53, 63, and 122; Riders vol. 13; Stancor P-6006 power trans.; Thordarson T-21F12 fil. trans., speakers and other items. Al Smith, Box 15, Greenfield, Mass.

**SELL OR TRADE** — RME-DB-20-70 preselector, RME-DM36 5 and 10 meter converter. Test Equipment wanted. J. Phennicie, Jr., Box 55, Norway, Iowa.

**WANTED** — 16 mm sound films, will pay cash or trade. F. Tantillo, 17 Orange St., Abington, Mass.

**WANTED** — Rcvr. for 220-225 megacycles, send full particulars. Chas. Stouth, Box 378, Secane, Pa.

**FOR SALE** — Riders manuals 1 thru 15, exc. cond., \$50. Harry Nobbliht, Edina, Mo.

**FOR SALE** — Sams Photofacts from 38 to 240. Un-used, exc. cond., \$160. Clarence B. Bolenbaugh, Box 171, Ohio City, Ohio.

**SELL OR SWAP** — Riders radio manuals 1 to 18 in perfect cond. Cash or trade for good camera. H. L. Benson, 315 Moiselle, Oklahoma City 10, Okla.

**FOR SALE** — Hallicrafters S-52 rcvr. with band spread, BFO, noise limiter, new tubes, realigned, \$40; Emerson 7" portable TV 600, \$46; Hallicrafters projector TV console, \$45 or can use HQ 120 or HQ 129X rcvr, peak to peak VTVM. Eugene Adams, 755 Delafield Ave., Staten Island 10, N. Y.

**FOR SALE** — Automatic record changer 78 RPM, \$12; Emerson phono combination, \$15; ATR inverters: 325 w., \$20 and 150 w., \$13; Zenith 3-way portable, 5 bands, \$25; Oak Ridge sig. gen., FM and TV, model 103, \$20. J. Kramer, 229 E 7th St., New York 9, N. Y.

**WANTED** — C-D Capacitor issues 1936 thru 1940, will pay fair price. Joseph V. Oliveri, 447 So. Ocean Ave., Patchogue, L. I., N. Y.

**SWAP** — Cameras still 4.5 lens and faster, one 16 mm movie camera and editor, for radio test equip. Mike Cles, 4252 N. Marmora Ave., Chicago 34, Ill.

**FOR SALE** — Gonset 3-30, \$15; Tri-Band and clipper, \$30; Sonapak, \$20; Elmac AF 67 and PMR6A with power supply, \$290, 1. n. L. Harrison, 1050 Bay Shore Blvd, Rochester 9, N. Y.

**SELL OR TRADE** — RCA ET5017 phone xmitter, 30-40 mc. AM, with schematic, weight 280 lbs. Want 30-50 mc. FM receiver, AC-DC, 6 v. DC or battery operated or battery eliminator. Prefer local. James F. Horan, 5029 Sherwood Rd. Pittsburgh 34, Pa.

**SELL** — Hammarlund 4-20 xmitter, 35 w. 80 to 10 TVI'ed, coils included, \$40; 4-11 mod., \$30; S40 rvr., \$65; all-band pre-selector \$8, perf. cond. Local preferred. V. P. Ternullo, 43 Robblee Ave., San Francisco 24, Calif.

**FOR SALE** — Webcor 80-1 wire recorder with mike, instruction book, 5 reels of wire, exc. cond.; Webcor 78 rpm record changer with base, perfect cond. No reasonable offer refused. Robert Spring. 2310 Vance St., Bronx 69, N. Y.

**WANTED** — L.M. or BC221 freg. meter in any cond. provided it has original calibration book. State cond. and price first letter. J. H. Griscom, Jr., 901 Monroe St., Annapolis, Md.

**SELL** — HQ129X, perfect; Meissner EX, KW final, \$80; 600 v. 300 Ma. supply, 807 xtal. xmtr., \$12; 130 ft. 8 cond. wire, \$4; 813's, \$9; 100 ft. RG8, \$4. Paul Bittner, 306 North 13th Pl. Springfield, Ill.

**FOR SALE** — C-D converter 11ORT25, input 110 DC, output 110 AC, low freq. hum. filter, \$20; Superior 650A sig. gen., 100 kc. to 35 mc. on fund. 25 mc. to 105 mc. on harm. 400 cycle ext. mod., \$15. H. W. Siemann, 130-27 230th St., Laurelton 13, Long Island, N. Y.

**FOR SALE** — 10" Philco table model needs power xformer; 10" Raytheon, no cabinet, needs tuner; used 21MP4, good cond. Best offer for one or all. A. Andres, 309 Glen Hill Ave., Yonkers 2, N. Y.

**FOR SALE** — Transformers: 500 w. mod., \$25; 5 v. 60 amp. fila., \$7.50; 3,000 v. DC 600 Ma. plate, \$50. Tubes: TV40, \$3.50; 8005, \$4.50; HF100, \$6; 75TH, \$7.50; 304TL, \$4. Manning, 2710 Lakeview, Rocky River, Ohio.

**FOR SALE** — Hickok 610A sweep gen., \$90. F. Garove, 722 Thayer St., Akron 10, Ohio.

**SWAP** — NRI multimeter; 200 Photofact folders filed alphabetically; Ghirardi's Radio-TV Circuitry and Operation, Audel's TV Service Manual; 200 resistors and condensers. Want test equipment. Ray Arendt, 207 E. Amherst St., Buffalo 14, N. Y.

**FOR SALE** — Power xformer: primary 115 v., 60 cy., secondary 1600 v. at 2 Ma. DC, fil. windings, 2.5 v at 1.75 a., 6.3 v. at 6 a., never used. Best offer. James Donaghy, 35 Montclair Ave., Roslindale 31, Mass.

**SELL OR TRADE** — Testing equipment, 1. n., \$300; radio and TV tubes and parts, \$500. Want pick up truck or jeep station wagon. Ray T. Holdman, 204 Jackson St., Bonne Terre, Mo.

**FOR SALE** — Hickok 202B VTVM. Bradshaw 10 VOM, both with probes, radio and TV tubes, parts, diagrams, manuals, phono parts. All letters answered. B. Fogelman, 22 Riverdale Ave., Brooklyn 12, N. Y.

**FOR SALE** — Radio-TV Shop, sales and service, estab. 17 yrs, fully equipped, one to three yr. lease, three months free. Ford 1/2 ton panel truck. Stock of radios, TV, and appliances. Inquiries invited. Comet Television, 549 Ocean Ave., Jersey City 5, N. J.

**SELL OR TRADE** — Old firearms, military rifles, xformers; neon and elect. motors. Need communications rec. Thos. Rohland, R. 3, Martinsville, Ind.

**FOR SALE** — RCA battery radio, 4 tubes walnut cabinet, fair cond., \$25, or what have you? Oscar Stevens, R. 3, Box 151, Benton, La.

**FOR SALE** — Xmitter, BC-459A, 696, 40-80; modulator 807S, two power supplies, metered, \$75; ARC-5, 2-3 mc., 1. n., \$15; auto xformer, tapped, 30 amp. with 0-150 AC GE meter, \$20. Stanley Kado, 2825 Claflin Ave., Bronx 68, N. Y.

**SELL OR TRADE** — 8-vol. set Encyclopedia, \$39.95 value for radio and TV items. Campbell, Box 183, Dublin, Pa.

**FOR SALE** — Ferret model 730 sig. tracer-electronic voltohmmeter complete with test leads, RF probe and instruction manual, very good cond., \$40 FOB. Otto M. Johnson, 5765 Gratiot Rd., Saginaw, Mich.

- WANTED** — Mobile 6 v. FM rcvrs., such as Monitoradio M-51 (30-50 mc.) and M-101 (152-163 mc.). State cond. and lowest price in first letter. A. R. Bell, Box 864, Bedford, Ohio.
- SELL OR SWAP** — Triplett 3434 sweep gen.; 5 x 8 Kelsey printing press; 6 amp. up to 6 batt. charger; 12 v. 50 amp. gen.; Mark II xmitter-rcvr. Wanted — VHF and UHF freq. meters. Slim's, 1147 Sunkist Ave., Waukeesa, Wis.
- FOR SALE** — Mallory Vibrapak VP552 in original carton, 6 v. to 350 v. 100 Ma., \$12, Bill Romain, 28 Avon Place, Staten Island 1, N. Y.
- SWAP** — Hickok 900B v., amp, wattmeter with case and test leads, RCA Color TV course, and service manuals. Want tape recorder or 16 mm. movie camera. William Barber, 309 Alexander St., Youngstown, Ohio.
- SWAP** — All-metal construction tilting tablesaw, motor and steel stand included for Garrard RC 80, 3-speed automatic changer. L. E. Flynn, Allen Place, So. Sudbury, Mass.
- FOR SALE** — Books on radio, theatre motion picture projection, shop practice, Elec. engineering. J. J. Cermak, 542 Woodside, Hinsdale, Ill.
- FOR SALE** — Antique electric radios, tubes, parts, catalogs, and magazines. G. N. Hartwell, 38 Charlemont St. Newton Highlands, Mass.
- FOR SALE** — Ten 16", 33 1/3 rpm broadcast transcriptions (Standard, Lang-Worth, etc.), good cond. with good music, all, \$9.95. E. W. Hill, 10 Plumtree Road, Levittown, Pa.
- FOR SALE** — Pilot 3" TV, \$45; Teleking 12 1/2" TV, \$50; portable disc recorder, 33 1/3 and 78, with radio and PA, \$75; Webcor tape recorder, \$125; Supreme 333 v., ohm Ma. analyzer, \$20. A. R. Dayes, 29 Charles St., Merrick, N. Y.
- FOR SALE** — Complete specifications for simple 7-tube converter to convert black and white TV to color using rotating color wheel, \$2.95. P. Vartanian, 1798 Santa Cruz Ave., Menlo Park, Calif.
- FOR SALE** — Precision EV-20 multimeter; field strength tester; Sylvania 139 tube tester with CR tube attachment; condenser-resistor tester NRI No. 112; Simpson 379 battery tester. Reuben Lagman, Box 33, Viola, Idaho.
- FOR SALE** — SX-71 without speaker, used very little, l. n. Best offer above \$130. Kenneth E. Gould, 509 Vine St., Liverpool, N. Y.
- FOR SALE** — Approx. 4,000 unused radio tubes in original boxes, mostly older types. Send list of requirements and offer for each type. William E. Freeman, 8418 11th Ave., Silver Spring, Md.
- FOR SALE** — Hallicrafter S40B rec., exc. cond., \$65; Heathkit VFO model VF-1, never used, \$15; low power phone-CW transmitter, \$25 (inquire about xmitter). Gary Gallupe, Riverside Ave., Fort Fairfield, Me.
- WANTED** — Used tape recorders, 8 mm silent and 16 mm sound movie projectors, 6 v. PA amp., cash or trade for audio-visual equipment. Lewy Film and Sound Service, 853 N. Eutaw St., Baltimore 1, Md.
- WANTED** — 19AP4 TV tube, guaranteed. Will swap electronic parts, tubes, shop tools. Frank Pray, 1156 Commonwealth, Boston 34, Mass.
- SWAP** — Astatic AT-1 Booster. Want VTVM, sweep generator, or 3" scope. John W. Rains, 2403 Dixie Place, Nashville 12, Tenn.
- WANTED** — Good Hi-Fi equipment in trade for 1. n., Hi-Standard "Sport King" .22 pistol, 4 1/2" barrel, 2 magazines; 750 rounds cal. 22 long. George E. Tyler, Pine Orchard Rd., Branford, Conn.
- TRADE** — Hezzanith (W.O. white) Vernier Marine Sextant, in A-1 cond., U. S. N. Observatory Certificate. Want ship-to-shore Marine radio, 12 v. and radio direction finder, Carl Nelson, 164-12 110th Road, Jamaica 33, L. I., N. Y.
- WANTED** — Contact with recent graduate of NRI Radio and TV Service, home study course of Washington D. C. Must be Cleveland or vicinity. Robert N. Weis, 4278 W. Anderson Rd., South Euclid 21, Ohio.
- SELL OR TRADE** — AN-APS 13 radar, BC522 rcvr, Dynamic mike, 3BP1's, radar-type tubes, 26 to 60 v. DC booster, Silver wavemeter. Want 16 mm projector or viewer, wattmeter, AC ammeter, magnet wire. R. C. Howard, 48 Stevens Rd., Clifton, N. J.
- WANTED** — Tube tester with roll chart. Advise model no., make, cond., age, and price. Ralph E. Schachat, 35 Meadowpark Ave. E., Stamford, Conn.



**WANTED** — Pix tubes, all sizes, local only. Will trade test equip., or cash. John Lubinsky, 3349 Fulton Rd., Cleveland, Ohio.

**SWAP** — LM freq. meter with AC supply and calibration book; Simpson model 663 VOM; receiving trans. tubes; Wilcox-Gay 3F10 Hi-Fi tape recorder; for Good FM-AM tuner, speaker enclosure and Hi-Fi record changer. Chicago area only. Stanford C. Stone, 4213 N. Broadway, Chicago 13, Ill.

**TRADE** — 7" and 10" Motorolas; 200 old (good) tubes, for 8 or 16 mm camera. Ed McEvoy, 715 So. 7th St., Lindenhurst, L. I., N. Y.

**SELL OR TRADE** — Approved field strength meter (VHF and UHF channels), \$50; Precision E-200-C sig. gen., \$45; Sonar condenser tester, \$35; Hallicrafter TV set, \$25; booster, \$10. Want tape recorder. All Haberman, 129 Morgan St., Holyoke, Mass.

**WANTED** — Hammond type G or H power amplifier with speakers with or without tone cabinet for a Hammond Organ. Have Knight model 232 Hi-Fi AM tuner, never used. Frank Szwaneck, Mullen, Neb.

**SELL OR TRADE** — Meck T60-1 xmitter; Gonset 10 meter converter; mikes, PE103 power supply complete with Thordarson xfomers D161918, D161912, chokes T19-C35, T19C42, capacitors, Merc. tubes, \$200 or Geiger Counter, boat and motor. Bob's TV, Ravenna, Neb.

**WANTED** — Radio for 1947 Lincoln working or not; 2-2 speed cheap G. I. recording motors; 16" discs. Harvey White, 1105 Waller Ave., Winnipeg, Can.

**FOR SALE** — In good condition. Gonset 10-11 converter and noise clipper, \$19; RME-45 rcvr. and speaker with built-in 100 kc. crystal calibrator, \$65 R. H. Fredenburg, 471 East Ford Ave., Barberton, Ohio.

**FOR SALE** — Elements of Elec. Engineering, Cook; American Electricians Handbook, Croft; Radio Engineering Handbook, Henney; Radiotron Engineers Handbook, RCA; Military Applications of Math., Hanson; TV Simplified, Kiver; Television, Zworykin. \$1.25 each postpaid. Charles Wendell, 19 Donald St., Bloomfield, N. J.

**SELL OR TRADE** — Rider's TV manuals, 1 thru 5, equal to new cond. Best offer. Nick's Radio, 169-10 140th Ave., Springfield Gardens 34, N. Y.

**SELL OR TRADE** — Eico 5' scope, \$24; Mallory 555H power supply, \$23; Simpson 260RT VTVM, \$29. All 1 n. Want 5-band converter, 12 v. dynamotor, beams, RF meters, or what have you? Phil Snyder, 5 Winchester Ave., Phila. 36, Pa.

**SELL OR TRADE** — Williamson amplifier kits, Pickering D140 and D260 cartridges with guaranteed perfect diamond styli, 3" Espey TV set. Want 16 mm movie camera, tape recorder, or what have you? Arnold B. Margolis, 120-16 234 St., Cambria Heights 11, N. Y.

**FOR SALE** — BC-221 AH freq. meter; 40 meter CW xmitter 70 to 120 w.; power supplies: 600 v. at 200 Ma. 6.3 at 6A; 400 at 200 Ma. 6.3 v. at 5A on separate chassis. All exc. cond. L. Berandt, 621½ Brooks St., Ann Arbor, Mich.

**FOR SALE** — 150 w., 40, 20, 10 meter CW xmitter, relay rack, VFO, 3 low voltage and one high voltage power supplies, metered, PP 811, \$75. Philadelphia area. R. B. Bonsall, 238 Bridge St., Drexel Hill, Pa

**FOR SALE** — Heathkit TS-2 TV alignment gen. and marker, factory calibrated, \$20. Robert Murry, 62 Front St., Addison, N. Y.

**FOR SALE** — Astatic AT1 booster; Stancor 110C xmitter, 100 w. lone CW; 2 TP6 plate xfomers, 1185 v. 500 m.; BC457, BC458, 2-866A with fil. xfomer; 20 w. power supply, BC456 mod. Chester Newell, 136 High St., Oil City, Pa.

**FOR SALE** — Wireless, telephone dial type remote control unit for 1941 Philco radio, \$5 postpaid; Scott volume expander, 4 tubes, push-pull input and output, from Scott 23-tube radio, \$10 postpaid. W. H. Greenbaum, 17 Poplar St., Elmsford, N. Y.

**FOR SALE** — 250TH transmitting tubes (unused Jan. tubes), \$9 ea.; 810 xmitting tubes, \$4 ea. All parts for a one amp., 3000 v. power supply, \$55 John B. Castle, 843 Princeton St., Santa Monica, Calif.

**WANTED** — Metal cabinet for surplus BC-221 frequency meter. State price. Victor Cargile, R. 1, Shallowater, Tex.

**FOR SALE** — Rear loaded cornerhorn cabinet, 15" Stephens woofer, 10" curvelinear tweeter, \$29.95; with 12" woofer, 6" tweeter, \$19.95. 3-speed record player, amp. and speaker, \$12.95. J. Davis, 1904 N. Laramie Ave., Skokie, Ill.

**WANTED** — RME-69. Swap or sell link freq. meter type 230-D2, 42.140, and 42.300 mc.; sola C.V. xformer 115V3A output; 6 v. dynamotors 500 v. 150 Ma. and 450 v. 175 Ma.; UTC-S48 100 w. converter 280 DC to 115 AC. McClure, 106 Wadsworth Rd., North Syracuse, N. Y.

**WANTED** — To contact students who recently completed RTTA correspondence course in Radio and TV. Also, interested in purchasing course without equipment. T. J. Romee, Public Works Dept., Navy 138, c/o FPO, New York, N. Y.

**SELL OR TRADE** — Harvey-Wells TBS50 deluxe bandmaster with speech amplifier, exc. cond.; 6 v. DC 300 v. .250 Ma. dynamotor for TBS50; Master Mobile 10M whip with body mount. Need Elmac AF67 xmitter. J. Cail, 1050 Meadowbrook Lane, Pocatello, Idaho.

**FOR SALE** — Books by Audel: Practical Electricity; Electric Appliance Repair and Servicing; Radio for the Millions; Everybody's Radio Manual: all for \$7. 2 crystals free. Ray M. Davis, Box 94, Pearl, Ill.

**FOR SALE** — Complete ham station incl. factory wired Johnson Viking Ranger, Hammarlund HQ 140X, Tel-Rex 20 meter Mini Beam, CD TR4 Rotor, coax relay, and mike, all l. n., \$450. Don Heller, 31 Joyce Rd., Tuckahoe 7, N. Y.

**POSITION WANTED** — TV serviceman with 6 yrs. bench experience wishes full time, steady employment, also radio repair. Age 40, white, married, 2 children; reliable and honest. Jerome Vogel, 2333 Eiler Ave., Pittsburgh 10, Pa.

**FOR SALE** — Tenna trailer, good cond.; Simpson TV antenna compass model 351. Want used Hickock jumbo meter model 4922. George Payad, 125 E. Main St., Staunton, Ill.

**FOR SALE** — Good shop instruments and unused Philco internal converters, UT21C and UT20A. Pennway Television Service Co., 5442 Penn Ave., Pittsburgh 6, Pa.

**WANTED** — Transcriptions and records from 1930-40. Will pay \$10 for early World discs and \$2 for records from my list. James Orlando, Dickerson Run, Pa.

**TRADE** — SX-62 Hallicrafter rcvr. with matching R-42 speaker in factory carton (needs alignment) for Precision 10-54-P tube tester and Photofact folders, from No. 103 up. H. C. Morris, 404 Second St., Shenandoah, Va.

**SELL OR TRADE** — Manly's Radio and Electronic dictionary, \$1; ICS reference library books on various subjects. Want 16 mm film and RCA 45 record attachment. Horace O. Pease, 144 Manson Ave., Kittery, Me.

**FOR SALE** — 68 vinylite transcriptions, 16", 33 1/3 rpm, popular and classical, in exc. cond. Over 400 individual selections. Gordon C. Gray, 945 Verdugo Circle Dr., Glendale 6, Calif.

**FOR SALE** — 125 w. CW trans., can be clamp tube modulated, 1625 parallel final, 6AG7 doublers, VFO, four band, \$60 FOB, Write for details. Neil E. Berg, 1111 3rd St. So., Moorhead, Minn.

**FOR SALE** — Eckotape 101-8 recorder, \$185; Hi-Fi magazines vol. 1, part vol. 4 (19 copies), \$5; Heathkit electronic switch S-1, \$19; UTC LS-22 \$16; GE RP10 cartridge pick ups, \$1.50 ea. Dayle Duckett, 3813 N. Bell, Chicago 18, Ill.

**FOR SALE** — NRI model 88 professional sig. gen., never been used, \$35. Arnold Unruh, Goodrich, N. Dak.

**WANTED** — Wiring diagram and parts list for Artone model 132 AM-FM radio-phonograph. Will happily pay \$1 for it. G. P. Lottich, 2119 Laburnum Ave., Roanoke 15, Va.

**POSITION AVAILABLE** — Electronic Engineer. Eng. degree preferred but not required. Must be familiar with industrial electronics and instrumentation. Majority of time to be spent on product development and application of electronics to various testing devices. Harry W. Dietert Co., 9330 Roselawn Ave., Detroit 4, Mich.

**FOR SALE** — Electronic hailing megaphones with new batteries, Merchant Marine surplus, \$25; E-200-C, \$45. Want Fairchild 541-A recording head. W. J. Slack, 1778 Fulton Ave., East Meadow, N. Y.

**FOR SALE** — NRI complete TV course, with all kits, l. n., \$50. David West, Kiamasha Road, Monticello, N. Y.

**FOR SALE** — 2 gross Ultra phones, 2 meter transceivers with tubes, l. n., \$35; BC 438 converted for 6 v. 200-400 kc. rcvr., good shape, with tubes, \$25; PE103-A dynamotor, l. n., \$35. Bernard Lyle, 26 W. St., Akron, Ohio.

**FOR SALE** — Heathkit alignment gen., model TS2, never used, \$15. Holden TV Service, 814 Richey, Pasadena, Tex.

**FOR SALE** — Amertran plate xformer, 6200 VCT, 700 Ma., \$50; filter chokes from BC-610, 8.8 henries, 600 Ma., \$10; 2 KVA Variac, 0-230, 1. n., \$30; G. E. open frame swinging choke 5/40 henries, 500 Ma., \$13. Macy, 2346 Dundee, Louisville, Ky.

**FOR SALE** — BC-348 0 rcvr. (built by RCA), 1. n., \$50; 110 v. power supply for above rcvr., \$6. John B. Castle, 843 Princeton St., Santa Monica, Calif.

**WANTED** — For cash or trade West. Elec. PA amplifiers. What do you need? H. H. Harrison, 300 37th Way, Sacramento, Calif.

**FOR SALE** — SX 71 with matching speaker, 1. n., \$160. P. J. Rutschn, R. 2, Box 762, Elizabeth City, N. C.

**FOR SALE** — Vibrapack Mallory VP-555H: 6 v. DC input, 300 v. 200 mills output, perfect, \$27. Merritt Malvern, 223 Grimsby Rd., Kenmore 23, N. Y.

**FOR SALE** — Deluxe mobile rig 3-band VFO automatic band switching while in motion, complete \$150; Deluxe KW rig, all bands, \$500; deluxe exciter, \$150. Don M. Lidenton, 701 Poplar St., Poplar Bluff, Mo.

**FOR SALE** — NC-125 rcvr. with matching speaker, year old; also panel meters, command xmitters and rcvrs. and maritime xmitter modified for broadcast use. W. D. Rathje, Grand Mound, Iowa.

**FOR SALE** — PE 157 vibrator power supply. Output 1.4 v. @ 500 Ma. and 125 v. @ 50 Ma., \$7. Two unused 2 v. wet cells (shipped dry), ea. \$1. N. L. Parker, 1240 Bedford, Detroit 30, Mich.

**WANTED** — For Cash. Radio World magazines 1934 to 1940. Walter F. Allgeyer, Box 207, Newark, N. J.

**SWAP** — 10" Delta band saw, 8" tilt-orth; "Darrja James" bench saw, both guar., 1. n., for top quality scope, sweep gen, and capacity checker. Herbert E. Pence, 311 So. 3rd St., Attalla, Ala.

**FOR SALE** — Precise test kits, R.F. osc., Marker gen. and VTVM kits or will trade for comm. rcvr. or 30 to 50 mc. police rcvrs. G. D. Griffin, 6421 Geary Blvd., San Francisco 21, Calif.

**FOR SALE** — Complete Radio-TV course including asembled scope and sig. gen. meter. Carl E. Zimmerman, R. 3, Pine Grove, Pa.

**FOR SALE** — 10-11 Gonset and Gonset noise limiter, \$15; antenna coupler will take 75 w. balanced and unbalanced line coax and open line, coils 10-80, \$15. Edward B. Schofield, 9031 Fort Hamilton Pkwy., Brooklyn 9, N. Y.

**FOR SALE** — Shure 55 Unidyne mike, 1. n., with floor stand, \$42.50; Turner Dynamic 22D with table stand, \$17.50. Wave King Radio, 2836 N. E. Sandy Blvd, Portland, Ore.

**WANTED** — Cables two approx. 18" in length for Motorola auto radio model 409. Have Radio and TV mags. in trade or give price wanted for cables. H. Seligson, New Hempstead Rd., New City, N. Y.

**SWAP** — 6B5 for brand new 6AU6, 12AU7, 6BQ6GTA or B. 6U8, 6CD6GA, 1B3G1, 12AT6, 12BA6, 12BE6, 35W4, 35Z5, 6AC7, 6SN7, 5AG5, 6J6, 5U4G. Ben's Radio Service, No. Tonawanda 2, N. Y.

**WANTED** — FM tuner for Magnexox AM FM, console model 148B style C104-336, or FM tuner of similar physical dimensions. Will pay cash. James McGee, R. 2, Monticello, Ill.

**FOR SALE** — ICS Radio Servicing and Elements of TV correspondence course, less kits, \$30 or trade for band saw or 8 mm motion camera. Lloyd T. Winters, 1040 Highland Ave., Cuyahoga Falls, Ohio.

**FOR SALE** — Alliance tenna-rotor, complete \$15; CREI Basic and Advanced Radio Eng. courses, \$25; Precision E-200 sig. gen., \$20; 10 juke-box 16 mm sound films, \$20 FOB. L. M. Swingle, 4723 48th St., NW, Washington 16, D. C.

**FOR SALE** — Barker Williamson butterfly condensers types CX34B, CX45B, JCX100E and JCX50E; also 12 mmf vacuum Jennings condenser, 20 K.V. Wm. H. Martin, Fife Road, R. 2, Bridgeville, Pa.

**FOR SALE** — Dry type transformer, 15KVA, 120 to 208/240 v., suitable for 220 v. appliances when only 115 v. is available. Best offer. L. J. Cunningham, 45 W. Charlotte Ave., Cincinnati 15, Ohio.

**FOR SALE** — Heath: TS1 TV alignment sig. gen., \$30; Simpson model 260 VOM, \$25; 25 w. amplifier, like WE 142 type, \$25. D. H. Deylan, 1240 S. Pest Rd., West Allis 14, Wis.

**TRADE** — Electric Hawaiian guitar, amp., case and accessories for test equipment. E. Harris, 1512 Fremont Rd., Sunnyvale, Calif.

**SELL OR TRADE** — Books: Practical Radio Communication 927 pages by Nilson and Hornung; Practical Math. for Home Study 697 pages, by Palmer and Bibb. Both books guaranteed. Alexander Podstepny, 1009 N. 2nd St., 2nd Flr., Phila. 23, Pa.

**FOR SALE** — Stancor mobile ST-203, new tubes, two xtals, used very little, plate meter on front panel, \$25; model 10M5 unused astatic hand microphone, \$12. C. G. Stuart, 141 Whiting St., Toledo 9, Ohio.

**SELL OR SWAP** — Elmac AF 67 used only 2 weeks, also HRO senior, with short wave coils. Want  $2\frac{1}{4} \times 3\frac{1}{4}$  speed or Crown Graphic, range finder and flash, and  $2\frac{1}{4} \times 3\frac{1}{4}$  enlarger 4.5 lens. Ronald M. Neiman, 958 So. Hills Blvd., Pottstown, Pa.

**FOR SALE** — 125 old type tubes such as 80, 27, 43 6F6, etc. 25c each or best offer for all; RCP tube tester model 322 \$20. John P. McCullen, 3050 Bainbridge Ave., Bronx 67, N. Y.

**FOR SALE** — Riders manuals, 1 thru 9 with index, clean, never used, make offer for all. F. Popkie, 7008 Colonial, Dearborn 6, Mich.

**SELL** — 5BP1, SCP1 CRT'S; Nat'l 1" scope, needs 913; old LM freq. meter. William L. Smith, Spencerville, Md.

**WANTED** — Hi-Fi speaker, turntable and pick up and FM tuner. Give lowest price acceptable. Theodore Nadeje, 5101-AA 39th Ave., Sunnyside 4, N. Y.

**WANTED** — Will pay \$50 for Bogen DB20-DP amplifier local only. Eugene Roy, 5 Hillside St., Haverhill, Mass.

**FOR SALE** — Philco 7050 tube tester; Solar capacity analyzer; Hickok 133-B 25,000 ohms per VOM or what have you to trade? S. S. Canfield, 1430 E. 55th St., Cleveland 3, Ohio.

**SELL OR TRADE** — Supreme tube and set tester model 405-A, 1. n., complete with test leads, instruction book and original carton; two BC-457 aircraft transmitters; ATR battery eliminator, complete, model 620. Want good mobile rig. Eddie Gigliotti, 249 So. Main St., Bangor, Pa.

**WANTED** — Fairchild 514 or similar disc recording cutting head. W. J. Slack, 1778 Fulton Ave., East Meadow, N. Y.

**WANTED** — Simpson Roto-Ranger model 220 tube tester. State condition and price. Charles H. Rieth, R. 4, Troy, N. Y.

**SWAP** — SCR-543 radio transmitter-rcvr. 40 w. output for RCA or Ferris sig. strength meter or other test equip. L. Brook, 1656 Manchester, Westchester, Ill.

**WANTED** — Operating instructions and/or operating manuals for TS100A/P scope and BC797B VHF transmitter. Will pay cash. Martin Johnson, 7th St. and Grand Ave., Alliance, Neb.

**SELL OR SWAP** — Advanced TV and FM Servicing course by CREI, 10 binders, 1952. Want Hi-Fi speaker, VTVM, or Communication rcvr., or make offer. Stanley Spiece, 3536 So. 15 Place, Milwaukee 15, Wis.

**FOR SALE** — Unused 350 w. 813 xmitter, professionally built, in Bud 19' cabinet, modulator push pull 1625, with 175 w. mod. xformer, \$225 2E26 VFO for same, JT 30 mike and extra 813. All above for \$275. Albert L. Crain, R. 1, Grandview, Mo.

**WANTED** — Two tube checkers, must be in working order, but need not be up to date. Will buy or swap. X-pert Radio-TV Service, Box 794, Wausau, Wis.

**SELL OR SWAP** — 2 Union car radios, also '41 Plymouth, 2 '41 Pontiacs, 2 '41 Chevrolets, '47 Buick, '41 Ford; several, 1. n., PA systems 15 w. Want Grid-dipper, S-38 or ?? Stanley J. Zuchora, 2738 Meade St., Detroit 12, Mich.

**FOR SALE** — Books: Radio Servicing by Marcus, \$2; Radio Engineering Handbook by Henney, \$1.50; Television by Zworykin, \$1.50. Charles Wendell, 19 Donald St., Bloomfield, N. J.

**WANTED** — Audio sweep gen., wow and flutter bridge, audio square wave gen., AC, VTVM reading down to .1 v. full scale at 100 kc. Boyd Mallet, 1455 Harrod Ave., Bronx 72, N. Y.

**FOR SALE** — Gen. Industries R-85L 2-speed disc recorder, \$22.50; portable typewriter, pica type, \$35; Scott 111-A noise suppressor, \$15; Astatic JT-30 Microphone, \$7.50; all FOB. V. R. Hein, 418 Gregory, Rockford, Ill.

**FOR SALE** — Hickock model 610A sweep gen., used once, complete with 4.5 mc. crystal, all accessories, probes, instruction manual in original packing case. Best offer. Julio Bellber, 503 W. 174th St., New York 33, N. Y.

**WANTED** — Late model tube checker in A1 cond. H. Wright, 146-15 130 Ave., So. Ozone Pk. 36, N. Y.

**SELL OR TRADE** — Back issues of QST, CQ, Radio News 1947 1948, and 1949. Would trade for HO gauge model train items magazines or antique buttons. David McKenzie, 2119 Douglas, Rockford, Ill.

**FOR SALE** — Capacitor Decade, Heathkit model DC-1 (laboratory type), 1. n., \$13. Joseph F. Dineen, 9 Winter Terrace, Westwood, Mass.

**WANTED** — Technical order for Army I.F.F. set SCR-515A. John Hoernle, 632 Weiser St., Reading, Pa.

**SELL OR SWAP** — TV and radio tubes in cartons, list value, \$182.50. Best offer. Interested in tape recorder, ham revr. or what have you? Milton Zwerling, 5630 Chrysler Ave., Baltimore 7, Md.

**WANTED** — Measurements model 80 or 82 sig. gen. Give price and condition. Electronic Engineers, Inc., 5615 West Division St., Chicago 51, Ill.

**FOR SALE** — RCA BC-474, exc. cond.; VFO portable transmitter and revr., 75 and 80 meter bands; phone and CW., \$60. FOB NYC area. Joe, 84-52 247th St., Bellerose, N. Y.

**TRADE OR SELL** — Underwood typewriter; Motorola-Blonde AM-FM Radio; UHF converter; Anchor booster; craftsman paint spray with gun; Astatic mike and press talk stand; '52 Chevy radio. John Pellock, 715 N. 7th, Benld, Ill.

**WANTED** — Viking VFO or equivalent of commercial vintage. Will trade 40/80 meter 40 w. CW xmitter with two power supplies, exc. cond., or cash. S. Dubov, 3100 Brighton 2nd St., Brooklyn, N. Y.

**FOR SALE** — 7" Emerson table-model 634 TV standard coil tuner, good power, \$15.95. Will ship anywhere. Jones Radio, 1115 Rambler Ave., Pottstown, Pa.

**FOR SALE** — Stromberg 10' TV perfect, \$35, matching base, \$15; Koenig 2 motor rotator for heavy ham or TV array 75' cable, complete, \$25; 78 rpm changer player, large mahog record cabinet, \$35. Will deliver 50 miles. Lester Porter, 220 E. Poplar, Danville, Ind.

**FOR SALE** — Unused 100TH's, \$10 per pair; Columbus Elect. VFO, NBFM modulator, good condition, self-contained power supply, \$25; 4,000 v. oil condensers. Jack Krasko, 122 Herriot St., Yonkers, N. Y.

**FOR SALE** — National NC-2-40-D, exc. cond. Used less than 50 hours. John Chester, 2912 E. 123rd St., Cleveland 20, Ohio.

**FOR SALE** — Mallory Vibropack dual vibrator and rect. tubes, 200 mills, 300 v., \$20; 100 w., 75 meter transmitter in carrying case, phone, CW, VFO and Crystal oscillator, complete, \$95. S. Casey, 33 Grove, Woodbridge, N. J.

**FOR SALE** — Sacrifice 5' scope, \$50; sweep gen., \$75; sig. gen. AM-FM, \$90; portable tube checker VOM, \$50; freq. meter, \$65; VTVM, \$25, 1,000 tubes, 50c each or best cash offer. Scott Radio Service, Benld, Ill.

**WANTED** — Supreme manuals No. 1 to 4. Have test equip. for sale or swap for comm. revr. HC-129X or equiv. T. Ferguson, 171 E. 91st St., N. Y.

**TRADE** — Argus C3 35 mm. camera for VTVM equal value, or will buy meter outright. Joseph Lishok, 683 Mountain Ave., Pomona, Calif.

**WANTED** — Code machines and keys. Jack Nelson, 915 Sherman St., Schenectady 3, N. Y.

**FOR SALE** — Harvey-Wells TBS-50C, 1. n., without power supply, with mike, \$85.95. R. Godwin, 3 Wellington Rd., Merrick, L. I., N. Y.

**FOR SALE** — Communications receiver National NC-173, exc. cond. Make offer. Includes NBFM adapter. Will deliver within 100 miles. C. Gabler, 1307 Merriam Ave., New York 52, N. Y.

**FOR SALE** — Feiler TS-3 sig. tracer, \$20; astatic 4-tube TV booster, \$12. Guide-17, Wolcott St., Malden, Mass.

**FOR SALE** — RT-700 Regency remote control unit in original carton (21 mc. if), \$38.50. Edward Tourath, R. 2, Algonquin, Ill.

**FOR SALE** — Mobile 10 meter rig, 30 w. xmitter-converter, PE103 converted for 500 v. or 250, output at 6 v. input, Master mount and antenna, Gonset noise limiter, autolite plugs and other suppression items. Complete, \$100. Albert L. Jeffrey, 1321 Brinton Rd., Pittsburgh 21, Pa.

**JOB OPEN** — General Electric, two-way radio representative, has opening for good mobile service man. Schneider Elec. and Equip. Co., 1106 Farnam St., Omaha, Neb.

*Sensationally  
New!*

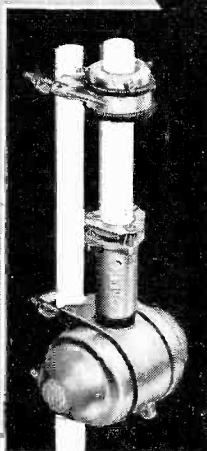
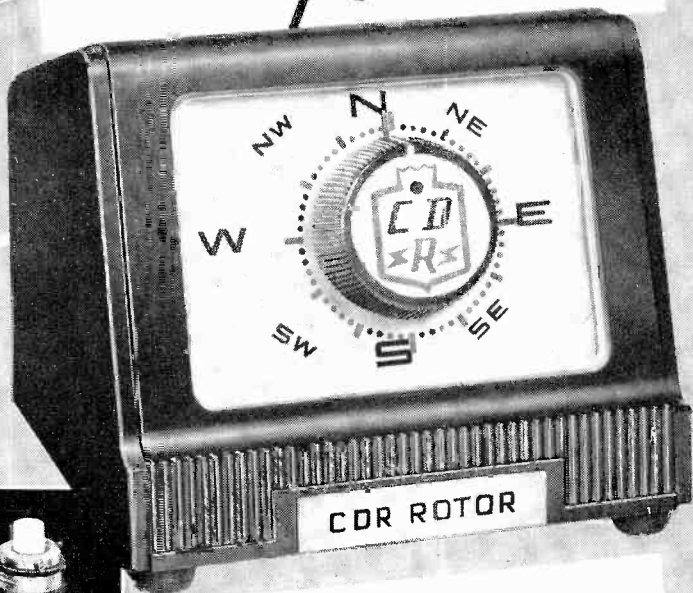

*Pre-Sold* to consumers in every leading TV market area with saturation TV spot announcements as well as newspaper advertisements. These further helps - animated point of sale display... newspaper mats... envelope enclosures... window streamers.

Models AR-1 and AR-2

# CDR ROTOR

*40% sharper tuning*  
than any other  
**AUTOMATIC ROTOR**

★ They said it couldn't be done — never thought it possible — but **HERE IT IS!** The AR-1 and AR-2 . . . the sharpest tuning **AUTOMATIC ROTORS** in the world. Superior construction and quality manufacture are featured in these as in the other **CDR ROTORS**, plus a handsome **NEW MODERN DESIGN CABINET** styled along lines for gracious, contemporary living and an added mechanical feature is a **MECHANICAL BRAKE THAT IS RELEASED MAGNETICALLY!** Here, truly, is the ultimate in rotors — handsome design, accurate, pinpoint, automatic performance easier to set and adjust — and **CDR dependability.**

## **Model AR-2**

*... complete, AUTOMATIC rotor with THRUST BEARING... and handsome modern design plastic cabinet, uses 4 wire cable...*

**47.95**

## **Model AR-1**

*... same as AR-2, without thrust bearing* **44.95**



**CORNELL-DUBILIER**

SOUTH PLAINFIELD, N. J.

Plants in South Plainfield, N. J.; New Bedford, Worcester and Cambridge, Mass.; Providence and Hope Valley, R. I.; Indianapolis, Ind.; Sanford and Fuquay Springs, N. C.; Venice, Calif.; and subsidiary, The Radiart Corporation, Cleveland, Ohio.

# C-D

and

# Faradon

**THE ONLY  
MICA  
TRANSMITTER  
CAPACITORS  
THAT EXCEED  
JAN SPEC'S**



**Cornell-Dubilier Electric Corp., So. Plainfield, N. J.**

*There are more C-D capacitors in use today than any other make*

See you- classified telephone directory for name  
and address of nearest C-D authorized distributor

ONSISTENTLY DEPENDABLE

# CORNELL-DUBILIER CAPACITORS



PLANTS IN S. PLAINFIELD, N. J.; NEW BEDFORD, WORCESTER AND CAMBRIDGE,  
MASS.; PROVIDENCE, R. I.; INDIANAPOLIS, IND.; SANFORD AND FRUQUAY  
SPRINGS, N. C.; AND SUBSIDIARY, THE RADIART CORP., CLEVELAND, OHIO