



# SPECIALIZED TELEVISION ENGINEERING

TELEVISION TECHNICAL ASSIGNMENT  
PHASE ANGLE, SINGLE AND POLYPHASE A-C SYSTEMS

Copyright 1950 by  
Capitol Radio Engineering Institute  
Washington, D. C.

717E

## PHASE ANGLE, SINGLE AND POLYPHASE A.C. SYSTEMS

### FOREWORD

The importance of phase relations of currents and voltages is seldom appreciated until it becomes necessary to make use of such relations practically—then it is essential to understand the effects thoroughly. There are very many practical applications in radio and television.

For example, on the mosaic in the iconoscope (picture tube) of a television camera, dark spots develop which cause the development of spurious voltages in the picture signal output; these in turn are transmitted and show up as dark spots or undesired shading in the received picture. This is corrected by developing voltages of opposite polarity, passing them through *phasing circuits* (usually combinations of fixed capacity and variable resistance), and then injecting them into the picture signal voltage. By means of simple variable resistor adjustments the *phase* of the injected (shading) voltage is regulated and the counteracting light spot moved over the face of the picture tube to cancel the dark spot which is inherent to iconoscope operation.

By means of combinations of L, C, and R, currents or voltages are *advanced* or *retarded* in relation to other currents or voltages. A thorough understanding of the meaning of *phase* and *phase angle* is essential in very many radio and electronic applications; such as, for example, the operation of automatic radio direction finders on aircraft and electronic control of welding periods. The basic principle underlying the Armstrong method of frequency modulation is an application of a *phase shifting* circuit. In some television applications "time delay" circuits are employed; one voltage pulse may be delayed by a predetermined time and then caused to "ride" on top of a wider pulse that was not so delayed.

Also, highly important to the radio engineer are polyphase systems. Because of increased efficiency in radio transmitters, and, for high-voltage power supplies, greater ease of ripple suppression, *three phase* power is used wherever it is available—except in the case of quite low power transmitters (usually under one kilowatt) where

*PHASE ANGLE, SINGLE AND POLYPHASE A.C. SYSTEMS*

power cost and cost of power supply components are not major factors.

While you may not realize it at this time, the subject matter of this technical assignment will be vitally important to an understanding of the material you will study in later assignments throughout the course. The proper concept of "phase" and "phase angle" is essential to the radio and television engineer.

E. H. Rietzke,  
President.

- TABLE OF CONTENTS -

PHASE ANGLE, SINGLE AND POLYPHASE A-C SYSTEMS

	Page
SCOPE OF ASSIGNMENT . . . . .	1
<i>OHM'S LAW FOR ALTERNATING CURRENTS</i> . . . . .	2
POLYPHASE A-C SYSTEMS . . . . .	7
<i>TIME DELAY</i> . . . . .	15

SCOPE OF ASSIGNMENT

It has been shown that the voltage and the current in an alternating current circuit are continuously rising, falling and reversing in direction during the sequence of a cycle. It is therefore apparent that if it is desired to compute the current or voltage at any particular instant, it is necessary to have some standard method of designating the instant. The standard designation is the 'Phase Angle'. The cycle of voltage or current is completed in 360 electrical degrees. The number of degrees from the starting point on the cycle to the designated instantaneous value is called the phase angle, and the phase angle during a cycle may be any number of degrees between zero and three hundred sixty. The symbol

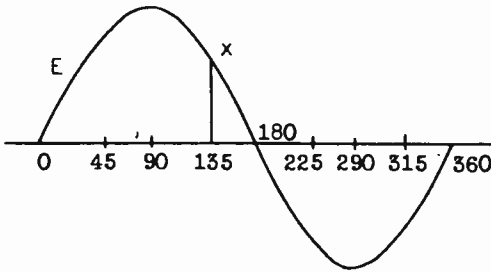

Fig. 1. — Sine curve used to show phase angle  $\phi$ .

for phase angle is the Greek letter Phi,  $\phi$ .  $\phi$  represents the actual number of ELECTRICAL DEGREES completed during a designated period. The designated period, in some calculations, may be more than one com-

plete cycle, but for most practical work is less than one cycle.

There are two general methods of showing the phase angle,  $\phi$ . One is by means of the sine curve. If a sine curve is plotted to scale, the horizontal line, (this axis), being plotted in degrees, any point may be selected along the sine curve and the phase angle determined by dropping a perpendicular from that point to intersect the horizontal line at right angles. The point of intersection will designate the phase angle of the voltage or current at the given instant. See Fig. 1.

In the diagram point 'x' has been selected. Dropping a perpendicular from point 'x' intersects the time axis at the 135° point. The phase angle of voltage at this instant is 135°.

Another method of graphically expressing a voltage or current at a given instant is by means of the vector diagram. See Fig. 2. In this diagram the voltage, E, has completed 135 electrical degrees.

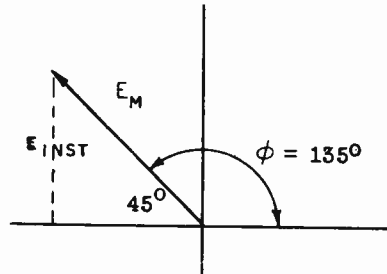

Fig. 2. — Vector diagram showing phase angle  $\phi$ .

The voltage is represented by the vector,  $E_m$ , rotating at a constant velocity in a counter-clockwise direction, starting at the horizontal axis to the right of the vertical bisector. In this case the instantaneous value of the voltage ( $E_{inst}$ ) will be equal to  $E_m (\sin 180^\circ - e)$  =  $E_m (\sin 180^\circ - 135^\circ)$  =  $E_m \sin 45^\circ$ .

The following symbols will be used to represent the terms commonly encountered in alternating current work in this and following assignments:

$E$  or  $e$  = Voltage

$E_m$  = Maximum Voltage

$E_{eff}$  or  $e_{rms}$  = Effective Voltage

$E_{ave}$  = Average Voltage

$E_{inst}$  = Instantaneous Voltage

$I$  or  $i$  = Current

$I_m$  = Maximum Current

$I_{eff}$  or  $I_{rms}$  = Effective Current

$I_{ave}$  = Average Current

$I_{inst}$  = Instantaneous Current

$R$  = Resistance

$L$  = Inductance

$C$  = Capacity

$P$  = Power

$W$  = Watts

P.F. = Power Factor

$\phi$  = Phase Angle

$\phi$  = Magnetic flux only when dealing in magnetic field calculations.

$\theta$  = Angle of Lead or Lag

$\pi$  = 3.1416  $2\pi$  = 6.28

$\sqrt{2}$  = 1.41  $\sqrt{3}$  = 1.73

$\omega$  =  $2\pi F$

$X$  = Reactance

$X_L$  = Inductive Reactance

$X_C$  = Capacity Reactance

$Z$  = Impedance

*OHM'S LAW FOR ALTERNATING CURRENTS.*—In an earlier assignment in which the relations between the direct current values of voltage, current, and resistance were discussed, it was shown that Ohm's Law held true in every case. Ohm's Law states that the current in any circuit varies directly as the voltage and inversely as the resistance of the circuit. Ohm's Law is primarily a direct current law. But it also applies to alternating current circuits WHEN THE CIRCUIT CONTAINS RESISTANCE ONLY.

Theoretically no circuit is composed entirely of resistance; there is always some inductance and capacity present. But if the effects of the inductance and capacity of the circuit are so small as to be negligible when compared to the effects of the resistance, the circuit may be considered, for practical purposes, as being a simple resistance circuit. This is true in a radio frequency circuit when tuned exactly to resonance. The effect of the capacity exactly counteracts the

effect of the inductance and the circuit at resonance acts as a purely resistance circuit. Such a circuit is often not tuned to EXACT resonance but ordinarily it is operated so near to resonance that the effects of the L and C of the circuit may be neglected.

Thus in a purely resistance circuit Ohm's Law may be considered as being correct even at radio frequencies. This means that in a circuit containing a given amount of resistance the current will vary directly as the voltage, and at any instant the amplitude of the current will be equal to the voltage *at that instant* divided by the circuit resistance:

$$I_{inst} = \frac{E_{inst}}{R}$$

Under this condition, when the voltage is zero the current will also be zero, when the voltage is at a maximum value the current will also be maximum, etc. When the voltage and current rise and fall simultaneously they are said to be IN PHASE. The 'in phase' current neither leads nor lags the voltage. This condition can exist in an alternating current circuit ONLY WHEN THE CIRCUIT CONTAINS NOTHING BUT RESISTANCE. (It should be remarked at this point that the effective resistance of a radio frequency circuit is a considerably different thing than the direct current resistance of the component parts of the circuit. This fact will be discussed in detail in later assignments).

Under certain conditions in an alternating current circuit the current and voltage do NOT rise and fall simultaneously. If the cir-

cuit is an inductive circuit, that is, if the effects of the inductance are not balanced out by an equal capacity effect, the current will rise and fall at a certain time interval LATER than the corresponding change in voltage. In that case the current is said to *lag* the voltage and is called a *lagging current*. If the circuit has a preponderance of capacity effect, the current will rise and fall AHEAD of the voltage and is said to *lead* the voltage. This is called a *leading current*. The theory and reasons for these phenomena will be discussed in detail in following assignments.

The lead or lag of the current with respect to the voltage is expressed in degrees and is called the ANGLE OF LEAD or ANGLE OF LAG, depending on the circuit conditions. This angle may be any angle between zero and ninety degrees inclusive but can NEVER exceed ninety degrees. The symbol for the angle of lead or lag is the Greek letter Theta,  $\theta$ .

The angle,  $\theta$ , may be shown graphically in two ways, first by means of sine curves, and second, by vector diagram.

The first method, sine curves, is shown in Figs. 3(A) and 3(B). In 3(A) the current, I, is shown leading the voltage. It should be very thoroughly understood that a point further to the right along the sine curve represents a later time than some point to the left. Thus the current has reached its maximum value ahead of the voltage maximum. The current is then ahead of the voltage and LEADS the voltage. In this case the lead is  $45^\circ$ , that is, I reaches maximum forty-five degrees, (electrical), ahead of E.

In 3(B) the reverse is true. Here I starts out from zero at a

time when E has already completed 45° of its cycle. In this case the current is said to lag the voltage by 45°.

The conditions as shown on the sine curves in Fig. 3, may also be shown by vectors, as in Figs. 4(A) and 4(B).

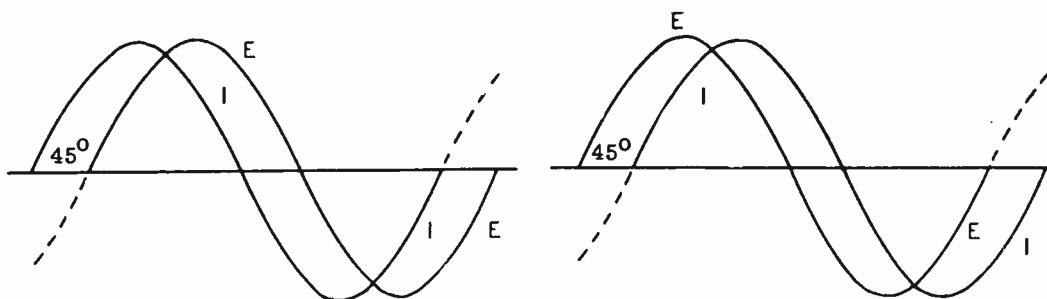

(A)

(B)

Fig. 3 (A) & (B).—Showing  $\theta$  as the angle of lead (A) & (B) on sine curves.

In 3(A) the condition will be expressed by the equation,

$$\theta = 45^\circ \text{ Lead}$$

In 3(B) the equation will become,  $\theta = 45^\circ$  Lag. The symbol,  $\theta$ , is used for either an angle of lead or an angle of lag, and when stating this angle, the condition of lead or lag must be indicated.

In 4(A), I has completed 135° of its electrical cycle. E has completed only 90° of its cycle. The current leads the voltage by the difference, or by 45°. This is shown by  $\theta = 45^\circ$  lead.

In 4(B), I has completed only 45° of its cycle while E has completed 90 electrical degrees. I then may be said to lag behind E by the difference between the two phase

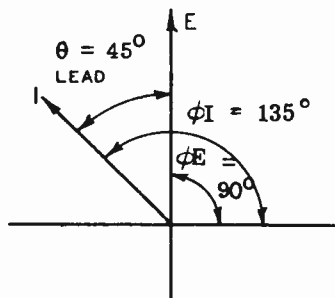

(A)

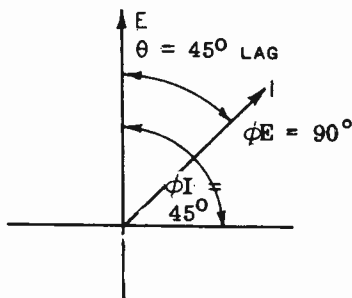

(B)

Fig. 4 (A) & (B).—Vectors showing  $\theta$  as the angles of lead (A) and Lag (B).



angles. This is shown by the equation,

$$\theta = 45^\circ \text{ Lag}$$

For most purposes  $\theta$  may be computed as the difference between the phase angles of voltage and current. For an angle of lead this will be  $\theta = \phi I - \phi E$ . For an angle of lag the second expression is reversed and becomes  $\theta = \phi E - \phi I$ .

This for general purposes is true, but in some special cases the procedure must be slightly changed. See Fig. 5. In this case  $\phi E = 20^\circ$

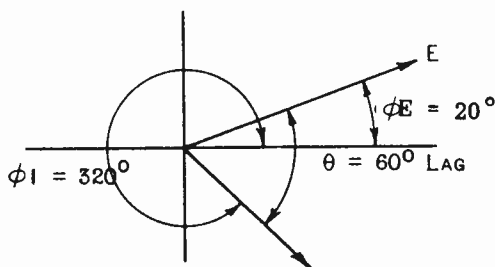

Fig. 5.—Showing angle  $\theta$  where E and I are on opposite sides of the reference line for  $\phi$ .

and  $\phi I = 320^\circ$ . The diagram shows that E is starting its cycle while I has almost completed its cycle. (All directions of motion are counter-clockwise.) The simple difference between these angles would be  $320^\circ - 20^\circ = 300^\circ$ . But it has been stated that  $\theta$  can never exceed  $90^\circ$ . Therefore, I can NOT be leading by  $300^\circ$ .

It must therefore be completing its cycle LATER than E which has started a new cycle. The angle then is an angle of lag and is the angle shown in the diagram as  $\theta$ . This angle is computed by subtracting  $\phi I$

from  $360^\circ$  and adding the difference to  $\phi E$ . The equation then becomes  $\theta = \phi E + (360^\circ - I)$ , or  $\theta = 20^\circ + (360^\circ - 320^\circ) = 20 + 40^\circ = 60^\circ$  lag.

This condition can occur only when one vector, E or I, has just started a new cycle and the other vector has not quite completed its cycle.

On the vector diagram all angles are measured from the horizontal axis to the right of the bisector and in a counter-clockwise direction.

Very often, in the derivation of formulas, in technical articles, etc., it is desired to express the phase angle in terms of time and frequency rather than in degrees. In that case the angular unit is the 'Radian'. In geometry the circumference of a circle is defined as  $2\pi r$ ,  $r$  being the radius of the circle and  $\pi$  being equal to 3.1416. (This subject has been discussed in an earlier mathematical assignment but it is believed that a brief review at this point will be helpful).

In vector notation one electrical cycle is illustrated by a complete revolution of a vector, the length of the vector representing the maximum value of current or voltage. This vector length thus becomes the radius of the circle formed by the vector extremity during one complete revolution.

Since the circumference of the circle is equal to  $2\pi r$ , then the distance  $r$  as measured along the circumference will be completed in  $1/2\pi$  revolution, and in one revolution this distance will be completed  $2\pi$  times. In the same revolution the vector will rotate through 360 degrees, therefore the angle completed by the vector as its ex-

tricity travels through the distance  $r$  will be equal to  $360/2\pi$  degrees, this angle being called one 'Radian'. One radian is equal to 57.3 degrees.

Since one electrical cycle, as vectorally represented by the circle, consists of one complete revolution, then one cycle may be expressed in terms of radians, as 1 cycle =  $2\pi$  radians. The cycle is commonly associated with time in terms of frequency,  $f$ .  $f$  = cycles per second. Since one cycle equals  $2\pi$  radians, the number of radians per second is a function of the frequency. Radians per second =  $2\pi f$ .

$2\pi f$  is usually expressed as  $\omega$ . Therefore the time of one radian, in seconds, being a function of  $f$ , is equal to  $1/\omega$  seconds.

It has been shown that in dealing with relations between current and voltage it is often necessary to consider the actual time elapsed between two sets of conditions; for example, the time elapsing between the maximum values of current and voltage in a circuit, expressed in terms of angular measure as the angle of lead or lag; the phase difference between two voltages impressed across a circuit, etc. Having the relation,

$$T_{(\text{one radian})} = \frac{1}{\omega} \text{ seconds}$$

The angle in radians for a given

$$E = \sqrt{(E_1 \cos \omega t + E_2 \cos \omega t)^2 + (E_1 \sin \omega t + E_2 \sin \omega t)^2}$$

condition may be expressed in terms of time in seconds as,

$$\text{angle in radians} = \omega t (\text{seconds})$$

At a frequency of 60 cycles per second, if two voltages across a circuit are displaced by .001

second, the angle in radians between the voltages will be,

$$\text{Angle (radians)} = \omega t$$

$$\text{Angle (radians)} = 2\pi f t$$

$$= 6.28 \times 60 \times .001$$

$$= .3768 \text{ radian}$$

$$\text{Angle (degrees)}$$

$$= .3768 \times 57.3 = 21.59^\circ$$

By expressing the angle in terms of radians as being equal to  $\omega t$ , the angular relations between any number of voltages or currents at any number of frequencies can be expressed in the form of equations. In the practical use of these equations it simply becomes necessary to evaluate with the proper values of  $f$  and  $t$ . Of course the above equation can be easily rearranged:

$$\text{Radians} = \omega t$$

$$t = \frac{\text{Radians}}{\omega}$$

$$f = \frac{\text{Radians}}{2\pi t}$$

A commonly encountered equation is,

or other equations in similar form. In this case  $\cos \omega t$  simply represents  $\cos \phi$ , and  $\sin \omega t$  represents  $\sin \phi$ ; however, in the equation  $\omega t$  expresses the angle in radians. In the practical problem these angles will be transferred into vector degrees to the nearest horizontal

axis. The above form is very convenient because it permits the equations to be written in terms of time and frequency. This permits the analyzing of conditions existing in a circuit at any definite time when voltages of more than one frequency, or displaced by more than one cycle, are to be studied.

A practical example of such a condition is encountered in calculations of field intensities in directional antenna arrays. Two antennas may be spaced by some desired distance and fed by transmission lines and phasing circuits with some desired phase difference. Calculations may then be made to determine the combined field intensity at given points in space, which may be more or less than one wavelength distant. Such conditions will be discussed in detail in later assignments dealing specifically with radiated energy.

When a general equation is desired to represent any set of conditions which may be encountered, the phase angle is usually expressed in terms of  $\omega t$ . When desired this angle can always be evaluated in terms of degrees.

### POLYPHASE A-C SYSTEMS

In electrical power work alternators which deliver power simultaneously from more than one set of windings are commonly employed, and power devices are designed to receive power simultaneously from more than one set of alternator windings. The advantage of such a system—called a polyphase system—is a more smooth flow of power into the operating device. In any single phase system the power supplied

varies between a maximum value and zero, so that at certain instants during every cycle no power is received from the line and it is necessary for the operating device to store sufficient power during the peaks to carry it over the zero power instants. In ordinary electrical power work the operating device is usually a motor. In radio the device may be either a motor or a high voltage rectifier. In the case of the high voltage rectifier supplying d.c., <sup>filters</sup> are necessary to store sufficient power to smooth out the voltage fluctuations across the load. Where the rectifier is designed for a polyphase power input, the output filter constants may be considerably reduced because the voltage never drops to zero and the power that must be stored is correspondingly reduced over that required in a single phase system. For that reason, except in the case of quite low power devices, polyphase power supplies are used whenever possible.

An alternator may have two complete sets of windings displaced from each other by  $90^\circ$ . Such a machine is called a two phase alternator. Since the windings are displaced  $90$  electrical degrees, the power outputs delivered to two circuits are likewise displaced by  $90^\circ$ . Such an output may be carried over three wires, one wire being common to both circuits. That is not considered good practice, however, because of the change of unbalanced voltage and load regulation, particularly with inductive loads, which render it objectionable. A four wire transmission line is to be preferred even at the cost of the additional wire. (It must be remembered that the power supplied by

a powerhouse is ordinarily distributed over a large number of circuits and devices, some of which may be designed for polyphase operation and some, such as lights, which are operated single phase across only one pair of wires).

A more commonly used polyphase is the three phase system. A three phase alternator has three complete sets of armature windings, these being so spaced around the stator that as the rotor poles pass under the windings the voltages generated in the three sets of windings are displaced by 120 electrical degrees. This phase displacement is shown in the sine curves of Fig. 6 and in the vectors of Fig. 7. The arrangement

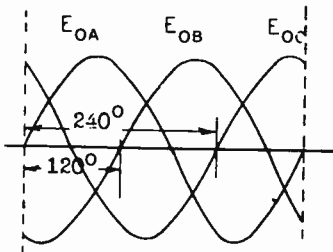

Fig. 6.—Three phase displacement shown by sine curves.

of the armature windings is shown schematically in Fig. 8. If the windings of Fig. 8 are rotated  $360^\circ$  past two opposite magnetic poles, or if north and south magnetic poles are rotated completely past the three windings, the three voltage cycles as shown in Fig. 6 will be produced. This is equivalent to rotating the vectors of Fig. 7  $360^\circ$ .

Since the armature windings are displaced 120 electrical degrees, the voltages generated across the

windings will also be displaced by  $120^\circ$  from each other.

Three possible connections to the load may be used: first, a four wire circuit in which the fourth wire connects to point o. With this circuit it is possible to use the

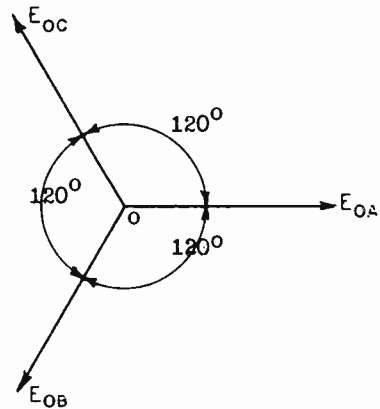

Fig. 7.—Three phase displacement shown by vectors.

voltage developed across a single winding. The four wire connection is rarely used. One commonly used connection is the Y connection as shown in Fig. 8. The other is the

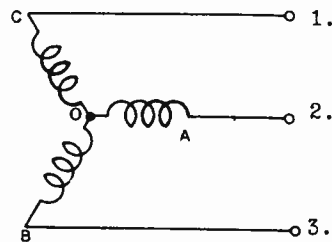

Fig. 8.—Three phase arrangement of windings in an armature—Y connection.

Delta connection as shown in Fig. 9.

Before considering the circuit connections and voltage vectors, the system of vector notation to be used should be briefly stated. In Figs. 6 and 7, the general voltage notations  $E_{o_a}$ ,  $E_{o_b}$ , and  $E_{o_c}$  are used to

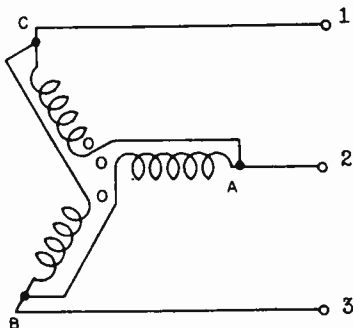

Fig. 9.—Delta connection of windings.

indicate the three winding voltages. These may be traced individually over their sine curves, and shown simultaneously by sine curves or by vectors displaced  $120^\circ$  apart. However, in combining these voltages mathematically, the general terminology will not be correct. For example, in considering the combined voltage across windings oa and oc (Fig. 8),  $E$  does not equal the vector sum  $E_{o_a} + E_{o_c}$ , but rather the vector difference  $E_{o_a} - E_{o_c}$ . This is true because in designating the voltages  $E_{o_a}$  and  $E_{o_c}$ , one means the voltage drops from o to a and from o to c. In considering the total voltage across the two windings from a to c, the sequence would be a to o to c or c to o to a. Thus the combined voltage could be expressed as the vector difference  $E_{o_a} - E_{o_c}$ , or the vector sum  $E_{o_a} = E_{c_o}$ , or the vector sum  $E_{a_o} + E_{o_c}$ .

The vector  $E_{a_o}$  is displaced  $180^\circ$  from the vector  $E_{o_a}$ ; the vector  $E_{c_o}$  is displaced  $180^\circ$  from the vector  $E_{o_c}$ ; and the vector  $E_{b_o}$  is displaced  $180^\circ$  from the vector  $E_{o_b}$ . This will be clearly shown in the following discussion.

First consider the  $\Delta$  connection of Fig. 8, the voltage vector of which is shown in Fig. 7. It is seen that the vector sum of all the voltages is equal to zero. This is also shown on the sine curves. At the instant  $E_{o_a}$  is equal to zero  $E_{o_b}$  and  $E_{o_c}$  have quite high values but they are *equal* in amplitude and of *opposite* polarity, their algebraic sum therefore equalling zero. At all points along the time axis the algebraic sum of  $E_{o_a} + E_{o_b} + E_{o_c} = 0$ .

By ordinary vector addition as previously studied, the sum of  $E_{o_a}$  and  $E_{o_c}$  would be found by completing a parallelogram and then drawing in the diagonal to point o. This is shown in Fig. 10 and is *incorrect in this case*, both in the amplitude and direction of the resultant for the reason as explained above. This can be shown very clearly by reference to Fig. 11.

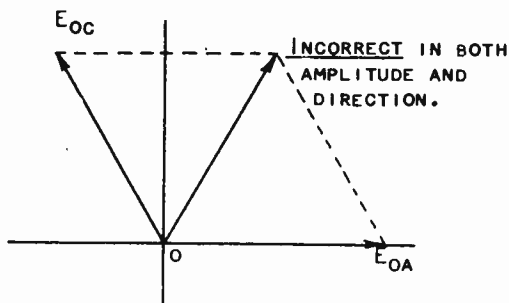

Fig. 10.—Incorrect method of adding vectors.

Consider load R across lines 1 and 2. According to Kirchoff's Law the sum of all the voltages around a circuit must equal zero. It is obvious that the voltage across R must equal the vector sum of the voltages

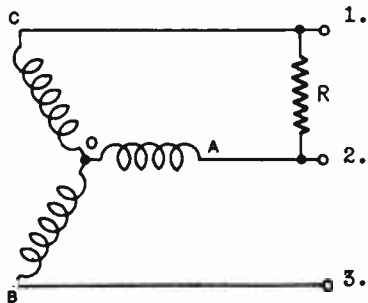

Fig. 11.—Analysis of three phase circuit with load R.

generated by the two windings oa and oc. However, this is *not* the vector sum of  $E_{oa} + E_{oc}$ . Starting at point 2, proceeding in a counter-clockwise direction, and assuming that the voltage drop across the connecting wires is negligible, the voltages are:  $E_{2-1}$ ,  $E_{c-o}$ ,  $E_{o-a}$ . Assigning a negative sign to the voltage across the load, (see assignment on Kirchoff's Law calculations), and a positive sign to the generated voltages,

$$E_r = \text{vector sum } E_{co} + E_{oa}$$

$E_{co} + E_{oa}$  is a vastly different matter than  $E_{oc} + E_{oa}$ . The voltage  $E_{co}$  is just the opposite to  $E_{oc}$ , therefore,  $E_{co} = E_{oc}$ , and  $E_{co}$  is displaced  $180^\circ$  from  $E_{oc}$ . This is shown on the vector in Fig. 12. Thus  $E_r = \text{vector sum } (E_{oa} + E_{co})$ .

The solution of the triangle (o,  $(E_{oa} + E_{co})$ ,  $E_{oa}$ , o) is handled very easily by simple trigonometry

as shown in Fig. 13. In this triangle, with reference to Fig. 12,  $oa = E_{oa}$ ,  $ob = E_r$ , and  $ab = oa = E_{co}$ .  $\theta = \theta_1 = 30^\circ$ . Triangle oaco = triangle bacb; also, ac, the perpendi-

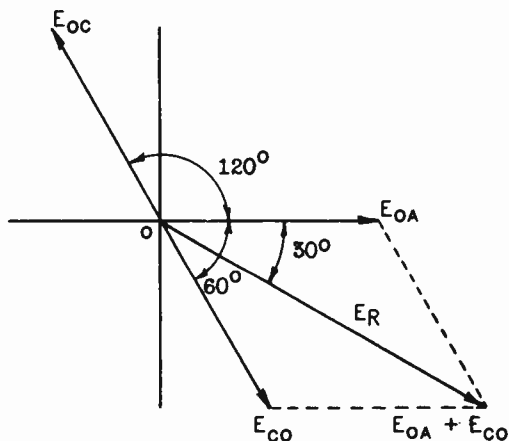

Fig. 12.—Correct method of solving a three phase circuit.

cular to ob, bisects ob so that  $oc = cb$ . Then  $ob = 2(oc)$ . In triangle oaco, since it is a right angle,

$$oc = oa \cos 30^\circ$$

$$ob = oa(2 \cos 30^\circ)$$

$$\cos 30^\circ = .866$$

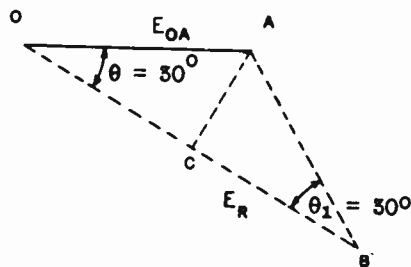

$$oc = oa \cos 30^\circ$$

Fig. 13.—Solving for OB by trigonometry.

$$2 \cos 30^\circ = 1.732$$

$$1.732 = \sqrt{3}$$

Thus  $ob = oa \sqrt{3}$ ,  $ob = E$  and  $oa = E_{oa}$ . Then  $E_r = \sqrt{3} E_{oa}$ .  $E_{oa}$  is the voltage across one winding of the Y connected armature and  $E_r$  is the voltage across the load  $r$  which is connected across two armature windings in series, that is, across the two line terminals 1 and 2. By the same reasoning it may be shown that:

$$E_{ca} = \sqrt{3} E_{oa} = \sqrt{3} E_{co}$$

$$E_{cb} = \sqrt{3} E_{ob} = \sqrt{3} E_{co}$$

$$E_{ba} = \sqrt{3} E_{oa} = \sqrt{3} E_{co}$$

$$E_{ca} = E_{cb} = E_{ba}$$

Thus in a Y connected generator the voltage across any pair of line wires is equal to  $\sqrt{3}$  time the voltage of 1 armature winding. Conversely, the voltage generated in any one armature winding is the voltage between any pair of line wires divided by 1.732.

$$(E_w = E_L / 1.732 = .577 E_{line})$$

Since the line wires and the respective armature windings are connected in series, the current in any one armature winding is equal to the current in the respective line wire. The line voltage  $E_L$  lags the winding voltage  $E_{oa}$  by  $30^\circ$  and leads the voltage  $E_{co}$  by  $30^\circ$ . With unity power factor—that is, when the generator winding current and voltage are in phase—line and winding are in series and the line current equals the winding current; the line current and voltage are in phase with one another for a resistance

load and both are out of phase by  $30^\circ$  with the winding voltage.

A balanced load circuit is shown in Fig. 14 where the loads across each pair of line wires are equal.

When  $R_1 = R_2 = R_3$  the amounts of power transferred over all three pairs wires are equal and the currents in the three wires are equal. The line current equals the armature current and equal power is delivered

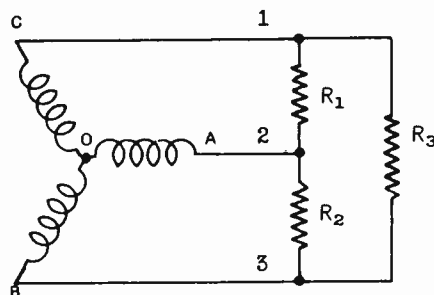

Fig. 14.—A balanced load circuit for a three phase system.

by all three armature windings. The power delivered by each winding is,

$$P_1 = EI(PF)$$

(where PF = power factor of the load =  $P/EI$  where  $f$  is the true power as indicated by a wattmeter.  $E$  and  $I$  are winding voltage and current respectively).

And total power delivered by all three windings, is,

$$P = 3 EI(PF)$$

but  $E = E_{line} / 1.73$

so that

$$P = \frac{E_{line} \cdot I_{line} (PF)}{1.73}$$

$$(3/1.73 = 1.73)$$

and

$$P = 1.73 E_{line} I_{line} (PF)$$

$$(I_{line} = I_{winding})$$

The Delta connected armature is shown in Fig. 9. It is shown in slightly different form in Fig. 15, but by tracing through the circuit from point to point it will be seen that the two connections are identical. In Fig. 15, winding ca is the equivalent of co in Fig. 9,

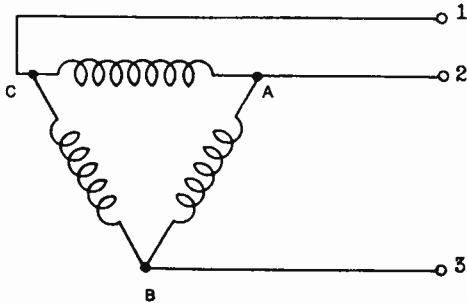

Fig. 15.—An equivalent circuit of Fig. 9.

ab in 15 is ao in 9, and bc in 15 is bo in 9. On first examining the Delta connection it would seem that a large circulating current should flow around the series connected windings. However, it will be remembered that the sum of all the voltages of the three armature windings is equal to zero at every instant. Since the three windings are in series, and since the sum of the series voltages is zero, there is no

voltage to cause a flow of circulating current around the windings.

From Fig. 15 it is seen that the voltage across the line is equal to the voltage across one winding. Thus line voltage 1-2 = armature voltage ca; line voltage 2-3 = armature voltage ab; line voltage 1-3 = armature voltage cb.

The current in each line wire is the vector sum of the currents in the two windings to which the line is connected. Thus the current in line wire 1 is vector sum ( $I_{ac} + I_{bc}$ ); in wire 2, line current is vector sum ( $I_{ca} + I_{ba}$ ); in wire 3, line current is vector sum ( $I_{ab} + I_{cb}$ ). For a system operating at unity power factor in which  $I_{ab}$  is in phase with  $E_{ab}$  etc., the vector of Fig. 16 will show the current

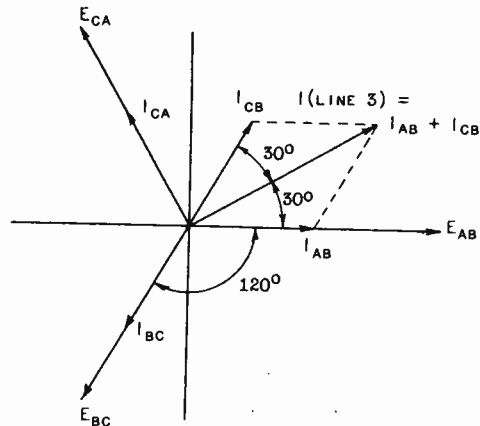

Fig. 16.—Current relations in a three phase delta connected circuit.

relations. The current in one line is calculated as shown. The procedure is similar to that used in calculating the line voltage in a Y connected armature. The currents



flowing into line 3 are  $I_{ab}$  and  $I_{cb}$ .  $I_{cb} = -I_{bc}$  so that  $I_{cb}$  is 180 out of phase or opposite to  $I_{bc}$ . It is so projected on the vector. The current in line 3 leads the voltage  $E_{ab}$  by  $30^\circ$  and

$$I_{line\ 3} = 1.73 I_{ab}$$

The calculation for the vector sum of  $I_{ab} = I_{cb}$  is exactly as shown in the triangle of Fig. 13. If the load is such that the system is balanced, all three line currents will be equal, the current in each line is equal to 1.73 times the current in each armature winding, the line voltage is equal to the voltage of a single armature winding, and total power  $P = 1.73 \cdot E_{line} I_{line} \cdot (PF)$  just as in a Y connected system.

In making calculations of E, I and P, the effective or r.m.s. values as indicated by meters in

the circuit are ordinarily used, just as in single phase calculations.

The connections and calculations shown for Y and Delta systems apply equally to alternators which generate power and to transformers by which power is converted into the desired current and voltage relation for use in the operating device—for example, a high voltage rectifier. Fig. 17 shows four possible three phase transformer connections: No. 1, both primary and secondary Delta connected; No. 2, both primary and secondary Y connected, No. 3, primary Delta connected, secondary Y connected; No. 4, primary Y connected, secondary Delta connected.

When three phase generator or transformer windings are Y connected the center point is sometimes grounded. This is called the neu-

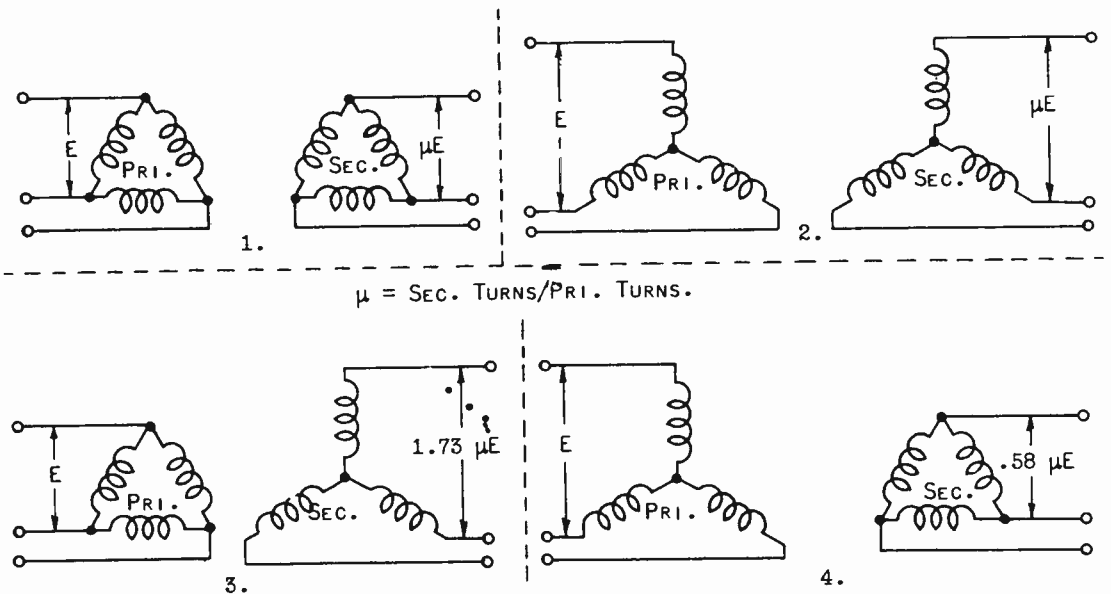

Fig. 17.—Four possible three phase transformer connections.

tral point of the circuit. If both the generator and the load have the neutral point grounded, and if the load is balanced, there should be no flow of current in the ground wire.

Where the alternator is to deliver high voltage, or where the transformer winding is to operate at high voltage, the Y connection is usually employed. Using the Y connection with the neutral point grounded, the actual peak voltage across any winding is only .58 of the peak voltage between line wires and the problem of insulation is greatly simplified. (Voltage across armature winding is equal to line voltage/1.73 = .58 line voltage). In the case of a high voltage three phase alternator, in order to generate a given voltage per phase, (between each pair of line wires), the voltage per phase winding of the armature need only be .58 of the required voltage between line wires.

Most high voltage rectifiers built to supply high d-c plate voltage for radio transmitters are designed for a three phase power supply. In such a rectifier the high voltage transformer is often connected as follows: the primary is Delta connected to the low voltage power supply and the high volt-

age secondary is Y connected to the tube circuits. (Connection 3, Fig. 17).

The following table lists the voltage relations between transformer primary and secondary for the four possible combinations as shown in Fig. 17. In this table  $\mu$  = the voltage step-up factor which is practically a direct function of the ratio of the number of secondary turns to the number of primary turns for each set of windings.

It will be seen that when primary and secondary are both Delta or both Y connected, the secondary voltage will equal  $E$  (the primary voltage) times the secondary/primary turns ratio. As a practical example, assume that a three phase transformer is built with 120 turns in each primary winding and 6,000 turns in each secondary winding. The primary is to be connected across a 220 volt power line.

The turns' ratio is  $6,000/120 = 50 : 1$ . Therefore  $\mu = 50$ . If both primary and secondary are Y connected or Delta connected, as in connections 1 and 2, Fig. 17, the voltage between each pair of wires in the secondary load circuit will be  $\mu E = 50 \times 220 = 11,000$  volts. If the circuit of connection 3, Fig. 17, is used—primary Delta, second-

TABLE I

	Connection		Volts Between Lines	
	Primary	Secondary	Primary	Secondary
1.	Delta	Delta	$E$	$\mu E$
2.	Y	Y	$E$	$\mu E$
3.	Delta	Y	$E$	$1.73 \mu E$
4.	Y	Delta	$E$	$.58 \mu E$

ary Y—the voltage across each pair of secondary load wires will be  $1.73 \mu E = 1.73 \times 50 \times 220 = 19,030$  volts. If the circuit of connection 4 is used, the secondary voltage will be  $.58 \mu E = .58 \times 50 \times 220 = 6,380$  volts.

The advantage of connection 3 for high voltage operation is quite apparent. In the first place, with the given transformer a much higher secondary voltage may be obtained for a given primary voltage. Second, the center point of the secondary winding may be grounded thus reducing the voltage between any wire and ground without reducing the voltage between wires. Third, if a voltage of only 11,000 or 12,000 volts is required, the primary may be operated at lower voltage, or, as would more often be the case, the transformer could be designed with a lower turns ratio and still deliver the same voltage that could be obtained with either connection 1 or connection 2 with the same primary voltage. Thus in high voltage rectifiers used in radio transmitting installations connection 3 is very commonly employed.

A three phase transformer installation may consist of three separate single phase transformers, one for each phase, with the windings of the three transformers connected as in any one of the four arrangements of Fig. 17; or a single transformer, in which are incorporated all the windings, may be used. The single transformer allows a considerable saving of cost in a large installation. However, if uninterrupted service is so essential that a spare *must* be available, such an installation will require two complete three phase transformers. If separate transformers are used, it

is only necessary that one single phase transformer be provided for emergency service, as the spare transformer can be quickly substituted for any one of the three transformers which may become defective on a single phase. In many of the larger broadcast transmitter installations the use of separate transformers for each phase has been found more satisfactory.

Actual rectifier circuits employing three phase power supplies will be discussed in detail in later assignments.

*TIME DELAY.*—It has been shown how phase angle may be converted into equivalent time elapsed in the cycle. Thus,

$$\text{Angle (Radians)} = \omega t = 2\pi f t$$

or

$$T = \frac{\text{Angle (Radians)}}{\omega} = \frac{\text{Angle (Radians)}}{2\pi f}$$

If the phase angle is expressed in degrees, then since  $57.3^\circ = 1$  radian, the time is given by

$$T = \frac{\text{Angle (Degrees)}}{57.3} = \frac{\text{Angle (Degrees)}}{(57.3)(2\pi f)}$$

Suppose one is considering a current and a voltage, and that the current lags the voltage by some angle  $\theta_L$ , as shown in Fig. 18(A) in wave form, and in 18(B) in vector form. (The constant angle of lag  $\theta$  implies that the current and voltage are of the same frequency). The angle of lag indicates that the current is always behind the voltage in timing; it reaches its zero, maximum, and all intermediate values

later in *time* than does the voltage. The time difference, or *delay*, can be calculated by the above formula;

ray work is as follows. Most waves encountered in communications work, such as audio (speech) or video

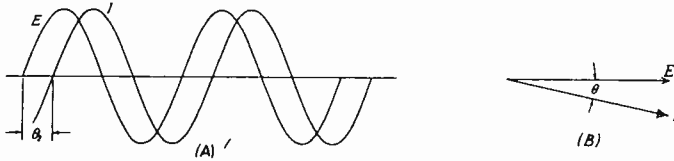

Fig. 18.—The wave and vector form of the current lagging the voltage.

it is simply

$$T_d = \frac{\theta_L \text{ (Radians)}}{2\pi f} = \frac{\theta_L \text{ (Degrees)}}{(57.3) (2\pi f)}$$

As a numerical example, suppose  $\theta_L = 35^\circ$ , and  $f = 100$  c.p.s. Then,

$$T_d = \frac{35}{(57.3) (2\pi 100)} = .000972 \text{ sec.}$$

or 0.972 milli-seconds, as it is more conveniently expressed.

Suppose, however, that the frequency had been 200 c.p.s. Then  $T_d$  would have been half the previous value, or 0.486 milli-sec. In order for the time delay to be the same at 200 c.p.s., *the angle of lag would have to be doubled, or  $70^\circ$ .* This can also be seen more generally from the formula for  $T_d$ : since  $\theta_L$  is in the numerator, and  $f$  is in the denominator, the fraction is unchanged if both increase or decrease by the same percentage. From this the following important rule can be stated:

*The time delay of a circuit is constant if the phase shift is proportional to the frequency.*

The significance of this rule in television, facsimile, and cathode

(television) are far from sinusoidal in shape. In many cases, however, they do have one property in common with sine waves, namely—they repeat the same values over and over again; i.e., they are repetitive, cyclic, or periodic in nature. A common example in television is the square wave, shown in Fig. 19. This is square rather than sinusoidal in

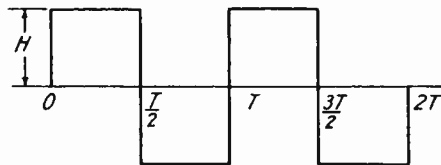

Fig. 19.—A square wave of voltage that appears quite often in television.

shape, but it does repeat its square form over and over again indefinitely at intervals of  $T$  seconds. Thus the first positive alternation shown occupies the time  $T/2$ ; the first complete cycle occupies the time  $T$ , and so on.

As will be seen in subsequent

assignments, the behavior of a circuit to a sinusoidally impressed voltage can be expressed in relatively simple mathematical terms. Such, unfortunately, is not the case for nonsinusoidal or complex voltages, even if they are periodic.

Fortunately, however, a French mathematician by the name of Fourier, discovered that nonsinusoidal, but periodic, waves can be represented by a special set of sine waves, integrally related to one another in frequency. The sinusoidal current flow for each sine-wave component of a complex impressed voltage can be readily formulated; the total current is the sum of these sine-wave current components and represents the effect of the total complex impressed voltage.

To make this clearer, consider once more the square wave shown in Fig. 19. It can be shown by means of the integral calculus that this wave corresponds or is composed of an infinite number of sine-wave components of different frequencies. The sinusoidal component of lowest frequency is called the *fundamental* or first harmonic; it has the same repetition rate as the complex wave

itself. The next component that occurs in the case of the square wave is one of three times the frequency; it is called the *third harmonic*. Following this, there is the fifth harmonic in the case of this particular wave, then the seventh harmonic, the ninth; in short, all harmonics that are odd multiples of the fundamental frequency.

The square wave is therefore found to have only *odd* harmonics. Other wave shapes may contain even harmonics as well. Each wave shape depends, however, not only on the number of harmonics present, but also upon their amplitudes and relative timing (moment at which they cross the time axis).

The first three components are shown in Fig. 20, as well as the square wave (in dotted lines). The square wave has an amplitude of  $H$  units. Its fundamental component has a greater amplitude than this, namely  $\frac{4H}{\pi}$  units. The third harmonic has an amplitude one-third that of the fundamental, or  $\frac{4H}{3\pi}$  units; the fifth harmonic an amplitude one-fifth of the fundamental, or  $\frac{4H}{5\pi}$  units, and so on. The harmonics for the square wave are said to have amplitudes that vary *inversely* as the harmonic order.

The next point to note is that for this particular wave shape the harmonics all pass through zero (intersect the time axis) in a positive direction at the same point, such as 0 in Fig. 20. For some other wave shape the crossings may be related in a totally different manner, but in any case the alignment of the waves is just as important as the relative amplitudes in determining the wave shape. This will be appreciated from the following discussion.

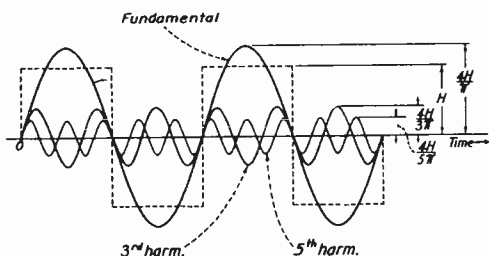

Fig. 20.—Analysis of a square wave which is composed of an infinite number of odd harmonics.

The manner in which the harmonics combine to form the square wave is illustrated in Fig. 21. In (A) the instantaneous values of the fundamental and third harmonic are

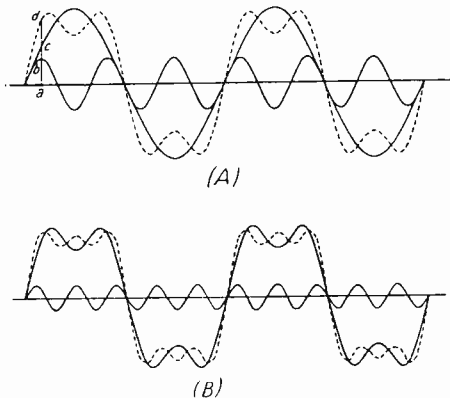

Fig. 21.—Adding odd harmonic to a fundamental and approaching a square wave.

added together to give a resultant wave shape shown in dotted lines. For example, at instant *a* the fundamental has the amplitude *ac*, and the third harmonic has the amplitude *ab*. The sum of *ac* and *ab* is *ad*; this is the instantaneous amplitude of the resultant wave.

The latter, it will be observed, is steeper along the sides and flatter on top; the sum of the first two components is beginning to approach a square wave in shape. In (B) Fig. 21, the fifth harmonic is added to the resultant of (A), and gives rise to the second resultant shown in dotted lines in (B).

Observe that this new resultant is even closer to a square wave in shape, and has many more ripples

on its top, but of smaller amplitude. As more and more harmonics are added, the sides approach the perpendicular; the top, a horizontal position, and the ripples on the top become smaller and smaller as well as more numerous. Finally, when the infinite number of harmonics have been summed, the wave becomes truly square in appearance.

Suppose it is desired to pass this wave through a circuit and preserve the shape at the output terminals. To be somewhat more specific, let the circuit be represented by a rectangle in Fig. 22. A square-wave generator is connected across the input terminals, and develops the square-wave voltage shown.

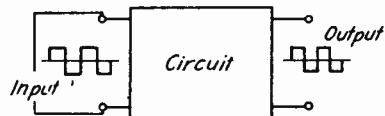

Fig. 22.—A circuit which produces a uniform time delay.

The question that arises is, 'What must the characteristics of the intervening circuit be to develop a square wave voltage across the output terminals?' Before answering this question, it is to be noted that it is not ordinarily necessary for the output voltage to be of exactly the same amplitude as the input voltage; it may be larger if a vacuum tube amplifier is incorporated in the circuit, or it may be smaller if ordinary circuit elements are employed. The only requirement is preservation of the wave shape.

In the first place, it is evident that the circuit must transmit all frequencies to equal extent from the input to the output terminals. For example, if the amplitude of the fundamental component at the output terminals is 80 percent of that at the input terminals, then the reduction in amplitudes of all other harmonics must also be 80 percent. The circuit is then said to have a flat amplitude response, and the relative amplitudes of the components at the output terminals will vary inversely as the harmonic order just as they do at the input terminals.

The next requirement is that of *uniform time delay*. The transmission of electrical energy is not instantaneous, and in some circuits an appreciable or measurable delay occurs between the impress of the wave on the input terminals and its appearance at the output terminals. The requirement of uniform or equal time delay for all components is also reasonable; it means that they will appear at the output terminals all delayed by the same amount, and will therefore retain the same alignment relative to one another that they had at the input terminals. Only in this way can they combine to form a square wave at the output.

This is illustrated in Fig. 23. The uniform time delay is  $T_d$ ; as a result of this the output wave appears later by this amount of time, but is just as square in shape as the input wave. Where the wave shape has to be portrayed on an oscilloscope screen, or other similar recording device, such as in facsimile, television, or in cathode ray work, all intervening circuits and amplifiers between the pickup

device and the reproducing device must have the two basic requirements mentioned above: a flat amplitude response and a constant time delay.

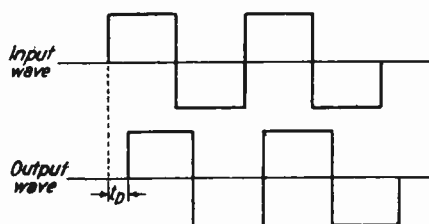

Fig. 23.—Square waves representing uniform time delay.

It is now possible to translate this constant time delay into corresponding phase shifts between the input and output components. As was shown previously, if the phase shift is proportional to frequency, then the circuit has a uniform or constant time delay. Conversely, if the circuit is to have a constant time delay, it must produce for each component a phase shift between its output and input terminals that is proportional to the frequency.

As an example, in the case of the square wave, suppose the phase shift between the input and output terminals for the fundamental is  $30^\circ$ . Then the phase shift for the third harmonic must be  $3 \times 30 = 90^\circ$ ; for the fifth harmonic it must be  $5 \times 30 = 150^\circ$ ; for the seventh,  $7 \times 30 = 210^\circ$ , and so on. If the phase shift is plotted against frequency, a straight-line relationship is obtained, as shown in Fig. 24. For this reason it is often stated that the circuit has a *linear phase*

shift (with frequency) or a uniform time delay.

Note in passing that two waves can be compared as to phase angle only if they are sine waves of the same frequency. This is because only in this case will the waves stay aligned with one another with this difference in phase angle; neither will gain nor lose in phase angle with respect to the other. For this reason the components in

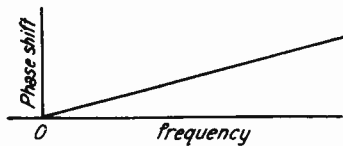

Fig. 24.—The variation of the phase with harmonic of a square wave.

the input or in the output square wave are not compared with one another; instead, *each* component is compared in phase with regard to the input and output terminals. Thus, it was stated above that the output third harmonic, for example, must be shifted in phase by  $90^\circ$  *relative to the input third harmonic*, not relative to the input or output fundamental.

There are various instruments

that can be employed to measure phase shift in a circuit at each frequency desired. Such instruments are particularly important in checking a video amplifier (used in television) or a cathode ray oscilloscope amplifier. Even if the amplifier has a flat amplitude response, it may still distort the incoming wave if it does not have a linear phase characteristic.

More will be said concerning this matter in subsequent assignments. It may be mentioned here, however, that in practice it is not necessary for the circuit or amplifier to be flat in amplitude response and have a linear phase shift up to an infinite frequency in order to preserve the wave from passing through it. Specifically, in the case of a square wave, it has been mentioned that the harmonics diminish progressively in amplitude. As a result, harmonics above the twentieth, or at most the fiftieth, can be ignored. Thus, for a sixty-cycle square wave, the amplifier need have a flat amplitude response and a linear phase characteristic up to  $60 \times 50 = 3,000$  c.p.s. at the most. Its response to higher harmonics is relatively unimportant: the distortion produced, for example, by the amplifier attenuating them will be too slight to be detected.



STUDY SCHEDULE ASSIGNMENT II

1. What is the instantaneous value of voltage at a phase angle of  $315^\circ$  when the effective voltage is 750 volts? When the average voltage is 250 volts?
2. If the current in an a-c circuit lags the voltage by  $45^\circ$ , what will be the instantaneous value of voltage when the current is at a phase angle of  $120^\circ$ ? What will be the instantaneous value of current at that same instant? The average voltage is 700 volts. The effective current is 60 amperes.
3. At  $\phi = 135^\circ$ ,  $E_{inst} = 200$  volts,  $\theta = 70^\circ$  lead,  $I_{ave} = 70$  amps. What is  $I_{inst}$  at this instant? What is  $E_{ave}$ ? What is  $I_{rms}$ ?
4. In a balanced 3 phase system Delta connected primary and wye connected secondary—the effective voltage between secondary line wires is 15,000 volts. The load connected to the secondary draws 4 amperes from each phase. The power factor of the load is 91 percent. What is the power consumption of the load?
5. What current flows in each line wire of a balanced 3 phase system if the generator is Delta connected and carries 120 amperes per phase?
6. What is the line voltage on a balanced 3 phase wye connected system if the phase voltage is 2,300 volts?
7. Given a 3 phase 110 volt 60 cycle transformer with a step up turns ratio of 70. Calculate the following when the transformer is connected Delta Delta, Delta - wye, wye - Delta, and wye - wye.
  - (A) Voltage across secondary winding.
  - (B) Voltage across each pair of secondary line terminals.

ASSIGNMENT II  
ANSWERS TO EXERCISE PROBLEMS

1.  $E_I = -750$  volts       $E_I = -277.5$  volts

Note: At an angle of  $315^\circ$ , we have a negative value since  $315^\circ$  lies in the fourth quadrant and the sine value is negative.

2.  $E_I = 284.42$  volts       $I_I = 73.26$  amps

3.  $E_{ave} = 180$  volts,       $I_I = 46.5$  amps,       $I_{rms} = 77.7$  amps

4.  $P = 94.5$  kw

5.  $I = 207$  amps

6.  $E = 3979$  volts

	(A)	(B)
Delta - Delta	= 7,700 - - - - -	7,700
Delta - wye	= 7,700 - - - - -	-13,321
wye - Delta	= 4,466 - - - - -	4,466
wye - wye	= 4,466 - - - - -	7,700

## PHASE ANGLE, SINGLE AND POLYPHASE SYSTEMS

## EXAMINATION

1. What is meant by "Phase Angle"? What is the symbol?

The phase angle is the number of electrical degrees from the start of the cycle to the instant under consideration.

The symbol is the Greek letter  $\phi$ . ✓

2. What is the instantaneous value of a voltage at a phase angle of  $238^\circ$  when the average voltage is 800 volts? When the effective voltage is 340 volts?

(a) 
$$E_{max} = \frac{800}{.636} \quad E_{inst.} = E_{max} \times \sin \phi$$

$$= \frac{800}{.636} \times \sin 58^\circ = \frac{800}{.636} \times .848 = \frac{1060.8}{.636} = \underline{1668.1V}$$
Recalculated error X

(b) 
$$E_{inst} = \frac{340}{.707} \times .848 = \underline{407.5V}$$
 ✓

3. What is meant by the "Angle of Lead"? "Angle of Lag"?  
What is the symbol?

Due to inductance or capacity in a circuit the current values will not rise or fall at the same instant as the voltage will. Inductance will cause ✓

PHASE ANGLE, SINGLE AND POLYPHASE SYSTEMS

EXAMINATION, Page 2.

3. (Continued)

The current to go thru a certain instant of the cycle after the voltage does. Capacity in the circuit will ~~be~~ cause the current to go thru an instantaneous value before the voltage. The difference in electrical degrees between the two is called the angle of lag or lead. The symbol is the Greek letter  $\theta$ .

4. If the current in an a.c. circuit leads the voltage by 60 degrees, what will be the instantaneous value of voltage when the current is at a phase angle of 130 degrees? What will be the instantaneous value of current at that same instant? The effective voltage is 500 volts, the average current is 70 amperes.

$$\phi_L = 130^\circ \quad \theta = 60^\circ \text{ lead}$$

$$\text{So } \phi_E = 70^\circ$$

$$E_{inst} = \frac{500}{.707} \times \sin 70^\circ = \frac{500}{.707} \times .939 = \underline{\underline{664}}$$

$$I_{inst} = \frac{70}{.636} \times \sin(180^\circ - 150^\circ) = \frac{70}{.636} \times .766 = \underline{\underline{84.3 \text{ amp.}}}$$

## PHASE ANGLE, SINGLE AND POLYPHASE SYSTEMS

EXAMINATION, Page 3.

5. At  $\phi I = 236^\circ$ ,  $I_{inst} = 15.5$  amperes.  $\theta = 82^\circ$  Lag.  $E_{ave} = 200$  volts. What is  $E_{inst}$  at this instant? What is  $E_{rms}$ ? What is  $I_{rms}$ ?

$$I_{rms} = \frac{I_{inst}}{\sin(236^\circ - 180^\circ)} \times .707 = \frac{15.5}{.829} \times .707 = \underline{\underline{13.2 \text{ amp.}}}$$

$$\theta = 82^\circ \text{ Lag so } \phi_E = 236^\circ + 82^\circ = 318^\circ$$

$$E_{inst} = \frac{200}{.636} \times \sin 42^\circ = \frac{200}{.636} \times .669 = \underline{\underline{210.5 \text{ V}}}$$

$$E_{rms} = \frac{200}{.636} \times .707 = \underline{\underline{222.5 \text{ V}}}$$

6. Explain the phase displacement in a three-phase a.c. system, such as used to supply a large transmitter with power.

AC for power is obtained initially from an alternator. The phase displacement can be explained on the basis of an alternator with one pair of field poles and three armature windings equally spaced. For each revolution of the armature past

PHASE ANGLE, SINGLE AND POLYPHASE SYSTEMS

EXAMINATION, Page 4.

6. (Continued)

The field poles a complete cycle of 360 electrical degrees will be induced in an armature winding. Since the windings are equally spaced on the armature they are  $120^\circ$  apart, and since each revolution is  $360^\circ$  the voltages induced in the three windings will be displaced from each other by  $120^\circ$ .

7. In a balanced three-phase system the effective voltage between wires is 220 volts. A step-up transformer taking power from the line has a Delta connected primary and a Y connected secondary. The effective voltage between secondary line wires is 22,000 volts. The neutral point is grounded. What will be the peak voltage across each secondary winding to ground? Show all your work.

$$\text{Sec. line Volt} = 22,000 \text{ V.}$$

$$\text{Sec. phase Volt.} = \frac{22,000}{\sqrt{3}} = 12,700 \text{ V}$$

$$\text{Peak Volt} = \frac{\text{Eff. Volt.}}{.707} = \frac{12,700}{.707} = \underline{\underline{18,000 \text{ V}}}$$

## PHASE ANGLE, SINGLE AND POLYPHASE SYSTEMS

EXAMINATION, Page 5.

7. (Continued)

8. In the above circuit a rectifier load connected to the secondary draws 3 amperes from each phase. (That is, the current in each line is 3 amperes.) The power factor of the load is 94 per cent. What is the power consumption of the load? Show all your work.

$$P = \frac{3 E I}{\sqrt{3}} \times PF$$

$$= 1.73 \times 22,000 \times 3 \times .94$$

$$= \underline{\underline{107.2 \text{ KW}}}$$