

ELECTRICAL COMMUNICATION

JANUARY

No. 3

1938

VOL. 16

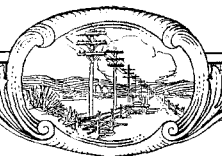

ELECTRICAL COMMUNICATION

A Journal of Progress in the
Telephone, Telegraph and Radio Art

H. T. KOHLHAAS, EDITOR

EDITORIAL BOARD

E. A. Brofos G. Deakin E. M. Deloraine P. E. Erikson F. Gill
W. Hatton R. A. Mack H. M. Pease. Kenneth E. Stockton C. E. Strong

Issued Quarterly by the

International Standard Electric Corporation

67 BROAD STREET, NEW YORK, N.Y., U.S.A.

Volume XVI

JANUARY, 1938

Number 3

	PAGE
ELECTRICAL COMMUNICATION IN 1937	185
THE RIGHT HON. LORD RUTHERFORD OF NELSON, O.M., F.R.S.....	205
CARRIER TELEPHONY AND TELEGRAPHY ON THE ARGENTINE STATE RAILWAYS	206
<i>By C. F. Bulstrode Whitlock</i>	
REDUCTION OF NIGHT ERROR IN RADIO DIRECTION-FINDING EQUIP- MENT FOR AERODROMES	213
<i>By H. Busignies</i>	
AN EXPERIMENTAL 5 kW "DOHERTY" AMPLIFIER.....	233
<i>By C. E. Strong and G. G. Samson</i>	
METHODS OF EQUALISING WAITING TIME ON CALLS INCOMING TO A MANUAL BOARD.....	240
<i>By W. J. Reynolds</i>	
THE DEVELOPMENT OF THE RIO DE JANEIRO AUTOMATIC TELEPHONE NETWORK	244
<i>By W. Hirsch and E. A. Brander</i>	
SOME PROBLEMS OF HYPERFREQUENCY TECHNIQUE	254
<i>By A. G. Clavier and E. Rostas</i>	
SOME RECENT DEVELOPMENTS IN TELEPRINTER SWITCHING SYSTEMS	263
<i>By P. J. Clemens</i>	
THE APPLICATION OF STYRENE TO H.T. CABLE SYSTEMS.....	276
<i>By T. R. Scott and J. K. Webb</i>	
RECENT TELECOMMUNICATION DEVELOPMENTS OF INTEREST.....	285

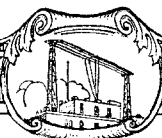

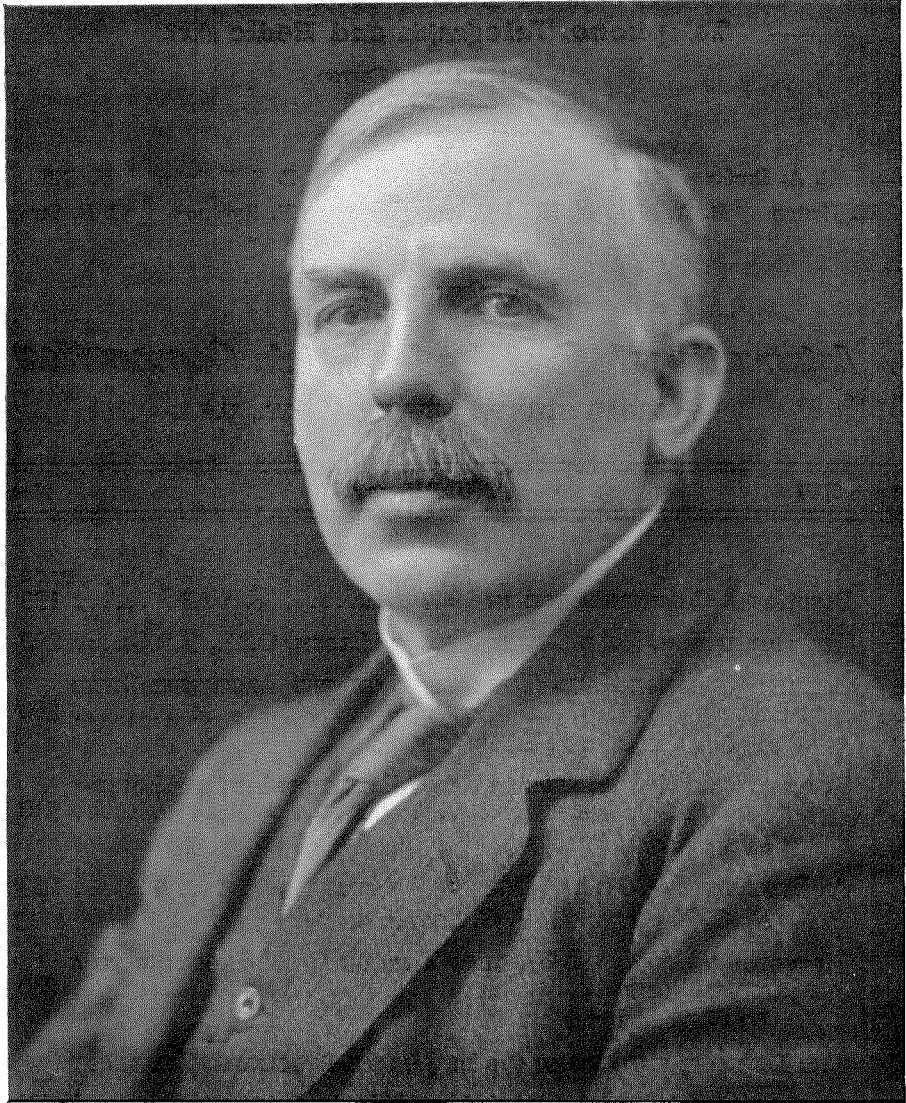

[Photo by Russell, London

THE RT. HON. LORD RUTHERFORD OF NELSON, O.M., F.R.S.
(See page 205)

Electrical Communication in 1937

REVIEWING the achievements in the science and art of electrical communication during 1937 and the few years preceding, progress perhaps has been relatively greater than in any previous period of similar duration. Accelerated applications of electrical communication consequently have resulted, not only in extent but also in the variety and scope of the service rendered. Thus developments of the year have placed broad band transmission on a firmer basis, both in the land and the submarine transmission fields; applications of greatly increased frequencies can now be definitely visualised; higher power ultra-short wave television, point-to-point and broadcast transmitters have been completed or are in process of construction; the first multi-channel, ultra-short wave radio link has been inaugurated in Great Britain; and world wide short-wave broadcast programmes have been disseminated, notably the Coronation ceremonies from London. Important extensions of national dialling and automatic ticketing, moreover, combined with the development of newer and more economical forms of transmission systems, presage an expansion in the communication art greater perhaps than can be conceived by the most optimistic.

Electrical communication—a century old but youthfully vigorous art—to-day evidently is on the threshold of a new and even more fruitful epoch. It is unique in one important respect since, in nature, it is essentially co-operative, providing facilities for practically instantaneous intellectual intimacy between individuals or small separated groups, as well as means for projecting the voice of a single individual to untold millions, whether they be neighbours, in nearby cities or on distant continents. The art has been fortunate, too, in that its amazing development has been greatly accelerated through the co-operative effort of individuals, groups and even nations. This co-operative effort also has been extended to include other sciences and arts with resultant benefit to them as well as to electrical communication. The

individual thus has been presented with increasingly valuable services which have become an indispensable component of modern civilisation.

Uniquely interesting was the 1937 Paris Exhibition. Electrical communication, along with its by-products, contributed in an important degree to the unqualified success of this outstanding international event. It, incidentally, affords an interesting commentary on the fundamental importance of the rôle of communications in modern life.¹

Administrations, private companies and technicians may take justifiable pride in the present achievements; and gain inspiration in visualising even greater accomplishments that surely lie ahead.

Communication Systems—General

Wide band transmission systems² during the year gained increasing predominance and considerable progress has been made since the completion of the first 12-channel multi-conductor cable systems.

Whereas, in the earlier systems, intermediate echo-suppressors formed a satisfactory solution to the suppression of echo effects on long circuits for all forms of carrier, it is now necessary to provide terminal echo-suppressors. Their design presents many new problems which involve operating and hangover times in addition to considerations of the possibility of false operation. These problems received much attention during the year under review, and considerable success has been attained with the new models.

Attention has been given to the application of 12-channel carrier systems to paper-insulated multiconductor submarine cables. The linking up of national networks including 12-channel carrier systems through such cables is already visualised.

Due to increased facilities available for long distance operation and marked advances in

¹ For numbered references see end of article.

automatic switching, several countries are now actively investigating the problem of dialling over long distance circuits. A few countries have already introduced long distance or national dialling within their borders. Long distance automatic international connections bring up the urgent necessity for adopting an internationally agreed series of signals to perform the required operations.

The introduction of television services and the very wide band transmission required between the studio or pick-up point and the television radio transmitter have given rise to intricate problems of transmission involving the study of types of distortion hitherto considered comparatively unimportant.

Progress in Wire Transmission Systems

Field trials of the Bell System's new 12-channel carrier-on-cable system were made over non-loaded cable pairs between Toledo, Ohio, and South Bend, Indiana, a distance of about 150 miles. The cables which were used were not especially designed for carrier but have been in service for a number of years as part of the New York-Chicago circuits. Nevertheless, it was found possible to obtain a considerable number of very satisfactory carrier channels.

Outstanding during the year was the addition to the telephone network in Great Britain of the new Birmingham-Manchester-Leeds-Newcastle coaxial cable systems for telephony and television; 350 km route length of such coaxial cable (containing four coaxial cores) were under construction. Further, the following multi-conductor cable systems for 12-channel carrier were completed: Edinburgh-Aberdeen (396 km); London-Cambridge (150 km); and London-Oxford (198 km). Similar multi-channel cable systems were under construction, namely, Birmingham-Gloucester (170 km); Aberdeen-Huntley (164 km); London-Guildford-Southampton-Portsmouth (315 km); and Glasgow-Edinburgh (145 km). The 4-core coaxial cables installed in 1937 or previously, or under construction, total 550 km, all of which have been or will be supplied by Standard Telephones and Cables, Ltd. The corresponding total of 12-channel cables installed or under construction in Great Britain is 1 938 km. In addition to these important new types of cables,

68 trunk cables were completed or under construction with a total length of 3 225 km as compared with 3 000 km in 1936.

In France, long distance cable systems are being proceeded with at the rate of about 200 km per year. Announcement has been made that manufacture has commenced on an important coaxial cable which eventually will extend from Paris to Bordeaux (605 km).

In Belgium, the third Brussels-Ghent cable (75 km) is in process of installation.

The extensive Italian long distance network, over large sections, has been placed in operation to the full capacity of the existing cables by the completion of loading, whilst new cables completed during the year and under construction totalled approximately 200 km. The 140 km cable for the Piemontesi Railway was completed.

In Switzerland, 68 km of toll cable have been completed and 78 km are under construction.

In Holland, in addition to normal extensions to the long distance network, an important railway cable has been completed between Utrecht and The Hague (149 km).

In Czechoslovakia, the underground long distance cable network was extended in line with the practice of previous years. Approximately 100 km of cable were completed and a further 100 km are under construction.

The Czechoslovakian and Rumanian (Societatea Anonimă Română de Telefoane) long distance systems are being extended by the addition of several important 3-channel carrier systems over open wire lines. The 690 km Bucharest-Kosice (Czechoslovakia) route over which they are being installed will be extended in Czechoslovakia to Trencin (210 km). A new 3-channel system is being installed also between Bucharest and Pancevo, Yugoslavia (460 km), from which point it will be extended to Belgrade, and will provide additional circuits between Bucharest and Belgrade for service between Rumania and Yugoslavia and, via Belgrade, to Italy. Likewise a new 3-channel system is under construction from Pancevo to Szeged (480 km) to provide additional circuit facilities between Belgrade and Hungary.

Large additions have been made annually for many years to the extensive Swedish long distance network. During the year approxim-



PRESIDENT LEBRUN INSPECTS TOTALISATOR TOWER AT PARIS EXHIBITION

During his visit to the Paris Exhibition on November 19th, Mr. Lebrun, President of the French Republic, inspected the Totalisator Tower constructed by Le Matériel Téléphonique to give visual indication to the public of the number of visitors arriving, and of the total number of admissions to date. The Tower (described in the October 1937 issue of "Electrical Communication") is seen on the right of the upper picture. On the left below, the President (second from left) is arriving at the Tower with his party, including Le Comte de Candé, sous-chef du protocole, Mr. Paul Léon, commissaire général adjoint de l'Exposition, Mr. Godard de Douville, commissaire, Mr. Godet, and Messrs. J. Roussel, Poret and Quéfféléan of Le Matériel Téléphonique. In the other picture the President is listening to an explanation of the operation of the Tower by Mr. Poret.

ately 440 km of cable have been completed and an additional 400 km were under construction.

In Norway, the first 114 km section of cable to include single channel carrier circuits was completed between Oslo and Moss over the route which will be extended to the Swedish border and which eventually will provide carrier circuits linking the two countries. An important 3-channel carrier system over open wire lines, totalling 680 km and linking the towns of Kristiansund, Stavanger, Notodden and Arendal, and another 400 km system between Lilleström and Trondhjem are under construction.

156 km of cable were added to the Danish underground network ; 111 km were in process of construction.

The completion of the important cable between Warszawa and the Polish Port, Gdynia, is now well advanced ; the final 217 km section between Torun and Gdynia is under construction.

In Russia the longest 3-channel system over open wire lines ever undertaken as a single system is now in process of construction by Standard Telephones and Cables, Ltd., London, for the Moscow-Khabarovsk route ; it is 8 620 km in length. This carrier system will also incorporate a broadcast programme channel embodying several novel features.

An important Egyptian cable for the Anglo-French Suez Canal Company was in process of installation. This cable will provide telephone communication over the entire length of the Suez Canal (189 km) and also between important intermediate points.

The Australian Commonwealth has evolved a series of underground long distance cable plans and the first cable section in the State of Victoria is now under construction between Melbourne and Geelong (approximately 65 km) which is part of the route followed by the present open wire carrier circuits which link Melbourne with Tasmania over the recently installed Bass Strait submarine cable system.³ It is interesting to note that the traffic over this long submarine cable inaugurated in 1936 has already reached such proportions that means are now under examination for extending the originally provided traffic facilities.

In India an important 3-channel carrier system over open wire lines is under construction for the Bombay-Madras (1 280 km) route.

At Singapore, the 68 km underground cable system has been completed.

In South Africa the first long distance cable between Johannesburg and Pretoria (56 km) was completed. An important 3-channel carrier system over open wires is under construction for the 1 160 km route between Johannesburg and Port Elizabeth.

Development of the non-loaded carrier system in Japan was continued with the completion of the Tokyo-Nagoya cable (360 km) with 7 repeater stations, and work was proceeding on the Sendai-Okidate cable (340 km).

The use of the carrier telephone system for the protection and maintenance of power transmission lines has developed rapidly in Japan, and the system is applied to all 154 kV lines and many of the 66 kV lines. In a recent installation in Northern Chosen the power transmission system is divided into three distribution branches, and three carrier channels are used to provide independent communication for each branch. As the nature of the territory in North Chosen places serious difficulties in the way of ordinary wired telephone systems, increasing use is being made of carrier systems for power line protection and maintenance.

Radio Broadcasting (Including Speech Input Equipment)

Progress in the field of radio broadcasting, apart from television, was characterised not so much by the announcement of new developments as by the continued and intensive application of existing technique to practical service.

In Europe the trend towards higher powers continues to be marked and, among other countries, Holland, Lithuania and Turkey must be added to the list of countries which are either arranging for or actually installing new stations of 100 kW rating and upward. In some instances entirely new stations are provided, while in others it is a case of extending an existing station which is the fortunate assignee under the Lucerne Plan of an unshared wavelength, the maximum exploitation of which is most desirable. The extent to which this trend towards high power has already

made itself felt is shown by the fact that about one in seven of the 250 existing medium and long wave stations in Europe and Northern Africa are now rated at 100 kW or over, and about one in four at 50 kW or over, while 55 per cent. have a rating of not less than 10 kW. In the United States, where broadcasting does not receive financial support from government sources, the use of high power stations is not so widespread; but transmitters with outputs of 50 kW are not uncommon and manufacturers have in hand designs for powers up to 500 kW.

In Great Britain the British Broadcasting Corporation have opened a new medium wave "Regional" station of 100 kW rating at Stagshaw. This station, which was supplied by Standard Telephones and Cables, Ltd., London, employs the modern high efficiency method of final stage Class B modulation and transmits with a power of 60 kW in order to conform to International regulations. A similar station is to be erected at Start Point in South Devon.

The British Broadcasting Corporation have further extended the utilisation of synchronised carrier operation and now have three groups of two stations and one of three stations operating on this method. Individual tuning fork control

of the master oscillator is used at each station in a group, the tuning fork being itself held in step with a master fork to which it is connected over the telephone cable network.

The Norwegian Administration have introduced synchronised carrier operation for a group of three stations and contemplate further extensions of the system. The local oscillators are held in step by periodic application of a synchronising signal sent from the master station over wire lines.

Short-wave long distance broadcasting services have recently assumed considerable importance as may be gauged from the fact that there are already over a hundred specific wavelength assignments for this purpose. Here again increase in station power is very noticeable. There are now some thirty stations rated at 10 kW or over.

At Daventry the British Broadcasting Corporation have added three new transmitters for the "Empire" service, two being rated at 50 kW carrier output at 22 megacycles. These two transmitters were supplied by Standard Telephones and Cables, Ltd., London, and were brought into service in time for the world-wide broadcasting of the ceremonies at the Coronation⁴

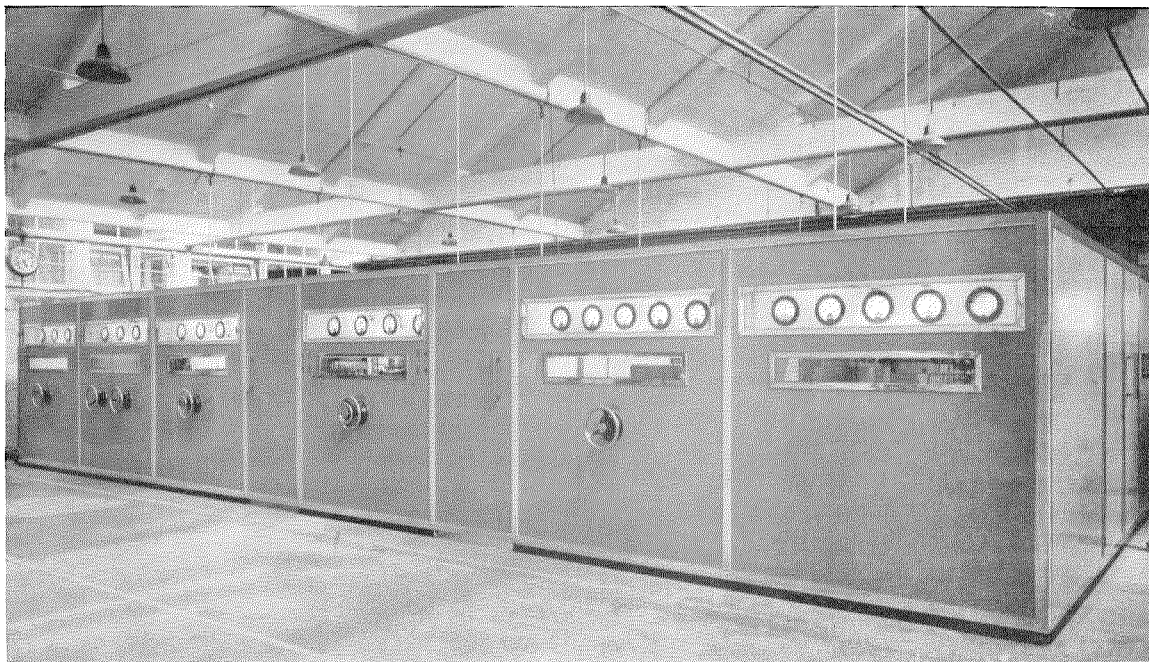

New B.B.C. Medium Wave Regional Transmitter, 100 kW Rating at Stagshaw.

of H.M. King George VI. They are designed for rapid selection between four pre-set wavelengths, and operate on the high efficiency Class B final stage modulation system. Another interesting feature is the use of "inverted" radio frequency amplifiers.

A transmitter of similar type⁵ is now being manufactured in Italy by Fabbrica Apparecchiatura per Comunicazioni Elettriche, Milan, for the Rome station of the E.I.A.R. It will have a rating of 100 kW. This station will also have a second 100 kW and a 50 kW transmitter, making three powerful short-wave sets in all.

In Austria RAVAG will install a 50 kW short-wave station which will be manufactured by Czeija Nissl and Company, Vienna. The 100 kW medium-wave station at Ankara, Turkey, will be supplemented by a 20 kW short-wave station, while Switzerland and other countries are contemplating high power short-wave transmitters for similar service.

The provision of broadcasting service in India, under the aegis of "All India Radio," has now been placed on a firm basis. The plans provide for services on medium wavelengths, for some of the larger cities, and on short wavelengths for general dissemination over the whole Peninsula. A total of thirteen stations has so far been projected; of these, eight will be on medium wavelengths, serving the cities of Delhi, Lucknow, Lahore, Trichinopoly, Dacca, Madras, Bombay and Calcutta; four will be on short wavelengths and located at Delhi, Madras, Bombay and Calcutta, for regular transmissions; while still another short-wave station, located at Delhi, will be used for special transmissions. The scheme includes the existing medium-wave stations at Delhi (20 kW), Bombay (1.5 kW) and Calcutta (1.5 kW). The new medium-wave stations are to be of 5 kW rating, while the short-wave stations will be of about 10 kW rating.

The Australian Government is continuing its plan of increasing the broadcasting service, and four new 10 kW medium wave transmitters are being manufactured by Standard Telephones and Cables (Australasia) Ltd. The number of Class B advertising stations has also been increased and several old stations have been modernised.

South Africa has ordered the first two relay

stations planned to provide service to outlying points not well served by the central stations.

The design of studio and speech input equipment can now be said to be stabilised on the basis of mains power supply to all amplifiers. In some cases the amplifiers use indirectly heated valves, and each amplifier has its own A.C. power supply unit with rectifiers for plate and grid supply; in other cases directly heated valves are used with rectified A.C. smoothed by floating batteries, this arrangement having the advantage of providing in itself an emergency supply system to care for short period interruption of the main supply system. The carbon microphone has been almost wholly replaced by microphones of the electrodynamic or ribbon pattern, and both directional and non-directional types of microphone are now used. Recording apparatus for either disc or tape is usually installed as an essential part of the equipment.

Following the improvements which have been made in recent years in the transmission qualities of telephone cable systems, the policy of partial or complete centralisation of studios has been adopted rather generally. An example of such centralisation is that of the Belgian Institut National de Radiodiffusion, which has recently placed an order with the Bell Telephone Manufacturing Co., Antwerp, for the complete equipment of a group of studios at the I.N.R. headquarters in Brussels. The equipment required uses indirectly heated valves with individual power packs; it includes separate amplifier groups and control desks for seventeen studios, two dramatic mixer positions and five recording rooms, and, concentrated in a central control room, large banks of amplifiers for outside broadcasts and monitoring purposes. Connection of the various studios to the outgoing line positions serving the stations for the French and Flemish zones of Belgium and the short-wave station for the Belgian Congo, as well as to the dramatic mixer positions and recording rooms, is made through a step-by-step automatic equipment. Connections to about 200 monitoring positions throughout the building can be established by means of a rotary automatic exchange. Both automatic equipments are interlinked for checking purposes. An 80 db amplifier signal-to-noise

ratio is specified, together with a 100 db signal-to-crosstalk ratio.

A few years ago the "relaying" of a programme from one country to another was an exceptional event. To-day it is commonplace, and concerts, observers' reports and items of special interest are every week passed over the international telephone network to be broadcast as a matter of routine in some country other than that in which the item originated. In the broadcasting of the Coronation⁴ ceremony of H.M. King George VI, however, the year witnessed a relay of unusual magnitude, in which the broadcasting authorities of no fewer than twenty different countries relayed the programme directly from London through their own stations.

Public Address

The installation of public address equipment on all occasions where a large number of people are assembled has become more and more common, and it is rare to-day when any public event of importance takes place without an installation of such equipment. The acoustical problems involved are such that special studies are required in connection with each installation.

During the year two outstanding installations of public address equipment were made in Europe: one at the Paris Exhibition;¹ the other at Westminster Abbey in connection with the Coronation⁴ of H. M. King George VI.

Commercial Radio

The year 1937 was characterised by an increasing demand for commercial radio facilities. An outstanding feature of new transmitters was the incorporation of facilities for rapid changes of wavelength. In England and America this tendency, combined with the demand for simpler control, has led to the extension of impulse controls operated by a telephone dial.

Ultra-short wave operation continues to be the direction in which commercial radio is advancing most rapidly. Its extension is in some cases due to the highly efficient aerials, which may be erected without excessive cost, and to reduced atmospheric interference; and, in other cases, to the possibility of transmitting wide bands of modulation frequencies.

Multi-channel operation of radio links has been brought into the practical field of communication by the use of these properties of ultra-short waves. 1937 marks the introduction for the first time of a multi-channel unattended remote controlled radio link in the regular long distance telephone network.

This unique installation is a 9-channel multiplex radio link connecting Belfast and Stranraer,⁶ which was formally opened for public service in August. The Press has mentioned the possibility of the installation of two more similar links connecting Dover and Calais, thus furnishing a further 18 telephone channels between England and France. Simpler single channel equipment has been used off the coasts of Scotland for extending telephone facilities to the nearby islands, since the character of the service does not warrant the high cost of installing submarine cables.

Plans involving the operation of long distance international links have been influenced by the drop in field-strength which is expected in the year 1940. Periods of severe attenuation have already been experienced on transatlantic circuits and have caused a demand for the erection of high gain directional aerials. On account of its wide band operation, the rhombic aerial has been favoured in meeting this demand. Such aerials have recently been installed at Geneva, Budapest, Bangkok and Durban, and it seems likely that further installations will be made to replace tuned arrays now in operation. This possibility, taken in conjunction with rapid band-changing by means of telephone dials, indicates the trend towards simplifying the operation of transmitters. By eliminating the necessity of mechanical adjustments to the transmitter itself and of switching the aerials, the operator is left free to concentrate on the handling of the circuit. Moreover, the provision of complete remote control of the transmitter is rendered easier.

On international links of first importance high gain aerial systems are already in use, but it is anticipated that at about the year 1940 a dozen decibels of additional gain will be needed for 40 per cent. to 50 per cent. of the time during sunspot periods in order to maintain the circuits at a commercial level. Since the average transmitter

carrier power is already of the order of 15 kW, still more gain in the aerial systems is economically justifiable. The older types give no certain improvement in operation beyond a gain of the order of 14 decibels since the vertical polar diagram thereafter becomes too sharp. The Bell Telephone Laboratories have, therefore, developed for receiving purposes, the Multiple Unit Steerable Antenna (M.U.S.A.), information on which was published during the year. This system gives much greater directivity in the vertical plane since the wave angle is continuously adjustable by the rotation of a suitable control system. Estimates suggest that a system incorporating 20 rhombic aerials and extending over a length of 2 miles would be practicable and would give an improvement of 12 to 13 decibels in signal-to-noise ratio over the older types of aerial. The great vertical directivity of this system enables it to respond to only one wave of a downcoming cluster at a given time; it, therefore, goes a long way towards eliminating telephone distortion caused by selective fading. In addition, several receivers may be supplied by the one aerial group, being adjusted to be sensitive at different wave angles. By combining the outputs of these receivers in a diversity system, a stable audio channel is obtained and, at times of bad fading, gives a surprising improvement in quality over single-aerial and space-diversity systems.

The M.U.S.A. aerial system is a fundamental development in the short-wave art since it gives promise of overcoming selective fading by arriving at its component causes. The play of economic factors on the commercial application of this system will be watched with interest.

In the United States a 200 kW high frequency radio telegraph transmitter was placed in service. Also of interest is the extensive use now being made of the newly developed re-entrant networks which make it possible to utilise antennae for two or more frequencies simultaneously, resulting in a highly economical radiating system.

Police Radio

A number of medium and short-wave systems are being installed in Great Britain, Czechoslovakia, Palestine and Egypt, but the most

significant development is the introduction of ultra-short wave for this service.

During 1937 there was a considerable increase in the use of these systems in the U.S.A. Approximately 275 areas are now served by U.S.W. systems of Western Electric or other manufacture.

In Europe, demonstrations of the system have been made in a number of countries and the system is being installed in Austria, Norway and Finland, while it is anticipated that U.S.W. for local area coverage will be adopted in other police networks. The great advantage of U.S.W. working is that two-way telephone communication can be maintained with mobile units equipped with small, lightweight transmitting and receiving sets.

It seems probable that the future trend of police networks will be the use of U.S.W. for local area coverage and medium or short-wave for long distance and international working.

Marine Radio

The installation of short-wave transmitters is proceeding at a rapid pace and practically all new ships built for overseas services now employ short-wave communication equipment.

This policy on the part of shipowners will result eventually in a great increase of traffic in the short-wave marine bands, and this in its turn will give rise to increased difficulty in the working of individual ships and coast stations owing to the additional interference thus occasioned. Many operating organizations, therefore, are introducing crystal-controlled, short-wave transmitters along lines recommended by the International Marine Radio Company, Ltd., London, several years ago.

The Swedish Administration has completed its design of a new ship's transmitting equipment which is provided with 6 crystal-controlled frequencies. All power for the transmitter is taken from an A.C. generator and rectified by means of Selenium type rectifiers.

By its ratification of the recommendations of the "Safety of Life at Sea Conference," held in London in 1929, the U.S.A. Government now requires the use of Auto Alarm Apparatus on board U.S.A. ships. Two types of equipment

have been developed to meet the shipowners' demands and the requirements of the Federal Communications Commission. The principle of automatic alarm signalling as defined by this Conference is now accepted by all the large shipping nations.

Another administrative act of importance is the law passed by the Norwegian Storting. The law makes it compulsory for all ships above 1 600 tons to install radio apparatus in advance of October, 1937, instead of January, 1938, the date previously given. It also compels all Norwegian ships crossing the North Atlantic to be fitted with radio, irrespective of tonnage, and is a direct result of the usefulness of radio in saving human lives as exemplified by the spectacular rescues in the North Sea during the unusually heavy storms experienced in the winter of 1936-37.

Communications with coastal cargo and passenger ships, as well as trawlers, are being handled mainly by radio telephony.

There is an increasing tendency towards the linking up of the radiotelephone installations on these small ships with the land telephone network. During 1937 several radiotelephone coast stations have been available for this service :

In Great Britain—Seaforth and Humber ;

In Norway—Tjömö, Kristiansund, Bergen and two others ;

In Sweden—Stockholm, Göteborg and Hernösand.

The carrier powers of the shore stations vary from 250 watts to 2 000 watts. Crystal control is employed on several of the new stations.

The use of radio aids to marine navigation is rapidly spreading. Radio direction finders specially designed for use on small ships were introduced in the U.S.A. These direction finders cover ships' communication and marine beacon bands.

Certain of these types of direction finders for small ships introduced by the International Marine Radio Company, Ltd., London, and others, are designed, in addition, to cover the 80-200 metre band. This enables the smaller cargo and passenger ships, and especially trawlers, seal and whale catchers, to whom it is often of great advantage, to take bearings on each other as well as on coast stations working within this band.

In Europe use is being made of medium wave range beacons to guide ships through narrow channels. In Finland one such beacon has been put into service at Grohara and another is on order for Rödhamn. The beam has a spread of about 4° and results from the combined action of a Bellini-Tosi system of crossed loops and a vertical antenna.

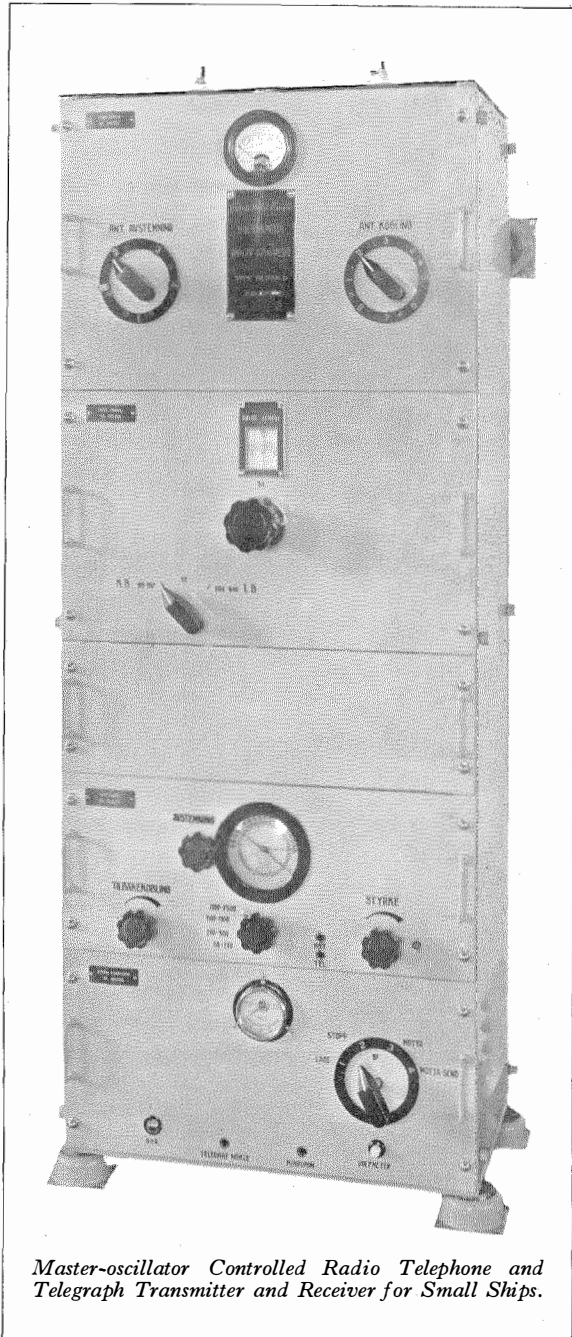

Master-oscillator Controlled Radio Telephone and Telegraph Transmitter and Receiver for Small Ships.

A modern master-oscillator-controlled radio telephone and telegraph transmitter and receiving equipment for small ships is shown in the illustration on page 193. The wavelength ranges are : 3 720 to 1 500 kc and 500 to 375 kc (80-200 m and 600-800 m). The carrier output power is 100 watts and the transmitter is capable of 100 per cent. modulation within the permissible limits of distortion.

Aviation Radio

For communication purposes the tendency is to use higher powered transmitters both on medium and short-wave bands. The reasons are two-fold : (1) a better signal strength is generally required on both wavebands ; and (2) the air transport companies wish to eliminate the 70-metre trailing aerial used extensively for the medium wave services.

The K.L.M., the Dutch air transport company, in 1937, introduced 200-watt equipments for medium and short-wave telegraphy on their routes to Batavia. On the European routes the medium wave only is used.

Standard Telephones and Cables, Ltd., London, have completed the development of a radiotelephone equipment for fighter aircraft. Crystal control of four fixed frequencies is used for both the transmitter and receiver ; and although the output power is of the order of three watts the ranges obtained, when working with a ground station having an output power of seven watts and similarly controlled, are remarkable. Another notable feature of this set is its remote control system which is electrical throughout. The weight is very low.

In the field of air navigation the following are of special interest :

(a) The introduction of the "Z" and "fan" marker beacons along the radio routes in the U.S.A. Frequencies of the order of 75 megacycles are used.

(b) The acceptance by the Australian authorities of a plan for using U.S.W. frequencies for range navigation as well as for blind approach beacons. This scheme was proposed by C. Lorenz, A.G., and demonstrations were carried out by this firm at Essendon, Australia, in collaboration with Standard Telephones and Cables (Australasia), Ltd.

(c) The installation and demonstration of the Lorenz blind approach system at Indianapolis, Indiana, U.S.A. (where the term "radio instrument landing system" is generally employed). The demonstration proved that a practical system for this purpose exists.

The Lorenz system⁷ is in extensive use in Europe, and has been adopted also in the Far East, in Australia, in South American countries, and in South Africa.

The United States Army has experimented with an automatic landing system in which radio signals from several beacons suitably located along the approach path control the automatic pilot equipment on the plane.

New models of the R.C.5 Standard-Busignies Automatic Radio Compass⁸ have been produced by Standard Telephones and Cables, Ltd., London, and by Le Matériel Téléphonique, Paris. The most important changes are the extension of the frequency range to include the band from 150 to 1 500 kc, thus enabling the pilot to take bearings on broadcast stations in both bands, and improvements in the remote tuning control.

During the year demonstrations of the RC.5 Standard-Busignies Automatic Radio Compass have been carried out in the U.S.A. These have aroused considerable interest on the part of the airlines, the Government Department of Commerce, the Army and the Navy.

Standard Telephones and Cables, Ltd., have also completed the development of a small, hand-operated, loop direction finder combined with a "homing" course indicator. The loop is protected by a streamlined housing ; and, due to its small dimensions, the drag at any aircraft speed employed to-day is negligible. The weight and space requirements have been reduced to a minimum, thus permitting its installation in aircraft for itinerant aviators.

In France, the policy of using ground direction finders was adopted by the Air Ministry some years ago. In the spring of 1937, an order for 24 Standard-Adcock equipments, type RC.6-A, was placed for civil and military airports.

The Swedish Telegraph Administration installed a Standard-Adcock direction finder for the Jönköping airport, as a result of the success

of the 1936 installation at the Norrköping airport.

The rapid development of regular airways in Japan has led to the establishment of radio beacons along a number of principal air routes.

In the U.S.A., work of importance was carried out during the year on the elimination of static interference with radio reception. The solution of this problem is of the greatest importance to air line operators everywhere ; and, with the knowledge resulting from the fundamental studies now completed, a satisfactory cure for this type of interference may be obtained in the near future.

Valves

Progress in the thermionic valve art was mainly directed to improvements in existing types and to the extension of the frequency range over which valves can be made to operate. Increased demands obtained for valves operating at ultra-high frequencies, and much effort has been devoted to their development. As is now well known, one of the requirements for such valves is that the transit time of the electrons in travelling from one electrode to another must be short.

By careful design, the range at which negative grid triodes will continue to function has been increased considerably beyond the previously accepted limits of oscillation. Notable advances in this direction have been achieved by the Bell Telephone Laboratories, where negative grid triodes have been oscillated at frequencies as high as 1 500 megacycles per second with an output of 2 watts. These frequencies have been made possible by the use of double leads to grid and anode, contrasting with the frequency of 650 megacycles per second obtained by the W.E. 316-A valve at an output of 2 watts. Small electrodes with extremely small separation are used in the new valves.

By making use of the "Micromesh" principle of construction, the Standard Telephones and Cables Valve Laboratory, London, has produced an indirectly heated valve capable of giving an output of over 10 watts at a frequency of 230 megacycles. Although the frequencies so far attained for this type of valve are far from those recorded above, it is worthy of note that this

particular valve is of such a size as to make its construction much simpler.

Development of wide band transmission systems places stringent requirements on the valves used. So far, advances have been made by improvements along more or less conventional lines. The principal aim for the initial stages of wide band amplifiers for repeaters, etc., has been to produce valves having a high ratio of slope to inter-electrode capacity. In addition, the output valve must be capable of delivering from one to five watts into a comparatively low resistance, thus placing considerable demands on cathode emission.

Steady improvement continues in electronic devices, such as iconoscopes and cathode ray tubes. These electronic methods of pick-up and reproduction still hold a predominant position.

The size of the valves used in radio broadcast stations continues to increase. Whereas not many years ago valves having peak power outputs of 40 kW were almost unknown, valves capable of delivering peak powers of 100 kilowatts are now in successful operation. Les Laboratoires, Le Matériel Téléphonique, Paris, have developed a valve, 3067-A, which has a power handling capacity of 200 kW peak. These valves are of the sealed-off or permanently evacuated type ; and it is quite possible that still higher powered valves of this type will be produced. High powered valves of the continuously evacuated type are undergoing trials, but it is not yet by any means certain that they will displace the sealed off types as higher powers are called for.

There is a growing tendency to use tetrodes and pentodes for transmission purposes. During the year radiation cooled pentodes with an anode dissipation of one kilowatt have become available, and the development of water cooled tetrodes is being actively carried out. Just how far high powered tetrodes will progress is problematical, but the indications are that very large valves of this type may become available within the next few years.

No outstanding developments in valves for radio broadcast receivers occurred in 1937. Changes have been limited mainly to modifications of known types. Perhaps the most note-

worthy feature was the rise to popularity of the so-called beam valve at the expense of the conventional pentode.

Radio Broadcast Receivers

The past year has been one without any startling innovations, the only marked feature being the general adoption of at least one short-wave band in almost every receiver. Otherwise the general trend of development has been towards a simplification of the controls which have to be operated by the listener and, particularly in the more expensive sets, an extension of the functions carried out by automatic means.

Television

In the field of television the year brought

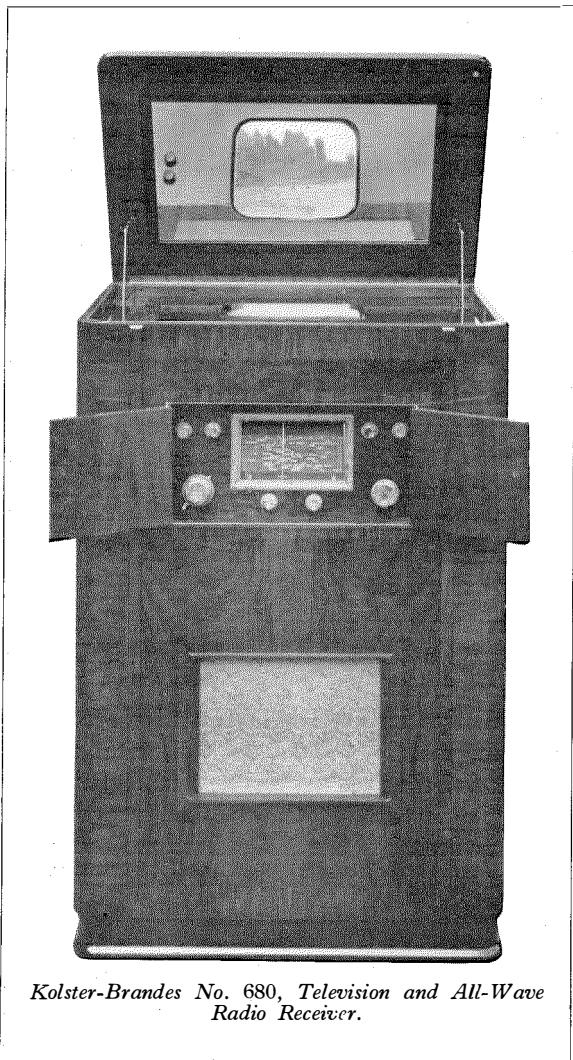

Kolster-Brandes No. 680, Television and All-Wave Radio Receiver.

forth no startling changes. Progress, however, has been consistent.

The British Broadcasting Corporation standardised on the Marconi E.M.I. system and have ceased transmission with the Baird system. Programme time is now three hours daily, a large part of the programme being direct vision by means of the Emithron camera.

The first "outside" television broadcast in Great Britain was made from London on Coronation Day, May 12th, 1937, when the British Broadcasting Corporation's television camera van at Hyde Park Corner was connected to the Alexandra Palace television broadcast transmitter by 9 miles of balanced screened-pair cable, with repeaters and equalizers at Broadcasting House and the Alexandra Palace. Television cameras formerly had only been operated in the immediate vicinity of the transmitter, but the transmission of the signals over the cable link did not appreciably deteriorate the quality of the pictures.

Some fourteen manufacturers showed television receivers at the recent exhibition at Olympia (London). The prices ranged from £38 to £125.

In France the old television equipment has been entirely replaced by modern studio and transmitter equipment, capable of giving 455 lines. Direct or film signals are used with the pick-up located either at the P.T.T. studio or at the Radio Palace at the Paris Exhibition. A vision transmitter of 30 kW peak power, supplied by Le Matériel Téléphonique, Paris, has been installed at the base of the Eiffel Tower and has been connected to the antenna at the top by a concentric cable. The vision transmitter operates on 46 megacycles and the sound transmitter on 42 megacycles.

There has been an advance in the intermediate film pick-up in Germany. By means of a mechanical scanner, electron multipliers and a special process, a film scanner has been produced which photographs, develops and transmits the picture within 16 seconds of the action.

The new N.B.C., Washington, D.C., studios, opened in 1937, include television equipment. Extensive provision has been made for visual broadcasts.

A successful demonstration of television

transmission over the New York-Philadelphia coaxial cable was given by the Bell Telephone Laboratories during November. Motion picture film and a disc scanner were used at the sending end and a cathode ray tube at the receiving end. The outstanding feature of this demonstration was the use of a large percentage of the available band width of the cable system. The results also proved that irregularities in this type of cable were negligible and that phase shift could be adequately compensated.

Wide publicity is given periodically in the popular Press to television programmes being received at great distances. Such reception, however, as is well known to technicians, is of a distinctly freak nature. Consistently reliable reception from the London Television Station is generally obtained at ranges of 30 to 35 miles, whilst reports from a number of viewers indicate that good reception is possible at 50 and 75 miles. Since television programmes are expensive, it seems obvious that television for some time to come at least will be dependent on coaxial cables for distribution to a number of television broadcasters.

Picture Transmission

Both fixed and portable installations for picture transmission are being employed increasingly by newspapers. Simplified systems for transmission of maps are being used in connection with weather forecasting.

Interesting results have been obtained with apparatus developed by the Laboratories of the Nippon Company, Tokyo. A special type of modulation avoiding to a large extent the effects of interference is employed.⁹

Subscribers' Equipment

During the last few years, subscribers sets have been brought to a high degree of perfection. The self-contained table set, long ago accepted in Europe, is now universally accepted throughout the world. Transmitters, receivers and their associated circuits have been improved so that to-day speech is transmitted with greater efficiency, less distortion (more naturally) and less extraneous noise. In 1937 no radically new ideas were introduced but a great deal of

carefully planned development and research was undertaken, and the work is still under way, to further perfect subscriber set equipment. Particular attention is being paid to improvements to reduce the cost of maintenance. Individual parts are being improved to better withstand the detrimental effects of moisture. Contacting and moving mechanisms, such as switch hooks, ringers and dials, are being improved to withstand rougher usage and dust. Cord life is being increased and insulation of the conductors improved by the use of rubber.

In recent years much effort has been expended on the design of Distant Talking and Loud Speaker Subscribers' Telephone Sets. The troublesome problem of the disturbing factors encountered in such a set—relatively minor in the ordinary telephone—has been investigated and important progress made. A loud speaking conference system for use in association with exchange or P.B.X. lines has also been produced.

A new 25 and 50-line automatic P.B.X. has been developed by Standard Telephones and Cables, Ltd., in conjunction with the British Post Office, and a similar P.A.B.X. covering the 50/200-line range is being developed. These equipments constitute the future British Post Office standard and all P.A.B.X.'s intended for use in Great Britain will be manufactured in accordance with these designs.

Rotary

The French P.T.T. has commissioned Le Matériel Téléphonique, Paris, to manufacture Rotary automatic equipment for the Paris regional area. This network, at present operated manually, is some 25 km distant from the centre of Paris and forms a 15 km belt around the Paris suburban area. The population included in the regional area is now about 1 000 000 with about 40 000 telephone subscribers.

The conversion from manual to automatic operation will be made in successive stages. About 9 540 lines in 14 exchanges are under construction. When complete the area will be equipped with about 60 000 lines in approximately 200 exchanges.

Production of the new 7-A2 type of Rotary equipment, with its many technical advantages, continues to increase. The number of lines

of this new equipment installed and on order in many important towns, including Brussels, Bucharest, Budapest, Oslo, The Hague, Copenhagen, Rio de Janeiro and Lima, totals nearly 200 000.

The Rotary automatic system is now installed in approximately 900 exchanges in 39 countries. The total number of lines installed or on order at the end of 1937 was over 2 000 000.

Automatic Ticketing

Automatic Ticketing has more than fulfilled expectations. At the end of 1937, 14 650 lines in 19 exchanges equipped with this facility were on order or installed. Of this number, 11 650 lines represent new equipment of the 7-D rotary type.

An economical method of introducing Automatic Ticketing in existing 7-A1 type Rotary exchanges has been devised and will be used immediately in a number of large exchanges. This new method is also applicable to all forms of step-by-step equipment.

During the year, new equipment of the 7-D Rotary type, equipped with Automatic Ticketing, was placed in service in the Belgian seaside towns of Knocke, Le Coq, Heyst and Zeebrugge.¹⁰ The pivotal switching centre of this network is the town of Bruges where the printing registers serving the complete network are located. All multi-fee calls outgoing from the outlying exchanges of Knocke, Heyst, etc., are trunked through Bruges, the printing registers in the latter town producing tickets which contain the number of the calling party, the number of the called party, the duration of the conversation in minutes, the basic tariff, the time of day and the date. In short, all the data formerly given by "manual ticketing" methods is now produced automatically.

This constitutes a real achievement when it is considered that the calling parties may be connected to exchanges some 25 or 30 km distant from Bruges, where the tickets are produced; also that the identification and printing of subscribers' numbers are accomplished entirely automatically and without requiring any co-operation on the part of subscribers.

The centralization of the printing registers in

the trunking centre of the network permits corresponding centralization of the ticket sorting and accounting, as well as the giving of information to the public by the special service control operator. The scheme also provides the most economical use of equipment.

The exchange at Knocke operated during the whole of the busy summer season, and the performance of the Automatic Ticketing equipment was highly satisfactory in every way.

National Dialling

During the year subscriber-to-subscriber dialling service was successfully introduced in the Rotary exchanges of Haarlem and the surrounding exchanges of the Bulb District, Holland. Thus approximately 20 000 subscribers in 24 exchanges now can reach Amsterdam and the surrounding exchanges by dialling a toll prefix followed by the number of the wanted party.

In Zurich, Switzerland, the first fully automatic national toll exchange is under construction. The first stage will include equipment for 280 toll lines with an ultimate of 1 840 toll lines. The installation of this equipment is part of the plan of the Swiss P.T.T. to place the whole country on a full automatic toll basis. When completed, only international connections will be handled manually. Five international toll exchanges are foreseen for serving the entire country.

This development in Switzerland is a good illustration of the trend of development in Europe. National dialling systems are under consideration in a large number of countries, some based on full automatic, subscriber-to-subscriber operation, and others on operator dialling.

In view of the fact that such automatic service will very soon be extended to international connections, the C.C.I.F. is now very actively studying means whereby the systems being introduced can be sufficiently standardised to allow international interworking.

C.C.I.F.

The probable introduction of automatic dialling and of possible "no delay" service in

international working, with the accompanying need for more circuits with improved groupings, more efficiently utilised, and more rigidly controlled from a transmission standpoint, has led the C.C.I.F., in addition to its regular work, to consider and study the problem of a "General European Long Distance Switching Plan." A sub-commission made up of technical, operating and traffic experts has been set up and has started on a very active programme of study which it is confidently expected will aid materially in the more rapid and efficient development of means for the international interconnection of subscribers throughout Europe. This decision of the C.C.I.F. to pool information and co-operatively plan the development of the international network is a great step towards advancing telephone use and service.

Telegraph Progress

A more general appreciation of Teleprinter systems, manifested by their extended employment for national telegraph services, was evident during 1937. The success achieved by the British Post Office in introducing voice frequency systems, and the replacement of obsolescent terminal equipment by Teleprinters prompted other European Administrations to take corresponding measures for raising the efficiency of their Telegraph services.

Teleprinter systems also continued to demonstrate their importance in the field of private written communication, and the year has seen a steady extension of their use in commerce and industry throughout Western Europe. In Great Britain alone, an additional 800 Creed Teleprinters have been acquired by the British Post Office to meet the growing demand for private point-to-point and Telex services.

The trend towards the more universal adoption of Teleprinter systems is equally apparent in the case of the British Railway Companies, most of whom have extended their existing Creed Teleprinter installations during 1937. New projects planned by the London and North Eastern Railway include an automatic Teleprinter switching system providing inter-communication between forty of its more important centres. The strain imposed on the railways by the increased transport handled has directed their attention to the facility with which

the Teleprinter can transmit invoices and way-bills for certain classes of freight, and trials are now being carried out having in view the introduction on a large scale of the Teleprinter system for such service.

By discarding Morse telegraphy in favour of the Teleprinter system operating in conjunction with multi-channel voice frequency transmission equipment, the Press in Great Britain is now obtaining an increase in speed and efficiency of news distribution.

There is a growing interest in the use of Teleprinters as a means for written communication between departments and offices in centralized manufacturing concerns, particularly in the case of plants engaged on mass production lines.

Important demands were met during 1937 by the provision of Teleprinters for handling weather reports in connection with civil aviation. This branch of the communication field gives promise of considerable expansion in many countries.

The demand for Creed High Speed Morse equipment for operation with radio systems exceeded that of previous years.

With the object of extending the field of application of Teleprinter systems, Creed and Co., Ltd., produced a new Teleprinter (Model No. 10) designed to provide Ticker Companies, News Distributing Agencies and similar service organisations, with a cheaper, smaller and comparatively noiseless tape machine, capable of operating at high speeds and simple to maintain. It operates on the same selecting code as other Teleprinter systems, and employs the same start-stop principle for maintaining unison with the distant transmitter, but it is radically different in design and construction and incorporates mechanisms which are new to the telegraph art.

Development work also was directed towards perfecting the design of existing Teleprinter systems, particularly in regard to the transmitting mechanism, in order to ensure that the distortion limits specified by the C.C.I.T. at the Warsaw meeting may be maintained at all times without critical adjustment.

Other new developments include an electromagnetic release for the answer-back unit to

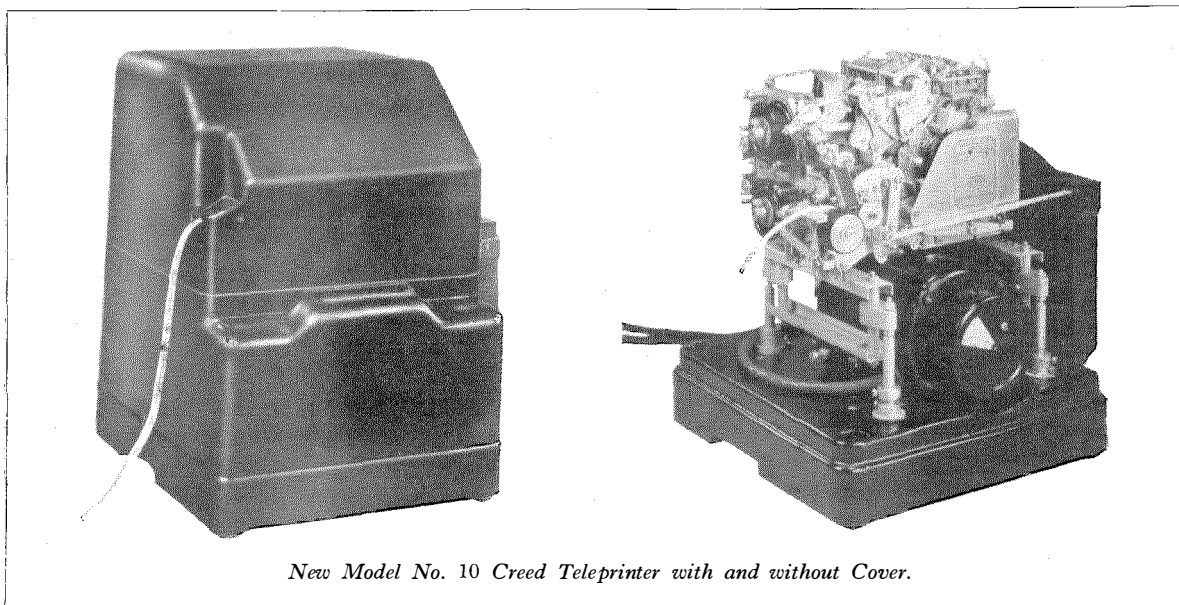

New Model No. 10 Creed Teleprinter with and without Cover.

meet the requirements of automatic switching systems, and an end-of-line indicator for use on Page Teleprinters operating without home records.

Teleprinter Exchange Systems

There is a growing tendency to consider Teleprinter exchanges as component parts of complete national or international systems. A number of new types of Teleprinter exchanges,¹¹ both manual and automatic, were designed during the year, and it is expected that this branch of the communication art will continue to expand. In Czechoslovakia the Telegraph Administration decided to inaugurate person-to-person Teleprinter services, including the linking up of Czechoslovakia with the European Teleprinter network.

Remote Control and Signalling Systems

Further developments and applications of Remote Control and Indicating Systems have taken place, notable examples being the successful introduction of variable frequency remote metering over the same pilot lines as are used for signalling and speech purposes. This form of metering has been applied to remote control systems in connection with the transmission of energy in bulk; also, to obtain indications from traction substations on important electrified

railways. Of particular interest in railway electrification schemes is the use of two wires only for the control and indication of a number of substations. Operating the variable frequency metering system on the same two wires often makes available a spare pair of pilot wires for use in emergencies, such as derailment.

A new development, which proved successful in its first field trials, is the remote control of street lighting by impulses superimposed on the ordinary distribution network. Further applications of this principle are being developed to enable water heating loads to be similarly controlled from substations or from a central control point. Another important application of this system will be the control of air-raid hooters or sirens from a central point, as well as of emergency calls for firemen and such volunteers as might be required.

Fire Alarm Systems

The Gamewell Fire Alarm System continues to make progress. In 1937 Standard Telephones and Cables, Ltd., London, equipped the new headquarters of the London Fire Brigade at Lambeth with 35 street boxes and the necessary recording apparatus, switchboard and batteries. This is the first part of the "B" division scheme of the London Fire Brigade covering Whitefriars, Cannon Street,

Red Cross Street, Soho and Holloway. An extensive system has been installed at East Barnet, in the North of London, and important orders are in hand for Belfast, Rugby and Dagenham. Of these, Belfast is the largest and consists of 110 boxes operating on 9 circuits with one headquarters station and three substations.

Railway Systems

Further developments have taken place in the Railway Signal Control systems, whereby the signal and point levers in a signal cabin are replaced by small turn keys and a diagram mounted on a suitable desk. Combined therewith a novel system of interlocking has been developed, providing the necessary interlocking between conflicting routes by means of motor driven rotary switches. With this system considerable space economy is effected, as compared with the more usual type of relay interlocking. Extensions of this development to include the remote control of track layouts are taking place; they will enable a large number of routes to be set up over a common control channel.

The Standard Signal Post Telephone System now includes the addition of a "Proceed" signal, as required by the British Ministry of Transport. Control has been effected without additional line wires and is the approved drivers' telephone system for use at signals in automatic territory on the London & North Eastern Railway of Great Britain.

All-Mains Power Suppliers—Selenium Rectifiers

Growth continues in the replacement of battery and floating battery power supplies by all-mains power suppliers employing Selenium¹² rectifiers. This trend toward the elimination of both batteries and machines in the telephone plant has been signalled by the official approval in 1937 of the telephone Administrations of several countries in addition to those which approved and adopted the Selenium rectifier previously.

In other applications,—radio, railway signalling, industrial equipment, etc.,—the use of Selenium rectifiers is growing rapidly,

particularly where small bulk and freedom from maintenance are essential.

Engine Indicators

An instance of the extension of communications technique to other fields is afforded by the Engine Indicator developed by Standard Telephones and Cables, Ltd., in conjunction with research engineers of the Anglo-Iranian Oil Company. This indicator uses a pick-up consisting of a magnetic diaphragm exposed, on one side, to cylinder pressure, and vibrating in front of a magnet carrying a coil, the output of which, after suitable amplification, is indicated on the screen of a cathode ray tube. The output of a pick-up of this type is proportional to the rate of change of pressure, and a special integrating circuit has been developed in order that actual cylinder pressures may be observed. Suitable modifications of the pick-up enable fuel line pressures and fuel valve movements to be shown.

Recent developments include a weak spring unit for the observation of relatively low pressures, such as exist in a cylinder during the exhaust and inlet strokes, and a calibrating unit enabling the accuracy of the readings to be checked under operating conditions.

The principles involved in the instrument are applicable to the indication of mechanical pressures and vibrations generally, and further development work to this end is in progress.

Power Transmission

Whilst considerable research is continually being directed towards solving some of the problems associated with the application of D.C. to the transmission of power, established A.C. methods continue to attract the major attention.

In the sphere of overhead lines, the problem of surges due to lightning and switching operations is of outstanding technical interest; and the correlation of measurements, carried out under practical conditions and in the laboratory, have enabled satisfactory advances to be made in the understanding of these phenomena. The lightning-proof line has become feasible so that further efforts can now be directed towards attaining more satisfactory ageing characteristics for the protective components.

Rational surge protection of a transmission system implies co-ordination of insulation levels to secure trouble-free operation in conjunction with economic construction. Considerable attention has been devoted to the impulse strength of various forms of insulation at extremely short testing times and, in this connection, the exploration of oil-impregnated paper and pressboards has been notable.

In the case of underground cable systems, the year has been marked by a consolidation of the position achieved by the pressure-type of cables. Additional test results have been published, and an opportunity of studying the behaviour of new types in service will shortly be available. As to the internal gas-pressure types, the field is still being contested by advocates of both the impregnated paper and the dry paper systems. A general anxiety has been revealed to discover some criterion which will indicate the occurrence of any disruptive discharges in the testing of this case of insulation.

There has been little change in the commercial position of solid type cables. The principles underlying the special intersheath type of cable described in 1936 have been shown to be essentially sound but the cables have not yet been installed in a commercial network. On long-period ageing tests their stability has proved to compare very favourably with that of normal types when judged purely on a basis of maximum stress, and this tends to confirm the economic advantages claimed.

The year 1937 has seen the extension of the principles employed in the construction of the condenser cone¹³ to an assembly of similar concentric units, which give a compact and economic type of coupling capacitor for carrier current working of transmission lines.

Dielectrics

The placing of hitherto unknown dielectric materials at the disposal of the electrical engineer is not possible every year. Much time is necessarily spent in the improvement and adaptation of existing materials to comply with the ever increasing severity of "working" conditions.

In the field of textile insulators the introduction of a fully (tri) acetylated cotton yarn, intended to meet the specific demands of a

certain long distance cable operating at high frequency, has provided the cable world with a weapon of far broader applicability. While other satisfactory high frequency dielectrics are commercially available, none combine the property of low dielectric loss with the widely known physical characteristics of the textile yarn as well as the new thread now made available to the consumer. Although tri-acetylated cellulose in the form of acetate rayon has long been adopted in the technique of insulation, its dielectric loss at high frequency is markedly inferior to the new cellulose tri-acetate in which the physical structure of the cotton thread is retained.

Partially acetylated cotton threads known to the electrical world as "Cotopa" have been progressively developed to include finer yarns suitable for the insulation of instrument wires, etc. The processing of fabrics and tapes provides a wider scope for the application of a material of proved yet steadily increasing insulation value.

In the field of paper dielectrics, the first radical change for many years was announced at the close of 1936. This covered the properties of acetylated paper providing the fibrous structure of normal cellulose paper substantially unchanged by the process treatment. The low affinity for moisture of this new product gave much promise of overcoming the slow electrical deterioration of paper insulation due to the ingress of moisture—long a problem of major importance. The past year has seen the interest of the papermaker actively aroused in the manufacture of so promising a material. The time is not far distant when another basic dielectric will be available in a vastly improved form.

The plastics dielectric field has not remained stationary; a newcomer, as yet largely untried, presents itself in the form of polymerised isobutylene. By nature it is a synthetic rubber with all the valuable physical properties of natural rubber but, in addition, it possesses the property of thermo-plasticity. The failure of bakelite and similar mouldable dielectrics to meet the present day demands of dielectric loss has led to intensive research directed to the development of improved dielectrics of this type.

A more careful study of the composition of the basic resin, particularly the nature of the filling materials employed, has resulted in the evolution of low loss compositions which will prove active competitors to the more expensive polystyrene mouldings now firmly established in the high frequency dielectric field.

The adaptation of polystyrene in the form of film and thread for use as the dielectric separator in broad band cable technique has continued during the past year. Most of the intrinsic mechanical difficulties in the application of a hard brittle dielectric of the nature of polystyrene, for use in a flexible cable, have now been overcome and the extremely efficient dielectric characteristics at high frequency of this material are now available to the cable as well as the apparatus engineer.

Considerable development has taken place recently in the refractory and ceramic dielectric field. The adoption of anhydrous magnesia with its complete resistance to fire as the dielectric medium for power cables has now become an established process in cases where fire resistance is of primary importance.

Ceramic dielectrics to replace mica in condenser manufacture are being steadily developed from two aspects of the problem: (1) the improvement of dielectric loss particularly at radio frequencies continues to receive considerable attention; (2) a great deal of development is in progress on the production of ceramic dielectrics with high values of specific inductive capacity whereby it is hoped to improve the dimensional factors of condensers. Similarly, much activity continues in the laboratory in an endeavour to produce high permittivity impregnants for paper insulated condensers and dielectric guides. The discovery that certain chemical substances can be transformed from low permittivity to high permittivity dielectrics at specific temperatures has led to intensive research to discover the ideal substance for use as a condenser impregnating material.

Past developments in the submarine cable dielectric field, whereby considerable reduction in the moisture absorption characteristics of natural rubber was effected by the removal of proteins and other non-hydrocarbon impurities, have recently led to the adoption of de-

proteinised rubber for many general rubber insulating problems. Deproteinised rubber has now become a market commodity available to all users. Similarly, the compounding of natural rubber with polymerised styrene, originally suggested for submarine cable insulation, has recently resulted in proposals for its more general adoption in the rubber insulation field.

One of the most interesting developments during the past year concerns liquid monomeric styrene, a material which on account of its peculiar property of thermal polymerisation is finding increasing use in specific insulating problems, such as, for instance, in the fabrication of power cable joints. In these cases the styrene is introduced in the liquid state and subsequently polymerised to a solid dielectric by the application of heat. The great drawback has been the tendency for monomeric styrene to autopolymerise during transport or storage unless suitably stabilised. The presence of a stabilising agent has added difficulties since it must be removed by chemical means before polymerisation can be proceeded with. A grade of monomeric styrene has now, however, been produced under the trade name of "Superstyrex" which is stable under conditions of transport and storage and yet, when heated at an elevated temperature, polymerises with no appreciable additional delay. This development will undoubtedly extend considerably the use of liquid styrene for insulating purposes.

In Memoriam

The death, in 1937, of two men of international reputation in the realm of science and communications, is regretfully recorded. The Marchese Marconi, whose name will always be associated with the development of wireless communication, was still experimenting when he passed away at the age of 63. In the field of fundamental science the passing of Lord Rutherford of Nelson brings to a close the career of a great scientist whose researches in the atomic field will continue to bear fruit in the years to come.

REFERENCES

1. "The 1937 Paris Exhibition," by P. Quéffélec, *Electrical Communication*, October, 1937.

2. "Bristol-Plymouth 12-Channel Carrier System," *Journal of the I.E.E.*, November, 1937, pp. 573-606; *Electrical Communication*, October, 1937.
3. "The Carrier Telephone and Telegraph Equipment of the New Bass Strait Submarine Cable System," by F. Ralph and R. L. Hughes, *Electrical Communication*, April, 1937.
4. "The Coronation," by F. Gill, *Electrical Communication*, July, 1937.
5. *Electrical Communication*, October, 1937, p. 180 (Rome Short Wave Broadcaster).
6. "Ultra-Short Wave Communication," by E. H. Ullrich, *Electrical Communication*, July, 1937.
7. "Ultra-Short Wave Radio Landing Beam—The C. Lorenz-A.G. Radio Beacon Guid eBeam System," by R. Elsner and E. Kramer, *Electrical Communication*, January, 1937.
8. "The Automatic Radio Compass and Its Applications to Aerial Navigation," by H. Busignies, *Electrical Communication*, October, 1936.
9. "Picture Transmission Using 'Time Modulation,'" by Masatsugu Kobayashi, *Electrical Communication*, October, 1937.
10. "Automatic Ticketing of Telephone Toll Calls," by Leslie B. Haigh; "Automatic Printing Register for Telephone Call Recording," by L. Devaux, *Electrical Communication*, April, 1937, also October, 1937, p. 180 (Automatic Ticketing).
11. Description given elsewhere in this issue of *Electrical Communication*.
12. "The Selenium Rectifier," by Erich Kipphan, *Electrical Communication*, July, 1937.
13. "Condenser Cones for Cable Testing," by J. K. Webb, *Electrical Communication*, April, 1937.

The Right Hon. Lord Rutherford of Nelson, O.M., F.R.S.

BY the death of Lord Rutherford on October 19th, 1937, at the age of 66, the world lost one of the greatest scientists of all time. Born the son of a farmer in New Zealand, he rose by his own genius and personality to the high position which he held in the realm of science. After a brilliant career at Canterbury University College, University of New Zealand, he proceeded to Cambridge with an 1851 Exhibition Science Scholarship and worked under Sir J. J. Thomson in the Cavendish Laboratory. In 1898 he was appointed Professor of Physics at McGill University, Montreal, and in 1907 he returned to England to take up the Chair of Physics at Manchester University. In 1919 he succeeded Sir J. J. Thomson as Cavendish Professor of Experimental Physics and Director of the Cavendish Laboratory at Cambridge, the position which he held at the time of his death.

Lord Rutherford's wide experience in different parts of the British Empire undoubtedly contributed largely to the development of the breadth of outlook which was one of his most marked characteristics. He was best known for his contributions to the study of radio-activity and atomic structure, but it is of interest for us to remember that his early research was in connection with the effect of high frequency fields on magnetised materials. He devised the first magnetic detector, and received messages from a distance of approximately three-quarters of a mile.

Many honours were bestowed upon him. In 1903 he was elected a Fellow of the Royal Society, and was its President from 1925 to 1930. He received a Nobel Prize in 1908 and the Order of Merit in 1925. In 1914 he was knighted and in 1931 he was created first Baron Rutherford of Nelson. In addition he received Honorary Degrees from Universities all over the world. Despite all the honours which he received and the eminent position he held, Rutherford remained extremely human. Important though his achievements in physics were, his greatest contribution to the cause of Science was in the personal influence he held over those who worked under his direction. Those of us who have had this privilege realise to some extent how greatly we are indebted to his enthusiasm and encouragement, and we know from personal experience that in his death the world has lost not only a great scientist but a very great man.

EDITOR'S NOTE.—This brief appreciation of the late Lord Rutherford of Nelson was contributed by D. H. Black, who probably has the unique distinction of having studied at the same school (Nelson College) and the same university college (Canterbury University College, New Zealand) as did Lord Rutherford, and of having carried out research under him at the Cavendish Laboratory, Cambridge. Other former research students of Lord Rutherford, attached to the Valve Division of Standard Telephones and Cables, Limited, together with D. H. Black, are W. T. Gibson, J. H. Fremlin and D. R. Petrie.

Carrier Telephony and Telegraphy on The Argentine State Railways

By C. F. BULSTRODE WHITLOCK,

Compañía Standard Electric Argentina, Buenos Aires, Argentina

THE Argentine Republic owns considerable railway property: in Patagonia, 1 304 km of broad (5' 6") gauge track; in the Province of Entre Ríos, 560 km of standard (4' 8½") gauge; and in the Northern provinces, 7 040 km of metre gauge. It also owns mileage of 75 centimetre gauge in Patagonia. The Administration Headquarters of these State Railways is located in the Federal Capital, the City of Buenos Aires, to which none of these railways as yet has access. The nearest and most important terminal is Santa Fe, which is situated approximately 490 km to the north and which is the terminus of the metre gauge property known as the Argentine Central Northern. This system, as already indicated, operates 7 040 kilometres of track, involving 418 stations, 590 locomotives, 316 passenger vehicles, 390 parcel and baggage cars, as well as 11 170 freight cars, without counting service vehicles. During 1934, according to the last officially published statistics, it carried 2 340 229 passengers involving 153 513 518 passenger-kilometres and 4 197 234 tons of freight, equivalent to 1 532 023 260 ton-kilometres.

It will be appreciated that the communication problem of such a system is of considerable importance. Prior to September, 1917, all wire communication was effected by telegraph. At that date, Standard Electric telephone train despatching equipment was installed on existing iron wire lines between Santa Fe and Bandera, a distance of 400 kilometres, with the despatcher's or control office located at San Cristóbal. Although excellent results were obtained no funds were available for further extension until October, 1922, when a contract was placed for extending the system to cover the following lines: Santa Fe to Tucumán, Salta, Jujuy and Embarcación; Añatuya to Resistencia and Tintina; Santa Fe to Cruz del

Eje, Córdoba and San Juan. In this case most of the wire plant erected was of hard drawn copper. Since then, additional train despatching equipment has been installed so that very little mileage without this facility exists; in fact, it is included as standard equipment whenever a new branch is built.

The problem remained, however, of improving communications between the Administration in Buenos Aires and the Central Northern system. Messages between Buenos Aires and Santa Fe were handled over a single telegraph wire which was leased from the National Posts and Telegraphs, and which was entirely inadequate for the purpose. Arrangements were subsequently made with the latter whereby a No. 8 B & S copper pair was erected on an existing pole line between Buenos Aires and Santa Fe and the circuit was composited for telegraph working. The railway was thus given the use of the pair for telephony and one of the conductors for telegraphy. Before the circuit was completed the application of carrier telephony was suggested to the Administration and a contract was executed for the installation of a DA-1 single channel telephone system with terminals at Buenos Aires and Santa Fe. This system was placed in service in December, 1933.

As is often the case, the enjoyment of good telephone facilities and the resulting economic advantages provoked a desire for further extension and, in March, 1934, the Administration, under the very able and progressive management of Engineer Pablo Nougués, charged their Chief of Telegraphs, Engineer Manuel Burzaco, with the study of an extension towards Tucumán. As originally engineered the plan involved the installation of copper wire throughout and the employment of voice frequency repeaters. In the meantime, however, the design by the Standard Electric

Laboratories of a by-pass filter for use at the intermediate way stations, capable of manufacture and sale at a price considerably lower than that of the normal by-pass equipment previously available, made the economic application of carrier communication principles to train despatching circuits possible. This development was brought to the attention of the railway Administration, and the purchase of copper wire for the proposed circuit between Santa Fe and Tucumán was held up since it was realised that considerably more could now be achieved with the funds appropriated.

As a result of further study the railway's communication engineer was able to propose a scheme whereby, without the erection of any additional conductors, it became possible to link up Buenos Aires, via Santa Fe, with the other main divisional points of Añatuya, Tucumán, and Cruz del Eje. Complementary to the foregoing, by the erection of some 50 kilometres of circuit between Santa Fe and Diamante and 40 kilometres between Santa Fe and Laguna Paiva, it became possible, by means of switching arrangements at Santa Fe, to embrace in the scheme both Diamante, the

terminal of the Eastern Railway in the Province of Entre Ríos, and Laguna Paiva, where very large Central Northern workshops and stores are located. Of the other points mentioned, Añatuya is a junction of increasing importance. Tucumán is the headquarters of the Northern Division with large workshops and stores at Tafí Viejo close by, and Cruz del Eje is the centre of the Western Division, also with its workshops and stores. A further and most interesting facility was also offered, taking the form of voice frequency carrier telegraphy superimposed on a carrier telephone channel.

The Administration, after studying the advantages to be derived by more direct and personal control, the resultant economies, and, further, the very desirable telegraph facilities obtainable, in July, 1934, signed a contract for the

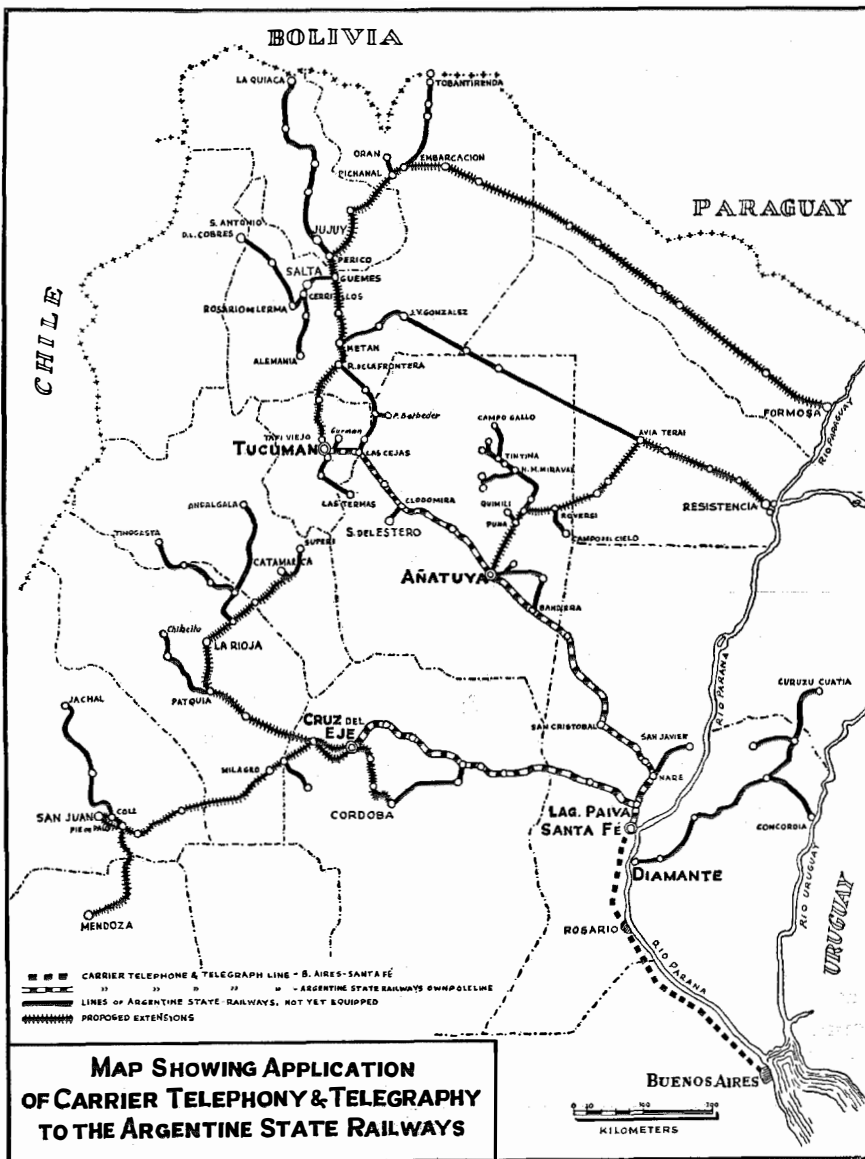

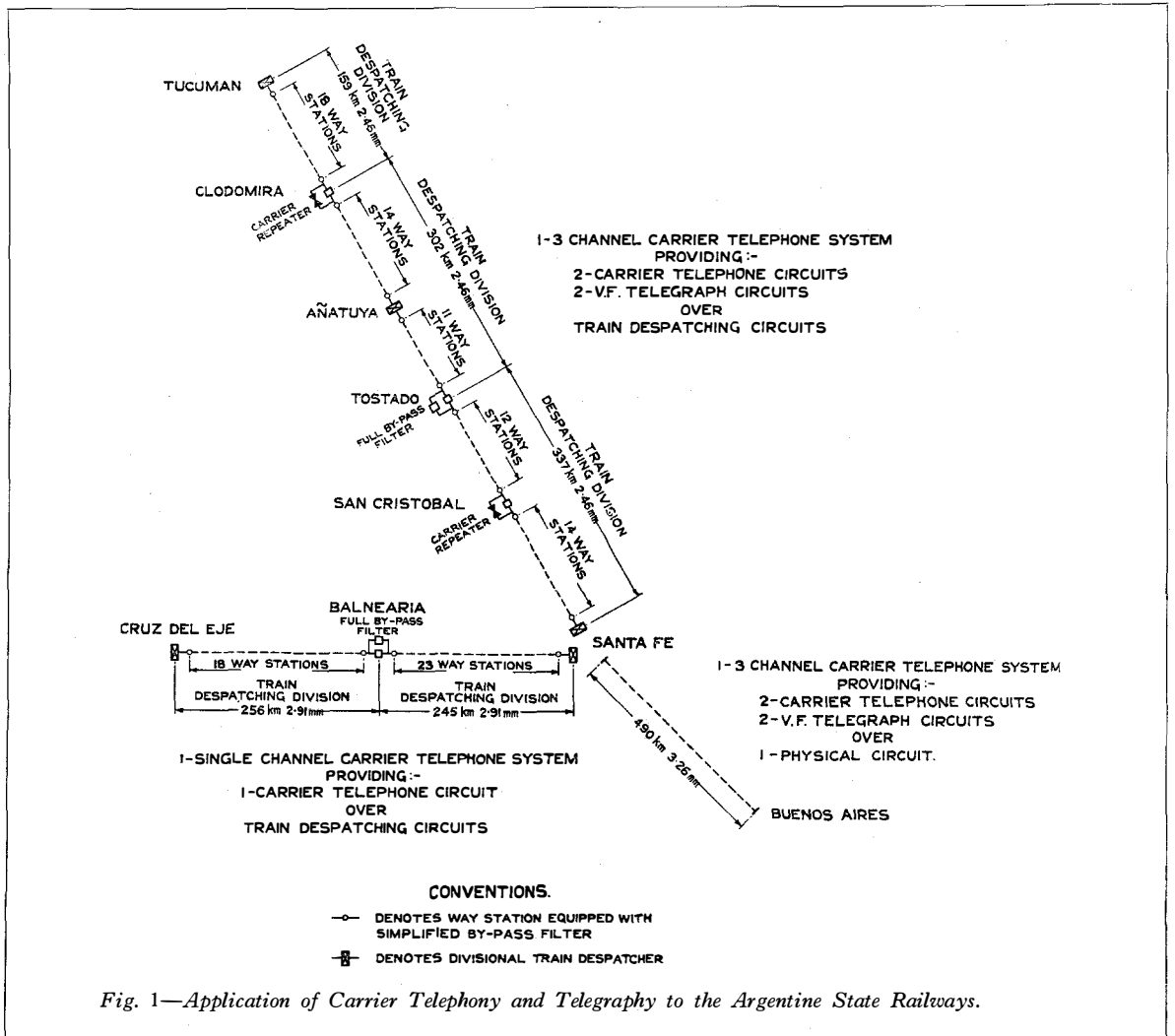

entire scheme of which the following is a synopsis :

Telephony :

1. Replacement of the existing DA-1 single channel system between Buenos Aires and Santa Fe by a type "C" 3-channel system.
2. Provision of a 3-channel system between Santa Fe and Tucumán with intermediate terminals at Añatuya and repeaters at San Cristóbal and Clodomira, utilising available 150 lb. train despatching circuits.
3. The application of the DA-1 single channel system, previously installed between Santa Fe and Buenos Aires, to the

existing Santa Fe-Cruz del Eje No. 9 B & S copper train despatching circuit.

4. The provision of way station filters necessitated by superimposing carrier working on the existing train despatching circuits.
5. The provision of a manual switchboard at Santa Fe for handling the switching of the long distance traffic involving Buenos Aires, Santa Fe, Diamante, Laguna Paiva, Añatuya, Tucumán and Cruz del Eje.

Telegraphy :

The provision of a 2-channel voice frequency carrier telegraph terminal at Buenos Aires, Santa Fe (two terminals, one north and one south) and Tucumán. This equipment enables

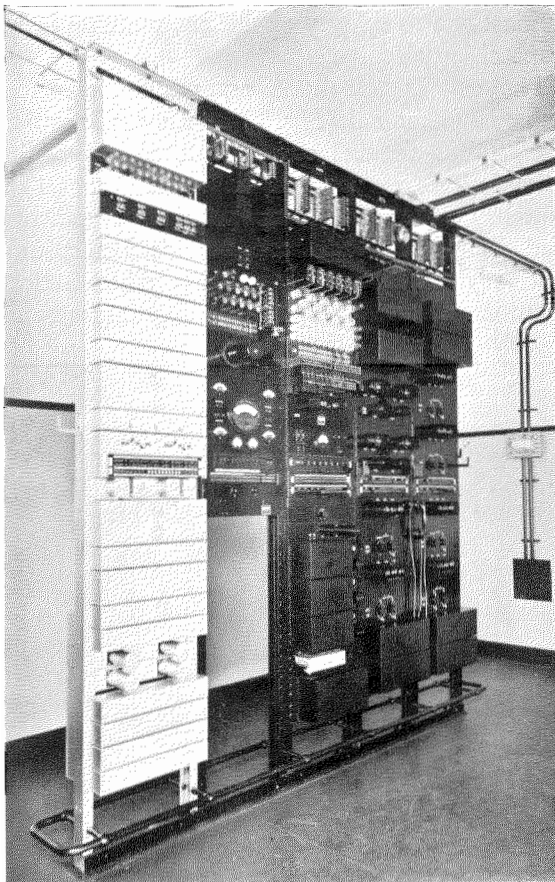

Fig. 2—Buenos Aires Terminal, Showing 3-Channel Telephone System Bays, Test Bay and V.F. Telegraph Bay.

direct telegraphic communication to be obtained between the above places and, when required, Buenos Aires can also work simultaneously with Santa Fe and Tucumán. The equipment was required to work superimposed upon any of the carrier telephone channels between Buenos Aires, Santa Fe and Tucumán in lieu of the telephone facility.

The distances and conductors involved are as follows :

Section	Circuit	Kilometres
Buenos Aires-Santa Fe	3.26 mm Copper	490
Santa Fe-San Cristóbal	2.46 mm Copper	197
San Cristóbal-Añatuya	2.46 mm Copper	277
Añatuya-Clodomira	2.46 mm Copper	165
Clodomira - Tucumán	2.46 mm Copper	159
Santa Fe-Balnearia	2.91 mm Copper	245
Balnearia-Cruz del Eje	2.91 mm Copper	256

Total overall distance—Buenos Aires-Tucumán, 1 288 kilometres.

Total overall distance—Buenos Aires-Cruz del Eje, 991 kilometres.

The following train despatching divisions were involved : Santa Fe—Tostado, Tostado—Añatuya—Clodomira, Clodomira—Tucumán, Santa Fe—Balnearia, and Balnearia—Cruz del

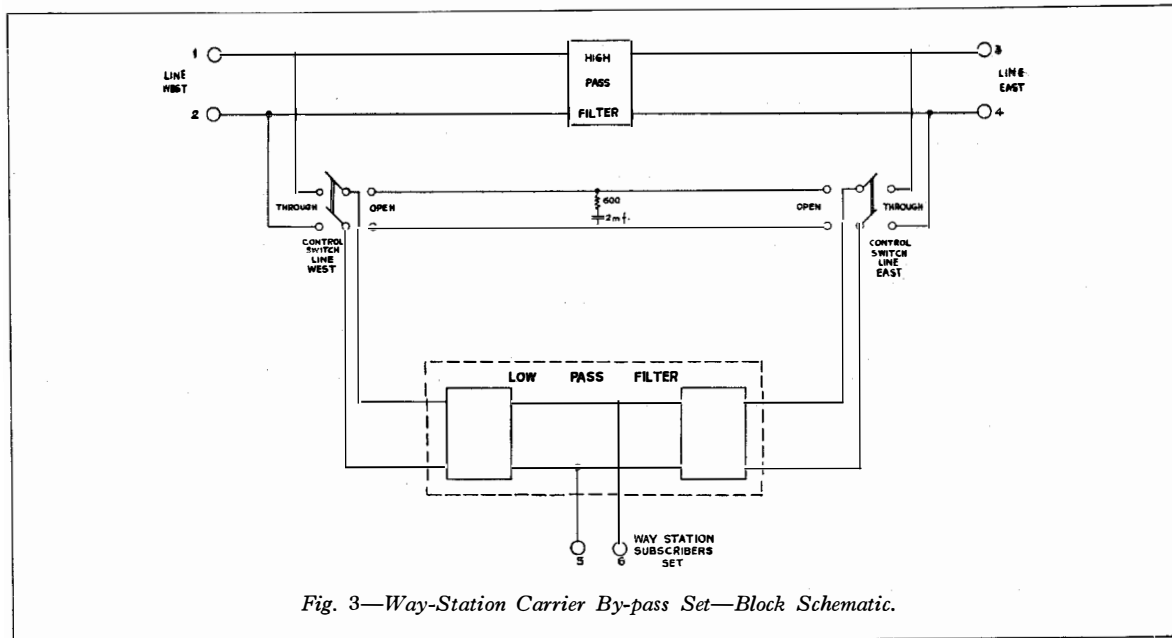

Fig. 3—Way-Station Carrier By-pass Set—Block Schematic.

Eje. A line chart showing the application of carrier telephony and telegraphy to the train despatching circuits is shown in Fig. 1.

It will be appreciated from the foregoing that the programme was important and ambitious. Furthermore, the Administration started this programme at a time when nothing so vast had been undertaken in connection with the application of carrier telephone and telegraph com-

munications to railway operation, utilising train despatching circuits.

The carrier telephone equipment for each 3-channel terminal (Fig. 2) consists of regular type "C" 3-channel components assembled in simplified form mounted on 3 standard 10 ft. 6 in. bays, the more complicated arrangements used in public telephone service being unnecessary in the case of the railway installation inasmuch as no extensions of any importance

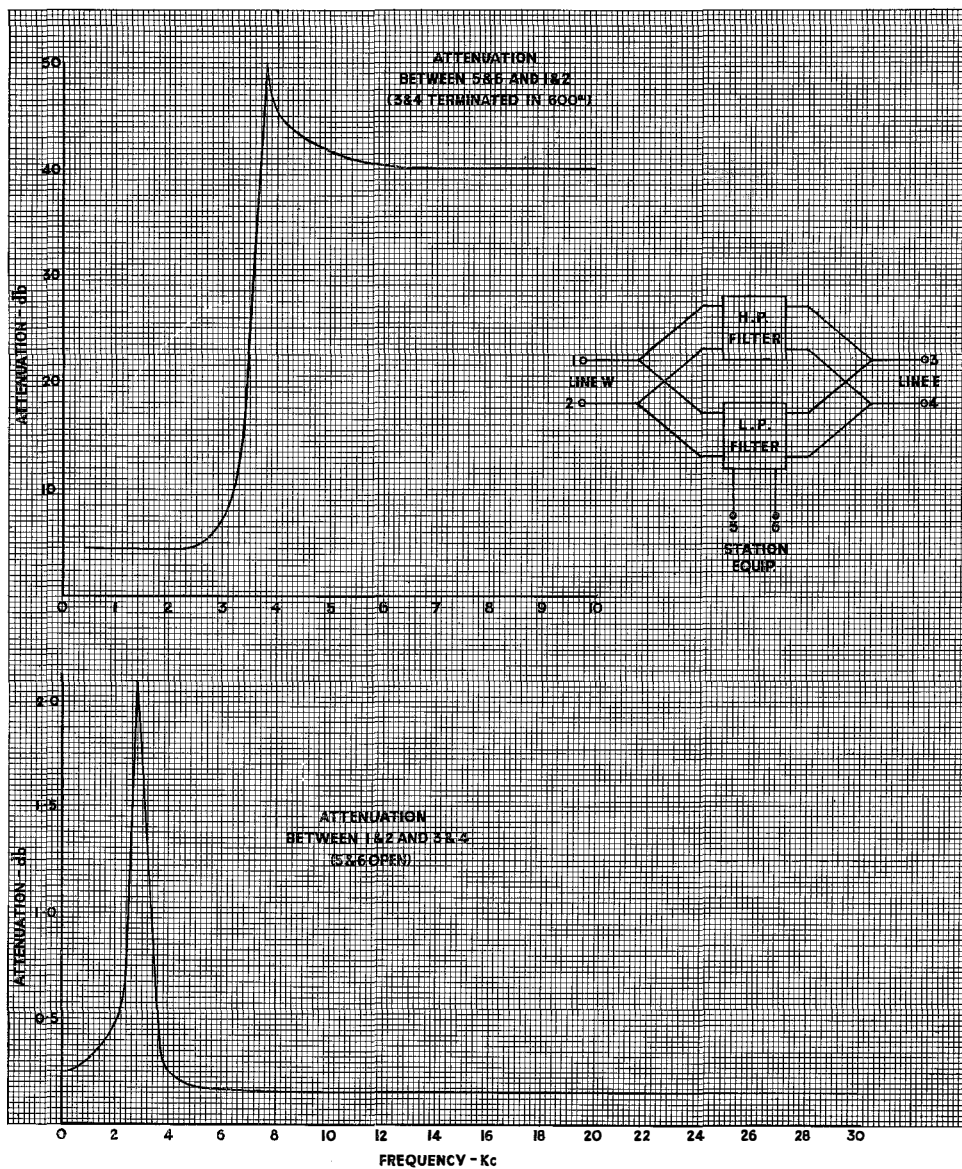

Fig. 4—Way-Station Carrier By-pass Set Frequency—Attenuation Curves.

at any one point are anticipated. Similar simplified arrangements are used at the repeater stations, San Cristóbal being equipped with a high gain repeater and Clodomira a low gain repeater. At both Santa Fe and Añatuya two terminals were supplied; one North and one South, to allow for switching and connections to other points. The DA-1 single channel equipment used between Santa Fe and Cruz del Eje is so familiar that it requires no special comment.

The voice frequency carrier telegraph equipment is of the individual oscillator-per-channel type and is mounted on bays with capacity for four channels. It has been previously described.*

The way station by-pass filters are interesting, comprising a high pass and a low pass filter with the connection for the way-station voice frequency equipment tapped off in the centre of the latter. They are equipped with two double-pole, double-throw switches to which the incoming and outgoing line wires are connected as shown in Fig. 3. These switches are used primarily for the location of faults and when one is operated the line is disconnected and, at the same time, a simple compromise network is connected to the end of the low-pass filter nearest the open line, thus maintaining a correct termination for the low-pass filter and enabling communication to be maintained both over the carrier circuit and over the sections of the traffic control circuit between the despatcher's station and the particular way station in question. The carrier circuit, it will be realised, is not opened by the operation of either of the switches.

The curves of Fig. 4 show the losses caused by the insertion of these filters for both carrier and voice frequency conditions.

At Tostado, since it is an inter-divisional station for both the Santa Fe and Añatuya train despatching divisions, a full by-pass filter has been provided in order to entirely prevent interference between the operations of either division.

At all terminal and repeater stations, the power plants consist of single batteries full-floated from either dry rectifiers or motor

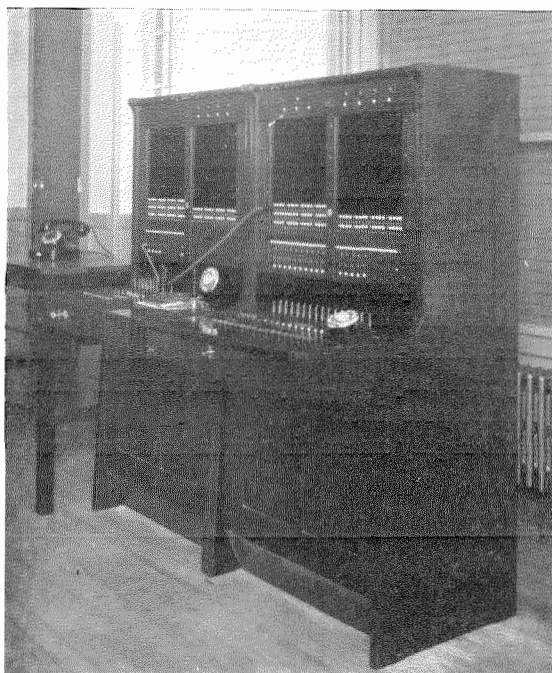

Fig. 5—Buenos Aires No. 7055 P.A.B.X.—Attendant's Board. The Long Distance Position is on the Left.

generators, as required by the local power supply available. The rectifiers and motor generators are duplicated as a precaution against failure.

At the Buenos Aires terminal, the Administration's headquarters, the carrier and voice frequency circuits are terminated on the attendant's board of a No. 7055 type P.A.B.X. (Fig. 5) manufactured by the Bell Telephone Manufacturing Company, Antwerp. This P.A.B.X. is equipped for 100 lines with tie lines to other switchboards, thus making the long distance network of the railway available to all the various departments of the Administration.

Installation was commenced in February, 1935, and completed in September, 1936, many delays intervening, partly arising from difficulties occurring in the field and partly from purely administrative reasons. A particular difficulty arose from damage to the way-station filters by lightning storms of most unusual severity, whereupon it was deemed advisable to make special arrangements to guard against recurrence, and also to facilitate the identification of a faulty filter. The equipment was placed in service section by section, and from practical experience there is now no doubt whatsoever that it is satisfactorily accomplishing

* "A New Voice Frequency Telegraph System," by J. A. H. Lloyd, W. N. Roseway, V. J. Terry and A. W. Montgomery, *Electrical Communication*, April, 1932.

its purpose, whether in telephony or telegraphy. There is no interchannel interference and, despite abnormal weather and casual line faults, the all-round stability of the carrier circuits has been remarkable. The circuit between Buenos Aires and Tucumán operated on one particular occasion, both on telegraphy and telephony, under excessive conditions of humidity, with one of the physical conductors cut at three different intermediate points, when over the Buenos Aires-Santa Fe section it was impossible to operate any of the physical circuits sharing the same pole line.

This highly interesting installation represents

the first in the world in which carrier telephony on so vast a scale has been applied to train despatching circuits. Over 1 788 kilometres of physical circuits and 4 262 telephone channel-kilometres as well as 2 574 voice frequency telegraph channel-kilometres are involved. It is specially interesting to note how readily the railway's staff has adapted itself to the maintenance of equipment entirely foreign to its previous experience. Much of the success attained is due to the keenness and interest of the personnel when confronted with the difficulties and problems that from time to time have arisen.



Fabbrica Apparecchiature per Comunicazioni Elettriche Stand at the Milan Aeronautical Exhibition (2nd-17th October). Aircraft sets manufactured by F.A.C.E. were shown. Included also were the R.9 Homing Device and the RC.5 Standard-Busignies Automatic Radio Compass.

Reduction of Night Error in Radio Direction-Finding Equipment for Aerodromes

By H. BUSIGNIES,

Les Laboratoires, Le Matériel Téléphonique, Paris, France

(1) INTRODUCTION

(1.1) General

THE art of radio-goniometry or direction-finding may be said to have originated in the work of Blondel about 1902, in connection with the directional properties of spaced aerials in general, followed by the evolution of the large frame aerial type of directional receiver by Bellini, Tosi, and others prior to the development of the valve amplifier. With the advent of the amplifier it became possible to reduce considerably the size of frame aerial required for practical use, though still further work was necessary to improve the accuracy, in which connection the name of Mesny must be mentioned. At the present time the frame aerial or "loop" type of direction finder is extensively employed in one form or another for marine and aircraft navigation purposes. Development in this line is still proceeding, and recent years have witnessed the introduction of the "automatic radio compass," of particular value on board aircraft, by which the direction of a transmitting station is automatically indicated with no further operation than tuning in to the station.

The scope of the frame aerial radio direction finder is nevertheless inherently limited by what is usually referred to as "night error," which makes it difficult and sometimes even impossible to obtain reliable directional bearings at night beyond a comparatively short distance. A rather similar error generally referred to as "aeroplane effect" is also encountered, both by day and night, and renders unreliable bearings taken from the ground on an aircraft transmitting station unless the latter is flying directly towards or away from the direction-finding station. These two errors seriously affect the value of the frame aerial type of direction-finder, particularly for aerodrome work.

The direction of a transmitting station may be obtained by orienting the plane of a vertical frame aerial so that it is in line with the station, as shown by the received signal being a maximum; or by orienting the plane so that it is at right angles to the line of direction, in which case the received signal is a minimum. In practice the latter method is always adopted (apart from the rather specialised case of the automatic compass), since adjustment for a minimum signal can always be more accurately determined than for a maximum signal. It is obvious that in order to obtain really sharp directional bearings the minimum signal must be very small indeed compared with the maximum signal.

Factors which depreciate the maximum/minimum signal ratio are: (a) interference, (b) set noise, and (c) unwanted components of the desired signal. The first factor, interference, affects all types of direction-finder, and is dealt with by incorporating a high degree of selectivity in the receiver portion of the equipment. The second factor, set noise, is also common to all types of equipment but can be minimised by careful attention to the design of the receiver, choice of valves and valve operating conditions. The third factor, unwanted components of the desired signal, is a function of the signal collector system, and is responsible for both night error and aeroplane error when the collector system is of the frame aerial type, whether using a single rotating frame or two fixed frames in space quadrature combined by a goniometer.

Another type of direction-finding system is that in which the signal collector is not a frame aerial, large or small, but an arrangement of spaced open vertical aerials. This arrangement, invented by Adcock some eighteen years ago, has the disadvantage that it requires a fair amount of space for the aerials, and is con-

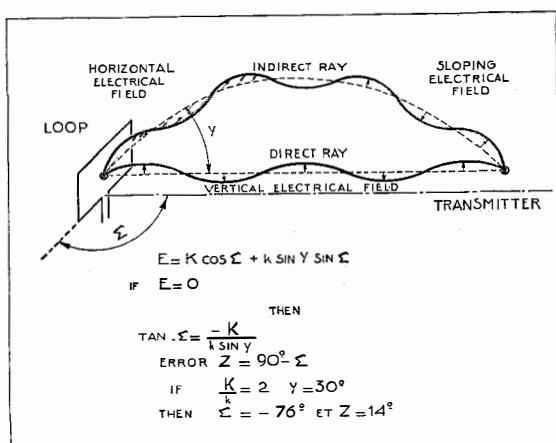

Fig. 1—Illustrating the Night Error in a Loop Aerial.

sequently unsuitable for use on board ships and aircraft. It has however the great advantages that it is inherently free both from "night error" and from "aeroplane error," and the increasing necessity for accurate and reliable radiogoniometry both by day and by night has led to its general acceptance as the best system for ground direction-finding stations, and in particular for aerodrome stations whose function is to determine the position of aircraft in flight.

While the principle underlying the Adcock collector system is simple, its application to practice involves a number of by no means inconsiderable difficulties. It was therefore almost totally neglected for some years. The manner in which these difficulties are overcome is discussed below in connection with the description of the Standard-Adcock Direction-Finder, an equipment which has been specially designed to enable full advantage to be taken of the Adcock principle and its attendant freedom from "night" and "aeroplane" errors.

(1.2) Night Error

Night error when using a frame aerial direction-finder is characterised by a more or less rapid change in the apparent direction of the station under observation, frequently combined with such a blurring of the signal minimum that it becomes difficult to detect it at all.

The source of this error is the reception by the frame aerial of a signal wave which has not followed the normal ground path between transmitting and observing station, but has been radiated skyward and then reflected from

the ionosphere towards the direction-finder. Though the properties of the ionosphere have not been studied in the same detail for the medium-wave band, normally used for direction-finding services (100 kc to 600 kc) as for the bands used for short-wave communication, etc., there is ample evidence that during the daytime waves of these medium frequencies are absorbed without reflection and therefore do not reach the ground again, while at night they are reflected with good efficiency, and may be very troublesome in causing fading and in disturbing direction-finding.

The reflected wave differs from the direct wave in two important points:

- (1) The wave front instead of being vertical is tilted, arriving with an angle of incidence between 10° and 70° ;
- (2) The electric field instead of being polarised wholly in a vertical plane through the line of propagation is frequently skewed and has therefore a horizontal component in the plane of the wave front.

Fig. 1 shows diagrammatically a transmitter source, the direct wave from which reaches a receiving frame with the electric field polarised vertically in the usual manner, together with an indirect wave in which, as an extreme case, the electric field is completely polarised horizontally in the plane of the wave front. The plane of the receiving frame aerial is at right angles to the direction of propagation. There is therefore no e.m.f. induced by the direct wave in the frame as a whole, since the wave front strikes both the vertical conductors simultaneously and induces in them equal and cancelling e.m.f.'s. If the indirect wave arrived with its electric field polarised in the vertical plane through the line of propagation, it also would induce equal and cancelling e.m.f.'s in the vertical conductors, and would not create any current in the frame. Since, however, the indirect wave has its electric field polarised horizontally in the plane of the wave front, and since the wave front is tilted, e.m.f.'s will be generated in the two horizontal conductors of the frame in opposite circuit directions but not of equal magnitude; they would be of equal magnitude only if the plane of the frame were tilted to coincide with the plane of the wave front. There will therefore be an

effective e.m.f. acting round the frame as a whole, giving a signal response despite the fact that the frame is oriented to receive nothing from the direct wave. If the frame aerial were rotated around a vertical axis, it would not cease to pick up from the horizontally polarised indirect wave until it had been turned through 90° , i.e., until it had reached the position for maximum pick-up from the direct wave. Under these conditions it is obvious that the direction of the frame for minimum signal must be displaced from its correct setting. If we assume that the directed and reflected waves arrive in time phase, we can write :

$$\begin{aligned} E_1 &= K \cos \sum \\ E_2 &= k \sin \sum \sin \gamma \end{aligned}$$

where E_1 = e.m.f. due to direct wave ;
 E_2 = e.m.f. due to indirect wave ;
 \sum = angle between plane of frame and direction of propagation ;
 γ = angle between arriving incident wave and ground.

The total e.m.f. round the frame aerial, therefore, is :

$$\begin{aligned} E &= E_1 + E_2 \\ &= K \cos \sum + k \sin \sum \sin \gamma \\ &= 0 \text{ when } \sum = \tan^{-1} \frac{-K}{k \sin \gamma} \end{aligned}$$

If the amplitude ratio of the direct to the indirect waves is two to one, and $\gamma = 30^\circ$, then the minimum is obtained at $\sum = -76^\circ$ instead of 90° —an error of 14° . The position of this minimum would be well marked, since the two waves were assumed to be in phase. In practice the reflected wave must be regarded as arriving with random phase, and the minimum is usually not sharply defined but rather blunt ; sometimes the variations in signal strength when the frame is rotated are so slight that reception might almost be described as of constant strength.

Owing to irregularities in the reflecting surface presented by the ionosphere there may be more than one wave reflected towards the direction finder. The effect of each wave may be analysed in the manner outlined above, and the horizontal electric components of the downcoming wave fronts summed to give the total interference.

If the frame aerial is at some height above badly conducting ground the effect becomes still further complicated as regards the relation between the phase of the direct wave and the phase and angle of incidence of the reflected waves. The principle underlying night error remains unaffected, however, and in substance is that illustrated by Fig. 1 ;—the error is due to a wave having in combination two special features (*a*) a tilted wave front containing (*b*) a horizontal component of electric field. Neither feature by itself would give rise to error—it is the combination which is harmful.

It follows from the above that the ratio of the indirect wave to the direct wave is of prime importance in that it fixes the possible magnitude of the night error. With ground transmitting stations the error may appear at quite short distances, due to the rapid attenuation of the ground wave, and there is something to be gained by using anti-fading aerials, i.e., aerials in which the horizontal radiation is improved and the skyward radiation reduced. Using the normal type of transmitting aerial, night error becomes evident on medium waves at distances of 70 km to 100 km over land ; with an anti-fading aerial, this distance may be about doubled.

In the case of transmission over sea the attenuation of the ground wave is far less rapid than over land, since the path traversed is both more even and of higher conductance. The distance at which night error begins to be appreciable is accordingly greatly increased, and may easily be as high as 200 km even with the normal transmitting aerial. The problem of night error is therefore much less serious in marine work than in the case of a ground station receiving from aircraft. Incidentally the use of direction-finders at sea in connection with radio beacons is usually restricted in any case to distances not greater than 200 km.

Over land the magnitude of night error at comparatively short distances may be serious ; on a wavelength of 900 metres, an error of $\pm 20^\circ$ at a range of 100 km is not uncommon when a frame aerial direction-finder is used.

(1.3) *Aeroplane Error*

Aeroplane error, experienced with frame aerial direction finders, is very similar to night error

in its nature and causes. It arises from the fact that, for communication on the medium wave-band, aeroplanes usually transmit on a trailing aerial. Since this aerial is largely horizontal the electric field radiated therefrom has a large horizontal component. The wavefront reaching the direction-finder is tilted, owing to the altitude of the plane. If the aircraft is flying at right angles to the line joining it to the direction-finding station, the horizontal component of the electric field (being parallel to the trailing aerial) will also be in the plane of the tilted wave front. We therefore have exactly the same conditions as shown for the indirect wave in Fig. 1, with an e.m.f. acting round the frame through the horizontal conductors if Σ is made equal to 90° , or through the vertical conductors if Σ is made equal to zero. In these circumstances it is impossible to get a true bearing. If, on the other hand, the aircraft is flying towards or away from the observing station the horizontal component is not in the plane of the wave front but parallel to the vertical plane of propagation, and cannot induce any current in the frame aerial if Σ is made 90° . In these circumstances a true bearing will be obtained. For courses in between the two extreme cases mentioned there will always be some horizontal component in the tilted wave front acting on the frame aerial, and the minimum will be more or less displaced from its correct position. Since the error varies with the tilt of the wave front (i.e., with angle γ , Fig. 1) it will vary with course, altitude, and distance of the aircraft.

It should be noted that this type of error occurs when receiving the direct wave from the aircraft, and is therefore encountered even during the day. During the hours of darkness the normal night error due to an additional indirect wave reflected from the ionosphere may be superposed on the aeroplane error itself, making direction finding of aircraft at night very unreliable indeed, if frame aerial reception is used.

(1.4) The Adcock Collector System

It has been shown above that in a frame aerial signal collector both night and aeroplane errors arise from the fact that the frame aerial will respond to any horizontal component of

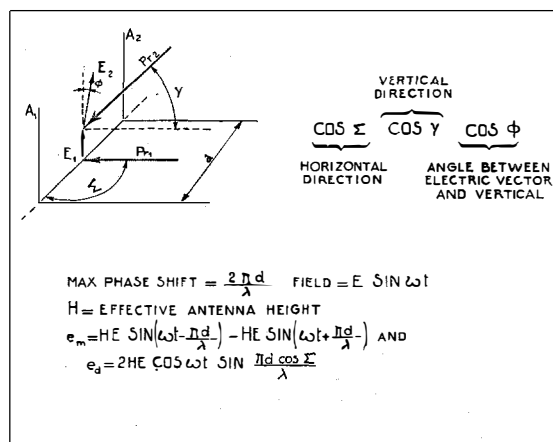

Fig. 2—Principle of the Adcock Aerial System.

electric field in the plane of a tilted wave front. A collector which does not respond at all to horizontal components of the electric field should therefore be free from both types of error. The Adcock collector system, which is based on the use of a pair of spaced vertical aerials, responsive only to the vertical components of electric fields, meets this condition exactly. The main difficulties which so long delayed practical application of the system have been associated almost entirely with the avoidance of horizontal pick-up in the horizontal leads connecting the aerials to the receiver, etc.; it is only recently that these difficulties can be said to have been fully overcome.

Referring to Fig. 2, A1 and A2 are vertical aerials constituting an Adcock pair. A wave arrives with horizontal direction Pr_1 , making an angle Σ with the vertical plane containing the two aerials, and has a vertical electric field E_1 . If $\Sigma = 90^\circ$, the two aerials are energised at the same time and therefore in phase, and will deliver no signal to a receiver to which they are oppositely connected. If, on the other hand, the direction of propagation is changed to coincide with the plane of the aerials ($\Sigma = 0$), the field still remaining vertical, aerial A1 is energised before aerial A2 or vice versa, the phase difference being $\frac{2\pi d}{\lambda}$, where d is the

distance between the aerials and λ the wavelength, and despite the opposite connection of the aerials there remains a definite voltage which can be applied to the receiver.

By rotating such a system of aerials we

could therefore obtain a directional effect similar to that obtained by rotating a frame aerial. In order to obtain sufficient pick-up, however, it is necessary to use an "open" system, i.e., one, say, with antennae 10 to 20 metres in height and suitably spaced. Physical rotation of such an aerial assembly is obviously impracticable. Recourse is therefore had to the use of two such fixed pairs of aerials in space quadrature, connected through a goniometer, and the direction of propagation of the signal is obtained by swinging the rotor of the goniometer in the same manner as when two fixed frame aerials are used.

Referring again to Fig. 2, let us assume that an additional and indirect wave arrives with a direction of propagation Pr_2 inclined at an angle γ to the horizontal, and with an electric field which is of course always perpendicular to the direction of propagation but is also skewed at an angle ϕ to the vertical. In this case we find the response characteristic quite different from that of a frame aerial. Provided that the directions of propagation of the direct and indirect waves are in the same vertical plane (horizontal projection of Pr_2 coincident with Pr_1) there is no error whatsoever, since the overall directivity of the two-aerial system referred to the relevant angles is proportional to:

$$\cos \sum \cos \gamma \cos \phi .$$

Here $\cos \sum$ and $\cos \gamma$ represent respectively the horizontal and vertical directivity relative to the direction of propagation of the wave front, while $\cos \phi$ represents the directivity relative to the electric field.

All the advantages of the spaced vertical aerial system can be deduced from the foregoing expression, which passes through zero, corresponding to extinction of the signal, when any one of the direction-cosines passes through zero. If we neglect completely the direct field, the only vector which characterises the horizontal directivity is the horizontal component of the direction of propagation of the wave front. Whatever may be the angle of the electric field, we get a radiogoniometric extinction of the signal when the plane of the vertical aerials is perpendicular to the horizontal component of the direction of propagation.

Thus, unlike the case of the frame aerial, skewing of the electric field cannot in this case create any error. Neither can the superposition of direct and indirect waves create an error.

The e.m.f. available for the receiver from a two-aerial system is obtained as follows:

Let $E \sin \omega t =$ vertical electric field horizontally propagated:

The nett induced e.m.f. is of the form:

$$e_m = HE \sin \left(\omega t - \frac{\pi d}{\lambda} \right) - HE \sin \left(\omega t + \frac{\pi d}{\lambda} \right).$$

where $H =$ effective height of each aerial,
 $d =$ distance between aerials,
 $\lambda =$ wavelength.

The variation of this e.m.f. as a function of \sum is given by:

$$e_d = 2 HE \cos \omega t \sin \frac{\pi d \cos \sum}{\lambda} .$$

When d is small compared with λ , as is usually the case, we may replace $\sin x$ by x , and the expression simplifies to:

$$e_d = \frac{2 HE \pi d}{\lambda} \cos \omega t \cos \sum .$$

Note that the angles γ and ϕ are such as to satisfy the condition that the electric field E_2 is perpendicular to the direction of propagation Pr_2 .

The spaced-aerial system of collector is thus entirely free from both the normal night error and the aeroplane error previously discussed. There remains only a small residual error sometimes encountered at night, when the horizontal component of the direction of propagation of the indirect wave may make a small angle with the true horizontal direction. This deviation of the indirect ray, arising from irregularities in the equivalent reflecting surface of the ionosphere, is very much smaller than the night error encountered with frame aerial collectors due to horizontal components of the electric field.

It will be clear from the foregoing that the Adcock collector system is, in virtue of its freedom from both night and aeroplane errors, eminently suitable for aerodrome direction finding stations. In addition to its freedom

from the errors just mentioned, the system has the further advantage that it enables bearings to be taken even on the indirect ray alone; its effective range is therefore not limited by the attenuation of the ground wave, but extends to the night (reflected wave) range of the transmitting station, which may be far greater than the (direct wave) day range.

While a frame aerial is inherently balanced in itself, an Adcock system must be balanced up very carefully. Two opposed aerials connected in opposition will not give a satisfactory directive nul unless the amplitudes of the e.m.f.'s induced in the two aerials are nearly equal; otherwise, excess reception in one aerial as compared with the other will result in an ill-defined minimum and correspondingly unsatisfactory operation.

It is also important that the e.m.f.'s induced in the four aerials be transmitted with unchanged phase relationship to the central point, where the bearing is determined by operation of the goniometer. A relatively small alteration of phase difference in this transmission produces a considerable error when the spacing between the opposed aerials is small compared with the wavelength. With reduced aerial spacing, the phase difference between the induced e.m.f.'s in the two aerials becomes smaller and the importance of the fixed transmission phase displacement increases correspondingly. The aerials are therefore placed fairly widely apart—about 1/10 of the

wavelength. Despite this precaution, it is necessary to obtain:

- (a) A maximum amplitude unbalance of 1/100 of the total electromotive force for a satisfactory radiogoniometric minimum extinction (40 db below the maximum); or a maximum unbalance of 1/1 000 if a really good minimum is required. (As explained later, the amplitude unbalance may be largely eliminated by a compensator;)
- (b) Transmission of the e.m.f.'s to the goniometer with relative phase shift not exceeding a few tenths of a degree—a requirement presenting some difficulties. For a wavelength of 900 metres and an aerial spacing of 80 metres, the maximum permissible relative phase shift from all causes should not exceed half a degree.

In the earlier forms of the Adcock collector system the vertical aerials were connected to the goniometer by long horizontal "lead-in" conductors, the latter being sometimes shielded. These horizontal conductors were naturally very liable to pick up from horizontal components of the electric field, and had to be particularly well screened and otherwise rendered inactive. A method frequently used was to allow two equal e.m.f.'s to be induced on the conductors in phase opposition; but this method involved extreme care in arranging the conductors symmetrically relative to the goniometer location, and it was difficult to maintain satisfactory phase opposition over a sufficiently large waveband.

A more satisfactory form of the Adcock collector, originated in England, makes use of a two conductor open-wire line for connecting the vertical aerials to the centre point. Even in this case, however, the system is liable to horizontal pick-up unless the conductors of the open-wire line are very well balanced.

Another form, that developed by Les Laboratoires, L.M.T., and Standard Telephones and Cables, Ltd., incorporates a different principle. Each vertical aerial is directly connected to earth through the primary of a high frequency transformer located at the base of the aerial. Between primary and secondary

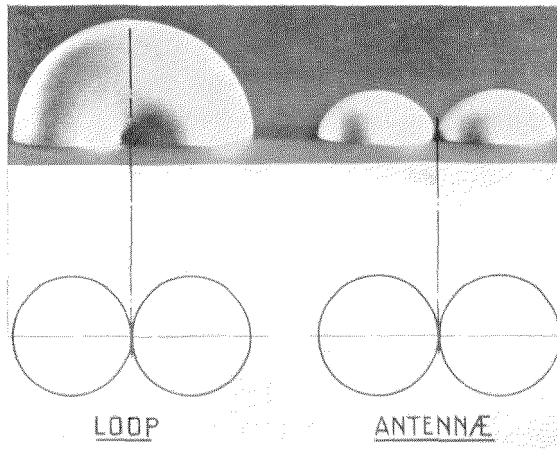

Fig. 3—Radiation Diagrams, Loop and Vertical Aerial Systems.

of the transformer is an electrostatic screen. The secondary winding of the transformer is connected to the goniometer by means of a lead sheathed transmission line, which may be either buried or simply laid on the surface of the ground, and which is completely devoid of pick-up from external sources.

This method of connecting the aerials has been found ideal, and has been incorporated in the Standard-Adcock series of direction finders. Each aerial operates entirely independently of the others, and the transmission lines can be allowed to follow any convenient path without regard to considerations of symmetry.

(1.5) Radiation Diagrams of Frame and of Spaced Vertical Aerial Systems

In the argument developed above the two types of collector system have been viewed strictly from the reception standpoint. The same conclusions can be reached from consideration of the radiation diagrams of the aerials when functioning as transmitters. These radiation diagrams are shown in Fig. 3, in the form of curved surfaces of equal radiation intensity, the horizontal intensity being made the same for both the frame aerial and the spaced vertical aerial system.

It is evident that with the frame aerial there is a radiation nul along one line only, that line lying in the horizontal plane, but with the spaced aerial system there is a whole family of lines of zero radiation, these lines lying in a single vertical plane. It follows that when used for reception, if there is no restriction on the plane of polarisation of the electric field, the frame aerial can in general give complete extinction of the signal only if the direction of propagation of the wave is horizontal, and coincident with the line of zero radiation; whereas the spaced aerial system is capable of giving complete signal extinction, and hence an exact bearing, no matter at what angle to the horizontal the wave may be propagated so long as the line of propagation lies in the plane of zero radiation. Thus the comparative merits of the two collector systems can be demonstrated without recourse to the detailed analysis given earlier. In the case of the frame aerial, any direction of propagation other than horizontal and coincident with the zero radiation line will

give rise to error unless the electric field is contained wholly in the plane of propagation, i.e., has no horizontal component in the plane of the wave front. This is a condition which is rarely satisfied with waves reflected from the ionosphere or radiated from aircraft with trailing aerials.

Incidentally, it is also evident from Fig. 3, that the frame radiates a much larger proportion of its total energy in the skyward direction than does the spaced aerial system. For equal horizontal intensities the frame aerial must therefore have a larger power input, the difference in power corresponding to the excess sky radiation which ultimately reaches the ground in the form of a strong reflected wave. It is for this reason that in the United States the frame aerial radiators originally used with radio beacons have been replaced by spaced vertical aerial systems which reduce the magnitude of the night error at normal working distances by virtue of their reduction in the skyward radiation and hence in the amplitude of the reflected wave.

(1.6) Pulse Transmission with Frame Aerial Reception

In recent years a very interesting scheme for avoiding night error has been put forward in Germany. Based on the system of pulse transmission evolved primarily for investigating the reflection of waves from the ionosphere, it consists in the transmission of very short pulses to the station by which bearings are to be taken and of their separating, by means of the rapid sweep of an oscillograph trace, the impulses carried by the direct waves from those carried by the indirect waves reflected from the ionosphere, the latter being retarded by the greater length of their path. Reception is accomplished with a rotatable frame aerial, note being taken of the bearing at which the image of the direct waves disappears, though that due to the reflected waves remains present.

This system makes possible the use of a small receiving frame aerial, which is very convenient. Unfortunately, a number of inherent disadvantages limit its practical value:

(a) The process is dependent upon the reception of the direct wave. Unlike the Adcock direction-finding system, it can-

not operate at all on the indirect wave, or take advantage of the increased night range possible thereby ;

- (b) Since reception is on a frame aerial, aeroplane error is not avoided ;
- (c) It is unsuitable for taking bearings at night from an ordinary transmitter not specially equipped for sending impulses ;
- (d) The short impulses occupy wide frequency bands (about 10 kc). This is a very troublesome feature in view of the restriction of the available band width by International agreement ;

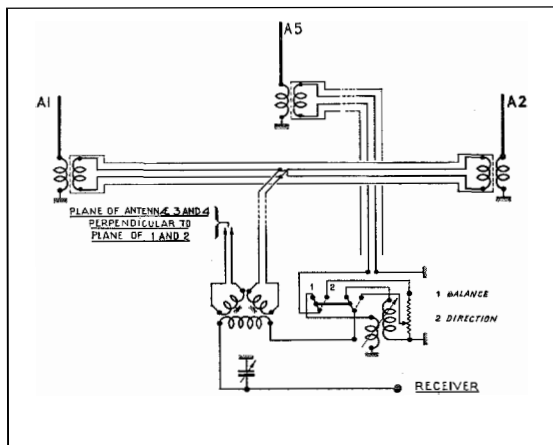

Fig. 4—Simplified Circuit Schematic of the Standard-Adcock Direction-Finder.

- (e) The receiver must not be highly selective. A highly selective receiver would round off the impulses and thus considerably reduce the efficiency of reception ;
- (f) The transmission of short impulses is equivalent to a low percentage of modulation, thus greatly reducing the range compared with that possible using a continuous wave signal ;
- (g) The operator must be highly skilled in order to extinguish only the direct wave response on the oscillograph whilst allowing the incorrect wave response to remain, since the images are close together and liable to confusion.

(2) THE STANDARD-ADCOCK RADIO DIRECTION-FINDERS

(2.1) General

Fig. 4 shows a simplified circuit schematic of a Standard-Adcock type direction-finder. A_1

and A_2 represent a pair of aerials with e.m.f.'s in opposition. The e.m.f.'s of aerials A_3 and A_4 (not shown in the figure) are similarly in opposition. The transmission lines are connected to the coupling windings of the standard type goniometer.

The following indicates briefly the principle of operations :

Consider two mutually perpendicular aerial planes A_1-A_2 and A_3-A_4 . For a direction of propagation at an angle Σ with the plane A_1-A_2 , reception in A_1-A_2 and A_3-A_4 is proportional to $\cos \Sigma$ and to $\sin \Sigma$, respectively. These e.m.f.'s are applied, respectively, to two coupled coils arranged in quadrature within which is located a third coil arranged to rotate round the common axis and carrying a dial graduated to 360° . The design of the coils is such that the mutual inductances between the movable coil and the two fixed coils are proportional, respectively, to the sine and cosine of the subtended angles formed by their planes.

The currents in the coupled coils give rise to a resultant high frequency magnetic field oriented perpendicularly to the direction of propagation of the incoming wave. Thus the movable coil in effect becomes a receiving loop indicating the direction of this magnetic field in accordance with the standard method by adjusting to signal minimum. By suitable setting of the scale it becomes possible to read off the direction of propagation relative to geographical north, with clockwise rotation of the pointer.

Fig. 5 shows diagrammatically a Standard-Adcock Radio Direction-Finder constituted by an Adcock aerial assembly with centrally located goniometer and radio receiver. The length of the transmission lines may be much greater than from corner aerial to centre of the aerial layout, up to about 1 km. The aerial system may thus be erected on a relatively remote piece of unoccupied land, while within the limit of 1 km radius the goniometer and receiver may be located wherever it is most convenient. There is, however, a rather better arrangement for meeting such a requirement. This is used in the Standard-Adcock Radio Direction-Finder, and consists in connecting the aerials in opposed pairs

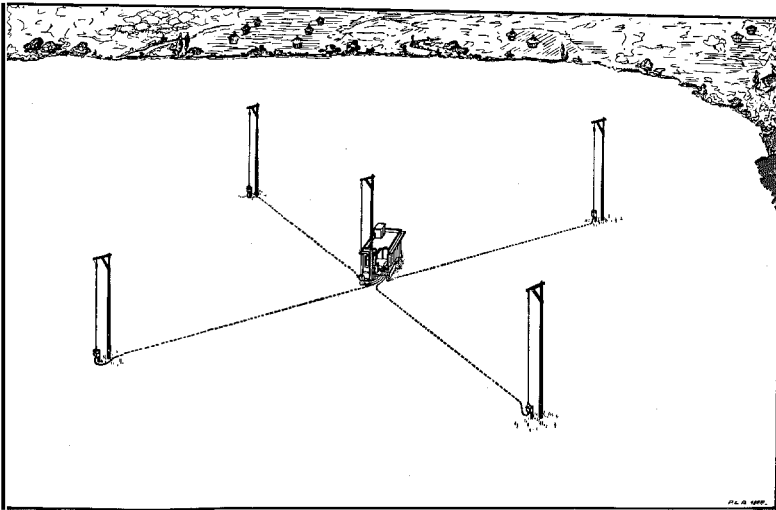

Fig. 5—Arrangement of the Aerials and Central Receiver.

at a centrally placed junction box from which two lines lead to the goniometer and receiver. Thus two lines are dispensed with; moreover, the balancing of the aerial system need only be made on the short corner-to-centre lines since the longer lines to the receiver have no effect whatsoever on this balancing.

The centrally located aerial is used to eliminate the 180° ambiguity and to perfect the balancing of the system as regards amplitude.

Fig. 6 represents diagrammatically the case where the aerials are located 1 km from the receiver. Three cables are run from the junction; one cable for each aerial pair and a third for the centrally located aerial. With this arrangement it is possible to place the receiver in any locality, even one subject to great interference. The losses in the lines are small, but it is necessary to have a reasonably good impedance match between the aerial transformer winding, the line, and goniometer winding.

(2.2) Aerial Coupling Transformers and Transmission Lines

The design and development of the aerial transformers is a matter of some difficulty, since it is necessary to provide an electrostatic screen between primary and secondary windings and yet retain a sufficiently

tight magnetic coupling to enable the transformer to work efficiently over the whole band of 100 kc to 600 kc. The presence of a screen between the windings is essential if the aerial is to be effectively separated from the transmission line. In the absence of a screen the capacity between the windings, unavoidably high in view of the necessity for tight coupling to enable the bandwidth requirement to be met, would permit the circulation of "parallel" currents between the aerials and the reception of horizontal com-

ponents of the electric field set up by the indirect wave.

Fig. 7 shows the following stages in the construction of one of these transformers:

- (1) Primary winding,
- (2) Electrostatic screen added,
- (3) Secondary winding added,
- (4) The completely wound transformer covered by several layers of insulation,
- (5) Copper shield added,
- (6) Collar,
- (7) The shielded transformer mounted in its water-tight cast metal container with lid open, and
- (8) Container with lid closed.

In actual use the metal container is further protected by a wood box which shelters it from direct rainfall, snow, etc.

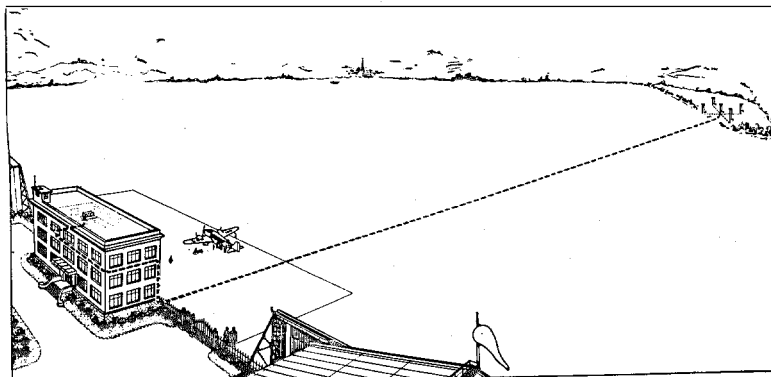

Fig. 6—Arrangement of the Aerial System with the Receiver Located at a Distance.

Since the signal collector system requires for its effective operation great precision as regards amplitude and phase, it is necessary to use transformers with closely matched characteristics. Even with the greatest care in manufacture some differences are found from one transformer to another, and in order to cover this a small variable condenser is connected in parallel with the primary winding, and the transformers matched up in pairs on a special high frequency bridge by adjustment of these condensers, so that the maximum error introduced, from whatever direction the signal may be coming, does not exceed 0.5° . Under these conditions of test and adjustment the balance conditions are satisfied over the whole band of frequencies allotted for medium-wave direction-finding (545 kc to 150 kc; 550 m to 2 000 m), while the effective reception band is from 600 kc to 100 kc (500 m to 3 000 m).

For the transmission lines use is made of special two-conductor cable with paper insulation for short lengths or super-Cotopa insulation for long lengths. The line loss, which varies with the square root of the frequency, does not exceed 3 db to 4 db per kilometre.

(2.3) *Goniometer Compensation and "Sense" Circuits*

When a wave strikes the collector system at right angles to the plane of one of the pairs of aerial, the opposing e.m.f.'s induced in the two aerials should be equal. In practice a small difference is always found, due to the following causes :

(1) *Slight slope of the ground*

The plane of equal electric field intensity is then neither parallel to the ground itself nor parallel to the true horizontal, but occupies an intermediate position.

In these circumstances some improvement can be made by a small increase in the height of the aerial with the lower base, but the correction is not complete over the whole waveband.

(2) *Small inequalities in the transformers and lines*

The difference in amplitude between the e.m.f.'s impressed in opposition on one of the goniometer windings from a given pair of aerials can be annulled by the introduction of an auxiliary e.m.f. from the centre aerial since, inasmuch as this centre aerial is in the same plane as the other two aerials, the e.m.f. induced

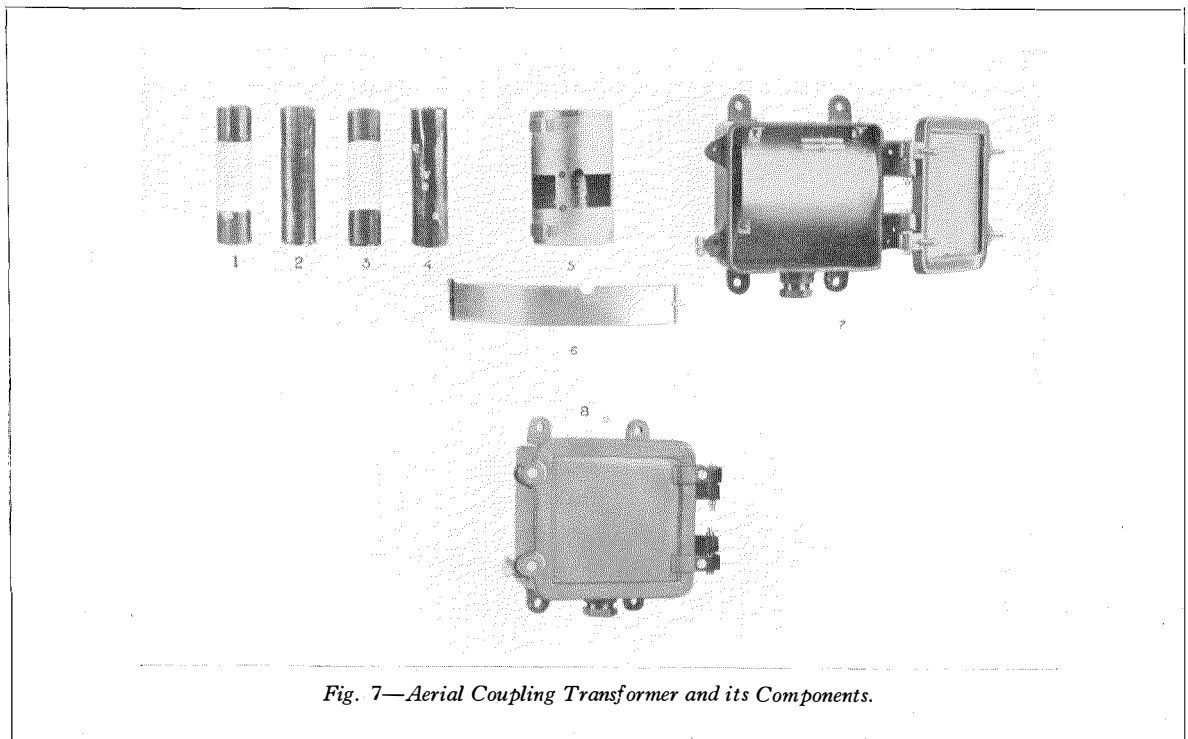

Fig. 7—Aerial Coupling Transformer and its Components.

in it is in phase with the out-of-balance e.m.f. from the pair. A very valuable compensation can be obtained in this way. Such compensation is, however, less nearly perfect when the direction of propagation makes some angle other than 90° with the plane of the unbalanced aerials. If this angle be Σ , then the e.m.f. from the centre aerial differs in phase from the out-of-balance e.m.f. by

$$\theta = \frac{2\pi}{\lambda} \cdot \frac{d}{2} \cdot \sin \Sigma,$$

where d is the spacing between the aerials constituting the pair, and $\frac{d}{2}$ the spacing between either aerial of the pair and the centre aerial. The effect of this phase difference reaches its maximum at around $\Sigma = 45^\circ$, since when higher values of Σ are approached the compensation e.m.f. induced in the goniometer becomes unnecessary as the search coil is coupled less and less closely to the fixed coil energised from the aerial pair under consideration. Even at $\Sigma = 45^\circ$, however, the effect is too small to introduce any serious error; in a typical case, $d = 80$ m, $\lambda = 1000$ m, and $\Sigma = 45^\circ$, the phase difference ϕ of the compensating e.m.f. is only 10° . The direct balance of the system is sufficiently good to make compensation of the residual unbalance by this method extremely effective.

The circuit connections of the centre aerial A5 are shown in Fig. 4. By means of the two-pole switch the aerial is used either for compensation of residual unbalance, or for "sense" finding, i.e., the elimination of the 180° ambiguity.

For compensation purposes the centre aerial energises through its transmission line a small inductance coil coupled to another coil which is connected in series in the tuned search coil circuit. Adjustment of the compensation is made by varying the coupling between the two coils.

For suppression of the 180° ambiguity the centre aerial transmission line is switched so as to be terminated in a resistance a variable part of which is included in the tuned search coil circuit. The e.m.f. so introduced is out of phase by 90° with that introduced by the compensation scheme of connection, and instead

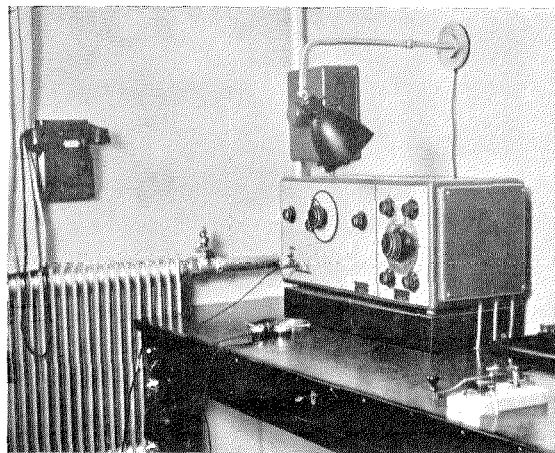

Fig. 8—Standard-Adcock Direction-Finder and Receiver Installed at Norrköping (Sweden).

of correcting the unbalance the e.m.f. is now either in phase or in anti-phase with the effective e.m.f. derived from the main collector system. When these e.m.f.'s are equal and in phase for that position of the search coil which gives maximum reception, a cardioid directional diagram is obtained, giving for one complete rotation of the search coil only one "maximum" and only one "minimum," thus removing the 180° ambiguity, i.e., finding the "sense" of the bearing.

In order to provide a very quick means of sense-finding the following method of operation has been devised. If the e.m.f. delivered by the central aerial instead of being equal to that delivered by the aerial pairs is made much smaller (say one tenth, for example), then on switching the centre aerial from its "compensation" position to the "sense" position, it will be found that the position of the search coil for minimum signal has been moved a few degrees (about six degrees in the present case) in the direction of an *increase* in the angular bearing, if this was originally the correct one, or in the direction of a *decrease* in the angular bearing if it was originally at 180° to the true direction. Thus a very simple operation gives an immediate indication of the sense of the bearing. The amount by which the minimum is displaced is governed by the adjustment of potentiometer R which injects the e.m.f. from the centre aerial. Incidentally it may be noted that the cardioid diagram corresponds to the

particular case in which the shifts of the minima have both been made 90° , with the result that since the shifts are in opposite directions the two minima originally 180° apart are made to coincide.

The goniometer is designed for accurate direction-finding on frequencies between 150 kc and 500 kc. The search coil circuit may be tuned over the range from 100 kc to 600 kc in two bands of 100 kc to 240 kc and 240 kc to 600 kc. The first mentioned band is obtained by tuning the search coil with a variable condenser of maximum capacity $1000 \mu\mu F$; for the second band the search coil winding is in addition shunted by a suitable inductance.

Equipments capable of sense-determination by the classical method, i.e., by means of a cardioid directional diagram, have been developed by Standard Telephones and Cables, Ltd. This method is favoured by certain users.

(2.4) Receiver Circuits and Power Supply Systems

The original receiver forming part of the Standard-Adcock Direction-Finders is of the straight type, and incorporates five stages—two high frequency amplifier stages, self-heterodyning detector, and two resistance-capacity coupled low frequency amplifier stages, the second low frequency stage being used only for loudspeaker

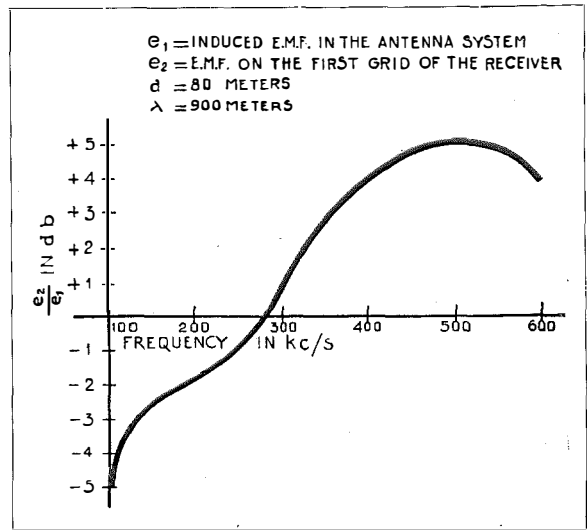

Fig. 10—100 m Transmission Line Characteristics.

reception. The frequency range covered extends from 100 kc to 600 kc, in two bands of 100 kc to 240 kc and 240 kc to 600 kc selected by means of a single switch. All the valves are indirectly heated pentodes, that used for the second high frequency stage being of the variable slope pattern, while in all other cases fixed slope valves are employed. Three tuned circuits are used for coupling between the two high frequency amplifier stages and to the grid of the detector, the fixed inductances being of the iron dust core type with a reactance/resistance ratio of the order of 150 to 200, while the three variable tuning condensers are of the air dielectric type, and are ganged together and provided with a tuning dial closely graduated in kilocycles. The input to the receiver, i.e., the search coil circuit, is separately tuned on the goniometer. These four tuned circuits give a selectivity corresponding to a pass-band of two to three kilocycles. By means of a switch it is possible to replace the resistance-capacity coupling between the detector and the first L.F. amplifier by inductive coupling between two circuits tuned to resonate around 800 cycles, in which case the selec-

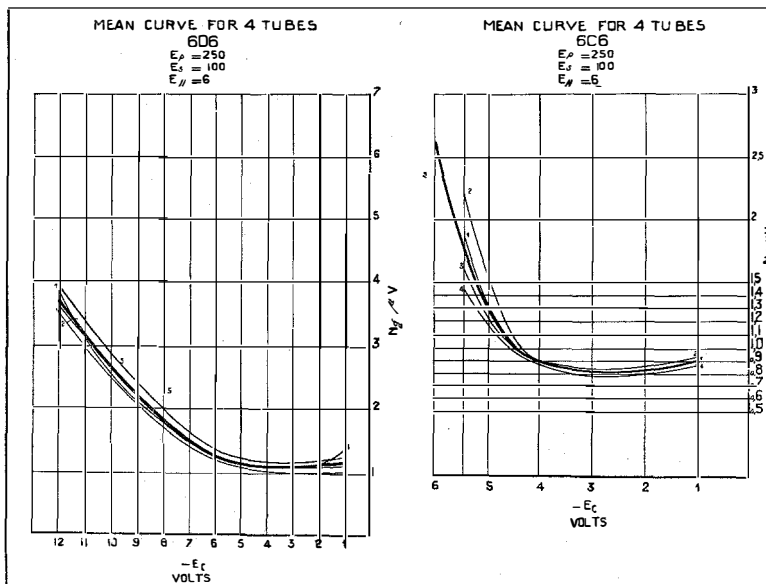

Fig. 9A Basic Noise of High Frequency Pentode Valves. Fig. 9B

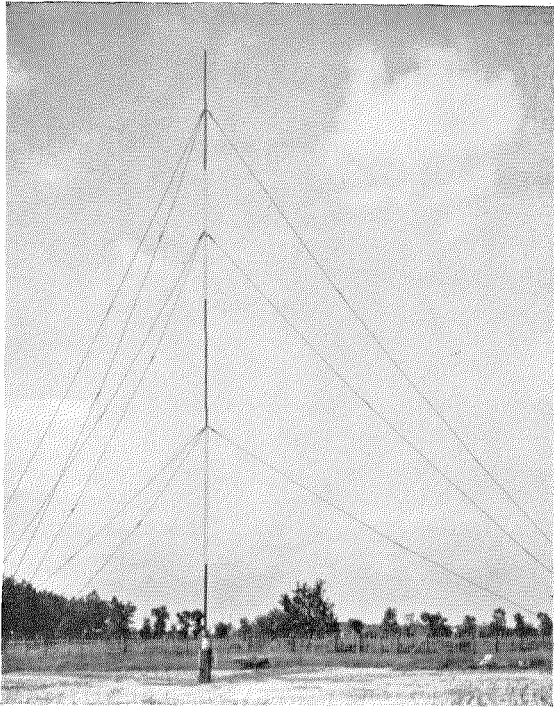

Fig. 11—Steel Tube Mast Aerial of the Standard-Adcock Direction-Finder at Bordeaux-Mérignac.

tivity is increased and the effective bandwidth reduced to a few hundred cycles.

The power supply system is arranged in a separate unit, and provides for alternative supply from either :

- (a) A.C. mains, 110 volts or 220 volts, with transformer tappings to cover variations in line voltage up to ± 15 per cent. ; in this case the valve cathodes are heated with A.C., while the D.C. supply for anodes and control grids, etc., is derived from a Selenium rectifier and smoothing filter ;
- (b) Battery supply of 24 volts, heating the cathodes directly, and supplying H.T. for the anodes, etc., by means of a 24 V—250 V rotary converter.

Either of these supply systems can be selected at will by means of switches on the power supply unit. The 24-volt battery system is normally installed for emergency use only, and is arranged to be charged from a separate rectifier.

The whole equipment, both receiver and

power supply, has been designed on the basis of continuous operation.

The receiver and goniometer units are mounted together on runners in a single container to form a desk-mounting assembly as shown in Fig. 8, the goniometer unit being at the right-hand end. The lid of the container may be raised to give immediate access to the valves and wiring.

The receiver controls are confined to tuning on the frequency calibrated condenser dial already mentioned, and the auxiliary controls of waveband selection and reaction which are seldom touched. The goniometer controls include the search-coil or direction-indicating dial, the index of which is equipped with a magnifying lens, and the auxiliary controls for compensation and for "sense" finding, together with the waveband selector and search-coil tuning adjustment, neither of which latter need be moved unless there is a considerable change in the wavelength on which watch is to be kept. For use under congested ether conditions, a superheterodyne receiver of high selectivity is available.



Fig. 12—Supporting Insulator and Base of Mast Aerial of Standard-Adcock Direction-Finder at Bordeaux-Mérignac.

(2.5) Receiver Sensitivity and Background Noise

In the case of radio receivers which form part of direction-finding equipment the degree of sensitivity and the amount of background noise are of more than ordinary importance. Particularly is this so when the equipment is required to take bearings on aircraft, since the latter are provided with transmitters which are necessarily of small size and low power and give only a weak signal. In the absence of atmospherics it is primarily the inherent signal/noise ratio of the receiver which limits the utility of the direction-finder since the latter has to work not even on the signal as it would be used for communication purposes, but on the radiogoniometric minimum of the signal, which may be 30 db to 40 db below the communication level. Obviously the effect of receiver noise is to mask the true point of signal extinction and turn a sharp minimum into a comparatively large "arc of extinction" or "swing" over the whole of which the signal is inaudible. For an arc of 2° the goniometric minimum signal is 35 db below the goniometric maximum, while with an arc of 10° the ratio is of the order of 20 db. It is fortunate that even when noise conditions give rise to an arc of extinction of 10° a good operator can judge the correct bearing to within $\pm 1^\circ$.

Now it can be said of any receiver which, when adjusted to maximum sensitivity, does not exhibit any background noise, that that receiver

does not incorporate as much sensitivity as could be effectively utilised. If the maximum useful sensitivity is to be obtained there is bound to be a certain amount of background noise. The sensitivity cannot, however, be judged on the background noise alone, for a badly designed receiver may have much more noise in it than a good one, and fail to detect signals which are still audible in the latter. The only real basis of comparison is the signal/noise ratio, which should be as large as possible.

Since the background noise is proportional to the bandwidth of the receiver the selectivity of the latter is also an important factor. When, however, the selectivity is high to start with, as in the case of the Standard-Adcock equipment, little further improvement in the signal/noise ratio can be obtained by increasing the selectivity without adversely affecting the ease of operation.

In a well-designed receiver the background noise arises almost exclusively from thermal agitation of the electrons in the input circuit to the grid of the first valve, or in the plate-cathode path of this valve, the first named source predominating if the input circuit is, in spite of its being coupled to the aerial system, only lightly damped. In the RC.6 equipment the noise from both sources is about the same, and is the minimum physically attainable.

It is obvious that if the signal/noise ratio is to be kept high the first valve must be employed as effectively as possible. It is for this reason that in the RC.6 receiver the first valve, a fixed-

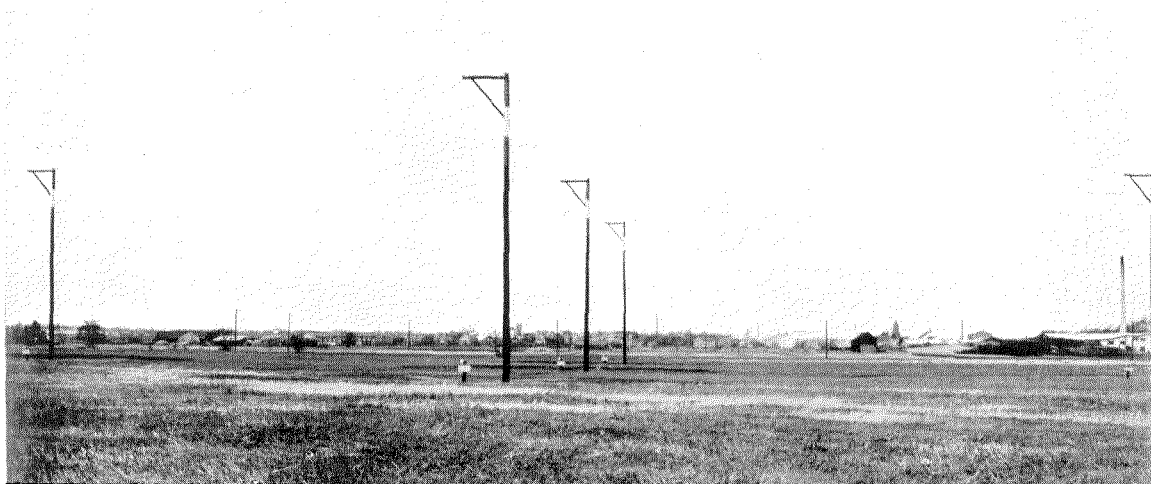

Fig. 13—Group of Five Aerials at Norrköping.

slope H.F. pentode, is always run at maximum gain, and gain control used only on the second stage, a variable-slope H.F. pentode with variable grid-cathode bias.

In Fig. 9-A is shown the relation between the background noise of a variable-slope H.F. pentode and the bias applied to the grid, the noise being expressed in terms of the equivalent e.m.f. on the grid. Fig. 9-B shows corresponding curves for a fixed-slope H.F. pentode. From these curves can be determined the best operating region for good signal/noise ratio.

The lower limit of high frequency signal which can be detected in an RC.6 receiver through the background noise is of the order of 0.5 microvolts on the grid of the first valve. Allowing a total swing or arc of extinction of 10° (i.e. $\pm 5^\circ$) the signal e.m.f. received from the collector system must therefore be at least $0.5 \text{ microvolts} / \sin 5^\circ = 5.75 \text{ microvolts}$. From Fig. 10, which shows the e.m.f. transfer ratio over 100 metres of line between aerial system and the goniometer of an RC.6-A equipment, it will be seen that with an aerial effective height of 3 metres this gives a signal field of approximately 2 microvolts per metre at 300 kc as the minimum necessary to secure a good directional bearing.

(2.6) Typical Installation Features

In practice the actual form of the aeriels varies according to local conditions. One type of construction is that of cage aeriels 12 m to 14 m high, carried by wooden supports; in another, rather more common, the aeriels consist of guyed tubular sectional masts, 14 m to 16 m in height, insulated at the base. Such a mast aerial is shown in Fig. 11; it is part of the direction-finding equipment at Bordeaux-Mérignac. The effect of the guys, which are sectionalised by insulators, has been found to be negligible. Fig. 12 shows the base of one of these masts in the course of erection; the base insulator, which carries the weight of the mast, can be clearly seen, as also the wooden box for protecting the aerial coupling transformer.

Fig. 13 shows the complete system of five aeriels of the cage type with wooden supports, as used at the direction-finding station of Norrköping, Sweden. The goniometer and receiver are located in a hut about 350 m from

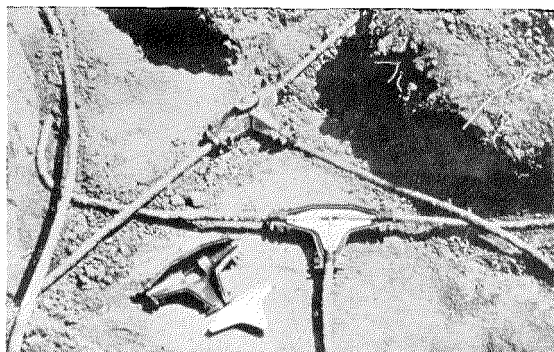

Fig. 14—Junction of the Cables of a Standard-Adcock Direction-Finder at the Centre of the Aerial System.

the centre of the aerial system and connected thereto by some 400 m of high-frequency cable. The interior of the operating room is shown in Fig. 8.

Fig. 14 illustrates the method of connecting the goniometer cables to the centres of the aerial coupling transmission lines for a Standard-Adcock equipment. The photograph was taken during the installation of the station at Belgrade-Zemun aerodrome. The electrical joints are covered by soldered lead sleeves and further protected by cast metal junction boxes filled with compound, the whole being coated with tar and then buried in the ground. The junction so protected is absolutely water-tight.

(2.7) Performance

The extensive series of measurements made during the course of development of the Standard-Adcock Direction-Finder has now been most usefully supplemented through the courtesy of users of one form or another of the equipment, who have communicated the results of numerous observations made on both fixed and aircraft stations and over widely varying distances. With the aid of this additional data the performance of this type of Direction-Finder with its Adcock collector system has now been well established, and may be roughly described as follows:

It has been determined that up to 200 km the night error for a fixed or aircraft station does not exceed $\pm 2^\circ$ when the direction-finding station is located in a region which, while irregular in surface, is not actually mountainous; up to 100 km it is in fact difficult to observe any sign whatsoever of night effect.

At greater distances, around 400 km to

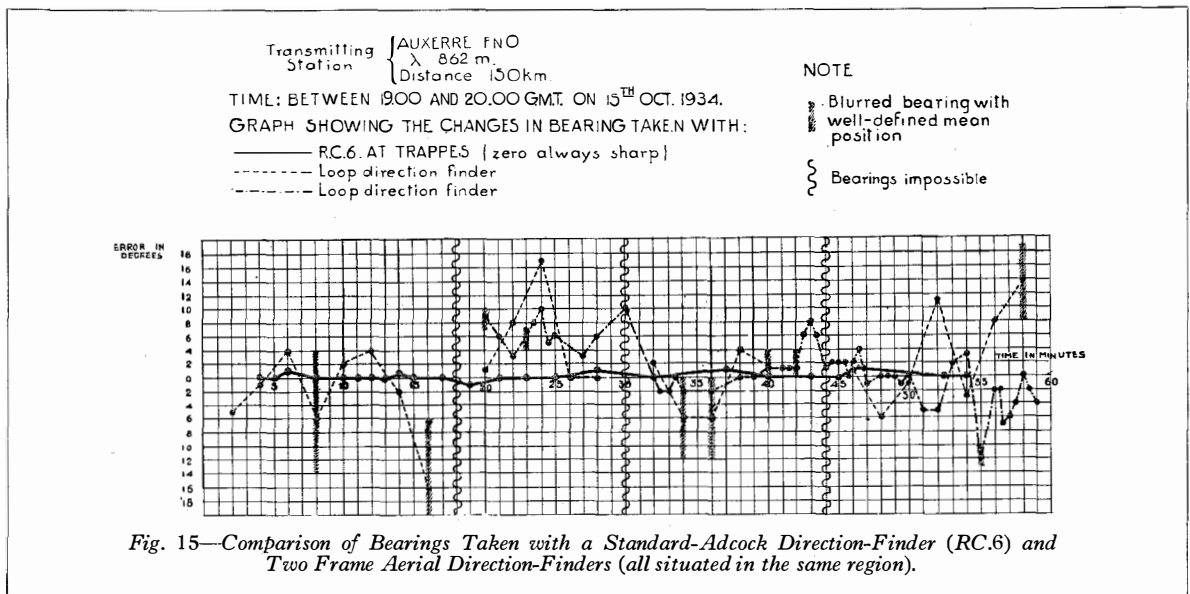

600 km, the presence of night effect is evident through *small* variations both in the bearings ($\pm 2^\circ$ to 4° on a wavelength of 900 m) and in the compensation required. The variations are definitely less on longer waves (1 500 m to 2 000 m) and greater on shorter waves (500 m to 700 m). Over sea, they frequently do not occur at all.

When the critical distance has been passed, the bearings become very constant and practically perfect stability is attained beyond 1 000 km, provided that the transmitters are sufficiently powerful to cover this range. The critical distance apparently coincides with the appearance of a reflected wave at a high angle of incidence, with the horizontal component of the direction of propagation rather ill defined and the vertical component predominating.

Fig. 16 indicates plainly that for frequencies of the same order, the stability of the bearings on land transmitters is better at distances around 900 km than at 460 km. Similar verifications for long ranges are difficult to obtain in the case of aircraft because of their lower transmitter power.

During the day, direction finding in the case of aircraft is effective up to a radius of about 300 km. At this distance the arc of extinction is of the order of ten degrees, the electromagnetic field from an aircraft transmitter of average power then being at that distance only a few microvolts per metre. (The term "average power," as referred to above, means 10 to 30 watts radiated from the aerial. Ranges of 500 km to 600 km are often obtained with

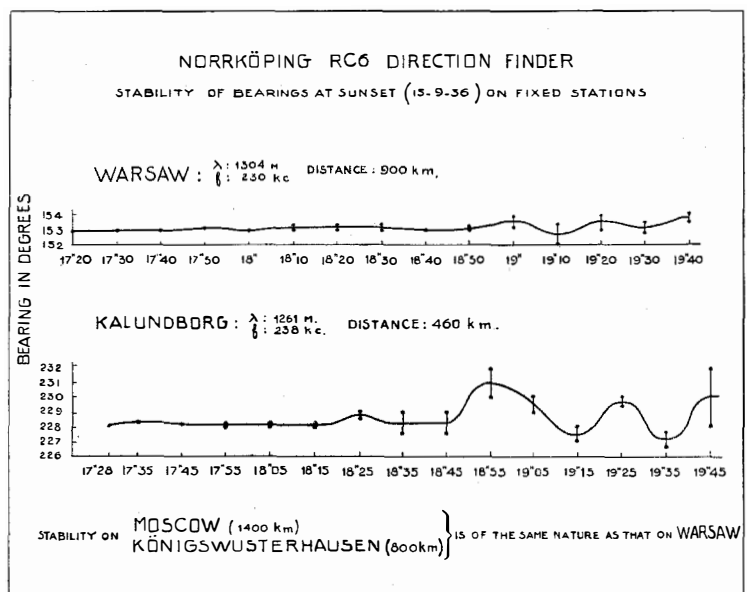

Fig. 16—Bearings at Sunset Taken on the Standard-Adcock Direction-Finder (RC.6) at Norrköping.

aircraft transmitters of higher power.) An arc of extinction of ten degrees is still sufficiently good to give a bearing accurate within 2° or 3° . The arc of extinction diminishes rapidly with the distance; between 100 km and 200 km bearings can readily be taken accurate to within 1° , during either the day or night.

At night it is practicable to take bearings with excellent accuracy by means of the indirectly propagated waves at distances often as great as 800 to 1 000 km. This represents one of the great advantages of the Adcock collector over systems designed to separate the direct and indirect waves and to restrict operation to the directly propagated waves.

For comparative purposes, the error of night bearings on the same fixed transmitting station, taken on a Standard-Adcock Direction-Finder and on two frame aerial direction-finders situated in the same region, is shown in Fig. 15. The wavelength used in taking these bearings, 862 metres, is very close to the aeronautical direction-finding wave. The curves indicate strikingly the errors which may occur at a distance of 150 km if direction-finding is attempted with a frame aerial during the night. Although errors observed with frame aerials are frequently of the order of $\pm 16^\circ$ under these conditions, the corresponding maximum differences encountered with the Adcock equipment do not exceed $\pm 1^\circ$.

The choice of location is of some importance; its influence must, however, not be exaggerated. Of ten locations which were investigated only one proved unsatisfactory. Ordinarily, direction-finding aerials are installed on well-open ground, preferably as horizontal as possible. Mountains are an undoubted hindrance, not only because of the resulting wave deflections, but still more due to their screening effect when they lie between the transmitter and the direction-finder. This screening is most troublesome when the mountains are close to the direction-finder. Here again, however, the Adcock principle has proved superior to all other methods in that night bearings may be taken on indirect waves, which pass above the mountains if these are not too close to the direction-finding system.

Direction-finding installations, as far as practicable, should therefore be located on free,

open ground. A high plateau is often a very favourable site against the occurrence of night error, inasmuch as any fixed error produced by the plateau can be measured and a correction applied.

In slightly mountainous regions, a favourable site may be determined without a preliminary installation. In very mountainous country it is advisable to carry out preliminary tests with a semi-portable Direction-Finder in order to determine the most favourable location.

(2.8) Applications

While the Standard-Adcock series of radio direction-finders has a large field of use at coast stations for marine navigation, and also for military purposes, its most valuable application is clearly to aircraft navigation. This has been recognised by the aviation authorities, and equipments of this type will shortly be in use at many important aerodromes.

The normal method of use is for two or three such equipments to operate as a group. When a pilot wishing to know his position asks for it by means of the radio transmitter on board his aircraft, his request is picked up by the direction-finding stations, each of which immediately observes the bearing of the signals. At the station in charge all the observed bearings are transferred to a special chart by means of a system of stretched threads, the intersection of the threads giving the position of the aircraft by triangulation; the bearing so found is then transmitted to the aircraft in some such form as "20 km south-west of Abbeville." All communication is by telegraph code, and the whole process takes remarkably little time; with skilled operators a position can be given to a pilot within 20 seconds of his request.

Another application is that known as "homing on bearings." In this case the pilot is kept informed at short intervals of his bearing on an aerodrome, and continually adjusts his course to fly on this bearing; usually the process commences when he is still distant by 30 km to 50 km. When by this means the machine has been guided over the aerodrome, which may be obscured by clouds, a special signal is transmitted to the pilot, and he then follows the "ZZ" procedure and descends through the clouds ("breaks the ceiling"), knowing that

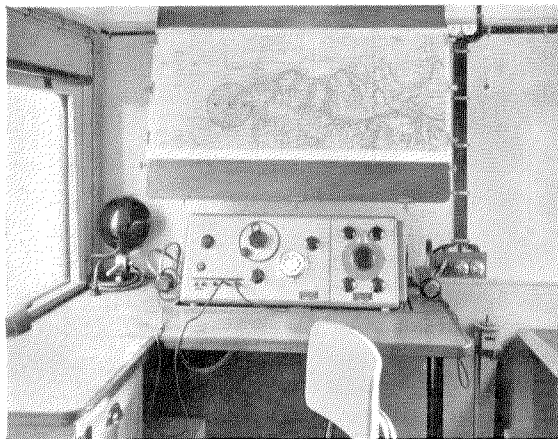

Fig. 17—Operating Room in Motor Van.

the aerodrome must be beneath him, and completes his landing in the usual way. The Standard-Adcock equipment is particularly useful for this method of navigation owing to its complete immunity from aeroplane effect and consequent ability to give accurate bearings even when the aircraft is close in and the transmitted wave arrives with a large angle of tilt. If a frame aerial system is used it is true that the aeroplane effect is at its minimum because the aircraft is flying towards the system (assuming the latter to be close to the aerodrome) but even so better accuracy is obtainable with an Adcock system of quite low height, 9 m to 10 m at the most.

It is the opinion of the writer that for maximum efficiency aerodrome equipment should include two direction-finders, one for long range work with its aerial system well

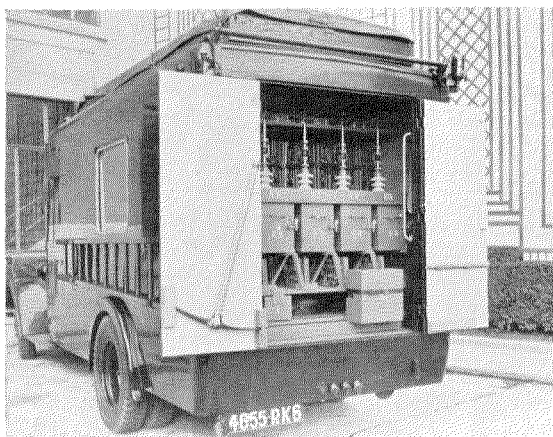

Fig. 18—Accessible Rear Compartment of Motor Van.

away from the landing ground, and another for short range work with a low aerial system erected at the boundary of the landing ground and on the normal line of approach. By the use of transmission line connections the goniometer and receiver units for both systems can be installed together in the same office quite conveniently.

It should perhaps be pointed out that fitting an aircraft with a radio compass does not make the aerodrome direction-finder any less necessary, and vice versa. Two safety measures are better than one. If the aircraft transmitter breaks down the aerodrome direction-finder cannot provide either a position or a bearing, but both can be obtained on the aircraft itself if a radio compass is carried, and disaster may thereby be avoided. In normal circumstances, however, navigation by the aid of bearings

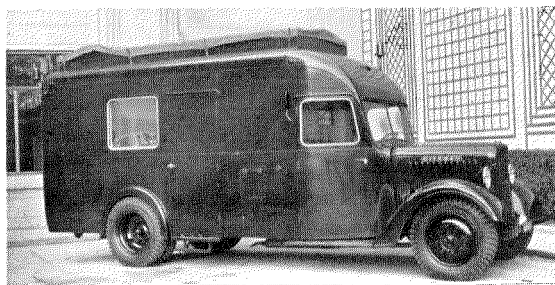

Fig. 19—Direction-Finding Motor Van.

determined at a ground station seems preferable to homing or a radio range beacon; the latter system has all the advantages but also all the disadvantages of rigidity, and in particular it requires the pilot to fly a predetermined course regardless of weather conditions. Against this, navigation by means of ground direction-finding stations offers all the advantages of perfect flexibility of course.

ACKNOWLEDGMENTS

In conclusion, the author is glad to take this opportunity of acknowledging gratefully the receipt of valuable observational data from users of the equipments described in this article. He also wishes to point out that much of the credit for the design of the aerial coupling transformers is due to one of his colleagues, Mr. J. B. Lair, who had previously studied the same type of problem in another connection.

APPENDIX***A Semi-Portable Direction-Finder with Adcock Aerial System***

A direction-finding equipment using the Adcock system of spaced vertical aerials cannot be built in a form portable in the same sense as a frame aerial direction-finder. It is possible, however, to arrange such a system to be semi-portable, i.e., capable of transport in a lorry and quickly assembled or dismantled. Such an arrangement is greatly facilitated by the aerial coupling scheme and transmission line connections evolved for the fixed types of Direction-Finders. Recognising this, the French Air Ministry placed an order with Le Matériel Téléphonique for a semi-portable equipment built on these lines; this is shown in Figs. 17, 18, 19, and 20.

The entire equipment comprises aerials, coupling transformer, transmission lines, receiver, goniometer, and power supply system. It is housed in a van which is divided into three compartments in addition to the driver's cabin. The rear compartment, shown in Fig. 18, carries all the aerial and associated gear which being used in the open is liable to become wet or muddy; this includes masts, coupling transformers, pickets, guys, etc.

In the centre compartment, shown in Fig. 17, are mounted the goniometer and receiver, and a certain amount of office furniture and equipment. As can be seen from the illustration it has been found possible, despite the limited space, to provide a compartment in which the operator can work quite comfortably.

The third compartment, Fig. 20, opens off the operating room and contains a 24-volt battery, petrol-electric charging set, charging switchboard, Selenium rectifier, and power supply panel for the receiver. It enables the batteries to be charged through the rectifier from 110-volt or 220-volt A.C. mains, if these are available, or alternatively by means of the petrol-electric set—a facility of great value in remote country districts. When electric mains are available the receiver may draw its supply directly therefrom precisely as in the case of a fixed station; in other cases, the supply is drawn from the 24-volt battery.

On the roof of the van, under a water-proof tarpaulin, are mounted the earth-mats used in

conjunction with the aerials. The latter are of duralumin tubing, and are held by three sets of steel guys sectionalised by insulators. Each aerial is 12 metres high and weighs about 20 kilograms, the weight being distributed by means of a metal mast shoe which enables the aerial to be erected even on rather soft ground. The mast shoe also carries the aerial coupling transformer with its protective wood casing. Four men are required to erect an aerial, one at the aerial base and one for each set of guys.

The transmission lines are of flexible type, and are shielded and rubber covered. The terminations are provided with moisture-proof connectors and identified by a colour-scheme which enables rapid connection to be made, without error, between the aerial coupling transformers, lines, and the van, the latter being



Fig. 20—Interior View of Power Supply Compartment in Motor Van.

if necessary 60 metres distant from the centre of the aerial system so as to avoid leaving the roadway.

All the items are, of course, arranged in such a way as to simplify the work of installation. Guy wires are carried wound on special formers, plug connections are used wherever possible, etc. The nominal time required to erect the station is six hours, with a crew of four men; with practice this time can be considerably reduced although, in addition to the work of erection as such, it includes the surveying necessary to ensure that the planes of the aerial pairs are accurately at right angles to one another, that all the masts are accurately vertical, and that the corner masts are rigorously equidistant from the centre point, together with careful laying of the earth mats and any necessary levelling of the site. It is perhaps worth mentioning that never yet has it been found necessary to re-adjust the aerial guys after erection has been completed, no matter how strong the wind.

The official tests, begun in frosty weather and

finished during a downpour of rain, showed that the performance of the semi-portable Standard-Adcock equipment is comparable with that of the fixed equipments. Since then it has been possible by means of this van to make numerous tests on different sites. The installation has been set up in various parts of France, in the east, in the south, in the west, and on the Breton plateau (reached over mountain roads of poor surface), and has enabled a direction-finding station free from night error to be erected in a few hours wherever necessity dictated. All the tests and temporary installations were made by the French Air Force under the direction of the Technical Department of the Air Ministry.

The usefulness of a mobile equipment of this character may be readily appreciated. It facilitates making tests and selecting sites for fixed stations, and moreover enables a direction-finding station, free from night error, to be put into service in a few hours to meet the needs of a new air route or for any other purpose.

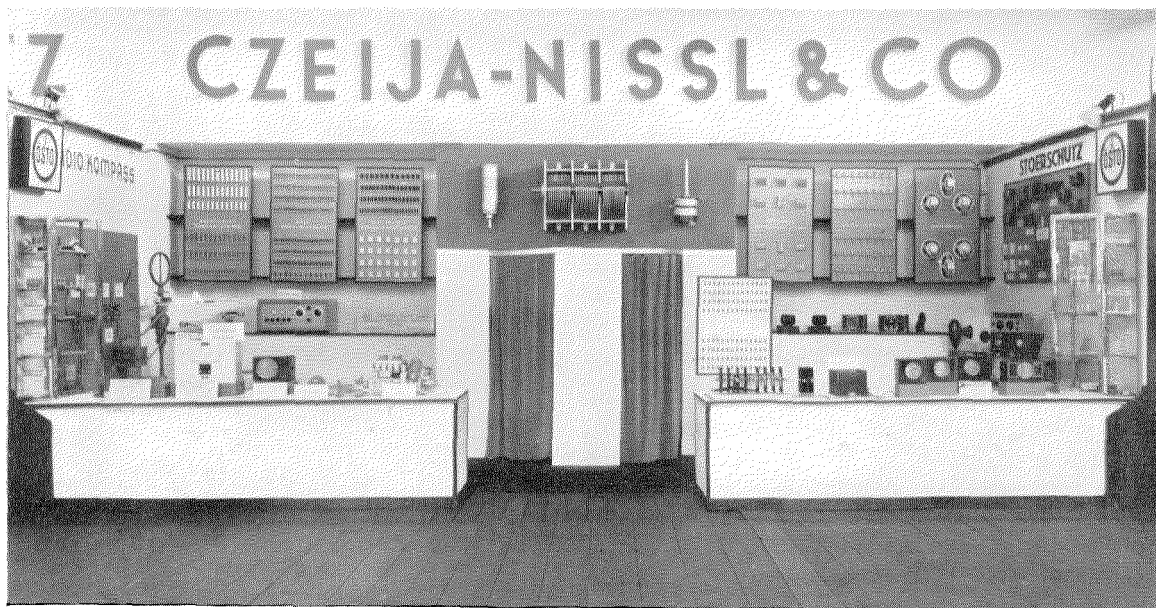

International Radio Show, Vienna, September, 1937. Stand of Czeija, Nissl & Company, displaying Amplifiers, RC.5 Standard-Busignies Automatic Radio Compass, Aircraft equipments, Radio components, etc. The Stand attracted great attention and was visited by the Federal President of Austria and other prominent people.

An Experimental 5 kW "Doherty" Amplifier

By C. E. STRONG, B.A.I., M.I.E.E., M.I.R.E.,

and

G. G. SAMSON, B.E. (N.Z.)

Standard Telephones and Cables, Limited, London, England

THE new linear radio frequency amplifier which has been introduced by W. H. Doherty,* is distinguished from the well-known Class "B" linear amplifier in that it operates at high efficiency for all levels of modulation.

The use of such an amplifier in a broadcasting transmitter results in considerable economy of power and offers an alternative solution to the method of final stage Class "B" modulation or the Chireix system of "outphase modulation" for the improvement of overall efficiency. The following is a brief review of the mode of operation, illustrated by performance figures derived from an experimental 5 kW transmitter.

It is well known that, if the efficiency of an amplifier is to be high, the conditions must be such that the peak amplitude of the alternating plate voltage is only slightly inferior to the value of the D.C. plate voltage. Under those conditions an increase of drive would not result in a corresponding increase of output voltage, and, consequently, the amplifier would not pass the positive peaks of modulation. Reduction of drive would, however, be accompanied by a reduction of output voltage and, under certain conditions of adjustment, the reduction would be proportional to the decrease of drive. To utilise such an amplifier for the purpose of raising the level of a modulated wave, it would be necessary to find some method of passing increased power for the positive peaks of modulation without affecting the operation on negative peaks.

There are two possible methods of accomplishing this result: (a) by lowering the impedance into which the amplifier works during

positive peaks while keeping it constant during negative peaks; or (b) by supplying power for positive peaks from an additional source. The Doherty system is a combination of both methods.

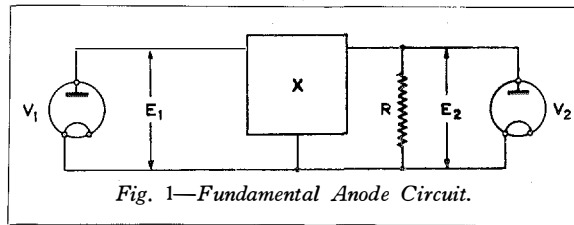

Fig. 1—Fundamental Anode Circuit.

Principle of Operation

Fig. 1 shows the fundamental anode circuit of the Doherty system. Valve V_1 supplies the carrier power at high efficiency and V_2 comes into operation only on positive peaks of modulation. Both valves are excited from the same source, V_2 being biased back so that it is cut off at carrier conditions. R is the load resistance and X is a quarter-wave network.

A quarter-wave network has the property that the input impedance varies inversely as the output impedance, and the following relations apply: $Z_1 = X^2/Z_2$ and $E_2 = \frac{E_1 Z_2}{X}$, where Z_1 and Z_2 are the input and terminating impedances, respectively, X is the characteristic impedance of the network, and E_1 and E_2 are the input and output terminal voltages.

In Fig. 1, X is made equal to $2R$. Consequently, for the carrier condition when V_2 is inoperative, E_2 is equal to $\frac{E_1}{2}$, and Z_1 , the impedance into which valve V_1 works, is equal to $4R$.

When modulation is applied, the terminating impedance across the network on negative peaks remains equal to R , and V_1 operates into a constant impedance, E_1 varying linearly with

* "A New High-Efficiency Power Amplifier for Modulated Waves," by W. H. Doherty, *Proceedings of the Institute of Radio Engineers*, September, 1936; *The Bell System Technical Journal*, July, 1936.

the applied grid voltage. On positive peaks, however, V_2 delivers power into the load, thus raising the impedance terminating the network and therefore lowering the impedance into which V_1 operates. The valve V_1 consequently delivers increased power although its anode swing remains constant. At the instant of full "up" modulation, V_2 delivers half of the total power thus raising the terminating impedance of the network from R to $2R$ ohms and lowering the impedance into which V_1 operates from $4R$ to $2R$. V_1 then supplies twice the carrier power and a similar power is supplied by V_2 , giving a total instantaneous peak power equal to four times the carrier power.

The introduction of the quarter-wave network between the anodes of V_1 and V_2 causes a phase shift of 90° between the voltages E_1 and E_2 (Fig. 1), and so, to enable a common driving source to be used, it is necessary to insert a 90° phase shifting network of opposite sign in the grid circuit of V_1 . The general arrangement is shown in Fig. 2.

As the R.F. input is increased from zero, the voltage at B increases linearly with the voltage at A until carrier level is reached, after which it remains constant. The current I_1 delivered by V_1 increases linearly with drive. The current I_3 also increases linearly with drive until carrier level is reached, after which it remains constant. The current I_2 delivered by valve V_2 is zero until carrier level is reached, after which it increases linearly with drive so that at 100 per cent. modulation level I_2 is equal to I_3 . The final result is that the sum of the currents I_1 and I_2 , equal to the total output current I_4 , increases linearly with drive.

The voltage at C is linear with drive, since up to carrier level E_c is equal to $\frac{E_B}{2}$, and as the drive is increased above carrier level the

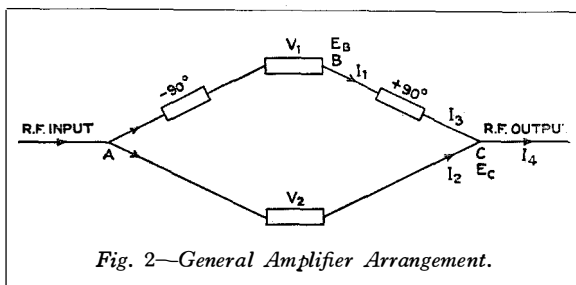

Fig. 2—General Amplifier Arrangement.

terminating impedance of the anode network changes linearly from R at carrier level to $2R$ at 100 per cent. modulation level, so that E_c increases linearly with drive until it reaches a value equal to E_B at full modulation.

The above effects are illustrated by the curves in Figs. 3 and 4, showing actual performance results obtained from the 5 kW experimental amplifier.

Design of Experimental Amplifier

The two forms of quarter-wave network used in the amplifier are shown in Fig. 5. It is convenient to use type (a) in the anode circuit giving a phase shift of $+90^\circ$, and type (b) in the grid circuit giving a phase shift of -90° . In both cases the input impedance is X^2/R and the ratio of input to output voltages is X/R .

The shunt arms of the quarter-wave network may be obtained very conveniently by detuning the anode (or grid as the case may be) anti-resonant circuits until the required impedance $-jX$ (or jX) is obtained. Fig. 6 shows simplified anode and grid circuits derived in this way.

In the case of the grid circuit X is made equal to R , the terminating impedance of the network, so that the voltages applied to the two grids are equal. The network, however, is also terminated by the grid impedance of V_1 . As the ratio of input to output voltages of the network depends upon the ratio X/R , the terminating impedance of the network must be substantially constant for all levels of drive from zero to carrier level. R should therefore be chosen so that the effect of the valve grid impedance is negligible over this range.

As the anode swing of V_1 remains constant for levels above carrier level, the voltage applied to the grid of V_1 need only rise sufficiently to allow for the loss of gain in this stage due to the fact that V_1 operates into a lower impedance on positive modulation peaks. The rise in grid drive necessary to maintain the anode swing at a constant voltage depends upon the anode impedance of the valve, but is generally of the order of 40 to 50 per cent.

If R_g is the effective impedance presented by the grid of V_1 at the peak of the audio cycle, the terminating impedance of the grid network at 100 per cent. modulation positive peaks is

equal to $\frac{R R_g}{R+R_g}$, and the ratio of input to out-

put voltages of the network is $\frac{X(R+R_g)}{R R_g} = \frac{R+R_g}{R_g}$.

If the grid voltage of V_1 is required to rise 40 per cent. above carrier level for 100 per cent. positive modulation peaks, then

$$\frac{R+R_g}{R_g} = \frac{2}{1.4}$$

$$\text{and } R = 0.43 R_g.$$

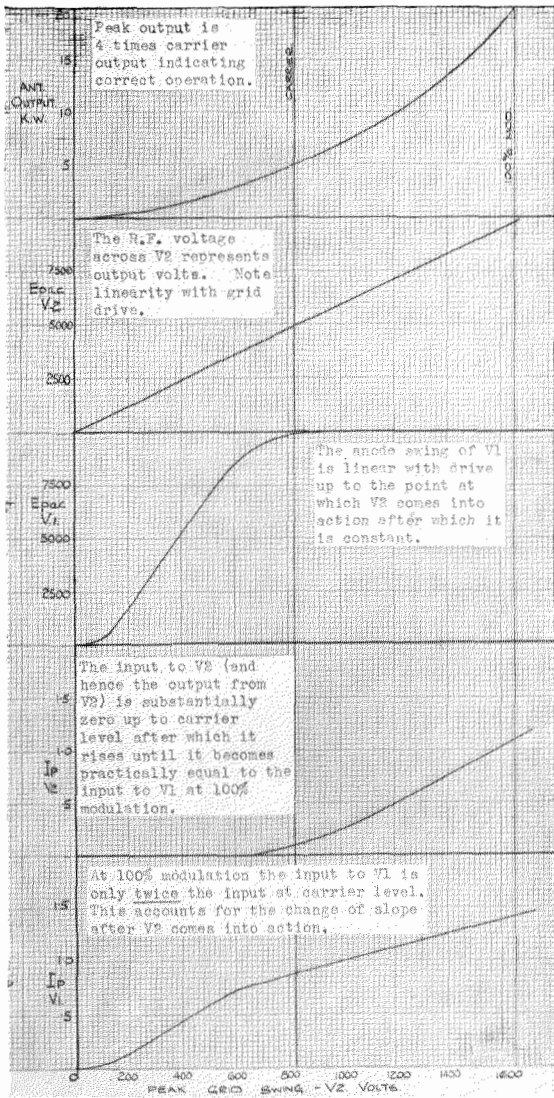

Fig. 3—Amplifier Characteristics.

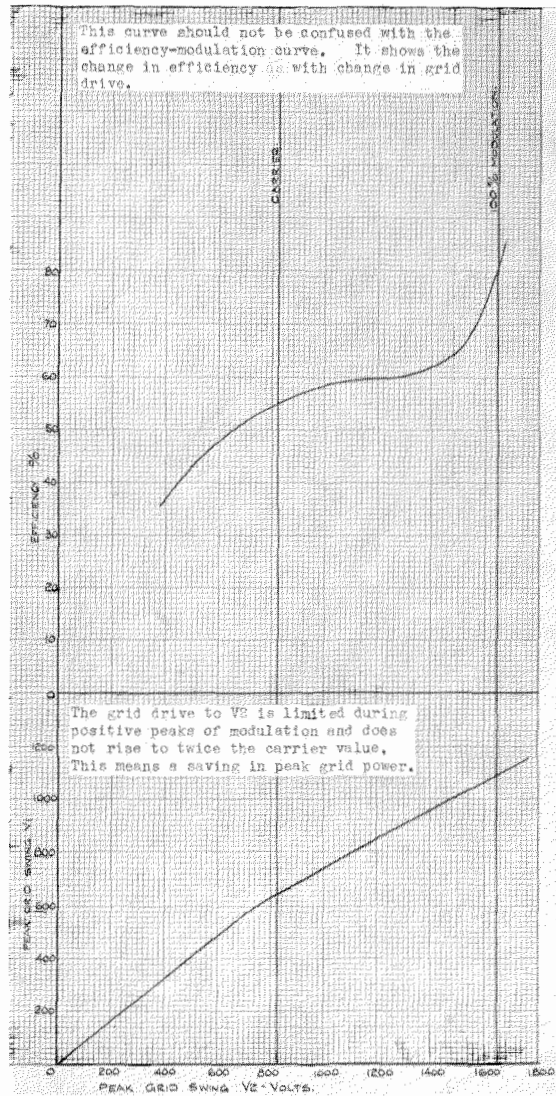

Fig. 4—Amplifier Characteristics.

This value of R generally satisfies the required conditions for negative modulation peaks ; but, if not, a compromise must be made, and the grid voltage of V_1 must be allowed to rise to a higher value. However, owing to the fact that the grid current is usually small at carrier level and then rises very rapidly, the value of R is not very critical.

The limitation of the rise of the grid voltage of V_1 means that the driver stage does not need to supply as much power on positive peaks as is the case in an ordinary Class "B" linear amplifier and, consequently, there should be some economy in the driving stage.

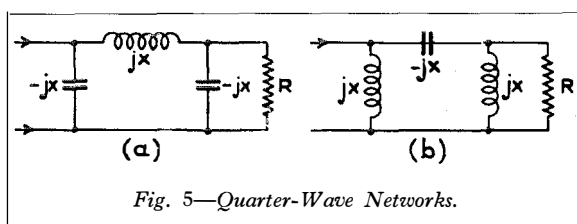

Fig. 5—Quarter-Wave Networks.

The circuit of the experimental amplifier is shown in Fig. 7. V_1 and V_2 are a pair of similar water cooled valves having three phase filaments. L_5 is the series arm of the anode quarter-wave network in which the shunt capacities are obtained by detuning the anode anti-resonant circuits L_3, C_7 and L_4, C_8 . The load resistance R_L is coupled to the anode circuit of V_2 by means of coils L_6 and L_7 , and condenser C_9 is interposed to tune out the reactance of L_7 .

Neutralising is effected from the grid circuit of each valve by using a balanced grid circuit. This requires the use of a balanced grid quarter-wave network of which C_{20} and C_{21} form the two series arms, the shunt arms being obtained by detuning L_1, C_3 and L_2, C_6 .

Meters M_1, M_2, M_8 and M_{10} are provided for reading the R.F. current flowing through C_1, C_4, C_7 and C_8 , respectively, so that the R.F. voltages across these condensers may be determined.

The resistors R_1 and R_2 form the terminating impedance of the grid quarter-wave network. A value of 10 000 ohms for each gave satisfactory operation. The resistors R_3 and R_4 are stabilising resistances.

Provision is made for connecting a cathode ray oscillograph to four points on the transmitter—grid of V_1 , grid of V_2 , anode circuit of V_1 , and anode circuit of V_2 . A harmonic filter is inserted in each line, the coil used for the purpose forming a voltage divider with the capacity of the transmission line, so that a suitable voltage is available for the oscillograph. The oscillograph is arranged so that any one of these points may be connected to the horizontal plates, and the sweep circuit of the oscillograph used, or any two points may be connected to horizontal and vertical plates, respectively.

Method of Adjustment

In order to line up the anode circuit, it is first

necessary to calculate the impedances into which the valves must work, as follows:

Applied anode volts = 10 000 volts ;
 Allowable RMS anode swing = 6 000 volts RMS ;
 Required output = 5 kW ;

Assume V_1 supplies the total carrier, then impedance into

$$\text{which } V_1 \text{ works} = \frac{6\,000^2}{5\,000} = 7\,200 \text{ ohms ;}$$

Impedance ratio of network = 4.1 ;

Impedance across output circuit (i.e., from the anode of V_2 to earth) = 1 800 ohms ;

And reactance of series arm of anode network = $j\,3\,600$ ohms.

It is found advantageous in practice to increase the output impedance and to allow V_2 to supply about 10 per cent. of the carrier; hence, the impedance was adjusted to 2 040 ohms.

The method of adjusting the anode circuit to obtain the desired impedances is as follows:

In the first place the impedance of the series arm of the network L_5 is adjusted to $j\,3\,600$ ohms by calculation, or by adjusting the coil on a bridge. A short circuit is applied between A and B , and an R.F. bridge is connected between C and D . The impedance across CD is then adjusted, at the working frequency, so that it is a pure resistance of 2 040 ohms. The adjustment is effected by varying the tuning of L_4 , and adjusting the coupling to the load R_L . The short circuit is then removed, and the bridge is connected between A and B ; L_3 is then tuned until the impedance measured is a pure resistance. If this value is not equal to

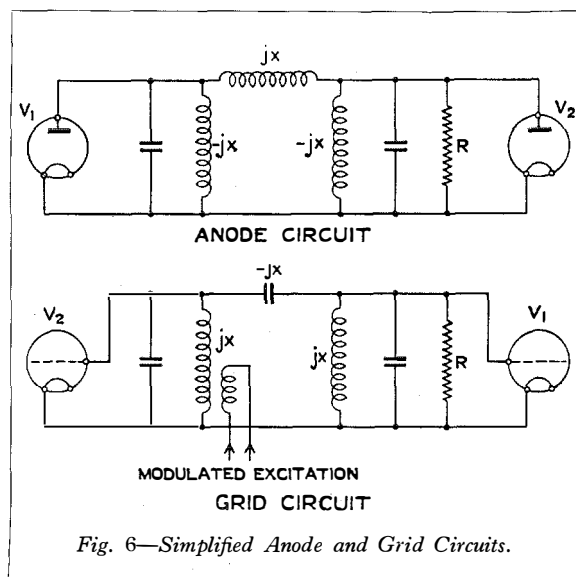

Fig. 6—Simplified Anode and Grid Circuits.

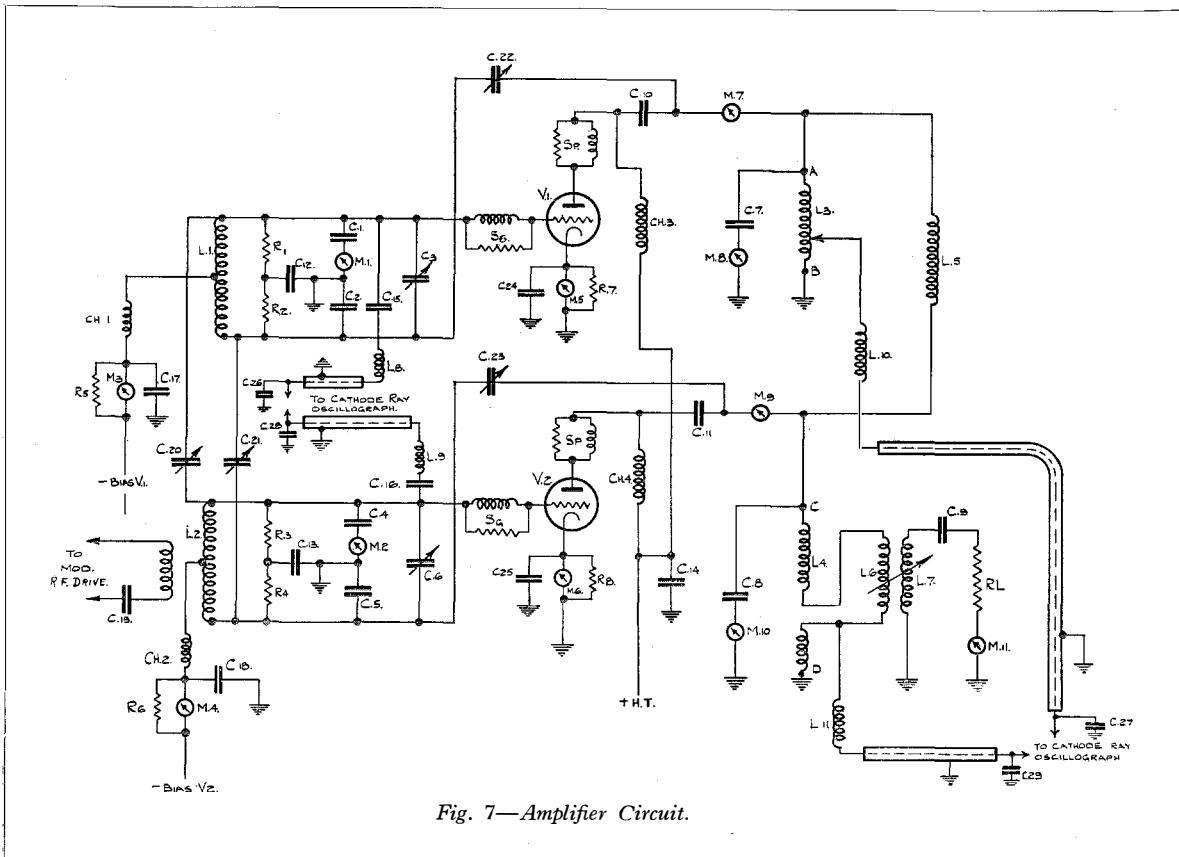

Fig. 7—Amplifier Circuit.

7 200 ohms, the impedance ratio of the network is not correct, and L_5 must be changed and the measurements done again (short circuiting AB and measuring across CD , etc.). If the impedance across AB is greater than 7 200 ohms, the inductance of L_5 should be decreased, and vice versa.

The explanation of the above method of measurement is based on the fact that, if a quarter-wave network is short circuited at one end, the other end presents an open circuit. The impedance measured across CD with AB short circuited, if a pure resistance, is therefore the load impedance; and, if a reactive component is also obtained, it indicates that the network is not a quarter-wave network. The impedance across AB indicates firstly, if a pure resistance, that the network is tuned to a quarter-wave, and secondly whether or not the network with the correct impedance ratio has been obtained.

To line up the grid circuit it is first necessary to select the terminating resistances for the

grid network, using an assumed value for the effective grid impedance of V_1 , and then if necessary to readjust the values of the resistances after measurements on power have been taken.

For example, assume a value of 12 000 ohms for R_g , then if R is the loading across the grid of the valve, we have

$$R = 0.43 R_g = 5\,000 \text{ ohms, approximately.}$$

Therefore R_1 and R_2 should each be made 10 000 ohms, and the reactance of condensers C_{20} and C_{21} should also be made equal to 10 000 ohms, which at the working frequency represents a capacity of $14 \mu\mu\text{F}$ approximately. Radio frequency drive should now be applied with the filaments of the valves cold. The grids of V_1 and V_2 are respectively connected to the vertical and horizontal plates of a cathode ray oscillograph through harmonic filters and transmission lines as shown in Fig. 7. It should be noted that the coil L_8 (or L_9) and the capacity of the transmission line act as a voltage divider,

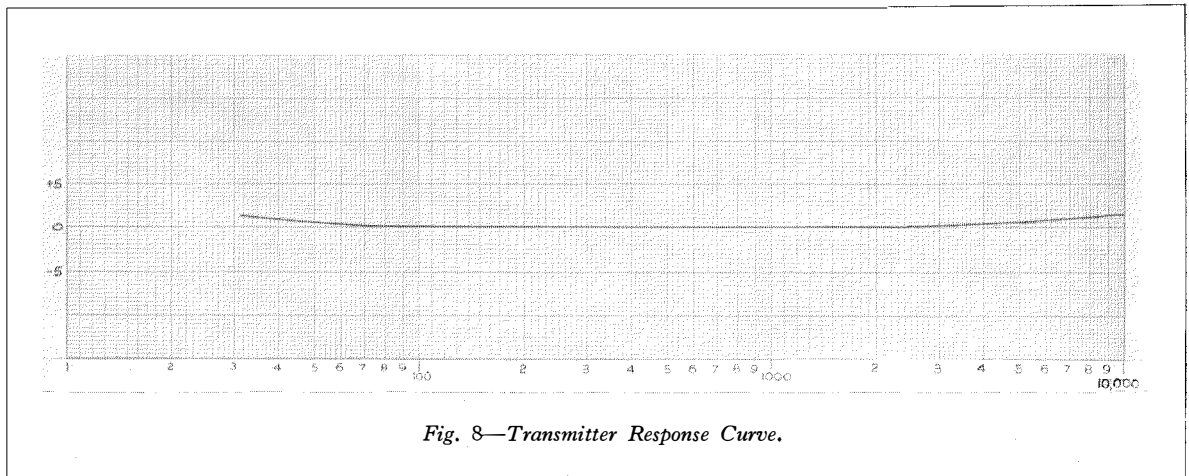

Fig. 8—Transmitter Response Curve.

and for short lines a small capacity is necessary across the oscillograph terminals. The grid circuit of V_2 is tuned for maximum circulating current, and then the grid circuit of V_1 is tuned until a circle (if the two oscillograph line filters are identical) is obtained on the oscillograph, indicating that the voltages on the two grids are in quadrature.

The final adjustment of the grid circuit must be made with anode power on the valves, after the final neutralisation has been effected and the anode circuit adjusted.

With the anode circuit set as described above, apply bias to both valves, the bias for V_1 being the normal bias for Class "B" operation, and the bias for V_2 being this value plus a value approximately equal to the RMS grid drive expected for carrier output. (For the 5 kW laboratory model these values were 300 and 900 volts.) Apply about half normal anode volts and bring on the R.F. drive until V_1 takes a small anode current.

Connect the anode circuits of the two valves to the cathode ray oscillograph. An ellipse with vertical and horizontal axes should be obtained, if the adjustment of the anode circuit has been made correctly. Check that the tuning of L3 is such that V_1 takes minimum anode current.

Increase the anode voltage to normal and adjust the drive until the desired output is obtained. Adjust the bias on V_2 until it draws between 1/6 and 1/10 of the anode current of V_1 , at the same time adjusting the drive until the correct output is obtained. Calculate the

peak anode swing of V_1 —obtained from the current flowing through C7. For high efficiency this value should be closely equal to the applied anode volts.

Retune the anode circuit of V_2 , if necessary, until the anodes of the two valves are in quadrature, making sure that the grid voltages are in quadrature during the adjustment.

Adjustment for linear operation is carried out as follows:

Apply about 60 per cent. A.F. modulation, and measure the positive and negative peaks of modulation. If they are not equal, it shows that the ratio of voltages applied to the two grids is not correct.

If the negative peak is higher than the positive peak, reduce the capacities of C20 and C21 slightly and retune the grids to quadrature (or if the negative peak is lower increase the capacities).

Readjust the drive for correct carrier output, and again compare positive and negative peaks. Repeat until both peaks are equal.

Check the peaks at 40 and 80 per cent. modulation. It may be found that the negative peak is higher at 40 per cent. modulation and the positive peak higher at 80 per cent., or vice versa. This indicates that V_2 does not come into operation at the correct part of the cycle for linear operation. Increase (or reduce) the bias on V_2 and readjust the carrier. Balance the peaks at 60 per cent. modulation and recheck at 40 and 80 per cent.

When the peaks are equal at all values of modulation, note the bias voltage on V_2 and the

reactance of the condensers C20 and C21. The transmitter should always be adjusted to these values regardless of the working frequency.

It should be noted that the above adjustment gives linear operation of the complete transmitter and not only the Doherty amplifier. One of the advantages of a Doherty amplifier is that, by correct adjustment, it is possible to balance out to a considerable extent non-linear operation caused in an earlier stage of the transmitter.

Range of Adjustability

An argument frequently brought forward against Doherty amplifiers is that the adjustment, for correct operating conditions giving a satisfactorily low degree of distortion, is critical; hence, with the average station operator, bad distortion may arise due to inaccurate adjustment. Experiments on the 5 kW model, however, indicate that the amplifier may be adjusted over very wide limits without the distortion rising above 7 per cent. As a transmitter using such an amplifier is modulated at a low power level, it is not expensive to construct the A.F. amplifier and modulator to have a very low phase shift over the working range, making such a transmitter ideal for the application of large amounts of reverse feedback.

Feedback is applied by coupling a rectifier to the output circuit, and feeding the rectifier component into a suitable point in the L.F. amplifier.

With the transmitter adjusted so that, without feedback, a harmonic content of 7 per cent. at 90 per cent. modulation is obtained, the application of 12 db of feedback will reduce the harmonic content to less than 2 per cent. The adjustment of the equipment may then be varied considerably without increasing the distortion, which will vary with adjustment between approximately 1 and 2 per cent. with a value of less than 1 per cent. for the critical optimum adjustment.

The laboratory model used a standard L.F. amplifier not specially designed for large amounts of feedback, and the feedback was limited to 10 db. With a correctly designed amplifier at least 18 to 20 db of feedback should be obtainable.

The noise level of the 5 kW model was found

to be -60 db unweighted with 9 db of feedback. A further increase of 9 db in feedback would reduce this noise level to -69 db. The three phase filament valves were connected for 6-phase operation in the above measurement.

Performance

The performance of the experimental amplifier when adjusted in the manner described above was very satisfactory, as may be judged from Figs. 3, 4, 8, and 9, in which all the relevant data is presented in the form of curves. Attention is particularly drawn to the linearity of the complete system, as shown by the curve of R.F. voltage across V_2 in Fig. 3, and to the high efficiency shown in Fig. 9 for all levels of modulation.

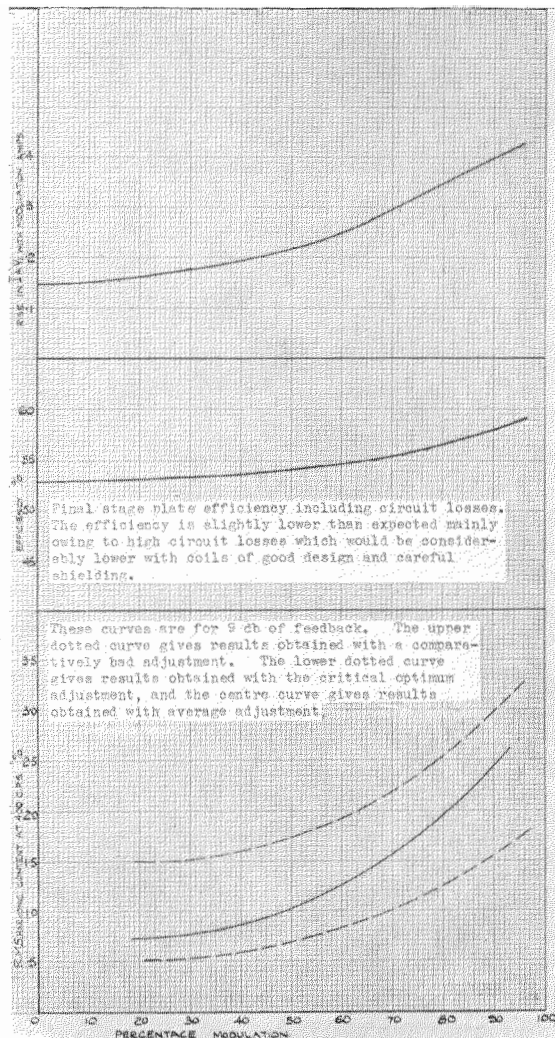

Fig. 9—Performance Curves.

Methods of Equalising Waiting Time on Calls Incoming to a Manual Board

By W. J. REYNOLDS, B.Sc., A.C.G.I., D.I.C.,

Standard Telephones and Cables, Limited, London, England

THE question of waiting time on incoming calls is of importance in all manual systems and specially so in the case of toll boards working on a demand basis. On large manual toll boards it has been almost universal to reduce the waiting time of incoming calls to a reasonable average by means of multiple answering or some similar arrangement, but no attempt is made to ensure that this average is not greatly exceeded for individual unlucky calls. Investigation on such manual boards has shown that under normal conditions a considerable number of calls may have waiting times of five times the average and that ten times the average is not uncommon.

The problem has been prominent in the recent development of automatic toll boards where it has been dealt with by introducing elaborate queueing methods which ensure that incoming calls are answered in their order of arrival. Such methods are expensive in themselves and moreover require that the operation of the board be based on the new conception of traffic distribution.

In the case of existing manual systems the problem is mainly one of improving the answering time whilst restricting apparatus modifications to a minimum. Several methods have been considered from this point of view, most of which are based not on the principle of queueing, but on the introduction of a special calling signal on calls which have remained unanswered for a certain time. The special calling signal adopted is usually "flash" or "flicker" instead of steady glow on the calling lamp. If it be desired to introduce a feature such as this on existing CLR or Trunk Demand circuits, the obvious method of introducing a change in the calling signal, after

the elapse of a given period, is to include in the line circuit an individual timing device. This may be a thermal relay or a stepping switch which is adapted to change over the lamp supply from earth to flicker after the required interval.

In schemes of this type, the most interesting problem seems to be the choice of the correct time interval. If this is made only slightly greater than the average answering time it follows that, during peak load conditions, a large number of lamps will be flashing and therefore the original problem of deviation from the average repeats itself for this group of flashing lamps. This indicates that the delay interval should be chosen so that the flashing lamp is an exceptional occurrence which operators are instructed to answer immediately. In order to cater for the considerable variation of load conditions which arises in any given exchange, it also seems desirable that the delay period should be adjustable over considerable limits in order that the traffic supervisor can determine experimentally the period which is most suitable for any given case. This requirement introduces considerable complexity in the individual timing device and tends to exclude the use of thermal relays for such a purpose.

New Scheme for Eliminating Excess Waiting Time on Incoming Calls

Consideration along these lines leads to the conclusion that if it is only desirable to have two or three lamps flashing at any time in a group of circuits, the remaining individual timing devices which are not causing lamps to flash are unnecessary. A scheme of some interest has been developed in which the calling lamps are flashed by common control circuits in such a way that the delay period before a lamp

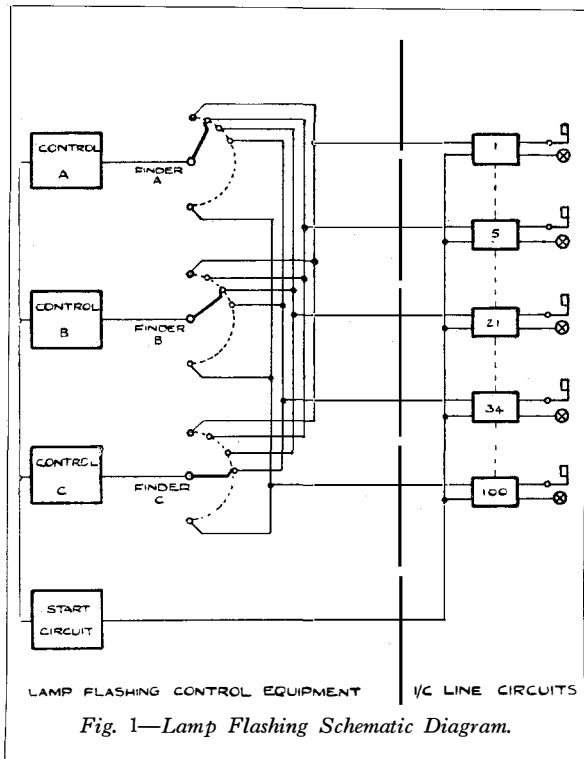

Fig. 1—Lamp Flashing Schematic Diagram.

flashes is controlled by the load on the group of lines. The number of control circuits required for a group depends in some degree on the number of lines and the traffic conditions, but it is decided mainly by the number of flashing lamps which is considered a reasonable maximum. In general three or four circuits will be the correct number for groups of 60 to 100 lines.

An equipment (Figs. 1 and 2) is being built for use with the incoming record lines of an existing toll board; it consists of a group of three control circuits with access switches which can deal with a maximum of 100 lines. With these circuits is associated a start circuit common to the group. In many cases the arrangement can be applied to existing manual exchange circuits without apparatus or internal wiring changes. All that is necessary is to wire the access cabling to the required points in the circuit. In general only one access point is required per line circuit, but in certain cases two have been found necessary.

A number of line circuits up to a maximum of 100 form a group which is associated with three control circuits, A, B and C, and a start

circuit. The finder switches are multiplied and have access to some suitable point on the line circuits so that the application of flicker to the access point causes the associated calling lamp to flicker in response. The start circuit is arranged so that it does not start up the control circuits until a certain predetermined congestion occurs. The congestion condition in question can be varied by changing the adjustment of the start relay and, in general, adjustment will be such that the system is brought into use when there are 3 or possibly 4 lines calling in the group. The finder switches are non-homing and may be on any point in the bank. When the start relay operates, the control circuits step the finders over the lines, but only one of the controls is in a condition which enables it to test for calling lines (for convenience this finder will be referred to as the "leading finder"). When a new cycle commences, the leading finder is the one which was left in this condition after the previous operation of the system.

The method of operation can be made clear more easily if the various functions of the circuit are treated separately. The method of controlling the search for calling line circuits will first be considered.

Suppose that A is the leading finder and seizes a calling line on outlet 5, it remains on this outlet without change until finder B reaches outlet 5. When this occurs, B takes over the leading finder condition and will then step on, but on subsequent outlets it will test for calling lines. A second bank on the finder is used for controlling the leading finder condition. If a line is calling on outlet 21, B will stop on this outlet and remain without change of condition until C, which has been driving without testing lines, reaches the same outlet. C will then stop, take over the leading finder condition from B and then step on and test for the next calling line, which may be on outlet 34. C will stop on this outlet. It will therefore be seen that finder C does not test outlets 1 to 21, it being argued that any calls which might be in this range have arisen subsequent to the search by the earlier finders and are therefore more recent than that on which B is resting. Search for calling lines is therefore controlled by two conditions:

- (1) Finders do not commence operation until a certain predetermined congestion arises ;
- (2) Finders do not search for a calling line until they have taken over the leading finder condition. This means that search is made only in a part of the bank which has been untested for the longest time and in which, therefore, any waiting calls are more likely to have been waiting a longer time than the average.

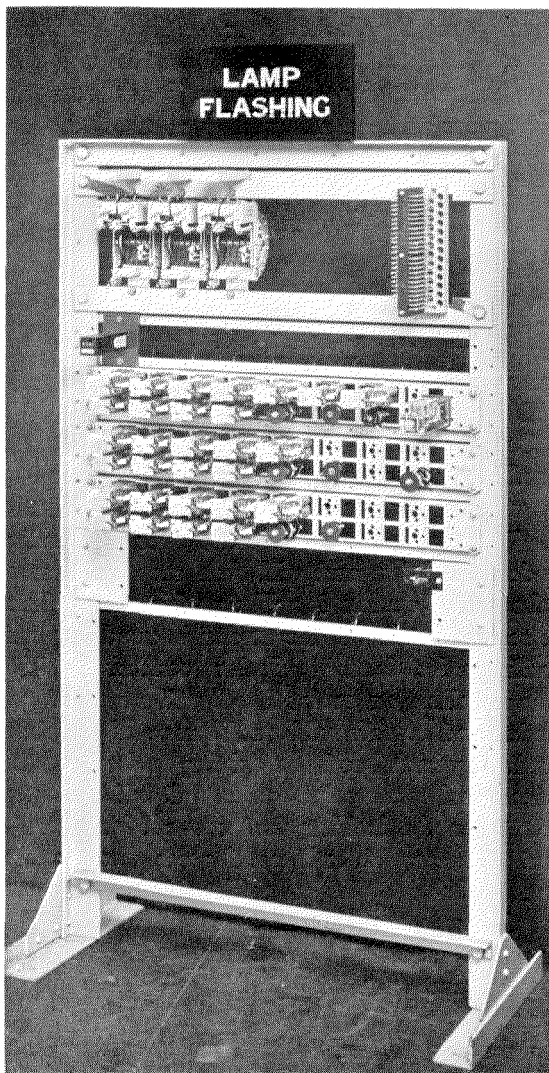

Fig. 2—Equipment for Eliminating Excess Waiting Time on Incoming Calls.

As soon as the line on which a finder is resting is answered, the control circuit is released and will drive as before. Thus if A is released it will drive to outlet 34, take over the leading finder condition from C and then search for the next calling line.

Having seized certain calling line circuits as described above, the second function of the system is to flash the calling lamps after a delay. One method of doing this would be to introduce a timing device in each control circuit, so that the lamp would be flashed if it remained unanswered for a given period after the control circuit has seized the line circuit. The actual method adopted does not require additional apparatus in the control circuit and consists in flashing the lamp of the associated circuit as soon as the control ceases to be the leading finder. Considering the case of outlet 34, the circuit is seized by control C and when the call on A is answered, this control drives from outlets 5 to 34 ; it then takes over the leading finder condition from C and the lamp with which C is associated then commences to flash. The delay period therefore consists of the answering time of a flashing call (Control A) plus the stepping time to the last outlet which was tested by a control (Control C). In other words it is dependent on answering time and on the congestion, since the latter governs the number of steps the switch takes in a given case. The finders are stepped under relay control, so that stepping speed can be set to give a reasonable basic delay.

Space does not permit a complete analysis of the various factors which enter into the operation, but they can be summarised as follows :—During congestion periods N control circuits search steadily over the group at a rate determined by the answering time, the number of calling lines encountered, and the stepping speed of the finders. At any moment $(N-1)$ lamps will be flashing and, since a finder only searches over lines which have been least recently tested, these lamps will be those associated with calls which have been waiting for some time before becoming associated with a control circuit.

The system does not give absolute equality of answering time, but it does ensure that no call can be left unanswered for a period greatly

in excess of the average. Since the number of lamps which can flash is fixed, and the delay before a lamp is flashed is controlled by various traffic factors, the flashing lamp is always an emergency signal to be answered at once. No matter what the traffic condition on the manual board may be, the operators cannot be faced with a condition where all the calling lamps are flashing. This condition may arise very easily during load transition periods if individual timing devices are used in the calling lines. Compared with any scheme using individual timing devices, the system described has the advantages of being exceedingly economical in apparatus cost and requiring a minimum of modification to existing equipment.

The Development of the Rio de Janeiro Automatic Telephone Network

By W. HIRSCH,

*Assistant Chief Engineer, Brazilian Telephone Company,
and*

E. A. BRANDER,

Engineer, International Standard Electric Corporation, Rio de Janeiro, Brazil

This article gives a brief outline of the development of the Rio de Janeiro automatic network owned and operated by the Brazilian Telephone Company.

RIO DE JANEIRO, the capital of Brazil and the most beautiful city of South America—known all over the world for its marvellous scenery and natural surroundings—during recent years has made remarkable progress, which has been reflected in the city's telephone system.

On January 1st, 1930, the official statistics showed a density of 2.9 telephones per 100 inhabitants. In January, 1934, the population was estimated at 1 717 000, while the number of telephones amounted to 55 450—equivalent to 3.23 telephones per 100 persons. According to recent figures, the population has almost reached the two million mark with 86 000 telephones in service, representing 4.8 per 100 persons. The central offices are actually equipped for 78 300 lines; 25 000 additional lines are on order and will be installed during 1938 and 1939.

The 29 000 lines that existed in 1929 were distributed over seven manual C.B. exchanges, and the first 7A.1 Rotary automatic type office was opened to traffic on January 1st, 1930. The ultimate stage of conversion from manual to full automatic operation will be reached in 1939, when the last manual office, "25," will be replaced by an automatic office, "25," of 8 000 lines of the 7A.2 Rotary equipment.

Fig. 1 shows the steady increase of automatic and decrease of manual subscriber lines in operation since 1930.

Equipment

The automatic exchange equipment consists of 7A.1 and 7A.2 Rotary systems manufactured by the Bell Telephone Manufacturing Company, Antwerp.

Rio de Janeiro is situated on the South Atlantic seaboard and has a sub-tropical climate despite its geographical location within the torrid zone. The humidity and temperature are elevated during the hot season, and experience has shown the necessity of using semi-tropical finish for the automatic equipment.

The problem which invariably presents itself in tropical countries is whether the equipment shall be designed for the prevailing tropical climate or whether atmospheric conditions within the exchange shall be controlled to suit the standard equipment designed for temperate climates.

Air-conditioning has been tried out and is actually in operation in two exchanges. One is office "27" located at the waterfront, where during the first year the automatic equipment installed showed signs of corrosion caused by the sea air. The other exchange is "22/42" in

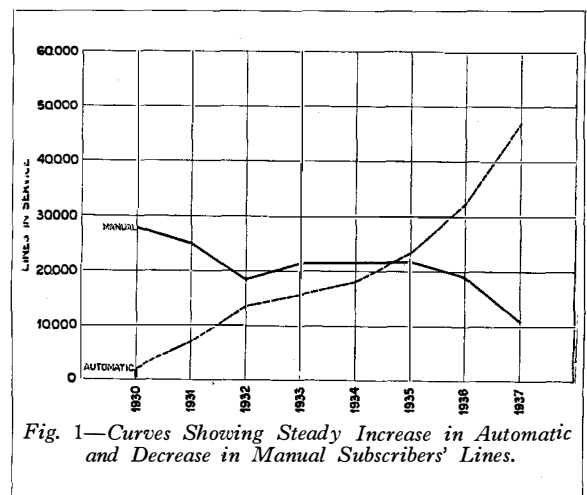

Fig. 1—Curves Showing Steady Increase in Automatic and Decrease in Manual Subscribers' Lines.

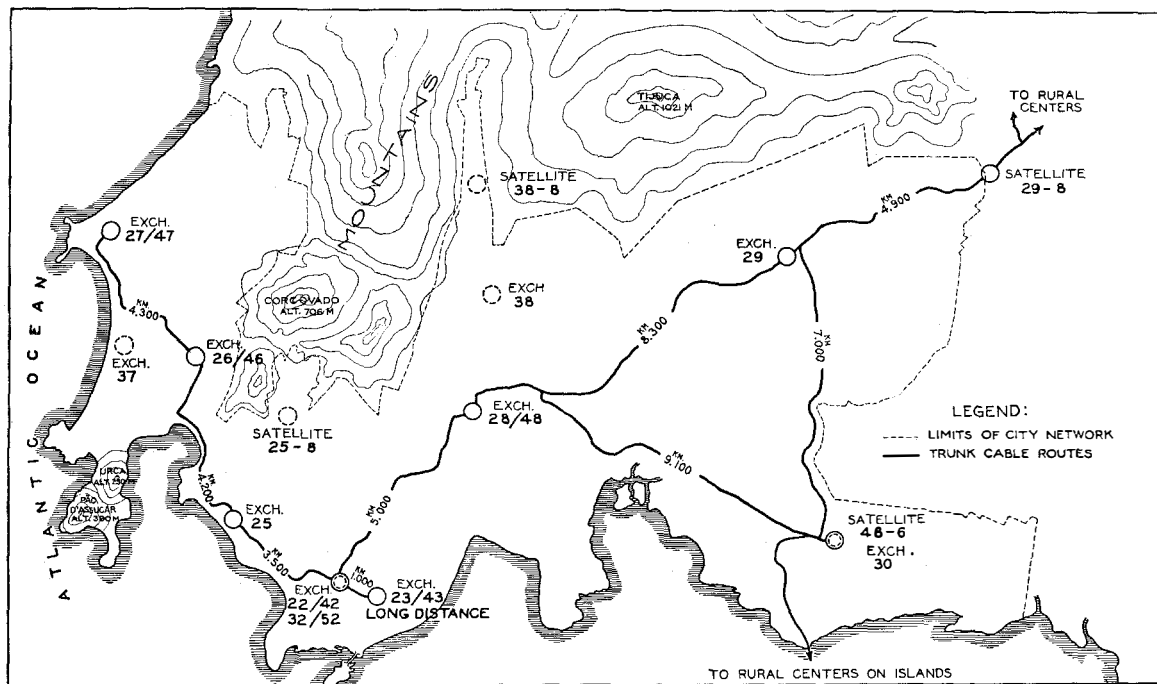

Fig. 2—Geographical Location of Telephone Offices and Trunk Call Routes at End of 1937.

the business part of the town, where the restricted space makes natural ventilation impossible, and the air is very much polluted due to the location of the exchange in the vicinity of a foundry.

By the term "air-conditioning" is meant cleaning, de-humidifying, cooling and circulating, as well as periodically renewing, the air in the exchange building. Heating is not required at any time of the year. Experience has shown that the expenditures involved in building design and first cost of air-conditioning machinery, as well as the continuous operating cost—mostly power bills—are so high that full air-conditioning can only be resorted to in special cases.

The Rotary equipment as now designed for Rio de Janeiro appears to stand up to the climate perfectly well in all but exceptional cases at the seafont. To achieve this result it has been necessary to select materials adapted to the climate, rather than to endeavour to make standard materials suitable by impregnation or other special treatment after manufacture. The high degree of humidity always present in the atmosphere of tropical countries necessitates the use of non-hygroscopic materials, and the high

temperature makes it necessary to avoid compounds with low melting points.

Electrical losses in apparatus such as relays, resistances and other coils tend to heat them to a higher final temperature than they would normally assume in temperate climates. By suitable windings and adequate spacing of such apparatus the temperatures can easily, and at relatively small expense, be kept down without air-conditioning of exchange buildings. In recent years the application of acetate treatment for wire, and the use of Cotopa insulation in the manufacture of switchboard cables, seem to mark an important step forward in obtaining increased insulation resistance of multiples and cable forms.

Based on this experience, only ventilating plants with filtering of the air to remove dust, have been considered for recent exchanges.

The city of Rio de Janeiro at present contains eight central offices (of 20 000 line capacity) and two satellites located in nine buildings. Three new central offices will be installed during 1938.

Fig. 2 shows the geographical location of the various offices, the trunk cable routes existing at the end of 1937, and the lengths of cables between the exchange buildings.

With the exception of the Central exchange building, which at present houses two 10 000 line units, offices "22" and "42," and to which two more units will shortly be added ("32" and "52"), all buildings were constructed to accommodate two 10 000 line units. In several cases one of the units is of the 7A.1 Rotary type while the second one added at a later date is of the 7A.2 Rotary type. These twin offices have common main distributing frames, power plants and trunking equipment.

A two figure prefix concealed in the subscriber's number is allotted to each central office, while satellites are designated by three figure prefixes consisting of the two figure prefix of the exchange to which the satellite is connected and the first figure of the 2 000 lines reserved for the satellite in the particular central office. The final capacity of an office to which a satellite is connected is decreased from 10 000 to 8 000 lines.

Table I shows the prefixes allotted to the various exchanges, the number of lines installed and ordered and the type of equipment supplied.

Numbering

The level numbering diagram shown on Fig. 3 is identical in all offices in the Rio de

Janeiro area. It will be noted that first group selector levels 1 and 10 are reserved for special services, while levels 2, 3, 4, 5, 6, 8 and 9 each accommodate one twin exchange of 20 000 lines.

Level seven relates to routing calls with prefixes 3 and 5 to auxiliary first group selectors to be added in all exchanges in 1938. The 10 levels of the auxiliary first group selectors will provide the facility of connecting an additional 10 twin offices, each of 20 000 lines capacity with prefixes "30" to "39" and "50" to "59."

The numbering capacity of the area thus will total 340 000 lines or 34 units of 10 000 lines each.

The original capacity of the area was 80 000 lines, with registers equipped for five-digit dialling. By the conversion from five to six digits in 1934, the capacity was brought up to 160 000 lines. With the introduction of auxiliary selectors, the registers will be modified to the final numbering capacity of 340 000 lines.

A typical junction diagram of a twin office equipment is shown in Fig. 4.

Traffic

For the area, the average originating traffic per line for the busy hour is of 2.8 calls, and the average holding time is 82 seconds per call,

TABLE I

Prefix	Regular Lines		Coin Box Lines	P.B.X. Lines		Manual C.B. Lines	Remarks
	7A.1 R.S.	7A.2 R.S.		Numbered	Un-numbered		
"22"	9 000	—	—	1 000	400	—	In service
"42"	—	9 000	400	600	—	—	" "
"23"	5 600	—	—	800	300	—	" "
"43"	—	6 000	400	600	—	—	" "
"43"	—	3 000	—	—	—	—	Cut-over 1938
"25"	—	—	—	—	—	4 800	In service
"25"	—	8 000	—	—	—	—	Cut-over 1939
"26"	—	6 800	200	—	—	—	In service
"28"	—	—	—	—	—	6 800	" "
"28"	—	9 600	200	200	—	—	Cut-over 1938
"48"	—	7 600	400	—	—	—	In service
"29"	5 000	—	—	—	—	—	" "
"29"	1 600	—	400	—	—	—	Cut-over 1938
"30"	—	3 000	—	—	—	—	" " "
"38"	—	8 000	—	—	—	—	" " "
"26"	—	3 000	—	—	—	—	" " "
"27"	9 800	—	—	200	—	—	" " "
"47"	—	3 800	200	—	—	—	In service
"48-6"	—	1 350	100	—	—	—	Cut-over 1938
"29-8"	1 000	—	150	—	—	—	In service
							" "

SUMMARY

Automatic lines equipped end 1937	66 700
Manual " " " " " "	11 600
Automatic lines under installation or ordered	41 000

including local, special service, and trunked calls between exchanges.

The average holding time before the introduction of automatic service was 125 seconds per call. The number of calls was correspondingly lower, and the total volume of traffic (call-minutes) per line remained practically unchanged during the conversion from manual to automatic. No tariff change was made during this period. Unlimited service both for residential and business telephones is still in force, although recently a measured rate has been under consideration.

To facilitate the traffic survey and engineering of new equipment, so-called Direct Reading Traffic Recorders of the Rotary type have recently been installed in several exchanges. They permit the direct observation, on a small number of meters, of traffic densities in EBHC without involved calculation. The recording meters, by means of switching keys, may be rapidly associated with any one of the trunking groups to be observed.

The following traffic figures can be directly read in 2-minute calls (EBHC) :

- (a) Originating traffic (separately) for the regular and overflow line finders per group of 200 lines ;

- (b) The register link traffic ;
- (c) The register traffic ;
- (d) The terminating traffic per group of final selectors ;
- (e) The outgoing traffic per direction ;
- (f) The total incoming toll traffic.

Power Plants

The power plants are of the full float, double-battery, manually operated type.

The voltage limits are 46 volts minimum and 51.75 maximum. The batteries can be used either in parallel or individually. The normal floating tension of the battery is 2.15 volts per cell with a minimum of 2.1 and a maximum of 2.2 volts. The main battery equipment consists of 23 elements, the normal floating voltage thus being 49.5 volts with a minimum of 48.3 and a maximum of 50.6 volts. For emergency discharge, 3 end cells are provided per battery, which can therefore be increased to 26 cells.

The starting and stopping of the generators, the cut-in and cut-out of rectifiers, and the switching in or out of the 23 cells of the main batteries and the three end cells are performed manually.

The generators are of the shunt type, directly

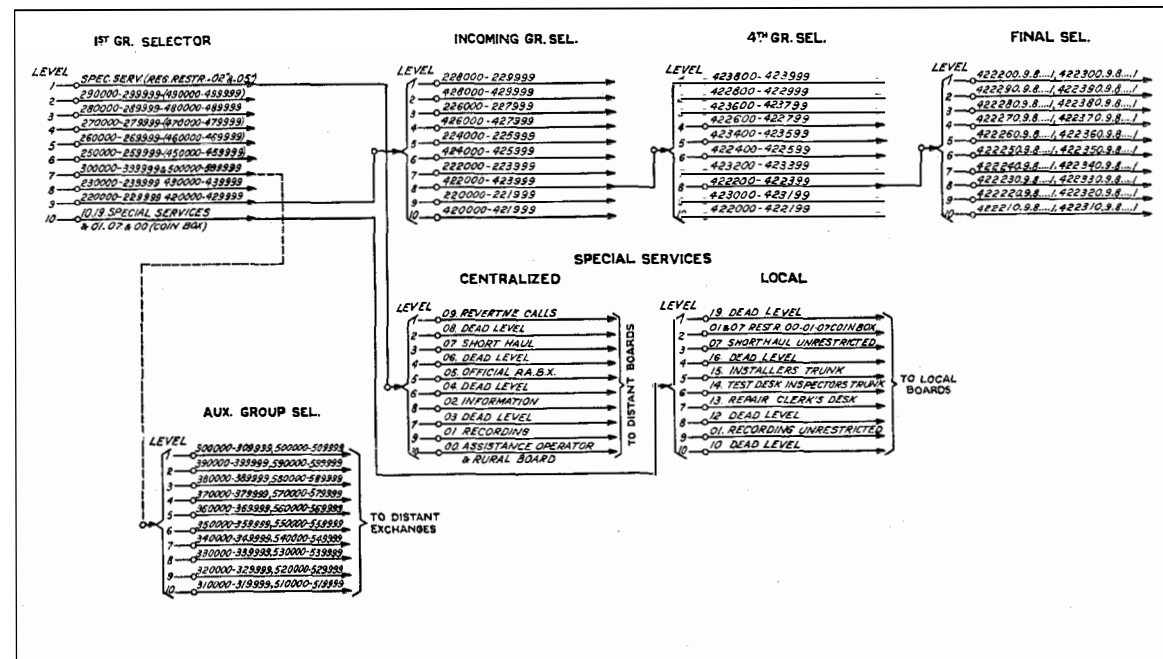

Fig. 3—Level Numbering Diagram.

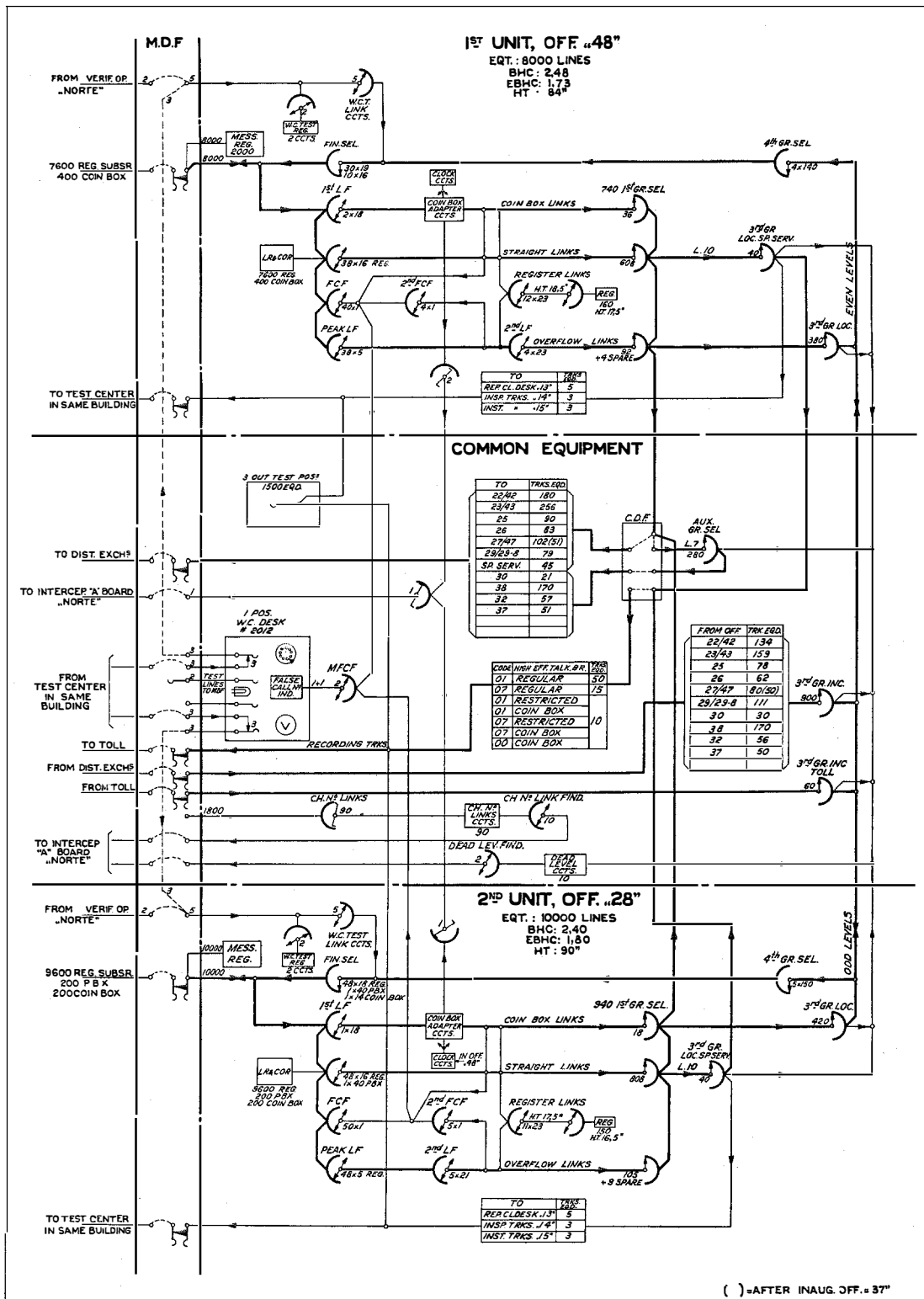

Fig. 4—function Diagram Exchanges "28/48".

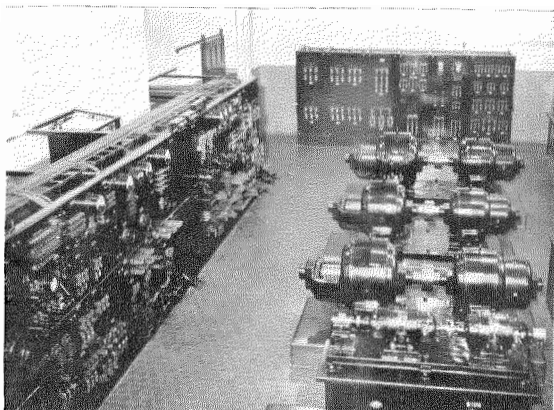

Fig. 5—Exchange "22/42" Machine Room.

coupled to three-phase asynchronous motors with built-in centrifugal starters.

For night floating, 60-ampere Hot Cathode Mercury Vapour Rectifiers are used. Selenium type rectifiers will be used in connection with power plants on order.

Automatic voltage regulators consisting of a solenoid type voltage relay, motor driven field rheostat and a Telechron motor interrupter maintain the tension on busbars within the prescribed limits of 49.5 ± 0.25 volts.

For measurement and testboard purposes, the dry rectifiers connected to the main supply deliver simultaneously D.C. of 20, 100 and 200 volts. Instead of rectifiers, future installations will be provided with motor generator sets consisting of an asynchronous motor and a generator delivering 200 mA of 20, 100 and 200 volts D.C. The voltage limits will thus be less dependent on the main power supply than is possible with rectifiers.

Two ringing machines are installed per twin exchange; one is A.C. and the other D.C. driven, arranged for automatic changeover in case of mains failure.

These machines supply ringing current, 110 volts D.C., positive and negative, for coin box circuits and ringing current superimposed on the 48-volt battery.

In 7A.2 offices, the ringing machines drive mercury type, slow speed interrupter sets.

The howler tone is obtained by a separate, high speed interrupter directly driven by a small shunt motor mounted on the power board.

The power plants are designed for an ultimate capacity of 20 000 or 40 000 lines.

To illustrate a few typical equipments: Fig. 5 represents the exchange "22/42" machine room, and Fig. 6 the exchange "26" battery room.

Metering

The tariff in the Rio de Janeiro area is flat rate for both residence and business subscribers. With the rapid station growth, tending to increase the calling rate, the introduction of a measured service had to be considered. All exchanges are now equipped for this eventuality.

It is only intended to apply the measured rate for business subscribers, while residential telephones will remain on the flat rate.

In order to avoid difficulties due to partial equipment of message registers, such as,

- (a) Meters not mounted numerically,
- (b) Rejumpering in case message rate is also introduced for residence lines, and
- (c) Change of strapping on cut-off relays, involving non-uniform wiring and difficult maintenance,

a plug-in type message register and a plug-in



Fig. 6—Exchange "26" Battery Room.

resistance of 2 400 ohms were designed. They provide the facility of adapting at will a line for flat or measured rate service by simply plugging in the resistance or the message register as the case may be. Full cabling of meter wires between main and distribution frame and message register rack has been provided.

Provision was made for a metering control device in the form of portable impulse printers. Adapter circuits located in the terminal room of the various offices and cabled to the main distribution frame are available for connecting any subscriber's line and checking the operation of his metering equipment.

These printers record on a paper strip the called subscriber's number, the time at the beginning and end of a call, and whether the call was metered or not. The latter indication is necessary since many classes of calls, such as those involving toll recording, special services and the Telephone Company's P.A.B.X., are offered free.

Fig. 7 shows a message register rack for 7 000 lines, equipped with a few message registers and resistances.

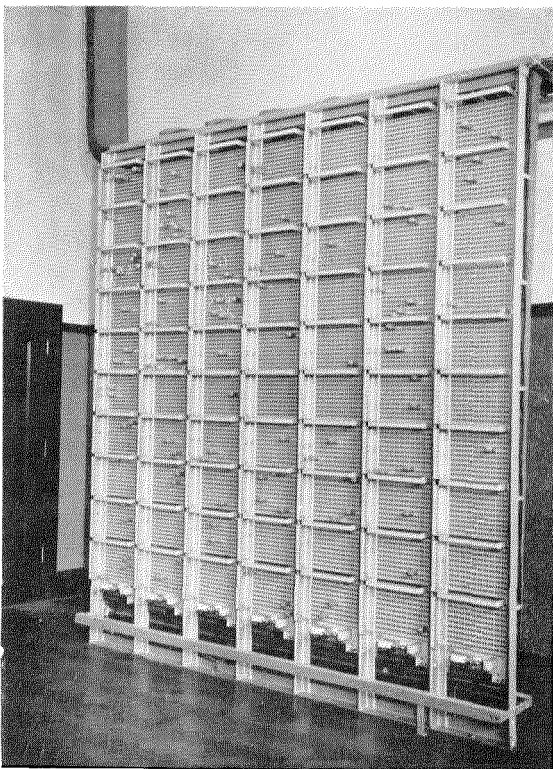

Fig. 7—Message Register Rack for 7 000 Lines.



Fig. 8—50-Position Information Board.

Special Services

The ordinary subscriber naturally has a very vague idea of all the complicated central office machinery which serves him faithfully—apparently without human help—through the extremely simple operation of dialling. The constant efforts of the maintenance staff to keep the machinery in satisfactory operation are unknown to him. To create the necessary human contacts between the Telephone Company and the public, several special services attended by operators have been established. According to the trunking method adopted, they are classified as “centralised” or “local” and 2 levels of the first group selectors are reserved for the special service calls, which are reached by subscribers dialling 2-digit codes. Generally the local special services are grouped together per exchange or district, and those which are centralised serve the whole city network. The division in local and centralised special services is made only for convenience of traffic handling by operators and economy of trunking plant.

Intercepting Service

As the turnover of subscribers is very high in Rio de Janeiro, where there are actually 26 disconnections and 36 new connections for every 10 telephones gained, and number changes often are unavoidable due to the introduction of new exchanges and conversion from manual to automatic, it is necessary to provide very ample intercepting facilities. Whenever a number is changed or disconnected, the line is connected on the main distributing frame to a dead line, or changed number circuit, and left there for approximately 6 months. Calls to such lines are routed over sets of line finders

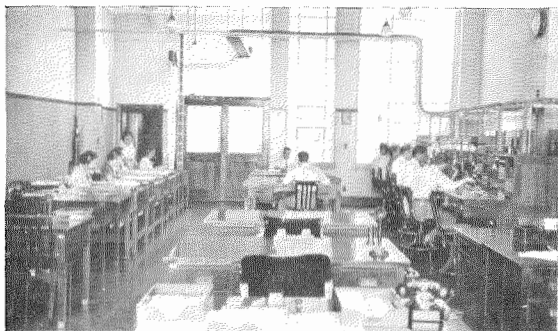

Fig. 9—Business District Test Centre.

to operators at a centralised board in exchange "23/43." In the daytime a total of 12 operators attend continuously to this service, which not only assists subscribers but also relieves the exchanges of the artificial load created by repeated calls to discontinued numbers.

The vacant levels on selectors are brought to the centralised intercepting board in a similar manner. Although the traffic to these levels is relatively low, interception of these calls has also been found advisable.

Centralised Information Service

Information service supplements the directory in order to keep subscribers advised regarding changes and additions during the directory period. For this reason alone the information board in Rio de Janeiro would be heavily loaded. The load is further increased, however, due to the widespread habit of using first names in daily conversation, instead of family names which are listed in the directory, and the large element of immigrants with foreign names.

It was found necessary to provide for the most up-to-date information service, and in 1936 a centralised 50-position board with automatic call distribution to operators was installed. The board is equipped with Rotary files which give each operator direct and speedy access to 120 000 listings.

A picture of the board in the busy hours of the day is shown in Fig. 8.

The 50 operators actually handle 3 000 calls during the busy hour. Access to the board is practically instantaneous with 3-5 seconds waiting time when the traffic is abnormally high.

Automatic subscribers reach the information

board by dialling "02." Such calls are routed over first levels of 1st group selectors in the various exchanges to centralised 2nd group selectors and trunk finders located in the building of exchange "23/43." The information trunks from the toll board and manual exchanges end directly on trunk finders. Two trunk finder groups are provided, one of which serves the traffic originated by the toll operators while the 2nd group is common both for automatic and manual trunks.

The incoming trunk finders are of the 100 × 5 point type and as many as 80 operators' positions can be connected, while the remaining 20 terminals are reserved for parking, transfer and overflow.

The regular trunk circuits are provided with 15 common parking terminals and one common parking circuit, while the preference trunk circuits from toll are equipped with three common parking terminals and one common parking circuit.

The transfer trunks to supervisor are common for preference and regular incoming trunks, and

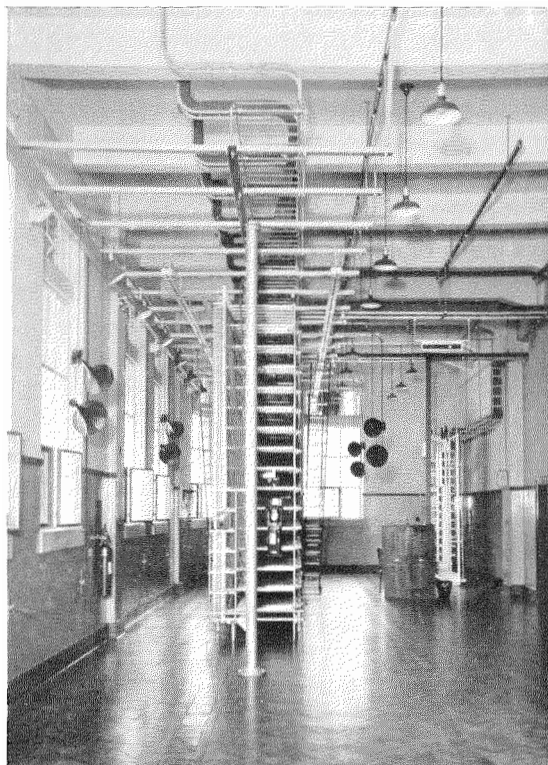

Fig. 10—Main Frame Room in a Small Exchange.

At the moment a position becomes free, an indication is given by the waiting call circuit, which makes the finder on which the first parked call arrived free and causes it to hunt again and test, on the free position. At this moment all remaining parked finders are advanced by one position in the arc.

In case more than one position becomes free at a time, all waiting finders start hunting in the sequence in which they were located on the waiting terminals. Those finders which are successful in testing on a free position are stopped in the regular way, whereas the remaining finders test again on the waiting call terminals in the same sequence as before.

During this hunting of waiting finders all other incoming calls are prevented from testing, so that the waiting calls have preference over fresh incoming calls.

The skeleton trunking diagram of the information board is shown at the bottom part of Fig. 11.

Repair Service

The repair service for subscribers' lines and telephone sets is handled over a repair clerk's desk where the complaint or trouble report is recorded, and a test desk where the cause of troubles is located and repair men despatched to clear them.

The city has been subdivided into three districts, each with a number of repair clerks' desks and test board positions. The business district test centre is located in exchange "22/42" building and is illustrated in Fig. 9. The repair clerks' desks will be noticed on the left-hand side. They have key-ended trunks for attending incoming calls, and each operator has access to 10 000 card records. Each card contains the complete record of each subscriber's installation and history. When a trouble is reported, the card is passed via the supervisor to the test desks, seen at the right-hand side. These desks are provided with a 100 000 ohm voltmeter and complete testing equipment to verify all line conditions.

Normally the subscribers' lines are reached over the test finals without the aid of any frame man in the distant exchanges.

For many cases, particularly new installations and cable testing, it is necessary to be in direct

contact with the main distributing frame in the exchanges. Therefore test lines to M.D.F.'s are equipped and terminated on jack panels on the frame. Orders for connecting up lines for test, and other instructions, are in these cases transmitted directly over a loud-speaking system, with loud-speakers near the frame and talk-back transmitters, thus making it possible to maintain a 2-way conversation from any point in the M.D.F. rooms and the test centre desks.

Only dynamic loud-speakers, without amplifiers, directly operated by the test desk transmitters, are used. The system operates very satisfactorily, provided room noise in the frame room is kept at a low level. In some cases acoustic celotex had to be applied to dampen the noise and echoes in large rooms.

This testing system has now been extended to all exchanges and satellites. As a further feature to facilitate and speed up the repair service, special service trunks reached by dialling "14" and "15" have been extended to the test desks. When a repair man dials these codes from a subscriber's set connected to a 7A.2 Rotary exchange, he obtains a metallic through connection to the desk, and the tester can verify the line conditions, dial speed, etc., without further switching manipulations.

The main frame room with loud-speakers in a small exchange is shown in Fig. 10, and a skeleton switching diagram for a test centre is shown in Fig. 11.

Future Developments

The switching system for Rio de Janeiro is now developed in all details, and no radical changes are foreseen for an extended period. When the numbering capacity is exhausted, the time probably will be ripe for the introduction of tandem trunking.

Studies are being made for the automatization of the exchanges in the rural district, outside the city limits but within the Federal district. These exchanges now are of the magneto type and employ direct dialling by the local operators into the city network. Calls to rural are completed via the "assistance operator" (dial "00"). These networks can without difficulty be fitted into the automatic system, which appears to be fully flexible for all eventualities.

Some Problems of Hyperfrequency Technique

By A. G. CLAVIER and E. ROSTAS,

Les Laboratoires, Le Matériel Téléphonique, Paris, France

THE practical development of commercial communication by means of oscillations of the higher radio frequencies (centimetre waves) involves much research into many technical problems in a region which so far has been only slightly explored. This research is, however, amply justified by the properties already known to be associated with these waves, the application of which is moreover not limited to radio communications but extends also to communication by waves travelling along dielectric guides. Development of this latter system appears indeed to be dependent on the development of centimetre wave oscillations, or of oscillations of still higher frequency, if impracticable dimensions of the dielectric guide are to be avoided.

The three short investigations described below form selected "units" in the general body of research work necessary to the evolution of an engineering technique for dealing with communication problems involving centimetre waves. They cover: (1) generation of the higher frequencies; (2) frequency stabilisation of a micro-ray oscillator; and (3) the use of reaction methods to control damping in a 3 000 megacycle receiver circuit. As "units," the scope of each investigation is narrowly restricted, and there is little apparent connection between them; but taken together they illustrate the variety of the problems which are encountered, and taken individually each furnishes some contribution to the general knowledge of a new branch of the art.

(1) GENERATION OF HIGH FREQUENCIES

The triode oscillators herein described are designed on a basis of cylindrical symmetry,*

*"Production and Utilisation of Micro-Rays," by A. G. Clavier, *Electrical Communication*, July, 1933.

and include a tungsten filament, a helical grid or "oscillating electrode," and an outer cylindrical plate or "reflecting electrode." Various examples reproduced from X-ray photographs are shown in Fig. 1. They are of the type used in the experimental micro-ray circuit installed between Dover and Calais in 1931.

While the wavelength generated by such triodes is definitely influenced by the external output circuit, which is connected across the two ends of the helical oscillating electrode, it is also influenced both by the tube constants and by the operating potentials. For a given tube it is possible to obtain oscillations over a range of adjustments in which changes in the output circuit are compensated by changes in the operating potentials to give constant wavelength; but, corresponding to each wavelength, there is one particular set of conditions in which maximum output is obtained. A curve of maximum output against wavelength usually exhibits one or more peaks, marking what are referred to below as the "optimum wavelengths" for that particular tube.

In order to ascertain how the optimum wavelength is related to the tube geometry, particularly as regards grid diameter, number and spacing of grid turns, and plate diameter, tests were made on a number of batches of specially manufactured tubes in which the factors just mentioned were deliberately varied. The results are shown in Table I, which gives in each column representative figures for a particular batch. While the individual batches were rather small in size, all the tubes in any one batch were reasonably uniform in performance.

Referring now to Table I, the tube shown as Type A is that used on the Dover-Calais experimental link. With a grid diameter of 3.5 mm, a grid of 17 turns with spacing of

TABLE I
CONSTANTS OF TYPICAL MICRO-RAY TUBES

TYPE	A	J	C	S	T	U	Y	X	AC	AD	AF	AE	AI
Grid Diameter, mm.	3.5	3.5	2.5	2	2	2	2	2	2	1.5	1.5	1.0	1.0
No. of Grid Turns	17	14	20	18	18	15	13	11	11	14	12	14	14
Grid Turn Spacing mm.	0.8	0.96	0.75	0.84	0.84	1.0	1.16	1.38	0.84	0.85	0.84	0.85	0.85
Plate Diameter, mm.	8.7	8.7	7.5	7.5	5.0	7.5	7.5	7.5	7.5	7.5	7.5	7.5	5.0
Optimum Wavelength, cm.	17.4	14.8		18			17			14.4			
Adjustment ..	$\frac{350/80}{70}$	$\frac{480/110}{70}$		$\frac{300/30}{80}$			$\frac{400/60}{80}$			$\frac{300/91}{50}$			
Wavelength, cm.			9.2	9	9.4	9	7.6		10	7.6			
Adjustment ..			$\frac{400/108}{80}$	$\frac{350/115}{80}$	$\frac{400/84}{75}$	$\frac{400/92}{75}$	$\frac{420/152}{72}$		$\frac{300/95}{50}$	$\frac{400/180}{50}$			
Wavelength, cm.				6.6									
Adjustment ..				$\frac{500/210}{85}$									

Adjustment shown as $\frac{350/80}{70}$ means: Grid Voltage = 350 V. Plate Voltage = 80 V. Grid Current = 70 mA.

0.8 mm, and a plate diameter of 7.5 mm, the optimum wavelength is 17.4 cm. The effect of a limited reduction in the number of grid turns (without change of axial length) is shown by the Type J tube, in which the reduction of grid turns from 17 to 14 was accompanied by a decrease in the optimum wavelength from 17.4 cm to 14.8 cm. Further reduction in the number of grid turns, however, resulted in tubes which failed to give any sign of oscillation, at any rate within the wavelength range under immediate consideration.

The Type C tube shows the marked effect of reduction in grid diameter from 3.5 mm to 2.5 mm. Despite an increase in the number of turns, the optimum wavelength was lowered from 17.4 cm to 9.2 cm.

The characteristics of this type of tube were so promising that a further series of tubes was constructed with grid diameters of 2 mm or less, notwithstanding considerable design difficulties encountered in maintaining the grid helix rigid under the high temperature resulting from an energy dissipation of about 30 watts under normal operating conditions.

The Type S tube, with a grid diameter of 2 mm and 18 grid turns, exhibited three well marked optimum wavelengths of 18 cm, 9 cm, and 6.6 cm. A decrease of the plate diameter from 7.5 mm to 5 mm (Type U) resulted only in the disappearance of the 18 cm and 6.6 cm wavelengths, leaving the intermediate wavelength slightly modified to 9.4 cm.

Returning to the original plate diameter of 7.5 mm, and using a 2 mm grid with turns reduced in number to 15 (Type U), a single optimum wavelength of 9 cm was again obtained. A further reduction in grid turns from 15 to 13 gave (Type Y) a tube yielding two optimum wavelengths of 17 cm and 7.6 cm. Still further reduction of grid turns was however unsatisfactory, the tube Type X apparently refusing to oscillate.

In the case of Type AC, the same number of grid turns was used as in the unsatisfactory Type X, but the axial length of the grid was reduced to give a grid-turn spacing of 0.84 mm instead of 1.38 mm, as the closer spacing had previously been found conducive to the generation of strong oscillations. The result was a tube with a single optimum wavelength of 10 cm. A rather similar tube with the grid diameter reduced from 2 mm to 1.5 mm (Type AD) gave two optimum wavelengths of 14.4 cm and 7.6 cm. Further reduction in either number of grid turns or in grid diameter (Types AF, AE, and AI) failed to yield tubes giving oscillations which could be detected with the measuring equipment available.

On all occasions when oscillations were observed it was found that, for a fixed wavelength, the relationship between the grid and plate potentials, and between these and the amplitude, followed the same general laws as were originally observed with the 17.4 cm tubes used on the Dover-Calais micro-ray link. This

is illustrated by Fig. 2, which shows "constant frequency" curves for four different wavelengths: 17.4 cm, 14.8 cm, 9.2 cm, and 7.6 cm. In obtaining these curves, the output circuit is held constant while the plate and grid voltages (E_R and E_O) are varied in such a manner as to maintain the wavelength constant. The plate voltage E_R and the relative output G are then plotted against the grid voltage E_O . It will be seen that the curves are of the same pattern for all four wavelengths. In each case there is a region in which both the E_R - E_O curve and the G - E_O curve are substantially linear, enabling linear amplitude modulation to be obtained (without frequency modulation) by applying the modulation voltage to both plate and grid electrodes simultaneously in the correct proportions.

In considering these results it is necessary to keep in mind the fact that, owing to the lack of a sensitive aperiodic detecting system, the

presence of oscillations cannot always be readily observed, particularly when the oscillations are very weak. The negative results must therefore be accepted with caution. Nevertheless the data derived from these experiments furnish strong evidence that the frequency of the oscillations generated in such circuits is critically dependent on the geometry of the tube. While tubes differing quite considerably in their geometry (as for example the four types illustrated in Fig. 1) are all capable of generating oscillations, quite a small change in the dimensions of the electrodes may have a very marked effect, sometimes to the extent of destroying all possibility of generating, in the desired wave range, oscillations of any useful magnitude. On the other hand, all tubes which are capable of exciting oscillations of fair magnitude exhibit constant-frequency voltage-amplitude characteristics of much the same form irrespective of electrode geometry and wavelength.

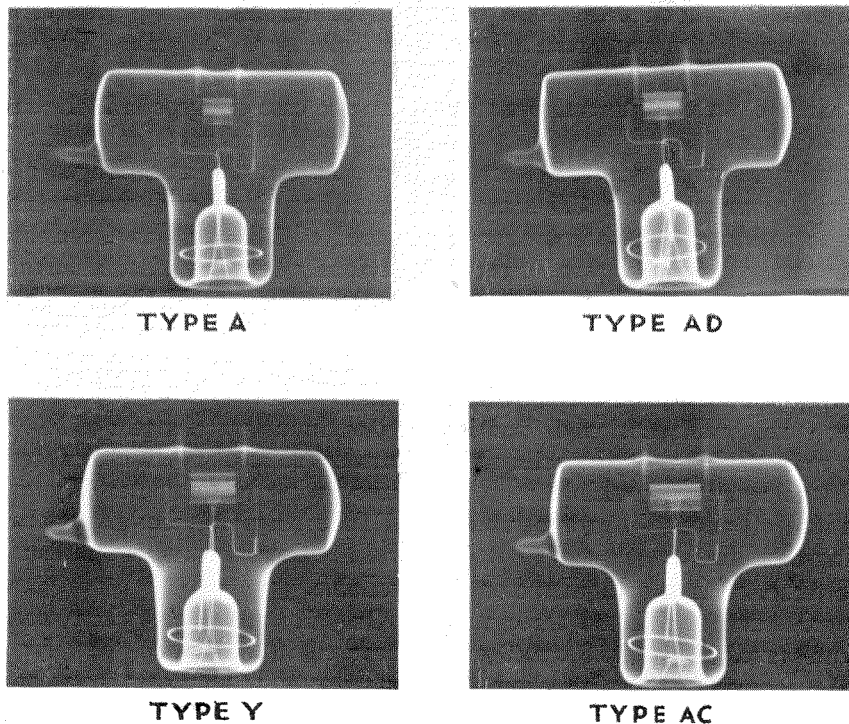

Fig. 1—Micro-ray Oscillator Tubes for Wavelengths Between 7.6 cm and 17.4 cm.

II. FREQUENCY STABILISATION OF A MICRO-RAY OSCILLATOR

Since the extensive use of any system of communication depending on carrier waves involves selection of channels on a frequency basis, stability of the carrier frequency is a matter of great importance. The required stability may be attained either by the direct method of utilising an inherently stable oscillator (with any necessary frequency multiplication) giving the full power output, or by the indirect method of synchronising an inherently unstable oscillator with a rigorously controlled source, which may be of much smaller power. Up to the present it has not been found possible to devise any system of micro-ray stabilisation based on the direct method without incurring a serious reduction of power output by the long train of frequency multipliers involved in starting from the most stable circuit available, a quartz crystal-controlled oscillator. Recourse, therefore, has been had to the indirect or

synchronisation method, a particular example of which is described below.

It had been observed during earlier work that, when beats of about 10 Mc p : s were obtained from two uncontrolled micro-ray oscillators, the frequencies of which were close to 1700 Mc p : s, the beat frequency, while far from being constant, could nevertheless be maintained for a few minutes within a limit of ± 500 kc p : s.

Fortunately, the frequency produced by micro-ray oscillators can easily be influenced in a known way by a suitable adjustment of the supply voltages. Such adjustment can be obtained as follows: apply the beat frequency to a differential circuit provided with detectors, the circuit being so arranged that a D.C. voltage of a certain polarity is obtained if the beat frequency is lower than a given reference frequency, while a voltage of opposite polarity is obtained if the beat frequency is higher than the said reference frequency. The D.C. voltage produced by this system

is added to the supply voltage of the micro-ray tube in such a way that the D.C. voltage variations will tend to bring the micro-ray frequency back to its normal value. A stabilisation of the micro-ray frequency will thus be obtained. The extent to which frequency fluctuations will be reduced depends on the rate of variation of the D.C. control voltage with respect to the beat frequency fluctuations.

The idea has been utilised in other circumstances. The problem, however, is complicated by the difficulty of producing an auxiliary micro-ray frequency which can be made to beat with the frequency to be stabilised. This

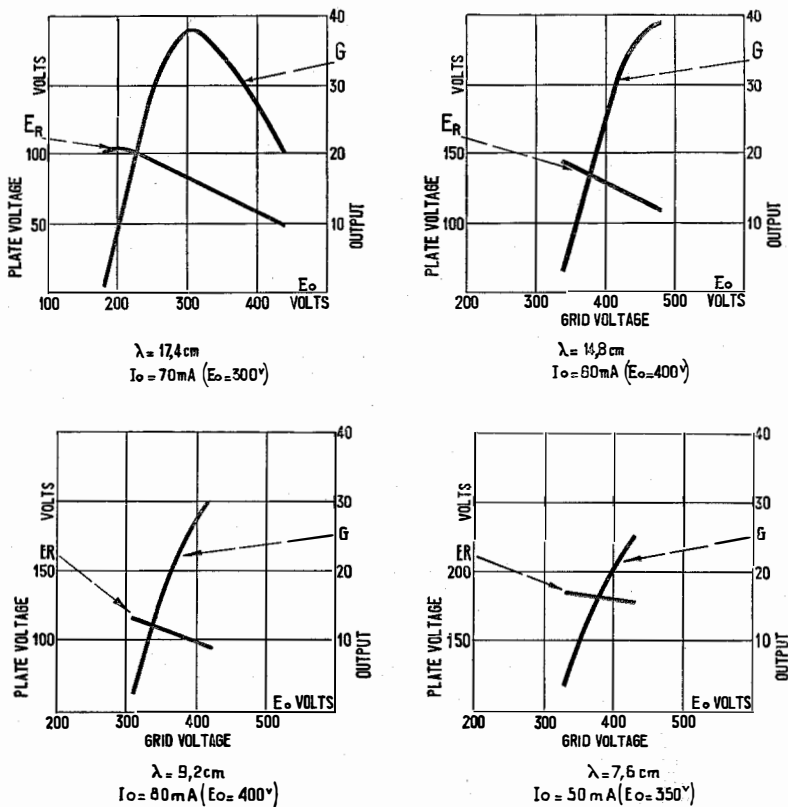

Fig. 2—"Constant Frequency" Characteristics.

auxiliary frequency must, of course, be as stable as possible; and, in order to reach a suitable degree of stability, it has been necessary to start from a quartz-controlled oscillator of about 20 Mc p : s and multiply its frequency a number of times in order to produce weak oscillations of the required micro-ray frequency.

With the use of this system it has been found possible to stabilise a beat frequency of 8 675 kc p : s to ± 25 kc.

DESCRIPTION OF EQUIPMENT

(a) Frequency Multiplier

Starting from a 21 619 kilocycles oscillator stabilised by a quartz crystal with reduced temperature coefficient (A.T. cut) and oscillating on its fifth partial, the frequency is multiplied by three in the following stage, in order to obtain 64.8 megacycles, and twice by two in the two following stages, so as to obtain 259 Mc p : s, i.e., a wavelength of 1.16 metres. The output circuit of the last stage is a transmission line, the electrical length of which is $\lambda/4$. This frequency is now further multiplied by four in a stage constituted by two Acorn tubes, the grids of which are driven in push-pull. The two plates connected together terminate on a transmission line of $3/4\lambda$ electrical length, constituting the output circuit.

A frequency of 1 037 megacycles has thus been obtained by multiplying 48 times a fundamental frequency of 21 619 kilocycles.

The oscillator so built up constitutes the reference oscillator used to stabilise the frequency of the micro-ray oscillator. Its mechanical construction is shown in Fig. 3.

(b) Beat Frequency Detector

On account of the weak output power of the frequency multiplier, a sensitive detector had to

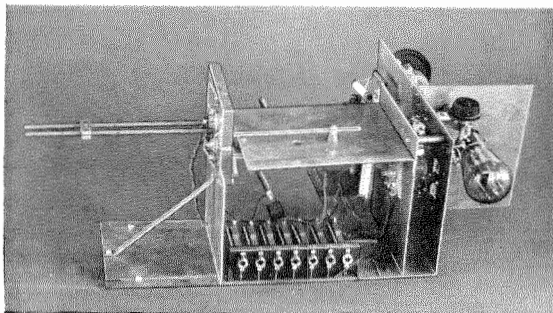

Fig. 3—Reference Oscillator, Frequency 1 037 Megacycles.

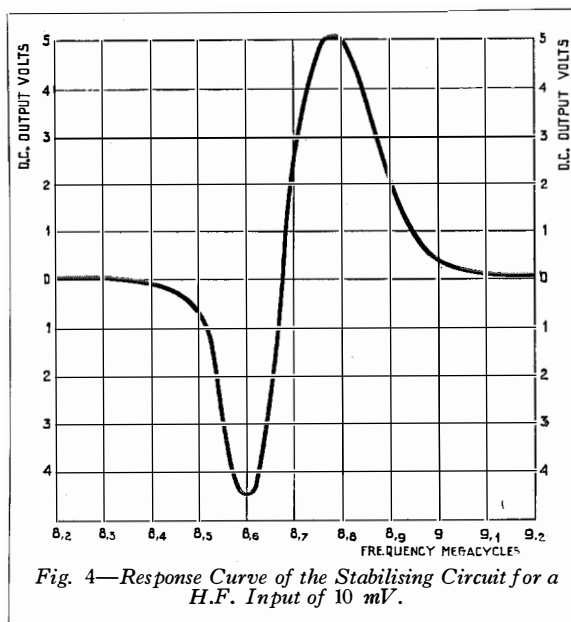

Fig. 4—Response Curve of the Stabilising Circuit for a H.F. Input of 10 mV.

be designed in order to provide sufficient amplitude of the beat frequency voltage. This was obtained by means of a micro-ray tube of the 3 036-Q type, tuned to the micro-ray oscillation frequency to be stabilised. It was necessary to adjust the detector close to oscillation, although all traces of oscillations had to be carefully avoided. The detector grid is connected to the ends of a tuned symmetrical line, terminating at the other end in a half-wave dipole. In order that the line may also serve as a high-pass filter to eliminate all unwanted frequencies coming from the frequency multiplier, it is cut at a current node and the sections are coupled by very small capacities constituted in fact by a gap of 5 mm between the ends of the conductors.

The plate of the detector tube is connected to the negative terminal of the filament through a 1 000 ohm resistance which serves as output impedance for the beat frequency. The rectified D.C. current in this resistance is of the order of 0.5 mA. The high frequency beat voltage is of the order of 60 mV.

The beat voltage coming from the detector is applied to the input of a four-stage wide-band amplifier (± 250 kilocycles) tuned to 8.7 megacycles.

(c) Frequency Stabilisation Circuit

The output of this wide-band amplifier is

loosely coupled to two selective circuits; one tuned to 8.65 Mc, the other to 8.75 Mc. Each circuit drives the grid of a grid bend detector, the anode of which is fed through a 20 000-ohm resistance. The D.C. voltage between the two anodes is zero so long as the two grids are not excited. If one of the two grid circuits is excited, a voltage difference will be found between the two anodes. If the other grid circuit is excited, the potential difference is of opposite sign. When the two circuits receive the same excitation, the voltage difference between the two anodes again becomes zero. If the frequency applied to the stabiliser is progressively increased, zero D.C. voltage is obtained between the two anodes so long as the frequency remains far from the mean resonance frequency of the two selective circuits. When resonance of the circuit tuned on the lower frequency is approached, a voltage is produced which will be called negative. As the applied frequency continues to increase, this voltage increases until a certain frequency is reached (corresponding approximately to resonance of the circuit tuned on the lower frequency), and then falls back rapidly to zero and finally becomes positive. The positive voltage increases up to a maximum corresponding to a certain frequency close to resonance of the second circuit, and then falls again to zero for higher frequencies. A typical response curve thus obtained is shown on Fig. 4; it has been plotted for a 10 mV input voltage at the amplifier.

The output D.C. voltage of this double detector is applied in series with the plate supply voltage of the micro-ray oscillator; the anode of the tube excited by the circuit on the higher frequency is connected to the plate of the micro-ray tube.

If the beat frequency is close to 8.7 megacycles but lower than this value, the double detector gives a negative voltage which is added to the negative supply voltage of the plate of the micro-ray tube. This increase of the negative voltage of the plate results in an increase of the micro-ray oscillator frequency. The increase of this frequency produces a corresponding increase of the beat frequency, provided the frequency of the reference oscillator has been previously adjusted below the micro-ray oscillator frequency. If the beat frequency is higher than 8.7 megacycles, the process is reversed and the beat is again brought back close to 8.7 megacycles. Thus the micro-ray oscillator frequency is stabilised around a value differing by 8.7 megacycles from that of the reference system.

Of course, the frequency stability cannot be perfect. The operation of the system involves frequency variation. It does, however, reduce the frequency variation relative to that which would occur were the stabilising system not introduced. The more rapidly the D.C. output voltage of the double detector varies with the beat frequency, the larger the factor by which the variations are reduced.

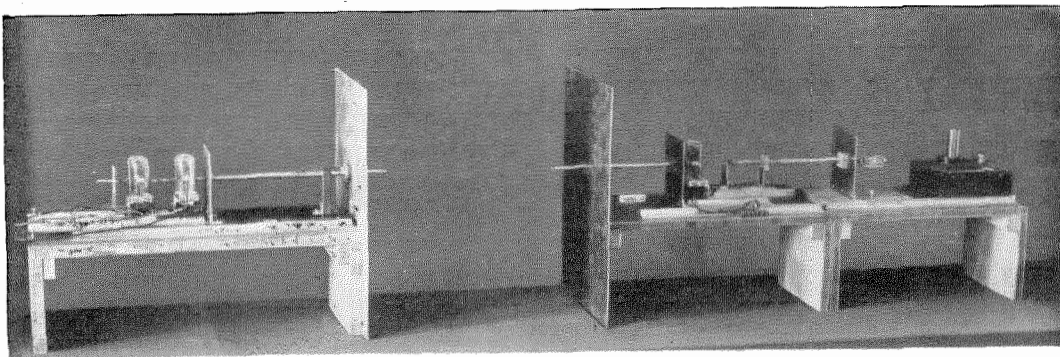
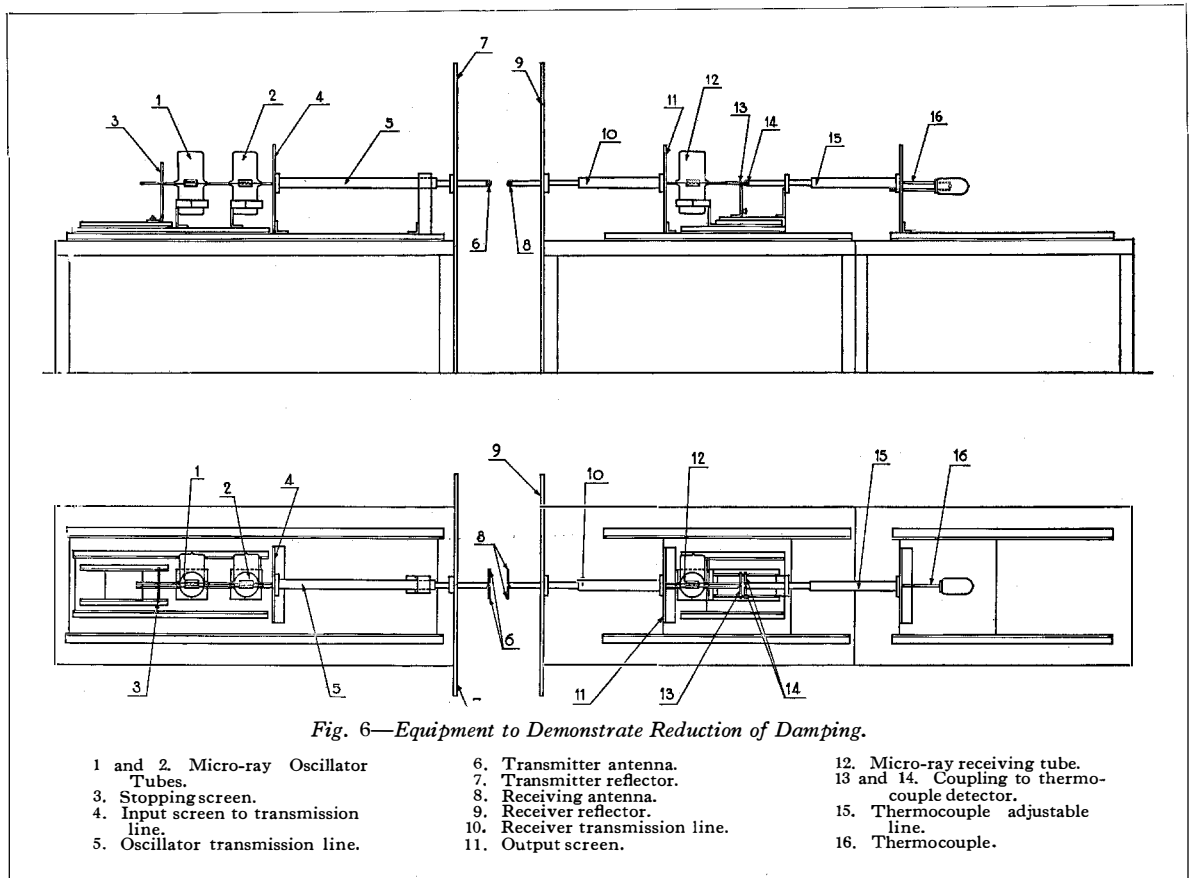

Fig. 5—Equipment to Demonstrate Reduction of Damping.



(d) Operation Requirements

In order that the system may start to function it is necessary that the initial beat frequency fall between the resonance frequencies of the two selective circuits. The frequency should remain stabilised thereafter. Since however the system only reduces frequency variations but does not suppress them altogether, it is necessary for sustained control that the beat frequency after stabilisation remain between the resonance frequencies of the two selective circuits. If the frequency drops outside these limits the stabilising circuits, instead of bringing the frequency back to 8.7 megacycles, will tend to push it further away from this value.

If the stabilising voltage is reversed, correct stabilisation of the beat at 8.7 megacycles is obtained, provided the reference oscillator has been tuned to a frequency above the micro-ray oscillation frequency. In this case, in fact, a frequency increase of the micro-ray oscillator produces a decrease of the beat frequency.

It is therefore necessary that the stabilisation frequency should operate in the opposite direction, in order to correct the frequency variations.

Besides these correct operating regions of the stabiliser, there are four adjustments leading to incorrect stabilisation, two at a beat frequency below 8.65 megacycles and two others at a frequency above 8.75 megacycles. Such defective operation occurs if the polarity of the stabilisation voltage does not correspond to the relative position of the frequencies of the reference oscillator and the micro-ray oscillator. In the present case, the variation of the stabilising voltage with frequency is in the direction of stabilisation for frequencies lower than 8.65 megacycles or higher than 8.75 megacycles. The danger of striking upon these improper adjustments becomes greater when the operating beat frequency is small compared with the micro-ray oscillator frequency. Using the ratio selected for this particular experimental case,

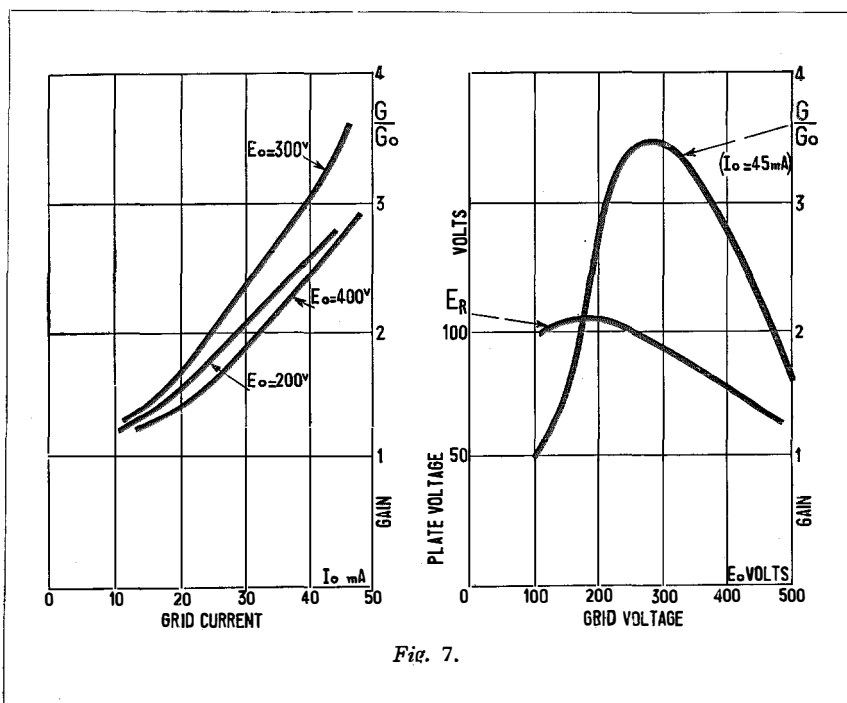

Fig. 7.

of 1 000 megacycles while the stability of an A.T. cut quartz crystal is of the order of 1/10 000th it is obvious that there is little to be gained by increasing the sensitivity of the stabilising system, although this could be done if required. The frequency stability of the system can be estimated at 1/8 000, the instability of the crystal being taken into account. The total frequency uncertainty of a 1 000 megacycle oscillator stabilised in this manner is therefore ± 125 kc p : s.

the risk is not too great, but nevertheless adjustment must be effected with great care.

Another condition for stable operation of the system is the choice of a proper time constant for the stabilisation system. As might be expected, a lower limit was found; this limit is of the order of 0.2 millisecond. With smaller time constants the system will tend to self oscillation. The time constant may however be increased to as much as one hundred times this lower limit with stabilisation still remaining effective.

PERFORMANCE

Using the system and apparatus described above, a micro-ray oscillator of nominal frequency 8 Mc off 1 037 Mc p : s remains constant to about ± 25 kc p : s.

If the $8\,500 \pm 25$ kilocycles beat output is heterodyned with a local oscillator of the same frequency range, an audible beat can be obtained. The frequency of this audible beat, however, is not constant. It varies slowly and shows in addition a rapid fluctuation. The frequency of this rapid fluctuation can be estimated by the lowest audible frequency which can be obtained; this is of the order of 1 000 p : s.

As the 25 kc instability represents 1/40 000th

III. USE OF A MICRO-RAY TUBE TO REDUCE THE DAMPING OF A 3 000 MC RECEIVER CIRCUIT

It is generally admitted that the grid or "oscillating electrode" of a micro-ray tube behaves like a line possessing negative leakance. If the tube is adjusted so that it does not actually oscillate, but is close to the threshold of oscillation, as for instance when the heating of the filament is suitably reduced, the negative leakance effect is still appreciable and gives rise to a decrease in the damping of the circuit into which the tube is introduced. This has been demonstrated by means of the equipment shown in Figs. 5 and 6.

A 3 000 megacycle oscillator was constructed using two micro-ray tubes operating in parallel. This oscillator when suitably adjusted gave a strong oscillation which could easily be detected by means of a thermocouple on a wavelength of 10 cm.

The receiver system consisted essentially of a dipole aerial connected through a transmission line to a thermocouple and a very sensitive galvanometer. Connected to the transmission line was a receiver type micro-ray tube.

With the receiving tube "cold," the oscillator was adjusted to give maximum deflection on the

galvanometer associated with the thermocouple, the latter being energised through the receiving dipole aerial and transmission line. The receiving tube was then switched on and, with suitable adjustment of the voltages on the plate and grid, the galvanometer deflection was found to increase three to four times. The oscillator system was then switched off (the receiving tube being left active) and the deflection on the galvanometer fell to zero.

In Fig. 7 are given curves showing the relationship between the receiving tube adjustments and the gain due to the receiving tube as measured by G/G_0 , the ratio of the galvanometer deflection with the tube active to deflection with the tube cold. The left-hand set of curves is plotted for various values of E_0 , the grid voltage, against variable grid current I_0 up to the limit of I_0 set by the threshold of oscillation. The right-hand curves show gain and plate voltage E_R for fixed grid current $I_0 = 45$ mA and variable grid voltage E_0 . It will be noticed that the gain curve shows a definite maximum.

The process just outlined is of course far from giving either the flexibility or the efficiency to which the communication engineer is accustomed when dealing with longer waves.

Such an application of negative leakance effects in the 3 000 megacycle region is nevertheless of considerable interest, and may lead to further developments which will bring the difficult technique of centimetre waves into the region of practical communication engineering. It should be noted too that while the effect dealt with in this last investigation has been described as the "removal of damping," it might equally well be described as relaying or amplifying. There is thus the possibility that a method of amplification based on this groundwork might be combined with crystal control and frequency multiplication, along the lines described in the second investigation, to give directly an inherently stable oscillator equipment of the same power output as that now obtained by the combination of a free power oscillator and a weak stable oscillator interconnected through a synchronising system.

In conclusion it will be realised that, in this field of research, much depends on the construction of suitable structures in evacuated envelopes, and the authors wish to acknowledge the very material assistance received in this respect from Mr. G. C. Chevigny, and the Vacuum Tube Department of Les Laboratoires, L.M.T.

Some Recent Developments in Teleprinter Switching Systems

By P. J. CLEMENS,

Bell Telephone Manufacturing Company, Antwerp, Belgium

THE rapid communication of intelligence between distant points has become indispensable to modern business, and the printing telegraph is playing an increasingly important part in the satisfaction of this need. Since the telegraph can produce a printed record of the message, not only at the receiving end of the circuit but also at the premises of the sender, it can claim two outstanding advantages—*independence of the presence of a person to receive a message, and the concomitant reduction of errors occasioned by the human element.*

It is well known that, although the telegraph preceded the telephone, the development of switching systems for the former has proceeded more slowly than in the case of the latter. There existed, it is true, even during the past century, a number of telegraph exchanges at which connections could be set up between instruments operated by private persons. But the various forms of telegraph instruments then used were slow and required considerable skill in operation; and, at the inception of the telephone, the public turned to the more convenient instrument, despite the advantage of the printed record. The public telegraph exchanges fell into disuse and gradually disappeared; and it may be said that, until recently, the extensive use of telegraphy has been restricted to the transmission of messages by Administrations and Operating Companies.

The progress made in the exploitation of the teleprinter, in new fields of use, has resulted in a continuous and simultaneous increase in the demand for appropriate switching equipment. With the introduction of the modern teleprinter, the telegraph exchange idea has again been revived since the teleprinter, now being very similar to an ordinary typewriter, makes it possible for regular office employees to transmit and receive accurate written records of communications without a great amount of special training. This has, from a subscriber's standpoint, eliminated the objectionable features of

the early telegraph instruments. In cases where great accuracy is required in the exchange of intelligence, where a written record of the message at the premises of both correspondents is of importance, or where language or phonetic difficulties arise, urgent communications can be handled best by teleprinter.

GENERAL SWITCHING PRINCIPLES

Telegraphy is now in a position to share in the rapid advances made in the telephone field. It requires switching facilities between private substations via local and toll lines with many of the facilities which exist in telephony.

It may be expected that, for intercommunication over short distances, the application of teleprinters will remain rather limited as compared with the telephone, an important reason being the comparatively high cost of the substation instruments; but, when used for intercommunication over greater distances, the lower cost of telegraph channels compared with those used for telephony is an important factor in favour of teleprinter service which tends to make it cheaper than telephone service on moderate and long distances. A teleprinter switching system should, therefore, permit through-connection over long distances; moreover, it should be considered as one of the most important requirements that the distortion factor introduced by any such switching system be kept as low as possible in order to provide the maximum margin available to cover line and incidental distortion. With this object in view, and despite the fact that many, if not all, of the teleprinters connected to a switching system will operate on the well-known "single-current" transmission principle, it would be an undoubted advantage if all telegraph transmission, within the exchange equipment at a switching point, were carried out on the "double-current" principle with separate balanced signalling channels for transmission in opposite directions.

Fundamentally, a teleprinter exchange con-

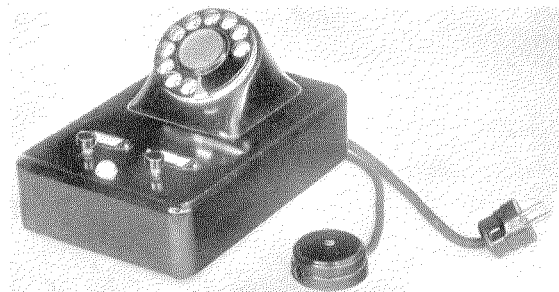

Fig. 1—Substation Control Box for Connection to an Automatic Exchange.

sists of two parts: (1) the terminations for substation lines; and (2) inter-urban trunks and the switching means for inter-connecting such lines and trunks. Substation lines may be divided into two classes: lines connecting local substations, and lines connecting long distance substations.

A "local" substation is connected over a 2-wire loop circuit, direct from the teleprinter to the exchange, in the same way as a telephone subscriber's set is connected to a telephone exchange, the maximum distance between the substation and the exchange being of the order of 40 miles of 19 B. & S. gauge cable. The teleprinter mechanism at such a substation is operated from a local source of power, but the signalling current is furnished from the exchange power plant.

"Long distance" substations are stations which cannot be connected over 2-wire loop circuits, either because of the distance involved or economic considerations. For the connection of such substations to the exchange, "polar" D.C., super-audio, voice frequency or other types of telegraph channels must be used. The distance between the exchange and the substation is limited only by the characteristics of the telegraph channels employed.

The exchange line circuits of this category are in general connected by means of 4 wires to the terminating equipments of the telegraph channels, which may or may not be located in the vicinity of the exchange. The distant ends of these telegraph channels are connected, usually over a 4-wire feeder line, to a converter circuit

which is itself connected over 2 wires to the substation. The converter circuit serves to convert from double-current to single-current operation, and vice versa, and is frequently located near the terminating equipment. The teleprinter mechanism at such a substation is operated from a local source of power, but the signalling current is furnished from the converter circuit.

The inter-urban trunks between teleprinter exchanges may be of the many standard types used for telegraph transmission. These include voice frequency carrier telegraph systems, metallic systems and differential duplex grounded telegraph circuits.

A teleprinter exchange should contain facilities for inter-connecting substation lines, connecting them with toll lines, and for inter-connecting toll lines, as required, together with the necessary means for establishing and supervising the connections. One of the most desirable requirements is that all lines, between which inter-communication is required, should be capable of being connected together without any special line-up or adjustment of the circuits or apparatus, and without departing from the principle that the overall distortion on all connections obviously must be low enough to permit satisfactory service.

It is not possible to connect a "local" substation line (cable or overhead), a long aerial line, a loaded cable pair and a voice frequency channel, to the same kind of relays or apparatus at the exchange. Similarly, a metallic connection cannot be made directly between these various systems. Repeaters or single-current to double-current converters are therefore necessary in nearly all exchanges, and they can only be omitted if switching is restricted to local substation lines with appropriate line

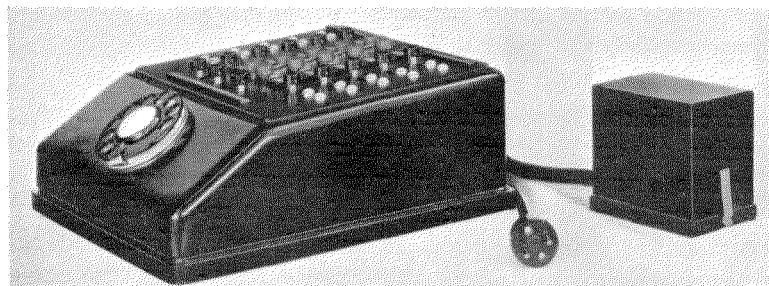

Fig. 2—Substation Control Box for Selective Broadcasting.

conditions, requiring no through-connection to other switching systems.

In the teleprinter switching systems herein-after described, the terminating equipment of all lines is provided with repeaters or converters, each containing a sending and a receiving telegraph relay. With this arrangement, all types of lines are converted into an equivalent system, thus permitting them to be readily inter-connected with each other and with any type of telegraph channel. The line terminating equipment can then be adjusted individually to suit the particular line conditions, and the type of teleprinter connected, in order to ensure optimum working conditions. This adjustment is a simple operation which can be performed without experimentation by reference to records of line conditions.

Broadcasting or the transmission of a message simultaneously to a number of stations has sometimes been used in telephony, but broadcast messages can evidently be handled more effectively by a teleprinter system because a printed record is obtained. This fact has led to an increasing demand for broadcasting facilities in teleprinter switching systems.

To meet the increasing demand for switching systems for use with teleprinter equipments, the Bell Telephone Manufacturing Company, Antwerp, in collaboration with Creed and Company, Ltd., London, has placed on the market a range of switchboards. For the time being, these are limited to small systems but can be arranged for international switching. A few are briefly described.

AUTOMATIC SWITCHING

Automatic switching for teleprinter exchanges has many advantages. The well-known reasons which led to the introduction of dial-operated systems in telephone operation are found to apply also in connection with telegraph operation. Further, there is the circumstance that in telegraph operation by manual methods, more time is required to establish a connection than would be required in telephony. Moreover, the equipment required at the operating position necessarily includes a teleprinter, the cost of which is an important item. The fact that automatic systems are ready for operation, both day and night, is no doubt an even greater

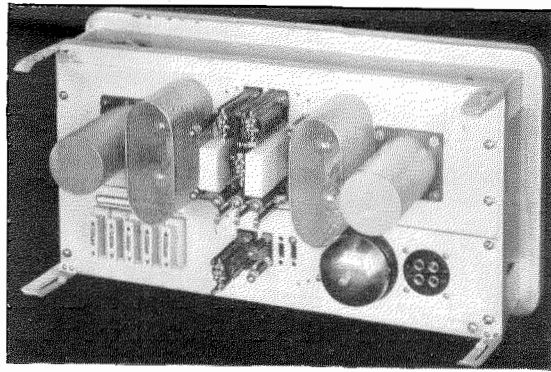

Fig. 3—Single-current to Double-current Converter.

advantage in telegraphy than in telephony, since the teleprinter lends itself admirably to the practice of leaving messages on the substation instrument even though no one is in attendance.

Substation Equipment

To enable the operator of a teleprinter substation to initiate, establish and release connections at the exchange, a control box is provided in addition to the teleprinter itself. Fig. 1 shows such a substation control box, which carries a dial, a starting key, a release key and a control lamp, and which also includes the necessary apparatus for controlling the teleprinter motor.

Special arrangements are in general necessary at substations from which messages are to be broadcast. One method is to provide a control box including, in addition to the apparatus required for initiating and releasing a regular connection, a key and two lamps for each substation line to which broadcast messages may be transmitted as well as one common broadcasting key. Such a control box is illustrated in Fig. 2; it is suitable only for use with teleprinters located near the exchange because of the number of wires required to connect the box to the latter.

Converter for "Long Distance" Substation

At some convenient point between a "long distance" substation and the nearest terminating equipment of the long distance telegraph channels leading to the exchange (preferably near this terminating equipment), a single-current to double-current converter is necessary. This is contained in a metal cabinet, arranged for wall mounting, as shown in Fig. 3. The converter proper consists of the telephone

type relays required for switching functions and two telegraph relays. In addition, the unit comprises the necessary fuses, a fuse alarm circuit, protecting lamps, and adjustable resistances for adjusting the currents in the local loop circuit and in the windings of the telegraph relays.

100-Line Automatic Exchange, Type No. 7130

Fig. 4 illustrates a typical junction diagram of an automatic teleprinter exchange with a capacity of 100 substation and junction lines.

The following different types of substation lines, amongst others less frequently met, may be connected to exchanges of this type :

- (a) A "Local" substation (which may be defined as one which is connected over a straight loop circuit to the exchange) operating on direct current which is fed from the exchange. Signalling over the line is done by single current which is converted in the line-terminating unit at the exchange to double current.
- (b) A "Long Distance" substation, which may be defined as a substation which cannot be operated on direct current fed from the exchange and which, therefore, is connected over one of the many different types of telegraph channels now available. In this case the line signalling is double current and, therefore, the line-terminating unit at the exchange merely acts as a repeater. For this reason, the terminating unit is slightly different from that of a local substation line.

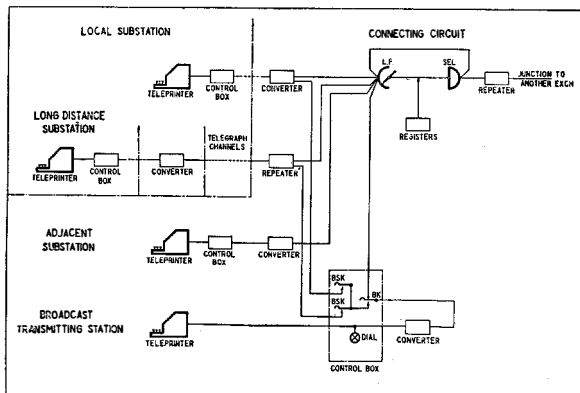

Fig. 4—Typical Junction Diagram of a 100-line Automatic Exchange.

- (c) A "broadcasting transmitting" substation, necessarily located in the vicinity of the exchange by reason of the number of inter-connecting wires, and providing for simultaneous transmission as well as normal intercommunication.

The exchange may also be connected to distant manual teleprinter exchanges or, with suitable register circuits, to other automatic exchanges.

The principal facilities provided include :

- (a) Connections, established by dialling, for 2-way communication, on a half-duplex basis, between any two substations ;
- (b) Transmission simultaneously to a number of local or long distance substations from a station arranged for broadcasting. The number of stations to which a message can be broadcast is usually limited. The control box shown in Fig. 2 is designed for broadcasting to 10 stations. Any number and choice of these 10 stations can be included according to the circumstances ;
- (c) A number of substation lines may be combined in a group, to which one single number is assigned (P.B.X. group). Upon calling this number, the caller will be connected to the first free line of such a group ;
- (d) Since each substation line is provided at the exchange with its own telegraph repeater, the most suitable transmission characteristic for each individual line is readily obtainable.

This type of exchange (ultimate capacity, 100 lines and 35 connecting circuits), is composed of several separate equipment units to facilitate extension. Equipment for 20 lines and 7 connecting circuits is mounted on a self-supporting frame known as a "line and connecting circuit" unit which can be seen on the right of Fig. 5. It is built up of two relay bays, separated by a bay of regular Rotary gear-driven single-motion switches. It is self-contained and, hence, is provided with its own shaft-driving motor and fuse panel. The relay plates have individual dust covers in front. The whole of the rear of the unit is protected by removable dust shielding ; and, in front

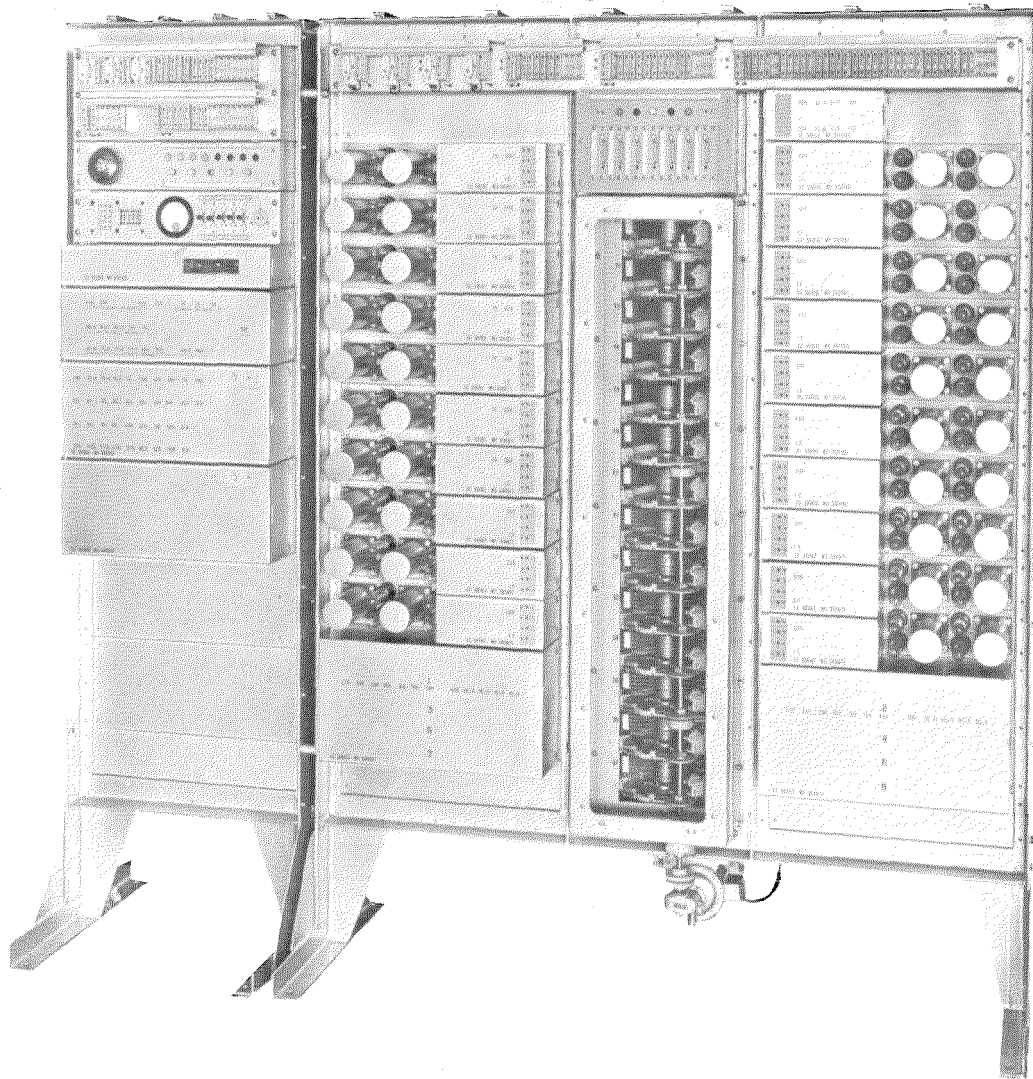

Fig. 5—No. 7130 Automatic Exchange.

of the rotary switches, a detachable hinged gate with a glass window is provided for observing the positions of the brushes. The apparatus on the unit is thus totally enclosed, except for the fuses, resistance lamps and test panel.

A separate unit is provided for mounting additional equipment which is always required, regardless of the size of the exchange, such as in connection with register circuits, common motor starting, finder starting, alarm circuits, etc.; also the test panel with measuring instruments and the routine test circuit. This

unit is known as the "common circuit" unit and is shown on the left of Fig. 5.

The exchange illustrated has a capacity of 20 substation lines. If trunks to other exchanges are required, the number of substation lines must be reduced or, alternatively, the trunk circuit equipment may be mounted on a separate bay. The exchange can readily be extended for 100 lines. It would then consist of one "common circuit" unit and 5 "line and connecting circuit" units.

Each substation line or trunk terminates at the exchange in a line apparatus unit which,

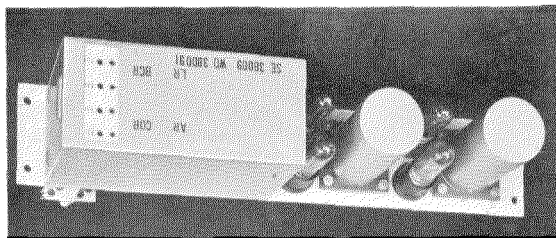

Fig. 6—Typical Line-Terminating Unit.

in addition to the relays required for switching, contains two telegraph relays, the necessary protecting lamps and variable resistances for adjusting the currents in the line and in the windings of the telegraph relays.

The terminating apparatus units of the different lines and trunks are all designed to mount on mounting plates of standard size and are thus interchangeable. Each circuit forms a complete unit which is provided with an individual cable form and terminal strip. A terminating unit for a line to a "local" substation, with provision for broadcast reception, is illustrated in Figs. 6 and 7.

A test panel is mounted on the "common circuit" unit, permitting verification of the adjustment of the telegraph relays, and is provided for this purpose with a milliammeter and a number of keys and jacks to accommodate the telegraph relay under test.

Every line circuit is provided with break jacks by means of which the milliammeter on the test panel, a teleprinter, or a distortion measuring set may be introduced into the circuit for checking current values or the transmission quality in different parts of the circuit.

10-Line Automatic Exchange, Type No. 7120

Fig. 8 shows a view of a smaller type of exchange. It has a capacity of 10 lines and 4 connecting circuits, but is shown only partially equipped for 5 lines and 2 connecting circuits. This exchange is designed to interconnect the same types of substation lines and provides the same facilities as the 100-line exchange.

The complete switching equipment is mounted on a single, self-supporting unit,

which is built up of 2 bays and is entirely self-contained. On the left-hand bay are mounted the connecting circuits and a part of the line circuits; on the right-hand bay may be seen the remainder of the line circuits, the broadcasting circuit, the test circuits and the fuse panel. Single motion step-by-step switches are used both as line finders and as selectors, and registers are not required. The same line-terminating units are used as for the 100-line exchange. The unit is provided with a test panel, equipped with a measuring instrument as well as keys and jacks, the same as in the larger size, also with a routine test circuit.

Power Supply

The 100-line and 10-line automatic exchanges are both designed to use positive and negative 50, 60 or 80-volt power for transmission circuits, according to the prevailing conditions, and negative 48-volt power for all switching functions.

Setting up a Connection between Two Substations

Such a connection is made by an automatic connecting circuit. In the larger size exchange, this consists of a line-finder, a selector and a number of relays. The line finder and selector are both single-motion switches of the same construction. The line finder hunts for the incoming call and the selector selects the called party in accordance with the digits dialled. Each connecting circuit has access to two register circuits. During the dialling and selecting period, one of the register circuits is connected to the connecting circuit but, as soon as selection is completed, the register circuit is

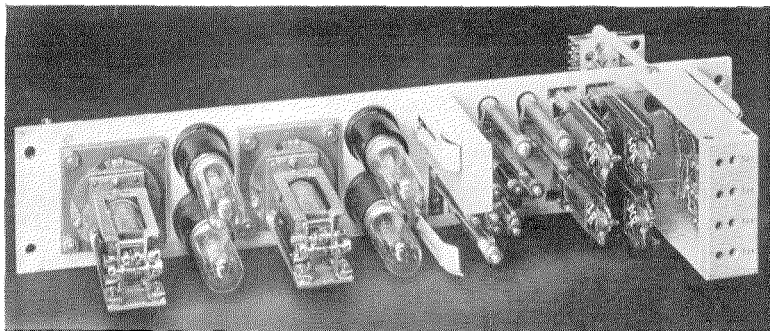

Fig. 7—Typical Line-Terminating Unit, with Covers Removed.

disengaged and is free to deal with other calls. The holding time of the register is so small compared with the average duration of a teleprinter connection that two registers are found to be sufficient for a fully equipped 100-line exchange. Nevertheless, to meet the possible case where the calling rate is exceptionally heavy, space and wiring for a third register are provided.

A call is originated from one of the substations by depressing the starting key, thus starting the line finders of all free connecting circuits hunting for the call. When one of them has seized the line, all the others are stopped, and one of the two register circuits is connected by relays to the connecting circuit to which the successful finder belongs.

As soon as the register circuit is connected, the motor of the calling party's teleprinter is started. This condition is indicated visually by the lighting of a lamp mounted on the control

box, and is the signal to the calling party that the exchange is ready to receive dialled impulses. The starting key, which is of the non-locking type, has to be kept depressed until the lamp on the control box lights.

The calling party may now dial the number of the wanted substation. The digits are received and stored on counting relays in the register. The selector is directed to the required line by driving it to terminals marked

from the register. A separate marking multiple is provided for each of the two registers, so that no interference between them occurs during this process.

The busy or free condition of the line reached is then tested. If the line is already engaged, the teleprinter motor at the calling substation is stopped, the signal lamp is extinguished and the connection is released automatically.

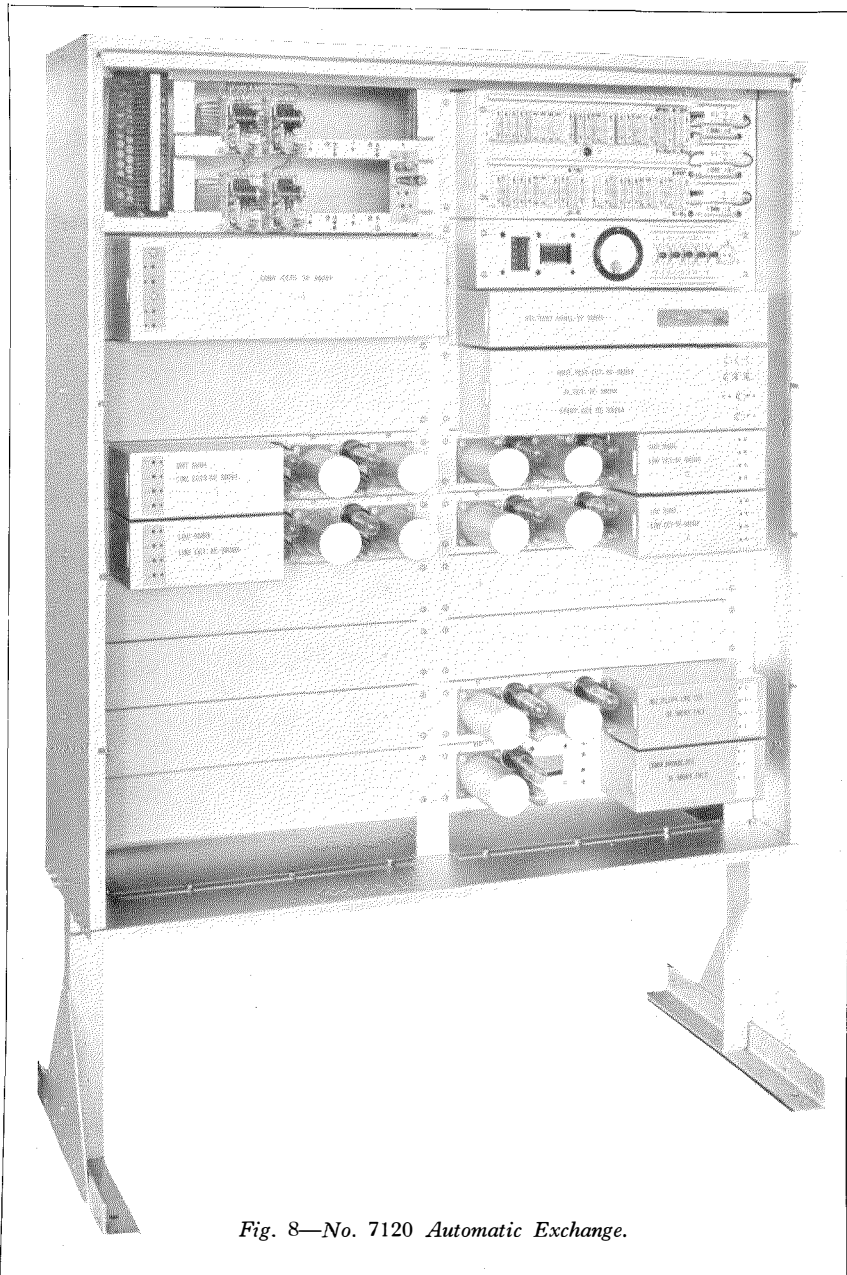

Fig. 8—No. 7120 Automatic Exchange.

If the line is found to be free, the teleprinter motor at the called station is started automatically and the lamp on the control box is lighted. The calling party, seeing that his own lamp remains alight, may now send the "who are you?" code, which starts the automatic "answer back" device on the teleprinter at the selected station and results in the code name of the latter being printed by both teleprinters. The desired message may then be communicated.

When both parties have completed their messages, either of them may signal this fact by momentarily depressing the release key, causing the release of the connection. The teleprinter motors at both substations are stopped and the lamps on the control boxes are extinguished.

Treatment of Incomplete Dialling or False Calls

Since for normal calling the starting key is

momentarily depressed, it is possible for the exchange equipment to distinguish a call caused by a permanent loop or grounded wire from the condition resulting from no dialling or incomplete dialling.

In the case of a false call due to a line fault, loop or ground, the exchange register circuit is released after a certain interval but the connecting circuit is held and causes an alarm to be given, thus enabling the fault to be traced by the maintenance staff. Should a substation depress the start key and call but fail to dial, or fail to complete dialling, the exchange equipment functions differently, all circuits in this case being released and returned to normal.

Broadcasting

As already stated, one of the substations may be equipped for broadcast transmission. So long as the common broadcasting key on the special control box at this station remains in its normal position, the station is connected to the switchboard in the same way as a regular substation so that intercommunication with any other station is possible in either direction.

For broadcasting a message to a group of substations, the operator at the transmitting station depresses the individual selecting keys of the stations which are to participate. If one of these stations happens to be engaged on a regular connection, the latter is broken down by the operation of the key and the teleprinter motors of both the substations involved are stopped.

Associated with each of the selecting keys are two lamps, one serving to indicate that the corresponding substation is connected to receive a broadcast, and the other to convey an acknowledgement signal to the effect that the message has been duly received. If the selected substation line

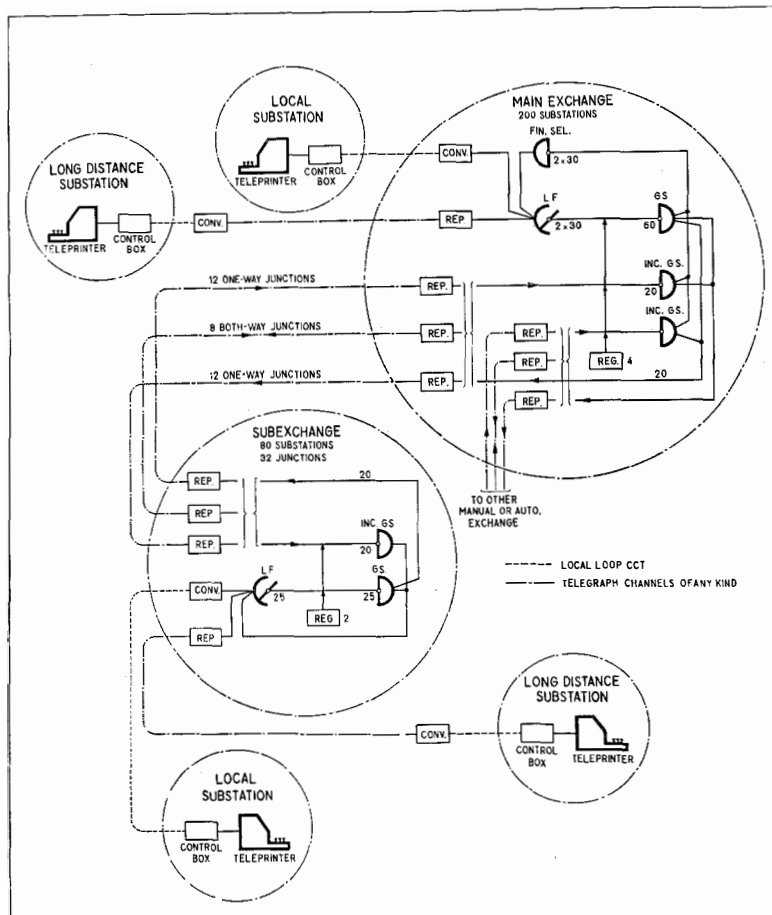

Fig. 9—Typical function Diagram of an Automatic Switching System.

is in working order, the depression of the selecting key lights the first lamp.

After the necessary selecting keys have been depressed, the common broadcasting key must be operated momentarily. This action disconnects the transmitting station from the automatic switches and starts the motors of all the selected substations.

Telegraphic transmission is now possible from the calling station towards the called stations, but not in the reverse direction. After the message has been completed, the substation operators are invited to indicate to the transmission station that the message has been received. This they do by momentarily throwing their release keys, causing their respective acknowledgement lamps to light.

The transmitting station alone can release the connection by restoring the selecting keys. All the teleprinter motors then stop and the stations involved are again connected to the automatic switches.

Interworking with Other Automatic Exchanges

In order to provide multi-office teleprinter switching service, certain connections naturally require more than one switching point. By way of illustration, Fig. 9 shows a typical junction diagram of an automatic switching system consisting of a main exchange to which are connected 200 substations, junctions leading to a sub-exchange and junctions to other manual or automatic exchanges. The main exchange carries traffic not only between its own substations, but also to and from the substations of the associated sub-exchanges, and transit traffic between sub-exchanges. The junctions between the main exchange and the sub-exchanges may be either both-way or one-way lines. The figure shows a typical case where 32 inter-exchange junctions are judiciously divided into 12 outgoing, 12 incoming and 8 both-way junctions.

Rotary type teleprinter exchanges employ

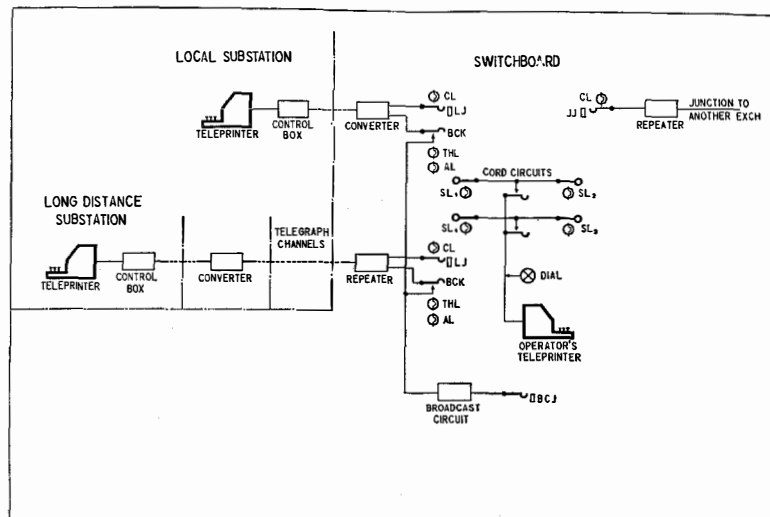

Fig. 10—Typical Junction Diagram of a Manual Exchange.

registers which permit of the same economies and advantages as are found in Rotary automatic telephone systems. The important switching facilities which result from the use of registers are already well known in the telephone field and they apply equally well to multi-office networks of teleprinter exchanges. Continuous hunting, full availability, tandem switching without any objectionably large number of digits, alternative routing, and overflow are some of the features which result in a flexible and, at the same time, economical trunking system.

Because the number of selections required for the establishment of a tandem connection may be greater than the number of digits dialled from the calling station and, consequently, selection of the wanted line may not be complete when dialling is finished, it is necessary to find a positive means of indicating whether the wanted station is free or already engaged.

In a single office system, the end of dialling practically coincides with the end of selection and, if the teleprinter motor continues to run and the control lamp remains alight after dialling has been completed, the operator knows that the line is free, without any positive indication of the fact. In the case of a multi-office network there may be some delay between the end of dialling and the testing of the wanted line at a distant exchange, and "line free" or "line busy" conditions may be indicated in the

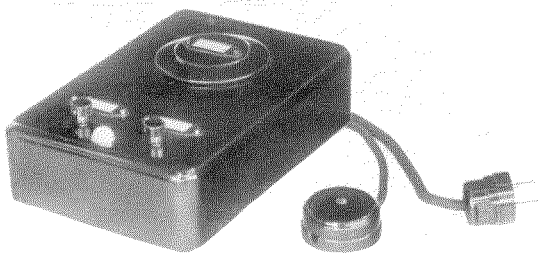

Fig. 11—Substation Control Box for Connection to a Manual Exchange.

following way. On a multi-office connection, the register at the originating exchange controls the selection of the required exchange and then transfers the number of the wanted substation to a register in the latter. When the wanted substation has been selected, the last mentioned register receives an indication of "line free" or "line busy." If the line is free, the register automatically sends to the called substation the code "who are you?" which starts the "answer back" device at this station. The register circuit then disconnects itself and the "answer back" signal is transmitted straight through to the teleprinter of the calling station. This station is thus provided with a printed record of the identity of the selected station, constituting a positive indication that the circuit is in a position to transmit the message. It also saves time since it is now unnecessary for the calling party to send the "who are you?" code. Should the required substation be found busy, the connection is released, the teleprinter of the calling station is stopped and the control lamp is extinguished. It is also possible to send back, from the register, the word "busy."

Multi-office operation on a large scale, such as is required for national or international working, must include some method of call charging based on time and distance, e.g., time and zone metering or automatic ticketing. Furthermore, the switching problems become more complex. It is planned to deal more fully with this type of teleprinter switching system in a subsequent article.

MANUAL SWITCHING

Where there are insufficient channels to provide "no delay service," manual exchanges may be required. They may also be used for

special cases, such as police service, where messages are to be broadcast from any outlying substation.

A typical junction diagram of a manual teleprinter exchange is shown in Fig. 10. The exchange illustrated combines the functions of a local and a toll exchange and not only serves as the switching centre for the substations connected directly to it, but also as the terminus of various long-distance telegraph channels extending to distant manual or automatic exchanges. It may, of course, be used to interconnect long-distance telegraph channels in cases where transit connections are required.

The exchange also furnishes "broadcasting" service, that is, simultaneous transmission from any of the substations to any combination of substations which may be selected individually at the switchboard, as required. A line circuit, for broadcast reception, is provided with a key and two additional lamps. The substations to be included in a broadcast are connected to a common broadcasting circuit by the operation of these individual keys. Another method of broadcasting, for use in somewhat different circumstances, requires no additional equipment in the line circuits but uses a multi-plug cord circuit to group together the participating lines.

The method of broadcasting illustrated in Fig. 10 is applicable in cases where messages are habitually transmitted simultaneously to all, or at least the majority, of the substations. If, however, the maximum number of substations to which a message is to be broadcast never exceeds 5 or 6, the method employing a multi-plug cord circuit is often more suitable.

Substation Equipment

As in the case of automatic switching, a substation teleprinter is associated with a control box by means of which the operator can call the switchboard operator and give a clearing signal when the call is completed. Fig. 11 shows such a substation control box. It carries calling and clearing keys and a signal lamp, and includes apparatus for starting and stopping the teleprinter motor from the switchboard. It will be seen that, apart from the dial, it closely resembles the control box used for automatic switching.

Converter for "Long Distance" Substation

The single-current to double-current converter, previously mentioned and illustrated in Fig. 3, is equally suitable for manual switching, since the problem of linking a "long distance" substation to the terminating equipment of the long-distance telegraph channels leading to the switchboard is the same in both cases.

Exchange Equipment

A typical switchboard section for a small non-multiple exchange is illustrated in Fig. 12. Such a section can accommodate up to 40 lines and 16 through-connecting cord circuits. These capacities may be doubled by placing two switchboard sections side by side.

The operators do not sit in front of the sections, as in the case of telephony, but at the side, in front of tables on which their teleprinters and calculagraphs, when needed, are located. One operator can sit at either side of the switchboard. By using a shallow key

shelf and placing the teleprinter tables at a suitable angle with the switchboard, the operators have no difficulty in reaching any jack.

If more than two operators are required, the two sections are placed apart with the line circuits multiplied over both of them. Four operators can then be accommodated. When two operators serve the same board, each has access normally to one half of the cord circuits, but may be connected by means of a concentration key to all cord circuits on the position.

The switchboard is a wooden section mounting the operating equipment in a conventional jack field and key shelf, and is provided with an iron hinged "gate," accessible from the rear, upon which are mounted the relays of the cord circuits. Fuses for the latter are also located in the rear of the section. The key shelf has the same height as a regular teleprinter table.

The line circuit equipment, which need not be accessible to the operator, is mounted on a separate apparatus rack. Fig. 13 illustrates one

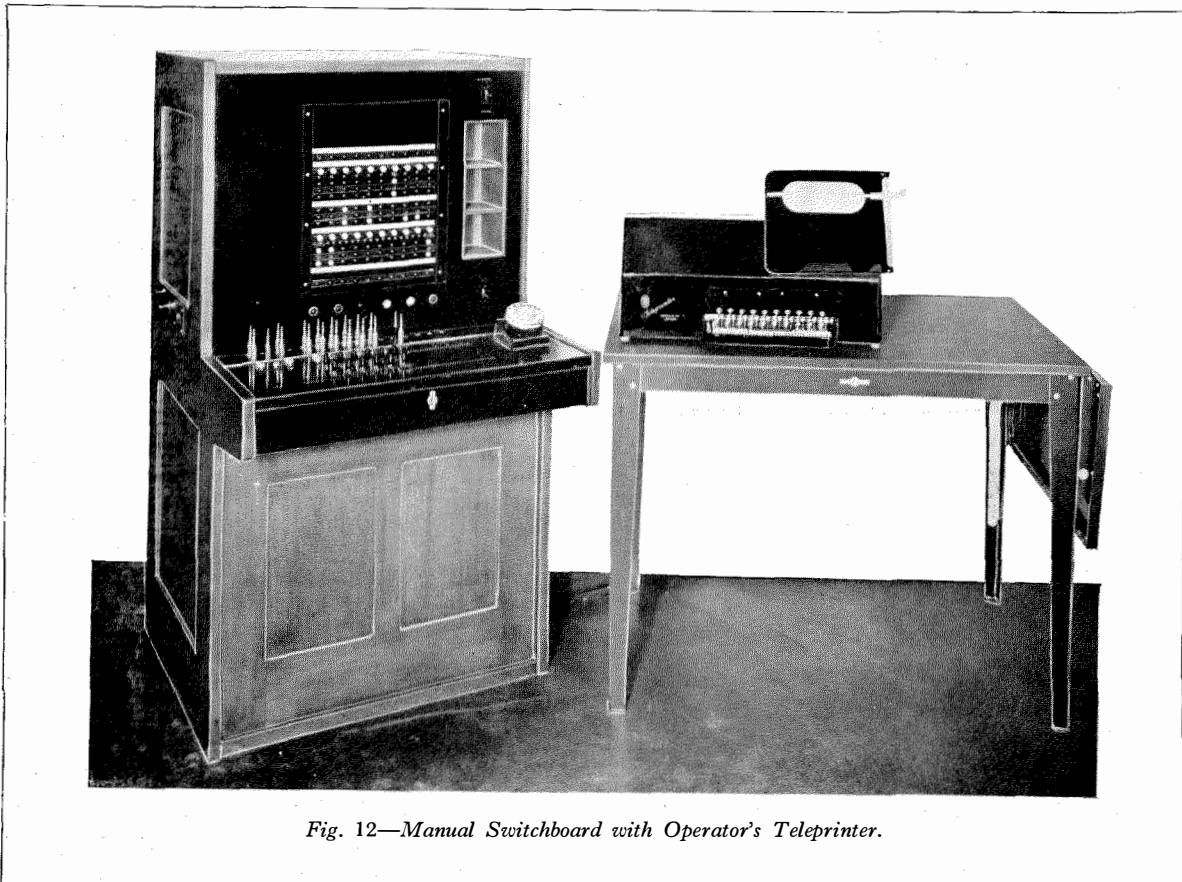

Fig. 12—Manual Switchboard with Operator's Teleprinter.

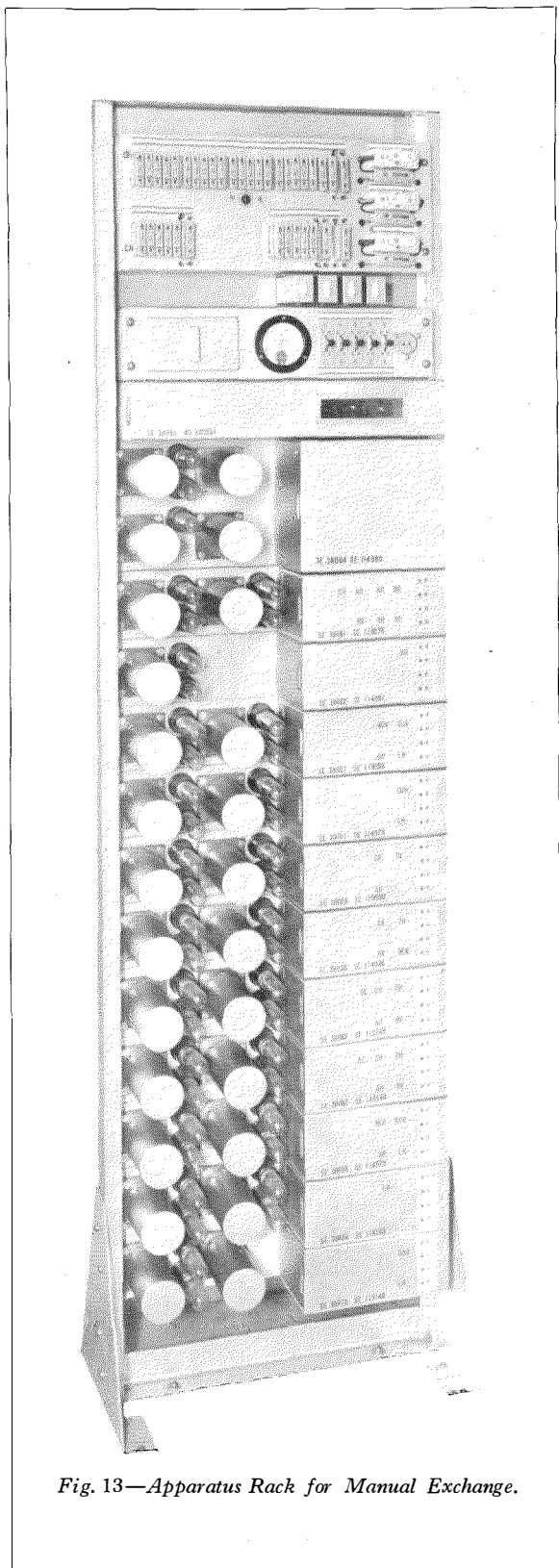

Fig. 13—Apparatus Rack for Manual Exchange.

type. Each line-terminating equipment forms a complete unit and is similar to that used for the automatic exchanges already described. Such a unit is shown in Fig. 7. Fuses for the line-terminating units, test panel and miscellaneous circuits are also mounted on the apparatus rack.

Power Supply

The manual exchanges of the type just described require positive and negative 50, 60 or 80-volt power for transmission circuits, and negative 48 or 24-volt power for local relay and lamp circuits.

Setting up a Connection between Two Substations

The operations involved in making a connection between two teleprinters are in many ways analogous to those performed in a comparable call through a small telephone switchboard.

A teleprinter substation operator, having no hand-set to lift from the cradle, originates a call by depressing the calling key on the control box, whereupon the calling lamp at the switchboard lights. The switchboard operator answers by inserting the answering plug of one of her cord circuits in the line jack and throwing the answering key. This latter action causes the teleprinter motors of the calling party's and her own teleprinters to start, and lights the signal lamp mounted on the control box. The lamp informs the calling party that the switchboard operator is ready to receive instructions.

The calling party types to the operator the number of the required substation, and the operator inserts the calling plug in the jack of the wanted line, if free. Insertion of the plug starts the teleprinter motor at the called station. The operator types a suitable indication to the caller that the connection has been effected. The two substations are connected through to one another as soon as the answering key is restored.

The operator is able to enter a connection by throwing a monitoring key, in which case the switchboard teleprinter prints the messages typed by both parties. She is also able to type to both parties simultaneously. Other keys permit communication with either party separately.

The momentary depression of the release key on the substation control box lights the supervisory lamp in the cord circuit. When the operator removes the plugs, the teleprinter motors at both substations are stopped.

Broadcasting

A request from a substation operator for a broadcast connection is conveyed to the switchboard operator in the same way as any other call. If the switchboard is provided with the type of broadcasting scheme illustrated in Fig. 10, the calling party is connected by means of a regular cord circuit to the common broadcasting circuit. The switchboard operator then depresses the individual broadcasting keys associated with the lines to be included in the broadcast, and connects them to the broadcasting circuit. The motors at the substations are started and the through-connection lamp belonging to each line lights. The operator types to the calling party an indication that the connection is completed and restores the answering key.

Telegraph transmission is possible from the calling station alone. Although, to avoid confusion, transmission in the opposite direction is prevented, each of the called parties, upon request, can indicate to the switchboard operator that the broadcast message has been

duly received. To do this, the called party momentarily depresses his release key, which lights the acknowledgement lamp associated with his line on the switchboard.

To release the connection, the calling party depresses the release key, which lights the supervisory lamp in the cord circuit in the usual way. The connection can then be taken down.

CONCLUSION

Teleprinter switching opens up an entirely new field for exploitation. It enables a private person to carry out his own telegraph communications with office staff no more highly skilled than that employed for typing his correspondence.

Perhaps the greatest incentive to the development of teleprinter switching is the fact that the narrower frequency band-width required for telegraph transmission, as compared with telephone transmission, permits a considerably more economical use of the line plant.

It may be expected that automatic switching will make more rapid progress than manual switching, since the channels available for telegraphic transmission are inherently suitable for the transmission of the impulses required for automatic selection, a situation which finds no parallel in long-distance telephony.

The Application of Styrene to H.T. Cable Systems

By T. R. SCOTT, D.F.C., B.Sc., M.I.E.E., and J. K. WEBB, M.Sc., A.M.I.E.E.,

Standard Telephones and Cables, Limited, London, England

PART II

In Part I¹ of this article, a semi-historical account was given of the development of styrene technique from the initial laboratory requirement of a special joint for Life Test purposes. It is now proposed to examine briefly the physical phenomena in solid or mass impregnated cables leading to migration of oil or compound with resultant deterioration of such cables. It is shown that styrene technique provides simple, economical and efficient methods of reducing this deterioration. In a subsequent part of the article now in preparation, the development of the styrenation technique will be dealt with in some detail, with particular reference to special applications of the technique to certain types of cable and to transformers and other electrical plant.

IT has long been realised that, when solid type cables are laid on gradients, migration of compound is liable to occur and that, therefore, at vertical distances of from 50 ft. to 80 ft., it is necessary to introduce barrier or stop joints so that the hydraulic head is sectionalised and limited to the above mentioned values. In the limit, attempts to suspend long lengths of impregnated paper insulated cables vertically have led to various forms of trouble due to the hydraulic heads produced and the oil migration induced. Special drained types of paper cable have been proposed, also jute insulated cables, but in general rubber insulated cables have been employed. All these alternative types for vertical runs have certain inherent disadvantages, and it would be convenient and economical to render ordinary paper cables suitable for such work. This is particularly the case in situations such as mine shafts or shafts leading down into tunnels.

It is obvious from Part I of this article that the styrene joints and plugs described therein are likely to meet this need if they can be applied commercially at a reasonable cost. One possible technical objection to their use will be dealt with hereinafter, viz., drainage from the region situated vertically immediately below the plug or joint.

It is claimed, however, that the above utilisation of styrene technique to prevent flow of oil down slopes is only part of the technical field in which gain is effected. It will be shown in the third part of the article that styrene may be employed with advantage as the main

insulation of cables even where the impregnant is a gas, i.e., in cases where liquid flow is absent. In this instalment it is proposed to deal principally with a third field of application, viz., that covered by the sealing-off of ends of lengths of cables so that no interference with the behaviour of the insulation within the lead sheath of the cable is permitted from oil, compound, moisture or gas resident in the joints, boxes or potheads into which the ends of such lengths of cable are led.

A simple illustration may be included here by way of explanation. Fig. 1 illustrates the normal set-up of a single core cable which terminates in an end box forming part of a high tension transformer. In a set-up of this nature there is a serious risk of leakage in the course of time of transformer oil through the gasket of the porcelain insulator. This oil increases the volume of compound in the end box and reduces the viscosity. The tail cable entering the box is generally working "hot" due to propinquity to the transformer and also, in many cases, due to exposure to the sun's rays. The resultant oil pressure built up in the tail cable forces cable oil into the box. The combination of oils or compounds in the box is, therefore, kept under pressure and in course of time is forced through the gaskets of the box. In times of low load in winter contraction of the oil/compound mixture occurs, low pressure is set up, and there is a danger of breakdown. In certain cases the transformer oil appears to be on top of the box compound and to form a boundary surface of weakness. Fig. 1 shows where the breakdown occurred in this particular case. Innumerable instances of trouble due to

¹*Electrical Communication*, October, 1937.

leakage of transformer (or switch) oil into box compound have been reported to the authors. The trouble appears to be most pronounced after the transformers have been in service for about seven years. In recent years certain types of oil-resisting compound have been put on the market and have been used in many cases. It is somewhat early to assess their efficacy when used as box filling compounds since seven or eight years must elapse before they can be passed out as satisfactory. One method of dealing with this trouble is shown in Fig. 2. The cable end entering the box is styrenated at its extremity; the box compound is eliminated and a connection made to the conservator of the transformer. The box is filled right up to the top with transformer oil, the expansion and contraction of which is dealt with by the conservator.

New cables being installed in connection with the transformer can be styrenated in the factory, the styrenated end being fitted first and length adjustments made at the other end. The first installation of this kind was made in June, 1936, at Manchester, on a set of 33-kV transformers, and the installation is giving entire satisfaction.

Alternatively the styrenation can be effected on site. This is necessary of course in the case of cables already installed and working. Two methods of styrenation, designated the "hot" and "cold," are available.

All types of cable can be dealt with by one or other of the methods developed, although in some cases the technique is still somewhat cumbersome and is under development. Fig. 3 shows a laboratory demonstration of the fitting of a 6.6-kV belted cable to an end box (in this

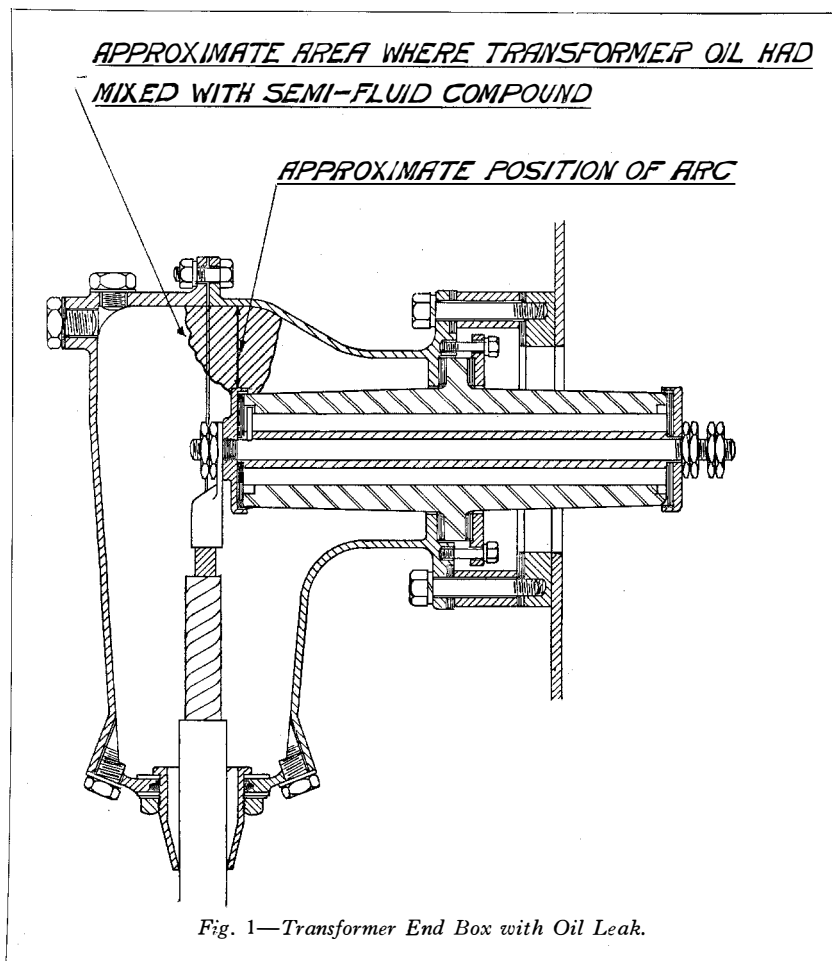

Fig. 1—Transformer End Box with Oil Leak.

case not a transformer box). One customer has even found it desirable to styrenate a 2-kV concentric cable. Fig. 4 illustrates another form of styrenated (single core) cable termination made up by "cold" polymerisation. In this case the termination is housed in a sealing bell or pothead.

In the transformer box case dealt with above, we have ignored the effect of hydraulic head, which may in some cases complicate matters if the cable rises from the transformer end box to an overhead line. The styrenated end is capable of withstanding pressures of the order of 5 or 6 atmospheres for long periods of time, so that it is capable of dealing with such cases. The hydraulic head problem is perhaps more usually encountered in cable terminating in sealing ends or potheads, the arrangement being often similar to that shown in Fig. 5. This case is worthy of somewhat detailed study

for it leads directly to the main migration problem considered herein.

Let us first look at some known phenomena resulting from the set-up of Fig. 5. It is usual to leave "gas cushions" in the potheads or, alternatively, to fill up and to provide sylphons. At all temperatures at which the compound or oil in the cable is fluid, flow takes place so that oil enters the lower pothead *B* and compresses the gas cushion (or the gas cushion of the sylphon). This compression builds up pressure until equilibrium is reached at which stage the pressure in the lower pothead is equal to *H* feet of oil. The volume of oil flowing into the bell *B* will depend on the reduction of gas volume in the cushion in that bell necessary to compress the gas to the pressure *H*. This volume of oil will eventually be removed from pothead *A* with consequent reduction of pressure in *A*. The reduction of pressure may easily be

of the same order as *H*. For example, if *H* were 20 ft., the initial total pressure on *B* would be about $1\frac{1}{2}$ atmospheres absolute, *A* having an initial pressure of 1 atmosphere absolute. Equilibrium in this case would occur at around $1\frac{1}{4}$ atmospheres absolute (in *B*), leaving the gas pressure in *A* at $\frac{3}{4}$ atmospheres absolute. This equilibrium might, however, not occur for some considerable time. For the moment, effects due to the expansion of the oil or sheath due to heating are ignored. If the viscosity of the oil is fairly high and the hydraulic resistance between *C* and *B* is low relative to the pressure H_2 and compared with the resistance from *A* to *C* and H_1 , discontinuous flow may occur. In a case observed pothead *B* received oil and rose to pressure H_2 four or five days before pothead *A* lost any appreciable volume of oil. A vacuum was evidently formed in the region of *C* which slowly filled up.

It is not too difficult to analyse the factors leading to this result. If H_2 is greater than the gas pressure in *B*, and the resistance between the points *C* and *B* is low, flow will occur, thus rapidly forming a vacuum round the region *C* and building up eventually an absolute pressure H_2 in *B*. If the gas cushion in *B* is large, a considerable volume of oil may be removed from the region of *C* before the pressure H_2 absolute is reached at *B*.

If, however, the resistance between *A* and *C* is large and the pressure H_2 is small, not even the assistance of the expansion of the gas cushion in *A* will cause sufficiently rapid flow to keep the cable full in the region *C*. Calculations on a theoretical basis founded on the above analysis give time intervals which correspond quite closely with the observed results.

It may be interpolated here that raising the viscosity of the oil will accentuate this "unfilled period" during which the cable at *C* is at least partially denuded of oil.

When the cable is refilled at *C* the pressure driving the oil towards *B* will become greater than *H*, i.e., equal to H_2 plus H_1 plus the residual pressure

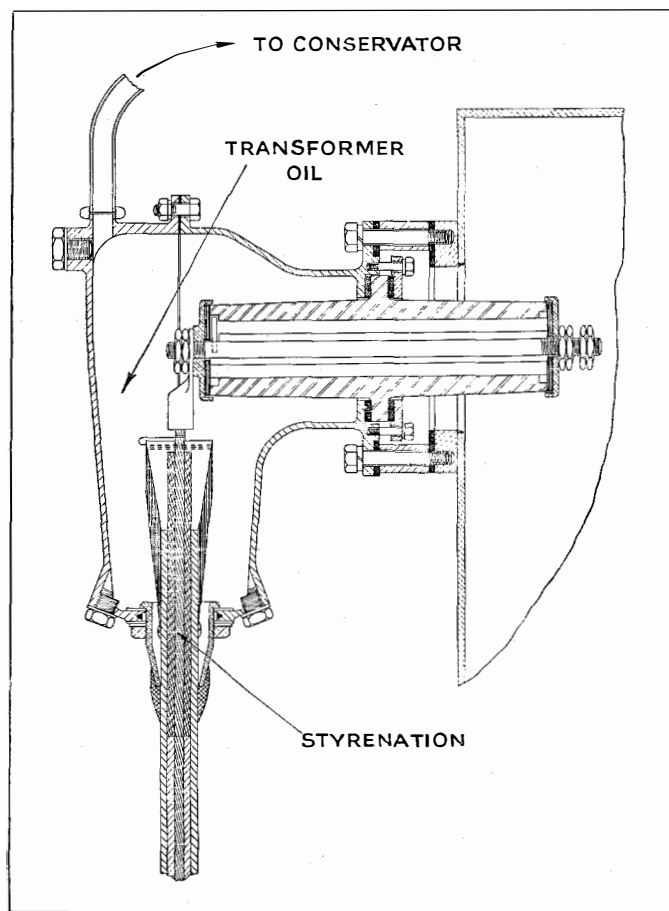

Fig. 2—Styrenated Transformer Tail.

in *A*. Further flow will therefore occur and *B* will receive more oil.

It is of course obvious that opening of either *B* or *A*, for example, in order to examine the oil level, will restore the gas pressure in the bell. In either case oil will flow from *A* to *B*.

On the other hand, if bell *B* is heated while *A* remains cold, the expansion of oil in *B* will cause increased gas pressure in this bell and will force oil back towards *A*. Subsequent cooling of *B* will reverse the flow.

It may be noted here that the practice of leaving gas cushions in potheads is somewhat dangerous for two reasons. First of all, it places gas in contact with the oil and encloses it in the cable system. Considering the care taken in degasifying the cable impregnant and in evacuating the cable itself, this cannot be good practice. Secondly, if and when leaks develop in gaskets, it is much easier to emit gas from the system than to emit oil. It may be forecast, therefore, that in course of time the gas will leak from pothead *B* so that this pothead gradually will fill up with oil and the porcelain and metalwork will take the pressure *H*.

This would be a serious matter if, for example, it occurred immediately after installation and before the cable went on load. Any increase of temperature in the pothead would build up a very high pressure due to the expansion of the oil. Even if the pothead remained cool due to ideal thermal dissipation, the expansion of oil in the cable would set up pressures of the order of 50–100 lb./sq. in. which would tend to wreck the pothead. This type of trouble was experienced to a considerable extent several years ago in Great Britain, and expansion domes or "lighthouses" and/or sylphons were hurriedly added to many potheads. Thirdly, the gas cushion should be designed from the point of view of volume and pressure so as adequately to meet all the service demands. This implies a complete hydraulic design for the solid cable along similar lines to those worked out for oil filled cables.

It may even be desirable to pump the gas cushion in *B* to a pressure higher than atmospheric in order to maintain approximations to

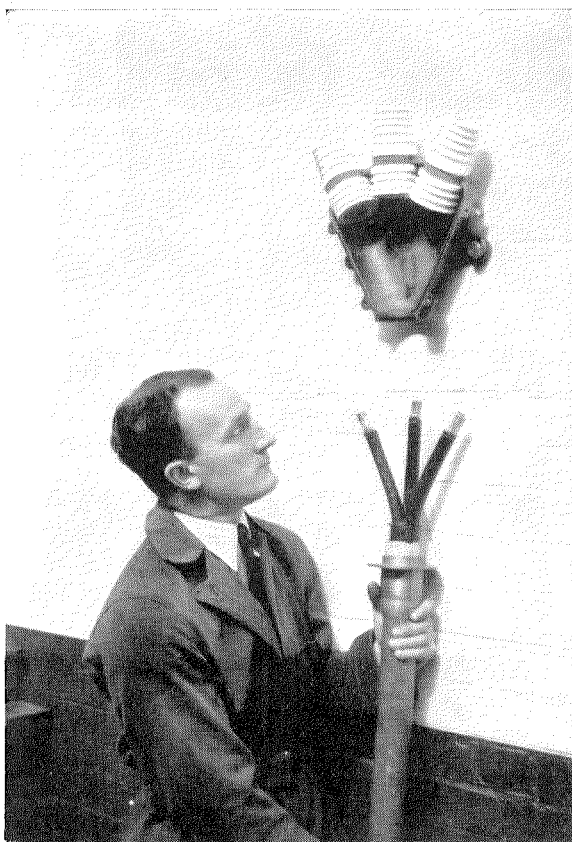

Fig. 3—Trifurcated Styrenated 6.6-kV Cable.

equilibrium over the major portion of the working load cycle of the cable.²

When the oil is really fluid, due to load or to the use of an oil of low set point, the two potheads—assumed free from leakage—reach equilibrium so that in *A* the gas volume increases and the gas pressure falls; in *B*, the gas volume decreases with resultant rise of pressure. Heating of the cable on load causes oil to flow into both *A* and *B*, so that the pressure difference is still *H* when equilibrium is reached. Cooling of the cable as the load decreases causes oil to be forced back into the cable from both *A* and *B*. If the oil does not become too viscous, equilibrium will still be reached between *A* and *B*; however, a "discontinuous" state of flow may arise both during heating and also cooling as described above for cold newly-installed cable. The general case is extremely complicated.

² "Supertension Joints and Terminations," by T. R. Scott, *The Electrical Power Engineer*, November and December, 1934.

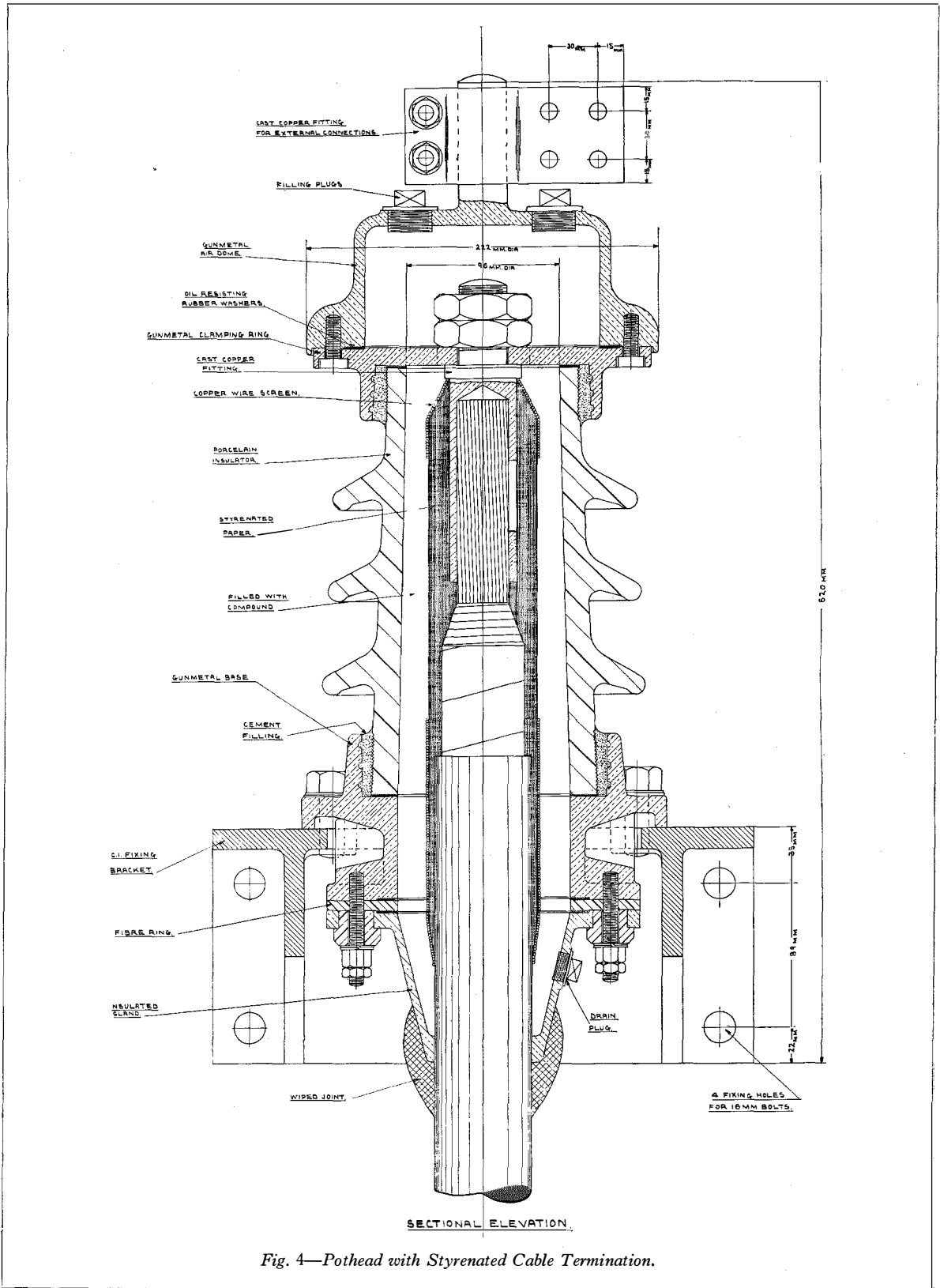

Fig. 4—Pothead with Styrenated Cable Termination.

An experimental survey of the flow, under various conditions of loading, gas cushion design, etc., and including also a theoretical analysis of flow conditions in solid types of cables, has been made by the authors. The experimental set-up was similar to that shown in Fig. 5, except that the cable rose between C and D, this being a more general case in practice. The effect of lead distension was included in the survey and also the variations effected by inserting plugs of various types.

The longitudinal and radial flow characteristics of solid type cables had previously been studied in some detail. Radial flow is an important factor in the recovery of cables after heat cycles. Radial resistance can be measured quantitatively in a simple manner³ and may be correlated with paper porosity, tightness of lapping and other cable design features. Longitudinal flow characteristics were measured quantitatively in connection with the development in the Laboratory of the "sheath impregnation" method⁴ whereby solid cables are impregnated after sheathing with ordinary viscous compounds.

Both types of flow are of importance in developing methods of styrenating cables without removal of the sheath by the methods briefly described in Part I of this article.

In the case of migration problems, longitudinal flow is by far the most important item and it seems worth while here to consider some quantitative data relating thereto.

The so-called "solid" type of power cable differs only from the hollow core, oil-fed type in degree so far as the longitudinal flow of compound is concerned. In the case of the former, an oil of higher viscosity is used, and moreover, the fluid resistance is higher. Flow, however, does take place in practice.

³ "Electrical Insulating Papers for the Manufacture of Power Cables," by T. N. Riley and T. R. Scott, *Journal of the I.E.E.*, August, 1929.

⁴ B.P. 379 704.

A cable conductor is stranded to give flexibility, and the interstices between the individual strands provide a channel along which oil can flow. Furthermore, there is some space between the insulation and the lead sheath which also has the property of fluid conductance.

For purposes of analysis, the fluid volume resistance/cm R may be defined as the drop in pressure per cm required to cause unit volumetric flow of a fluid of unit viscosity. It can be expressed by the equation :

$$R = \frac{\frac{dp}{dl}}{\eta \frac{dv}{dt}} \dots \dots \dots (1)$$

R is in c.g.s. units when :

- p = pressure difference in dynes/cm²,
- l = length in cm,
- v = volume of fluid in cm³,
- η = viscosity of fluid in poises,
- t = time in seconds.

Defined in this way, R is independent of the type of fluid used and measurements made with air agree substantially with those made with oils.

Average values which have been obtained for the copper conductors alone are given in Table I.

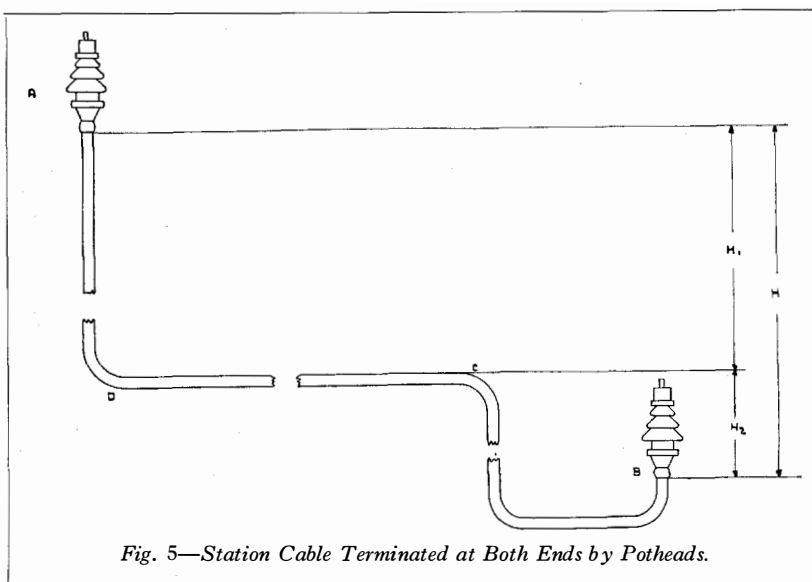

Fig. 5—Station Cable Terminated at Both Ends by Potheads.

TABLE I

Strand Section sq. in.	Fluid Resistance/cm R in c.g.s. units.
0.15	35 000
0.20	20 000
0.25	12 000
0.30	8 000

Due to the parallel path offered by the space between the insulation and the lead sheath of a single core cable, the overall fluid resistance/cm will have a value considerably below that of the strands alone. A clearance of only 15 mils across one diameter is sufficient to reduce the resistance to the order of 1 000–4 000 c.g.s. units.

From a knowledge of the fluid resistance/cm and the viscosity of the oil filling the cable, together with the pressure difference, the rate of flow $\frac{dv}{dt}$ may readily be calculated from equation (1). Thus, consider a length of 200 yards (or 18 300 cm) of cable having a fluid resistance/cm of 4 000 c.g.s. units. At a temperature of 20° C., the viscosity of the oil might be about 20 poises. If the pressure difference between the ends of this length is 10 lb./sq. inch (i.e., 689 000 dynes/cm²) the rate of flow will be :

$$\frac{dv}{dt} = \frac{689\,000}{18\,300 \times 20 \times 4\,000 \times 3\,600} \\ = 1.7 \text{ cm}^3/\text{hour.}$$

If the cable is on load and consequently at a higher temperature the viscosity of the oil may decrease to a value of only about 1 poise, so that under these conditions the rate of flow will be increased twenty-fold, or to about 34 cm³/hour.

In so far as any flow occurs in the dielectric itself, it may usually be regarded as being purely radial and due to the effects of thermal expansion and capillary attraction. The longitudinal fluid conductance of the dielectric is negligibly small compared with that of the strand and space under the sheath. In the case of a 3-core cable there is a further conductance due to the worming spaces, where the packing material is very much looser than the dielectric proper.

Fig. 6 illustrates graphically, by the shading effect, the low packing density which may exist in the filler spaces of a three conductor screened cable. The figure is reproduced from a photograph of a styrene wafer constructed by the method developed by Wyatt⁵.

It was intended originally to extend the discussion in this article to cover the above mentioned experimental data and theoretical analyses of migration problems but it has been decided to publish them separately. It is useful, however, to record herein the following conclusions reached in this study :

(1) Importance of the value of the fluid resistance of a cable

The behaviour of a cable is largely determined by the value of its fluid resistance, a factor which has received little or no attention in the past in connection with solid type cables. The movement of compound is a function of the static pressure due to the gradient, the viscosity, the rate and amount of expansion, and the fluid resistance. Determination of the latter gives a measure of the looseness of the lead sheath.

A 100 ft. length of cable hung vertically down a shaft reimpregnates on a heat cycle from the accumulation of oil at the base some 5 times more rapidly than 300 ft. of similar cable laid on a gradient of 1 in 6.

It follows that in selecting positions for stop-joints or plugs, resistance values should be studied just as carefully as gradient values.

(2) Except those situated at the base of a gradient, all joints tend to supply oil to cables and, therefore, gradually to become denuded of oil

The phenomenon of "ratcheting," which is frequently encountered in power cables, is due to oil flowing in the direction determined by the pressure gradient when the cable is relatively cold. An increase of temperature consequent upon an increase of load causes this oil to expand. This results in the building up of large hydraulic pressures which tend to force the oil back along the cable to its original

⁵ Paper planned for early publication in *Electrical Engineering*.

location; but, if the temperature increase is rapid enough, the pressures may be of sufficient magnitude to cause a permanent distension of the lead sheath and further accumulation of oil at such points. The same cycle of events recurs with each load cycle, although the magnitude of the pressures diminishes due to the distension of the lead sheath and consequent lowering of the longitudinal fluid resistance. Observations along similar lines were made in 1929 by C. F. Hirshfeld, A. A. Meyer, and L. H. Connell.

Unless the joints are pressure fed, they must gradually deteriorate because of the loss of oil.

The relatively high mortality of such joints compared with cables is probably associated with this phenomenon.

(3) The major portion of a full length of solid type cable between reservoir type joints or terminations, i.e., the portion other than the few yards adjacent to the latter, works successfully under reduced hydraulic pressures at periods of low loads

It follows that if the lengths were sealed off, for example, by styrene joints, there is no reason why the whole length should not work satisfactorily. In other words, the few yards adjacent to the joint should be at least as strong electrically as the major portion of the length.

(4) The few yards of cable adjacent to terminations and joints with gas cushions, in general, exhibit deterioration products which are absent from the major portion of the length

This is partly due to the diffusion of gas from the gas cushion of the joint or termination, the diffusion being aided by the ratcheting of the oil into the cable.

It is obvious, if the statements regarding migratory phenomena made in this paper can be substantiated,—as they can,—that the applica-

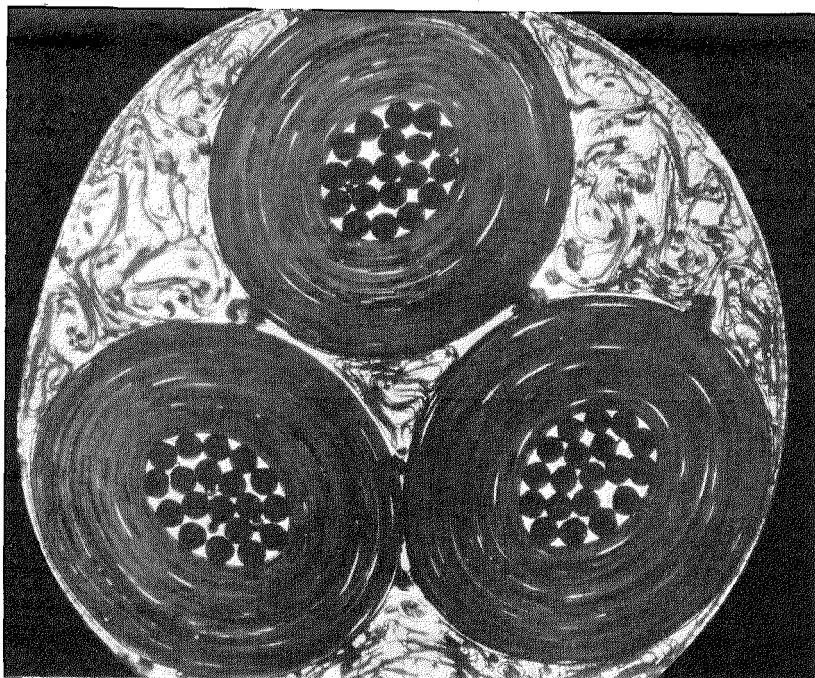

Fig. 6—Styrene Wafer of 3-Core Cable Showing Filler Space Density.

tion of styrene joints, plugs and terminations at carefully selected positions will prevent the considerable movement, oscillatory or unidirectional in trend, of compound or oil which at present occurs in solid cables in service. Faults due to such causes may be few in number and deterioration effects at electrical stresses at present employed may be slow. The number of faults occurring due to compound migration, however, are numerous enough to justify insurance against the contingency of their occurrence. Attempts to cheapen cable networks must involve the increase of working electrical stress and/or the increase of working temperature; deterioration, therefore, in the future, will become more rapid and more important. The advent of styrenation technique may therefore be stated to be timely and likely to accelerate progress.

The positioning of the styrene barrier, however, must be carefully studied. A barrier at *A* in Fig. 5 would make matters worse if it were not accompanied by a barrier at *B*. A barrier at *B*, however, would be beneficial even if the barrier at *A* were omitted.

Generally speaking a barrier should be inserted at some point near the base of the

gradient, and further barriers inserted at points higher up as indicated by studies of the resistance and pressure heads of the various sections of the line. In view of the statements made above, it may be claimed that it is definitely advantageous to make every joint a styrene joint, every termination a styrene termination, and to insert where necessary styrene plugs in positions where migration may

occur within the length of cable between normal joint positions.

There is no reason why this application should not be effected without undue expense if styrene technique can be simplified to a point where it competes commercially with other schemes. The developments carried out to this end will be described and discussed in Part III of this paper.

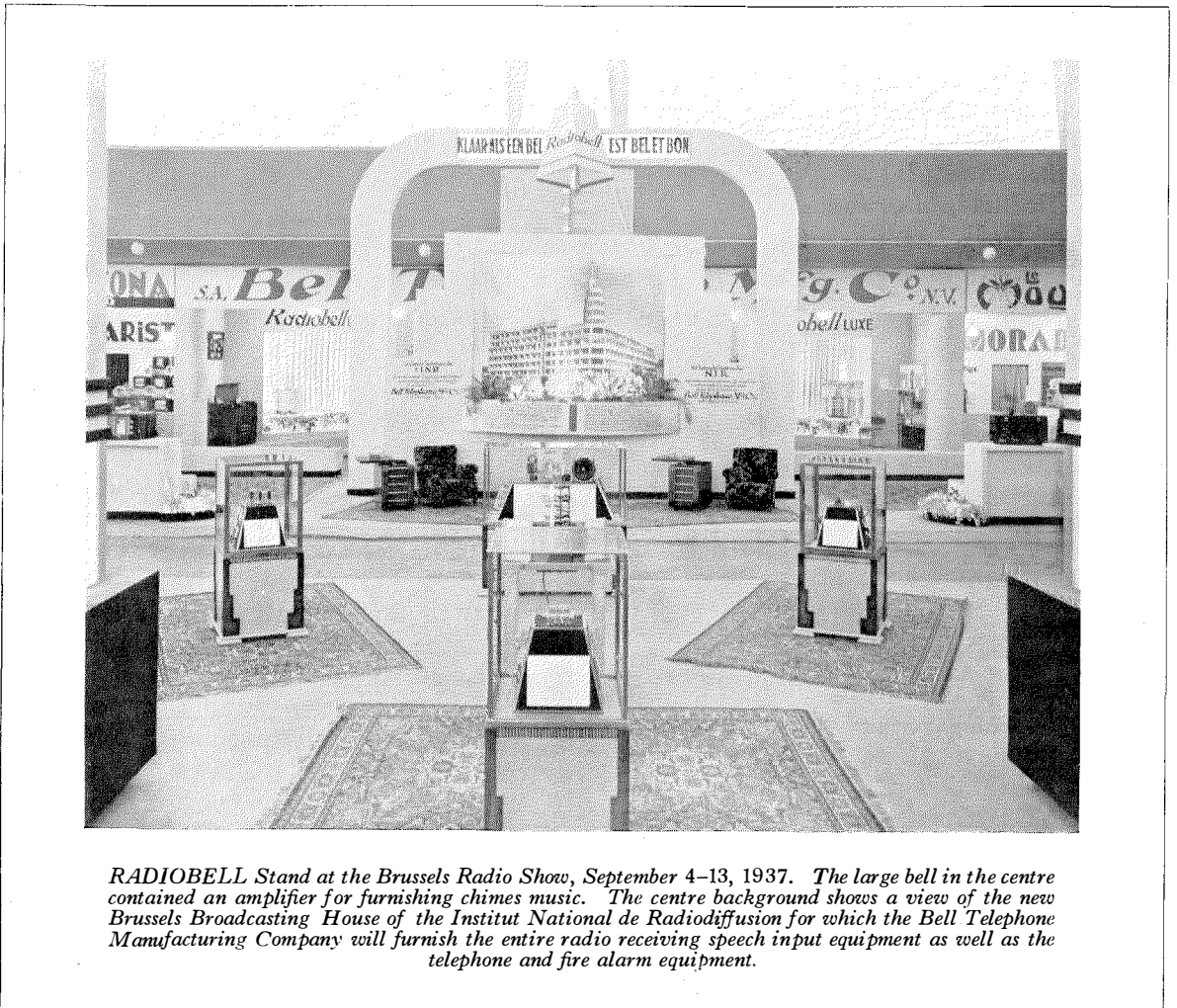

RADIOBELL Stand at the Brussels Radio Show, September 4-13, 1937. The large bell in the centre contained an amplifier for furnishing chimes music. The centre background shows a view of the new Brussels Broadcasting House of the Institut National de Radiodiffusion for which the Bell Telephone Manufacturing Company will furnish the entire radio receiving speech input equipment as well as the telephone and fire alarm equipment.

Recent Telecommunication Developments of Interest

Automatic Ticketing Applied to Teleprinter Switching.—The Czechoslovakian Telegraph Administration has decided to inaugurate person-to-person Teleprinter services including the linking-up of Czechoslovakia with the European Teleprinter Exchange Network. The requisite Switching Equipment for Teleprinter Exchanges in Prague and Brno has been ordered from Creed and Company, Limited, and is being manufactured by the Bell Telephone Manufacturing Company, Antwerp. It comprises Automatic Switchboards providing for dial controlled local, national long distance, and incoming international connections; Manual Switchboards at which “long period” connections and “broadcast” connections will be set up; and a Toll Switchboard (International) providing for the supervision and dialled extension of international calls originated by Czechoslovakian subscribers.

It is of particular interest that the recording of calls will be carried out automatically by ticket printing registers operating in conjunction with the connecting circuits of the automatic switchboards.

• • •

Surgical Equipment.—The use of high frequency currents for surgery is rapidly growing, due to their advantages for many classes of operations. Foremost amongst these advantages are absence of bleeding, prevention of spread of infection, ease of sealing severed arteries, less shock to patient and more rapid healing.

The R.1 Surgical Equipment or “Electrocisor” has been developed by Standard Telephones and Cables, Limited, for carrying out this “bloodless” surgery in conformance with modern operating technique. Primary features are facilities for all modes of operating by the manipulation of only two controls, and mechanical design giving convenience, safety and ease of cleansing and sterilising.

The “Electrocisor” is mains-operated and uses a spark type oscillator in order to ensure reliability during operation as well as minimum

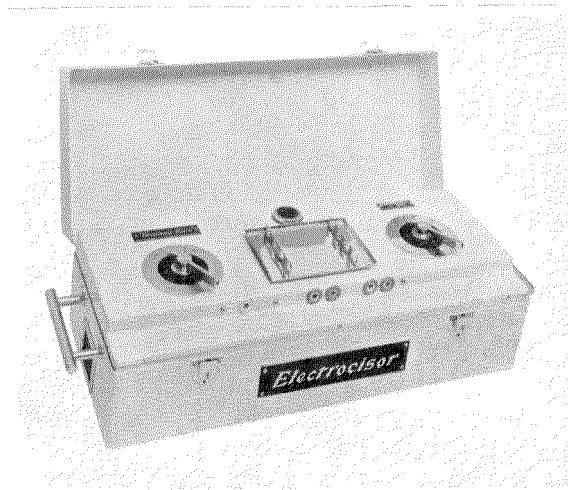

“Electrocisor” Surgical Equipment.

maintenance expense. It works on a frequency of approximately 1.5 megacycles and has a nominal output of 200 watts. The equipment includes a removable cover locking on to the case for convenient transportation. In accordance with hospital practice, it may be fitted with a wheeled trolley or carriage.

The actual operating procedure is to divide the tissue by a spark passing to the patient from a needle type of electrode brought close to the tissue and then drawn fairly swiftly across it, or to dry up, or coagulate the tissue by a disc or sphere electrode placed in contact with the patient for a few seconds. The former method is used for incisions and the latter, for destroying or isolating growths or abnormal tissue. Many modifications of these two essential modes of operating are followed in practice and call for a variety of electrodes for specific duties. For use with the equipment the R.1 Surgical Instrument Kit is available, comprising a wide selection of electrodes which fit into insulated holders mounted in a metal case. Case and contents are all sterilisable.

As an optional item a footswitch is supplied, duplicating the “On/Off” switch on the equipment itself and relieving the surgeon’s hands of this control.

The weight of the Equipment is 68 lb. (31 kg) and the overall dimensions are 2' 5" \times 8 $\frac{3}{8}$ " \times 10 $\frac{7}{8}$ " (735 \times 213 \times 276 mm).

• • •

Distant Talking and Loudspeaker Subscriber's Set.—A combined Distant Talking and Loudspeaker Subscriber's Telephone Set has been developed by the Bell Telephone Manufacturing Company, Antwerp. Its use enables telephone subscribers to talk into the transmitter from a distance, as for example, when walking about a room, provided the voice is kept at an even level, the maximum distance being, however, determined by the acoustic properties of the room. When the called party replies, the same instrument acts as a loudspeaker.

This new device is a convenience in conferences and for similar purposes, since groups of individuals at either end of the telephone connection can hear as well as participate in the conversation without changing their positions. Further, the hands are left free since a telephone instrument is not required but is available for privacy purposes if desired.

The 2002-A Distant Talking and Loudspeaker Subscriber's Set shown in Fig. 1 can be connected to any automatic or C.B. manual telephone line and the hand-set also is available for use. When the start key is depressed, current is connected to the amplifier and a pilot lamp in-

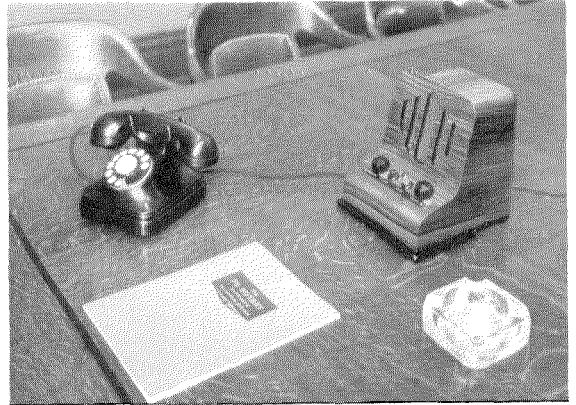

Fig. 2.

dicates that the amplifier is in operation. The amplifier operates from A.C. mains supply. A separate D.C.-A.C. converter of the vibrator type is added for operation from D.C. mains. Should speech be too loud or weak, the volume can be adjusted. Switching from talking to listening is automatically done by voice operated relays, manual switching also being provided.

The 2004-A equipment shown in Fig. 2 is similar, with the exception that the control keys are mounted on the loudspeaker instrument. This permits the use of a standard subscriber set.

The amplifier is equipped with quick-heating valves and is only in operation when in actual use, giving economy in valve life and current consumption.

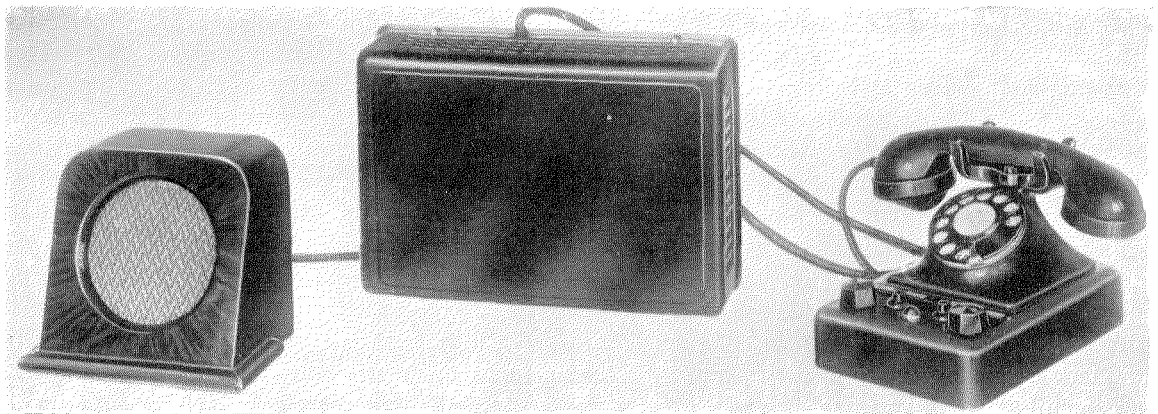

Fig. 1.

Licensee Companies

BELL TELEPHONE MANUFACTURING COMPANY.....	<i>Antwerp, Belgium</i>
<i>Branches : Brussels</i>	
BELL TELEPHONE MANUFACTURING COMPANY.....	<i>Berne, Switzerland</i>
BELL TELEPHONE MANUFACTURING COMPANY.....	<i>The Hague, Holland</i>
CHINA ELECTRIC COMPANY, LIMITED.....	<i>Shanghai, China</i>
<i>Branches : Canton, Nanking, Tientsin.</i>	
COMPAGNIE DES TÉLÉPHONES THOMSON-HOUSTON.....	<i>Paris, France</i>
COMPAÑÍA RADIO AEREA MARITIMA ESPAÑOLA.....	<i>Madrid, Spain</i>
COMPAÑÍA STANDARD ELECTRIC ARGENTINA.....	<i>Buenos Aires, Argentina</i>
CREED AND COMPANY, LIMITED.....	<i>Croydon, England</i>
FABBRICA APPARECCHIATURE PER COMUNICAZIONE ELETTRICHE.....	<i>Milan, Italy</i>
<i>Branch : Rome.</i>	
INTERNATIONAL MARINE RADIO COMPANY, LIMITED.....	<i>London, England</i>
INTERNATIONAL STANDARD ELECTRIC CORPORATION, <i>Branch Office</i> ,...	<i>Rio de Janeiro, Brazil</i>
JUGOSLAVIAN STANDARD ELECTRIC COMPANY, LIMITED.....	<i>Belgrade, Yugoslavia</i>
KOLSTER-BRANDES, LIMITED.....	<i>Sidcup, England</i>
LE MATÉRIEL TÉLÉPHONIQUE.....	<i>Paris, France</i>
<i>Branch : Rabat, Morocco.</i>	
NIPPON DENKI KABUSHIKI KAISHA.....	<i>Tokyo, Japan</i>
<i>Branches : Osaka, Dairen, Taihoku.</i>	
SOCIÉTÉ ANONYME LES TÉLÉPRIMEURS.....	<i>Paris, France</i>
STANDARD ELECTRIC AKTIESELSKAB.....	<i>Copenhagen, Denmark</i>
STANDARD ELECTRIC COMPANY W POLSCE SKA z O. O.....	<i>Warsaw, Poland</i>
STANDARD ELECTRIC DOMS A SPOL.....	<i>Praha, Czechoslovakia</i>
<i>Branch : Bratislava.</i>	
STANDARD ELECTRICA.....	<i>Lisbon, Portugal</i>
STANDARD ELECTRICA ROMÁNA, S.A.....	<i>Bucharest, Rumania</i>
STANDARD ELÉCTRICA, S.A.....	<i>Madrid, Spain</i>
<i>Branches : Barcelona, Santander.</i>	
STANDARD ELEKTRIZITÄTS-GESELLSCHAFT A.G.....	<i>Berlin, Germany</i>
STANDARD TELEFON-OG KABELFABRIK A/S.....	<i>Oslo, Norway</i>
STANDARD TÉLÉPHONE ET RADIO, S.A. Zürich.....	<i>Zürich, Switzerland</i>
STANDARD TELEPHONES AND CABLES, LIMITED.....	<i>London, England</i>
<i>Branches : Glasgow, Leeds, Dublin, Cairo, Pretoria, Calcutta.</i>	
STANDARD TELEPHONES AND CABLES (AUSTRALASIA), LIMITED.....	<i>Sydney, Australia</i>
<i>Branches : Melbourne ; Wellington, New Zealand.</i>	
STANDARD VILAMOSSÁGI RÉSZVÉNY TÁRSASÁG.....	<i>Budapest, Hungary</i>
SUMITOMO ELECTRIC WIRE & CABLE WORKS, LIMITED.....	<i>Osaka, Japan</i>
VEREINIGTE TELEPHON- UND TELEGRAPHENFABRIKS AKTIEN-GESELLSCHAFT, CZEIJA, NISSL & CO.....	<i>Vienna, Austria</i>

Sales Offices and Agencies Throughout the World
