

RECEIVED
COMMUNICATIONS SECTION
FEB 25 1951

H. E. Pank
7-1-51

TECHNICAL PAPERS Presented at the



Engineering Conference March 25-31, 1951

10-10
10

No. 171
\$10.00

M. S. Ponte
9-1-71

~~81553~~

TECHNICAL PAPERS Presented at the



Engineering Conference

March 28-31, 1971

ENGINEERING DEPARTMENT
NATIONAL ASSOCIATION OF BROADCASTERS



TAB BOOKS
BLUE RIDGE SUMMIT, PA. 17214

FIRST EDITION

FIRST PRINTING—AUGUST 1971

Printed in the United States
of America

Reproduction or publication of the content in any manner, without express permission of the publisher, is prohibited. No liability is assumed with respect to the use of the information herein.

Library of Congress Card Number : 70-171723

CONTENTS

OPENING OF THE CONFERENCE	5
NAB ENGINEERING ADVISORY COMMITTEE REPORT	6
SMPTE STANDARDS FOR TELEVISION	9
JCIC COLOR COMPATIBILITY PROGRESS REPORT, BTS-VIR COLOR SIGNAL FIELD TEST RESULTS	12
EMERGENCY BROADCAST SYSTEM PANEL	19
OPERATIONAL & ECONOMIC CONSIDERATIONS OF THE AURAL STL	31
STEREO & SCA COMPATIBILITY CONSIDERATIONS	35
A DISCUSSION OF AUTOMOBILE RADIO RECEPTION	45
DESIGN & CONSTRUCTION OF A RECORDING CONSOLE FOR BROADCAST PRODUCTION FACILITIES	63
CARE & TREATMENT OF AILING DIRECTIONAL ANTENNAS	76
THE USE OF FERRITE COMBINERS FOR PARALLEL OPERATION OF AM TRANSMITTERS	82
EVERYTHING YOU ALWAYS WANTED TO KNOW ABOUT CARTRIDGE MACHINES---BUT WERE AFRAID TO ASK	87
PROGRESS REPORT ON TECHNICAL FACILITIES AUTOMATION OF TV STATIONS	92
THE AUTO CUE COMPUTERIZED LIGHTING CONTROL SYSTEM	102
RELATIONSHIP OF TELEVISION PICTURE QUALITY TO FIELD INTENSITY	109
MAGNETIC TAPES IN THE 70's	127

EXTENDING VIDEO HEAD WHEEL LIFE WITH DUST CONTROL BY LAMINAR AIR FLOW	138
VHF TV REMOTE CONTROL PANEL	144
RAPID CHECKOUT OF AUDIO & VIDEO TRANSMISSION PERFORMANCE IN A BROADCAST PLANT	156
NEW HIGH-IMPEDANCE, LOW-DISTORTION INTERPHONE AMPLIFIER	167
SIGNAL-LOSS DETECTOR SUITABLE FOR AUDIO & VIDEO SYSTEMS	173
ROLE OF THE CASSETTE VIDEO TAPE RECORDER IN STATION OPERATION	179
OPERATIONAL EXPERIENCE WITH VIDEO TAPE CARTRIDGES	182
THE FIRST 220 KW UHF TELEVISION TRANSMITTER	186
COMPUTERS & AUTOMATION—ARE THEY IN YOUR FUTURE?	209
FCC-INDUSTRY TECHNICAL PANEL	215

Opening of the Conference

Vincent t. Wasilewski
President: National Association of Broadcasters
Washington D. C.

Welcome to the NAB's 25th Annual Engineering Conference. For a quarter of a century, NAB has held these engineering conferences. And for good reason: engineering has always led the way in broadcasting. Technology is what makes the industry possible. In all modesty, I believe that the conference is regarded by nearly everybody in the industry as the high point of the engineering year. It provides an opportunity to inspect one or more pieces of gear from the vast amount displayed here. It is the place to see the latest broadcast engineering developments, since the NAB Convention is often chosen as the place where break-throughs in electronic equipment are unveiled for the first time. It is a place to learn, since the program planned by our able Engineering Vice President, George Bartlett, and your Engineering Conference Committee is always informative and, we hope, covers the waterfront from large stations to small. One other asset of the engineering conference is that it permits engineers to join the management and ownership session. Many of the top people in the industry have come up from engineering and engineering itself has broadened over the years to include many management functions, and we believe it is important for both management and engineering people to mingle together and see how the other half lives.

And so I hope that the total Convention—both engineering and management sessions—and the exhibits are worthwhile and informative. I hope you learn something. I hope you enjoy yourself. If the conference can be improved, let us know. It is your conference—put on for your benefit—and you should be satisfied. We hope you will be.

NAB Engineering Advisory Committee Report

Alert H. Chismark
Chairman, NAB Eng. Adv. Com.
Broadcasting Div./Meredith Corp.
Syracuse, N. Y.

Once again, it is my pleasure to present the traditional Engineering Advisory Committee report. It seems only yesterday that we were assembled to hear a similar report on the status of our past activities. Unfortunately, with our ever-increasing need to do more and more, faster and faster, these 12-month intervals seem shorter and shorter. Nevertheless, as chairman of the Engineering Advisory Committee, I am indeed pleased to bring you this status report on the Committee's activities during the past year. My remarks, as usual, will be brief and will just touch on the highlights of the more important aspects of our work and accomplishments since we last met.

First, I would like to express my appreciation for the assistance which has been given me by members of the Committee, a group of dedicated engineers working quietly and efficiently behind the scenes, acting as your liaison to the NAB, the industry, the FCC and other governmental agencies. Those serving on the committee this year are: Bob Flanders, Station WFBM; Gene Hill, Kaiser Broadcasting Corporation; Bill Honeycutt, station KDFW-TV; Les Learned, Mutual Broadcasting System; Jim Parker, CBS Television Network; Verne Pointer, American Broadcasting Company; Keith Townsden, station KLFY-TV; Bill Trevarthen, National Broadcasting Company; Ben Wolfe, Post-Newsweek Stations; and Bob Leach, formerly of U.S. Communications.

The past year has been another very busy period for the Committee, complete with the ever-present frustrations, an occasional sweet smell of success, the ever-present failures and, in some instances, a feeling of true accomplishment and contribution. Our activities have covered the proverbial waterfront and have ranged from microphone to antenna, camera to receiver, seminars to allocations. Solutions to some problems have not been easy, but we have attempted to lead the way in developing solutions to many of our thorny problems which confront the operational aspect of our industry.

Let's start off with the good news: After a seven year struggle, uphill and down, of field tests and experiments, of arguments and counter-arguments, I am happy to announce that the Commission has finally amended its rules to permit the remote control of VHF-TV transmitters. This has been a monumental accomplishment which involved thousands of man hours, literally hundreds of technical reports and untold numbers of field trips to substantiate the feasibility and reliability of such a technique. To afford you ample opportunity to fully explore the new rules, we refer you to the VHF-TV remote control panel session. I would suggest that all those interested in this new development read this material. It is such a milestone in our effort that I wish I could say "champagne for everyone."

Since our last meeting, the Commission has adopted the new Rules governing the sharing of TV Channels 14-20 with the Land Mobile Services. Although this proceeding basically has been terminated, there are other fringe areas which must be struggled with, such as restructuring the 947- to 952-MHz STL band and the use of 2150 MHz for aural STL service. We are still active in these allocation proceedings and are doing our best to reflect the industry's position.

In a continuation of our operator licensing activities, during July of 1971, the Com-

mission issued a Notice of Inquiry and Notice of Proposed Rule Making looking toward amending Part 73 of the Rules dealing with operator licensing requirements at directional AM stations. This action was based upon a petition which was filed by the Association with the approval of the Engineering Advisory Committee. Comments in this proceeding were due on February 23, 1971, and reply comments on March 23, 1971. Needless to say, we have been extremely active in this area and I think our filing on the 23rd can be considered a precedent-setting document which, hopefully, will lead the way in solving this thorny problem.

For years, we have been talking about revising the Commission's Rules and Regulations in one fell swoop; however, such a project is easier said than done. On January 8, 1971, we took the first step in this giant effort and submitted a very lengthy document with the Commission proposing a complete revision of Part 74 of the Rules dealing with radio remote pickup, studio-to-transmitter links, TV STL, remote pickup and intercity relays. This filing was based upon the advice and counsel of over 250 station engineers and was prepared under the guidance of a special ad hoc group of the Advisory Committee. It is the first step in a long-range project designed to develop meaningful changes on a large-scale basis rather than through the time-consuming piecemeal process we have been following in the past.

I know many of you have followed with some disappointment the lack of progress which has befallen our petition requesting a relaxation of the so-called "two-hour" inspection requirement and the remote logging of phase which we filed on January 20, 1967. You will notice that the Commission's rule making notice in the operator licensing proceeding makes reference to this pleading and poses questions on this subject. Hopefully, the two-hour reading controversy will be finalized at the time the new operator license rules are adopted.

One of the most controversial areas we have been involved in recently deals with the coding and identification of TV commercials and program material. You will recall that the Commission, over the strenuous opposition of the Association, adopted a new technical criterion which permits the transmission of coded information in the masked area of the picture. After the adoption of the new rules, it became evident that commercial material supplied to the stations did not comply with the Commission's new rules. A 90-day moratorium has now been issued during which time the technical criterion will be reviewed by the proponent and interested parties. We will, of course, follow this activity closely, filing whatever material we feel is in the interest of the broadcast industry.

Another problem area centers around the visibility of the transmitter and-or remote control unit from the normal operating position. This subject has promoted many heated discussions over the past several months, many of which have degenerated into some very violent sessions. It is a subject which warrants serious study as to its applicability in light of today's technological development and operational requirements. The requirement is presently under very close review by the Advisory Committee and hopefully a meaningful petition looking toward a clarification of the present rules will be filed with the Commission within the next few days.

We are still deeply involved in two subcommittee activities dealing with automatic transmitters and tower icing. Both of these efforts were scheduled as long-term continuing projects, but the latter (tower icing) has been accelerated by the recent storms in Chicago, along with the falling ice from the antenna structures atop the John Hancock building. However, this is not something that will be solved overnight and I'm sure we will be confronted with many similar situations before a solution is forthcoming.

We are pleased to report that another highly successful Engineering-Management Seminar was held during 1970 at Purdue University with approximately 40 broadcast-

ers participating from all sections of the United States and Canada. We have now scheduled an Advanced Engineering Management Seminar to be held at Purdue during December of 1971. Attendance will be limited to those who have completed one of the six basic courses and will be a continuation of the overall Purdue educational program. We strongly recommend that any of you who have completed the basic program make every effort to attend the Advanced Seminar.

Continuing with our educational efforts, a third Technical Seminar was held in Cleveland, Ohio, dealing with the design, operation and maintenance of directional antenna systems. This program is under the direction of Carl Smith and Associates and the response for this type of technical program has been so gratifying that a fourth such seminar has been scheduled for October, 1971. In view of the directional antenna questions asked by the Commission in its operator license proceeding and the possibility of a directional antenna endorsement, I would strongly encourage all those who have not done so to consider attending the October directional antenna technical seminar.

Color compatibility has been a subject of discussion for the past year or so and we have been cooperating with the SMPTE, IEEE, and EIA to effect a solution to the problem. You will learn more on this from Mr. Blair Benson's presentation on the proposed new Vertical Interval Reference signal which is presently being field tested.

Our Cassette standards program is now off and running and every effort is being made to expedite the adoption of professional cassette standards to assure the interchangeability of program material recorded on such devices. Our timetable envisions a date of mid-January, 1972.

These are but a few of the more important matters the Committee has dealt with since we last met. They have been reviewed for your information and to remind you that the Engineering Advisory Committee is your committee. It was established not only to advise the staff and the NAB Board of Directors in technical matters, but also to make your thoughts known to the industry and the Commission. If you have a technical problem which may affect the industry as a whole, make it known to your Engineering Advisory Committee. Let us hear from you. It is only through such feedback that we are able to properly and adequately represent you.

Again, on behalf of myself and the other Committee members, I would like to say it has been a privilege to serve as your spokesman and hope that our past efforts have met with your approval.

SMPTE Standards for Television

W. T. Wintringham
Engineering Vice President, SMPTE
New York, N. Y.

Twenty-one years ago, in 1950, the Society of Motion Picture Engineers recognized the growing interest of its members in television by changing its name to the Society of Motion Picture and Television Engineers. About the same time, its Engineering Committee on Television was formed, and the scope of its Engineering Committee on studio lighting was enlarged to include the lighting of television as well as of motion-picture studios. The standardizing activities of these Engineering Committees were coordinated carefully with the activities of committees in the Electronics Industries Association (then the Radio Manufacturers Association), the Institute of Electrical and Electronics Engineers (the Institute of Radio Engineers), and the National Association of Broadcasters (then the National Association of Radio and Television Broadcasters), through a Joint Committee for Intersociety Coordination. As a result of discussions and agreements in this Joint Committee, the SMPTE was given full responsibility for the preparation of Standards and Recommended Practices covering the production of video signals from motion-picture film and from video tape.

Today, the Society is sponsor for four American National Standards and for eight SMPTE Recommended Practices covering details of the use of motion-picture film in television. It must be kept in mind that these Standards and Recommended Practices supplement much larger numbers of related documents which cover the use of film in both the motion-picture and the television fields. Also, SMPTE is the sponsor for 11 American National Standards and for 11 SMPTE Recommended Practices covering details of the use of video tape in quadruplex recorders. Beyond these issued documents, there is a number of Draft American National Standards and Draft SMPTE Recommended Practices in each of the several steps of the preparation and of the approval procedures.

In order to facilitate the application of these American National Standards and SMPTE Recommended Practices in the adjustment and the evaluation of television film chains, the Society has available test material in the form of 35mm and 16mm motion-picture film in the form of 8 x 10-inch transparencies and the form of 2 x 2-inch slides. These materials are manufactured to a high order of precision in accordance with the Standards and the Recommended Practices in which they are specified. At the present time, we do not have similar test material in the form of video tape. However, our Engineering Committee on Video Tape Recording is working diligently on the specification and the procurement of such test materials.

The principal purpose of SMPTE sponsored American National Standards and of SMPTE Recommended Practices in the television field is to ensure the interchangeability of program material in recorded form. That is, motion-picture films or video tapes made in accordance with the Standards and Recommended Practices can produce identical pictures when handled by any television station making use of the Standards and the Recommended Practices. Toward this end, for example, our documents on video tape cover such obvious matters as the dimensions of the raw tape, of the reels, of splices, and of the vacuum guides in video tape machines. Other documents cover tape speed, modulation practices for low-band monochrome and color recording, for high-band recording, and the characteristics of the audio record. This series will be

supplemented in the near future by an SMPTE Recommended Practice (or possibly an American National Standard) for a code for tape editing. Still other Standards describe the leaders for monochrome and for color tapes; and also, we have a Recommended Practice which specifies the information that should appear on the labels of the reel on which a tape is wound and on the can in which the reel is stored. Standards and Recommended Practices have been issued specifying the characteristics of a number of test tapes, but the SMPTE has not yet begun distribution of these tapes.

It is well known that the acceptability of a color picture depends on the conditions under which it is viewed. As a first step towards insuring that different station engineers see the same picture, SMPTE has issued a Recommended Practice calling for a reference white on studio monitors corresponding to CIE Illuminant D6500. This leads directly to the problems of standardization of color motion-picture film for use in broadcasting. In this case, interchangeability is affected greatly by the fact that film is produced in motion-picture rather than in television studios, and the techniques which may have been proven suitable for films intended for theatrical projection may not be the most satisfactory for films intended for television broadcasting.

It is a fact that films having colors and ranges of density and of contrast that would yield acceptable pictures when projected in a theatre may well be quite unsatisfactory for television broadcasting. About a decade ago, the SMPTE issued a Recommended Practice defining the density and contrast range of monochrome films that would produce acceptable pictures when viewed over a television system. At the same time, a tutorial paper was published in the JOURNAL OF THE SMPTE disclosing the techniques of studio lighting most likely to result in satisfactory films for TV use.

The appearance of the colors in a projected motion-picture film depend, as in television, on the color of the reference-white light used for projection. It has been traditional in the motion-picture field to print 16mm color film for projection by a tungsten lamp (3000 - 4500 kelvins). This is, of course, much warmer (redder) than the reference white used in television (D6500 for studio monitors), so that a print made for tungsten projection appears far too blue (less red) when viewed through a properly adjusted television system. To alleviate this problem, an SMPTE Recommended Practice was issued last December requiring that 16mm prints for television use be reviewed by projection with a reference white on the projection screen of 5400 kelvins, much closer to the television viewing condition. It has been found that prints made in accordance with this Recommended Practice yield highly satisfactory television pictures. It is my expectation that, in time, the Society will issue a Recommended Practice calling for an illuminated surround in motion-picture-film review rooms to simulate even more closely the typical TV viewing situation. Such a practice has been standardized in Canada and in Europe; and it has been demonstrated to a number of engineers and producers by the Eastman Kodak Company.

The SMPTE Recommended Practice on Safe Action and Safe Title Areas for TV transmission is of concern principally to motion-picture and to television producers. Since part of the broadcast picture is hidden behind the mask on the picture tube of the typical home receiver, important information must be confined to the restricted areas defined in this Recommended Practice if it is to be seen by the home viewer.

The American National Standards on the areas to be scanned from 16mm and 35mm motion-picture film and from slides and opaques are intended for use in the alignment of film-camera chains. These Standards define the equivalent areas on the films or slides which should be scanned, and also the areas which should be projected optically onto the cathodes of the camera tubes. These scanned areas are realistic from the practical point-of-view, since the height and the width dimensions of the scanned areas are about 3 percent smaller than the optically projected areas, and, in addi-

tion, are about 5 percent smaller than the images printed on the films. Test films and slides are available from the SMPTE for use in the alignment of the scanned areas in film-camera chains.

These SMPTE alignment test films and slides contain test patterns for checking resolution, mid-band streaking, astigmatism, field uniformity, scanning linearity, and interlace. We are working in our Engineering Committees at the present time on many other test-films, slides, and transparencies which are needed in the day-to-day operation of a television station. These test materials will be available in the form of 8 x 10-inch transparencies for checking and aligning live cameras in the studio, as well as in the forms required for use in film-camera chains.

Another test material that should be mentioned is the SMPTE Color Reference Film, which is available in 16mm and 35mm motion-picture film and as 2 x 2-inch slides. This test material was manufactured under carefully controlled conditions and is representative of the application of the best techniques for the production of color films for television use. These test materials should produce excellent color pictures when used in any properly adjusted film camera chain and viewed on a properly adjusted monitor. In addition to its utility for overall checking of a color television system, this Color Reference Film is a valuable reference for the evaluation of other color films. Film laboratories make use of the Color Reference Film in this way, as a guide for the printing and the processing of color films for television use.

In addition to its activities in standardizing the picture portion of material for television on motion-picture film or on video tape, SMPTE is active in the standardization of the sound records on these same materials. For example, the American National Standard for the audio record on 2-inch video tape specifies that it shall precede the corresponding video record by 9.25 inches, and that the proper audio reproducing characteristic shall be that specified for a magnetic-tape speed of 15 inches per second in Section 2.80, Standard Reproducing Characteristic, of the NAB Recording and Reproducing Standards for Mechanical, Magnetic and Optical Recording and Reproducing (1953).

None of the American National Standards sponsored by the SMPTE and covering sound on motion-picture film is directed specifically toward television usage. However, they are applicable in the television field, since today's television practices are identical to those in the motion-picture field. There are Standards covering the location of the sound record, either optical or magnetic, on Super-8, 16mm, and 35mm motion-picture films. In addition, test films are available for the alignment and testing of sound reproducing systems.

At this time, there is no American National Standard response characteristic for recording and for reproducing sound on 35mm motion-picture film. Work is in progress in the SMPTE on standardizing the conditions under which sound is monitored in dubbing rooms, toward the end that it be reproduced satisfactorily in a typical theatre. This project is being enlarged to take care of the difference between the acoustical conditions in a typical home living room and those in a typical theatre. When this project is completed, we will be able to specify a frequency response characteristic between the film and the ears of a sound director in a dubbing room, such that the quality he hears is the same as the quality heard by the ultimate listener.

In this brief paper, I have been able to mention only the highlights of the SMPTE standardization programs that might be of interest to television broadcasters. I should mention that an index to SMPTE-sponsored American National Standards and Recommended Practices, and a catalog and price list of SMPTE test material is available from the Society's headquarters in New York. In addition, I should say that I welcome your comments and your suggestions on our standardization programs.

JCIC Color Compatibility Progress Report, BTS/VIR Color Signal Field Test Results

K. Blair Benson
Chairman, JCIC Ad Hoc Committee

Frank Davidoff
CBS Television Network
New York, N. Y.

Since its formation a little over two years ago, the Ad Hoc Color Television Study Committee has conducted investigations of the causes of variations in color television reproduction over a broad front, covering every link in the television system chain from picture generation to home reproduction. The enthusiasm and diligence of the Committee members, the Subcommittees, and other standing committees joining in the effort have been most encouraging, as are the results of the various investigations. In this short report I will not be able to cover in detail all of the work of the Ad Hoc Committee and the various subcommittees.

TRANSMISSION

A Transmission Subcommittee was organized in early 1969 under the Chairmanship of Mr. W. C. Morrison of RCA. The charge to the Subcommittee was, "To examine the television system from the output of master control to the antenna terminals of receivers; to determine the origin of significant deviations in color in received pictures; and to report the results to the Ad Hoc Committee."

Data was gathered from test signal transmission in Chicago over three transmitters to eight antennas and tuners, two at each of four different receiving locations. The work of the Subcommittee was reported in detail by Mr. Morrison on September 19 at the IEEE meeting in Washington. The conclusions and recommendations are of major importance and warrant review. They found, with few exceptions, the part of the television system tested was operating within applicable FCC specifications. Despite this, by Committee standards, significant deviations in hue and saturation were measured.

There are two types of system errors which they attempted to evaluate. The first was the system performance as seen by an observer tuned to a single channel. The second was the performance as seen by an observer switching among several channels. In the first case, evidence of errors was found but, with one exception, proper setting of receiver controls would have given satisfactory results. The exception was a progressively larger error in differential gain as the signal approached white level. How to interpret this in terms of viewer satisfaction is not clearly evident. In the second case, there is no doubt that the variations in hue and saturation were excessive. Objectionable variations are permitted within present specifications and practices, and it is to this situation that the Subcommittee's recommendations apply.

Hue. The principle cause of the excessive channel-to-channel hue variation measured was isolated to one transmitter wherein the reference burst was shifted to phase (although within FCC specifications) with respect to color information in the picture. The need to tighten the burst-to-chrominance phase tolerance is clear and is recommended. This task has been taken up by EIA BTS.

Saturation. That saturation (chrominance-to-luminance ratio) errors were excessive is not surprising. The specification on frequency response, by itself, permits excessive station-to-station variations. In addition to this, evidence was found that the prescribed method for measuring frequency response does not give an accurate indication of chrominance-luminance ratio. This shortcoming is ascribed to the

failure to detect significant changes in the luminance signal. Luminance changes result from differential gain errors and from quadrature distortion in RF amplitude detectors, as well as from frequency response errors. The differential gain characteristic, as usually stated, cannot be combined with the frequency response characteristic to yield an actual chrominance-luminance ratio. It appears that the saturation characteristic is not only loosely specified but that saturation variations are concealed by the fact that the actual saturation characteristic is seldom measured.

The saturation situation is further complicated by receivers which use the burst to sense saturation errors. Objectionable variations were found in the burst-to-chrominance ratio in switching from station to station. As was the case with hue, this was principally due to one transmitter with an error in burst amplitude.

It is clear that the specification on characteristics affecting saturation—linearity (differential gain) and frequency response—need to be unified to prevent tolerance build-up. This is recommended. Furthermore, if color burst is to continue as a chrominance amplitude reference for receivers, it is evident that a joint effort with receiver designers is needed to determine the additional tolerances that may be required. This, too, is recommended. In view of the changes measured between the output of the transmitters and the output of our receiving monitors, it is evident that some comprehensive checks of receivers are needed.

Burst Position. The variations in burst position were found to be marginally acceptable. The recommendation in this area concerns the mechanics of the specifications. Compliance with specifications would be more easily ascertained and maintained if the blanking interval specification utilized a burst with the finite rise time which must, in fact, be present.

The findings of the Transmission Committee have been turned over to EIA and IEEE for determination of specifically what is required in the way of tighter tolerances and improved testing procedures. The subsequent work of the EIA in regard to some of the Transmission Committee's findings is reported in the paper by Mr. Davidoff, on behalf of the BTS Committee.

CABLE TELEVISION TRANSMISSION

As a fallout from the Transmission Subcommittee field tests, an examination of CATV systems was conducted by another subcommittee under Mr. Normal Penwell. Mr. Penwell, as you know, is Engineering Director of the NCTA. That Subcommittee's report is complete and presently being reviewed by the Ad Hoc Committee. They have found specific areas of equipment design and in measuring techniques that contribute to color variability. Recommendations are being made for specific action by appropriate EIA and NCTA committees. Some of the highlights of their investigation may be summarized as follows:

First, the wideband portion of a properly designed, installed and operated cable system apparently is not a significant contributor to color nonuniformity. However, if, for example, cutoff filters of the system introduce phase or amplitude errors, color errors can occur on channels at the bandpass limits.

The most likely source of distortion of color signal parameters in a cable system has been identified by the Subcommittee as the single-channel section. Consequently, further laboratory investigations are planned which will cover, among others, the effects of tuning, IF alignment, input signal level changes, AGC operation, and mixer signal injection level variations.

Another apparent problem encountered was that in an alarming number of cases, color performance of receivers connected to a cable system can be improved by overriding the automatic fine tuning circuit by means of the manual tuning control. Sub-

sequent investigation indicated that this was a result of improper maintenance or adjustment of the receiver by service technicians and could be corrected by proper alignment.

Lastly, a major problem found in measuring system color performance is the inadequacy of the RF baseband conversion equipment. This subject, along with the questions of quadrature distortion and chrominance-luminance distortion, is taken up by a subcommittee chaired by Mr. Rhodes of Tektronix in his paper and warrants further investigation.

VIDEO SIGNAL PROCESSING

Mr. R. L. Pointer's Committee of the NAB, studying video signal processing amplifiers, has found this equipment, through improper adjustment, can introduce significant variations in color and, more importantly, improper operation of video tape equipment. This Committee has compiled a very complete and impressive report on their findings which will be turned over to EIA and IEEE for appropriate action, and to equipment manufacturers as a guide for direction in design improvements.

COLORIMETRY STUDY

First, the Colorimetry Subcommittee, under the Chairmanship of Mr. E. P. Bertero of NBC, completed a study of the effect upon picture reproduction by variations in colorimetry component characteristics. Using a relatively complex mathematical model, a computer analysis was conducted of color television system performance, and the resultant degree of reproduction fidelity under varying conditions of scene lighting color temperature, camera signal matrixing, receiver phosphors, and receiver adjustment.

The work of this subcommittee was completed earlier last year and was reported in the April SMPTE Journal by Messrs. DeMarsh and Pinney of Eastman Kodak. The calculations provide data which permit the effect of variations in these component characteristics upon the television picture to be stated in terms of "just noticeable differences"; or in other words, in degree of viewer awareness. The subcommittee has been reconstituted under the SMPTE Television Committee to carry on the work toward development of means for designers and broadcasters to evaluate camera performance. The scope of activity includes a simple and straightforward procedure for operating personnel to assure the day-to-day uniformity of color rendition.

Most recently, the recommendations of the EBU Ad Hoc Committee on Color Television Primaries has been under study by the Subcommittee. The EBU is proposing that the CCIR standardize on new primary characteristics to compensate for present-day receiver phosphor characteristics. Because of the broad implications of the proposal, it has been agreed that the problem should be assigned to a committee representing both broadcasters and receiver manufacturers, and that two steps should be taken, viz: a) Advise U.S. CCIR Preparatory Group 10 as to what position to take in regard to choice of primaries, and b) recommend the characteristics of an ideal reference receiver which can be used as a benchmark of performance for receiver designers and broadcasters. In other words, this will not dictate receiver design; if departures from reference are made, the effect on performance can be evaluated quantitatively.

COLOR MONITOR SET-UP

A subcommittee of the SMPTE Television Committee on Color Monitor Set-Up is developing standard procedures for uniform adjustment of this very important part of the video system. Mr. Grayson Jones is chairing this subcommittee.

OPTIMUM RECEIVER BALANCE

Mr. D. Zwick of Eastman Kodak is conducting an investigation of the effect on viewer satisfaction of different values of white balance for the home receiver. The present practice of the home receiver being balanced to 9000K or higher is not compatible with studio practice and may be a significant factor in accentuating variations in color.

CONCLUSION

In closing, I would like to commend the members of the Ad Hoc Committee, as well as those of the other committees assisting in the study, for their valuable and enthusiastic participation. Their efforts have prompted the initiation of a variety of in-depth studies, covering the full gamut of television system elements; and of equal importance, it has created an increased awareness of the problems by the industry and an impetus toward undertaking appropriate corrective actions. In short, concerted efforts promise to bring about a significant improvement in color quality for the home viewer.

As part of the current industry effort to improve the uniformity of color television program signals, the Broadcast Television Systems Committee of the EIA, under the chairmanship of Mr. Bernard D. Loughlin, is investigating the use of a color reference signal. This vertical interval reference signal (called VIR) is to be combined with the program signal and is a reference for the amplitude and phase characteristics of that program signal. It is planned to insert this signal on line 20 of the vertical blanking interval on one or both fields.

The signal contains a luma reference at 50 IRE units, a black reference at 7.5 IRE units, and a chroma reference of 40 IRE units peak-to-peak superimposed on a pedestal of 70 IRE units. The fundamental reference parameter is the luma reference. The black and chroma reference levels and the sync and burst levels of the program are to be adjusted with respect to the basic luma reference. The structure of the signal is such that the bottom of the chroma reference is at the same level as the luma reference, thus permitting a quick check of relative level. The phase of the chroma reference is adjusted to be the same as that of the burst of the program signal. Subsequent phase differences between chroma reference and burst may be easily observed. The VIR signal may be added to the program at a point where a skilled operator subjectively adjusts his equipment controls to obtain a satisfactory picture. At any further transmission or processing point, the subjectively adjusted picture may be obtained by reestablishing the proper levels and phase in accordance with the color reference signal.

To demonstrate the utility of the proposed vertical interval reference signal, we have prepared a film that illustrates some typical applications of this signal. The first scene shows a typical closeup of a young lady. As we all know, in order to present a pleasing picture on the home receiver, it is very important to maintain flesh tones at the proper hue and saturation. It is normal practice at an appropriate point in the television plant for a skilled operator to adjust equipment to obtain proper luma and chroma levels and burst-to-chroma phase. At this "point of certification," as it is

called, an excellent picture will be obtained. If this picture, as adjusted by a skilled operator, could be maintained or reestablished at any point in the television system, the goal of consistent and quality television pictures would be brought much closer.

An insert added to the picture shows the waveform of the VIR signal. This signal, when added to the program at the point of certification, will serve as a reference for proper levels and phase. When the VIR characteristics are reestablished, the associated program characteristics will also be reestablished. The next insert shows a phase display of the VIR on a vectorscope. Only line 20 is shown. Since the phases and amplitudes of the chroma reference and the color burst are equal, the two vectors are superimposed. If an error in amplitude or phase should develop, the vectors will quickly separate. The insert now shows the introduction of a phase error. The phase error is removed and the vectors are again superimposed. When the operator observes this superposition on the vectorscope, he knows that the chroma amplitude and phase are correct.

Scene II shows a typical television transmission problem where the picture has low chroma level. The picture looks weak and unsatisfactory, and the operator recognizes that a problem exists. However, he has no way of knowing what the proper correction should be. If the subjective judgments of individual operators are relied upon, the resultant pictures will show great variation. Another difficulty which hinders operators is the lack of standardization in the adjustment of their color monitors. If these two factors are taken into account, we can be fairly certain that the "corrected" program will be appreciably different than when it was certified. An insert in the picture shows the VIR signal waveform associated with the program. The chroma reference level is about 6 db lower than normal. The station operator receiving this signal has a precise indication of what the proper correction should be. No subjective judgment is required, and the correction is independent of the status of his color monitor.

If we gradually increase the chroma gain of an amplifier using the VIR as our guide, the chroma reference is restored to the proper level, and at the same time the picture chroma has also been restored. It must be emphasized that by using the VIR as a reference, the program has been restored to the original chroma level without any subjective interpretation by the operator.

Scene III demonstrates the problem that exists when a program signal has the improper color burst phase. This is a situation which can occur frequently in normal operation. It may be the result of an incorrect phase adjustment of the reinserted burst in a stabilizing amplifier. It may occur during playback of a video tape where the reinserted burst phase in the processing amplifier is incorrect. This error, of course, is highly objectionable to the home viewer, since flesh tones become distorted and unpleasant. An operator will immediately recognize that the picture is improper. If he subjectively adjusts the burst phase to improve the picture, he will be relying on both his own judgment and the condition of his color monitor.

The vectorscope shows the chroma reference and the color burst separated by about 20 degrees. This is consistent with the distorted flesh tones. As the burst phase is gradually corrected, the hues of the picture follow the correction of the burst phase. When the chroma reference and burst vector are superimposed, the proper flesh tones have been reestablished. Since the operator has used the VIR as a reference to restore the proper burst phase, no subjective interpretation had to be made.

Following is a report by Mr. Eric Leyton, Chairman of the VIR/BTS Field Test Subcommittee, on the progress of the field tests in the VIR signal to date.

MR. LEYTON (RCA, Princeton, New Jersey): We have been testing the VIR system now for a period of some months. We have had the signal operating over the three networks, and I think we have found no substantial difficulties with it and no reason to believe that it is going to cause any problems. We have a lot of objective data, and the data are at present being analyzed. I am not prepared to talk about that particular part of the data at this time.

However, about two weeks ago in Portland we organized a subjective test of the VIR signal because we thought that in addition to objective measurements we should have some subjective measurements to really find out if it does any good. Let me quickly tell you the arrangement of the test. We originally had five transmitters involved in the test. The VIR signal is a very powerful signal. The night before we did the test, the 1,000-foot tower at one of the stations fell down. Therefore, we used only four stations.

The arrangement of the test was that one station, KOIN, generated pictures which went then on a joyride through the circuits for roughly 1,000 miles and back to the four transmitters. At the receiving unit, located five or six miles from the transmitters, we had four commercial TV receivers ranged side by side and back to back. With those we had four video monitors. The video monitors were driven from stabilizing amplifiers.

Initially, the receivers and monitors were adjusted as nearly as we could make them identical. They were then tuned to the four stations, and we asked the people there to make two kinds of judgments: One was an absolute rating of the picture on each monitor or receiver, and one a comparative rating of A against B, B against C, and C against D. We asked them to rate them as follows: Rating No. 1 was no detectable error, or in the case of the rating between them, no detectable difference. Rating No. 2 was error difficult to detect, or difference. No 3, error easily detectable but not objectionable. No. 4, error or difference on the threshold of objectionability. No. 5, definitely objectionable.

It happened that various things went wrong in the test. It was not rehearsed. Also, everybody knew we were coming, and in the initial stages the pictures were really very good indeed, and I think if all the pictures were as good as those, we wouldn't be fooling around with the signal. Of course, you cannot improve on perfection. However, we do have a set of results. Unfortunately, I didn't have time to get slides made for these results. They came out of the computer only last Thursday. I will try to describe it to you.

We sorted these slides on the basis of the rating before any VIR signal was used. I should say we made three tests of ten slides each. First, we went through ten slides and asked people to do the rating I described, in the normal operating mode of the transmitters. Then we inserted the VIR signal and asked the transmitter operators to adjust it on the first slide and make the applicable transmitter correct according to the VIR signal. We went through the ten-cycle gap. Third, we repeated the ten slides, making adjustments for each slide which we think would simulate automatic equipment.

Altogether we had something over 10,000 ratings to compare, and twenty-five people making judgments. Obviously, the results on the basis that we have them analyzed at the moment are as follows: If the initial rating was 1, which was substantially perfect, the ratings after the readjustment according to the VIR were also 1. With the ratings initially 2, the average after the improvement was $1\frac{1}{2}$. So, the rating was $1\frac{1}{2}$. With an initial rating of 3, the improvement was $1\frac{1}{4}$, and with an initial rating of 4, the improvement was about $2\frac{1}{4}$. It is interesting to note that the curves for the receivers and the monitors and for both tests lie very closely on top of each other,

which leads me to believe that the tests had some validity. I wish to point out that these are very preliminary results, and I am not really sure we have done the proper statistical analysis as yet, but we will do that in the very near future.

Emergency Broadcast System Panel

Moderator: Hon. Robert Wells
Defense Commissioner
Federal Communications Commission

Panelists:

Joseph F. Keating
ABC News, New York, N.Y.

Thomas O'Brien
ABC News, New York, N.Y.

Authur Peck
CBS Radio Network, New York, N.Y.

Harfield Weedin
CBS Radio Network, Los Angeles Calif.

Thomas H. Phelan
NBC TV Network, New York, N.Y.

Howard Schoeffler
AT & T, New York, N.Y.

Gerald B. Trapp
AP, New York, N.Y.

Peter S. Willett
UPI, New York, N.Y.

Lt. Cdr. Max
Stephenson, USN

Lt. Col. Harland E. Priddle, USAF
White House Communications Agency, Washington D.C.

MODERATOR WELLS: I think maybe I can get your attention for a little opener by just saying to you, "This is a test." Members of our panel are:

Peter S. Willett, General Manager, Broadcast Services, United Press International, New York.

Gerald B. Trapp, General Broadcast News Editor, Associated Press, New York, New York.

Howard Schoeffler, Sales Manager - Facilities, American Telephone & Telegraph Company, New York, New York.

Lieutenant Commander Max O. Stephenson, The White House Communications Agency, Washington, D.C.

Thomas H. Phelan, Director of TV Technical Facilities, NBC Television Network, New York, New York.

Arthur Peck, Director of Broadcast Operations, CBS Radio Network, New York, New York.

Thomas A. O'Brien, Vice President and Director of Radio News, American Broadcasting Company, New York, New York.

Joseph F. Keating, Executive Producer, Radio Special Events, ABC News, New York, New York.

Colonel Harland E. Priddle, U.S. Air Force, The White House Communications Agency, Washington, D.C.

I would like to read a telegram addressed to George Bartlett, Vice President for Engineering of NAB:

"Dear Mr. Bartlett:

"As you were aware, Colonel Redman and I had planned to personally attend your EBS Panel meetings on March 29. The effective operation of the EBS has always been a matter of personal concern to me. Unfortunately, travel commitments in support of the President will not permit myself or Colonel Redman to attend the EBS Panel meetings. I have selected Lt. Col. Harland E. Priddle and Lt. Cmdr. Max O. Stephenson of The White House Communications Agency to act as my representatives at your meetings. I have asked, in addition to their normal participation, that specific information regarding the interrelationship of the Office of Telecommunications Policy and my Office be summarily presented. Please extend my regrets to all concerned for being unable to personally attend. With best regards, s/ James D. Hughes, B/Gen, USAF Military Assistant to the President, The White House, Washington, D.C."

So, Jim Hughes and Albert Redman can't be with us, but these gentlemen are just as familiar, probably more so, with the day-to-day operations.

Before we get into the guts of the EBS situation as far as the false alert is concerned, we have a report on a crisis of a different sort, and for that report we have Harfield Weedon, of CBS Radio, Los Angeles.

REMARKS BY HARFIELD WEEDIN
NAB CONVENTION-CHICAGO
MARCH 31, 1971

At 57 seconds past six o'clock on the morning of February 9th, everybody in Los Angeles woke up at the same time—whether they wanted to or not. KNX, the CBS station in Hollywood, abruptly interrupted its all-news format and went rock and roll—literally. At KGIL in the San Fernando Valley, the night man was going off duty and the morning man was coming on. They met in the sound lock just as the building began to shake violently. It was so difficult to stand that both lay down on the sound lock floor. The KGIL newsman was about to enter the building. He tried to continue walking but couldn't move; he had the feeling of trying to stand on the deck of a heavy-rolling ship.

My home is in the San Fernando Valley also. I had the same feeling as that KGIL newsman, except I had it in bed—with my wife. We actively shook, rattled and rolled for about fifteen seconds. My first reaction was the same as that of everyone I've talked to since. I reached over and turned on my transistor radio to affirm that what had just happened to me was an earthquake. It must have been, but I wasn't able to find out. Every station I tuned to had been knocked off the air. So I tuned the dial back to KNX and left the radio on. I knew we had emergency power and that we would be back on the air shortly.

In checking with them later, I found that KFI, KABC, KFWB and most of the other major stations had only a few seconds interruption as they switched to emergency power without incident. KMPC's transmitter is in the San Fernando Valley, so it took them 11 minutes to reactivate the station. KGIL's power did not come back on for 31 minutes. KNX's studios are at Columbia Square in the heart of Hollywood. The building is rigid concrete, built in 1937, and it suffered a lot of damage. All lights were knocked out for approximately 20 seconds until the emergency generators started, turning on key lights. The 50-kilowatt transmitter, located over 25 miles from the studios in Torrance, is automated, and although the transmitter emergency generator started operating, the studio engineer in Hollywood couldn't get it back on the air, so he shifted to the 10-kilowatt auxiliary transmitter and got it operating at 6:07:30 AM; programming resumed at 6:07:55, and back to full power at 7:15.

Master Control for the CBS Radio Network is on the ground floor at Columbia Square and the engineer in charge, Hal Owen, turned out to be one of the news stars of the day. Within one minute after the quake hit, Hal was on the tie-line to New York talking to CBS News. He told them he had lived in Los Angeles all his life and had never experienced anything like the earthquake he had just gone through. Before the CBS News ended at 6:06, the news that Los Angeles had suffered a major earthquake was broadcast to the nation—but not in Los Angeles. KNX was still off the air. But engineer Hal Owen had scored a newsbeat.

At KABC, it wouldn't have made any difference whether ABC had it on their news or not. As soon as the morning newsman collected his senses, he bailed out of the ABC newscast that was on the air and took over, rather shakily, himself. About that time, one of their reporters called in from police headquarters and the big newsday began, as it did for every other radio and television station in Southern California.

It was almost as though all stations had been alerted to stand by for a big story. Morning traffic is thoroughly covered in Los Angeles, so KMPC's Airwatch Helicopter was on the ground just before taking off, as was KABC's. KFI has a fixed wing plane whose pilot is Bruce Wayne and so does KGIL whose pilot is Bruce Payne. Nearly all the stations have mobile units and they were ready to go, or going.

KMPC's Paul Pierce had a mobile unit cruising in the area of the Olive View Hospital. When he arrived and saw the devastation, he immediately jumped out of the mobile unit and started pulling people out of the wreckage. Then he remembered he was a newsman and started phoning in reports.

Television Station KNBC studios are located in not quite downtown Burbank in the Valley and had just started their automated early morning broadcasts when all power went off. One newsman, Dave Horowitz and one copy boy were on duty at the time. Quick-thinking Dave got an engineer and the copy boy and went out to the KNBC mobile unit which had its own self-contained power unit. They were able to go back on the air from the mobile unit with Dave on camera and the copy boy listening to transistor radios tuned to KNX and KFVB, the two all-news stations. As soon as they would report something, the copy boy would write it out and hand it to Dave who broadcast it and duly credited KNX and KFVB as his sources.

KTLA, the Golden West-Gene Autry television station, wasn't due on the air until 9:00 AM, but when the quake hit they went into action and signed on at 7:45. KTLA owns and operates a 120,000 dollar helicopter that is equipped with a quarter of a million dollars worth of electronic equipment. It was developed by chief engineer John Silva and is the only permanently-equipped helicopter in the world capable of transmitting live color pictures. Called a Telecopter, its two-man crew, pilot-reporter Larry Scheer and cameraman-engineer Harold Morby were in the air by 7:30 and on the air by 7:55.

By this time, other helicopters were in the air over the stricken area. Los Angeles City Police have 16 helicopters, and the county and city fire departments also operate a helicopter fleet. The disaster was first discovered and reported by a city fire helicopter. Until that time, no one had realized how tragic the quake was and had thought the damage slight. The KTLA Telecopter stationed itself principally above the Van Norman Dam when they discovered that two-thirds of the concrete apron of the reservoir had collapsed, leaving only an earthen fill to hold back 3 1/2 billion gallons of water. Over 79,000 people in a 12 square mile area were threatened by these billions of gallons of water. The tension mounted as the day went on and those 79,000 people had to be evacuated from their homes. Through it all, KTLA's Telecopter hovered over the dam broadcasting a perfect picture seen by millions of people. Golden West Broadcasters made the picture available to all television stations and to the three networks. At one time, six of the seven Los Angeles TV stations had the same Telecopter picture and sound on the air at the same time. It was a great service.

The really great service, however, was the job done by radio and television reporters in dispensing the information necessary to control a major disaster without panic. There was a minimum of hysteria and a maximum of cooperation between all stations and the police and fire departments.

No area is as prepared to broadcast emergencies as Los Angeles. We've had practice for years with our annual fires, torrential rains, floods, mudslides and the onslaughts of the Pacific Ocean. All served as dress rehearsal for the earthquake which directly affected 400,000 people and was felt by millions. And the broadcast industry came through with flying colors. I think all of us can be proud of the way Los Angeles broadcasting handled the emergency.

Well, the after-quakes went on for weeks, but now, over a month and a half later, most of us have settled down. I saw a sign in our Columbia Square parking lot a few days ago that sort of expresses all our feelings. It was a bumper sticker, and it read, "California I Love You—With All Your Faults."

MODERATOR WELLS: Thank you. It seems for one little earthquake in California we had more stations off the air than we did for the national EBS.

This panel discussion was put on the convention schedule long before February 23. We had already had meetings in my office with industry people about the subject for this discussion. One of our concerns before that date was that not many of you would find time to come here and talk to us. Now, we all know that broadcasters are promotion-minded. I would like to make one thing clear: Even though I was plugging for random tests, it is not true that we arranged for a false alarm to promote our session here today.

In a serious vein, though, the fact that this session was in the works shows that all of us who work with the EBS felt that we needed to take a look at it—and that the NAB Convention provides the only opportunity for us to get together with so many of you for the purpose of shedding a little light on what the EBS is, what you expect of it, and what it expects of you.

Before we get to the questions, I would like to put one thing on the record. Speaking for my fellow Commissioners (and I am sure I speak for the other agencies of government, too), I want to say this: We know that participation in the EBS is voluntary, and that in this activity, as in many others in which broadcasters are participating, you have contributed substantial time, money and effort in this voluntary project. This applies to all levels—the networks, the stations, the common carriers, the wire services, all deserve this recognition. We know that you have given freely of your help and your facilities, and you should be commended for it. Your facilities and your know-how are truly a national resource, and all the EBS is all about is to make a plan for using this resource under conditions we all hope will never happen.

We don't have an Emergency Broadcast System—we have a PLAN for an Emergency Broadcast System. In the event of an emergency, the plan gives us the way to bring the system into being—to put it all together. We have the hardware, we all know that. The problems we have are the old bugaboo people problems.

We had one letter that came to the office suggesting what we should do if stations did not sign off the air, and that was to forcibly sign them off for thirty days. That would leave, out of 8,000, 400 on the air. It would solve the noise pollution level, but I don't know what else.

Here is what I said in a letter to many congressmen: "We do not intend to punish those stations that did not respond properly to the emergency action notification. This would include the vast majority of stations in this country. I would point out the success of the EBS, the primary purpose of which is to permit the President to speak to the people on very short notice in time of emergency, depends upon the voluntary cooperation of all stations. Not all stations are required by the Commission rules to go off the air when EBS is received. Approximately 3,000 of 8,200 stations are authorized by the Commission to stay on the air to broadcast emergency information. Punishment, I think, is not warranted, but a thorough review of the EBS plan and procedures is warranted and is under way." That, maybe, will clear up my feelings on the way it stands.

For an analysis of the survey that we sent to you, may I thank you. We will arrive, I expect, at somewhere close to an 80 per cent return. I truly appreciate your being a big help to us. Joe Keating will give us an analysis of that.

MR. KEATING: This report was released by the Defense Commissioner's Office on March 18. It is the result of an ad hoc group appointed from the National Institute Advisory Committee:

"An Ad Hoc Working Group of the National Industry Advisory Committee (NIAC) was formed by the Defense Commissioner, Federal Communications Commission, on

February 25, 1971 for the purpose of analyzing the responses and reactions of the broadcast industry concerning the Emergency Action Notification (EAN) transmitted in error on February 20, 1971 and its effect on the Emergency Broadcast System plans and procedures.

"The analysis of questionnaires by stations in response to the Defense Commissioner's February 22, 1971 request reveals a pattern of reactions which, taken together, prevented the spurious teletype message from triggering the complete nationwide system at all levels.

"All 6,249 respondents were asked if they knew what they were supposed to do; only 233 stations—3.7 per cent of the total—stated they did not know what to do on receipt of the Emergency Action Notification.

"Stations cited a number of reasons for taking no action. In reply to the question: "What action did you take? If you took no action, give your reasons," the following were the most commonly cited reasons (totals exceeded 100% due to multiple answers):

1. Received no confirmation of EAN through monitoring of assigned Key Station (36.8%).
2. Received message on AP or UPI Radio Wire advising that EAN was sent in error (30.8%).
3. Doubted validity of EAN message (28.0%).
4. Coincided with time of regularly scheduled test message (20.8%).
5. AP-UPI message not seen until after cancellation (14.0%).
6. Network affiliates monitored National Programming channels, heard normal programming since Network EBS not activated (13.0%).

"815 stations reported that the EAN was not received; 604 of these could not have received the message because they do not have AP or UPI Radio Wires.

"In the questionnaires many stations included remarks or recommendations which have been turned over to the NIAC Working Group currently studying the EBS Plan and procedures. The final recommendations of the industry group will be submitted to the FCC for transmittal to the White House and other interested parties."

MODERATOR WELLS: In the telegram read from General Hughes, there was a statement, "In addition to their normal participation, specific information regarding the interrelationship of the Office of Telecommunications Policy and my Office be summarily presented." For that and for any other remarks, I would like to introduce Colonel Priddle.

COLONEL PRIDDLE: I would like to add, in addition to the comments read to you in the telegram, General Hughes' personal thanks based upon the voluntary participation and gracious help which you all as industry people have been giving us in the past.

I would like to discuss, for just a few moments, the role of the military assistant to the President and how he feels regarding his position in EBS. As EBS is used, it obviously becomes presidential communications. Looking to that end, we must decide ahead, not after the fact, what our basic EBS requirements are.

We have undertaken a review of the requirements as they used to exist, and we passed these to Bureau chiefs in Washington on March 16 of this year. The Bureau

chiefs are collecting comments from their respective networks today with the deadline for that input. We will then get together with the Bureau chiefs again and discuss if we, the White House, are basically on the right track as far as requirements in the EBS area. We feel this is extremely important, since this is the starting point if we are to have a basic system which will be responsive and which will be effective in the case it requires that. The Office of Telecommunications for the President will manage details and work with the FCC, and so on, in making sure that all the little nuts and bolts are pulled together.

Basically, our job in the Military Assistance Office and acting for the White House will be to reflect basic requirements. To this end we also will deal as we have in the past directly with the Bureau chiefs such as Small, Lindsey and Jordan, in making sure that there is an understanding of these requirements.

In closing, I might add that there is a little philosophical thing we might state. Although we don't like to do it sometimes, it goes like this: "Sometimes lessons well learned by mistake are lessons well learned."

MODERATOR WELLS: Lest you begin to think EBS is a governmental project, I would like to say that I truly accept the recommendations of the industry people. The working relationship between our Office and the men in the White House is very good, but basically EBS is part of the broadcast system, and what we do or don't do is partly yours; so I think it is up to you, as they have been doing, to help us out with your efforts. Joe Keating has consented to take over on this now.

MR. KEATING: I think we would like to open up the questions from the floor. We will try to answer them, assuming we are going to get some.

VOICE: Our station happens to be the only 24-hour station in the State of Vermont. It is a primary station but we don't have emergency facilities provided by the government. Anyway, we received the warning, but the announcers on duty did not notice it until after the bulletin had come through. I feel badly that we didn't do our part, even though it turned out to be not so bad.

Fifteen or nineteen minutes went by with that sitting on the wire. To me that is about the normal span, unless you have a fully manned news staff that would be looking at the wire services. We have a CBS Net Alert which we probably would depend on even more because that is instantaneous throughout the program.

What I would like to see is a piece of equipment the station would buy for bulletin information, such as the CBS Net Alert and the other. It hasn't anything to do with the actual teletype itself.

MR. KEATING: The question, in general, if I can summarize the key point, is whether it is possible to have your wire service message on EAN trigger some kind of external alarm.

MR. TRAPP: No. When stations subscribe to UPI we have tried to encourage them to buy the contact points. There are contact points available to attach to the teletype machine on which you can rig up your own alarm system—light, bell, whatever you want—and they are available from both AP and UPI. The contacts cost \$25, I believe. It is a one-time charge. If you want the whole system it runs about \$75.

MR. KEATING: Does AP or UPI manufacture this device itself, or do they have to get it elsewhere?

MR. TRAPP: We do not manufacture it.

MR. WILLETT: We don't either, but there is one firm, B & I Electronics, located in Greenville, South Carolina, Post Office Box 8653, Station A. The zip code is 29604. There is one manufacturer who produces a bulletin trip system. What this is, is that you can set it to go off on a certain number of bells on either AP or UPI wires, and I would suggest if you are going to use it just for EAN messages you probably set it at eight bells, giving yourself a little bit of leeway. In that way, it

won't go off on bulletins or messages but will go off only on the EAN Alert, which is ten bells. This unit runs \$64.50, and I believe there is another manufacturer that is making a similar unit.

MR. KEATING: To add to that, the wire services shortly will move, as an advisory, this information on the fact that contacts can be put on the machine and that there are outfits that will sell you such a device; or you can even build your own. Also, the networks will provide a closed circuit to pass this situation along the lines so you can get it more broadly disseminated.

MR. WILLETT: We also have a schematic which will be available to anyone who wants to build their own bulletin trip.

VOICE: What precautions have been taken to prevent a repetition of Murphy's Law here at the originating point?

MR. PHELAN: As you probably know, at the moment we have an interim system which involves a relay of the message from the "mountain," which is checked out by the wire services and verified through the White House. This is not the ultimate system, and the White House, together with the FCC and the industry, is studying additional means of authentication, so this grabbing the wrong tape hopefully will be a thing of the past.

VOICE: On February 22, two days after the false alarm, I had a visit from an FCC Field Inspector who immediately proceeded to ask for my logs of that Saturday, which I furnished, and he signed a receipt for them and removed them to New York. My station did not go off the air for reasons that we had not received the verification list at that time. It was late, and the key station had not triggered our EBS receiver. I am still a little bit concerned. I would like to know when there will be an official statement by the Commission as to the status of those stations that did not leave the air.

MR. KEATING: I think Commissioner Wells did cover that point in his earlier remarks when he stated that the responses to the questionnaire were to be informative, and it was not anticipated that any punitive action would be taken against stations for what they did or didn't do.

MODERATOR WELLS: That's right.

VOICE: I would like to know if they have made any provisions for notifying foreign language speaking people in the large metropolitan areas like New York and Chicago of what the EBS is all about when a national alert does occur.

MR. O'BRIEN: In the actual EBS plan, which all stations should have on file, there is a standby script which, in the case of foreign language stations, would be translated into the language of the audience that is listening to that program.

VOICE: I would like to sort of reverse the trend of the thinking here. It seems to me that everybody is saying the broadcasters made a big mistake and that they should be punished, and that they goofed. I feel myself there was enough doubt, having only one source giving the messages, that the broadcasting industry really served the country far better by doing what it did than by causing a national alert which might have created panic in many areas.

I think the broadcasters should be applauded for using their common sense and making sure that this was a real alert before anything was done, rather than the note that seems to be going through the entire country, that we made a mistake. I think we did the right thing. We found only one source was in error, and we didn't cause a panic.

MR. KEATING: I don't think any broadcasters up here will disagree with that.

MR. WILLETT: The ad hoc committee that made the analysis came to the same conclusion in their report.

MR. KEATING: In fact, the opening lead in our report was that there were a series of things that prevented chaos and panic by virtue of the fact that common sense did

prevail. On the other hand, we do have to take a serious look at the fact that things that were supposed to happen didn't happen.

VOICE: Does the committee feel that if a future message comes along it would have to agree 100 per cent with the sample message that we are supposed to match them with? This was not received in its entirety in some cases. I am just wondering if in the future we shall actually follow word for word, or does somebody interpret how much you have to get.

MR. KEATING: You mean you did not get the entire text as shown on the yellow card?

VOICE: The end of the ten-bell signal, and the daytime, and such.

MR. PECK: I think the point is very well taken. I think you should depend on the entire message including the ten bells, and I think in the interim plan, where any such message would be relayed by AP/UPI, their personnel would understand this and this might become part of the original authentication.

VOICE: Bells are not going to solve this problem. We have the technology which will allow us to transmit direct from the White House through our stations to home receivers. With proper coding, those transmitters can be turned on or off and a message broadcast at will.

MR. PHELAN: What the gentleman is talking about is not a voluntary system. He is talking about a case system, and I am sure the technology exists not only within the industry but within the government. As Commissioner Wells and the gentlemen from the White House have stated, that is not the basic requirement of the system. I think as such nobody has been working toward that end.

I believe we can do one thing to help this people problem. We are still going to have people in it, and we hope to keep people in it because if we do there is always a chance for all of us. We are going to try to simplify things. We found out in reading the messages, and so on, that came in, one thing we can say is going to happen in July of this year, and that is that we are going to have authentication lists and instruction cards that at least agree in color, so people will not have to be looking for crazy names on the list, and they can go merely by color.

Everything that is printed on the card will also be printed on the envelope, so this is going to make it simpler in general for people at the news desk or master control or wherever it might be. In line with that, we are going to continue and hopefully some day in the not-too-far-distant future I will guess that as far as operations go, the whole plan can be put on one or two cards.

CHAIRMAN WELLS: Half a system is better than no system at all. We can have a complete system or none. What good is a voluntary system that doesn't work?

COMDR. STEPHENSON: Perhaps in the original plan it is pretty specific in the White House statement of requirements that I am not sure you are familiar with. It says:

"The non-government communications industry will, in view of their expressed and demonstrated willingness to assist the Federal Government in the establishment of an Emergency Broadcast System, unreservedly make their facilities available for emergency use.

"Existing facilities of the non-government communications industry will, if utilized to the maximum advantage, prove adequate for emergency presidential use. Because of the substantial number of facilities available, bypass and backup arrangements can be provided in such depth as to assure a high probability of survival despite the infliction of severe damage to the system as a whole.

"In view of the fact that appreciable costs would accrue to the Federal Government for the construction of special radio and television stations designed for use on non-

government frequencies, and because of problems inherent in the operation of such stations and the limited day-to-day application of such facilities, it is desirable that existing privately-owned facilities be utilized by the President in communicating with the populace."

VOICE: What happened to the EBS two-tone system that was to be developed as more foolproof and didn't rely on fading of the signals, and so on? Is the radio system going to be absolute or is it still going to be continued?

MR PECK: I think we have apples and oranges here. The two-tone system could conceivably replace the third method and it could also alert receivers in the homes, that is true; but that isn't what we are talking about. We are talking about how we get the message to the station to go into emergency action notification mode and send out that fourth method, that two-tone system. Really, that is the end of the line, not the beginning of the line. We are trying to solve the problem between the mountain and the transmitter and the operator who then would have to push the button at that individual transmitter.

I might say that if you are talking about alerting stations by off-the-air communications from, say, a long-wave transmitter as has been suggested in many cases, you are also running into a lack of redundancy in that people have pointed out it is much easier to knock off one super-power station somewhere than it is to knock off some 6,000 or 8,000 AP/UPI drops.

VOICE: It appears in the instance of a false alarm, most stations like to confirm the warning by all means available as to whether or not it is legitimate. Do you feel it is good policy to always confirm an alert from one source or another before you take any action?

MR. KEATING: Yes, after studying these replies and also studying the present-day contemporary picture here, we do feel that there is a need for a kind of additional credibility authentication, and something along that line is now being thought about as to how we give you another way, possibly not exactly the way it is now, but some means for your operators to be able to double-check.

COMDR. STEPHENSON: That is true. Recently we in the White House originally forwarded to the Office of Telecommunications and we have been investigating several different methods that might serve this function, trying to make a determination of which is the most feasible from both an economical standpoint and from the standpoint of being able to reach most people and to supply them with some means of authenticating over and above what they have had in the past, so that they really and truly believe what they see or hear. Something to substantiate the message before them, either that it is a test or an alert. Recently we forwarded to the Office of Telecommunications what we think is at least a method that warrants further investigation, and we know they will be investigating it.

VOICE: Is it possible that this will become policy?

COMDR. STEPHENSON: It is entirely possible. I can't say it will be, but it is possible.

VOICE: What is the purpose of an individual code word by the date? Why can't there be one code word set up, such as SOS, or MayDay, to be used to authenticate this thing? These lists are in something like 8,000 stations across the country. Why couldn't the one word be set up for a description of the official alert?

What I said about a piece of equipment—sure, we have the EBS on a voluntary basis as it has been, and have the information come over existing AP/UPI network stations, but a piece of equipment that the station buys. I think every broadcaster would be willing to put out a couple hundred dollars when you are talking about a plant in excess of \$75,000 or \$100,000 worth of equipment that would recognize this code word inde-

pendent of the teletype and set off an alarm. In other words, have one code word to initiate the EBS system.

MR. KEATING: You are talking about another approach to authentication—a word. This is something broadcasters aren't qualified to discuss but the military people are.

COL. PRIDDLE: I think there is some degree of compromise that is easier when you have a single word. I think you would have to accept this because of the 8,000 people who are going to know the word. Granted that this possibly may be triggered by an automatic device—in other words, following what you are talking about. I think, in summary, this is just a part of the type of authentication that we are now probing further to, maybe in some way, automatically authenticate for you. But there is some danger in a single word, because we have trouble enough trying to keep it sealed and everything else, and trying to change it every day. It will be spooked easier if you have a single word.

MR. KEATING: We might add that it isn't only a matter of a one-word key. It's also the message which follows on; and we have two messages here to tell the station what to do, EAN 1 and EAN 2. Within the networks there is another mode of alerting, and right now we have about sixty-six different origination points.

MR. PECK: I think there is a point that could be made, and maybe it is a misunderstanding. No one in the White House Communications Agency nor the networks feels that everything is fail-safe about this method or any other method. All we can do is put in as many roadblocks as possible to try to eliminate the pulling of the reel of tape off the hook where it shouldn't have been in the first place.

Many of these steps that we are taking are to make people think, to cause a definite action and reaction to go on to the next step, and a code word is certainly not a secret. It can be read by anyone who knows where it is sealed or hanging, but it is a step which has to be taken with the networks and stations, and gives you a chance to think if everything is right. Just one little piece that can be cut out.

For example, at CBS we can't send a net alert 8 or 9 on our transmitter without the man physically pulling out the plug that is there to block the circuit. That doesn't mean anybody can't do it if his mind is set to it, but it does mean he can't stick his finger in dial hole 8 or 9 by accident. He has got to think and make a positive action. Many of these things are designed with that in mind, to make a positive action to help everybody think all along the line.

VOICE: I think the basic problem is still alerting the stations. I would like to see a system entirely apart from the bulletins which come down the wires, possibly a tone that activates a special relay apart from the bulletin so you will know it is something different.

MR. PHELAN: We agree with you. We ask for a number of bells, but it gets complicated with their flash bulletins and things of that sort. I know that both AP and UPI have been bugged in the last couple of weeks on that score, and maybe they will be able to come up with something in this new procedure which will eliminate that problem.

VOICE: We have pretty well discussed the problem of the human factor. What is the status of the two-tone receiver? That was proposed at one time. Speaking from a television station point of view, we have a lot of trouble with 15-kHz hash getting into our receiver. We have to be careful where it is located so it works properly. We would love to see something besides carrier break as far as off-air monitoring. We do not use a monitor at the present time. Could we have a brief status report on that receiver?

MR. PHELAN: There were investigations made by the industry and by the Commission, and reports have been prepared but have not, as far as I know, been

formally acted on by the Commission. This requires concurrence of a lot of other agencies, and also requires some concurrence from the people who eventually make receivers and equipment, to make certain that this will not be a device which will cost a fortune and which will prevent it from getting into widespread public use.

I don't think there is anybody here who can give you a definite statement as to where this stands at the moment; but we are with you, and we want to see the old Conelrad carrier break system go. Looking over a lot of the suggestions that came in, it might be well if you would put out a note to your news people and other people in the station that Conelrad died a long time ago. We still get things back cancelling the Conelrad message. If we could forget Conelrad we might have made one step forward in the last ten or fifteen years.

MR. PECK: If we went into the two-tone method, every station that wanted to be part of this voluntary action would then have to buy a transmitter to send those tones, and to start out with it is a fairly expensive piece of equipment. The latest thing that has been going on has been trying to check tolerances of cartridges as to whether they could be used as the transmission for the two tones in a very simple manner in any station and still have the receiver closed down enough on the receiving gate so that false signals would not creep in. That is one of the latest problems being considered.

MR. PHELAN: I am sure a lot of television stations have been wondering whether they are going to get into the act. I know some of you are in the act now, acting as relay stations or parts of the country where AM doesn't have adequate coverage. The White House Statement of Requirements as they are being promulgated shortly requests that we provide pictures along with sound, so that you might say the EBS is now coming of age. I think the President realized that the old Chinese proverb of a picture being better than a thousand words is correct.

MODERATOR WELLS: Just about a minute to comment on one thing about taking our hats off to the broadcasting industry for not creating havoc that morning, and taking credit for great thinking. I am a broadcaster, too, and I would like to say that in all fairness I think a lot of our skill in not going off the air was done because a great many of the stations didn't see the alert light cancelled. We can hardly take credit for that.

However, I would like to mention one thing. One of the men on the panel hasn't said a word. He travels on the theory that he never learns much while he is talking. He does listen well. May I say that one of the most learned men up here is the AT&T representative who takes care of all the switching. Howard, I hope you enjoyed the trip. You sure were quiet.

Again I would like to thank not only the members of this panel for the work they have done in the past, but I don't think any of you realize how much time, effort and money these men put in, and how much money their companies spend on a strictly voluntary product. As a broadcaster and Commissioner I appreciate it. We go through all this fine detail, and if we ever got a PA system to work, we could solve the EBS problem.

Operational & Economic Considerations of the Aural STL

John A. Moseley

President, Mosely Associates Inc., Goleta, Calif.

One day, during December, 1968, the Dow Jones Industrial Average closed at 98. It went over 1000 on an inter-trading basis but it closed at 98. However, from that day on, to May 28th of 1970, there was a very amazing decline, down to the point where the Dow Jones tipped to 6-31—a significant drop. This drop also included the so-called Blue Chip Stocks, but, fortunately, all of them did not participate in this decline.

To most people, this economic condition was surely a recession and, of course, to certain aerospace workers, particularly in the state of Washington, it was a disaster. Fortunately, however, the economy has leveled off and has regained a great deal of strength and this morning (3/30/71), or yesterday, the Dow Jones Average closed at 9-0-3.

However, the last 15 months has been a very interesting period for most radio managers and owners in that it is forcing them to closely examine their operating costs in relation to their individual stations. In some instances, new capital expenditures have been involved. Fortunately for the manufacturers, these were made in an effort to obtain lower daily and monthly operating costs and here is where you as broadcast engineers can help your managements, being a part of the management team rather than being a fellow in the back room where he has a workbench at his back. You can do this, in fact, by making recommendations which will reduce costs without sacrificing the technical standards of your operations.

I have a copy (12 pages, from pages 89 to 112) of a portion of the FCC tariff #260 filed by AT&T on just the series #6000 telephone lines. The series #6000, as most of you know, are those devoted to your program circuits. This is a rather lengthy document and a very confusing document for those of you who might have read it. It is likewise confusing to me, but, on the other hand, last September 1st this tariff went into effect, or a similar tariff from other changes went into effect across the country, thus bringing into sharp focus the high cost of wire facilities.

Obviously, the manager would like to reduce these monthly operating costs, so with this as a preface, I would like to discuss the aural STL and how it can help reduce operating costs in your station and, at the same time, help to improve quality.

To begin with, this will not be a typically deep subject. I would like to cover this in a broad range, quickly describing the system in a few moments that I have. I'll begin by discussing some of the questions which are frequently asked about the STL. Of course, they range from very simply who can use the STL as to, for example, the area of equipment that is needed to properly maintain and operate an STL system. This is obviously going to be limited to those people who are now using leased lines.

As a manufacturer, I would like to talk about STL as a means of going from one room to the next, but normally it is required for people using leased lines. These are the people who are open for STL.

Inter city relay service is another way to reduce operating costs. This is especially true in the prairie and mountain states, where network line costs are running over \$400 to \$600 per month for a rather inferior system.

TD aural stations presently use STL frequencies or STL bands. However, you should be aware that this is a current matter before the Commission, in relation to

which they are considering removing the television stations from the present 947- to 950-MHz band, leaving more space available for AM and FM broadcasters. Section 74.532 covers the licensing requirements. Here again, only the station can become a licensee of STL.

Early in the game, in 1960, customers purchased and received a license in relation to installing STL for direct background music. In other words, when a customer received his license, he in effect received notice from the Commission that they had erred in this matter and had revoked his license because it was not for carrying program service. Therefore, STL must be used primarily for program service.

Of course, there are ways of getting around this. If you have a requirement for control and metering functions by establishing auxiliary studios, it still must be used for program service. Any class of licensee must be on duty or operator must be on duty at the place the STL is installed.

Logging is very simple—hours of operation, program frequency check and any other pertinent data relating to the operation of the STL. These must likewise be kept for a period of two years.

We are also often asked, "What can I do with STL?" Obviously, programs, both from monaural and stereo operations are involved. In the area of saving money, the practice of using only one STL to relay a composite stereo signal to your remote transmitter site obviously saves the cost of an additional STL. When used in the proper configuration, one STL can carry the whole package to the transmitter. You can also use STL for remote control subcarriers, for wire lines and for other operational circuits relating to your station.

In making a decision on an STL, any matter involving engineering and the station management team, you are facing a decision of what to do with this. Now, I have found a process that is appealing to many engineers because it is sort of related to a formula. It involves steps A, B and C, and as you go along, it isolates the steps from one another and, when this happens, I feel you are in pretty good shape.

These steps are, very simply, to first define what the objectives are that you are trying to accomplish. Then you turn your mind to other problems, other areas, one of which, for example, is defining the problems that you are going to have in relation to meeting these objectives. Then, once you have the problems listed, then you turn that switch off and get on your other section of the line, which tells you how to solve these problems.

One is in dollar costs. Once you have the objectives, the problems and the costs separated as individual items, then it is up to you to apply the formula, a very simple formula. That is, you carry the objectives to the cost or equate those two together. You do not equate the objectives to the problems. People who equate the objectives to the problems are problem-oriented people. People who equate the objects to the cost to solve the problems are object-oriented people.

I think that object-oriented people are the best ones to make a decision for management and so you as engineers can be most helpful to management by doing a simple procedure like that.

Now, let's summarize some of the common objectives you might want to list for the aural STL. The first has to do with a reduction in operating costs. Of course, we discussed that earlier. Some of the people who have talked to us have had telephone company increases of 500 per cent. I have heard of only one station that had a decrease. The average is between 200 to 300 per cent, at least as of last September.

Another objective of STL would be higher reliability. Better performance would be a third objective. The fourth objective, fortunately for me is well illustrated today by an article on the rear page of the Wall Street Journal. Those of you staying at the

Hilton Hotel had a copy laid outside of your doors. The article I have reference to is on the back page. The article is entitled "Move Over Mabel."

Now, what is the worst telephone company in the United States? Of course, some people will vote, especially those from California, for General Telephone. Therefore, another objective you might consider in relation to STL is to eliminate the association with the telephone company.

A proper STL system, in my opinion, will certainly out-perform telephone company service. It is, for example, under your complete control and the article I previously mentioned refers to this, especially in relation to service. Therefore, this does have some advantage. Further, it does imply responsibility for you to maintain the operation of the STL.

Now, let's talk about some of the problems you are going to be faced with in the decision-making process. Some of you will be specifying system configuration. This means, do you want to transmit in mono or stereo, SCA, etc.? Do you desire remote control? What kind of remote control do you have or do you desire?

There are many variations of these three basic areas in relation to specifying a configuration. However, I think they can be interwoven in order to come up with a variety of systems tailored to meet your own requirements. You also would be considering particular problems in relation to installation of an STL.

Another problem that you will want to assign cost to or figure into your plan is the installation and training of your personnel—the operation and maintenance of the equipment. Finally, you have the problem of testing this equipment.

All of these problems can be solved, even where you have a big mountain in front of you blocking the path. That can be solved, for example, by a 5-loop system, in which case, when you equate the cost to the object, it is not worth it. Perhaps here you can go around with telephone company lines.

Now, let's consider a few of the problems in the context of this presentation. For example, in considering a system configuration, you have a frequency selection problem. Unfortunately, the Commission's record on frequency assignment in a given area is rather out of date. It is computerized and should be on time. It doesn't take into account new applications and your local RI or field office has these on file. In fact, they are a good starting point. Nevertheless, it is a good idea to check with your local engineers in order to find out who is on the other channels and if there are any other applications pending.

Further, you will need some coordination in the boundaries of the United States. I think you should, in the different areas, consult with your consulting engineer on these types of problems, especially if there are any profile concerns which you are interested in.

Likewise, the actual configuration of the equipment is very important. As mentioned earlier, there are configurations for AM and FM remote control without the use of any wire-line facility. The systems are basically similar; that is, the STL can convey all program material; that is, mono or stereo and SCA program, and it can also convey remote control tones to operate the transmitter. Further, the metering can be returned to the studio via the recently subaudible tones operating at the 20- to 30-Hz range, without exceeding six per cent modulation. We have a 50-kilowatt operating station in California which uses three per cent modulation. Therefore, it doesn't effect the program content. In the case of FM, the use of subcarriers for return of metering information is available. This metering system does not conflict with the use of that subcarrier for SCA program service. Therefore, the income-producing revenue that the SCA provides is not lost.

In relation to the path evaluations under consideration, you will have many things to consider, such as reflection, refraction, zone clearance (if you have any obstacles in front of you), and then, of course, you will likewise have antenna considerations to discuss. There is also the factor of the length of transmission lines. Here again the consultant can be of great help, although, of course, your NAB Engineering Manual likewise is full of ideas on this. Therefore, as an engineer, it is not difficult for you to come up with some preliminary engineering study.

When you receive the equipment, the installation is the key. It should be neat. Again, in my opinion, I have seen many stations, and unfortunately too many of them, that are very difficult to service when you do have trouble.

Another important "must" in a system of this nature, in relation to operational considerations, is initial back-to-back tests. In this case you want to make frequency response (SNR) checks, but most important is that when you get this equipment it should work. I will not say, of course, it will work. However, if you abuse the system in relation to a program nature, if you overload it and overdrive it, for example, see where the equipment folds up, this will, in turn, determine how much headroom you have and then, depending upon your operation, you can operate the STL accordingly. Further, the equipment should have a good maintenance schedule.

One of the things, when you do have a problem with an STL, is to understand the signal flow in the equipment. Therefore, if you have problems, you can say the signal is good from point A to point B, but from B to C something is happening, and these are the points that you have to follow from the beginning to the end. It is just like in servicing a radio. Then, in relation to this information, if you are seeking help from the manufacturer, you can advise him because he, after all, does not have a crystal ball, though very often I think we are accused of having one.

With regard to test equipment, you certainly cannot do this with a Simpson #260. We have many people who have asked us about this. A good audio-generator and a distortion meter are very good. Also, you can have a power output meter, but this I do not think is too necessary. It is very frustrating without the necessary test equipment. Therefore, these problems do occur and you do want to evaluate the project. You also want to find out what this is going to cost. In other words, the test equipment which you think you should have is going to cost you X number of dollars.

You also have the problem of installing antennas. In other words, you add all this up and equate it to operating costs and then, in turn, can you make a presentation to your management and indicate to them that you do or do not need the STL; that is, you either can or cannot justify it. When you have done this, then I think that you as engineers will have served your management best by analyzing the problem and making a recommendation as to whether or not the aural STL should be used.

Stereo & SCA Compatibility Considerations

Moderator:

James C. Wulliman
WTMJ AM-FM-TV

Panelists:

Carl G. Eilers
Zenith Radio Corp., Chicago, Ill.

Howard M. Ham
Moseley Associates, Inc., Goleta, Calif.

Leonard E. Hedlund
McMartin Industries, Inc., Omaha, Nebr.

A.S. Jarratt
Radio Corporation of America, Camden, N.J.

Harold L. Kassens
Rules & Standards Division, FCC

MODERATOR WULLIMAN: In opening this panel, let me first make a couple of remarks as to why I am here. A number of people who saw that I was going to be on the panel asked me if I was going to deliver a paper. I said, "No, I am going to point like Ed Sullivan." Now, I do not have the knowledge these gentlemen do, but this situation did happen to us—in other words, we began about a year ago operating an SCA on a station that had been running stereo from the time it was approved. A few days after we put the signal on the air we began receiving mail asking, "What did you do to the best stereo signal in town?"

Well, the upshot of this was that several of us began to make trips to hi-fi stores and one of the things that happened to me the first day out as I walked into one of the stores would give you an idea of why we felt that it might be worthwhile to discuss the problem. After I had introduced myself to the manager, he said, "You like to hear that whistle on FM, don't you?" Well, that did shake me up just a little bit.

Another comment that we received from a listener was "Don't you care any more?" Such comments will shake you up a little bit because, after all, we do care. Well, we suggested that perhaps this whole problem should be discussed at an NAB meeting. Of course, we will not define it as a problem today because it has many, many facets.

At this point, I would like to call on Mr. Jarratt, of the Radio Corporation of America, to give you a bit of overview on what the extreme framework of this is and then we will hope to have time for questions a little later on.

MR. JARRATT: First of all, I would like to mention that there are going to be a few individuals here this morning to whom we will be doing a disservice. The salesmen in your area, for example, were probably not aware of this problem until you acquainted them with it.

The basic problem that we are talking about is that of the intermodulation product better known as the "birdies." These "birdies" are the result of a general lack of linearity somewhere in the total system.

The total system includes the exciter, stereo generator, transmitter, transmission line, antenna, signal propagation, receiving antenna and transmission line and the receiving antenna itself and, of course, the transmission line on the receiving antenna. All of these points, in fact, can introduce the "birdies."

This reminds me of the old saying in real estate, "What determines the price of real estate?" Well, there are three things that determine it and that is location, location and location. In this case, it is linearity, linearity and linearity.

In order to reduce these birdies, you are in a situation where you have to be sure that everything in the transmitting end is linear. Check all of the points I have mentioned.

For those not familiar with exactly how this is happening, let me explain that any nonlinear circuit will produce a third harmonic of the 19-kHz pilot at 57 kHz which will beat with the 67-kHz subcarrier and produce a 10-kHz birdie. Any 76-kHz component will beat with the 67-kHz subcarrier and produce the same effect.

MODERATOR WULLIMAN: Next I would like to introduce Mr. Leonard Hedlund of McMartin Industries who has, within the past few weeks, conducted some test relating directly to this discussion.

MR. HEDLUND: In relation to this problem, a test setup was used to measure SCA interference into the stereo channel of a stereo monitor. The equipment used for the test included a stereo generator, an SCA generator, a TBM-4500A stereo monitor and a TBM-2000A SCA monitor. The composite or baseband output signal was monitored at all times with a Hewlett Packard 180A oscilloscope.

The 19-kHz pilot (with distortion of less than one per cent) was injected into the system at a level of 10 per cent modulation verified by the stereo monitor. A ref-

erence level of 1 centimeter was established on the oscilloscope. The right channel was modulated 90 per cent with a 400-Hz signal and verified by the monitor. A Hewlett Packard model 33A distortion analyzer was connected to the audio output of the monitor and a reference level was established at zero db. The 400-Hz modulation was then removed.

The FM SNR measured with the audio analyzer was 68 db below the established reference level. The built-in peak voltmeter in the monitor measured -69 db. The pilot was temporarily removed and the SNR remained the same, thus producing no interference.

An unmodulated 67-kHz SCA carrier was injected at a level of 10 per cent as verified by the Hewlett Packard scope, the amplitude of which was now 2 cm. The total modulation meter reading of the stereo monitor indicated 19.8 per cent. This slight error (0.2 per cent) is inherent in the monitor when reading the addition of the 19- and 67-kHz carriers. The TBM-2000A SCA monitor meter read exactly 10 per cent SCA injection.

The signal-to-noise now measured -65 db on the Hewlett Packard Analyzer and -66 db on the internal voltmeter of the monitor. Removing the SCA carrier dropped the reading to the original -68 db. The output of the audio analyzer was monitored with another scope and a carrier was barely visible in the noise, indicating a slight amount of intermodulation of the 19-kHz components and the 67-kHz SCA carrier; however, it increased the noise by only 3 db.

The SCA generator was modulated with the following audio frequencies and the signal-to-noise ratio of the stereo monitor indicated the amount of intermodulation occurred in the right audio channel. The deviation of the SCA channel was maintained at plus 6 kHz.

As you will notice, frequencies above 6000 Hz start producing noticeable SCA interference in the stereo channel; 7000 and 8000 Hz were objectionable. The deviation of the SCA channel was reduced to plus 4 kHz. Frequencies up to 6000 Hz produced a figure of 64 db and was barely inaudible.

Music program material was fed into the SCA generator at a peak level of plus or minus 6 kHz and noticeable whistles and swishing sounds were heard in the output of the stereo monitor. The response of the Hewlett Packard distortion meter and the internal voltmeter of the monitor is too slow to give an accurate indication of the actual signal-to-noise ratio or intermodulation, as the readings were averaging around -58 db below reference level. The right and left channel readings were identical. The level of the program material was reduced to plus or minus 4 kHz deviation and the SCA interference diminished greatly but was still audible.

A 5-kHz low-pass filter was inserted in the audio line feeding the SCA generator, removing the higher harmonics and no audible SCA interference was noted in the audio output of the stereo monitor. The audio analyzer indicated a constant SNR of -65 db under these conditions. This test utilizing program material is more meaningful than the sine-wave test which had low harmonic content. Program material is nonsinusoidal, with a lot of harmonics and the higher harmonics above 5 kHz must be removed.

Another test was conducted to verify the effect of distorting the transmitted 19-kHz pilot carrier. The 19-kHz pilot was purposely distorted to 6.5 per cent and produced predominantly third harmonic distortion (57 kHz). This was injected at 10 per cent under the same conditions as previously described. The FM SNR measured again was -68 db below reference level.

An unmodulated 67-kHz SCA carrier was injected at 10 per cent. The FM SNR and intermodulation products now read only -57 db below the reference level. The output of the analyzer was viewed on the scope and the carrier frequency of the new signal was amplified and measured with a frequency counter as 10 kHz.

The figures indicated that SCA interference was produced by the induced 57-kHz harmonic. Further tests were conducted and it was noted that pilot distortion figures of 5 per cent or less created little or no SCA interference. The intermodulation products were definitely created in the stereo demodulator and were caused by the higher level of the (57 kHz) harmonic and the 57-kHz carrier. The 67-kHz injection level was increased to 15 per cent and the SCA interference increased approximately 5 db pointing out the importance of proper monitoring of the SCA injection level.

Further tests were conducted with the switching type demodulator used in the stereo monitor. The 38-kHz switching voltage which normally is 38 volts p-p was reduced to 20 volts p-p. This was accomplished by increasing the negative feedback preserving the low distortion of the 38-kHz carrier, reducing the switching duty cycle so that the diodes conducted for a very short period of time. The stereo performance, separation, distortion, etc., were not appreciably affected; however, the SCA interference increased by 12 to 14 db, pointing out problems that can occur in an improperly operating stereo demodulator. The 38-kHz switching voltage was restored to the proper level.

The 38-kHz switching voltage was purposely distorted to produce harmonic distortion. This produced a 9-kHz carrier or "whistle" because of the intermodulation products of the 76-kHz harmonic and the 67-kHz carrier. Tests proved that the intermodulation products produced by a switching type demodulator can be minimized to a level of -65 db with careful design.

Other sources of SCA interference blamed on the monitor or transmitter can be caused by RF amplifiers used at remote locations. RF amplifiers, when operated at maximum gain at remote locations, can have a tendency toward slight regeneration, narrowing the bandwidth, creating phase distortion and creating severe SCA interference. This can be minimized by reducing gain to the lowest possible level and by carefully tuning. This is similar to problems encountered in IF stages in tuners and receivers.

The following tests prove that if the SCA injection level is maintained at 10 per cent or less, the SCA deviation is held to a maximum of plus or minus 6 kHz, or preferably plus or minus 5 kHz. The SCA audio frequencies are limited to 5 kHz by a low-pass filter and if the transmitter is functioning properly it is possible to keep the SCA interference down to a level of at least 63 db or better and normally should not be objectionable, except to the most discriminating ears.

MODERATOR WULLIMAN: I would now like to present Mr. Howard Ham of Moseley Associates, Incorporated, who has provided much information for us in helping to track down this problem as it relates to transmission.

MR. HAM: I really feel that I need not comment to any great length at all here. Leonard's tests have quite well indicated what we have been talking about for some time. Some of you are new to the problem and some of you have been suffering with it for many years.

All in all, there is one fact to consider and that is no matter how well adjusted your transmitting equipment is, even to the degree that you have an ideal receiver or monitor system, it indicates that listening to good hi-fidelity music with good hi-fidelity receiving equipment, even a tone or a discreet birdie of nine or ten kHz and as low as minus 65 db and in some cases -70 db below 100 per cent modulation, is considered objectionable by some listeners. On the other hand, others have a dif-

difficult time hearing it. The people working at our plant, for example, cannot hear a thing above four kHz; so they are home free.

However, the fact of the matter is that some people are far more critical than others about it. As I said, no matter how careful you are with the adjustment of the transmitting equipment, you cannot prevent problems that occur at some listening sites to some listeners. In other words, with regard to this whole matter, you are at the mercy of a great deal of different opinions. From a technical aspect, I would like to make one further comment. I have talked to a great number of people over the last several years and one of the questions that often has arisen concerns the selection of this type of stereo technique or system. This has all been pretty well proven from a transmission viewpoint, for example, that in terms of bandwidth occupied, fidelity capability, and all of these other involvements, the system is very respectable. It was, in fact, selected to be compatible with standard monaural tuners but, also, with SCA; and from a theoretical viewpoint, it is. Unfortunately, the most objectionable feature that seems to be occurring today exists in the receiver.

I would like to repeat once more that it makes no difference how careful you are with your maintenance and the transmitting equipment, the problem is going to exist to some degree in certain consumer products. Therefore, if the transmission equipment is dirty, if you have problems, then you certainly likewise exaggerate these problems. You can make it very undesirable for any listener. On the other hand, if you have good housekeeping, this goes a long way toward getting the total answer toward the responsibility for the condition of transmitting equipment.

MODERATOR WULLIMAN: Our next panelist has demonstrated that it is possible, certainly with careful engineering, to build a garden variety receiver that can have the kind of signal-to-noise in terms of this problem that is down pretty close to that of a good monitor. While we have heard demonstrations of very high-priced systems where the whistle is audible at 50 feet, I think that is probably paying a compliment to Carl in relation to his part in the design of equipment like this. One of the nicest things I can admit about him is that he has certainly proven it is possible to do this without the receiver costing \$1000.

MR. EILERS: You know, I feel as though I am defending the receiving industry, and I think your accusations are probably well-founded. I would like to go back into a little history on this in order to indicate to you that this problem is not new insofar as the receiver manufacturers are concerned and this has to do with those that were around when the FCC first adopted this system in 1961.

Something like two years after that date, several people felt our laboratories should examine receivers to see just what was going on in the industry, since we had heard about this problem quite frequently. However, we did find out, through our investigations, that many receiver manufacturers were not doing their homework; either they did not know about the problem or, in the case of the component receiver industry, they considered this not a hi-fidelity service and, therefore, not something they should even consider talking about.

The components that we have found, by and large, were intermodulation components between the 67-kHz SCA subcarrier and the 19-kHz pilot. That is, you did not have to have a third harmonic of necessity in order to generate the problem. In fact, if you adhered strictly to the FCC rules in regard to the cross-talk from the SCA channel into the total baseband for the exterior signal, you can show that with just the SCA signal present there will be no cross-talk, but yet, when you insert the pilot, there will be intermodulation that exists in some form or another. This usually is true in all transmitters and receivers, even to the extent that you will generate a component in the vicinity of 48 kHz for one component and there, by and large, is the

greatest offender. The 48-kHz, when demodulated in the stereo demodulator, will produce a 10-kHz note, such as we have been hearing about.

There is also another one which produces a 9-kHz audio beat but this one is not the greatest offender. It is the 10-kHz beat note that we found back in 1963 which was the greatest offender.

Accordingly, as a result of these tests, we presented a paper at the Audio Engineering Society in October of 1963, which was published in 1964, so that there would be available some knowledge to people who might want to design FM receivers for stereo reception simultaneously with an SCA channel broadcast.

What has happened in the meantime? Well, we have had many, many radio receivers coming to us from overseas. We have receivers designed in the Orient. We have them designed in Europe and in fairness to them, while they have adopted the system that we have in this country, they have not adopted the SCA principle. Therefore, in connection with many of them, I am sure, they were ignorant of this particular problem. It may be, therefore, that a little missionary work with those people would help out the problem.

The tests that were performed back in those days indicated that the figure, whether 9 kHz or 10 kHz should be down at least 55 for the average listener. Now, here I am talking about those people who do not really know that it is there. Preferably, it ought to be at least 60. This includes the misadjustments, if you will, of tone controls in the receiver. Therefore, the measurement is made at the speaker and not at the output of the stereo detector. Therefore, you have the benefit of any boosting or detrimental action of any boosting at the end.

If you can have the beat note down to 60 db at the speaker relative to 400 cycles, then we find that the critical listener will just barely hear and it will not be objectionable. This isn't really something that is contrary to what we have heard before. I believe what we have heard about before was aggravated by the tone controls. What can we do about this problem?

I think the problem exists artificially in the transmitter and to a large extent in the receiver. The intermodulation between the stereo pilot and the SCA subcarrier can be generated in the RF circuits of the transmitter or in the tuner and I have a discriminator circuit of the receiver in the zero demodulation and these two, generally speaking, will be noncorrelated. They will tend to add as power rather than as voltage. Therefore, if you have 63 db, let us say, of interfering component, intermodulation component and transmitter measurement and then a similar measurement at the receiver up to the stereo detector, the overall will be 3 db worse—that is, 60 db.

You must remember that if the overall system should provide 60 db of rejection of these components, that all components in the system must be better than that including, of course, the receiver.

Well, we have, in our own shop, recognized this problem right from the very start, especially since we were one of the proponents of a system, and we found out that the SCA subcarrier could be injected, providing you took extra pains in keeping control of the distortion components.

Our receivers to date typically measure 75 to 77 db down on the 10-kHz component and 90 db in the case of the 9-kHz dropoff. This would be fine, especially if you recognize that there are some things that will generate distortion that are not under your control, such as the multi-path distortion that could exist between transmitter and receiver. This will cause a phase shift in the IF system, consequently causing the intermodulation and, therefore, we felt that in our own receivers you must have an SCA trap to protect the stereo demodulator.

Now, what have some of the other people done? Here I would like to separate the receiver manufacturers into two groups, as has already been done by Mr. Wulliman for us, the component receiver type and those that are in our end of the business, the so-called packaged goods type of receiver manufacturers.

By and large, we have in our section of the industry been aware of the problem and have done something about it, although, in the early days, this was not completely true. The component people, on the other hand, who advertised their wares in the audio field type magazines, at least among other places, will completely ignore this problem. At least this is my impression. Further, one proof of this point is that the various testing laboratories and consultants that will test the receivers that you will see the results of in these magazines completely ignore the presence of this problem. In other words, they say nothing about the SCA problem.

There is, for example, a well-known testing laboratory that tests for one of the magazines published in the midwest. I will not mention any names. I think many of you will know who I am speaking about. However, they have nothing to say about this problem. They will measure sensitivity to the receiver, separation, signal-to-noise, a lot of things of that nature, but they are completely silent about the SCA problem.

There is another testing laboratory which, by the way, has a booth downstairs in the Conrad Hilton Hotel, selling broadcast equipment, which likewise does not say anything about this problem in their testing. There is another well-known kit manufacturer who, in fairness to them, does say what it does and how it performs. For example, 55 db is mentioned in one case, 50 db in another and they are silent about some of the other products. This, of course, is completely unsatisfactory.

Therefore, I believe that the way to get at the problem is to get at the people that do the testing for this type of receiver, whether the receiver comes from the Orient, Europe or is domestically manufactured.

I think one further point is perhaps to emphasize to the receiver manufacturer the extent of this problem and the continuing need for SCA service among the broadcasters. A high percentage of broadcasters rely on this type of service, which might emphasize to those people who have design responsibility that this must be accounted for.

MR. WULLIMAN: I think the last couple of remarks that Carl made reminded me of the possibility of 4-channel stereo which might perhaps be put on a subcarrier similar in frequency to the SCA. Certainly, some stations who may not wish to transmit background music service, might, in turn, wish to transmit 4-channel stereo in the future. Therefore, if this problem is not recognized, we will suddenly find ourselves in a big trap insofar as the total 4-channel stereo transmission system is concerned.

I believe that some of the panel members have some thoughts along this line but I don't want to get into numbers. Harold, I believe you said that you were here to field questions, but before we go into that, do you have any remarks you would like to make about the history of this situation or anything?

MR. KASSENS: Well, there isn't much I can say that you have not already heard from the experts, except I would like to emphasize just a couple of things. Carl, for example, was talking in terms of numbers. For your information, the numbers are these.

There are over 600 SCA authorizations out and over 600 stereo stations that have reported to us and as to how many of the SCAs are stereo or vice versa, I cannot tell you since we don't require this information. However, I am sure the number is well over 300. Therefore, this indicates the prevalence of the problem.

I have to admit that both Jim and I have been talking about this and he was going to reply first so that I could hear what it really was because I have never heard it. However, I will not argue that it does not exist. In fact, I would expect that it does exist and that is why I am going to emphasize a few little points.

One of these has to do with the question of injection levels which was mentioned. Unfortunately, I am afraid some stations do not realize how very important this is. To get off the subject a little bit, I think it is fairly well established at this stage of the game that improper injection level is a cause of the signal dropouts. A lot of people have complained, when they went into stereo, that they got a picket fence. However, I now think we all recognize that the problem has to do with improper injection levels.

I have a field note here from an antenna manufacturer that points up this problem and advises their clients to the effect that it is very important to have the proper injection levels to cure signal drop-outs. I think we are talking about the same sort of thing here. I have been getting wind of the fact that some of the operators did not believe we really knew what we were talking about when we said ten per cent SCA and they have been raising the level of the SCA and, of course, they were not happy with having to cut it down to ten per cent when they went into stereo. As a result, you had a few unsatisfied customers. Of course, the easy answer is to try to go up. Some people get a little concerned that all the stereo lights are not coming on so they jack up the level a little bit.

I think this is a part of the problem and the answer is a very obvious one—namely, that the receiver manufacturer believes he can rely on our rules. If you start fooling around with those levels, then you have created problems for him. Therefore, I do think that the injection level is very important.

Another thing is that if you stop and analyze the stereo demodulator, you have to recognize that in this demodulation you have a substantial level of 19 kHz and in the doubler, a substantial amount of 38 kHz. Now, if the receiver is also picking up 67, the level in the stereo demodulator is going to be rather high unless you have an SCA trap—not only to have one but to make sure it is peaked at the subcarrier frequency. Some subcarriers are in 65 and some at 67. I think here, at least to me, one of the factors is to make sure that the SCA trap is there and that it is properly peaked.

Some of the information we have received indicates the fact that they are present, but they are a long way from 67 and this is a part of the problem. Also, Carl mentioned the fact that some of the manufacturers did not realize what SCA was and a goodly number of receivers have shown up in this country without the trap. This is especially true of foreign manufacturers.

There is one other point that I would like to make and that is in relation to the nature of the program on the stereo channel. This has not been mentioned specifically, but when Jim first called me when this problem showed up and they were having trouble finding an answer, there was an indication that in his particular case he had been playing good music type of programs and with a rather tremendous dynamic range. I think the answer here is obvious to you. If the spurious products are there and you hit low passages, obviously you are going to hear them. Therefore, I think this is, likewise, a factor to be considered here.

MR. WULLIMAN: That is a good point, Harold, because I did mean to mention that in my initial remarks. Now, in discussing this whole situation with a number of different station engineers who have stereo, I have said I doubt that we would have a problem insofar as the listener is concerned if we had the two signals from the beginning. It is a fact that we had a so-called "good" music or "middle of the road" music main channel operation over a reasonably wide dynamic range and that to this we added the SCA so that they could hear the difference that gave us our results. If we had,

from the early days of stereo, an SCA operation and had gone through all the problems that I have discussed with other people who were in it before and then tried to evaluate and decide whether or not to go into it, we would have a far different outcome.

Incidentally, with regard to this matter, we do not find the transmitter to be a problem. It is pretty stable. It hasn't been a problem anywhere along the line. However, the people really would not have known what we were doing to them because it is my opinion now that the very least that we are doing to people in connection with their receivers is reducing signal-to-noise.

This is the case whether or not they recognize what is happening to them because while they may not write us a letter or call, it is causing a reduction in signal-to-noise that we might say is a fatigue factor, depending on the listening conditions. As far as the audibility is concerned and whether it was objectionable or not, none of us at the station were aware of it until we began to get listener complaints.

It did not, however, exist to the extent that we heard in the couple of weeks before beginning to get some response and, therefore, we were looking for some sort of problem because we did hear some existed.

Now I would like to open the session to questions from our audience. Do you have any questions?

FROM THE FLOOR: I wonder about the second and third audible subcarrier frequency. We have one stereo plus an educational subcarrier and we thought about adding two more subcarriers for various reasons. I wonder, whether, in regard to this, any investigation has been done on what kind of system should be used?

MR. KASSENS: Well, my first reaction to your question is that if you are going stereo and you are adding two more subcarriers, you are going to drive Leonard nuts when he tries to design the receiver because the cross-talk, I would expect, would be tremendous.

MODERATOR WULLIMAN: Under the rules, is there any way that they could put more than one subcarrier in when they have stereo?

MR. KASSENS: Strictly speaking, the spectrum space is there. You have all the way from 53 kHz up to 75 kHz to put as many subcarriers in as you want, but the only problem that you run into has to do with the cross-talk into the stereo subchannel, which is a fabulous one.

MODERATOR WULLIMAN: Therefore, if they were narrow enough, you could have several?

MR. KASSENS: Right.

FROM THE FLOOR: I wonder how close we are to a discreet transmission for discreet signals insofar as 4-channel stereo is concerned, particularly if it involves the matter of using 100 kHz instead of the 75 which is now available. I believe that was one of the systems that was suggested. I have also further heard it stated that it will be possible to run stereo in discreet fashion and also SCA signal-to-noise if you are now broadcasting stereo and SCA. I am wondering if this is something that is in the near future?

MR. KASSENS: In answer to your question, I do not have the slightest idea because I think there are a tremendous number of problems involved. However, I would like to pick up on something that you said in relation to what Jim said about the problem that we are talking about. I suspect there would be a problem, of course, because you have to remember that if you are switching at 76 kHz and you have 15 kHz sidebands, I suspect they will be at 67 as well and we do have a rather substantial problem. Therefore, I do not conceive that you can use SCA at 67 while you are switching at 76.

MODERATOR WULLIMAN: Howard, you are shaking your head, do you have a comment.

MR. HAM: My only comment to that is if you have 4-channel stereo pertaining to the system that you define here, you consider the use of SCA and, like Harold says, where are you going to put it—there isn't any room for it.

MR. EILERS: I would like to comment on that. Even if there were room for it, in order to be compatible with the receivers already on the market, there is no place other than the 67-kHz spot that the receiver is blind to. We are trying to achieve at least 60 db and hopefully a lot better than that. In relation to the group of birdies that may exist, we must use a configuration that has been collected by accident and is now in common use. I don't think there is any other spot for SCA.

MODERATOR WULLIMAN: I would like to say that we tried, with Harold's blessing, an experiment that did not last a whole day, in trying to move the SCA frequency up. As I recall, we were around 72 because we found, on an experimental basis, that we seemed to get rid of the birdie or at least it got to around 12 kHz or something like that. I seemed not to be a problem.

Also, the bandpass of the music receiver was such that you could not tell we had moved it. However, the only trouble is that we did exactly what Carl is talking about; we made a quick telephone survey and found that it was audible in the experimental receiver. We also slid right out of our tuning traps on others. We quit at noon, as I recall, and came back to 67 where we belonged.

I am afraid that we are now going to have to close. Perhaps, if you have further questions, you can contact these gentlemen after the session and get them answered.

A Discussion of Automobile Radio Reception

Edward H. Herlihy
Kaiser Broadcasting Corp., Boston, Mass.

H.G. Riggs
Delco Electronics Division, General Motors Corp., Kokomo, Ind.

This is a brief history and introduction to the main part of this speech by Mr. H. G. Riggs of the Delco Radio Division of General Motors.

In the Fall of 1969, our FM station in Boston, WJIB, received several complaints of poor FM car radio reception in the Providence, R.I. area. Each of these complaints was traced to 1970 General Motors cars using windshield antennas. The Kaiser Broadcasting Engineering department was asked to further investigate this problem. In the course of our early efforts, NAB Engineering was contacted and the problem discussed. The result was a joint Kaiser/NAB engineering study begun in February 1970. Tests were made on directivity, impedance and resonance of the windshield antenna. Sound recordings were also made to point out the aural disturbances caused by operation of the windshield wipers, especially with FM reception. Our tests showed some directivity and a swishing sound in the background when the wipers were operated. These tests and recordings were presented to a meeting with Delco representatives at NAB headquarters in July of 1970. Many points were brought up which Mr. Riggs will discuss in a moment. It was agreed to have a second meeting in the Fall. This was held at CBS headquarters in New York. A progress report was given by Delco at that time and another meeting was scheduled for January 1971.

At the CBS meeting it was decided by the NAB Group to sponsor an independent engineering study for presentation to Delco in January. This study was received from Carl Smith Associates of Cleveland, Ohio in time for our January meeting. It showed about the same findings as the Kaiser/NAB study.

The study was presented to Delco and a progress report was made by the Delco Engineering department. It was suggested at the meeting to have Delco give a progress report on the windshield antenna at this meeting. This has been further expanded to discuss automobile radio reception in general.

It has been the purpose and intent of these joint industry meetings to point out problems caused by the windshield antenna and seek action to solve these problems. We on the radio transmission side of the group feel that Delco is making progress towards solving the problems. Mr. Riggs will now bring you up to date on the windshield antenna and car radio developments in general.

Although I have been in manufacturing all my life, we actually are members of the same team in that we supply the "hardware" through which you reach audiences. You gentlemen supply the "software," if you will, which encourages potential buyers to order a radio—hopefully Am and FM—for their new car.

Therefore, we in the auto radio industry are just as concerned about offering the motorist—who is our customer and your listener—the best radio system possible at a price he can afford and is willing to pay.

As our population has become larger and more mobile, the number of people listening to the radios in their automobiles has grown steadily. Not only are more people listening to more auto radios but the amount of time they listen per day has steadily increased. Suburban living has created new traffic patterns. The flexibility of the automobile permits the motorist to live in residential areas farther from his work, thereby increasing his time-in-car per day.

CUMULATIVE NUMBER OF FM RADIOS INSTALLED IN GM AUTOS

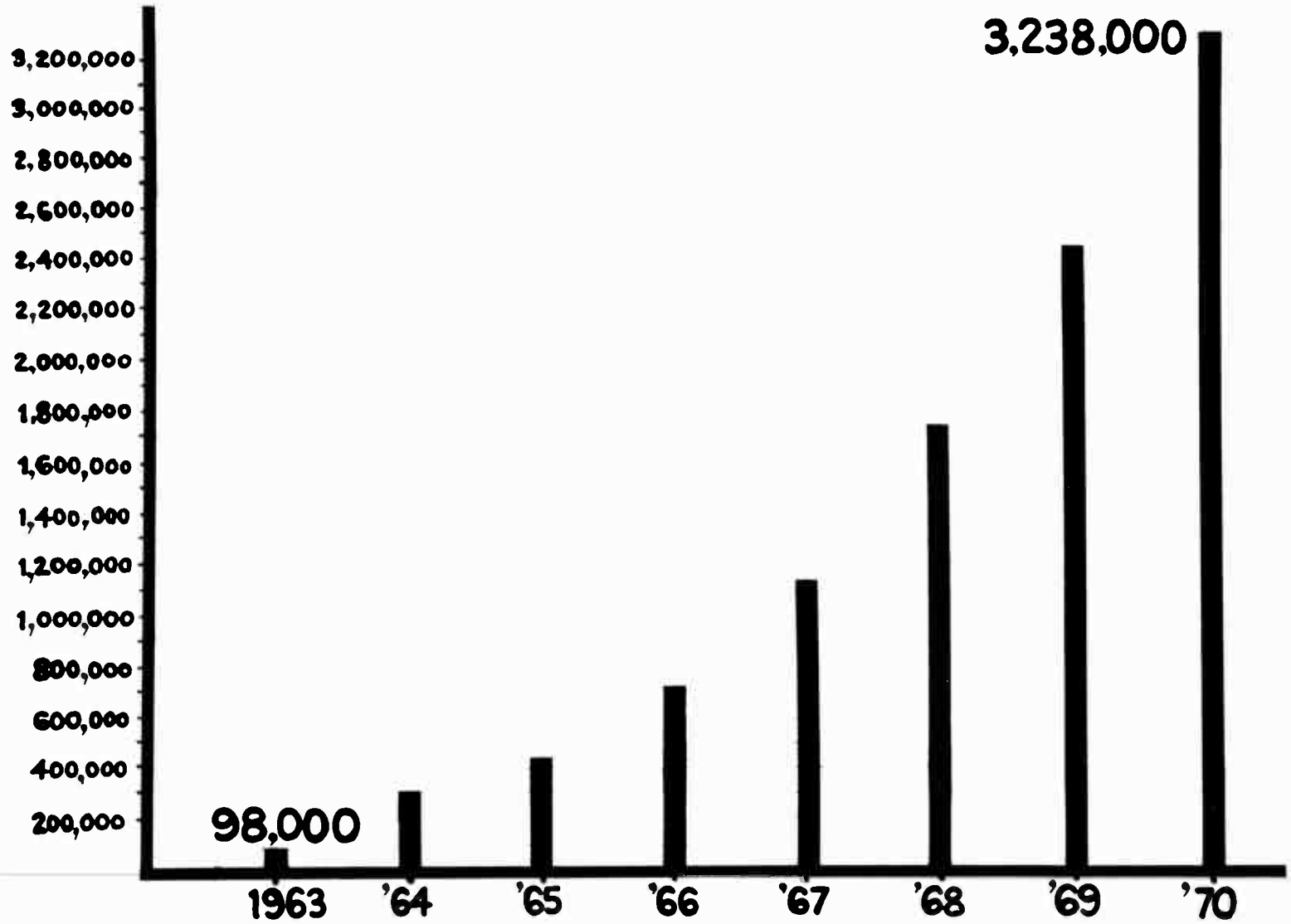

Fig. 1

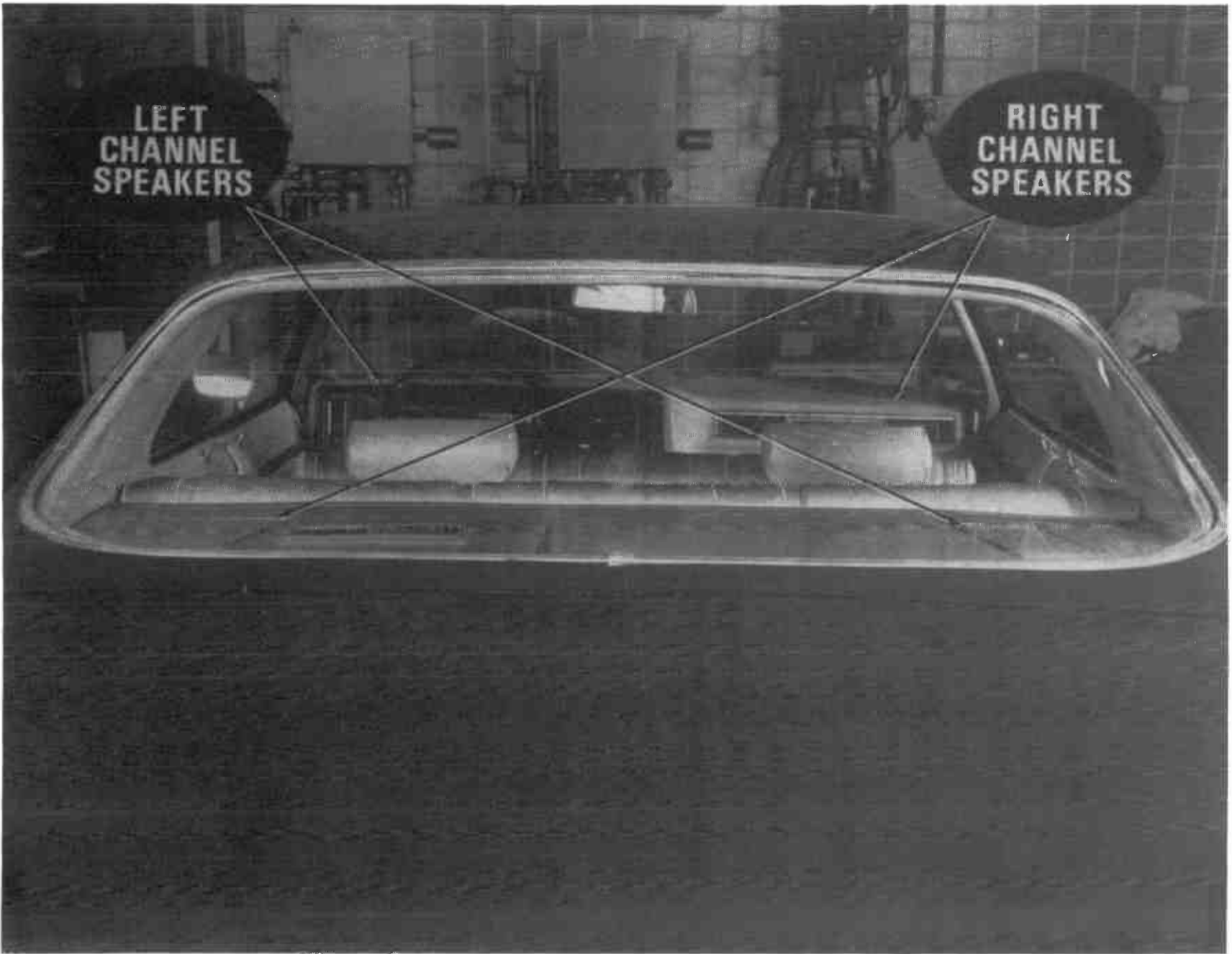

Fig. 2.

The superhighway network has increased vacation travel by automobile. We are hearing more and more about more leisure time for the working man... the four day work-week seems to be getting more attention.

You gentlemen, of course, are intensely interested in reaching this traveling audience, in providing motorists with the most entertaining and informative programming possible. Delco Electronics also is vitally interested in these motorists. We are dedicated to providing them with the finest system available, the final link in that electronic hook-up between your radio stations and your listening audience.

Since 1936, our division—which was known as Delco Radio Division of General Motors until our operations and those of AC Delectronics Division in Milwaukee were consolidated last September—has been an industry leader, we think, in designing and building reliable automotive radio systems.

We also feel we have been innovative. The signal-seeking radio for quick and automatic selection of desired program material on any listenable station, including stereo-only signal seekers, as one example. Also, the all-transistor radio with its instant-on feature and elimination of the former well-known vibrator power supply is another. FM and FM stereo with their 4-speaker systems is another.

Delco was conducting extensive tests of FM reception in the late 1940s when a few relatively low-power stations were getting on the air, using the old 50-MHz band. Our work, of course, has continued since that time.

I don't have to tell you gentlemen about the substantial increase in FM broadcasting during the past 10 years. I am sure your association has very complete statistics. But I thought you might be interested in some of our figures which indicate the growth in popularity of FM in the auto industry.

We began building AM and FM receivers in mid-1962 for introduction in Chevrolets in the 1963 model year. Our initial production was a rather modest 98,000. However, since 1963, Delco has manufactured well over three million radios capable of receiving FM broadcasts, in addition to AM frequencies. Well over one million—one-third—of these three million are FM stereo receivers (Fig. 1).

Assuming that most of the GM automobiles built since 1963 and equipped with FM radios are still in service, the chart in Fig. 1 gives you an indication of the size of your automobile FM listening audience in GM cars. The industry total, of course, is much higher.

So, with this background, I think you can see why we, as members of the auto industry whose major marketable product is the auto radio, are so vitally interested in the products and systems which provide the motorist-listener with the best possible radio reception.

As you recognize, I'm sure, the automobile presents a totally different physical, acoustic and electromagnetic environment compared with the home. However, in some ways, the listening conditions are very good. For example, the audience is in a fixed, seated location in the car and, therefore, the tone quality, speaker positioning and stereo effect can be precisely tailored to the automobile interior.

To exploit this advantage, as many as four speakers are being installed in the automobile for cross-fire reproduction of stereo programs (Fig. 2). They present excellent "center-orchestra" type listening. Large speakers and high acoustic output, several times that of the usual home radio, are provided to give good tone and to overcome wind and traffic noises. But, along with the advantages, FM reception in the automobile presents some difficulties. I want to elaborate on the challenges we have faced—and are facing—to solve these problems.

Between 1960 and 1970, the number of stations broadcasting FM signals increased from 688 to 2,196, at our last count (Fig. 3). Although not specifically relevant

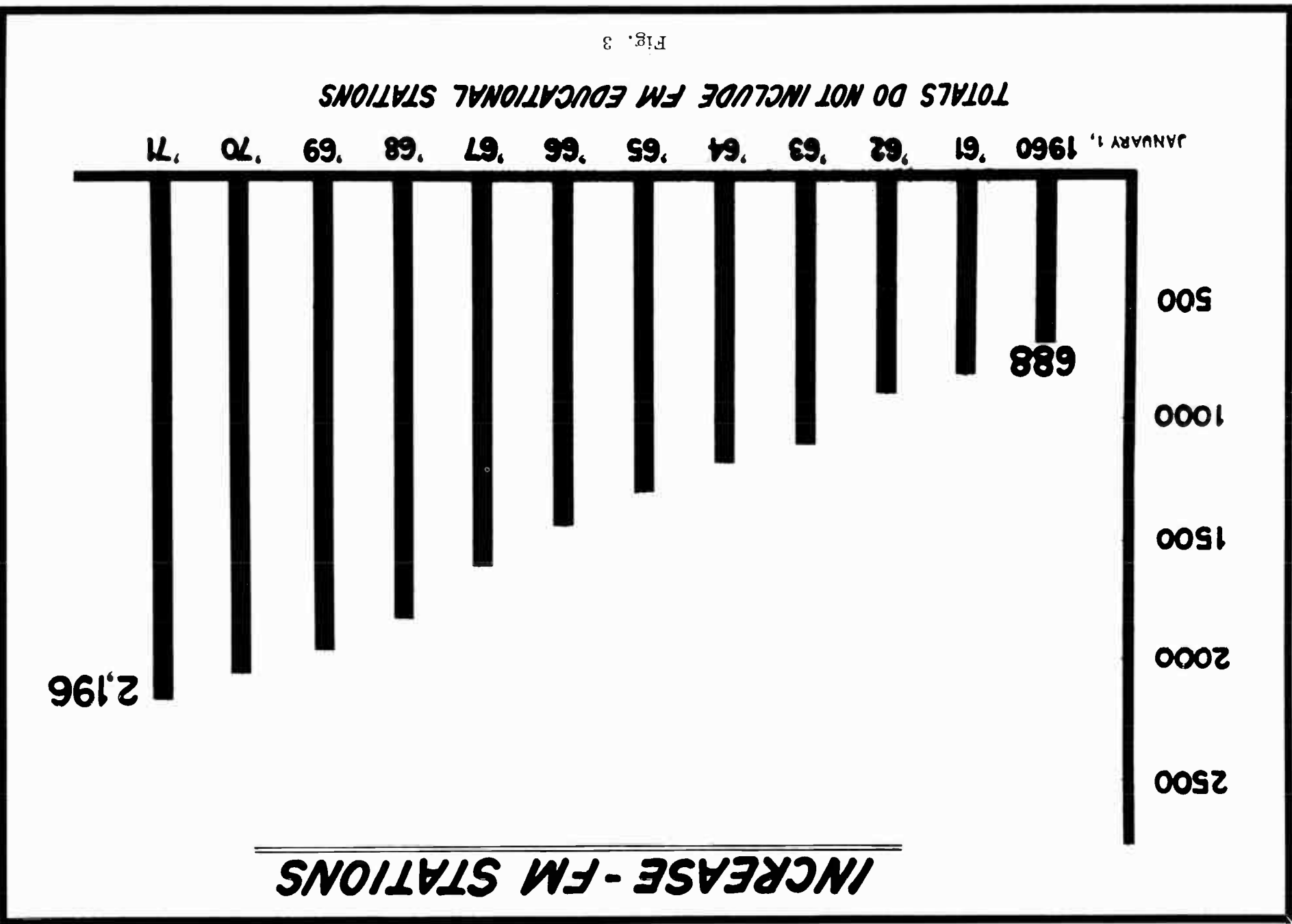

Fig. 3

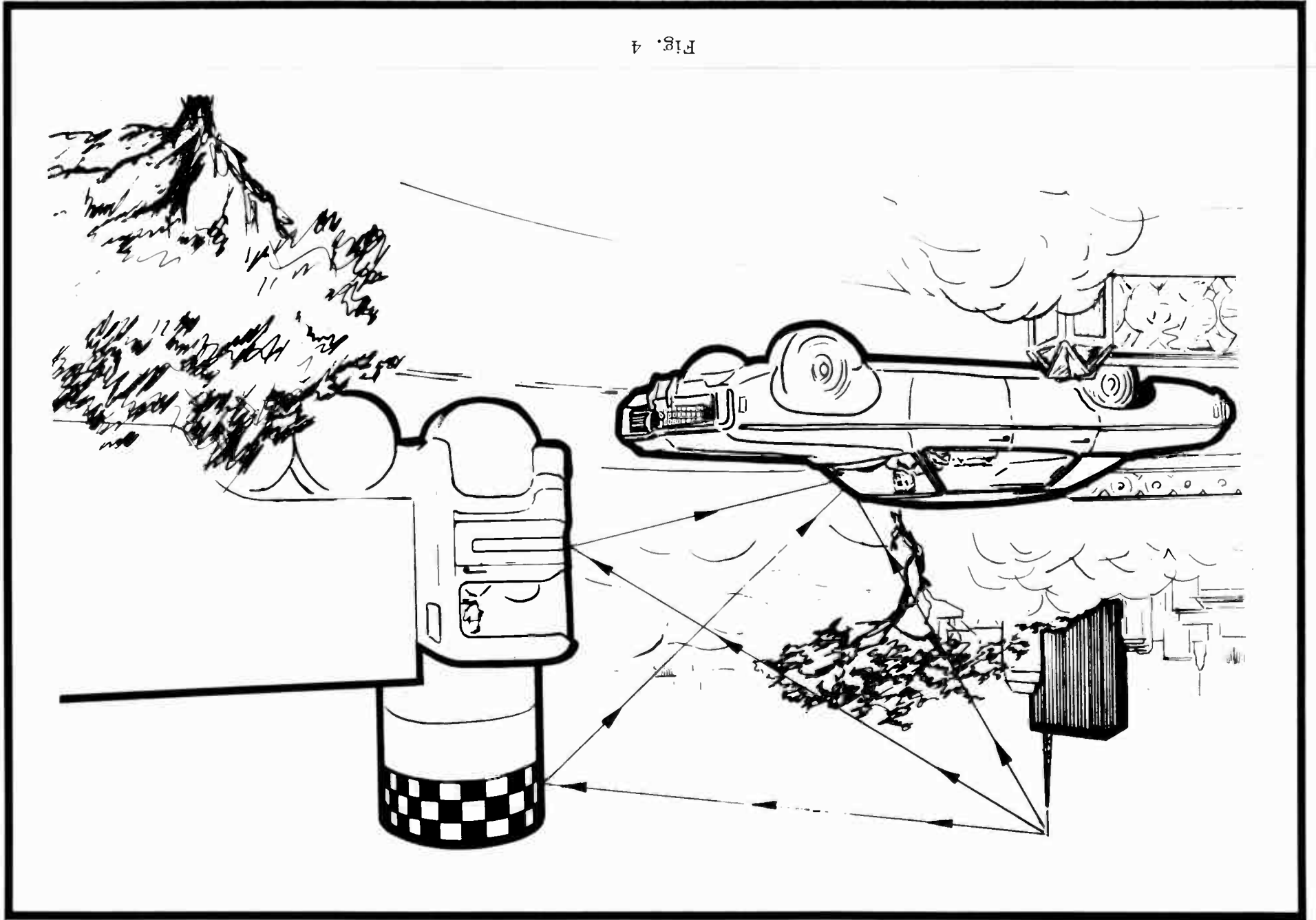
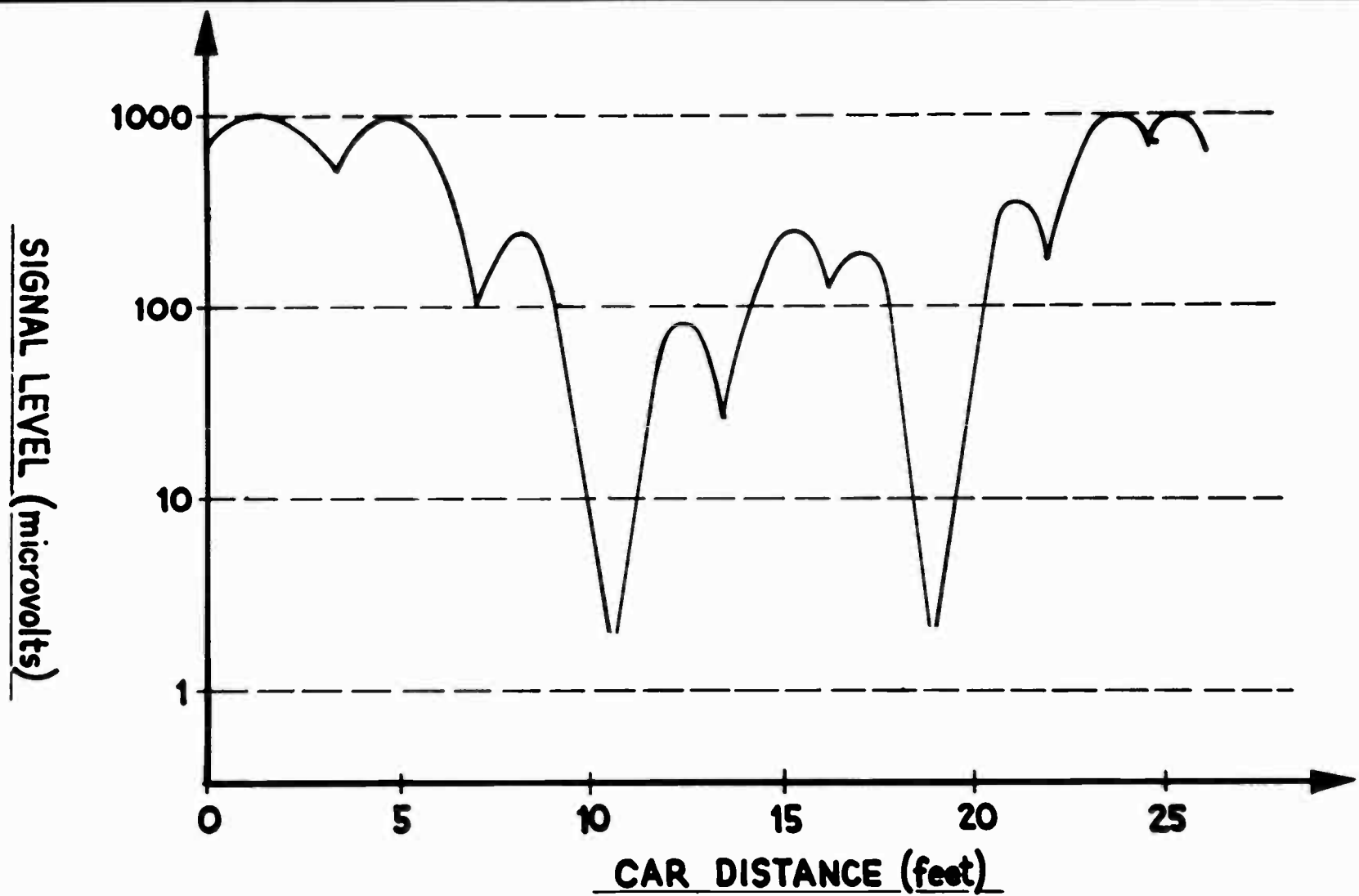

Fig. 4



**RECEIVED SIGNAL LEVELS IN MULTIPATH AREA
WOODLAWN AVE. AT I-94 OVERPASS - DETROIT**

Fig. 5

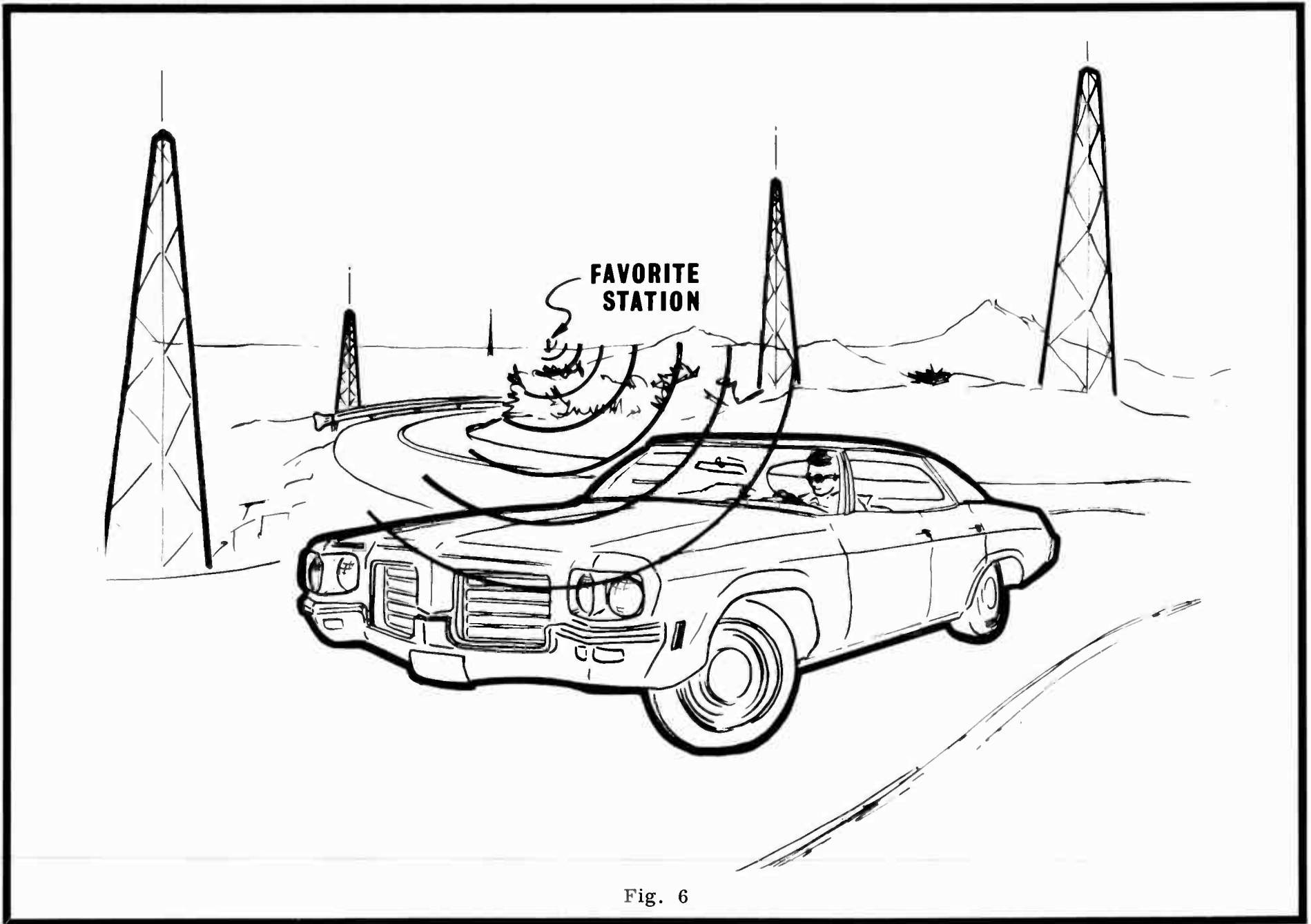

Fig. 6

to this discussion the number of AM stations also has grown substantially, from 3,326 to 4,256 in this same period.

Such growth requires the design and building of better, more sensitive and more reliable auto radios which tune in one and only one station, as more and more geographical areas of interference are generated. In addition, the vehicle's location, relative to the transmitting station, is continually changing. The listener experiences a wide variety of reception conditions, ranging from those while immediately adjacent to the transmitter site to the far fringes of reception areas.

Our experience indicates that the range of the usual Class B FM station is 30 to 50 miles and is limited, not so much by the pick-up characteristics of the auto antenna system or by the power of the transmitters, but by the listener's tolerance to receiving noise bursts in rapid succession as he moves along the roadway, and by his desire to hear specific programming.

The noise bursts to which I refer are due to a major automotive FM reception characteristic and problem—multipath distortion. This multipath distortion is the partial or complete cancellation of an FM signal caused by the addition and subtraction of several signals from the same station arriving at the vehicle's receiving antenna from different directions or angles.

Fig. 4 is an example of multipath distortion. The car's radio receives the direct signal from the transmitter, plus signals reflected from metal surfaces such as tall building, bridges, power lines, water tanks—even other vehicles moving or standing still. All types of vehicle antennas recognize multipath distortion.

For example, in a metropolitan area where typically received signals may average several millivolts—a very strong signal, incidentally—multipath effects can, and do, reduce the signal a thousandfold (by a factor of a thousand) to below the sensitivity threshold of the receiver for a short distance, every few feet (Fig. 5). Depending upon the severity of this multipath "null" and the speed of the automobile, the listener may hear a slight tick, a hiss, a sputter, or a growl. We have worked very hard to minimize multipath effects by providing the best sensitivity possible, and by minimizing the harshness of multipath effects when they do occur.

You gentlemen have spent many thousands of dollars to provide sufficient transmitted power, partially vertically polarized radiation, and unobstructed antenna sites to assure the best reception for the greatest number of listeners. The steady, rapid growth of the automotive FM audience attests to the fact that we both have been successful. But we still have work to do.

In addition to the multipath problem limiting maximum range, broadcast engineers interested in the service areas covered by FM broadcast stations must not overlook another important difference between their mobile listening audience, which is on the move, and those listeners sitting at home. Many motorists drive past transmitter antenna sites where multiple transmitting antennas create very high-intensity electromagnetic fields, often on several closely spaced frequencies.

The auto radio audience in these situations may be well within the service area of another station several miles away (Fig. 6). They may prefer to listen to this distant station, but find that their reception is being interrupted by the transmitters nearby. This interference comes in short bursts. These staccato bursts always seem to occur when the closing prices on the stock market or some other vital piece of information is being broadcast. Such transmitting areas with heavily traveled roadways nearby are not difficult to find. Typical areas are found adjacent to the Empire State Building, Exit Number 86 along Route 25 around Boston, the Chicago Loop and the waterfront area near Cobo Hall in Detroit, just to name a few.

In these areas, the automotive receiver/antenna system must be designed to do a better-than-average job of station-sorting if the listener is to receive his favorite program without interference. Unfortunately, this design is not usually the one which gives maximum range of pick up.

As more and more high-powered transmitters are put into service, this sorting ability must be made better and better. To do this, we have improved the radio and the automobile antenna and, most importantly, the electrical match between these two elements.

Improvements to the auto radio during the past few years include greater intermediate frequency selectivity. This permits the separation of the many high-powered FM transmitters operating only 800 kHz apart, and often using antennas physically separated by only a few hundred feet. Our tuning system is designed to be immune to temperature variations and to normal excursions in the car's battery voltage. Also, a characteristic known to engineers as "front-end" selectivity has been improved in order to avoid, as much as possible, two stations coming in together.

Now, about the automobile antenna: The limitations of the whip antenna, which has been standard for the automobile for about 30 years, are well known. While the performance of a new whip antenna is quite acceptable, its receptivity deteriorates quite rapidly because of age, exposure to weather, and other factors. Therefore, after a year or so, there is a high probability that its performance will be substantially degraded. Also, the whip antenna is an attractive target for vandals. It can be broken off in car washes and by low-hanging tree branches, especially when it is mounted on the right-hand side of the vehicle (Fig. 7). The telescoping sections sometimes loosen and cause noises in radio reception.

For several years we have been experimenting, attempting to find the optimum automobile antenna which is mechanically and electrically very sturdy and, at the same time, inconspicuous and inaccessible. Insulated bumpers and insulated trunk lids tend to give very adequate—but mildly directional—pick-up on AM. But they are quite unacceptable on the FM band.

Fig. 8 shows one proposal tested: a rod insulated from, and mounted adjacent to, the rear bumper. Electrical defroster grids (Fig. 9) in rear windows give good pick-up on both AM and FM, but they are quite expensive and are not installed on a very high percentage of automobiles.

We developed a good antenna which insulated the entire top of the car at the four corners (Fig. 10). The problem here, however, was to build the automobile with sufficient strength and structural integrity to withstand rollover tests. This problem has not been solved. At one time, loops in the windows or windshields (Fig. 11) of the car were reported by the inventor to be very effective. But our tests indicated high directivity and low pick-up on both AM and FM broadcast bands.

The decision to use windshield antennas was based on the results of extensive field testing programs which indicated that its pick-up was adequate; it was mechanically sturdy; it was inconspicuous. In 1969 we first used the windshield antenna on all Pontiac Grand Prix models. The favorable experience during 1969 led to its installation on practically all GM cars beginning with the 1970 model year. The field failure rate on antennas was greatly reduced in 1970 with the new antenna.

The antenna consists of two wires, five-thousandths of an inch in diameter, running vertically up the center of the windshield and then extending horizontally for 16 inches each side of center (Fig. 12). Although it appears to be a dipole, it definitely is not. The two vertical wires are connected together at the bottom and give the windshield antenna substantially vertical polarization just like its predecessor, the whip antenna. This antenna can be coupled to the radio with optimum

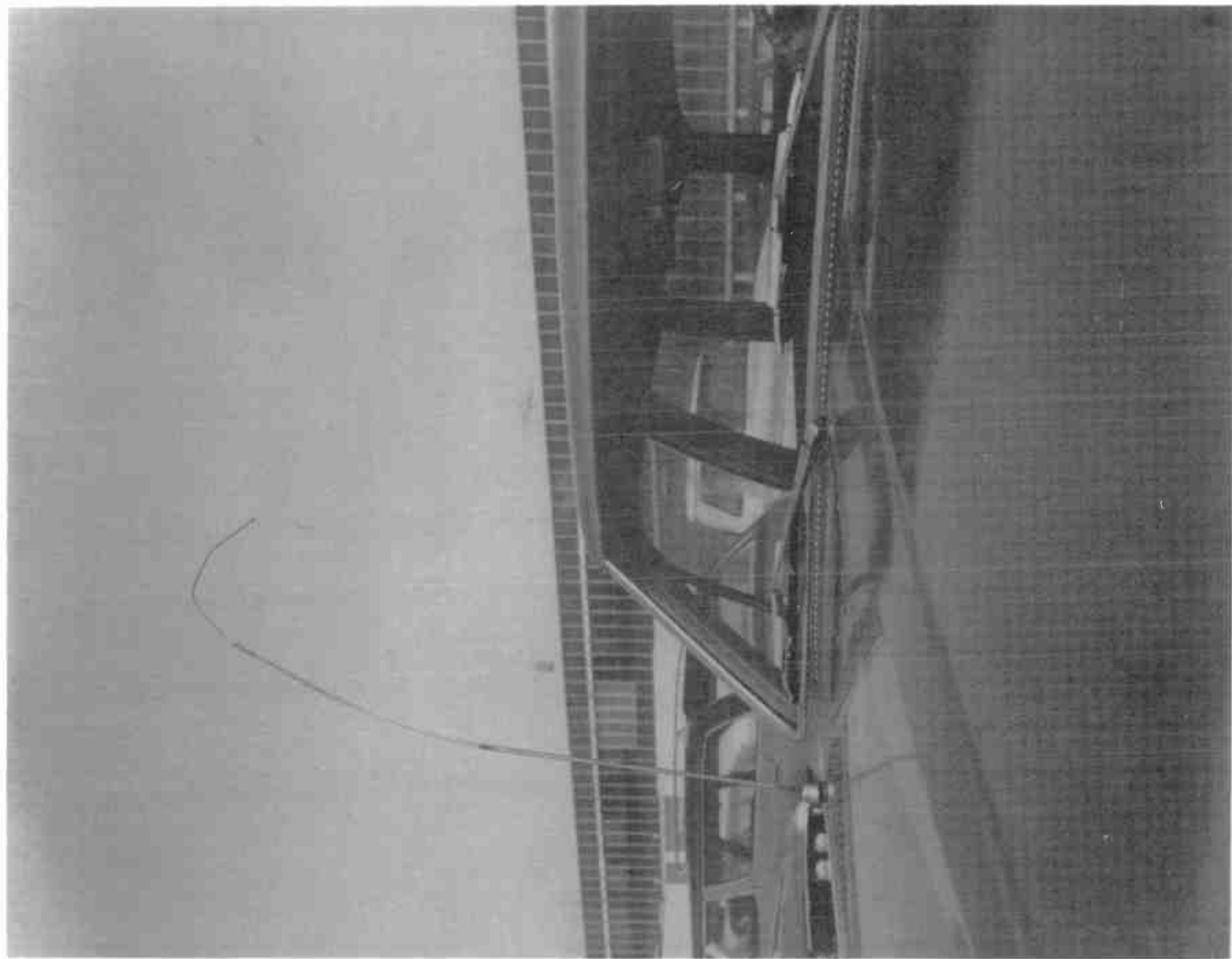

Fig. 7

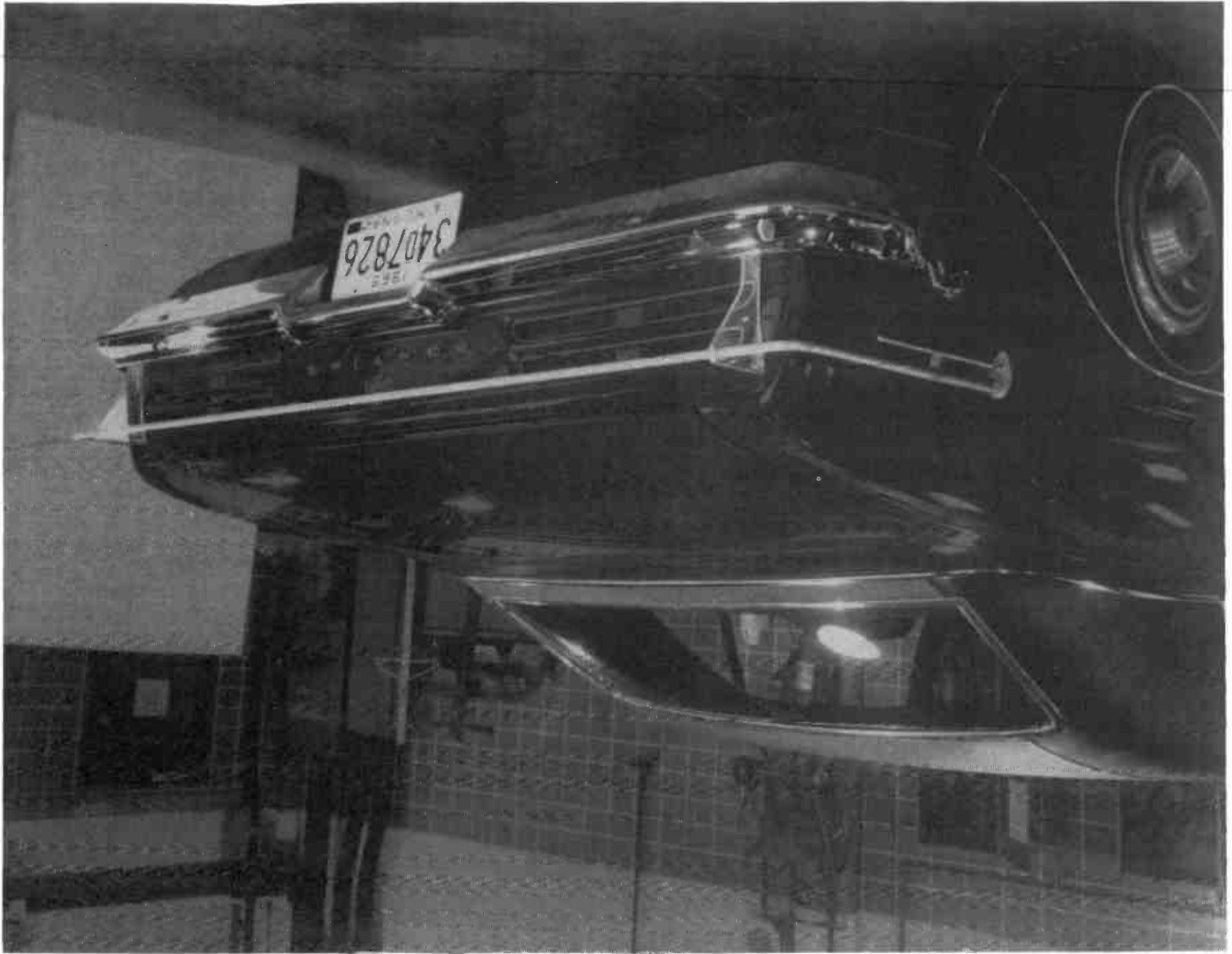

Fig. 8.

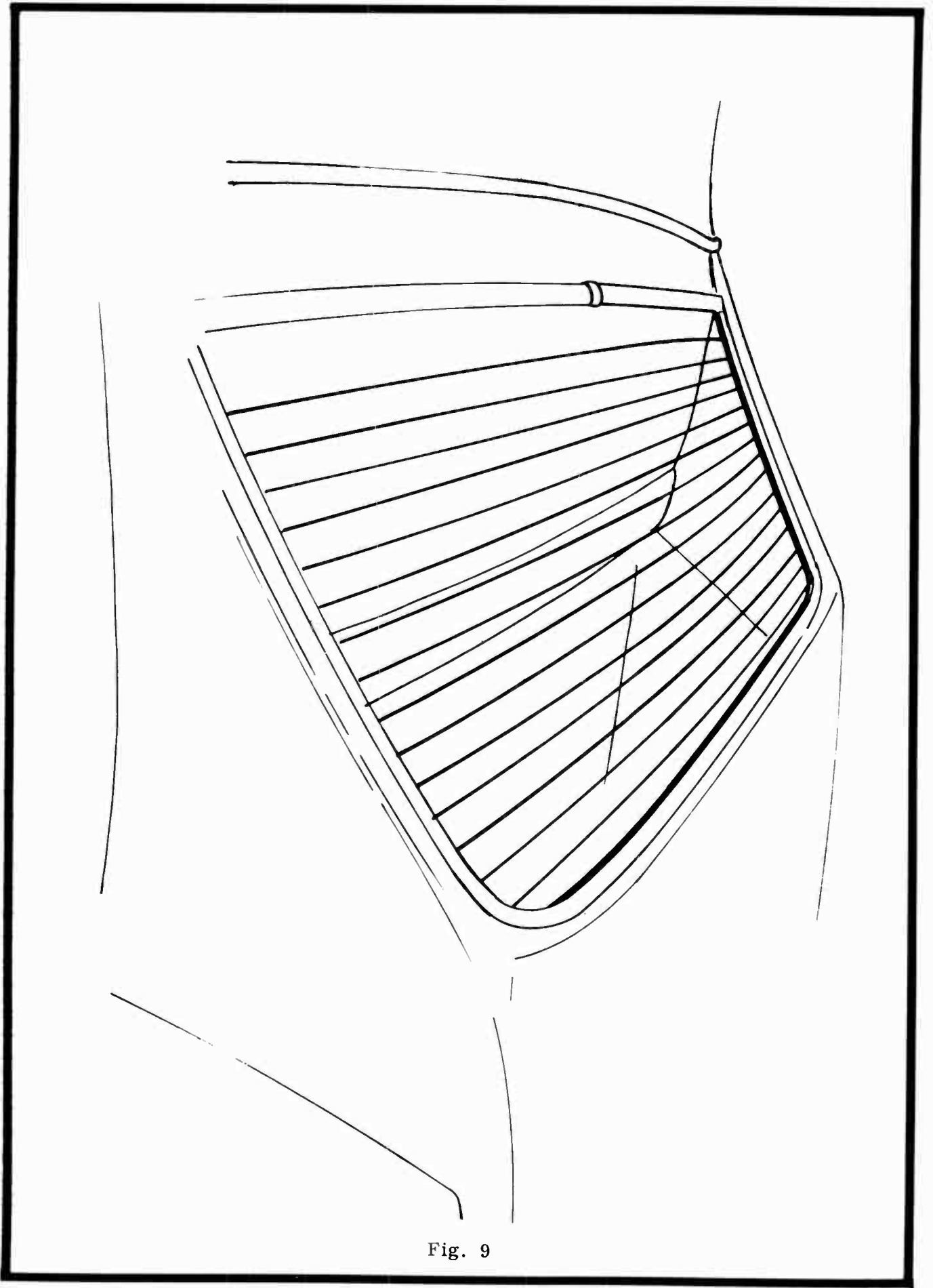
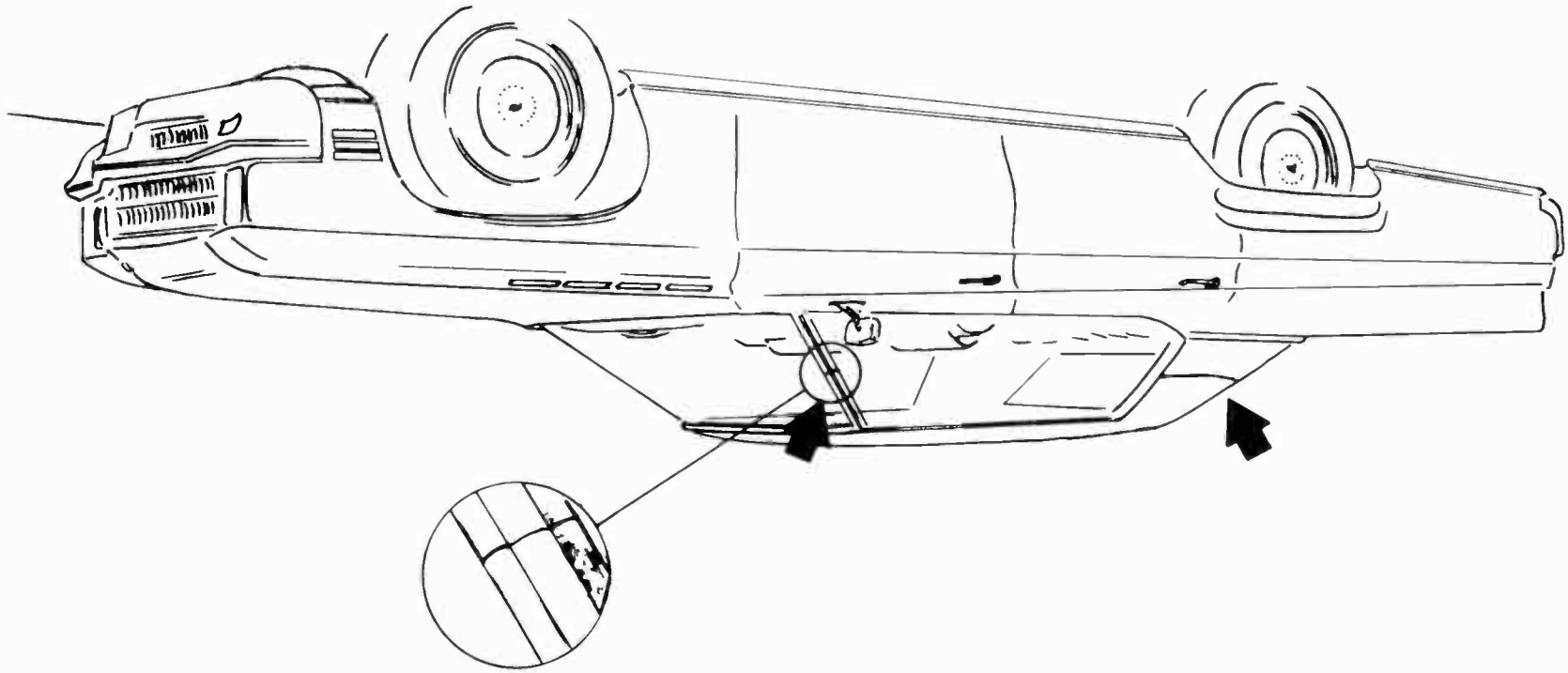

Fig. 9

Fig. 10



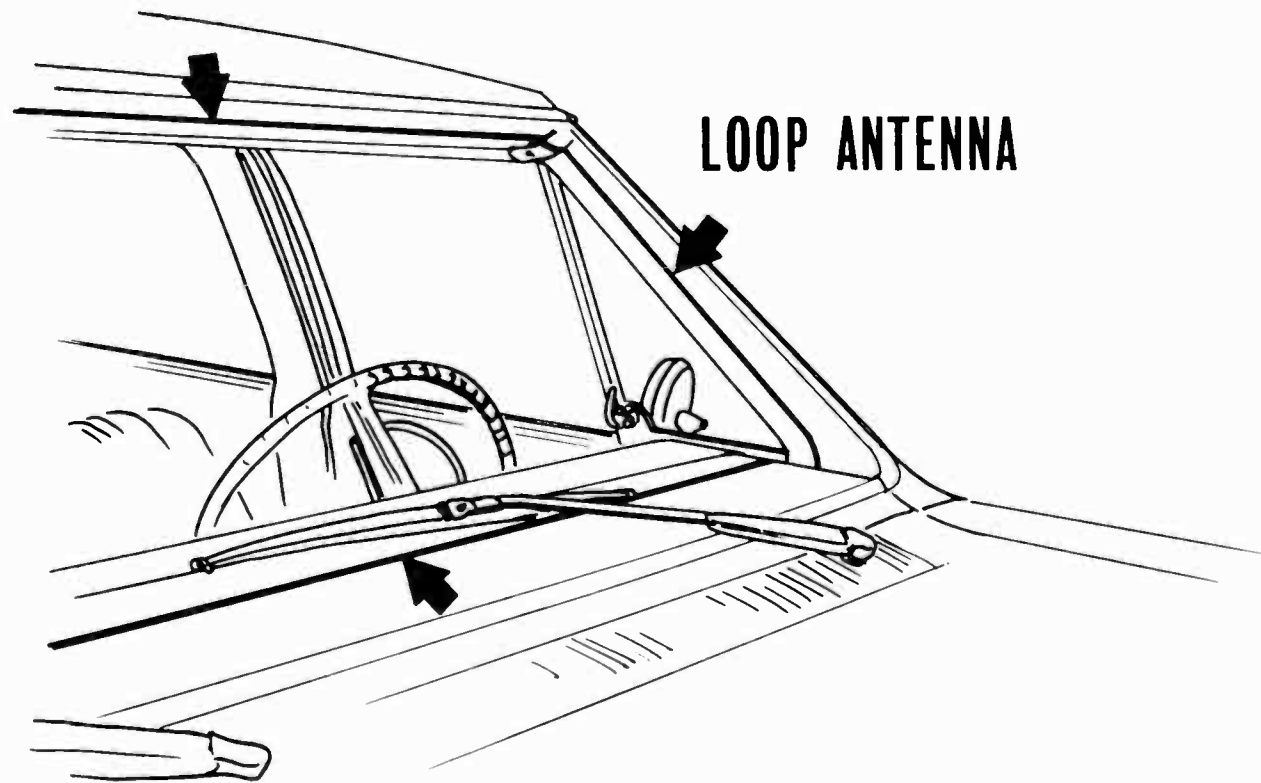
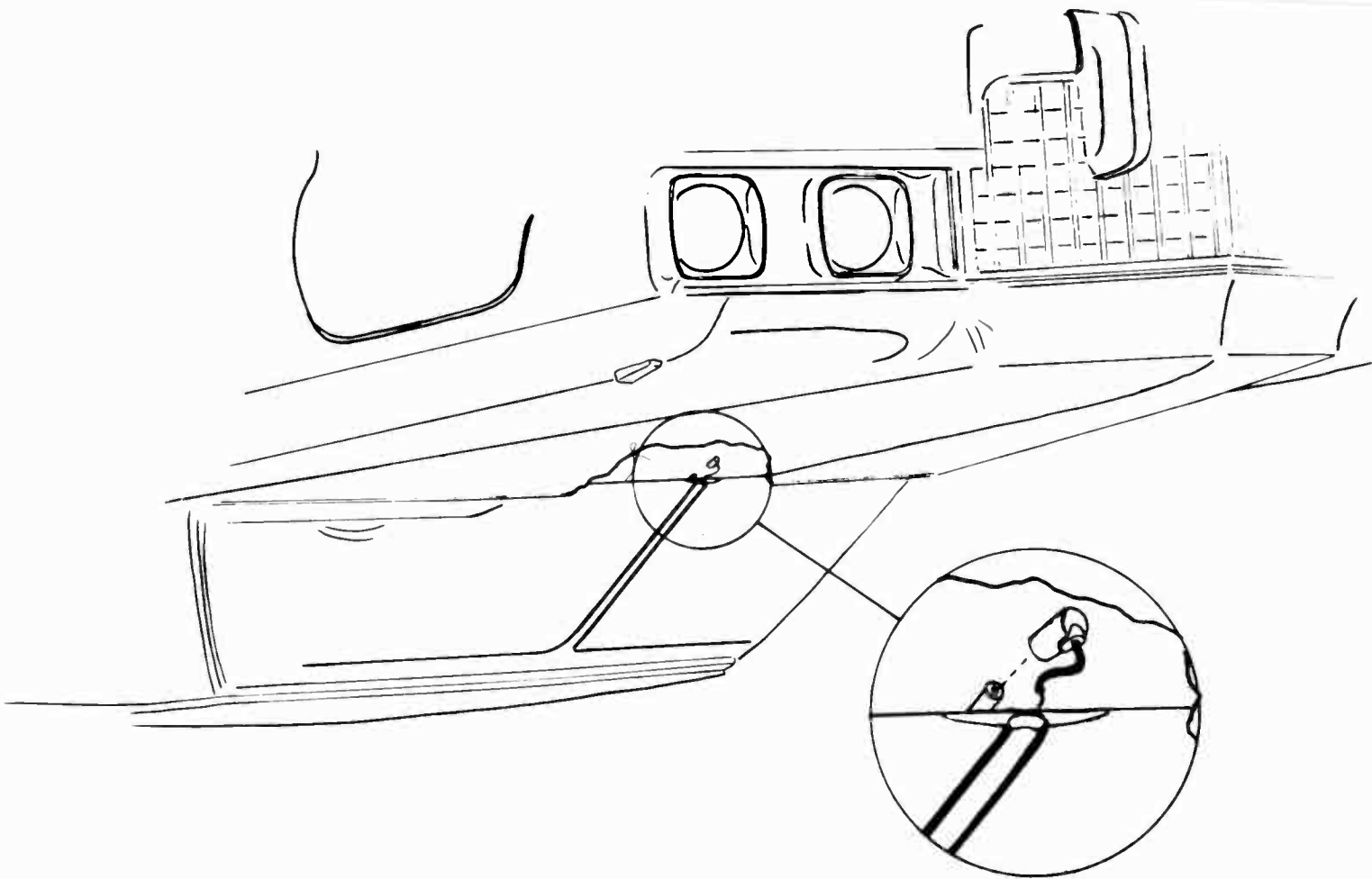

Fig. 11

Fig. 12



circuitry and can be expected to perform well over a long period of time, without mechanical damage or deterioration.

Early experience with the windshield antenna revealed some tendency of the windshield wipers to cause noisy radio reception, particularly when the radio was tuned to a weaker station. However, many 1971 cars have newly designed windshields which locate the antenna wires above and substantially out of reach of the sweep of the wiper blade so this effect, if any, is negligible. Additional design changes and modifications are being considered for those windshields which still show some wiper-swish effect.

For example, development work is continuing with flexible plastic windshield wiper blades as shown in Fig. 13. These insulating blades, of course, have no effect on radio reception as they pass back and forth across the windshield in the vicinity of the antenna. These wiper blades, however, will not be approved until tests, which currently are underway, have eliminated the possibility of the deterioration of the plastic by certain types of windshield washer fluids currently available to the motorist.

As we have gained added experience with windshield antennas in all parts of the United States, we have continued to make up-grading changes in the antenna-radio system. For example, we have adjusted the amount of signal that is fed into the first stage to provide adequate sensitivity and to prevent overload of the receiver. We have linearized the first RF amplifier to minimize detection in this transistor on strong signals. We have designed the IF amplifier and detector so the optimum tuning point does not vary over a wide range of signal inputs. We carefully control the length of the shielded antenna lead-in cable to more closely match the length for optimum FM reception.

There are, of course, other modifications to the antenna-radio system and we are continuing to make improvements in problem areas whenever they show up, and we are making these improvements just as rapidly as the state-of-the-art permits. In conclusion, may I again emphasize, that Delco Electronics is dedicated to manufacturing automotive radio systems which reproduce your broadcasts as faithfully as is technologically possible. The usual problems of handling rapid variations in FM signals under all conditions of the vehicle's location and speed require receivers of the highest quality, and we feel these problems are being solved. We are pleased, but not content with our progress. We will continue our programs to improve on our best efforts.

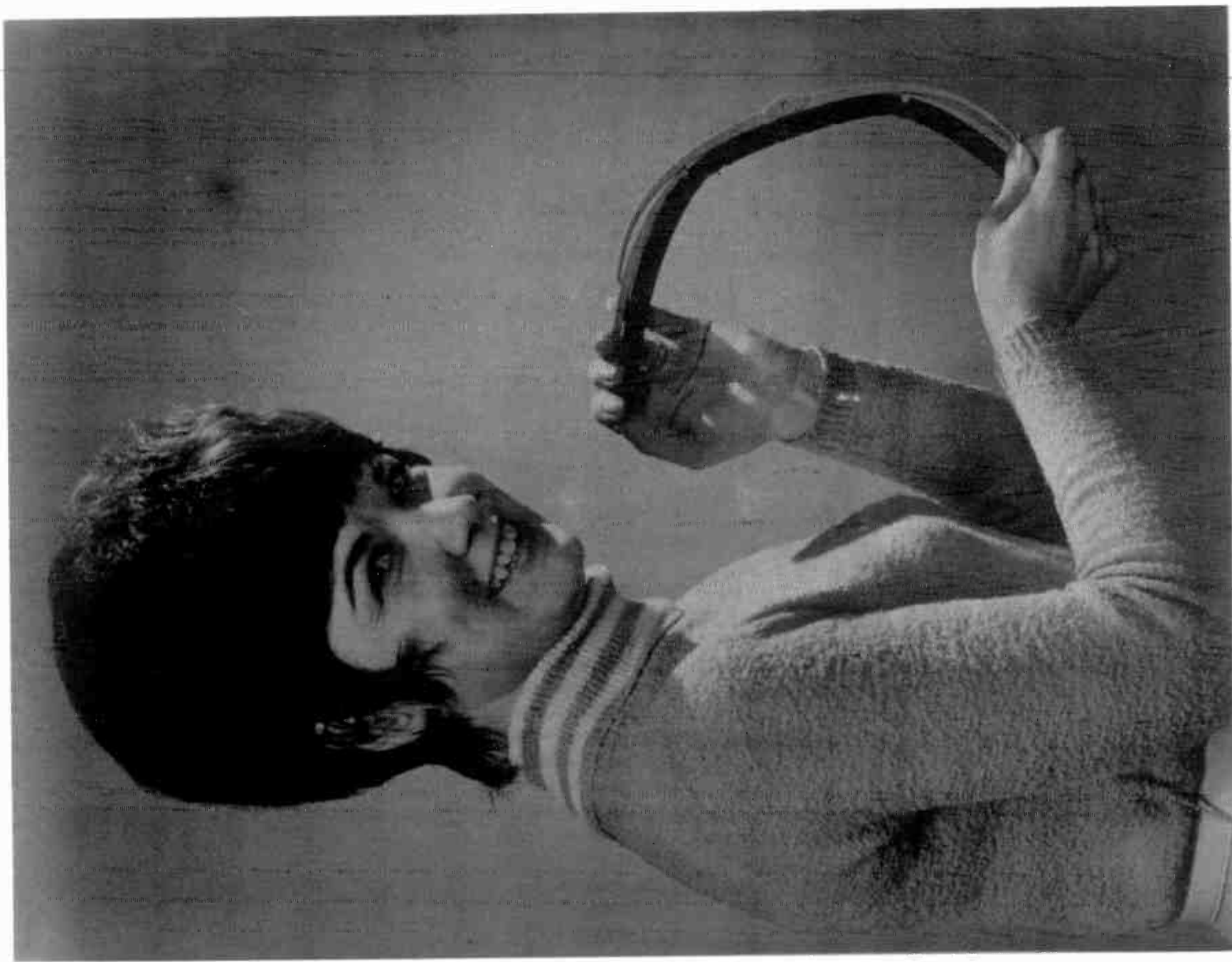

Fig. 13

Design & Construction of a Recording Console for Broadcast Production Facilities

Charles T. Morgan

WARM Radio, Wilkes-Barre/Scranton, Pa.

Most Susquehanna stations are equipped with three combination studio/control rooms; one of these is used for "on air" programming while the other two are used for recording of commercials, station promotions, agency work, etc. Although these recording or production studios can be used for "on air" operation, their primary function is that of a production studio. Traditionally, a broadcast console similar to that used in an "on air" studio is used for production; but, when building a new production studio for WARM, I decided to look to the recording industry for a console designed specifically for this purpose.

It appears as if the recording industry is years ahead of the broadcast industry as far as audio equipment is concerned. The use of ICs and operational amplifiers is widespread, and the quality and reliability are excellent. Most manufacturers use the module or building block approach, and one of these modules is shown in Fig. 1. This input module, 1 1/2 inches wide and 14 inches high, contains a microphone amplifier, a no-loss equalizer capable of giving complete control over both high and low frequencies, two line amplifiers, a rotary control for feeding the echo bus and a vertical slide-wire attenuator for controlling the overall gain of the module.

Stock consoles are available, but the smallest of these have four separate program outputs for feeding multiple track recorders. My next consideration was a custom

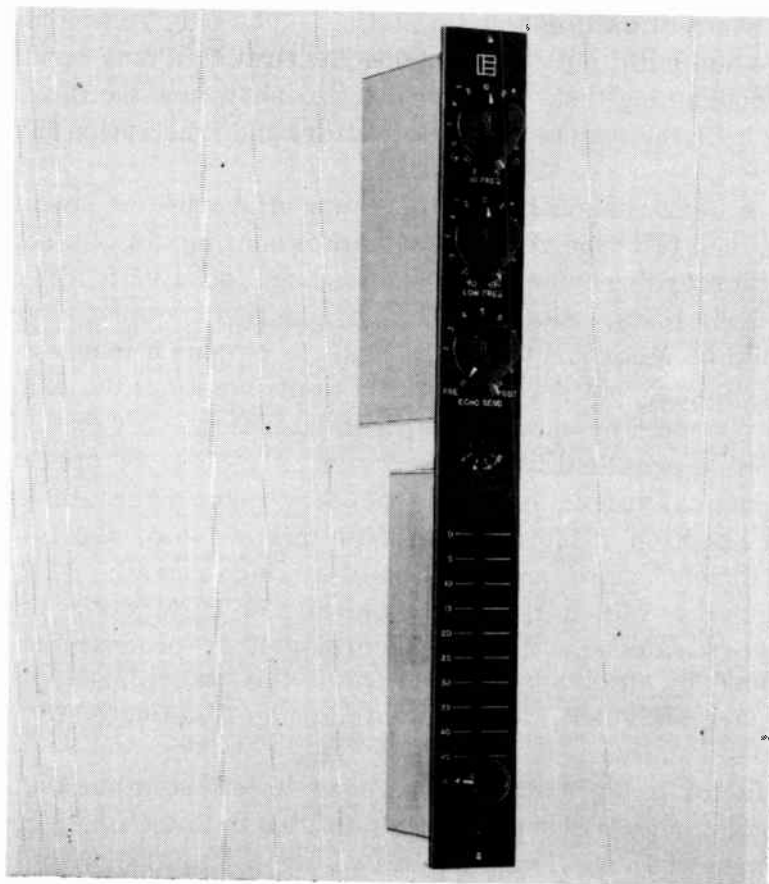

Fig. 1

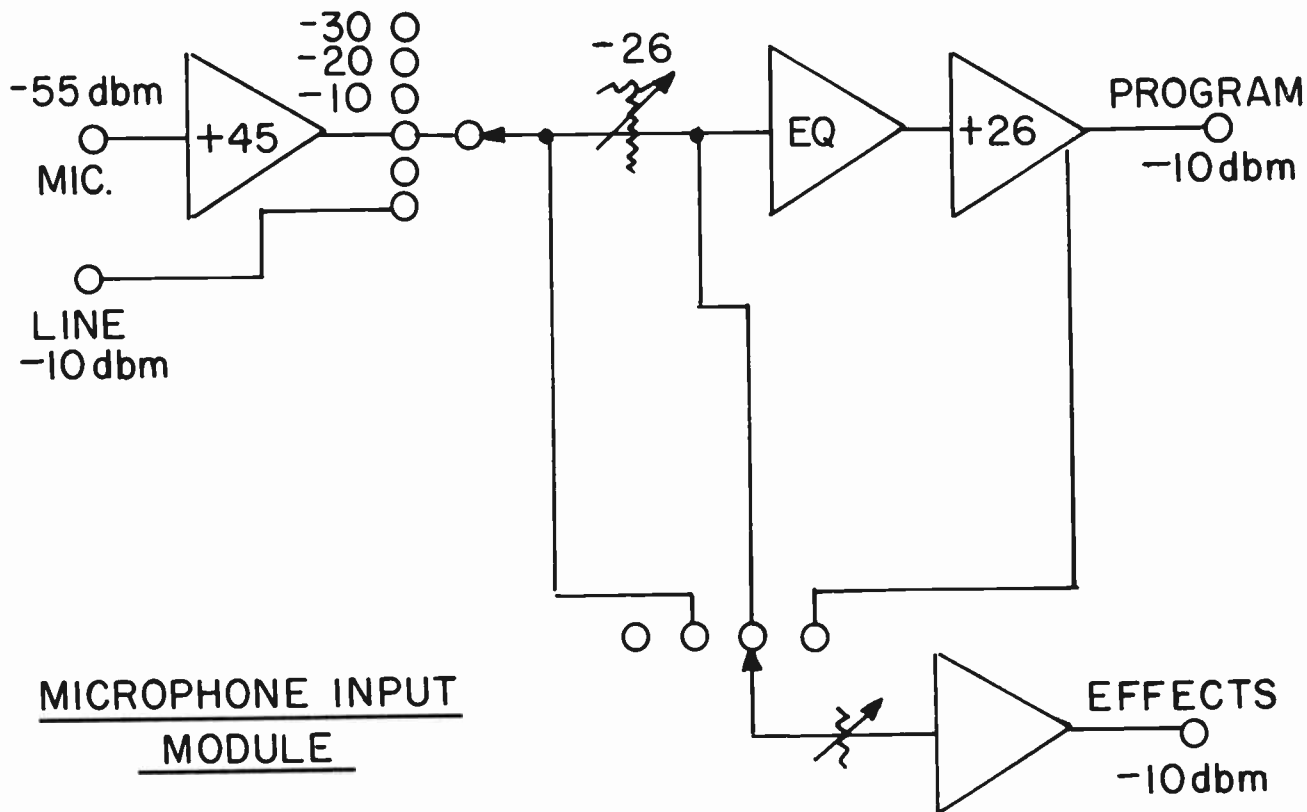

Fig. 2

console built to my specifications, but the engineering cost kept it above the price range that would make it practical for a radio station. The only remaining choice was to buy the modules and build my own console. At first this may appear to be a very tedious and time consuming task, but I will try to show how the module construction and high-level mixing reduce the time, effort and frustration involved in this type of project.

My input requirements were reasonably simple, two microphones, two turntables, two cartridge machines and two tape recorders. Additional inputs of a secondary nature were needed for recording from other studios, an "off air" feed, remote lines and regular telephone lines. Since this is a production console, equalization and reverberation should be incorporated in the console in such a manner that it can be applied to any of the inputs, but not necessarily to all inputs at the same time.

This console is to be operated by announcers, not engineers. My experience indicates these people can be excellent board operators only when the operation can be reduced to purely mechanical action; only then can they react mechanically and concentrate on the creative portion of their work. With this in mind, there should be no patching, no cross connection or preselection of mixing channels. For example, if Turntable 1 is connected to Mixer 3, it should always be on Mixer 3, and no switching should be incorporated that could connect any other program source to this input. This same philosophy applies to all portions of the console, and whenever any of the special features are activated, an indicator light is illuminated to alert the operator.

The most important factor in the design of this console is that it has the capability of expanding or undergoing major changes to keep in step with the ever-changing requirements of a broadcast station. This capability goes a long way when trying to justify the cost for any piece of equipment.

Most manufacturers offer similar modules, but Electrodyne was chosen because they offered a wider variety of modules, the simplest of which is a straight-forward high-level input without a microphone amplifier or equalizer. This module is, of course, lower priced, but it contains everything necessary to meet the requirements for the high-level inputs of this console.

INPUT MODULES

The microphone input module is shown schematically in Fig. 2. The microphone preamplifier has a gain of 45 db, and a switch is provided to bypass this amplifier if it is desired to use it as a high-level input. Other positions of this switch are used to reduce the preamplifier gain by as much as 30 db in order to accommodate higher microphone output levels. The output of this preamplifier is connected to the vertical or straight-line attenuator. This is an Altex slide wire "T" network with an audio taper and adjustable in steps of .1 db. The attenuator is followed by a line amplifier with a gain of 26 db, which is sufficient to make up for the loss in the attenuator when it is in a normal operating position. A second amplifier is used to feed what is generally referred to as the ECHO bus. A rotary gain control and a coaxially mounted switch connects this amplifier to various points within the module. In the PRE-position the two attenuators function separately, each controlling the gain of its respective amplifier. In the POST 1 or POST 2 position, the pickoff point for the echo amplifier is either before or after equalization, with the vertical attenuator controlling the gain of both amplifiers.

The high-level inputs are quite similar to the low-level inputs as shown in Fig. 3. The only difference is that preamplification and equalization are not provided, and a cue position is added to the vertical attenuators. An important feature of these modules is that no gain or loss is involved; whatever level is present at the input appears at both outputs when the attenuator is in the normal operating position. The maximum output level of these modules is plus 18 dbm.

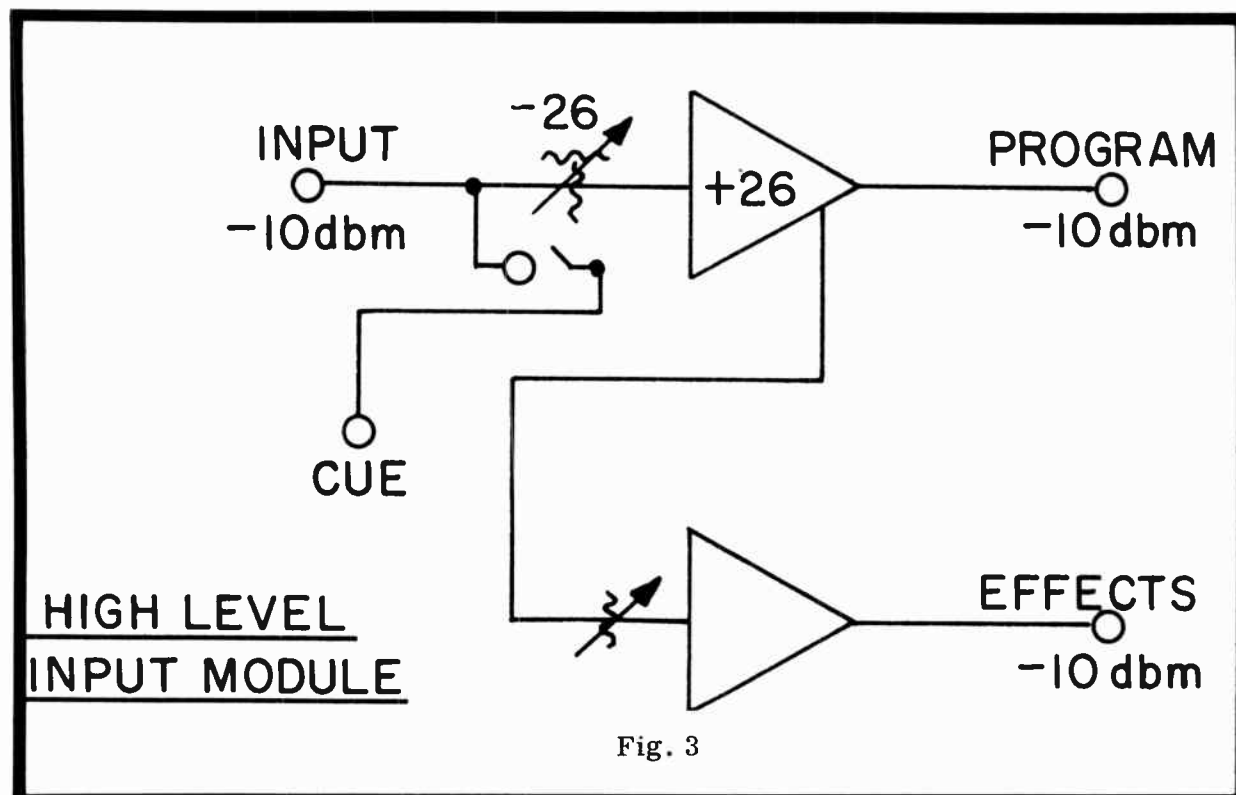

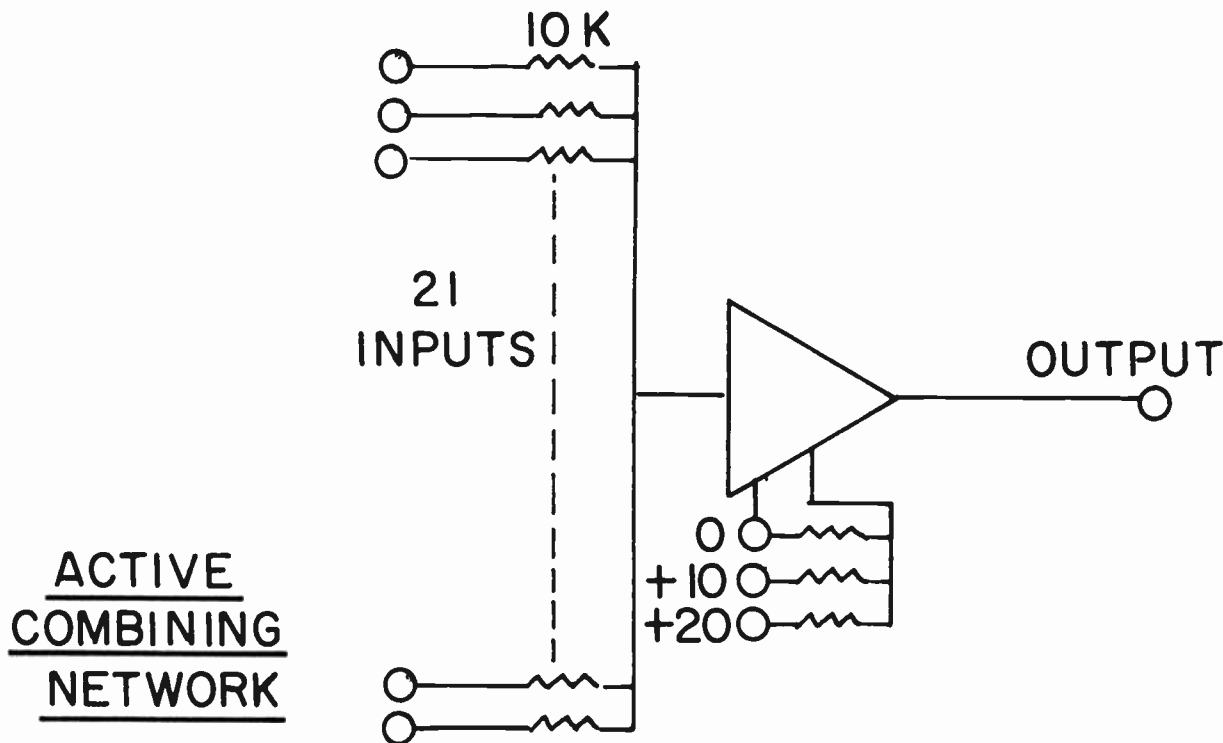

Fig. 4

The ECHO BUS, or what I choose to call the EFFECTS BUS, is used in normal recording consoles to route a portion of the audio from an input module through an echo or reverberation system and then recombine it with the normal or straight-through audio. By this means the proper amount of reverberant sound may be added and adjusted at will during a recording session. In my console I have expanded this slightly to add to the console's versatility and produce other special effects, thus the term "effects bus." Each module has two separate output amplifiers which, through the switching system, feed the program and effects mixing channels.

ACTIVE COMBINING NETWORKS (ACN)

The mixing system uses Active Combining Networks (ACN) that combine up to 21 inputs without loss. This combining network, shown in Fig. 4, utilizes an IC operational amplifier connected in the inverting mode. One of the characteristics of this configuration is a very low driving point impedance; and, when coupled with any two of the 10K input resistors, form a "T" pad which provides over 70 db of isolation between these inputs. These input resistors act as high-impedance bridge circuits and may be connected to the low impedance output of the modules without affecting either the module or the mixing bus. Since this is a bridging circuit, no back loading or make-before-break switches are required.

The gain of the amplifier is adjustable from unity to plus 10 or plus 20 db by strapping the proper resistor at the socket of the ACN. The bridging resistors are located inside the ACN housing; therefore, all wiring associated with the mixing circuit will be at line level.

EQUALIZATION

Three separate equalizers are used in this console. Two are built into the microphone input modules, and the third is controlled by an external switch that connects it to either the program or effects channel.

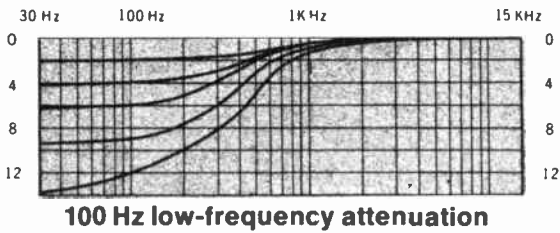

Fig. 5

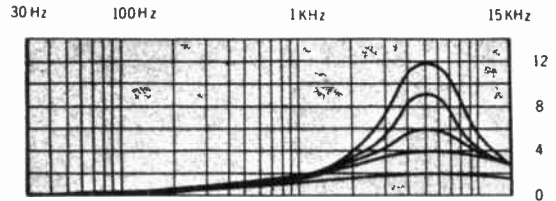

Fig. 6

Three separate equalizers are used in this console. Two are built into the microphone input modules, and the third is controlled by an external switch that connects it to either the program or effects channel. This equalizer utilizes the same IC amplifier used in the other modules and, like the other modules, has no insertion loss. Low-frequency boost is selectable at 40, 100, or 300 Hz, and is switchable in steps of 2, 4, 6, 9 and 12 db. Low-frequency attenuation is also available in these same steps.

Fig. 5 shows the low-frequency attenuation curves when the selector switch is set at the 100-Hz position, and a separate curve is drawn for each setting of the low-frequency control. These curves are typical of the family of curves representing either attenuation or boost at the various positions of the low-frequency equalization selector.



Fig. 7

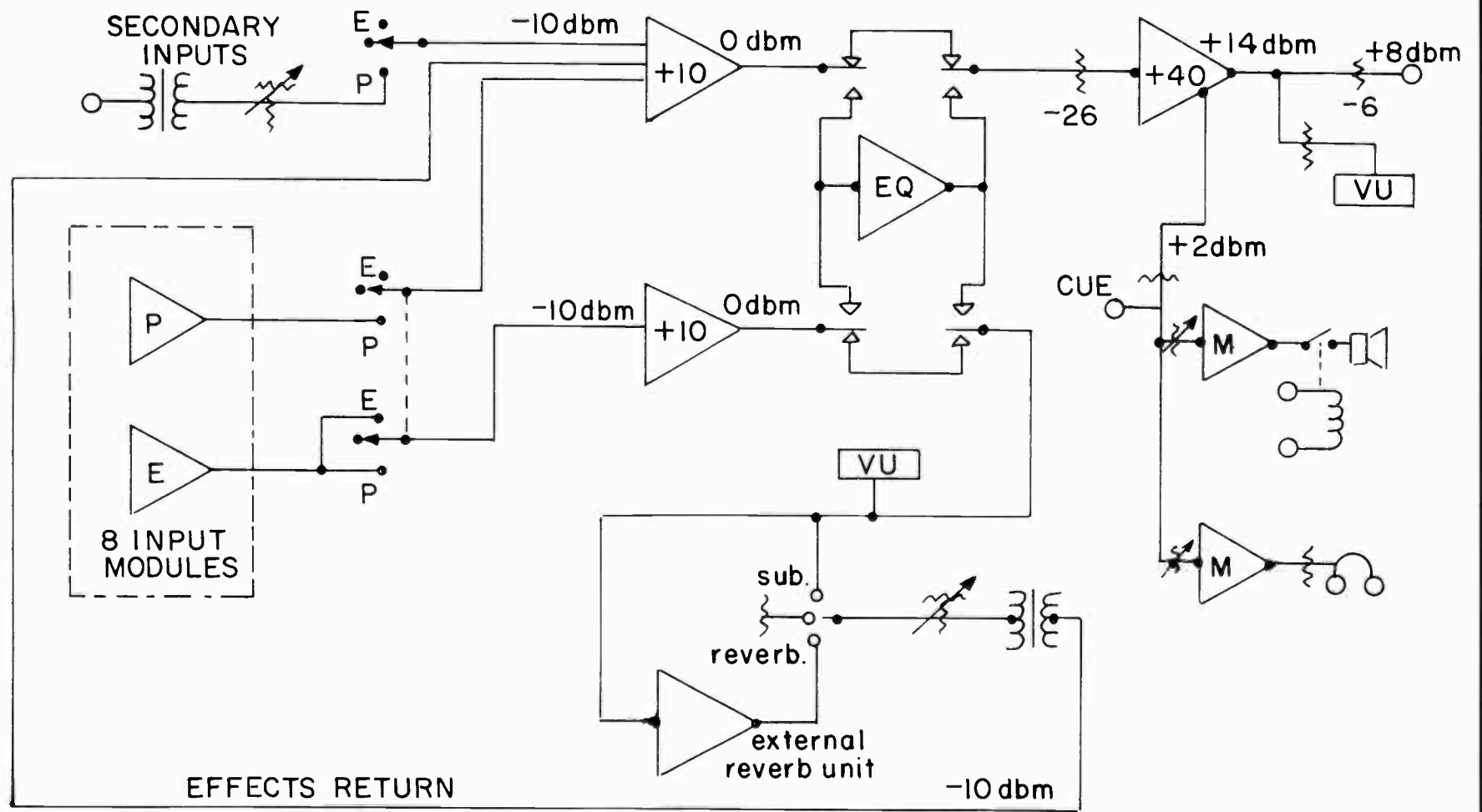

Fig. 8

WARM PRODUCTION CONSOLE

Fig. 6 shows the high frequency peaking at minus 5 kHz, and again a separate curve is shown for each step of the rotary switch, in this case, the high frequency control. Center frequencies of 1.5, 3, 5 and 10 kHz are selectable with the degree of boost and attenuation adjustable by the rotary step control.

Fig. 7 shows this equalizer and the switch used to place it in the circuit. The light associated with the lever switch is illuminated when the equalizer is connected in either the Program or the Effects channel. The lower control governs the low frequencies; attenuation is accomplished by turning counterclockwise and boost by turning clockwise. The frequency selector switch is coaxially mounted on the rotary control. The upper control handles the high frequencies in the same manner, offering independent control of both ends of the spectrum at the same time. All controls are completely silent and may be adjusted during a recording. Identical equalizers are used in the microphone modules.

THE PROGRAM CHANNEL

A block diagram of the entire console is shown in Fig. 8. A total of 8 input modules (two microphones and 6 high-level) are used and the output of the program and effects amplifier in each are connected to the appropriate ACN through key switches. When these key switches are placed in the down position, both the program and effects outputs are connected to the appropriate ACN, but when the switch is placed in the up position, only the effects output is operative. The output of the cue switches on all the high level modules are tied together in a common cue bus; this is necessary to provide the automatic override feature of the cue/monitor system.

The system is setup so that all line level signals entering the console are at approximately -10 dbm for normal operation, and any signal sources of higher level are padded down before entering the console. Since the input modules have unity gain with the mixing attenuators in a normal operating position, the normal output of both the program and effects amplifier is -10 dbm. This corresponds closely with the normal output level of the microphone channels and is well below the maximum output level of plus 18 dbm.

Both ACNs are strapped for a gain of 10 db which produces a normal operating level of 0 dbm at the ACN output. This is the recommended operating level for the best signal-to-noise ratio, while at the same time maintaining 18 db of headroom between normal and maximum operating levels.

The output of the program ACN is connected to the 26 db pad at the input of the line amplifier through the normally-closed contacts of the equalizer switch. The equalizer can be placed in the circuit at this point and used to control the overall frequency response of the program channel. Since this equalizer has unity gain and a maximum operating level of plus 18 dbm, it can be switched in and out of the circuit at will.

The line amplifier is also an integrated-circuit device which can be strapped at the socket to provide between 40 and 55 db of gain. Input and output transformers are located within the module, and the maximum output level is plus 30 dbm into 600 ohms. The gain of this amplifier is set for 40 db which, when coupled with the 26 db loss of the input pad, produces a normal output level of plus 14 dbm. A 6 db pad is used for isolation between the amplifier and the console output terminals, resulting in an output level of plus 8 dbm for normal operation. The VU meter and associated pad are connected to the output of the line amplifier and 0 VU corresponds to plus 8 dbm. These pads are located at the line amplifier socket in order to prevent running the lower level input and plus 14 dbm output throughout the console. The line amplifier has a second output for feeding the monitoring system which is isolated from the first and designed to work into a 600-ohm load. The level at this output is 12 db below the main output and, in this case, would be plus 2 dbm.

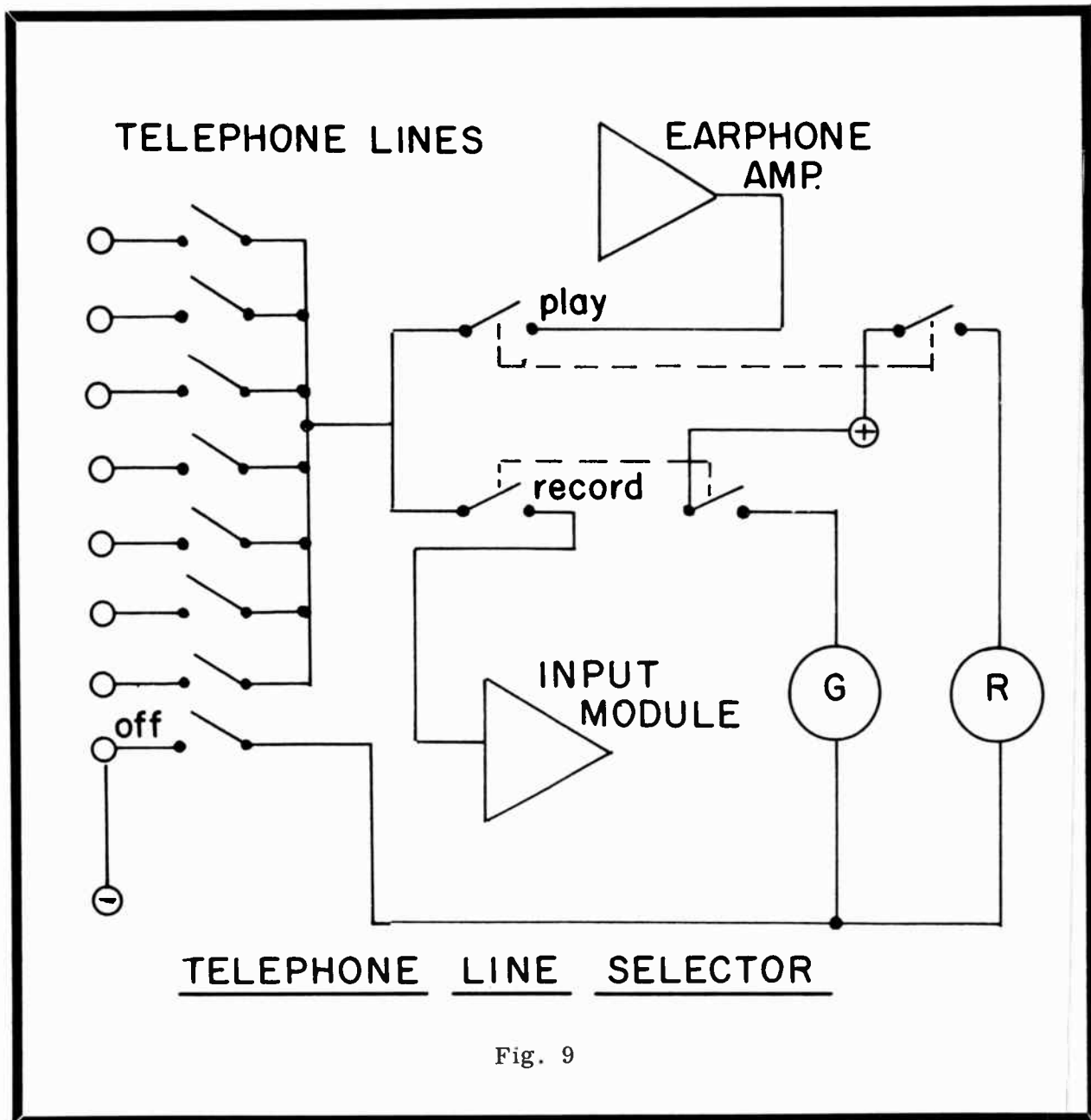

Fig. 9

It may seem, by looking at Fig. 8 that all audio wiring, with the exception of the microphone and output line, is at -10 dbm or 0 dbm. This is considerably different than the typical broadcast console, using conventional mixing at levels of -40 to -50 dbm. A switching click that would be objectional with a -50 dbm signal may be inaudible at -10 dbm. Crosstalk between wires with level differences of 10 db is far less of a problem than if the levels differed by 50 db.

THE EFFECTS CHANNEL

The output of the Effects ACN is connected to the equalizer bypass switch, and the equalizer can be switched into the effects channel in the same manner as explained for the program channel.

In order for the effects channel to become operative, it must be returned to the program channel; this is accomplished through the Effects Return switch. When this switch is in the Sub-Master position, the effects channel can be used as a sub-master channel with or without equalization. When in the Reverb position, an external re-

verberation unit is switched into the effects channel; and, with this arrangement, it is possible to alter the quality of the reverberant portion of the sound to create a variety of effects. The level of the effects return path is controlled by the variable "T" pad and connected to one of the program ACN inputs through an isolation transformer. Since both ACNs produce phase inversion, an isolation transformer is required in order to return the signal to the Program ACN in the proper phase.

For normal operation the input switches are placed in the down position which connects that input through the program channel to the line output. This switch also closes the circuit to the Effects channel. With the Effects Return switch in the Reverb position, the desired amount of reverberant sound is added to the straight-through audio at the Program ACN. If you want more reverb on one input than another, for example, heavy reverb on music with a lesser amount on voice, this balance is adjusted by the Echo Send controls on the individual module.

If it is desired to produce a commercial using several program sources while providing equalization for only one of these sources, say a turntable, all key switches except the one requiring equalization are placed in the down (program) position and their echo send controls turned down. The turntable switch is placed in the up position which connects this module to only the effects channel. With the equalizer connected in the effects channel and the Effects Return switch placed in the sub-master position, the turntable audio is combined with the program channel after equalization. This same system can be used with or without equalization to control the level of a number of inputs at the same time; that is, use the effects return control as a

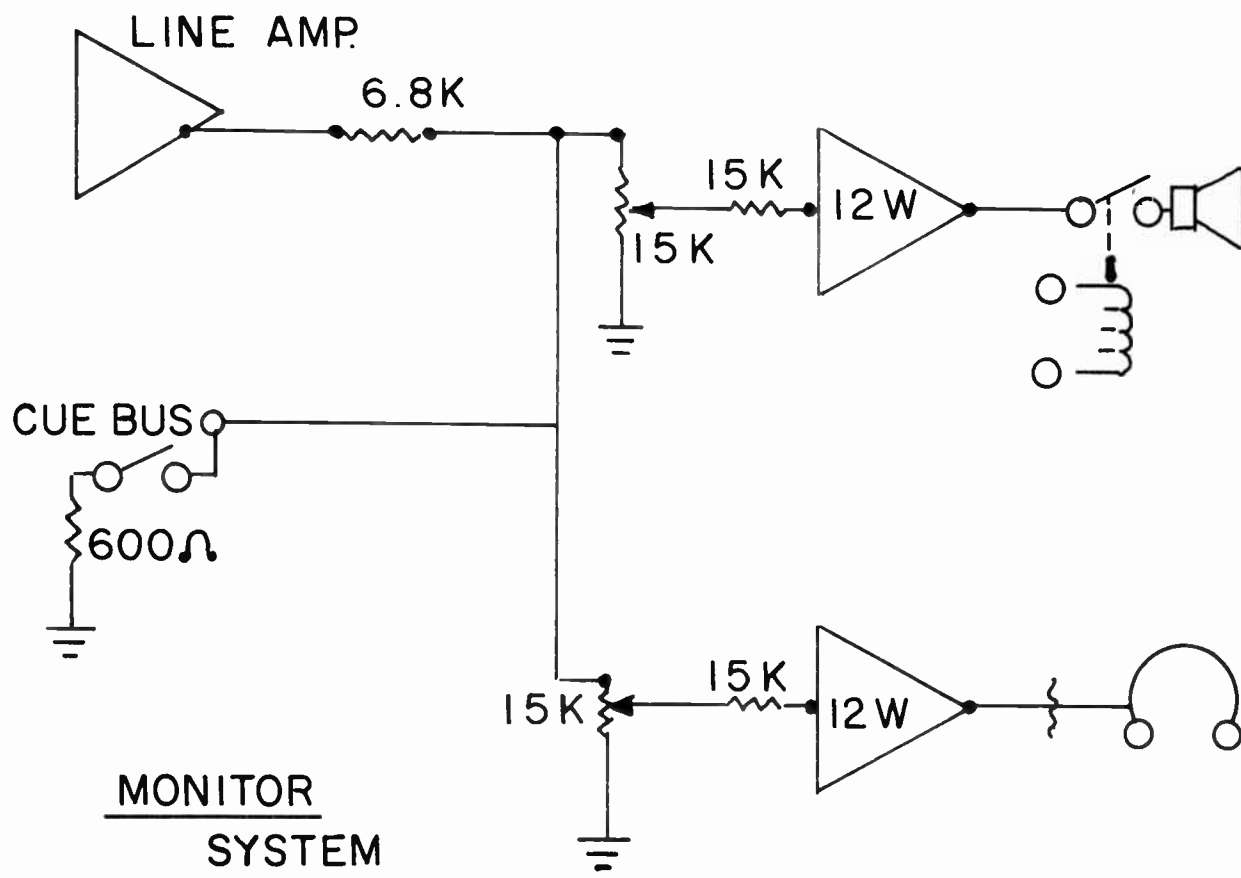

Fig. 10

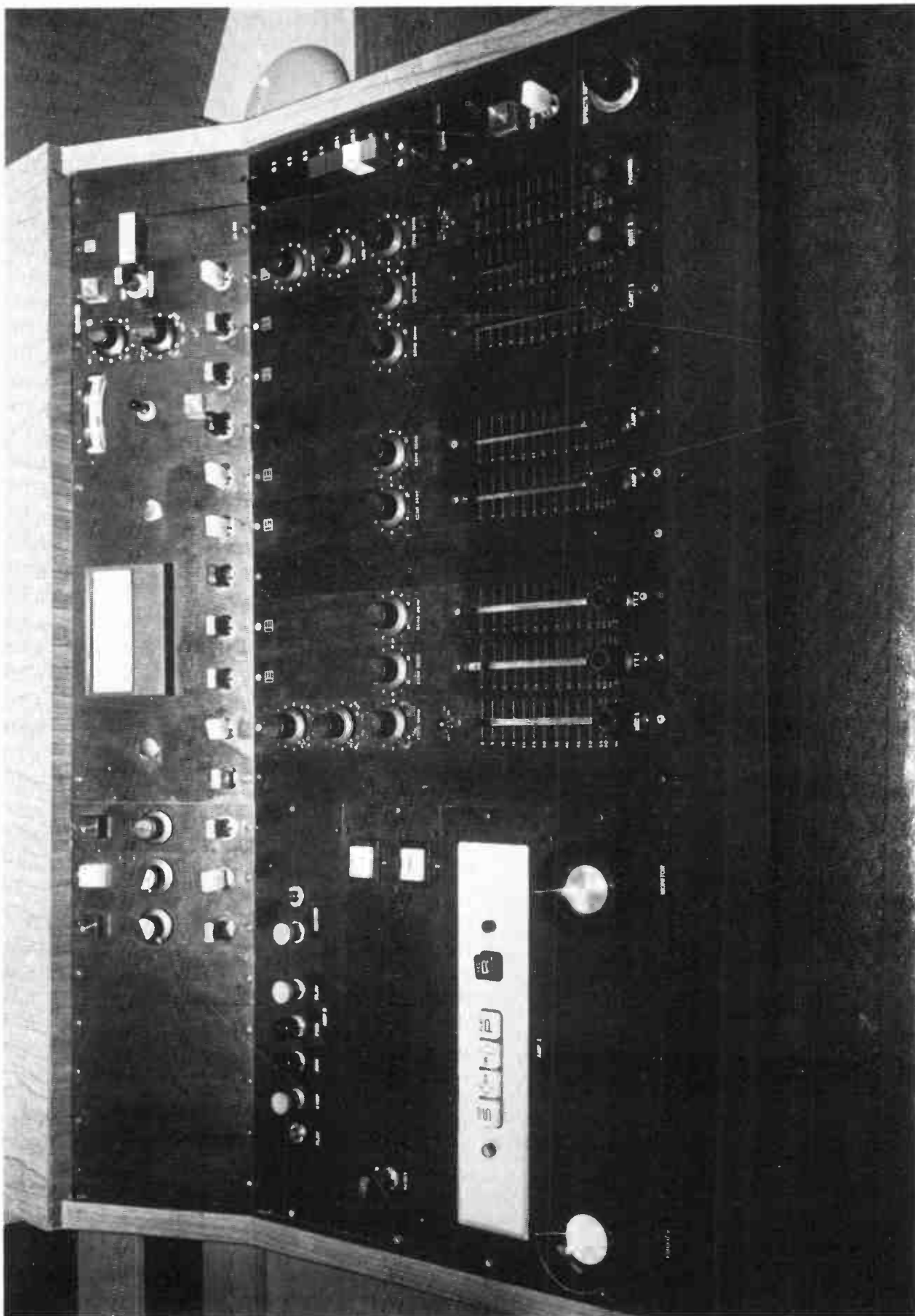

Fig. 11

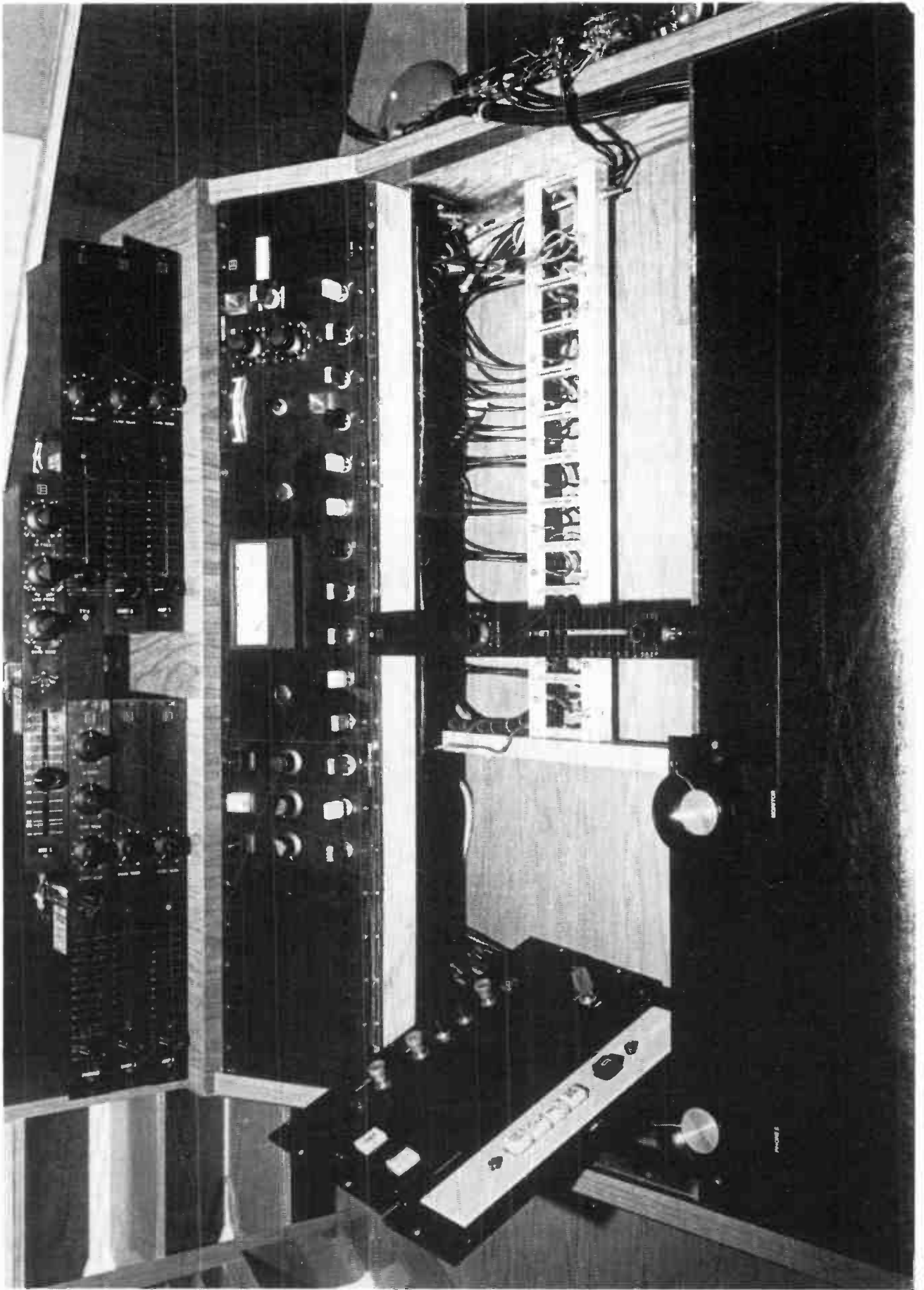

Fig. 12

sub-master attenuator. An edgewise VU meter is connected in the effects channel in order to preset levels. The ACNs can handle up to 21 inputs, and some of these are used for secondary program sources, such as an air monitor, portable recorders or pickups from other studios.

TELEPHONE LINE SELECTOR

In any radio station there is always a necessity to record from or play into a standard telephone line. This is particularly true in a production studio where it is often necessary to play a recorded commercial over the telephone for a client in order to receive his approval. The second microphone would be the least used of the eight input modules on this console; therefore, it was decided to have it double as the telephone line input. The equalizer incorporated in this module is of great help in improving the quality of the signal received from these telephone lines. Recording is accomplished by simply switching the input selector on the module to line (Fig. 9); and, with the telephone selector switch in the record position, selecting the desired telephone line. The output of the earphone amplifier is connected to the telephone line through the play button for sending a signal out on a line. Panel lights are used to indicate that the telephone system is operative and is in either the record or play mode.

MONITOR SYSTEM

The monitoring system (Fig. 10) consists of two integrated circuit 12-watt monitor amplifiers; one is used for feeding the control room speaker and the other is for headphones. The program input to these monitors is fed directly from the isolated output of the line amplifier with no intervening switch; the monitor is always across the output of the console.

In this monitor system I have incorporated an automatic cue device. When any of the mixing attenuators are dropped to the cue position, they are connected through the cue bus to the high side of the monitor gain controls. This low-impedance upsets the voltage dividing network, causing a larger portion of the signal at the program input of the monitor to be dropped across the 6.8K resistor, resulting in a reduction of normal monitor level when any of the attenuators are placed in the cue position. Normal programming is reduced below the point where it would interfere with the cueing process, but at a level that can still be heard. This automatic cue system works with both the speaker and earphone amplifiers.

CONSTRUCTION

The entire console, shown in Fig. 11, is housed in a wooden cabinet 36 inches wide, 36 inches deep and slants upward to 10 inches in height at the rear. A soft leather arm rest is used at the front of the console. The entire face of the console consists of 3/16-inch thick sections of black anodized brushed aluminum. Each and every section can be removed, replaced or moved from one section of the console to another. This ability to change or replace small sections of the console is ideal for making future changes or additions. The left-hand portion of the console is used for remote control of tape recorders, cartridge machines and various other control functions. The two knobs at the lower left of the console are the monitor and earphone level controls; like the other portions of the console, these sections can be altered or moved around to suit the changing requirements of a broadcast station.

Fig. 12 shows the console with all but one of the input modules removed and illus-

trates the ease with which service or modification is accomplished. The module sockets are mounted on two pieces of aluminum angle iron; and, although only 8 modules are used, the console is completely wired for 10 input modules. The additional modules may be added by simply removing the blank panel and inserting the new module. The 24-volt power supply is located within the supporting desk directly below the console. One of the important factors in constructing this type of console is that the power supply buses for all active components must have a very low resistance in order to prevent crosstalk, degeneration and ground loops. For this reason the two aluminum angle irons used to mount the module sockets also service the power supply buses.

Indicator lights are used throughout the console and are illuminated when any of the special features, telephone lines, effects, reverb or secondary inputs are activated. When none of the lights are on, the console functions as a normal straight-forward console. These indicator lights allow the console to be used in the conventional manner without fear of unwanted equalization or special effects.

The cost of this console, including housing, blank panels, components, equalizers, switching, etc., with the exception of the labor involved, is approximately the same as the cost of a normal good quality broadcast console without these extra features. The real savings in constructing a console such as this is that it will not become outmoded. The high quality of the components, the flexibility and the expansion capabilities insure that this type console will meet your exact requirements today, and your exact requirements 10 years from today—no matter how different they may be.

Care & Treatment of Ailing Directional Antennas

John H. Battison
Carl E. Smith Consulting Radio Engineers,
Cleveland, Ohio

It is not my purpose in this talk to cover points of normal maintenance. It is naturally assumed that you have a good and well organized maintenance program. So, what we might call routine operational problems should be covered by your normal maintenance schedule. However, it might be well to add at this point, if you don't have a well thoughtout maintenance schedule, make one up as soon as you get back to your stations.

Within recent years the FCC has shown an ever-growing amount of interest in directional antenna operations. New stations going on the air are finding an increased concentration on the part of the Commission in obtaining concrete proof of absolute adherence to the theoretical directional antenna patterns. Existing stations, when their licenses come up for renewal, are quite frequently subjected to unpleasant shocks. Examination by the Commission's renewal branch engineers often discloses that the operating logs for the composite week indicate that the directional antenna system has been operating outside its licensed parameters!

Some of the older established stations are also finding that they are being required to update directional antenna proofs which may have been made 20 years ago or more. Many of these have not been reproofed since the original license was issued. In some cases, the Commission's requirements are satisfied by an explanation of the discrepancies on the operating logs. In others, a skeleton or partial proof is the only thing that will satisfy the Commission's engineers.

Major problems are frequently encountered in reproofing directional arrays that were installed 20 years ago or more. Many of the original measuring points along the radials have been built over, or are rendered useless by the proximity of buildings or overhead lines. Many times, too, monitoring points that have become old and trusted friends over the years are found to be at the very least misleading, if not down right untruthful. Where conditions around the monitoring points have changed over the years, the monitoring points are often still within the license limits. Yet when the radial is run and analyzed, the inverse fields are higher than the MEOV!

In a situation like this, the only solution is major surgery in the form of the selection of new monitor points. If this is done, it will probably also entail making a series of new nondirectional measurements, utilizing the new measuring points along the radials, plus, of course, a skeleton proof.

In this connection, one of the rather unusual problems that can arise when making a partial proof or reproof of an older station is what happens when the number of towers used in one of its patterns has been changed since the original proof. A case like this may, perhaps, entail two different sets of radials—one for each pattern.

As a case in point, one of our client stations, which originally had a 5-tower in-line array, used in a DA-2 configuration, added a 6th tower to be used in the daytime pattern only. The reworked configuration used tower 6 and towers 1 and 2 of the original array which then formed the daytime antenna system.

The original proof of performance radials were drawn from the center (No. 3 tower) and were thus good for day and night measurement purposes. When the daytime array was modified, new radials were required from the center of the daytime array.

The nighttime pattern was still referenced to the No. 3 tower, and because of the spacing between this tower and the new No. 6, it was necessary to maintain two separate sets of radials, one each for the day and night patterns. The array was adjusted to that all the night-time monitor points were within the license specifications, and the radials were run. Practically all of the points on the original radials were found to be useless because of the intrusion of overhead lines, and new construction, which in some cases completely obliterated the old points.

It was necessary to pick new regular and alternate monitor points, and also to select new points along the radials to complete the proof-of-performance. Even though not required by the FCC, the licensee could probably have saved money by having the chief engineer make a skeleton proof from time to time, thus he would have been prepared to cope with the deteriorated radial conditions.

PAPER PROBLEMS

Some of the problems experienced by the broadcaster in connection with his antenna system are simply the results of inadequate and careless log keeping on the part of his operators. The Commission will usually accept phase monitor readings within 4° and plus or minus 5% of the current ratios as specified in the license, except, of course, for those unfortunate licensees who have tolerances of plus or minus 1° and plus or minus 1%.

Careless logging, which represents phase angles to be consistently outside the 4° tolerance, and/or base current ratios that are consistently outside the tolerances allowed by the license, and for which no corrective action appears to have been taken (according to the log or the maintenance entries), almost always result in a requirement for a skeleton proof-of-performance. A number of these cases have come to our attention recently in which DA adjustment and/or partial proofs were required. In some cases it was quite apparent that had proper attention been paid to log keeping during the preceding years, a costly (and license renewal delaying) proof-of-performance would not have been required. In fact, it has recently become rather apparent that much of the consulting engineer's work is frequently due to carelessness and inattention to detail on the part of log keepers, and the people whose job it is to insure that proper log entries are made. On the other hand, such items as widely varying phase and current ratios on a particular tower are usually indicative of changes in either the power supplied to the tower or the phase monitor system.

If varying ratios or remote base currents are indicated for a specific tower and the parameters for the other towers in the array are normal, an immediate inspection should be made of all the elements in the transmission line system. Starting at the phasor, all connections should be checked for tightness and, if practical, the line condition should be checked for intermittent shorts or open circuits due to faulty soldered connections, etc. In one such case the varying base current was traced to worn out and dirty contacts in the pattern changing relay at the tower base. When the relay was replaced, the base current returned to normal.

Shortly after, the same tower began to exhibit random variations on the phase monitor. This particular trouble was eventually traced to an intermittent connection in the sampling loop on the tower. From ground level observation the loop had appeared sound, and it was not until a close-up physical check was made that its condition was discovered.

It is quite possible that a careless and disinterested operator would have been content to go along repeating the anticipated or normally expected phase monitor readings. Unless the erratic phase monitor readings occurred during the time that

parameters were being recorded or logged, these variations could have gone unnoticed, although this should not have occurred!

MONITOR POINTS

When a construction permit for a directional array is issued, certain monitor points are specified. These values show the maximum radiation that is permitted at these points. Normally, a licensee is required to measure and record these values once every seven days. A monitor point that is consistently high, in the absence of unusual circumstances, such as extreme cold conditions and which are acknowledged to increase conductivity, can usually be taken as an indication of a misadjustment in the directional antenna system. Always assuming, of course, that nothing has occurred in the vicinity of the monitor point to account for the consistently high readings. Great changes have taken place in local construction and power line installations in most areas in recent years. It is, therefore, a very wise precaution to select alternate monitoring points and obtain the Commission's approval to log and use these in addition to the regular points to demonstrate that the array is properly adjusted.

The use of alternate monitor points also serves a double purpose. Local conditions can cause a change in a regular monitoring point reading that might indicate excessive radiation. But if the alternate monitoring point does not also indicate excessive radiation, the increase may be due to a purely local condition. This may prevent an inexperienced operator from attempting to readjust an array that is already operating properly!

Discussion of monitoring points brings up a topic which has become of increasing concern to engineers who are required to maintain directional antenna systems. It has finally been accepted in engineering circles that cold weather produces an increase in ground conductivity in many parts of the country. Thus, a monitor point which has been running happily within 1 mv/m of its limit throughout the Spring, Summer and early Fall, may begin to run perhaps 1 to 10 mv over its limit with the onset of Winter conditions, when the ground freezes. This, of course, is a problem that is normally experienced only in the northern part of the United States, and generally is not found in Florida!

However, inspection of the station's operating logs may lead to a citation, and perhaps a monetary forfeiture, if monitor points consistently run above their limits and no efforts have been made to account for this phenomenon.

One precaution which can be taken to prevent problems of this nature requires the making of a series of measurements along the radial, or radials, involved—if possible, at the same points at which the original proof-of-performance measurements were made. The new figures should be plotted on log-log paper and re-analyzed. Frequently, it will be found that a new, higher, conductivity curve will fit these new figures, and that the inverse field measured at 1 mile remains within the MEOV. This is an indication that the radiated power is within the licensed parameters, and that the increase at the monitoring point is due to an increase in conductivity.

If the foregoing is the case, the correct step is to record all the information and file an application requesting a modification of license to specify a higher monitor point value during Winter months. If interference considerations permit, a relaxation of the MEOV and a permanent increase in monitor point limits may also be requested.

PHASOR ROCKING

A technique that is employed to return a wandering directional antenna system to its licensed parameters is "phasor rocking." This is not a project to be undertaken lightly, and without making the proper preparations. It must also be done carefully if it is to be useful; this means it is time consuming. Carried to its ultimate conclusion, it involves the stationing of personnel equipped with field measuring sets and mobile radio equipment at each of the points to be monitored. After each change is made in a phasor setting, the fields measured at the monitor points are reported by radio to the engineer performing the adjustment. These values are then recorded in the appropriate columns against the specific adjustment.

It is, of course, necessary to request an authorization from the Commission to operate with parameters at variance from the licensed values for a period of time to cover the proposed tests. Until the Commission has authorized this operation, it is essential that no departures from the licensed parameters are made!

If an operating bridge is available, it should be connected at the common point to ensure that abnormal departures from the licensed common point impedance, and hence current, do not occur. Normally, small variations in the common point impedance will be noted, and can be recorded as the phasor controls are rocked. But unless any very wide variations are noticed, which would indicate a very bad misadjustment of the phasor, these readings are not too important at this time. Of course, if a new set of phasor control settings is obtained, it will be necessary to measure and correct the common point impedance as required.

A good way to proceed with the phasor control rocking, is to vary the controls systematically in turn, commencing with the magnitude control for tower 1 and advancing it about three quarters of a turn clockwise. All phase monitor readings are then recorded with the reported reports of monitor point readings. The actual change in phasor settings will depend on individual preference and condition. The No. 1 tower magnitude control is then retarded one and one half turns counterclockwise from its last setting, so that it is actually three quarters of a turn counterclockwise from the original setting. Again, all phase monitor point readings are recorded. This magnitude control is now returned to its original setting and all readings should be the same as they were prior to the first movement of this control.

Next, the phase control of No. 1 tower is moved in a similar manner, as are all the other controls in turn. When the exercise has been completed, the result should be tabulated. Analysis of these results should show that specific adjustments to certain towers will cause changes in the desired direction in monitor point readings and phase monitor readings. It is usually possible to determine from this tabulation which way the phasor controls should be moved to obtain the desired results. I must emphasize, however, that it is absolutely essential to record the phasor settings before any knob is turned and to keep an accurate and concise record of every adjustment made. If you don't do this, you are liable to end up with an array that is completely out of adjustment!

DA-NDA SWITCHING

Many of the directional stations that have been constructed in recent years embody control circuitry that makes it possible, in the case of a DA-N station, to switch from nondirectional to directional operation and vice versa by pushing a button. In the case of DA-2 stations, although more complicated, it is frequently possible

to switch from each pattern to a nondirectional and back again by means of push-buttons. If any of you are contemplating the construction of a new antenna system, or an updating or modification of an existing one, I would strongly recommend that you include this facility. It doesn't cost a great deal of money, and the convenience that it provides is priceless. As a matter of fact, there have been strong suggestions that the Commission will, before too long, require that this facility be embodied in all directional antenna systems. I firmly believe, not only from an engineer's view point, but also from the point of view of management (whose interest lies in preserving continuity of signal pattern during DA measurements) that it is a very worthwhile addition to any antenna system.

The DA-NDA system that I have described above speeds up every kind of measurement operation. It is possible to go to any measuring point once only, and to read any antenna pattern value at that point in the course of two or three minutes. These readings are made under identical weather and field strength meter orientation and adjustment conditions. I might add, in connection with NDA readings, that when questionable readings are noted at a monitor point, or when trouble in a DA operation is suspected, nondirectional readings taken at the monitor point and ratioed to the directional readings give a very good indication of an antenna's performance and condition.

An item that is frequently overlooked, because its operation is normally trouble-free and consistent, is the phase monitor system. We are not going to talk about the instrument itself, but we will talk about the connections between the instrument and the antenna system. If you have inherited a directional antenna system whose installation details are not very familiar to you, you would be well advised to become familiar with every detail of the installation, not forgetting the location where the excess sampling lines are stored.

As we are all aware, it is necessary that all sampling lines have the same electrical length. This means that the line length is controlled by the distance to the furthest tower. The towers that are closer to the location of the phase monitor will have lines of the same length, but the excess line will have to be stored somewhere. It is an axiom of the FCC, and good engineering practice, that all excess line lengths be stored in such a way that equal lengths of all of the lines are subjected to the same climatic and temperature conditions. If this is not the case, the expansion or contraction of unequal lengths of line will cause a plus or minus change in the phases indicated on the phase monitor. If you experience changes of this type under extremes of weather condition, be prepared to check the location of the excess phase monitor sampling line.

TRANSVERSE RADIALS

Sometimes in the adjustment of a directional antenna, an unwanted null or an unwanted lobe may appear. It frequently happens when the monitor points have failed to show that the antenna is not correctly adjusted. That is, the monitor points are within the FCC limits. But when a skeleton proof of radials is run, it is sometimes found that the inverse fields along these radials are higher than one would expect from the monitor point values. Or, of course, the points could be a great deal lower than the licensed monitor point values, and this again would be a cause for suspicion.

If an unwanted lobe or null is suspected, running a transverse or cross radial will frequently show up the unwanted effect. The technique of making a transverse radial is a little different from running a regular radial.

In the case of a transverse radial, it is a good idea to select an arc or radius of a suitable value, perhaps two miles, and draw this arc with a radius covering the

whole of the area under suspicion. In one case, we had four radials with an arc at a radius of about 1.9 miles crossing all four. Good measuring points were picked at intervals of about 1/10th of a mile, or less, along this arc and a series of measurements made.

These measurements were plotted on linear paper with the azimuth plotted in degrees along the abscissa, and the field strength in millivolts along the ordinate. The licensed pattern called for a null at 277° . To our surprise, we found the null to be at 287° !

The transverse radial could, of course, be run as a straight line in any desired direction. Then the distance from the antenna would vary for each point, and a third variable would be introduced into the problems. Use of a transverse radial is not very common in normal directional antenna work, nor is it required or even desired by the FCC. However, it is a tool that can be very useful at times.

In concluding these notes on directional antenna problems, I might re-emphasize that many of the problems that station engineers encounter can be prevented by proper maintenance. It seems to be an obvious thing, but you would be surprised at the number of times we encounter DA problems which are directly traceable to what I like to call "agricultural laziness!"

The antenna field should be kept clear of all brush type vegetation, and grass and weeds should be kept cut to a low level. Within the area around the tower base screens, the crushed rock—and only crushed rock should be used there—must be kept clear of weeds and vegetation. Weed killer applied here at regular intervals is very useful. One of the surest ways of encouraging varying DA meter readings, is to allow high brush growth in this area. One station that we inspected had a wild grape vine securely wrapped around the RF lead from the tuning house to the antenna base. Luckily we found it before the "Grapes of Wrath" of the FCC descended on the station.

The Use of Ferrite Combiners for Parallel Operation of AM Transmitters

Paul Gregg

Bauer Transmitting Products,

Mgr. Sparta Electronics Corp., Sacramento, Calif.

In Europe, the operation of broadcast transmitters (AM-FM or TV) in parallel has been an accepted practice for years. Not hampered by some of the operator requirements that we have here in the United States, parallel operation was the obvious answer to unattended operation in areas where technical help was limited. Having a "working" standby guaranteed a continuous signal even when one of the transmitters was in trouble. In this country, parallel operation of TV and FM transmitters began as a convenient means to achieve higher powers with available equipment. In AM the accepted practice has been to have a "standby" transmitter, which for economy reasons, usually is a lower power model than the main and is only operated when called upon. Station accountants usually frown on such investments since it involves a capital expenditure that is not always "at work." The program department will complain if the "emergency" signal is inferior to the normal or if any dead air exists while the switch is made. And they have a good point, for in this day of heavy competition you cannot afford to have dead air and the consequential loss of listeners. You can make up the lost spots but it is hard to get those listeners back. This paper describes a unique system of combining the output of two equal power AM transmitters using modern ferrite techniques.

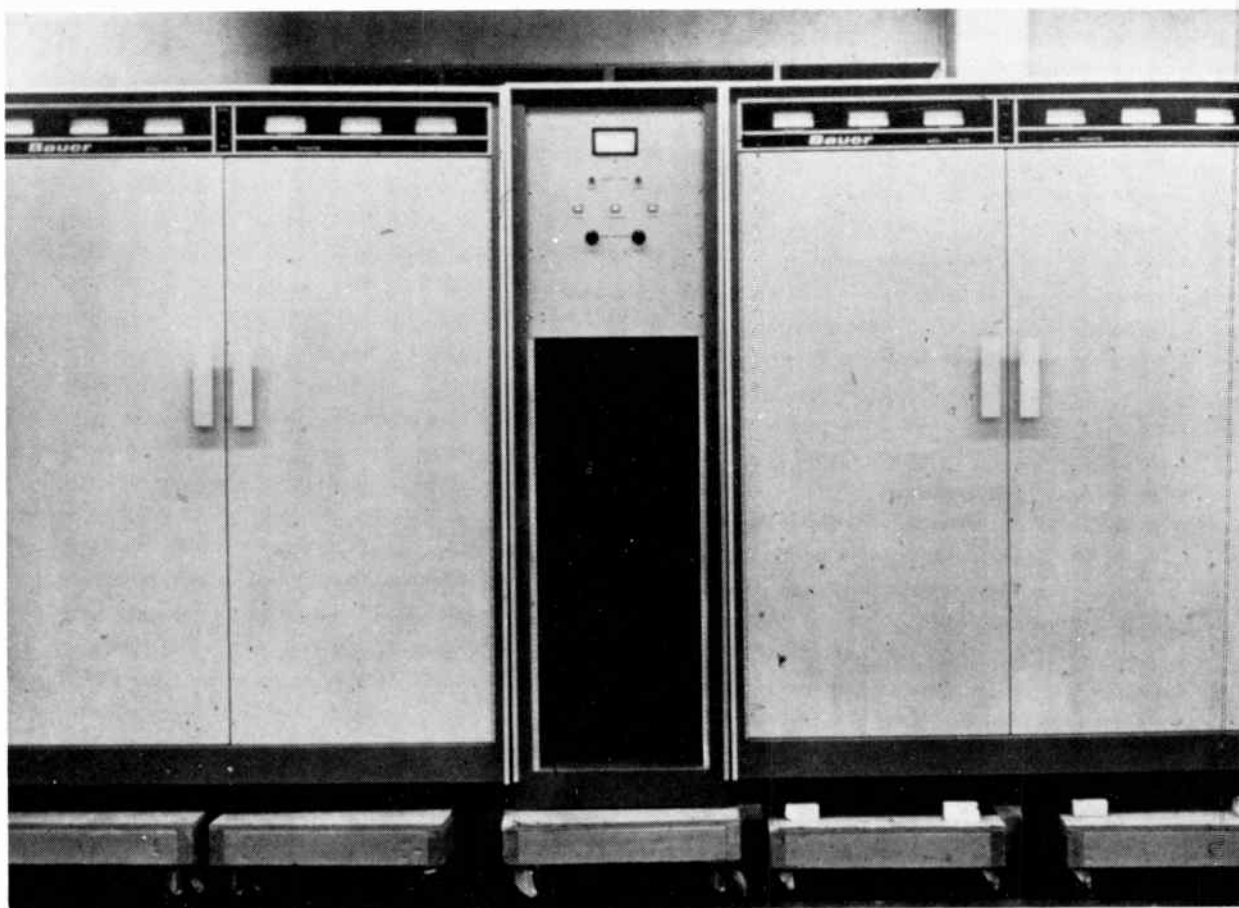

Fig. 1

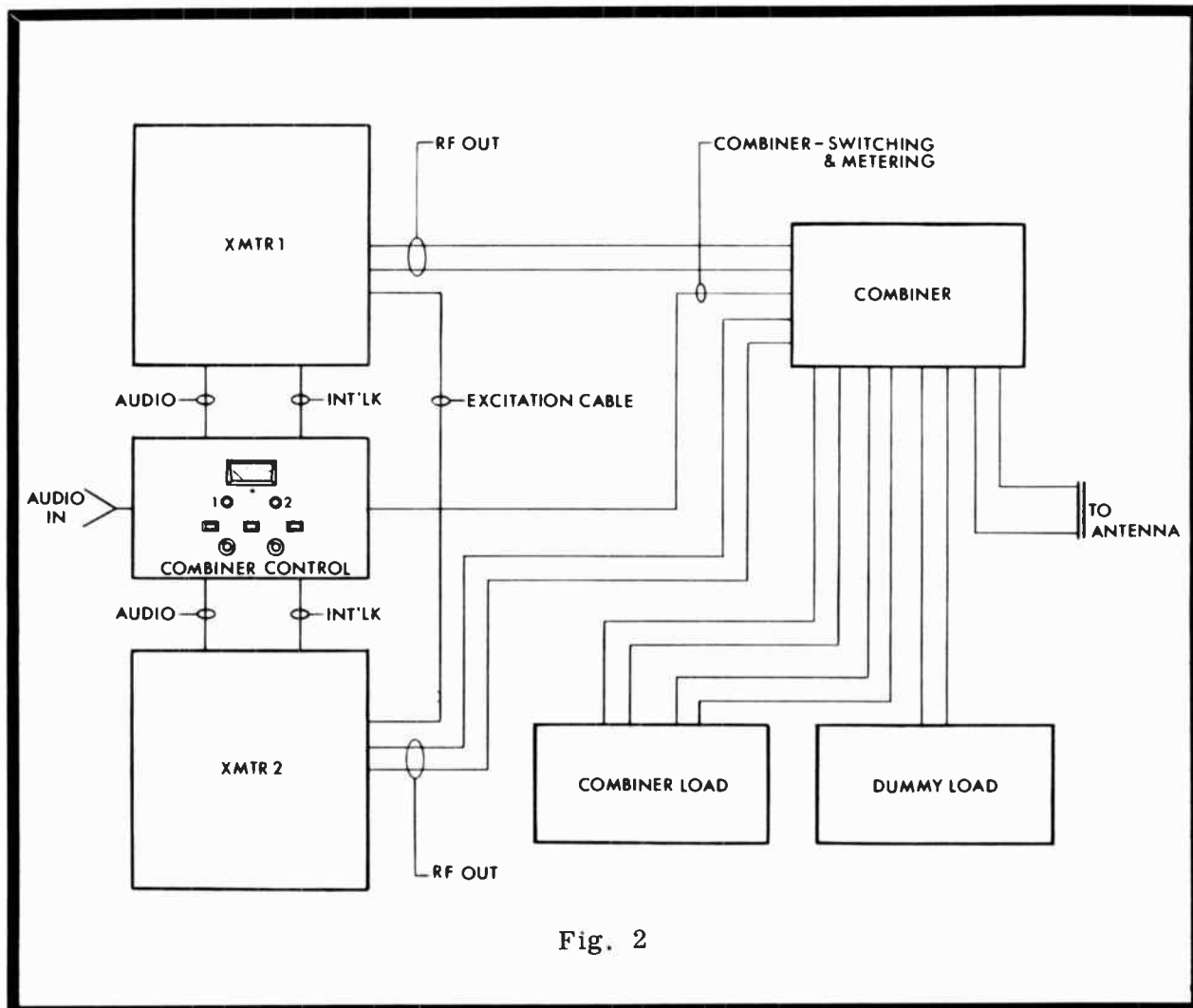

Fig. 2

Fig. 1 illustrates a Bauer Model 725 transmitter in operation at 25,000-watt WRNG in Atlanta. It consists of two Model FM-15A 15-KW transmitters being operated at 12,500 watts each, a combiner control panel and the ferrite combiner (Fig. 1). The power output of this combination is 25 KW, a fairly rare power level in this country. The only other choice available to WRNG was a 50-KW transmitter operating at half power. This represented a higher initial investment and lacked the desirable "built-in standby" feature. A block diagram of the WRNG Radio system is shown in Fig. 2. Incoming audio is combined in a hybrid transformer. Only one oscillator is used to drive both transmitters and the combination is made by tying the two buffer stages together. The oscillator in transmitter #2 becomes a spare and could be pressed into service if necessary.

The combiner control panel (Fig. 3) is the heart of the system. The meter indicates the power in the combiner load and thus indicates the phase and amplitude adjustment of the two transmitters. The switches supplied permit instant selection of either transmitter, either into the system dummy load or into the combined mode. Audio feed to the two transmitters is split from a single source with a hybrid transformer and individual controls permit modulator balance.

The combiner is housed in a rectangular aluminum box (Fig. 4) and is weatherproof to permit either indoor or outdoor mounting. It measures 19" x 15" x 10 1/2" high. Input and output connections are standard 1 5/8" EIA female. The internal cooling system consists of the natural convection of transformer oil. Approximately 24 gallons are used in this unit which is hermetically sealed at the factory.

Fig. 5 schematically illustrates the combiner circuitry. T1 and T2 are wideband transformers and utilize tumbled ferrite core material. The relays are all of the ceramic vacuum type. R1, the combiner load and the dummy load are made up of ohmweve resistor elements and are external to the combiner. Notice that there are six ports in all: J1 and J2 are transmitter inputs; J3, the output to the antenna; J4 and J5 connect each leg of the system to the combiner load, and J6 connects to the system dummy load. As shown, both transmitters are in the combined mode and if their phase and amplitude are equal there will be zero voltage across R1. This is monitored continuously the combiner load voltage meter located on the control panel. Phase control can be accomplished by tuning the driver plate control of one transmitter power output by a motor-driven output coupling control. These are not critical adjustments and daily attention in not required. Should one transmitter fail, the

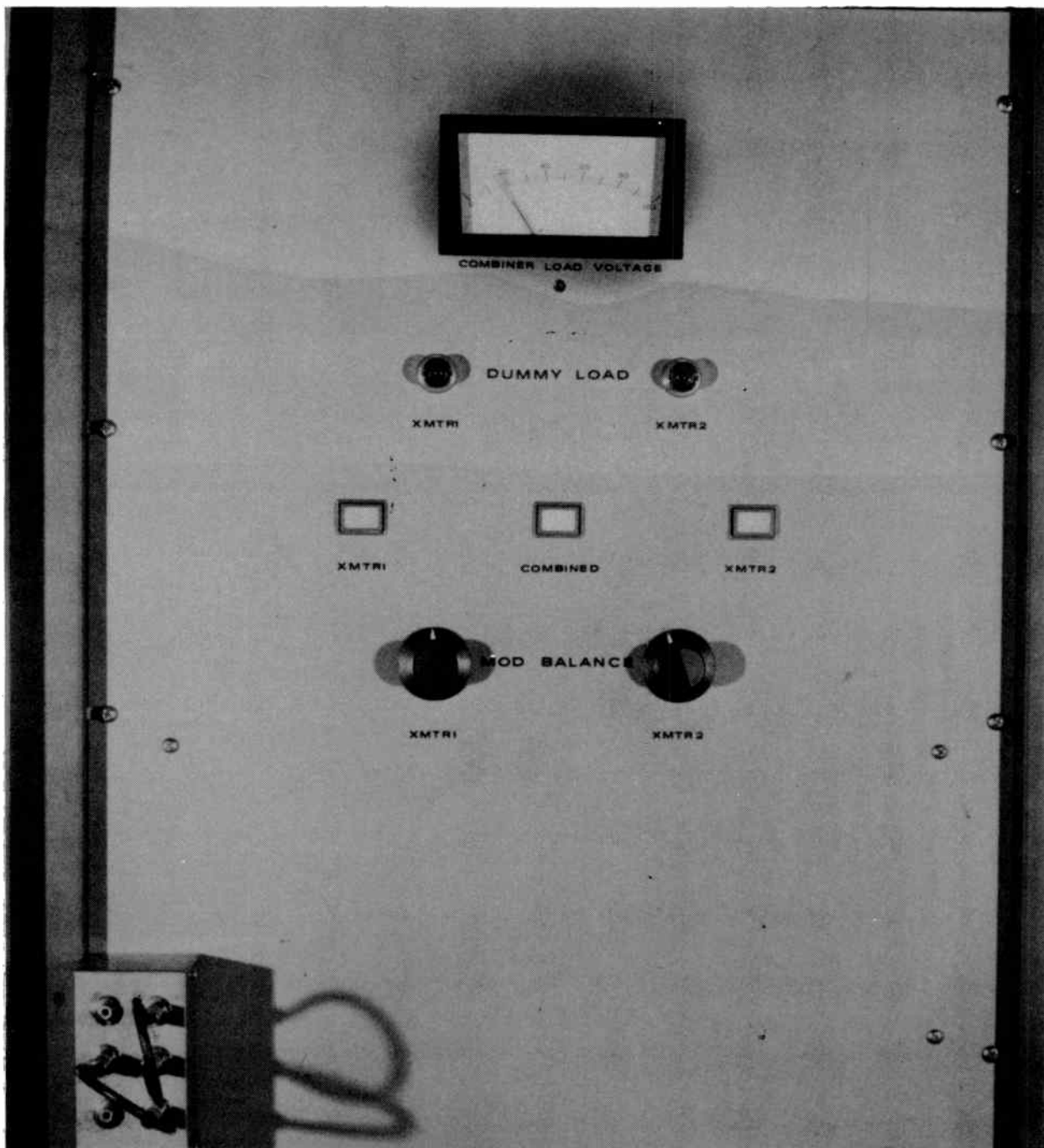

Fig. 3

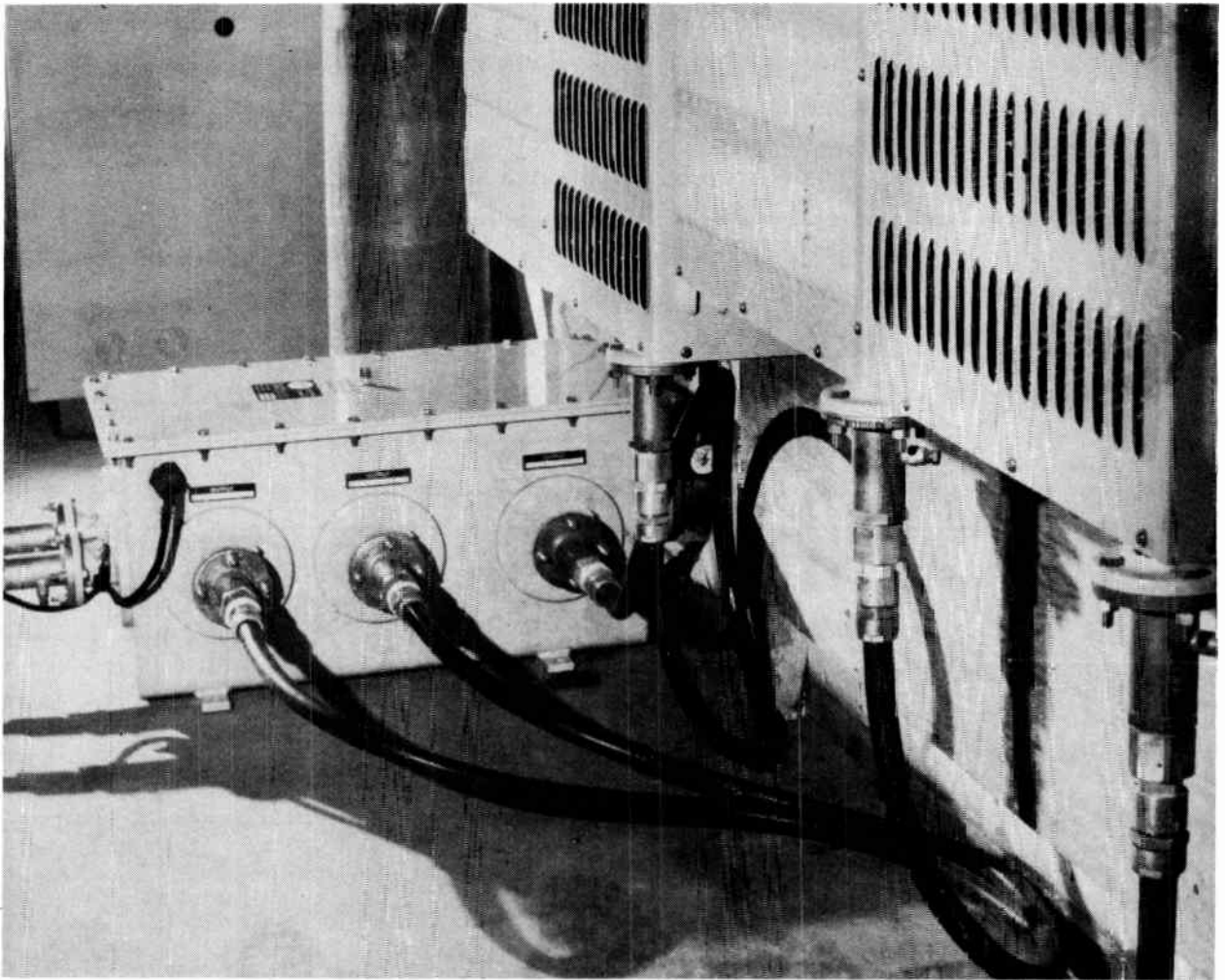

Fig. 4

combiner load (R1) will absorb half of the power from the working transmitter and the actual power to the antenna will decrease 6 db. By switching the "working" transmitter directly to the antenna, the power to the antenna is reduced to only 3 db and the problem transmitter is connected to the dummy load for troubleshooting. If desired, this switching could be automatic. By proper selection of R1, the load seen by either transmitter in a non-combined condition is equal to that when they are in combination. Extended operation in a non-combined mode would not be harmful to any of the components involved. A further refinement could include an alarm system that could monitor the voltage across R1 and thus alert the operator of potential transmitter problems. Let us review the advantages of combined operation.

- a) A "working" standby—maximum use of capital equipment.
- b) Greater operation flexibility.
- c) Achievement of higher power with individual units of convenient size.
- d) A continuity of service—no on-air interruptions.
and those advantages of a ferrite combiner—
 - a) Small size
 - b) Low maintenance

With the combination of the simple ferrite combiner approach and some newly available transmitter powers, it is now possible to reach the standard operating levels used for AM transmission in the United States—two 2.5 KW transmitters for a 5 KW operation; two 5 KW units for 10 KW and two 12.5 KW transmitters for 25 KW. For full reliability, the parallel or combined system is the answer.

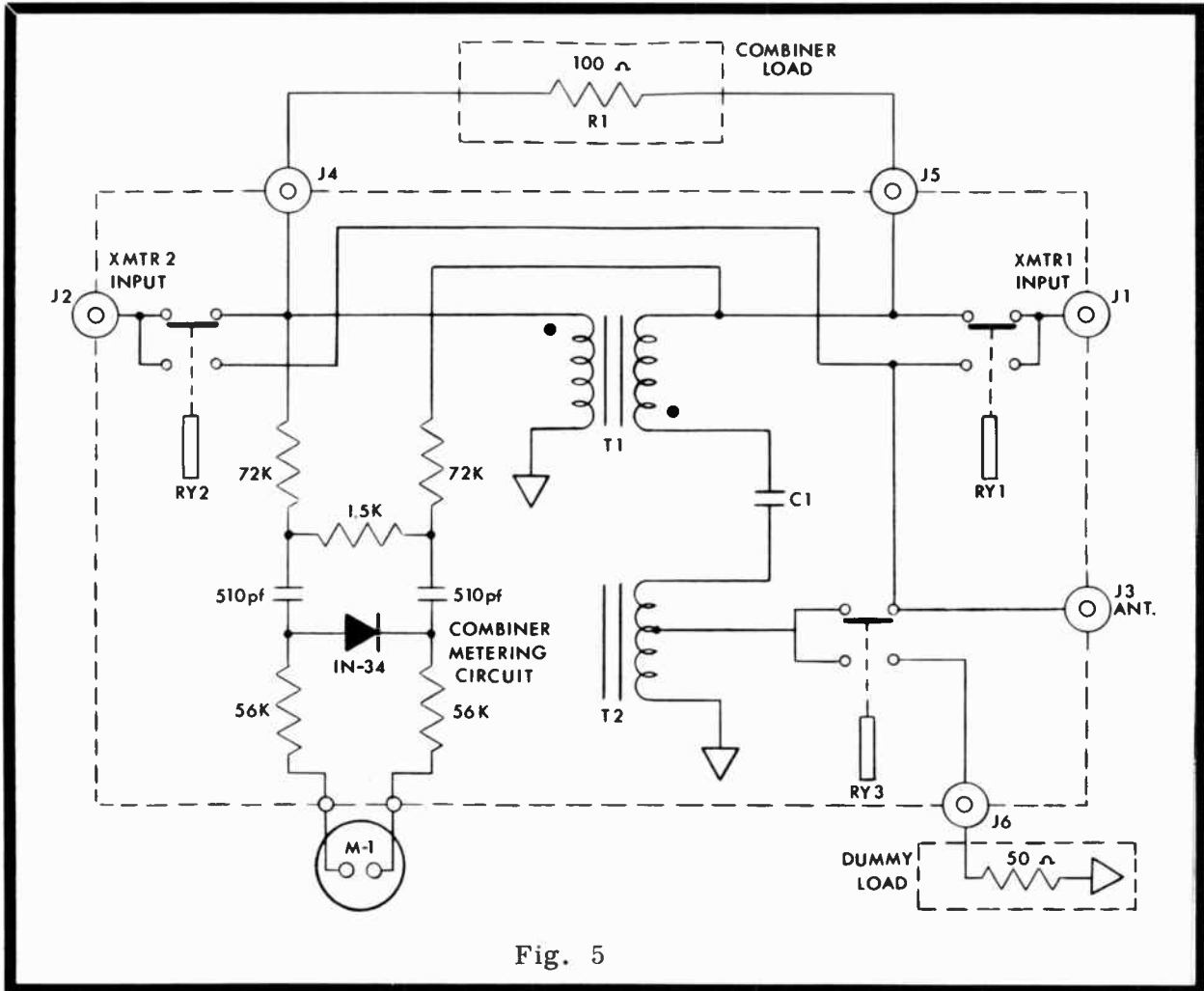

Fig. 5

Everything You Always Wanted to Know About Cartridge Machines

— But Were Afraid to Ask.

Jack Jenkins
International Tapetronics Corp., Bloomington, Ill.

In developing the first machines, the design goals were to reduce on-the-air mistakes and remove the mechanical task of cueing records and reel-to-reel tape machines. I was involved in introducing the cartridge concept at the 1959 NAB Convention here in Chicago and it achieved almost immediate success. Total success was not immediately achieved, primarily because machines would not always play when start button was pressed. If the operator were fortunate enough to have the machine start after pressing the start button, with almost equal frequency the machines would fail to cue, and continue to play the commercial over and over.

The heads used on the early machines were constructed with a plastic face which was not compatible with the tape in use at that time. If you will recall, it was necessary to clean heads several times each day. In the early machines, indirect capstan drive and complicated linkage assemblies caused undue maintenance problems of a mechanical nature.

The first machines built were not of the quality which the broadcaster demands and is being provided today. There is no question that the early machines did require a good engineer to maintain if they were to provide the type of service expected of quality equipment. We also must recognize that cartridge machines are used primarily to play commercial program material on the air. The failure of a machine while playing commercials is more detrimental to a radio station's operation than would be the failure of a turntable or other electromechanical devices.

The cartridge machine has grown up from its infancy in a relatively short time. The fast-paced modern programming common today would not be possible without the use of a cartridge machine. It is possibly the most helpful tool which has been provided programming personnel in recent years. An outgrowth of the cartridge machine is program automation. It is doubtful that automation would be what it is today without the flexibility provided by cartridge machines.

The dependability and the amount of maintenance required has been vastly improved through design of modern tape cartridge machines. Let's look at some specific areas of design change. The original plastic heads were replaced with a head of all metal-faced construction. The front contour is of a hyperbolic shape. The shape and material substantially reduce the need for cleaning the heads and relieve the problems caused by early pressure pads.

Another area of major design improvement took place in the head assembly. The early units either contained no tape guides or at very best possibly one guide. In today's equipment there are usually three tape guides of a non-magnetic material which are rigidly supported and will not lose alignment. They serve the very important purpose of greatly improving the azimuth relationship of tape and head as compared to the variable and erratic guidance provided by the cartridge itself.

The head mount has been radically changed from the simple angle bracket which was found on early machines. In the modern design of today's cartridge machines you will find the head mounting is of very sturdy construction. The azimuth pivot point is directly behind the center of the head in both a vertical and horizontal plane. This

feature is one which you will not find on many of the most expensive reel-to-reel machines. This design feature is important since it permits azimuth adjustment without disturbing the height adjustment.

Many operators of cartridge machines want to vent their anger or demonstrate their physical prowess while loading a cartridge in their machine. They seem to muster all of their strength while inserting a cartridge. Obviously, this doesn't add much to proper maintenance of guides and heads. And it does require heavy-duty design of the entire head assembly.

It is common in today's machine to achieve a tape speed accuracy of 0.1% or better. This speed control is as good or better than that of the most expensive reel-to-reel machines or turntables. It must be recognized that tape drive is much more difficult in a cartridge than in reel-to-reel applications. The tape drive is subjected to wide variations of drag by the cartridge. The tape pulls from the center and winds back in the outside of a common hub of tape. This dictates that the tape must slip upon itself as the cartridge plays. This slipping action does not occur at an even rate, causing the tape to jerk as it pulls from the center of the hub.

All cartridge machines of early design made use of an indirect drive system using belts and pulleys. Instantaneous load extremes cause belt creepage to occur in this system of tape drive. Belt creepage is the phenomenon where the belt is minutely stretched by an excessive load as it moves on to the drive pulley. As the pulley turns and the stretched portion of the belt moves around the pulley, the excessive load is removed and the stretched portion of the belt contracts. This will cause a variation of tape speed and cannot be corrected by even the best maintenance program.

The solution to objectionable speed variation can be achieved through the use of a direct-drive motor. The hysteresis-synchronous direct drive motor concept also removed the requirement for two bearings in the drive system. The flywheel assemblies used in indirect drive units were typically supported by two bronze bearings which required frequent lubrication and were subject to excessive wear. This assembly is completely eliminated in the direct-drive system.

The 600 RPM direct drive motor which has been used in reel-to-reel machines for years, proved not to be satisfactory for cartridge drives. A slower turning motor and, therefore, a proportionately larger capstan shaft was required. The larger the shaft the greater the surface available for the tape and pinch roller to contact in the driving action.

In the early 1960s, after having recognized the tape drive problems associated with the 600 RPM motor, a slower turning 450 RPM motor was developed which delivered adequate torque, 7 to 10 inch-ounces. The next improvement, in the state of the art, was in the area of the capstan shaft tape drive surface. With a large capstan, directly driven, it seemed reasonable to assume that tape could be driven with the accuracy of an electric clock which achieves its power from a hysteresis motor. If the tape could be driven and not permitted to slip between the pinch roller and capstan, then extremely accurate tape drive could be achieved. However, the process of machining the capstan shaft leaves minute circular ridges around the shaft. These ridges result in the undesirable effect of presenting a lowered coefficient of friction like runners on a sled. By machining the shaft to a very high polish (4 micro-inch finish or less) and then blasting the shaft with aluminum oxide particles, a random roughened pattern can be accomplished. This permits the positive tape drive demanded by broadcasters. And, finally, a solution to holding the random roughened pattern and not permitting it to wear off after years of tape drive was needed. It would seem a diamond studded capstan shaft would be ideal. It probably would be,

if cost were no problem. The solution to capstan life can be found in a process called electrolyzing which will provide about a 5-year shaft life under heavy broadcast use.

Another mechanical portion of a cartridge machine to be scrutinized is the pinch-roller linkage. This assembly must be extremely quiet in its operation since most cartridge machines are used near an open microphone. An air damped solenoid (for noise reduction) with a minimum of moving linkage parts (for reduction of maintenance) is most desirable in this assembly. An expected design life of a minimum of a million operations is necessary.

Maintenance of today's cartridge equipment is dependent upon the amount of use. For sake of reference it will be assumed that the machine to be maintained is played 10 times per hour on a 24-hour per day basis or 240 one-minute plays per day. This totals 4 hours of playing time per day.

Lubrication requirements of solenoid and bearings will vary and is dependent upon original design. Recommendations of the manufacturer should be observed, so the first rule of thumb is to read the instruction book. If the unit is a direct drive design, it is probable that the capstan motor contains permanently sealed Class 7 ball bearings. This type bearing cannot be lubricated because the bearing is sealed; therefore, any effort to do so will only result in getting oil into the motor windings or some other area of the motor which does not need oil. You can expect an average of 5 years life from this type bearing, turning at 450 RPM. You might question sealing the bearing and say "Leave it open, because I will lubricate it and make it last longer."

It is not a question of getting oil into the bearing, but a question of keeping dust, cigarette ashes, iron oxide from the tape and other foreign material, such as Coke, out of the bearings. Other bearings which may be found in the linkage assembly will be either self-lubricated, sintered bronze-sleeve bearings or plain bronze bearings. Plain bronze bearings can usually be identified by their lighter brass color. This bronze bearing should be lubricated with a light grease about once a month. The ambient temperature and type grease used, can cause wide variations in frequency of lubrication. The self-lubricated sintered bronze (oilite) bearing is bronze in color but usually much darker than plain bronze. Close inspection will reveal dark spots in the bearing material. A very light oil, #10 or lighter, should be used to lubricate this bearing. There are pores in this material which will store oil and supply oil to the working surface of the bearing. It should be noted that adding surface oil usually will not replenish the stored oil in this type bearing. The stored oil can be replenished by immersing the bearing in heated oil.

The solenoid plunger should be lubricated with a dry lubricant. Graphite or some other commercially available lubricant is ideal. Oil on a solenoid plunger will usually attract dust, cigarette ashes and other particles.

The electronics of a cartridge machine can best be maintained by having a means of measuring the electrical parameters and taking corrective action as required. The ideal means of testing the electronics is to have test cartridges which are used on a monthly basis. The first test cartridge should have at least 4 tones (more if the units are stereo) 100 Hz, 1 kHz and 12 kHz. These tones should be recorded at 10 db below normal level of about 15 seconds duration. One additional tone of 400 Hz should be recorded on this tape at normal or 0 level. This tape is played in each unit once a month. While playing the cartridge measure the output of the machine. A loss of the 12 kHz tone indicates head misalignment or head wear. Level of playback and distortion should also be observed. Any electronic deterioration can be observed and corrected with this simple test.

The head should be visually inspected for an uneven worn surface. It is possible that a head will scrape oxide from the tape while still providing fair playback characteristics. If so, it should be replaced before running all of your carts. Another test to be performed with this cartridge has to do with the recording unit. First measure the playback section of the recorder with the prerecorded tape as outlined above. If the playback performs normally, then select an unrecorded (erased) cartridge and record the same 4 tones as is recorded on the prerecorded test tape, 100 Hz, 1 kHz and 12 kHz at -10 db and 400 Hz at full or 0 level. Compare this newly recorded tape with the prerecorded tape. Any variance will indicate a deterioration in the recording process and corrective action can be taken. It must be noted that severe head azimuth variation can be caused by the cartridge. Therefore, the cartridge used to measure the recorder should be selected and kept as a test cartridge to be erased and re-recorded each month as outlined above.

Another test cartridge is one with cue tones recorded at normal cue level. If the equipment to be tested contains the three standard NAB tones (150 Hz, 1 kHz, and 8 kHz), then all three tones will be required on the test cartridge. Using a thoroughly erased cartridge, record cue tones in the normal manner. After recording the tones, reverse the playback head leads so that the cue head is connected to the program playback amplifier. Play the pre-recorded test cartridge. The cue tone output levels as reproduced through an NAB equalized playback amplifier should be 1 kHz, plus 0.4 150 Hz plus 6.1, 8 kHz -9.4 with reference to a 400-Hz tone recorded at 0 db (NAB standard reference level). Next, play the newly recorded cartridge and compare levels with the test cartridge. Any variation will indicate a deterioration of the cue record electronics or cue record head.

The final test cartridge is pre-recorded with the three cue tones, 8 db below normal cue level. This cartridge is used to adjust the cue sensitivity of the playback units. The cue play sensitivity should be lowered, then increased to the point of just tripping when this cartridge is played. This will then provide 8 db of excessive cue sensitivity when a cartridge is played which has been recorded at normal level.

It is suggested that the station engineer record the above mentioned test cartridges. You will need as your primary standard a test cartridge such as an NAB test cartridge or a test cartridge purchased from the equipment manufacturer. If this primary test cartridge is used to test all machines on a monthly basis, the short-wavelength sensitivity will be degraded by repeated playing. This loss is a direct result of wear products adhering to the tape and causing poor contact with the reproduce head. If one is aware of the cause of signal loss, then by carefully using the tape and by keeping the tape, heads, and guides clean, you can minimize this loss. In my opinion, the best way to maintain a primary test cartridge is to record your own test cartridges as outlined above and compare them with the primary test cartridge each 6 months. By so doing, the primary test cartridge should hold its accuracy for years.

Cartridge maintenance is the final requirement of successful cartridge broadcasting. The corner post around which the tape passes prior to reaching the heads is very critical. The height of the top lip of this post must be exactly .562 inches. With the cartridge sitting on a flat even surface, measure from the surface on which the cartridge is lying to the underneath side of the corner post (level at which the upper edge of the tape runs).

On Fidelipac Cartridges the white corner post can be gauged by sighting over the edge of the gray base to the overhang of the corner post. If the overhang is above the edge of the gray base, the corner post is probably high and needs to be readjusted. A gauge is required if this is to be accurately adjusted.

Another variable in most cartridges is the post between the heads which causes the tape to wrap around the head face when the cartridge is inserted. This post should be exactly vertical in all cartridges. If it is not vertical, it will cause the tape to skew up or down; thus, causing an apparent azimuth variance from cartridge to cartridge. Even three closely toleranced tape guides will not always make up for this cartridge deficiency. For several years I have encouraged cartridge manufacturers to put an adjustable corner post in cartridges so tolerance correction could be made within the cartridge. In this manner, each cartridge could be adjusted to a standard in order to substantially eliminate variations from cart to cart.

The final important point to observe has to do with the tape. A prerecorded tape which has been playing properly for years (an ID cartridge, for example) is erased and rerecorded, and seems not to play properly after being rerecorded. The probable cause is that much of the oxide was worn away which only causes a slight drop of output on playback, but when the tape is rerecorded the reduced amount of oxide requires a different amount of bias and, therefore, will not rerecord.

Another problem related to tape is that after many plays the oxide will be completely worn away at the point of pinch-roller capstan contact where the tape is repeatedly started. This worn tape can be moved to the run-out section where the program has ended and the tape is running out to cue; but, generally speaking, when tape is badly worn in this way, the cartridge should be reloaded.

The amount of bias required will vary with different brands of tape. Station engineers should be very careful not to mix different types of tape without first measuring the recording characteristics of the new tape, being sure that it is identical with the old.

Excellent performance from today's cartridge machines is achieved as a result of design improvements and a thorough maintenance program. Years of trouble-free service is provided by today's cartridge machine.

Progress Report on Technical Facilities Automation of TV Stations

G. E. Eustis

General Electric Co., Syracuse, N. Y.

When the paper on "TV Station Automation" was presented at the Fall Conference of the SMPTE, the General Electric Company had just installed a full-time operating technical facilities automation system at KBMA-TV in Kansas City. The system consisted of a General Electric GE/PAC-30 process minicomputer controlling the master control area of an independent UHF television station, entering the program schedule via data processing cards, controlling machines, and an audio/video switcher. This paper undertakes to review the original system and the features that have been added as the result of working experience with that system in both hardware and software.

The five major hardware components of the system include the control panel, switching electronics, computer, machine control, and the CRT entry system. The software embraces the thousands of instructions that tell the computer how to interpret the daily program schedule and to put it on the air. In addition to this operating routine, error recovery and other service routines are worthy of our consideration.

The basic switcher consists of 16 audio-follow-video inputs and four audio break-away sources that are controlled by the panel shown in Fig. 1. There are three output buses, one preview and two program. A video combiner permits mixes or wipes between the two program buses. Keying is also available by use of the preview bus to select the key source. While the manual mode of operation makes available only three wipe patterns, one of which can be changed by switches below the control panel, the automatic mode includes seven additional patterns, thus providing all of the basic patterns, including a circle.

An audio combiner follows the video mix and wipe functions, and for the audio override function provided, the preview bus is aired over the combined audio program outputs. A microphone input can replace the preview bus in the override mode, or it can completely replace the normal audio output. Audio level and monitoring controls are provided in the center of the panel.

The cluster of buttons in the upper-right corner of the panel are used for computer control. The hold button delays the execution of events while it is held depressed. The skip button causes the next event to be deleted. The next three buttons govern mode control. There is, in addition to the automatic and manual modes of operation, an intermediate mode, called preset, that allows the operator to control the start of all transitions. The roll and take buttons light up when there is an operator-initiated transition to be performed. Pressing the illuminated button starts the transition.

The only transitions provided in the original system were cut, key, mix, or wipe. Four additional types of transitions were provided in the final system. Mix and wipe via black were added to allow mirror flips to be performed in black while switching between two projectors on the same film island. This automatic transition also eliminates one line of input information when black is desired between two program segments. Override was added to allow audio tags, etc. Nine background or key filler sources were added to the key mode. The original system used self key, but it was also found desirable to matte-key. Thus, nine of the video inputs can be designated as background sources during system setup. The last function added was the microphone input to the audio breakaway sources.

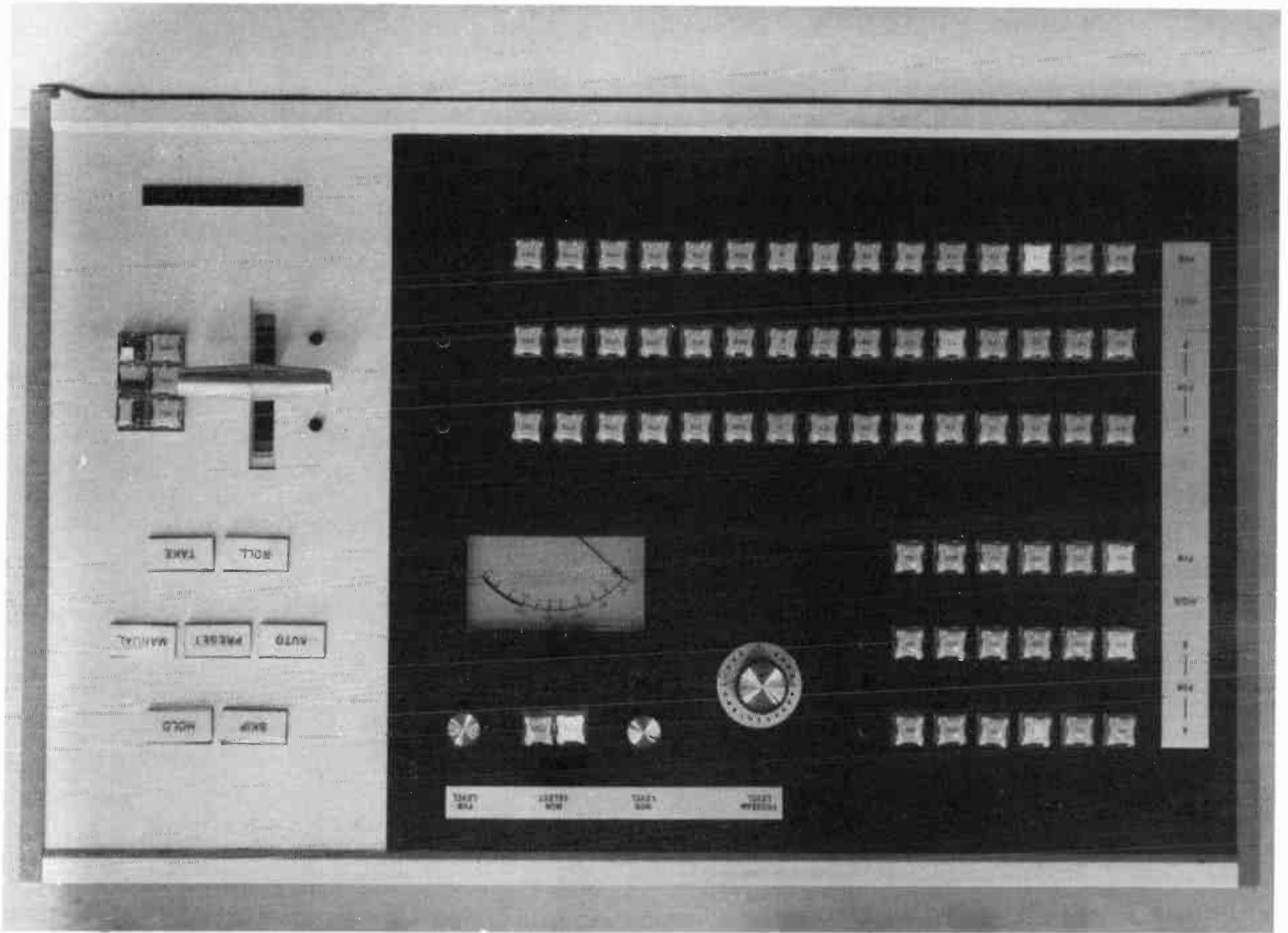

Fig. 1

TIME	DURATION	VIDEO	T	AUDIO	PROGRAM
15:08:13	7:00	F02A	C	F	CARTOON-MOUSE M
17:03:03	D 1:00	F02C	C	F	EQUAL EMPLOYMENT
17:04:03	D 7:14	F02B	MF	F	WILD WILD WEST
17:11:17	D 1:00	V06	MF	F	THUR NITE MOVIE P
17:12:17	D 14:50	F02B	WM5	F	WILD WILD WEST 2
17:27:07	D 1:08	F02S	VF	M6	NEWS
17:28:15	C :06	F02S	XF2	C7	ID SL# 25 CTG
17:28:21	D 17:03	F02B	VF	F	WILD WILD WEST 3
17:45:24	D :30	V05	MF	F	TREEHOUSE PROMO
17:45:54	D 1:00	F02C	C	F	MEDICAL RUBELLA 2
17:46:54	D 1:00	F02C	C	F	CLEAN AIR 7
17:47:54	D 7:54	F02B	MF	F	WILD WILD WEST 4
17:55:48	D :55	F02C	VF	F	DRAGNET PROMO
17:56:38	S :05	F02C	O	M6	DRAGNET TAG
17:56:43	1:00	F02C	C	F	PTA 27
17:57:45	A :18	F02B	VF	F	WILD WILD WEST T
TIMING ERROR + 00:00:02					

Fig. 2

These new types of transitions were added without changing the constraint of three columns to define the transition. Samples of the various types can be seen under "T" on the monitor image shown in Fig. 2. Key and over require a second line of program data to define the secondary source. When on the air, this line is displayed on the normally blank line after the on-air line.

Machine control can take various forms, depending upon the configuration of machines at the site being automated. It is here that the modularity of the software program is of great benefit. Small changes can be made in system operation without affecting other portions of the programming.

The simplest possible system provides contact closures for preroll, stop, show, and slide change. Here, the computer is not used to verify the operation of the machine; therefore, the operator must note machine failures as they occur and take the necessary corrective action.

A more comprehensive machine control system was developed to fully utilize the capability of the computer. In this system, a single control head, employed in the manual mode, can control either a film island or a video tape recorder and also provide verification information to the computer for error detection. Since all control and tally information is multiplexed on a single data line, the control system is also ideal for use with a preassignment matrix.

Software instructions to drive these control heads are modular and vary as a function of the machines being controlled. The most complex system is the General Electric PF-12 film island, consisting of four projectors and two color TV film

cameras. In such a system, assignment conflicts can arise when attempting to preview a second projector into a camera already on the air; when attempting to call for the on-air projector into the off-air camera; or stopping projectors in similar situations. Machines are not stopped if they are to be used again in less than the preroll time.

Several error-recovery routines have also been incorporated into the automation system. Some are alarm routines that merely alert the operator, while others attempt to keep the system on the air. When selecting input sources, the computer not only initiates the selection but also verifies completion. If the tally from the buttons does not match the request from the computer, the computer tries a second time before transferring to an error-recovery routine that notifies the operator. If the erroneous bus is on the air, the error routine selects the input on the other bus and puts it on the air.

If a fade or wipe is incorrect, similar corrective action is taken. Error messages to the operator are also initiated by card reading errors, such as hopper empty, backspace card, etc. An alarm is sounded when an error occurs to alert the operator that a message is displayed on the CRT.

The input data, or program schedule, is checked for syntax error and logical inconsistencies, such as illegal characters, command codes, or speed missing in a fader transition. The operator is notified of these errors by the erroneous area on the CRT blinking and by a message display. The timing of events is also checked, and the operator is notified of any discrepancy which could be caused by improper scheduling or a late cue. All errors can be corrected by use of the CRT data entry keyboard shown in Fig. 3.

The CRT data-entry system allows the operator to change the input schedule and interact with the operating system. In the original system, the operator could correct or replace a line on the monitor, add or insert a new line, or compose a line to be typed on the log. In the present system, a line can be deleted or the clock can be reset as well as other functions performed. Inputs made by way of the CRT entry system are checked for errors in a manner similar to that for the schedule input from cards.

The as-run log typed by the automatic system is in the format required by the FCC. In the manual mode, the time and sources are typed automatically with the time on and off of the automated operation. In the manual mode, however, the operator must fill in the FCC program data to fulfill requirements.

Fig. 4 shows a typical log segment. The date and page number are type at the top of each page. The first is a typical on-off automation message. The next two lines are spot announcements in a station break. The next line is typical for a fully self-contained program such as a half-hour program from network. Following the half-hour station break is a program that includes spots as well as an operator message at its midpoint.

In the General Electric GE/BAC-100 system, the standard input source is the 80-column data processing card. Since all of the columns are not used for the technical automation system, the surplus ones can be coded for billing data, etc. The cards containing the business data can be processed by a business computer following airing. Errors or omissions can be entered into the source deck from the as-run log. An additional benefit of the card system is that in repetitive daytime programming, last week's cards become the basis for this week's schedule.

Since a deck of cards is the input source, the printed listing of the deck can be the program schedule that is circulated around the station. Provision is made in the card input routine for handling cards that print notes or comments on the operating

Fig. 3

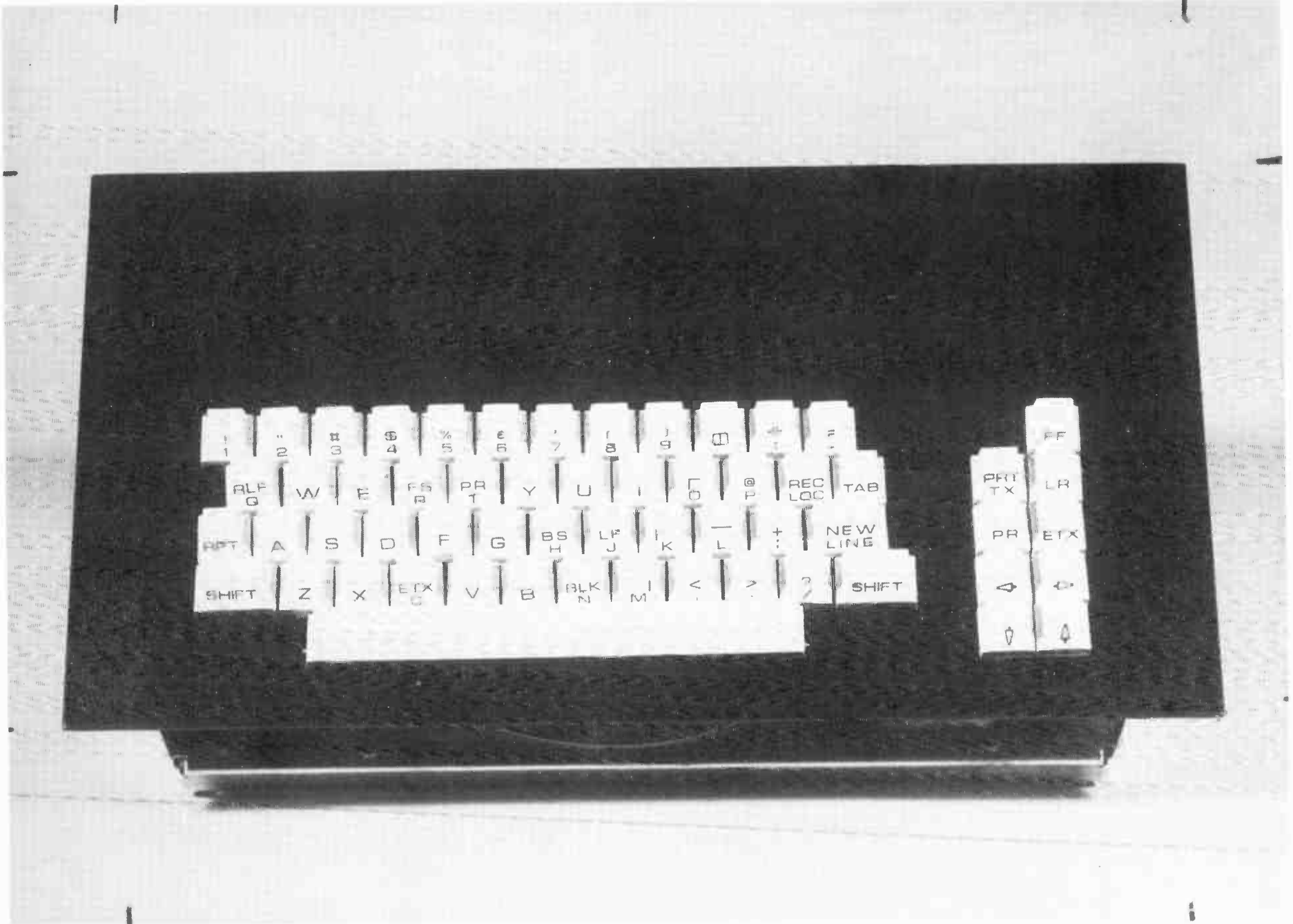

schedule. These cards will not affect technical automation nor will they occupy space on the CRT display. If a duplicate is made of the deck, it can be sorted by source and machine for loading lists that may be posted at each machine. These lists can also be used to make up "spot" reels.

The brain of the GE/BAC system is the GE/PAC-30 minicomputer, which is modularly expandable and physically small; less than 20 inches wide by two feet high. Its main memory is expandable from 4000 to 64,000 bytes, or characters. Of the 30 plug-in circuit boards that make up the computer, ten comprise the central processing unit, and the remainder interface other devices, such as machines and the switcher. The computer language employed is an expanded version of the IBM 360 instruction set, a very common language with which 80 percent of today's operators are familiar.

Considering that the average instruction is executed in five microseconds, 200,000 decisions can be made in one second. The processor can transmit 50,000 commands per second via the multiplexer bus to up to 255 devices and 500,000 bytes per second through the selector channel. These figures are cited only to show the capability of the GE/PAC-30 minicomputer.

A properly designed process control system runs at only 50 percent of its capacity during peak loads. This conservative loading prevents overload problems such as were encountered by the recent Apollo moonlander during the lunar descent phase. The leftover processing capability of the system can be used in other, less urgent, programs. A non-priority program that can afford to wait a second or two for exe-

TIME		PROGRAM ANNOUNCEMENT SPONSOR	ANN. TYPE	PROGRAM	
BEGIN	END/DURATION			SOURCE	TYPE
***** ON AUTOMATIC OPERATION AT 18:59:30 ***					
19:00:00	1:00	CANCER SOCIETY #53	PSA CM		
19:01:00	1:00	BROWN SHOES # ANP601			
19:02:00	19:29:00	BOURBON STREET BEAT		NET	ENT
19:29:00	1:00	HILLS IGA # 115	CM ID CM PSA		
19:30:00	:05	STATION ID C# 15 S# 76			
19:30:05	:30	NAT'L BANK OF CNY			
19:30:35	:30	BUCKLE UP # 12			
19:31:05		CRIME BUSTERS		LOC	ENT
19:43:10	1:00	FAIRMT BOWL # 1060	CM		
19:44:10	1:00	MON NITE MOVIE PROMO	NCA		
* NO AUDIO FIRST 10 SEC OF SEGMENT TWO					
19:52:50	1:00	USN RE-ENLIST # 46	PSA CM		
19:53:50	1:00	BEST DRUG CO F560			
	19:59:00	PROGRAM END			
19:59:00	:30	JAYS HARDWARE # 1530	CM		
19:59:30	:10	STATION ID C# 25 S# 70	ID		
19:59:40	1:00	PAUL'S MEN SHOP # PM 4360	CM		
20:00:40	:20	SAT SPORTS SPCL PROMO	NCA		

Fig. 4

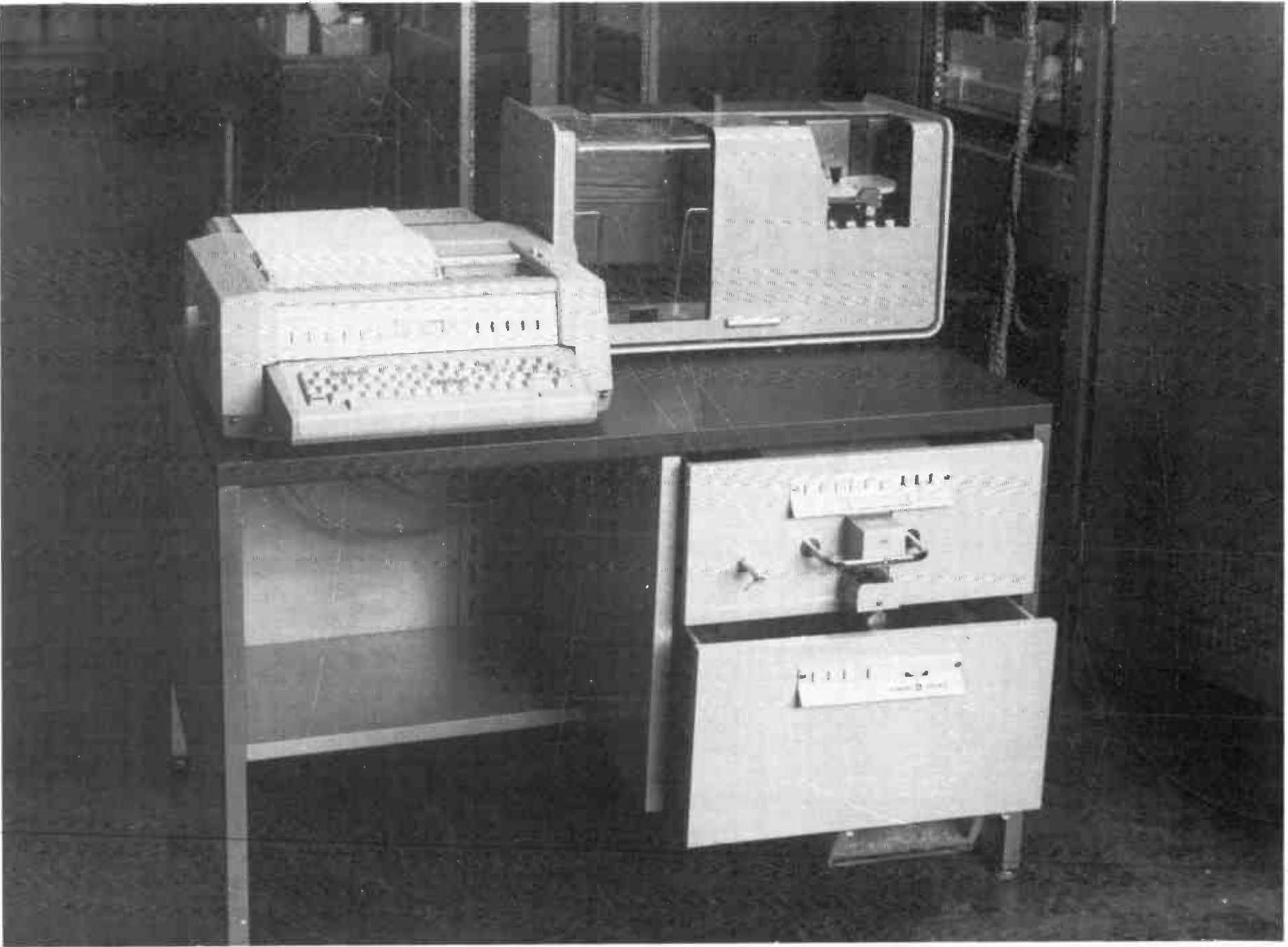

Fig. 13

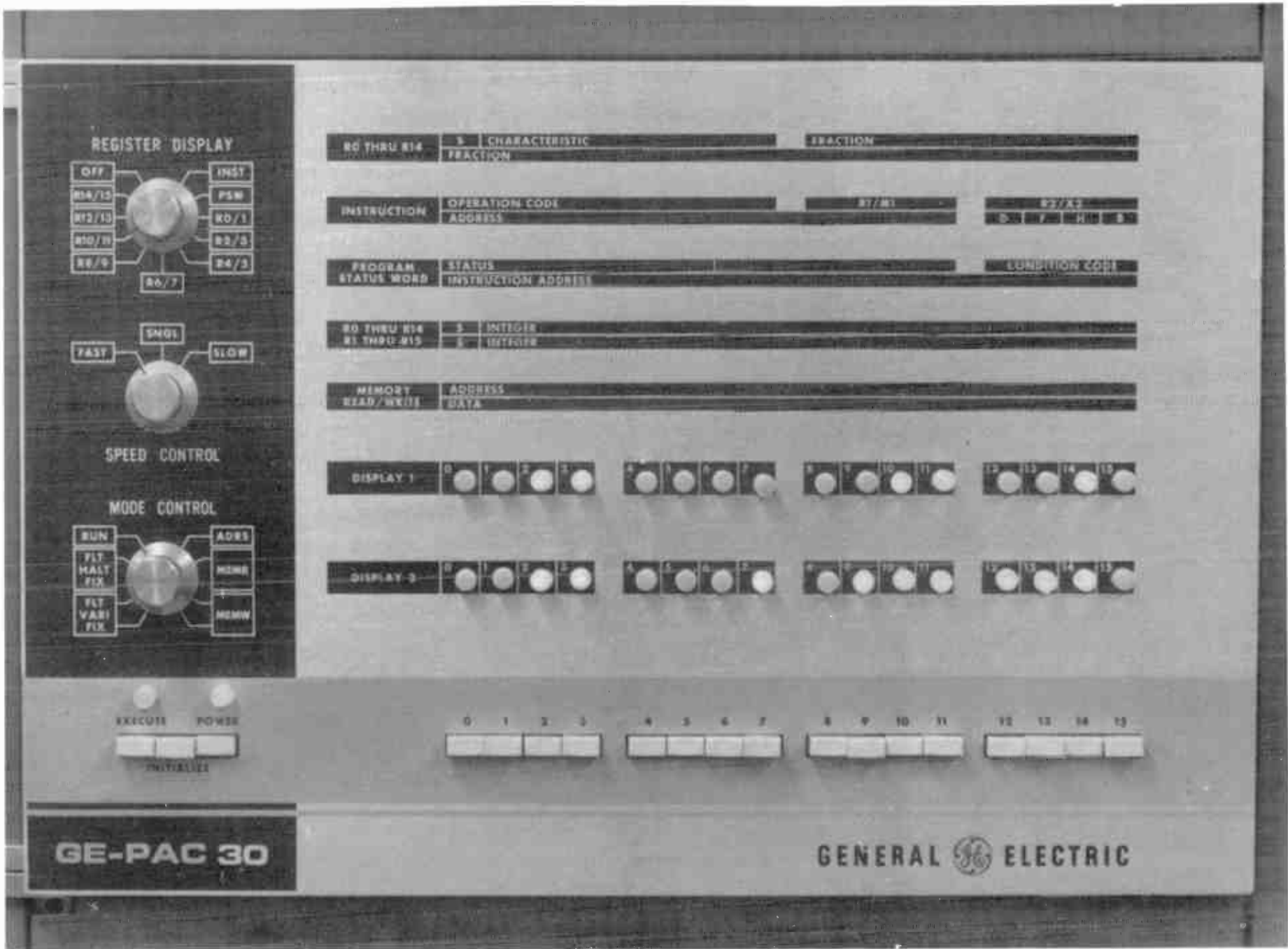

Fig. 6

cution can use the "free time." An example of this type of non-priority programming is the monitoring of a remote-controlled transmitter (recently authorized by the FCC for VHF) and the logging of its data. This application does not require the split-second timing of program control so that it can use the "free time" on the computer. For instance, instead of the 9:00 AM reading being taken at precisely 9:00, it may be logged at 9:00:06, which is still considerably more timely than present-day manual recording.

Another non-priority program on which we are presently doing some research is the generation of future program schedules, using another CRT entry terminal. As now envisioned, the traffic clerk could either generate a new schedule from scratch or take last week's schedule and update it. She could search through the schedule, inserting, deleting, swapping, or correcting lines. When finished, a preliminary schedule could be printed with all timing errors, etc., noted, or as the final schedule.

An extension of this system could be that of maintaining availabilities for several months out and of entering contracts as they are sold. The operator would, naturally, be able to search for open spots, conflicts, and perhaps look for opening with certain demographics.

The flexibility of a computer-controlled system, and particularly the GE/PAC-30 minicomputer, is illustrated by an automated ETV network control center being developed for Pennsylvania. This center will feed up to three different programs to any combination of 18 output lines. The system includes some of the program schedule generation functions mentioned above.

In a general way, this is what the General Electric Company now has in actual operation for TV station automation. The benefits resulting from such automation may be summarized as follows:

1. With the many types of transitions built into the General Electric automation system, the broadcasting station can have a better on-air image. A perfect flow of programming and smooth, unspoiled transitions attract prime advertisers and higher revenues, while assuring minimal switching errors during crowded program breaks, with their consequent "make-goods," thus resulting in better time efficiency

2. A legible FCC log provides a clear and concise understanding of what really occurred without resorting to an expert in hieroglyphics.

3. Input checking notifies the operator of errors in the program schedule well before they can do any harm and allows as well for non-panic schedule updating.

4. A simplified entry system with seven commands, using television terminology and a standard typewriter keyboard, facilitates last minute changes or error corrections.

5. A closed-loop operating system makes corrections to put the right source on the air before the operator even senses the error.

6. Although automation seldom displaces workers with technical backgrounds, it does much to remove a great deal of the drudgery from their daily tasks, allowing time for more meaningful work, such as the routine maintenance that never gets done because of the pressures of schedules. Automation permits the video controller to do the job he is really paid to do, producing the best picture quality possible, not pushing buttons.

7. At a time when broadcasters are having problems finding qualified technical staff members, automated stations face less of a problem. Technicians seem to be attracted by the "two-world" concept of computers and broadcasting.

We, at General Electric, feel that automation of the broadcasting industry is not a blue-sky concept. Stations have been partially automated for some years; many

have dreamed of becoming fully automated. At General Electric, we are making that dream a reality today.

The author would like to take this opportunity to thank his colleagues at General Electric and the staff of KBMA-TV for the help and advice that has developed our system as it is today.

The Auto Cue Computerized Lighting Control System

Adrian B. Ettliger

S.J. Bonsignore

CBS Television Network, New York, N.Y.

The application of computer techniques to stage lighting control began a few years ago, and a variety of approaches have been tried. The data storage function in lighting control requires memorizing a series of cues, each cue consisting of a pattern of number values specifying the voltages to be fed to an array of dimmer control channels. Digital data storage techniques can readily perform this task, but the man-machine problem, requiring that the operator have easy manual access to alter the dimmer settings, has proven difficult to resolve satisfactorily.

CBS has for many years followed with interest the developments in electronic memory lighting control systems. No such system had been installed previously in any CBS facility because it had been decided that certain inherent limitations must be overcome before memory lighting cue storage could meet the particular demands of network television show production. The restrictions present in commercially available systems, which were all of the "hard-wired logic" rather than stored program type, were:

1. Access to individual dimmer channels during automatic operation was restricted; i.e., some preparatory action is always required to adjust any given channel, as opposed to the ability on a manual board to reach for and adjust the specific control lever.
2. The status of the control channels, which on a manual board is apparent from the profile of the positions of the bank of control levers, was not made readily apparent to the operator, except at prohibitive cost such as including a special meter for each channel.
3. The sequence numbering of cues was universally rigid, making awkward the addition, deletion, or changing of the sequence order of cues.

The new CBS system, which overcomes the above disadvantages, is based upon the use of an alphanumeric display with a light pen as the controlling instrument. By programming the computer to respond to operator requests in a closely interactive manner, problems of status display and the dynamic relationship between functional options and system status can be dealt with at a very effective level.

The system installed in Studio 31 at CBS's Television City in Hollywood provides for 120 dimmer control channels. Twenty of these channels actually feed multiple dimmers for cyclorama circuits. The lighting control function requires the activation of a series of patterns of values for various combinations of the 120 control channels. Following conventional practice, dimmer settings are expressed on a scale of 10. The system provides for settings to a precision of one-quarter point, so that the total number of points on the scale is forty. As initially configured, the cue storage capacity of the computer memory is 255; i.e., a total of 255 data fields, each expressing 120 values to forty point resolution, are stored. The computer's central processor contains 4096 12-bit words, and the information is stored on a disc having a capacity of 32, 768 words.

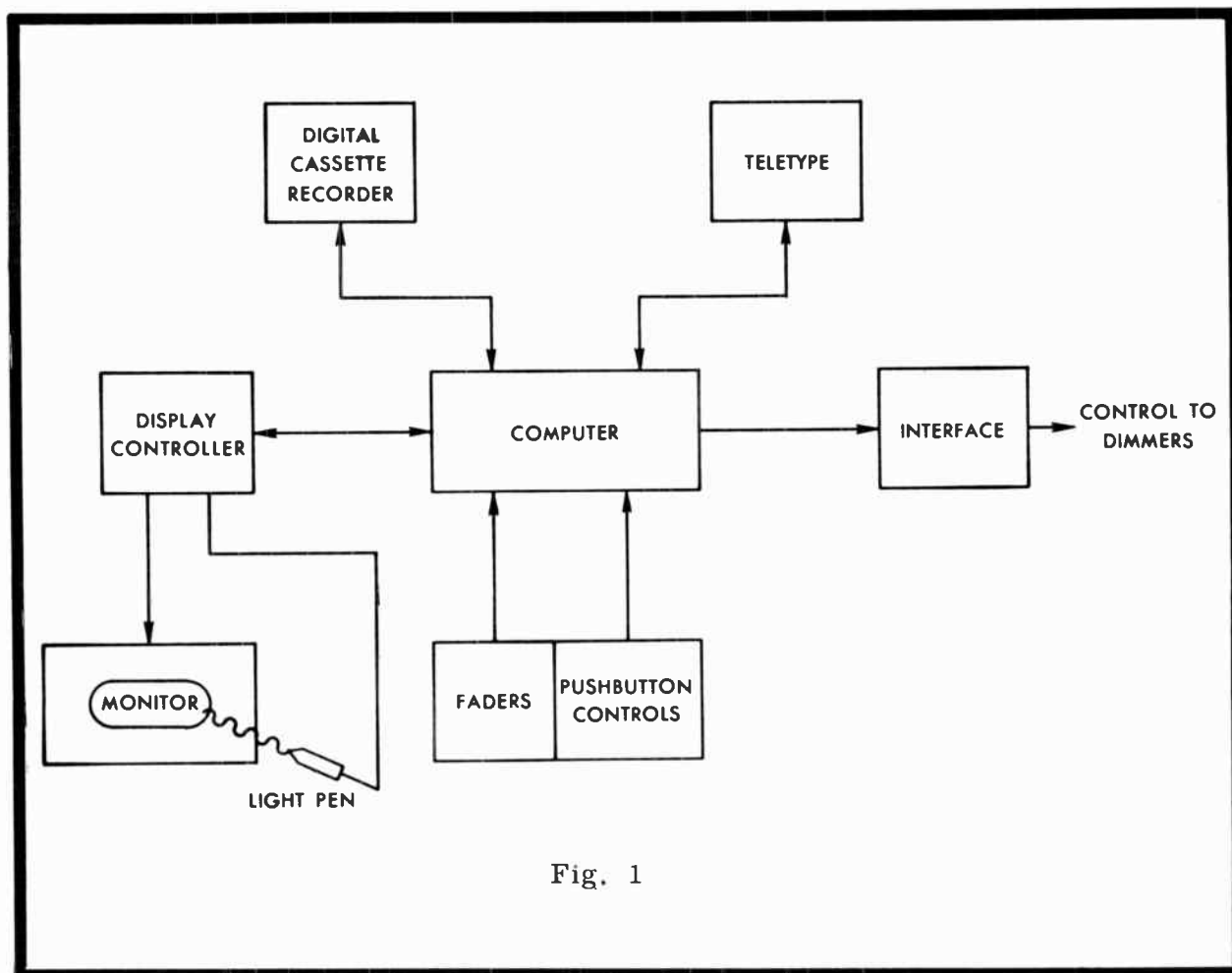

Fig. 1

A block diagram showing the relationship of the major system components is given in Fig. 1. The computer is at the heart of the system. The display controller, the key to the system concept, includes the light pen as an accessory. The monitor is a standard television unit. The two-way communication path between the computer and the display controller handles most of the instructions given by the operator to the computer and provides the operator with all system status information. A limited number of manual controls, including faders and pushbuttons, are interfaced directly to the computer. The dimmer control signals are provided through an interface unit containing an array of digital-to-analog converters.

Fig. 2 is an overall view of the operator's console. The monitor with the fader handles at its left and the small pushbutton panel to its right constitutes the entire computer man-machine interface. The tier of controls above the desk is a set of manual dimmer controls which, with the fader handles in the right wing unit, are a manual back-up system. Fig. 3 shows an operator using the light pen on the monitor. Fig. 4 is a close-up of the display with the light pen in use. Fig. 5 shows the computer equipment rack. The unit in the center of the rack is the computer central processor, with the disc memory above it. At the top of the rack are the display controller on the left and the digital cassette recorder on the right. Fig. 6 views the same area from the opposite end, showing the interface units. Each interface frame is 7 inches high and contains eight plug-in printed circuits cards with six digital-to-analog converters on each card. The top frame contains the digital logic for the fader and push-button controls. All frames contain their own power supplies in plug-in units.

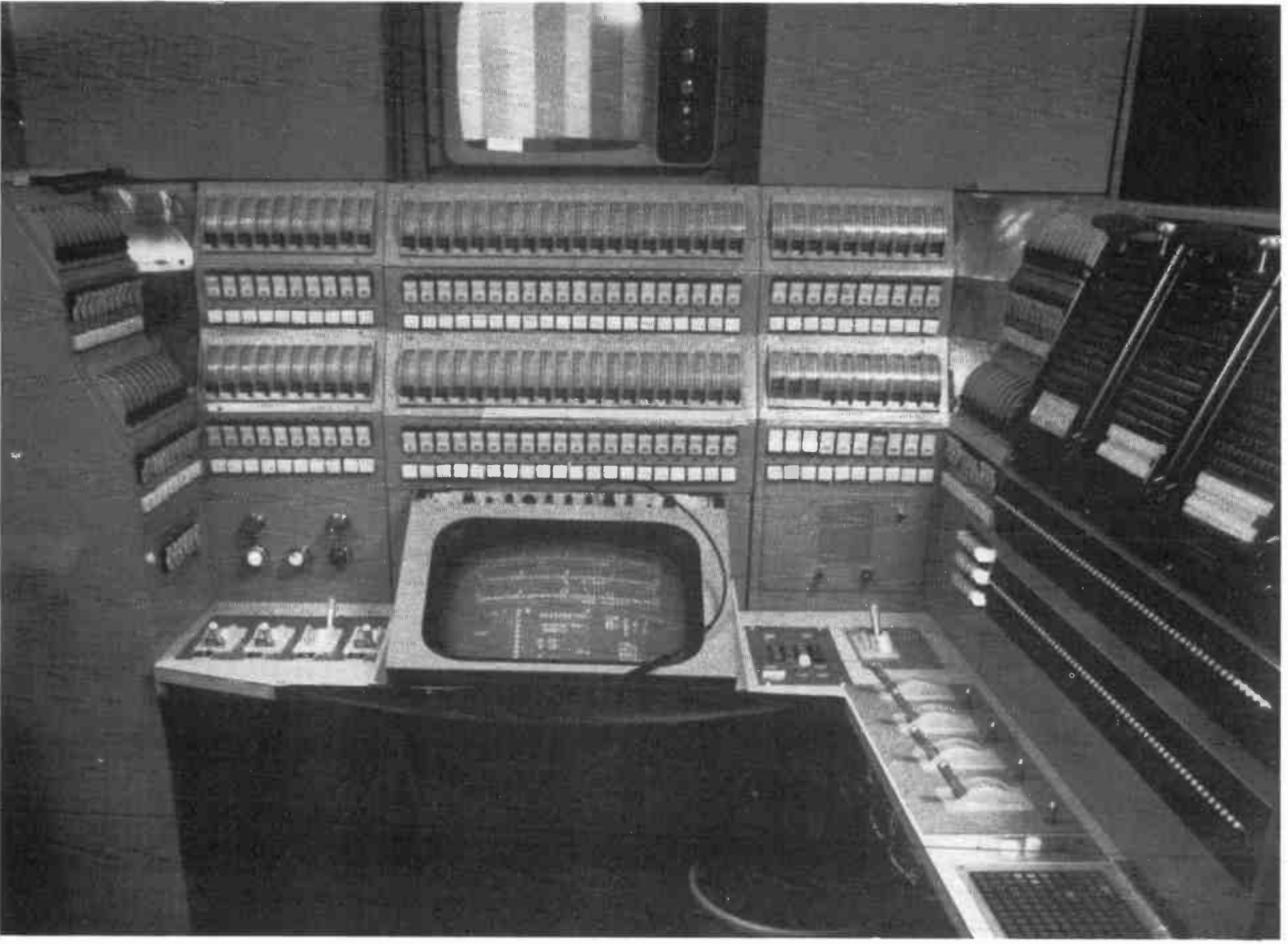

Fig. 2



Fig. 3



Fig. 5

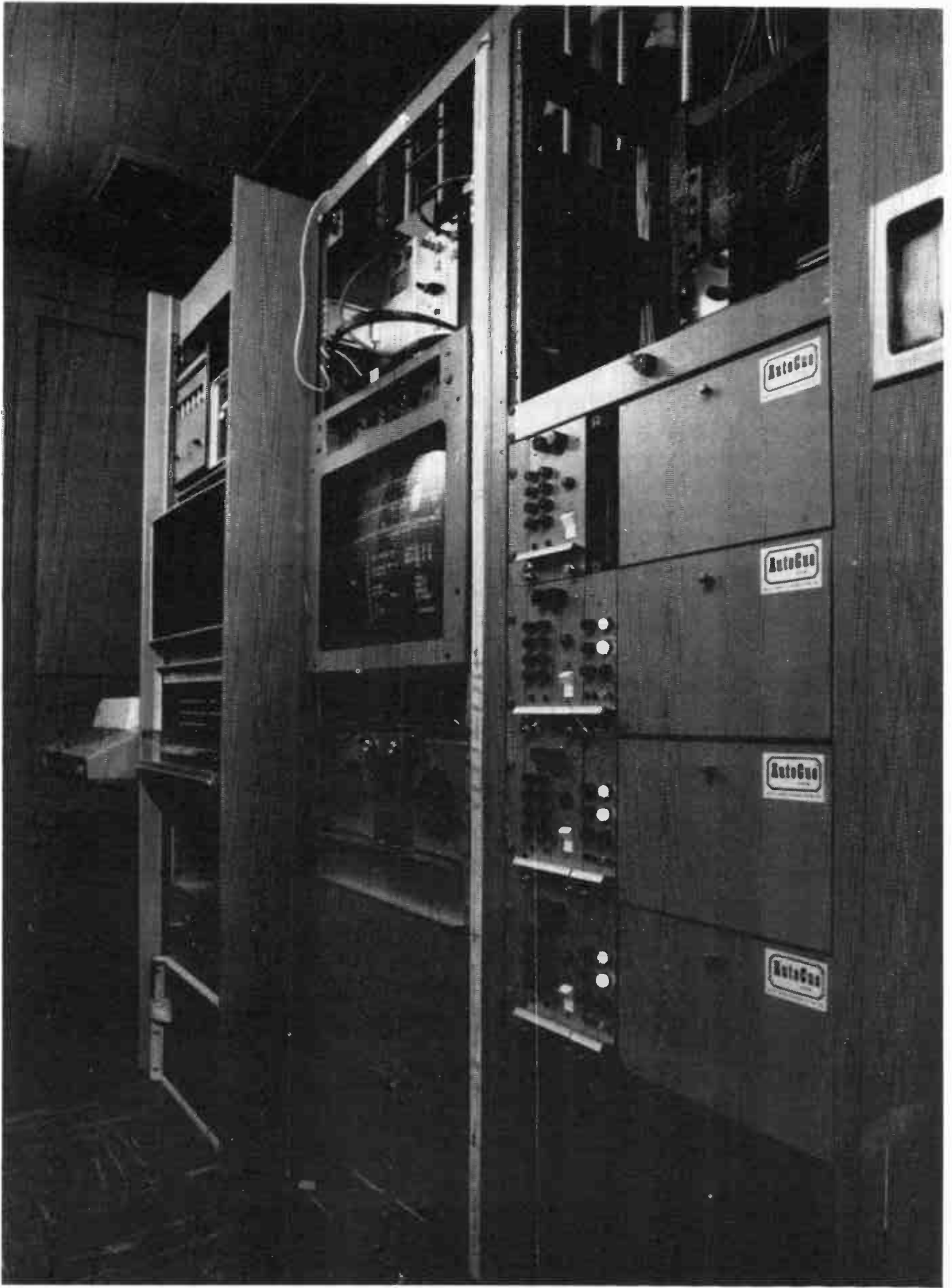

Fig. 6

Relationship of Television Picture Quality to Field Intensity

Neil M. Smith, Engineering Consultant, Washington, D.C.

One of the more discouraging traits one can detect in one's fellow man is the tendency to discuss in great detail matters about which that person knows very little. Engineers observe this phenomenon most often when among management personnel, of course, but candor requires us to admit to ourselves that engineers are among the worst offenders in this category. In the world of engineering there are simply too many things to know. This requires us to pick and choose among the possible areas of information available to us in the hope that we will absorb all the knowledge we need without wasting time in unnecessary areas. Moreover, it requires that, in research, we concentrate on certain areas while ignoring others.

In television broadcasting, an area of knowledge about which little is known but much is said is the actual quality of service provided by a station to its public. We have, of course, developed methods of calculating the signal strength expected at particular locations on a statistical basis, and, now and then, the coverage of a station is actually measured. These methods, however, seldom provide us with more than a set of circles on a map, denoting the locations of various median levels of field intensity. Seldom, if ever, do we attempt to depict coverage in terms of the quality of picture made available to the public. In the next few pages, some thoughts on this subject will be discussed.

We are all familiar with the Grade A and Grade B Service Contours established by the Federal Communications Commission. They are intended to define the reasonable limits of service in urban and rural conditions and are most often based on calculation rather than measurement.

TABLE 1

BASIS FOR GRADE A SERVICE STANDARD

Required Field Strengths (dbu)
(to overcome receiver noise)

	Channels 2-6	Channels 7-13	Channels 14-83
(1) Thermal Noise	7	7	7
(2) Receiver Noise Figure	12	12	15
(3) Peak Vis. Car./RMS Noise	30	30	30
(4) Transmission Line Loss	1	2	5
(5) Antenna Effective Length	-3	6	8
(6) Local Field Strength	47	57	65
(7) 70% Terrain Factor	4	4	6
(8) 90% Time Fading Factor	3	3	3
(9) Median Field Strength	54	64	74

Some years ago the Commission set forth values of field intensity for each of the three television bands, which were considered "required" for adequate service. For Grade A Service, the assumptions in Table 1 were made. These calculations are quite simple. The Commission assumed certain receiver characteristics and came up with a value of signal at the receiver input which should provide an acceptable picture. They then threw in a factor for transmission line loss (based on 50 feet of 300-ohm twinlead) and another that accounted for antenna gain and efficiency (assuming 0 db gain at VHF and 8 db gain at UHF). Finally, they added factors to account statistically for time and location variations and came up with a set of median values of "required" signal strength.

One further step was then made by assuming an additional factor required to overcome urban noise. The addition of this factor resulted in specified Grade A field strengths of 68 dbu for Channels 2-6, 71 dbu for Channels 7-13, and 74 dbu for Channels 14-83. It may be seen that the additional factor was 14 db on Channels 2-6 and 7 db on Channels 7-13, but, at UHF, urban noise was not considered significant, and no additional factor was included.

TABLE 2

BASIS FOR GRADE B SERVICE STANDARD

Required Field Strengths (dbu)
(to overcome receiver noise)

	<u>Channels</u> <u>2-6</u>	<u>Channels</u> <u>7-13</u>	<u>Channels</u> <u>14-83</u>
(1) Thermal Noise	7	7	7
(2) Receiver Noise Figure	12	12	15
(3) Peak Vis. Car./RMS Noise	30	30	30
(4) Transmission Line Loss	1	2	5
(5) Antenna Effective Length	<u>-9</u>	<u>0</u>	<u>3</u>
(6) Local Field Intensity	41	51	60
(7) 50% Terrain Factor	0	0	0
(8) 90% Time Fading Factor	<u>6</u>	<u>5</u>	<u>4</u>
(9) Median Field Intensity	47	56	64

In similar fashion, "required" rural field strengths were established as shown in Table 2. In these computations, the same noise and line loss figures were employed, but the antenna factor was changed so as to be based on an antenna of 6 db gain for VHF and 13 db gain for UHF. In addition, different terrain and time fading factors were used, and, of course, urban noise was not considered.

On this basis, the television industry was provided with a standard for service, and the Commission regularly employs these standards in its determinations. Popularly, the Grade B Contour is considered the limit of reasonably usable service, while the Grade A Contour is taken to define the limit of good service. The City Grade Contour, established simply as 6 db above the Grade A level in all cases, is usually thought of as defining high quality service.

Through use, these standards have become reasonably well understood, and they provide a convenient basis for comparisons between one station and another. The

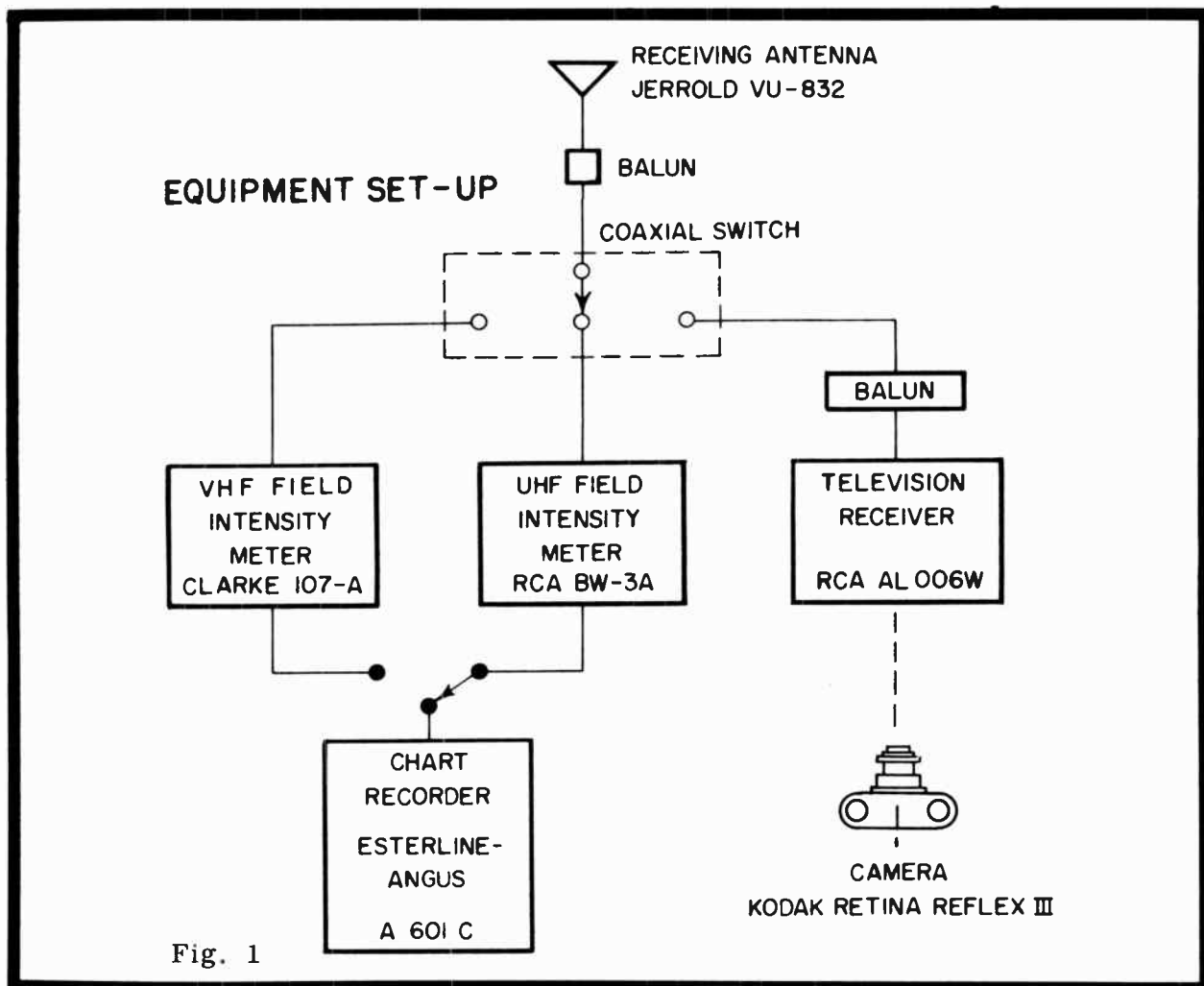

question remains, however: Are these standards reasonably representative of actual conditions in the viewers' homes?

It is not difficult to design a program of measurement and observation by which an answer to this question can be found. The only difficulty lies in the time and expense necessary to obtain sufficient information for analysis, which is the main reason for the paucity of data in this area.

Despite these problems, there is, from time to time, reason to make such studies for specific purposes, and the data thus obtained can sometimes be used to answer questions concerning the general nature of television service. The writer has participated in a number of studies of this nature, involving measurements and observations on stations in various locations and on differing frequencies. Of these studies, one was particularly appropriate to the present question, and the data included herein is taken from that study.

In this measurement program, data was obtained on a low-band VHF station, a high-band VHF station, and a UHF station, all serving the same area. Field intensity and picture quality information for each station was taken at a total of 203 locations covering a wide range of field intensity and picture quality.

The equipment employed is shown in the block diagram in Fig. 1 and in the photographs in Figs. 2, 3 and 4. The antenna was a Jerrold Model VU-832 which is designed for both VHF and UHF reception. It was purchased from a major Jerrold dealer who recommended it as representative of the all-channel antennas being installed by him in that specific locality. For each channel, the Jerrold antenna was calibrated against the appropriate standard dipole.

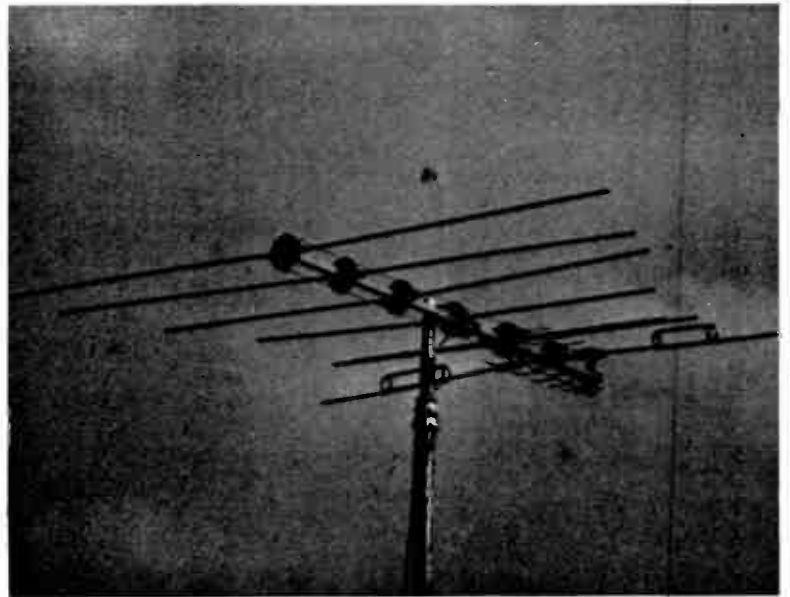

Fig. 2

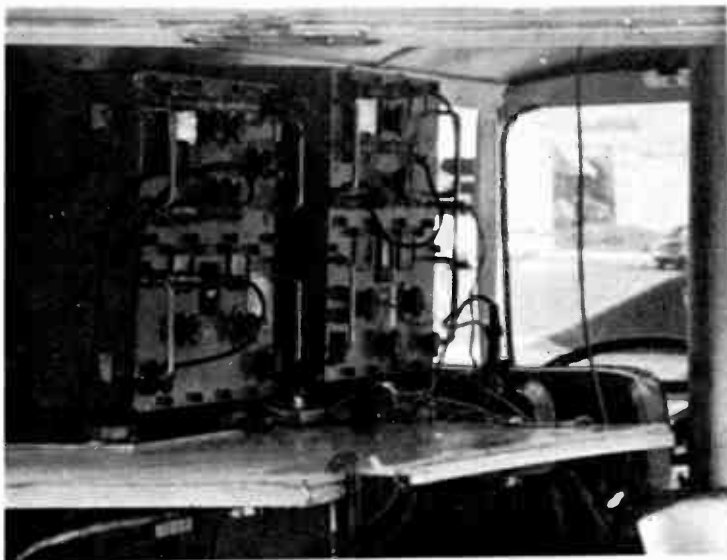

Fig. 3

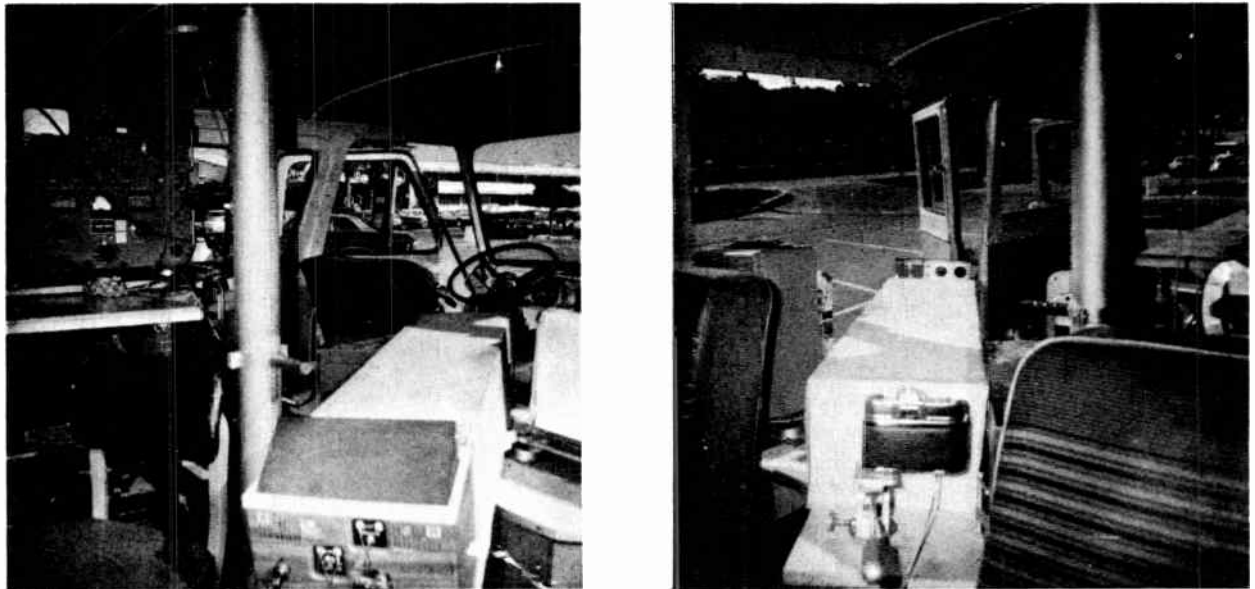

Fig. 4

The antenna was connected through a balun and coaxial transmission line to a coaxial switch, by which the signal could be fed to either of two field intensity meters or to an RCA Model AL006W television receiver designed to operate from a 12-volt DC power source. (This receiver was purchased, new, at the beginning of the study.) An opaque tunnel was attached to the front of the receiver, through which photographs of the television screen could be taken.

The two field intensity meters were an RCA Model BW-3A (for UHF) and a Nems-Clarke Model 107-A (for VHF). By means of a switch, the output of either meter

TABLE 3

TASO PICTURE QUALITY GRADES

- GRADE 1 (Excellent) - The picture is of extremely high quality; as good as you could desire.
- GRADE 2 (Good) - The picture is of high quality, providing enjoyable viewing. Interference is perceptible.
- GRADE 3 (Passable) - The picture is of acceptable quality. Interference is not objectionable.
- GRADE 4 (Marginal) - The picture is poor in quality, and you wish you could improve it. Interference is somewhat objectionable.
- GRADE 5 (Inferior) - The picture is very poor, but you could watch it. Definitely objectionable interference is present.
- GRADE 6 (Unusable) - The picture is so bad that you could not watch it.

GRADE 1



EXCELLENT

GRADE 2



GOOD

GRADE 3



PASSABLE

GRADE 4



MARGINAL

GRADE 5



INFERIOR

GRADE 6

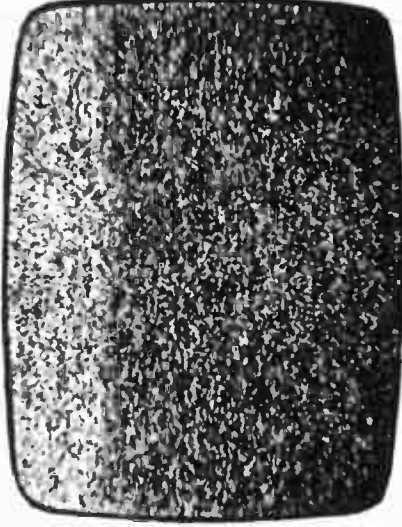

UNUSABLE

EXAMPLES OF TSO PICTURE
QUALITY GRADES

Fig. 5

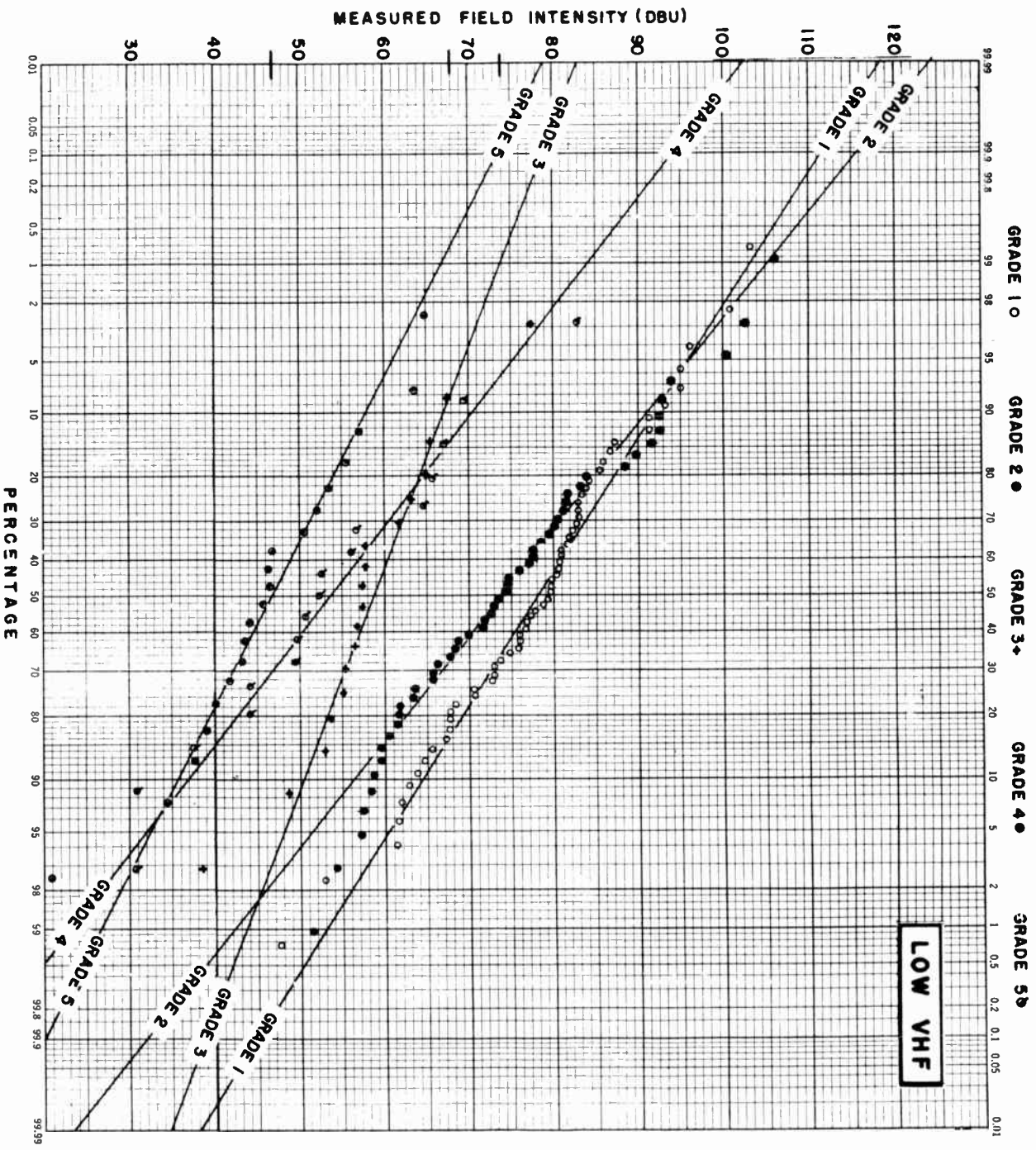

Fig. 6

could be used to drive an Esterline-Angus Model A-601-C chart recorder. All of the equipment was housed in a small van which included a pneumatically operated telescoping mast to permit measurement at an antenna height of 30 feet above ground.

At each location selected, the mast was raised to its full height, and one of the field meters was tuned to the appropriate channel. The antenna was then oriented for maximum signal, the meter calibrated, and a mobile run of 100 to 200 feet was recorded. (In many cases, a 10-db pad was inserted into the input of the field intensity meter so as to permit measurement near mid-scale on the meter.) The truck was then returned to a location on the path just traversed at which a signal of approximately median value was obtained. At that location, the signal was fed to the RCA television receiver, the receiver tuned, the photograph taken, and the picture quality grade established.

This technique was followed for each of the channels at each of the 203 locations. After all data was obtained for one location, the mast was lowered, field notes were completed, and the vehicle was then driven to the next location.

In grading the pictures, the six-grade TASO system was employed, which is similar

to other systems often used for this purpose. The grades are assigned numbers, 1 through 6, and were described in the TASO Report as listed in Table 3 (see Fig. 5). By these means the measured field intensity and the resultant picture quality were obtained for a station in each of the three television bands at each of 203 separate locations. These data may be analyzed in a number of ways.

In Figs. 6, 7 and 8, the data is plotted as a function of probability for the three stations; that is, the data was separated by picture quality, and all of the measured field intensity values for each particular grade of picture were plotted against probability. These data show some interesting effects.

We see, as one would expect, that higher quality pictures tend to be associated with higher values of field intensity. We also see, however, that there is considerable overlapping of data points. The data in Table 4 is taken from these graphs. Thus, we see that although the median value of field intensity increases as picture quality improves, there is a wide spread in the data. The greatest spreads were found for low-band VHF, with the values of field intensity for a given level of picture quality covering a spread of some 50 db. The variations on high-band VHF were slightly less, on

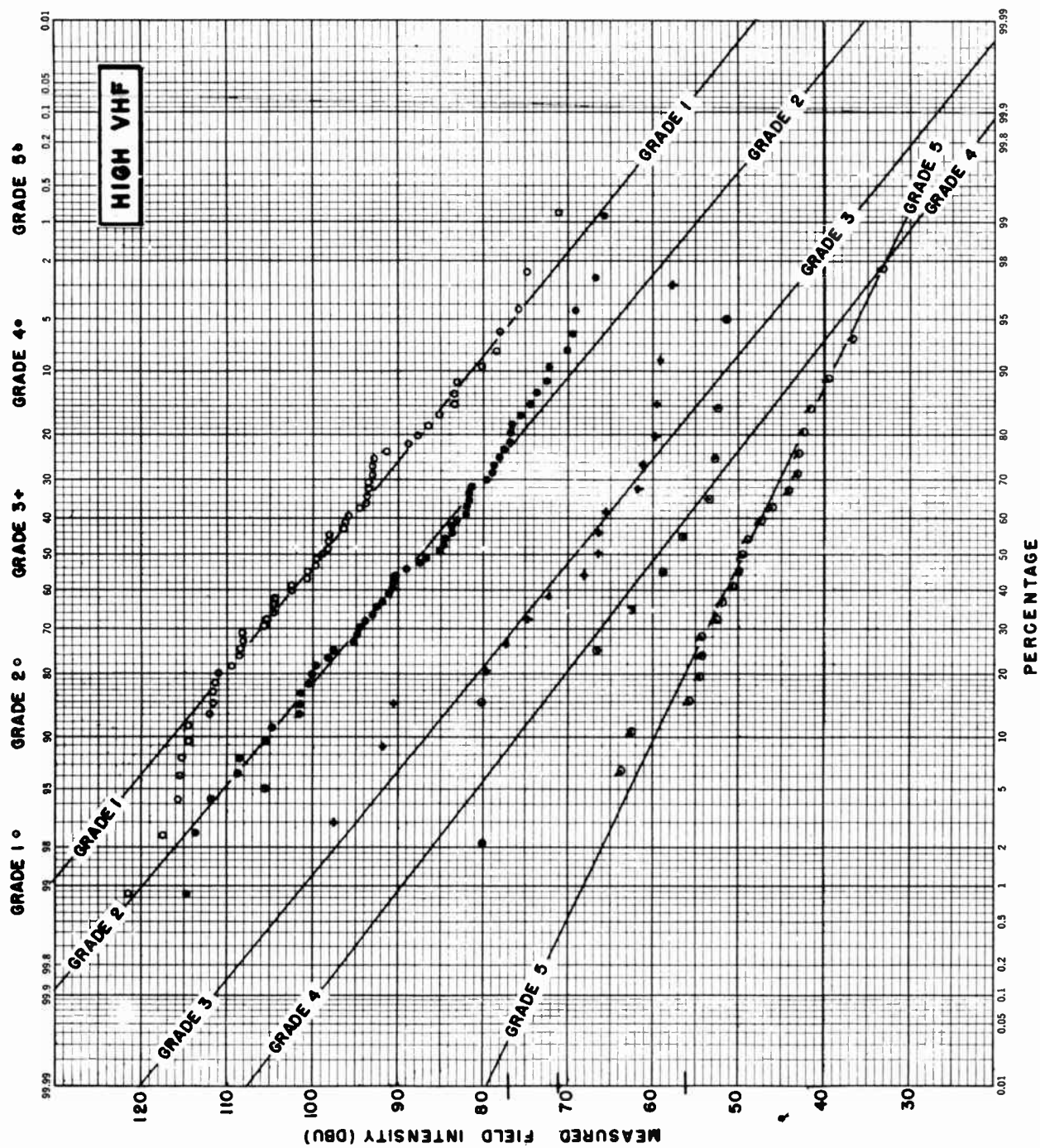

Fig. 7

TABLE 4
 MEDIAN FIELD INTENSITY BY PICTURE GRADES

Picture Grade	Measured Field Intensity (dbu)			
	Low-band VHF Median	Low-band VHF Range	High-band VHF Median	High-band VHF Range
1	78	48-103	99	71-122
2	74	51-106	87	66-115
3	59	38--77	69	58--97
4	54	30--83	59	51-105
5	47	21--65	49	33--80

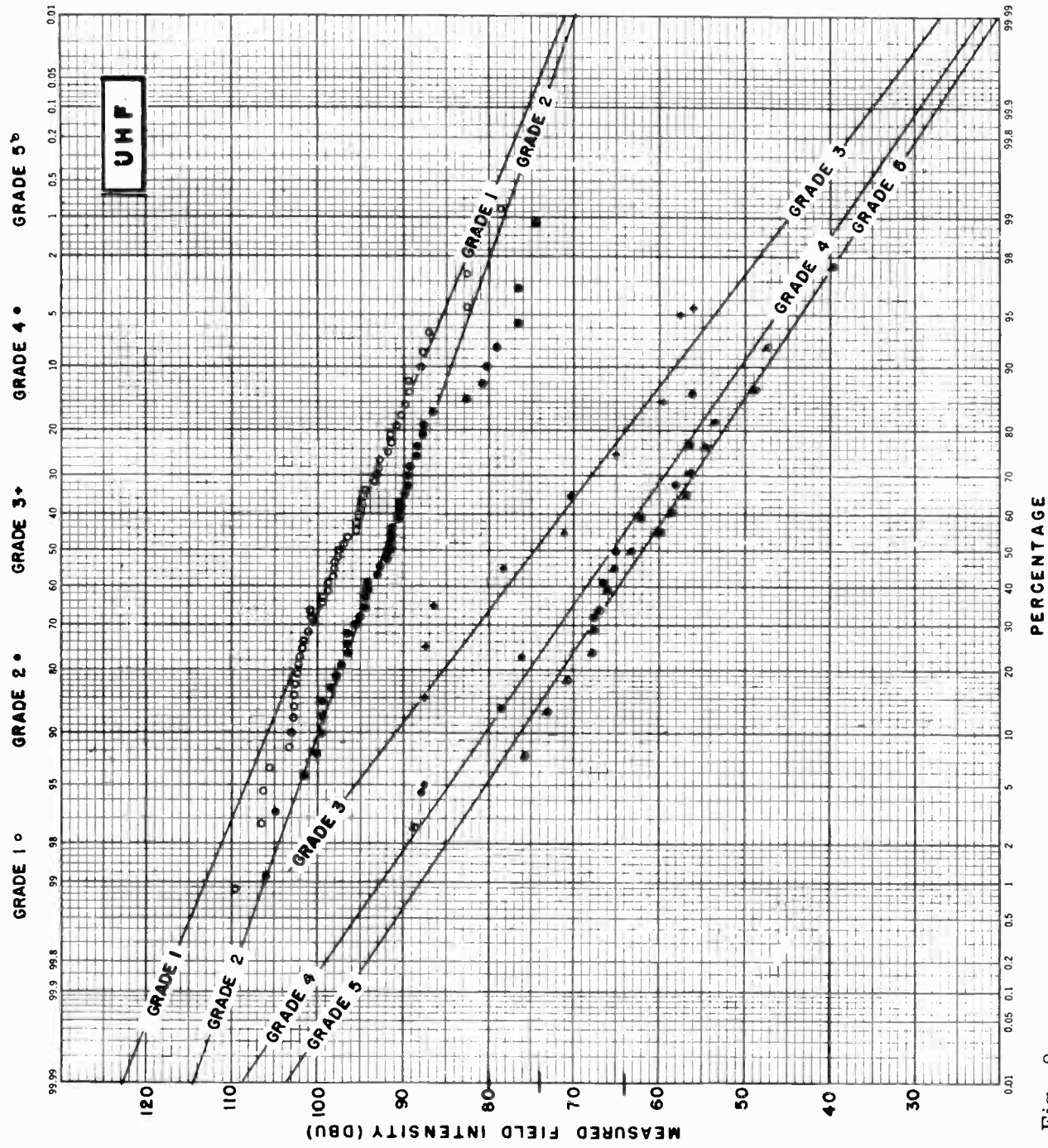

Fig. 8

LOW VHF

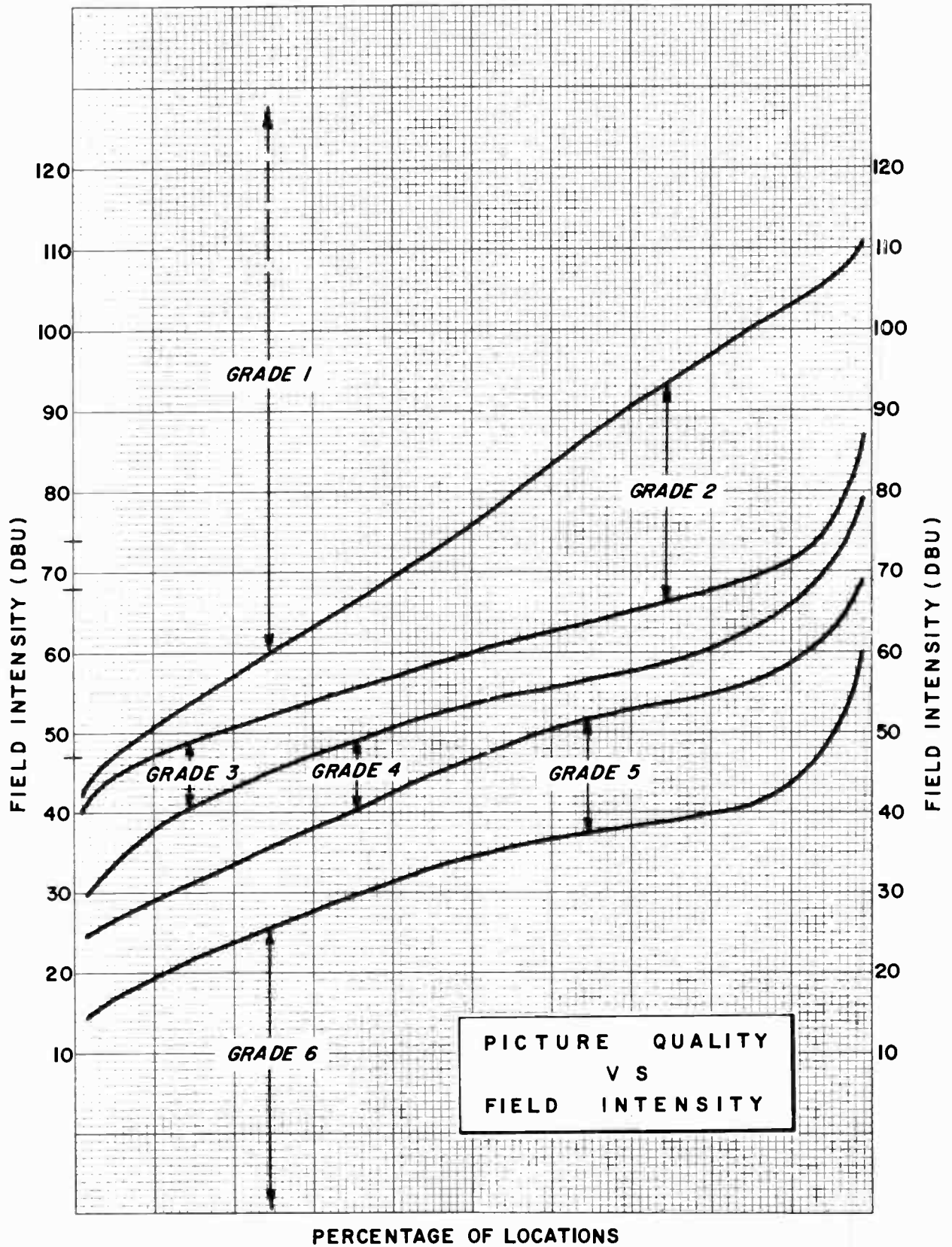

Fig. 9

the average, and the spreads at UHF were much less, being on the order of 30 db.

At low-band VHF, the differences in slope from one set of data to another are much greater than those found in any other band. As a matter of fact, the curves (lines) intersect. This should mean that, for instance, in low-band VHF, with fields higher than 95 dbu, there are more Grade 2 pictures than Grade 1 pictures. Or, for the same band, with a signal stronger than 64 dbu, more Grade 4 pictures than Grade 3 pictures are observed.

One's reason says that these things cannot be and that, therefore, there is perhaps an insufficiency of data. On the other hand, the results are not surprising, if one remembers that a great portion of the rating of picture quality in this study involved ghosting, and ghosting is independent of signal strength. Thus, it is likely that what the data really says is that, once a particular level of signal is reached, picture quality is affected predominantly by other factors. Therefore, for the low-band VHF Grade 1 and 2 data, it seems more nearly correct to conclude that, when the field intensity exceeds approximately 85 dbu, the grade of picture will depend on the extent of ghosting, and that a curve based solely on signal strength becomes meaningless at that point.

Although these plots provide certain information, their practical value is actually quite limited. They tell us what the field intensity is likely to be for a picture of a given quality, but they do not help us to anticipate the picture quality when field intensity is known, which is most often the case and which is the basic concern herein. In order to provide such information, the data has been reanalyzed, resulting in the rather unorthodox graphs in Figs. 9, 10 and 11.

In the construction of these graphs, the data was first separated by frequency band and then by field intensity "blocks." By this we mean that all picture quality data corresponding to field intensities between, say, 90.0 dbu and 94.9 dbu was grouped together, and the percentages of each quality level established. By plotting this data it was possible to establish the smooth curves shown. The vertical scale is field intensity in dbu. The horizontal scale is 100 units of percentage. If one selects a given level of signal strength, one can find the distribution of picture quality levels that would be expected for signals of that strength. For example, on low-band VHF, at the Grade A signal level (68 dbu), there are 38 percentage units in the Grade 1 area of the graph, 43 units in the Grade 2 area, 11 units in the Grade 3 area, and 6 units in the Grade 4 area. This means that (where conditions are identical to those existing during the subject study, of course) for a signal of 68 dbu on low-band VHF, 38 per cent of the locations would receive a Grade 1 picture, 43 per cent would receive a Grade 2 picture, 11 per cent would receive a Grade 3 picture, 6 per cent would receive a Grade 4 picture, and the remaining 2 per cent would receive either a Grade 5 or a Grade 6 picture. (When analyzing data on the basis of probability, it is, of course, impossible to arrive at a 100 per cent figure, since an element of uncertainty must always exist. Thus, the graph does not extend across the entire horizontal scale, and the percentage figures neared the ends of the scale are rather imprecise.)

These graphs may be used and compared in a number of ways. They show us that distinct differences exist from one frequency band to another, and that the relationship between field intensity and picture quality is not at all linear. To receive a usable picture—that is, Grade 5 or better—at 50 per cent of the locations, 34 dbu is required at low-band VHF, 40 dbu is necessary at high-band VHF, and 53 dbu is required at UHF. Similarly, for a perfect (Grade 1) picture at 50 per cent of the locations, 76 dbu is required at low-band VHF, while approximately 95 dbu is required for such quality at high-band VHF or UHF.

Fig. 10

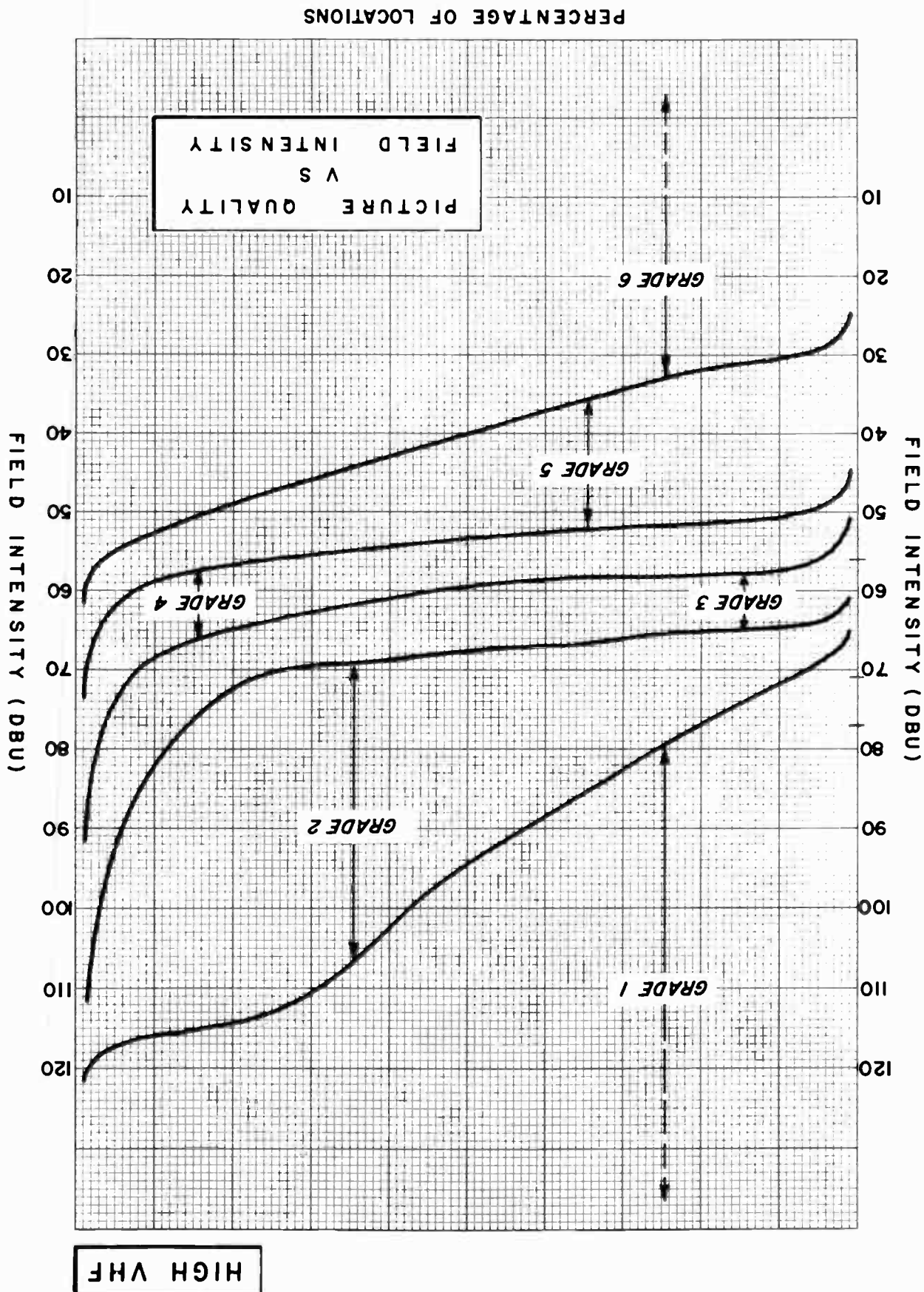

UHF

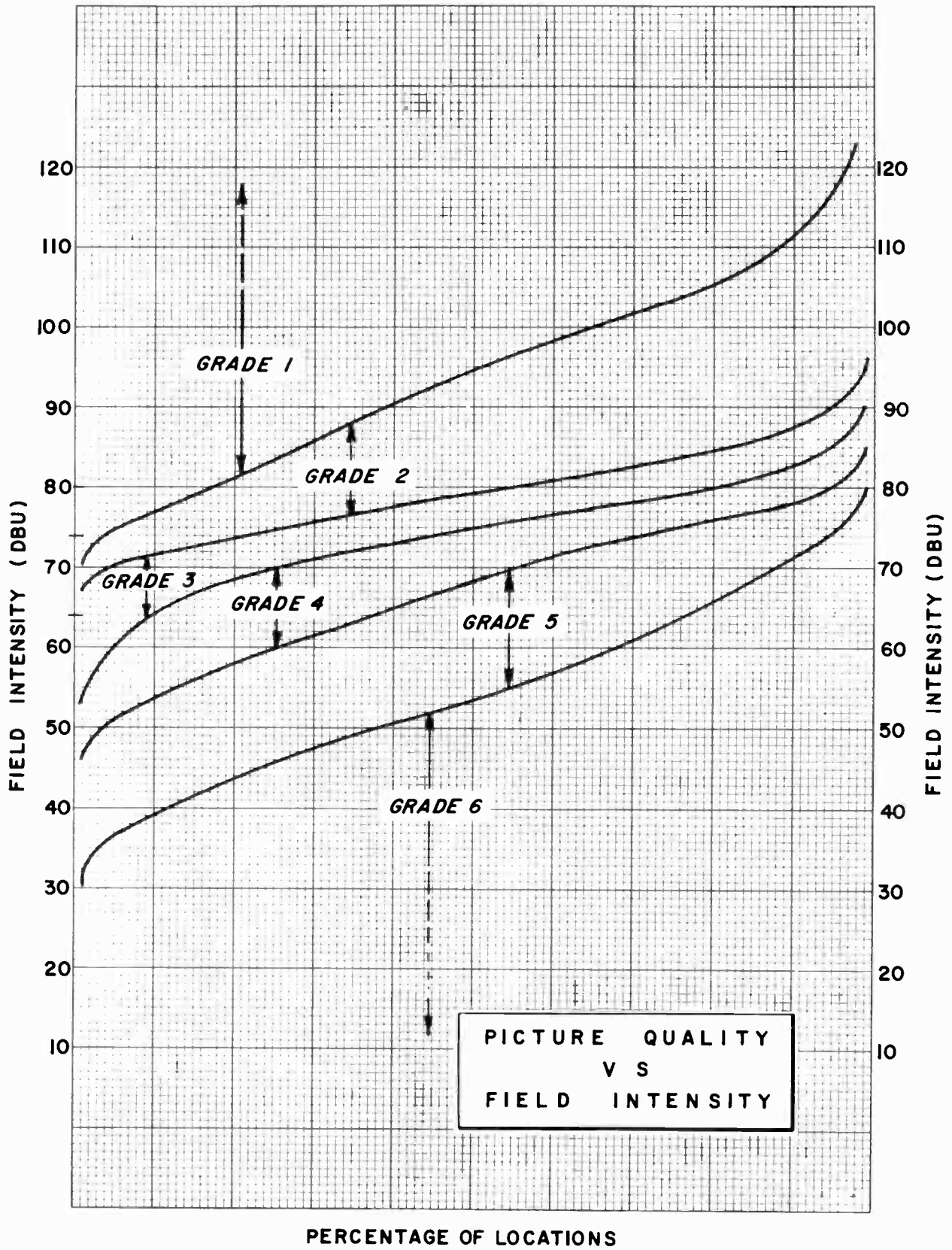

PICTURE QUALITY
V S
FIELD INTENSITY

Fig. 11

TABLE 5

DISTRIBUTION OF PICTURE QUALITY GRADES
AT GRADE B CONTOUR

Picture Grade	Percentage of Each Picture Grade		
	Low-band VHF	High-band VHF	UHF
1	5	<1	<1
2	4	<1	<1
3	20	5	10
4	22	69	28
5	42	23	39
6	7	3	23

At the Grade B level, the data in Table 5 was found. These data show that if one assumes that a Grade 4 picture is the poorest quality to be considered usable (Grade 5 being unacceptable for viewing by most people), the Grade B specification for low-band VHF is quite suitable, since 51 per cent of the Grade B locations would receive at least a Grade 4 picture. For high-band VHF, 74 per cent would be so served at that signal level, but at UHF, only 38 per cent would receive a usable picture. At high-band VHF and UHF, no appreciable number of Grade 1 or 2 pictures are found at the Grade B contour, but 9 per cent of the low-band VHF pictures are in those grades at that level of signal. On the other hand, there are more Grade 6 pictures at low-band VHF than at high-band VHF, and many more at UHF.

One of the interesting points found in the graphs is that, for high-band VHF, the curves defining the upper limits of Grades 3, 4, and 5 have only a slight slope across most of the graph. Although all of the graphs show the greatest uniformity and the least slope in this region, the phenomenon is not nearly so marked for the other bands. What this suggests is that for these values of picture quality, field intensity is vastly the most important factor in picture quality, and the relationship between the two is very nearly linear. Thus it may be seen that, at the Grade B signal level, only 5 per cent of the pictures are of Grade 3 quality, but an increase of 6 db in signal strength would result in Grade 3 pictures at 62 per cent of the locations. As a comparison, it may be seen that, at City Grade level for high-band VHF, 19 per cent of the pictures are of Grade 1 quality, but an identical increase in signal strength of 6 db in this case increases the instances of Grade 1 pictures only to 29 per cent.

Even though the data on which these curves are based is insufficient to establish any great truths about television service, the phenomenon just observed forces the conclusion that an improvement in received field intensity provides picture quality improvement most noticeably where middle grade pictures are found, and a much greater increase in signal strength is required to provide significant improvement for the highest and lowest grades of pictures. In other words, a power increase would convert a great many Grade 4 pictures into Grade 3 pictures, but the Grade 6 pictures turned into Grade 5 pictures would be many less in number, as would the Grade 2 pictures that improved into Grade 1.

This effect is quite logical. The observable difference between Grade 1 and Grade 2 pictures is very often in the presence of a slight ghost. Such a ghost would probably not be noticed in the noisier Grade 3 and 4 pictures. On the other hand, the difference between Grade 5 and 6 pictures is most often a function of the ambient noise level at the particular receiving location, while, for Grade 3 and 4 pictures, the differences in noise level from location to location are not so noticeable. Thus, signal strength is most important where medium grade pictures are received.

From these curves, one could establish a set of coverage contours, different from those now employed, that would relate more directly to the quality of picture received. The standards might be as follows:

GRADE B: Grade 4 picture or better at 50% of the locations

GRADE A: Grade 2 picture or better at 50% of the locations

CITY GRADE: Grade 1 picture at 50% of the locations.

TABLE 6

SUGGESTED SERVICE STANDARDS

Band	Field Intensity (dbu)					
	City Grade		Grade A		Grade B	
	Present	Suggested	Present	Suggested	Present	Suggested
Low VHF	74	76	68	60	47	47
High VHF	77	94	71	68	56	54
UHF	80	95	74	79	64	68

The field intensity values for such standards (with the present values included as a reference) would be as listed in Table 6. There are two significant points to be made from this table. In the first place, the general similarities are quite striking. In seven of the nine sets of figures, the present and suggested values differ by no more than 8 db, suggesting that the Commission's standards do indeed illustrate reasonably comparable levels of service. The other matter of importance is that, for City Grade service on high-band VHF and UHF, the present standards are optimistic by 15 db or more. This means that for excellent pictures at these frequencies, much more signal is required than had previously been assumed. But why should the City Grade level for low-band VHF agree so well with the level required for Grade 1 pictures?

The answer is simple. A substantial factor for the effects of urban noise on low-band VHF reception is included in the City Grade specification, but such noise is only significant in the more industrialized portions of a city and has little effect in the outlying residential areas. Thus, this disadvantage is realized in only a small percentage of the locations and tends to show its effects mainly by introducing additional scatter in the low-band VHF data.

It thus would appear that the above data should provide a very practical means of defining television coverage. However, before such a conclusion can be reached, a

TABLE 7

QUESTIONS REGARDING VALIDITY OF SURVEY DATA

1. How accurate is the field intensity data?
2. How accurate are the corresponding picture quality ratings?
3. To what extent is the data sufficient for detailed analysis?
4. Are the measured stations representative of all stations?
5. Is the locality representative of all localities?
6. Is the receiving installation representative of all receiving installations?

number of doubts, as listed in Table 7, must be resolved. Points 1 and 2 present few problems. The measurements were based on the well established TASO technique, and the instruments were calibrated by the National Bureau of Standards. Although the picture quality determinations are a more subjective sort of thing, in this particular case the screen was photographed for each channel at each location so that others could use the photographs for independent evaluation. In all cases, although all observers did not agree on all pictures, the overall ratings were remarkably similar, suggesting that the picture quality ratings were not unduly influenced by a single viewer's idiosyncrasies.

The third point is a significant one. Based on 609 observations at 203 locations, the data is insufficient for any real generalizations, particularly with regard to the middle grades of pictures. If the subject study has been designed expressly for the purposes of this discussion, much more data on middle grade pictures would had been obtained, and much less data on Grade 6 pictures would have been accumulated, since it is worth little in this discussion.

With regard to the particular stations and the particular locations studied, there is no reason to believe that these are not representative of all stations and localities, but one could not be sure of this without obtaining at least some similar data on other stations in other places. These questions must, therefore, be left unanswered.

The sixth question is the most important. The receiving installation is made up of an antenna, a transmission line, and a receiver. In order that the test results be as representative as possible, a number of different receivers should be tested, even though the receiver employed in the subject survey is believed to be reasonably representative of the television sets presently on the market. Furthermore, all observations in the subject study were of a monochrome picture, and data based on color pictures would be a valuable addition (although it is the author's experience that there is seldom a serious statistical difference between monochrome and color quality ratings).

The transmission line is a minor matter, and differences in line from one installation to another are a relatively small factor; however, the antenna used is of great sig-

nificance, and this is the most critical factor in extrapolating this specific data into the realm of the general. It has already been pointed out that the antenna was represented to be typical of those in use in the area studied. Its characteristics, however, are not the same as those assumed in the establishment of the Grade A and B signal strengths. The gain figures are listed in Table 8.

TABLE 8
COMPARISON OF ANTENNA GAINS

Band	Antenna Gain (db)	
	Assumed by FCC	Used in Survey
Low-VHF	0 (city), 6 (rural)	2
High-VHF	0 (city), 6 (rural)	7.5
UHF	8 (city), 13 (rural)	7

It may be seen that the gain figures assumed by the FCC do not agree very well with the gain figures of the antenna employed in the subject survey. In urban areas, the Commission assumed the use of rabbit ears, or the equivalent, for VHF and an antenna gain of 8 db for UHF. For rural areas it was assumed that VHF antennas would have a gain of 6 db, with 13 db gain assumed for UHF antennas. The subject antenna had a gain of 2 db at low-VHF and approximately 7 db a high-VHF and UHF. Is either set of figures realistic in terms of present usage?

In urban areas, rabbit ears are commonly used for VHF reception, particularly for the second and third sets in a home. In such instances, however, a UHF loop antenna is usually used, so the assumption of 8 db gain would seem optimistic. Where an outside antenna is employed, it is either an all-channel antenna similar to that used herein, or it is designed for VHF only.

Thus, in a city, when indoor antennas are used, the Commission's assumptions are reasonable for VHF but seem optimistic for UHF. Where outside antennas are installed, the assumptions are reasonable for low-VHF and UHF, but not for high-VHF. It should be pointed out that, with all-channel antennas, while the size of the antenna (and, consequently, its gain) may vary, the relationships of the gain figures for the three bands tend to remain similar to those shown above, with high-VHF and UHF gains similar (except for the very highest UHF channels) and low-VHF gain several db less. In rural areas, the Commission appears to have been optimistic about low-VHF and UHF gain, but reasonably correct for high-VHF.

It is, therefore, difficult to resolve the last question. The author, as you might expect, believes that the gain of the antenna used is more typical than the gain figures assumed by the FCC. One may, however, believe that the Commission's assumptions, or some other assumptions, would be more appropriate and still make use of the curves included in this report by shifting the horizontal scale so as to correct for the difference in assumed gain. For example, if a UHF antenna of 13 db gain is assumed for rural areas, one need simply refer to the 70 dbu line on that graph (64 dbu plus 6 db) to establish the expected picture quality percentages at the Grade B Contour. (This process, of course, does not account for changes in ghosting resulting from the use of a higher or lower gain antenna.)

If one is to utilize these curves, it is important to remember that they represent a comparison of measured field intensity and picture quality. These picture quality rat-

ings would compare to predicted field intensity only if the predicted values were actually achieved, and this is often not the case, particularly in the UHF band. Thus, these curves should be used with the understanding that, if the predictions of received field intensity are not correct, the picture quality provided also will not agree with the prediction.

Based on the above, we may conclude that we have established a set of curves by which one may predict the quality of picture delivered in the viewers' homes, within the limits of accuracy as discussed above. From these curves we may make a number of conclusions about television service, among which are:

Changes in signal strength affect middle grade pictures more noticeably than the very good or very bad pictures.

The relationship between picture quality and field intensity is not at all linear, although it is more so for middle grade pictures and for high-band VHF.

The optimistic assumptions about UHF antenna gains seem to have resulted in somewhat optimistic UHF contour values.

The pessimistic assumptions about urban noise seem to have resulted in a pessimistic low-band VHF Grade A standard.

Even though the current FCC contour value standards are far from precise, in a general sense, and as thought of in day-to-day usage, these standards do provide a realistic picture of station coverage.

I would like to express my appreciation to the American Broadcasting Company, Western Telecasters, Inc., and Radio-Television, S.A., for permitting the use of certain of the data in this presentation. I would also like to thank Frank Kear and Bob Kennedy for their assistance during the field survey, George A. Powstenko for creating the illustrations, and G. Fred Bode, who was my partner during the entire field project and without whom this information could not have been accumulated.

Magnetic Tapes in the 70's

H. Lee Marks
3M Company, St. Paul, Minn.

As the television industry launched itself into a new decade, rumbles were being heard concerning improvements in television recording. This news of better things to come seemed to be all encompassing. From a hardware standpoint, promises of new and improved video recorders were being backed up by introductions of sophisticated machines for both quadruplex and helical recording. The industry began using a new type of video tape that guards itself against damage. Several announcements and demonstrations have been made concerning revolutionary approaches to the duplication of recorded video material. All this is fascinating and important to our developing industry, but a common denominator that cuts across all of the topics that we have mentioned is the capability of the magnetic recording medium itself.

There have been vast improvements in the last decade. Improvements that took us from what we thought was as good a black-and-white picture as anyone would ever expect from a recording, to the kind of flawless, well defined, richly colored pictures that each of us expects to see on our monitors today. The low-noise oxide, introduced in the sixties, coupled with advanced, clean running binders, was an important breakthrough moving us toward that excellence that we now take for granted. Because of the improved signal-to-noise ratios attainable with the low-noise oxide, multiple generation dubbing was not only possible, but became the accepted way to produce everything from a dog food commercial to a 90-minute extravaganza. In the close analysis, the oxide on the tape has caused a lot of changes in the television broadcast industry, and it appears that these changes are not about to stop.

In exploring new ways to make even further improvements in the electromechanical properties of video recording tapes, it appeared that we had gone just about as far as was possible with our present-day family of synthetic low-noise oxides. If we wanted to see a meaningful improvement in the key recording characteristics of both RF output and signal-to-noise ratio, we would have to enter into some extensive research centered upon modifying the basic oxide particle.

After many years of work, and extensive application evaluation, we were ready to announce the result of this basic research. We had succeeded in developing a new family of oxides that offered all the features indicated in the objectives of our tape design engineers. The products in which the new oxides are used are referred to as high-energy tapes because of the higher output that can be derived by proper application of this new recording media.

Since it is generally well known that a higher output can be predicted when the coercive force and remanence of a tape are increased, it was an adjustment in these parameters that made this breakthrough possible. We achieved the needed increase in coercivity and remanence by modifying the composition of the gamma ferric oxide and properly dispersing it in a binder system. A small amount of cobalt has been introduced into each particle of oxide in a manner that allows the control of the resultant coercive force to a predetermined level. This technology of introducing cobalt into the particle to increase coercive force has been known for years by the chemists in the industry, but results in the past were disappointing in that the introduction of the cobalt detrimentally altered the particle size and shape. This altering of particle

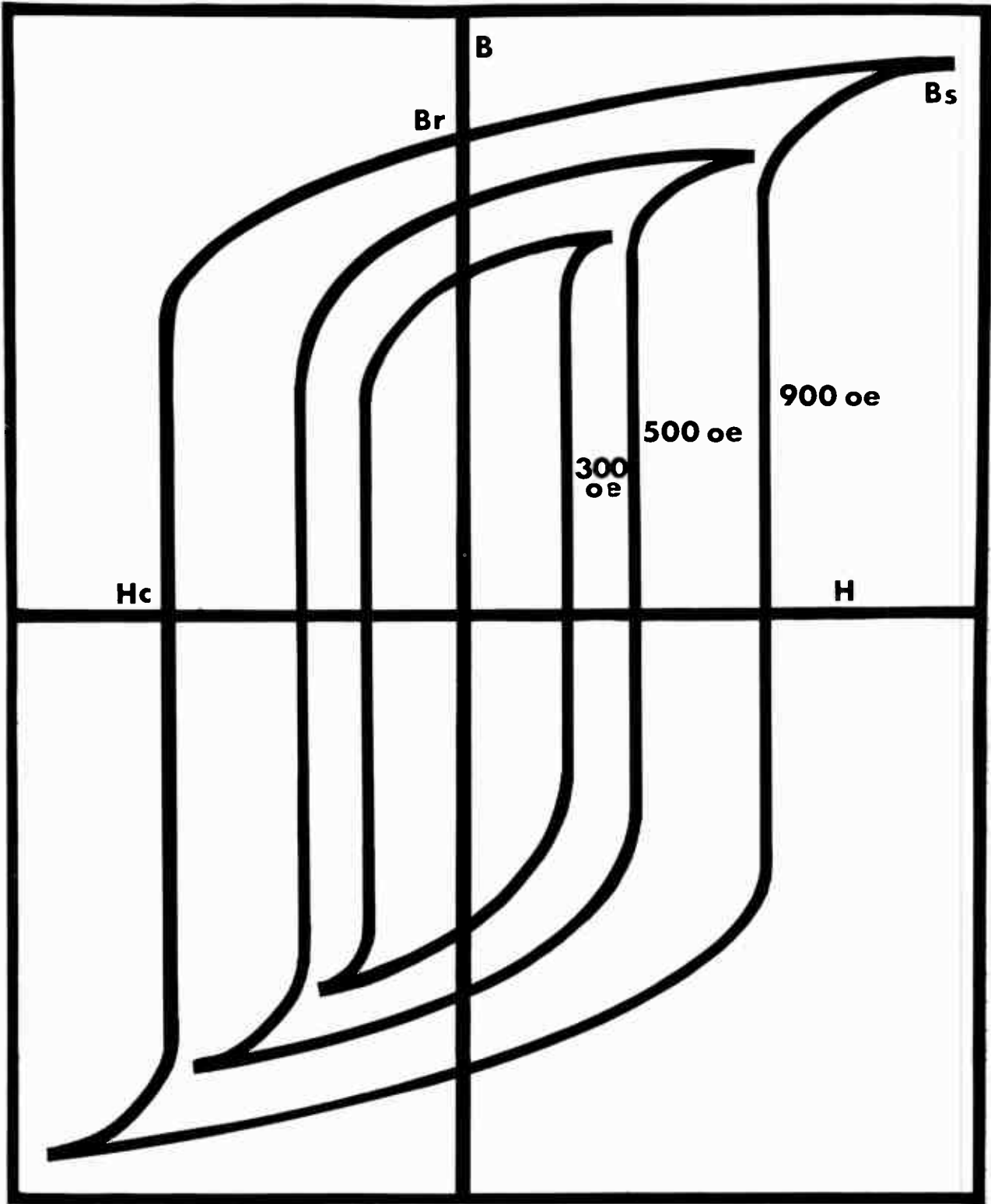

B-H HYSTERESIS LOOPS

Fig. 1

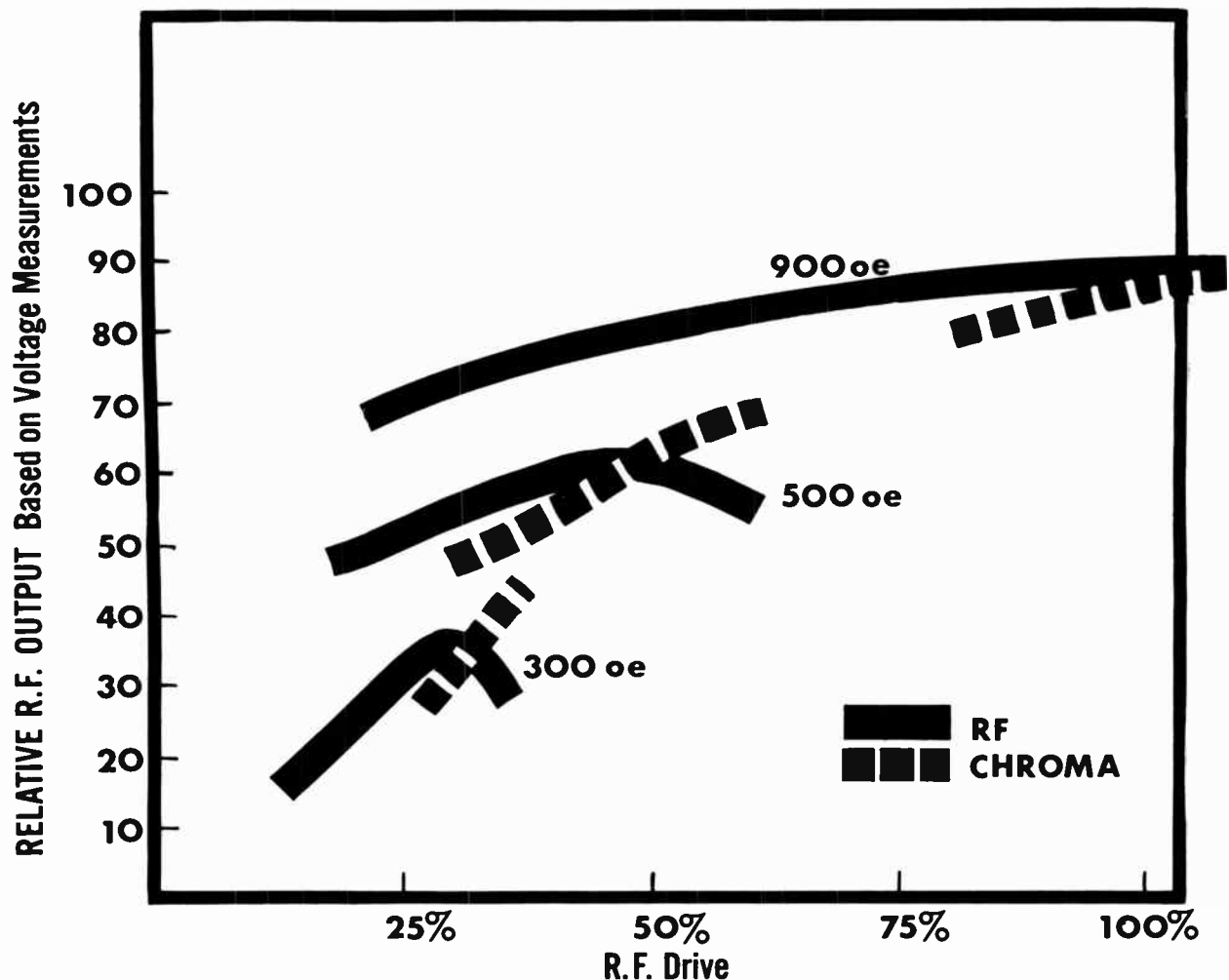

R.F. OUTPUT AND CHROMA RESPONSE VERSUS R.F. DRIVE QUADRUPLEX

Fig. 2

size and shape had an adverse effect on the signal retention of the tape, especially when it was heated or flexed. With the development of this new technology, it is now possible for us to produce high energy oxide that has the same controlled particle size and shape as the gamma ferric oxide. As a result, it has the same signal retention ability as the gamma ferric oxide.

This new oxide technology enables the tape manufacturer to tailor make magnetic tapes with coercive force values from as low as 300 oersteds to as high as 1000 oersteds, while maintaining retentivity values in the 1200 gauss range.

We could now use this proprietary oxide to develop a family of tapes that would provide immediately noticeable benefits to the user. When used to manufacture video tapes, both improved signal-to-noise ratio and increased RF output are achieved. Because of the ability to control the coercive force in the finished product, tapes can be specifically designed to accomplish a specific purpose. We are currently producing tapes for both quadruplex and helical recording with coercivities of 500 and 900 oersteds. The 500 oersted version is totally compatible with video recorders that are in use today, and the 900 oersted tape will find use in the field of advanced systems technology. It is interesting to note that the benefits just described were accomplished

without the need for the usual technical tradeoffs that plague design engineers. These new high-energy tapes still incorporate the best features of present day tapes in the areas of physical handling, tape wearability and head life.

The classic means used to compare the capabilities of various oxides is the familiar hysteresis loop. An analysis of the loop provides us with three important parameters. These are the saturation value, referred to as B_s , the amount of retained flux, known as B_r , and the amount of energy required to reduce the retained flux to zero, called the H_c . These three properties, as well as the shape and size of the oxide particle, determine the magnetic capabilities of the finished tape.

In Fig. 1, we see three hysteresis loops. The small one represents the pattern seen for conventional video tape, such as scotch Brand No. 400. The next largest is a trace of the loop formed by a compatible 500 oersted high-energy tape, and the largest describes an experimental 900 oersted high-energy product. The three important points are labeled on each of the three curves. Saturation, or B_s , is seen in the first quadrant in the upper right-hand corner. The amount of retained flux, B_r , is seen on the positive vertical axis and the H_c or energy required to reduce the flux to zero appears on the left. In this type of measurement, a great deal can be learned from the shape and size of the curve in the second quadrant between the points B_r and H_c . The amount of area that lies under the curve in this quadrant is a measure of the relative energy available from that oxide for recording.

Notice the additional area gained by the two high-energy products. Inspection reveals that the 900 oersted tape yields nearly four times the area of conventional 300 oersted oxides. And the 500 oersted tape encompasses an area that is about twice as large. This extra energy that is available can, of course, be used to good advantage for television recording.

One of the things to investigate in evaluating a new video tape formulation is the amplitude of RF output seen when this tape is played back. There are three sets of curves in Fig. 2 that illustrate this. The curves next to the 300 oersted label will be used as a reference because they are typical of conventional tapes currently in use for quadruplex recording, such as scotch Brand No. 400. Here, represented as a solid line, we see the traditional optimization curve showing the peak being reached at a point slightly above the level that represents 25% of the available RF drive used in recording the tape. The relative output on playback is seen on the scale as reaching 40 units. While this peak level of 40 on the vertical axis is important for making comparisons with tapes with greater coercive forces, noting the shape of the curve is important, too. We see here that the optimization curve rises rather steeply to the peak and then descends with equal steepness.

When we compare the optimization curve for the 500 oersted high-energy tape, we immediately notice a 4 db increase in RF output. We notice also that the entire curve is positioned farther to the right, indicating that additional RF drive was used when the tape was recorded. We mentioned that the 500 oersted high-energy tape was compatible with today's recorders. This curve substantiates this, as the entire curve falls well within the available RF drive. The peak, or actual optimization point, falls at about 45% of the maximum drive utilizing a 1.5 mil gap depth. While a new head that has full gap depth requires more drive, the record drivers have more than enough range to easily obtain optimization.

The shape of the 500 oersted curve is quite different than that representing the 300 oersted conventional video tape. It is not as steep and this is a convenient advantage. The operator performing the optimization will notice a broader optimization range, making it easier to adjust for the desired maximum. This broadened range also means that RF drive optimization need not be performed as often throughout the life of the video head assembly.

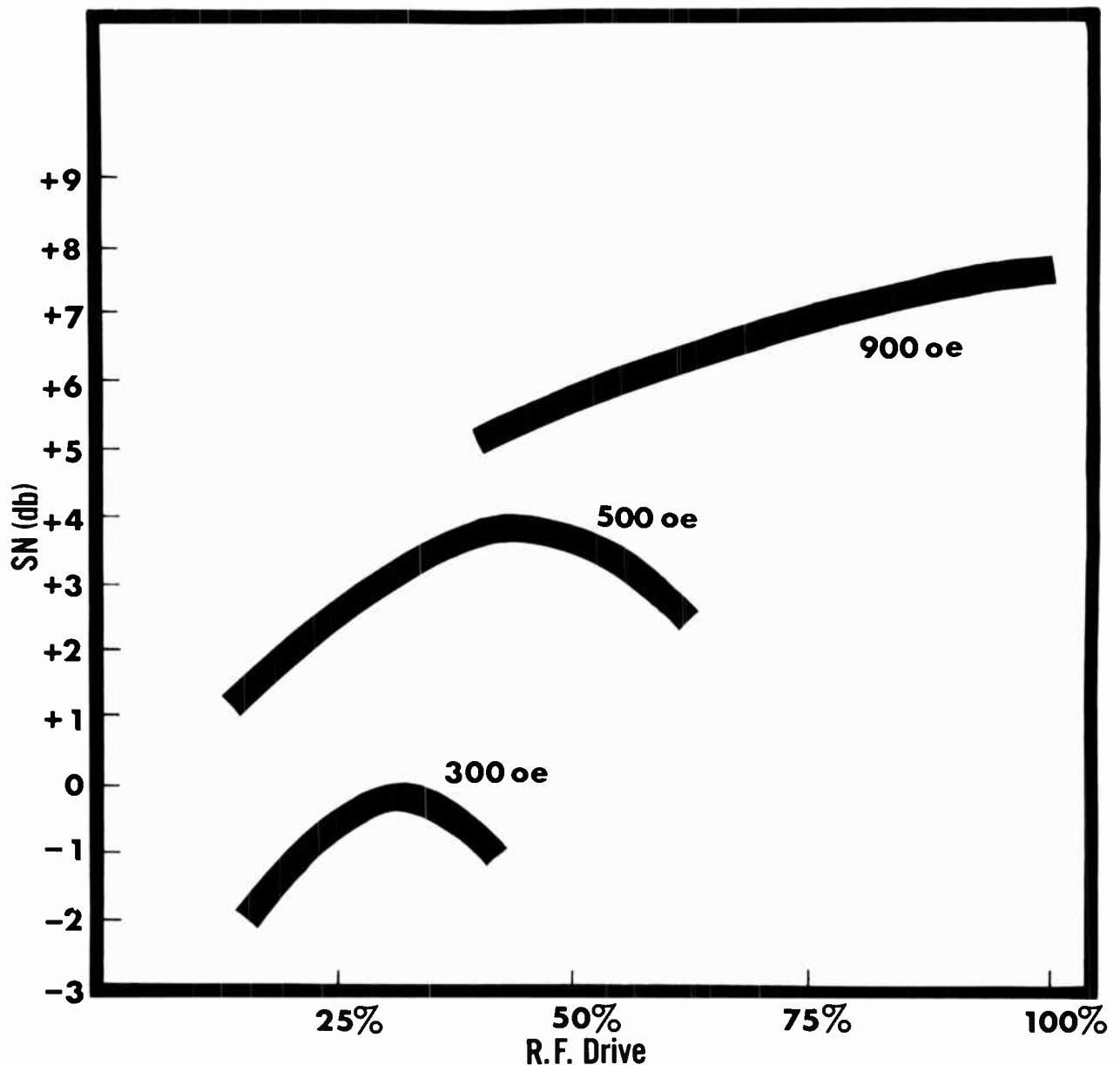

S/N VERSUS R.F. DRIVE QUADRUPLEX

Fig. 3

The broken lines in the figure indicate the chroma slope for each of the tapes. This represents the equalization change that is needed to compensate for wear on the video head pole tips. As the tape coercivity is increased, the slope of this line decreases, meaning that less correction is needed to maintain proper equalization. Just as was true when speaking about RF drive, the equalizers, too, would not require adjustment as often and such adjustment would be less critical.

The uppermost solid curve is representative of the 900 oersted experimental product. This tape is not designed to be compatible with recorders in normal use. As can be seen, the RF drive was set at maximum to obtain optimization. The head that was used was specially selected for this test to provide the efficiency needed to attain the optimization point. While we agree that this does not represent normal operating conditions for present equipment, it does clearly demonstrate the rather dramatic 7.5 db increase in RF output that this 900 oersted tape will yield, when compared with the 300 oersted tape that is the standard of the industry today.

The optimization curve is even more broad than it was with the 500 oersted tape and the chroma slope is approaching the horizontal. It is evident that when machines are readily available that will make use of tape in the coercivity range, the need for repeated RF drive and equalization adjustment will be minimal.

Signal-to-noise ratio is a key parameter and a much discussed topic when speaking in terms of picture quality. This is especially true where video tape is concerned. Great strides in this direction have been made by camera designers, switching and processing equipment manufacturers and by the builders of the quadruplex recorders themselves. With the advent of the high-band color standard, companies such as ours introduced video tape manufactured with low-noise oxide. Master tapes were clean and quiet. So quiet, in fact, that it was now possible to produce a second or third generation dub that looked as good as the master would have looked using the former tape. It wasn't long and multiple generation editing and dubbing was the standard way of doing business.

A meaningful improvement in the signal-to-noise ratio of the recording tape for today's as well as tomorrow's applications is the second very important benefit that is gained with the use of the high-energy oxide. In Fig. 3, we see a set of curves that, at first glance, look a great deal like the ones in the previous drawing. Once again, on the X axis, we see RF drive indicated in per cent of maximum. On the Y axis, however, we have shown signal-to-noise referenced to optimum conditions for the 300 oersted tape. The peak on the bottom curve, then, is zero db. The improvement in signal-to-noise ratio, when using the 500 oersted tape, amounts to an impressive 4 db. Once again, we should restate that this will be achieved on today's recorders without any modification. All that is necessary is a normal optimization adjustment.

On the same drawing, we have also shown a plot for the 900 oersted tape. With the specially selected head and maximum RF drive, we realize a 7 1/2 db improvement over the reference tape. This, of course, is not a compatible product, but does stimulate the imagination as we look to the future, to a time when machines are designed that can supply the additional RF drive needed to properly record it and sufficient erase fields so that it can be erased and used again.

The additional 4 db gained in signal-to-noise ratio, when using the 500 oersted tape, is particularly advantageous when one considers that most release tapes today are

	1ST GENERATION		2ND GENERATION		3RD GENERATION			4TH GENERATION			Change From 300oe Master	
	Master Tape Type	Established S/N	Dupl. Loss	Work Master Tape Type	Resultant S/N	Dupl. Loss	Edited Master Tape Type	Resultant S/N	Dupl. Loss	End Copy Tape Type		Final S/N
1.	300oe	50	1.5	300oe	48.5	1.5	300oe	47	1.5	300oe	45.5	-4.5
2.	500oe	54	1.5	500oe	52.5	1.5	500oe	51	1.5	500oe	49.5	-0.5
3.	500oe	54	1.5	500oe	52.5	1.5	500oe	51	2.0	300oe	49.0	-1.0

MULTIPLE GENERATION S/N COMPARISON

Fig. 4.

really fourth generation copies of a master. With the aid of the chart in Fig. 4, we can easily compare several combinations of multiple generation dubbing.

The first example, labeled Number 1, charts the progression of the four generations using 300 oersted tape in each step. This is the way things are being done now, using conventional video tape. Moving to the right through the first example, we notice that the established signal-to-noise ratio of the master on the 300 oersted tape is 50 db. We have placed a circle around that number because it will be used for comparisons with the other examples. As we move into the second generation that will also be on 300 oersted tape we encounter a loss in duplication of 1.5 db in SNR. The second generation copy will have a signal-to-noise ratio of 48.5 db. The duplication loss into the third generation is again 1.5 db, and the same is true for the fourth generation. This final copy has a signal-to-noise ratio of 45.5 db which is down 4.5 db from the original master. I think we will all agree that today's masters on 300 oersted tape are excellent, but we will also agree that the final, fourth generation copy does not exhibit that same degree of excellence. It's good and it's usable, but how often have we all said that it is a shame that we can't air the master.

Look, now, at the second example. Here, the master and each of the succeeding generations were made on 500 oersted, high-energy tape. With this product, the master reflects the 4 db improvement in signal-to-noise ratio so we begin with 54 db. Each generation of copying will again reduce the ratio by 1.5 db. This results in a fourth generation copy with a SNR of 49.5 db. When we compare this to the original master recorded on 300 oersted tape, we see only one-half db difference. We have now succeeded in producing a fourth generation copy that is as good, visually, as the traditional master made on conventional tape.

The third example indicates the use of the high-energy tape throughout the mastering and editing steps, but here conventional tape was used for the final fourth generation copies. The first three generations are the same as example Number 2, with 1.5 db duplication loss per step. As we move into the fourth generation, that will be recorded on standard 300 oersted tape, we will encounter a 2 db duplication loss. The net result is a final copy with a signal-to-noise ratio of 49 db. This is an insignificant one-half db down from a final copy made on the new high-energy tape and a barely perceptible one db below a conventional 300 oersted master.

The numbers on the chart clearly suggest that for almost all fourth generation release copies, it would be wise to master and edit on high-energy tape and economically sound to produce those final copies on traditional video tape. In those instances when the absolute ultimate in SNR is required, an extra one-half db can be gained by using high-energy tape throughout the entire process.

Our discussion to this point has centered about the 500 oersted product. We have seen from the previous curves, however, that both RF output and signal-to-noise ratio are greatly improved as the coercivity is increased. Since the high-energy oxide lends itself so well to being tailored to yield a wide range of coercive force, it is our hope that future machine designs will take advantage of this aspect. For a given application it may be that a system making use of 650 oersted tape would be ideal. For another use, 825 or 435 might render optimum performance. Tape is no longer the limiting factor in the recording process. High-energy tape is a reality. All that is needed now is the hardware to take advantage of this breakthrough.

We say this as a preface to our closing discussion on the application of high-energy tape to the field of helical video recording. Here, just as with the quadruplex systems previously discussed, increased coercivity of the recording tape has the capability of yielding an increase in both RF output and signal-to-noise ratio.

Fig. 5 contains the optimization curves for the standard 300 oersted helical tape

now in use, as well as two high-energy constructions. Once again, RF drive is plotted along the bottom in terms of the drive that is available and relative RF output appears along the vertical axis. Notice that with traditional tape optimum drive is about 50% of what is available. The 500 oersted high-energy tape will require about 70% of the total available drive and would deliver 4 db more RF output. This, of course, is compatible with present day equipment.

We have also shown a curve representing a 700 oersted experimental product. Even with the use of a specially selected video head, we were just able to reach the optimization point. You will notice, however, that the increase in RF output amounts to 6 db. Just as we noticed with the quadruplex examples, as we increase the coercivity the curve becomes more rounded and loses its steepness. This would again mean that optimization adjustments would be less critical and that they would be required less often.

Signal-to-noise ratio is also increased with the higher coercivity tapes. Fig. 6 plots RF drive against SNR for the three tapes being discussed. Using the standard 300

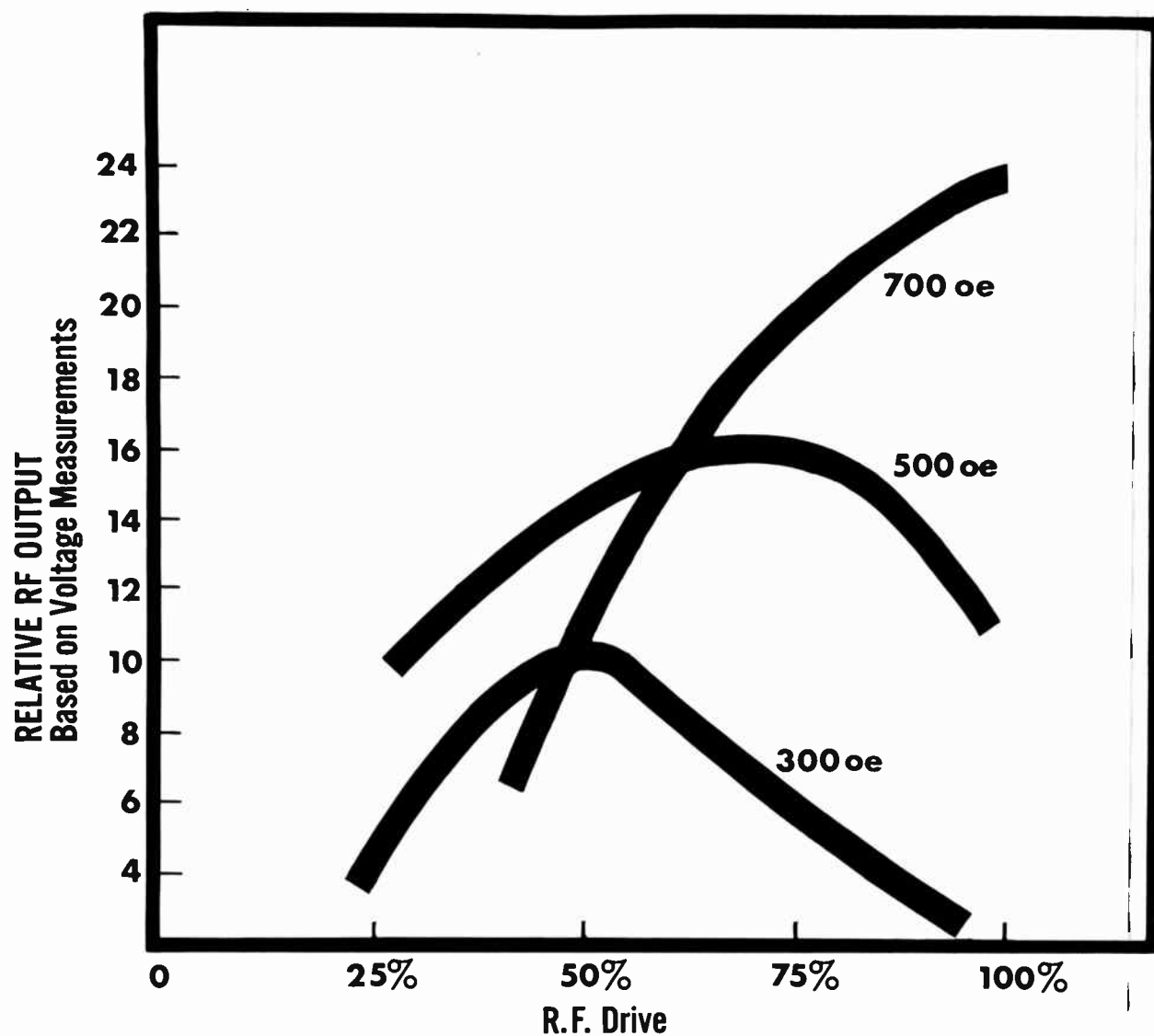

**R.F. OUTPUT VERSUS R.F. DRIVE
1" HELICAL**

Fig. 5

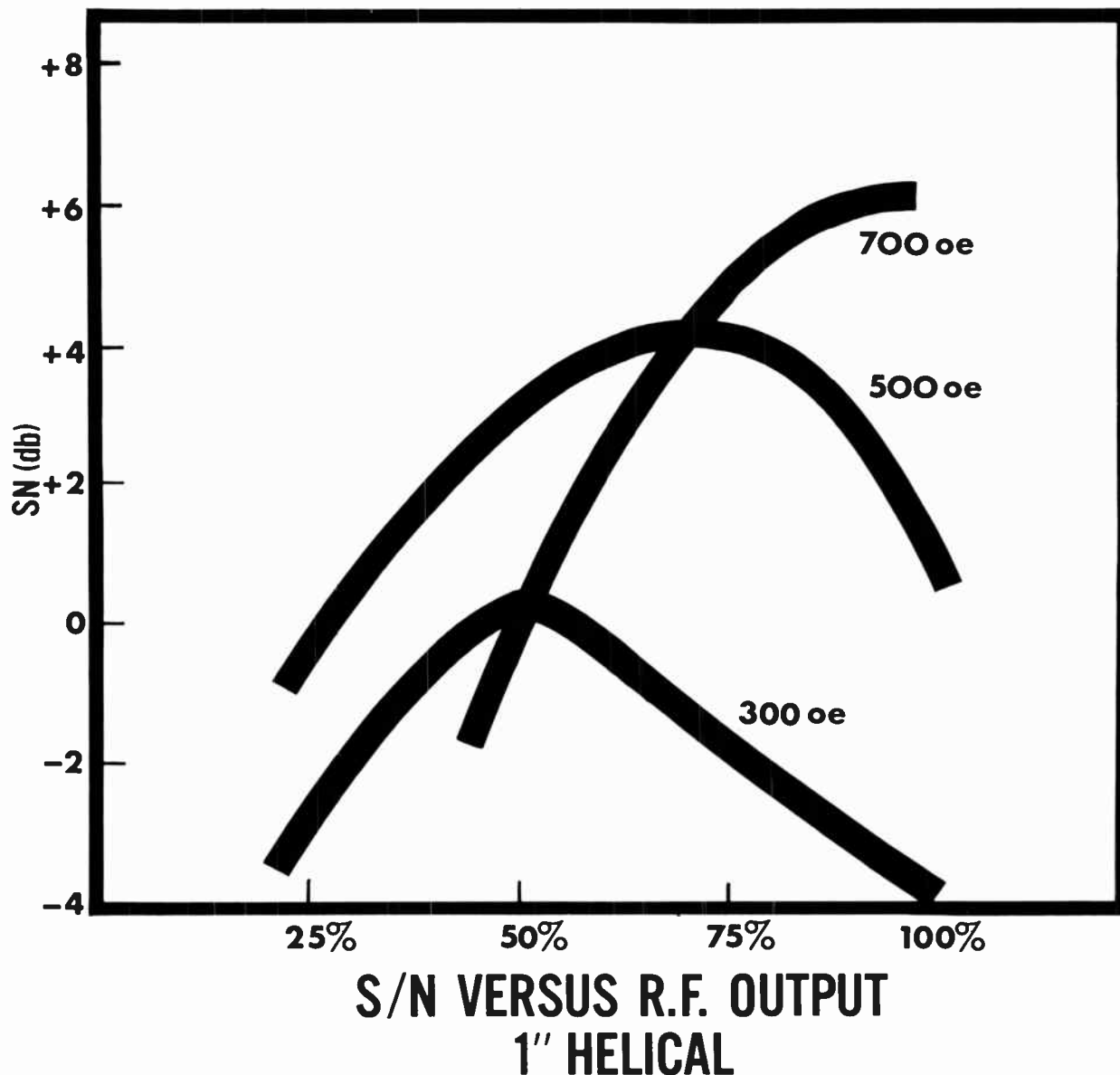

Fig. 6

oersted tape as the reference, we see that the 500 oersted compatible product offers an increase of 4 db, and the 700 oersted experimental tape yields a 6 db increase.

These curves, used in the last two figures, were generated on a one-inch helical recorder. While this type of machine would not handle 700 oersted high-energy tape without modification, it does an excellent job with the 500 oersted tape. This, however, does not hold true across the complete line of helical recorders. In some cases, the signal-to-noise ratio established by the machine electronics is equivalent to what is possible with traditional tapes. When tapes with improved SNR are placed on the machine, little if any difference is seen. With some half-inch recorders, even though we see a significant increase in RF output, the signal-to-noise ratio cannot be improved because of the electronics limitation. In other cases where we do see an improvement in SNR, it is disturbing to note that the signal-to-noise of the tape playback is only 5 db below the EE (electronics-to-electronics) capabilities of the recorder. With the tapes used up until now these shortcomings were not really noticeable, but with the introduction of the high-energy family of tapes we can see that picture quality is seriously hampered by the limitation of the recorder electronics. Now

that an improved tape is available we sincerely urge the hardware designers of our industry to develop the equipment to utilize the potential of this new oxide to complete what can amount to a great leap forward in video technology.

As we look to the future we see constant attempts at miniaturization and a desire to place more information on a reel of tape. The high-energy tapes that we have been discussing have a greatly improved short wavelength response. This offers the possibility of operating at slower speeds. To many, this ability to operate at a reduced speed signals the gateway to practical video cassette recording. Up until now the drawback has been the need for an overly large cassette, an unduly short program or a serious sacrifice in picture resolution.

To demonstrate the slow speed capability of the three tapes we have been discussing, we modified a recorder with a 13 micro-inch head gap to run at half the normal speed. Fig. 7 compares the results of this test with the same recorder operating normally. Here we see RF output plotted as a function of the recorded wavelength. Our zero db reference point is established at the one-eighth mil, normal operating point for the standard 300 oersted product. This is the vertical line on the left. By

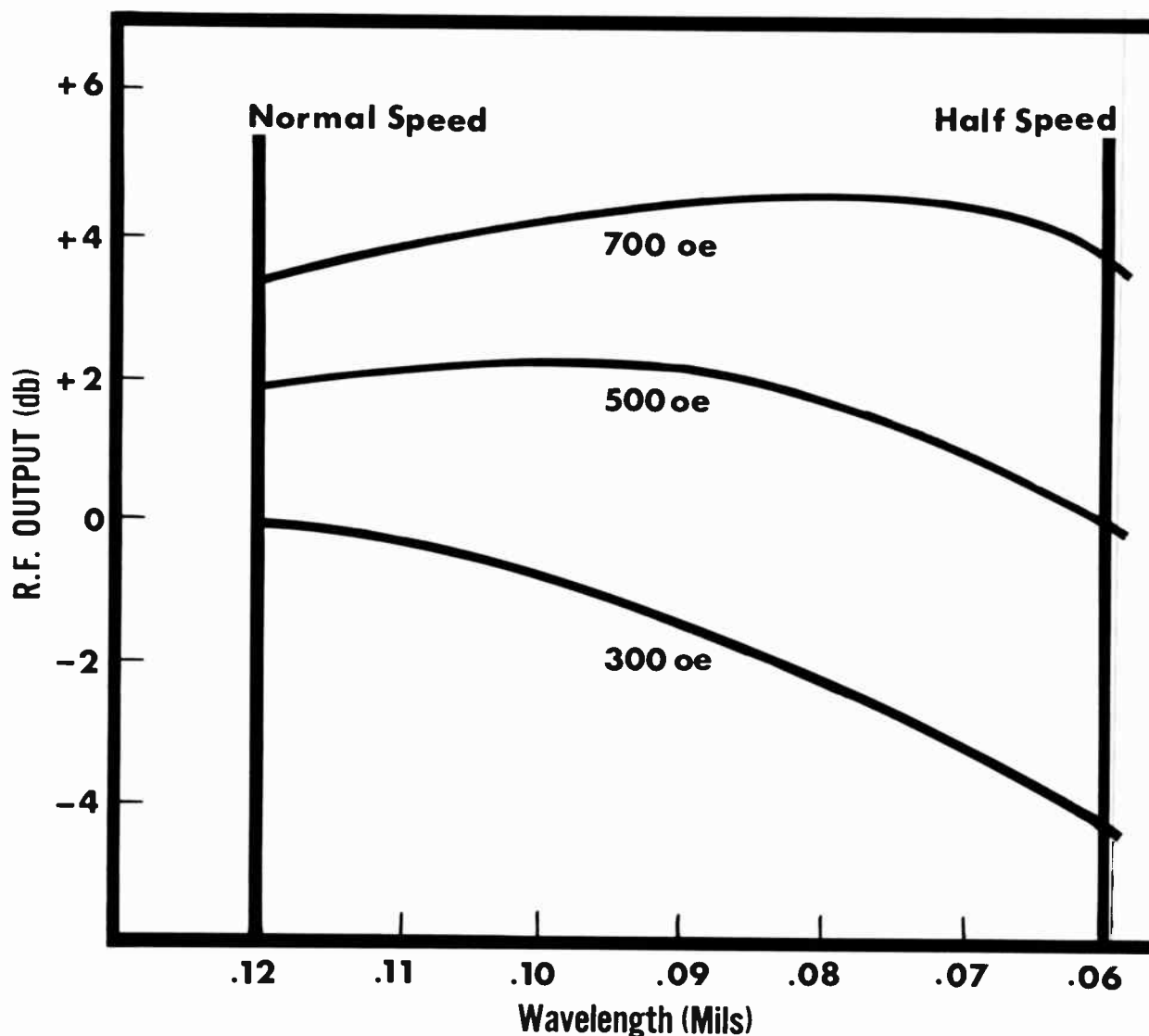

**R.F. OUTPUT VERSUS WAVELENGTH
OPERATING AT 2 SPEEDS**

Fig. 7

reducing the speed to one-half, we are then recording at one-sixteenth mil, and the standard product is seen to be nearly 5 db down in RF output as it crosses the vertical line on the right.

The 500 oersted high-energy tape operates at a plus 2 db from the reference at the normal speed, maintains this output at the one-twelfth mil wavelength, and has an output at one-sixteenth mil—the half speed point—that is equivalent to the 300 oersted tape at the normal speed. Standard tape at normal speed produces a picture of excellent quality. It is now possible for equipment designers to obtain the same picture quality on half the length of tape by reducing the head-to-tape speed by one-half. The era of half-speed recording is here now with a readily available compatible tape product.

If we follow a similar plot for 700 oersted tape, we observe an interesting result. In this case the experimental high-energy product has an output at half speed that is actually 4 db better than conventional tape at the normal speed. It is apparent from this that not only can one achieve a comparable picture at half speed, but it is now possible to obtain a better picture at half speed than has been possible at the normal speed.

The latest breakthrough in oxide research has equipped us to accomplish many things in the immediate future. Increased RF output and improved signal-to-noise ratios are immediately achievable with the compatible 500 oersted tape and higher coercivity versions promise even further degrees of excellence. We can tailor coercive force of the finished tape product to provide the industry with whatever is needed to improve the quality of video recording. And the best thing about it is that this is not a laboratory dream—the tape is here today.

Extending Video Head Wheel Life with Dust Control by Laminar Air Flow

James H. Sharman
 KOAT-TV, Albuquerque, N.M.

The increasing use of magnetic recording tape in the production of television programming has focused increasing concern on the problems of tape and VTR head wheel life. Magnetic recording tape becomes unusable when the recorded information can no longer be recovered with minimum loss or "dropout." Likewise the life of the head wheel is limited by its ability to record and recover the information on the tape with a high degree of reliability. Both of these problems are economic in nature in that any extension in life will result in direct reduction of operating expenses.

The problems of tape life and head wheel life are both related to physical wear. The relatively high head speeds across the tape and the high pressures necessary to assure constant intimate contact produce a predictable wearing situation between the tape and the recording head. It is known that dust particles in the environment will cause accelerated wear and shorten the usable life of the head wheel. (1, 2)

TABLE I
 TYPICAL CONTAMINATION LEVELS

Particle Sizes	Number of Particles/Ft. ³		
	Rural Area	Urban City	Manufacturing Plant
0.7 - 1.4	35,090	1,325,000	2,165,000
1.4 - 2.8	13,580	121,700	146,000
2.8 - 5.6	4,530	38,900	39,700
5.6 - 11.2	1,130	3,400	5,950
11.2 - 22.4	140	570	625

The natural environment surrounding the earth contains large amounts of contamination. Much of this contamination consists of finely divided solids called "particulates" or "aerosols." The concentration of particulates varies, depending upon meteorological conditions, local population and industrial activities. In general, the particulate level is higher in industrialized urban areas with the highest levels generally recorded within the occupied areas of manufacturing plants and commercial buildings. Table 1 shows typical airborne particulate levels for such environments.

In discussing airborne particle concentrations, the particle size distribution must be considered. As can be seen in Table 1 the concentration of particles increases rapidly as the size decreases. Air contamination within occupied building spaces arises from three sources:

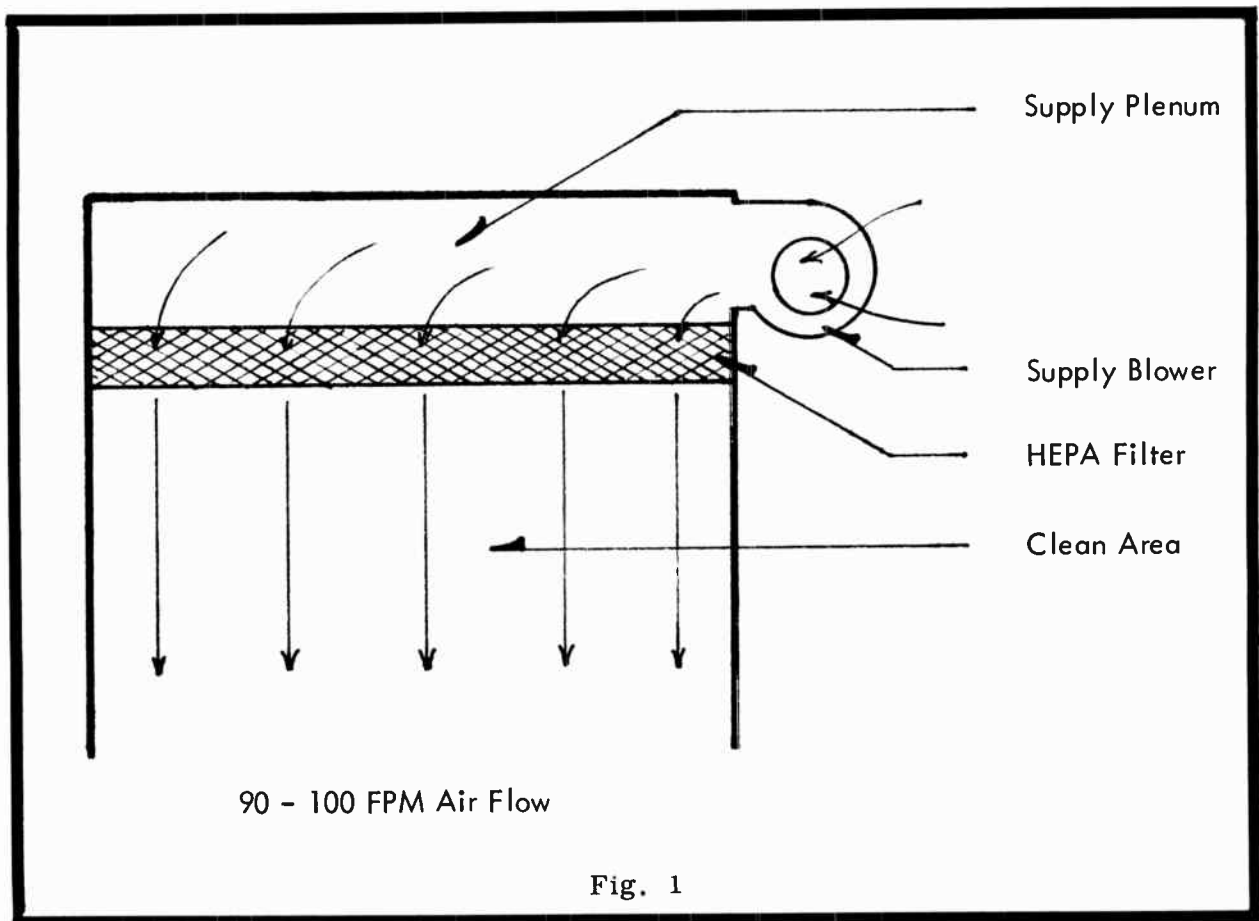

1. Fresh air brought into the building by the air conditioning system and through open doors and windows.
2. Contamination generated by people in the area.
3. Contamination stirred up from the floor and furniture by personnel and equipment activity.

Air filters in the air conditioning system can reduce the first source. Good house-keeping practices and controls on personnel activities can further reduce sources 2 and 3. However, experience has shown that even with high efficiency filters in the air conditioning system and rigid personnel control restrictions (the latter being difficult to enforce in the typical television operation), a minimum level of 50,000 to 100,000 particles per cubic foot (PPCF) is about all that can be expected.

A method of creating a super-clean environment was developed in 1960 by the Sandia Laboratories in Albuquerque, New Mexico. Called Laminar Air Flow Systems, the technique depends upon two factors:

1. Air is supplied to the room or localized critical zone through High Efficiency Particle, or HEPA, filters that effectively remove all airborne particulates. The efficiency of removal of particles as small as 0.5 microns exceeds 99.99%.
2. This "clean air" is then distributed in such a way that it flows unidirectionally through the room or zone in a single pass, sweeping away internally generated contamination and creating a barrier against external sources.

Fig. 1 illustrates the basic system. HEPA filters are placed immediately at the inlet to the enclosure and cover one ceiling or side wall. The air is thus filtered at the source to the area and is diffused so that a unidirectional flow is created throughout the area. A flow velocity of 90 to 100 feet per minute is generated which is imperceptible to personnel, yet effectively purges the enclosure. An entire room may thus be controlled or localized zones controlled as needed. This large volume of clean air flow provides an environment in which the particle concentration is maintained below 100 PPCF, or Class 100 as defined by Federal Standard 209A.⁽³⁾ Any particles generated within the area are instantly purged away and eliminated.

Having long recognized this need for a clean environment, many stations have taken steps to improve conditions in the video tape recording room. These steps normally involve a more vigorous maintenance and housekeeping schedule. Carpeting is often installed to reduce re-entrainment of dust from the floor and unnecessary traffic within the area is restricted. As an ultimate measure, increased efficiency filters or electronic precipitators have been installed in the air conditioning system and the room pressurized to reduce extraneous dust. Recently the application of Laminar Flow in modular form over VTR equipment has demonstrated that significant improvement in head wheel life can be realized when such airborne dust is eliminated from the head wheel area.

KOAT-TV first became involved in video tape recording during the summer of 1960, using a pair of Ampex VR-1000B machines. At the outset, our head life was anything but good, but after considerable experimentation with brands of tape and other variables, we were able to obtain an average head life of some 350 hours. This appeared to be on a par with the industry average, although we kept hearing reports of far better life at other stations, occasionally up to 1,000 hours. During 1968 we converted completely to high-band recording with a pair of VR-1200A machines and a third VR-1200B. Operating under almost identical conditions as with our low-band machines, our average head life plummeted to 150 hours or less. Again we experimented with different brands of tape and this with, I imagine, improvement of heads through normal evolution, resulted in our being able to increase the average life of our Mark X heads to approximately 335 hours by late 1969.

During this same period Mr. Lou Sanders of Enviroco, Inc., manufacturer of the Envirozone Laminar Flow Modules, was the invited guest of Dr. George Fishbeck, science instructor on KNME-TV, an Albuquerque educational television station. Lou was describing the laminar flow principle and caught the attention of Robert Gordon, chief engineer of KNME-TV. It seemed that this laminar flow in modular form, available at the time, might serve to correct some of the dust problems in the KNME-TV tape area. Lou Sanders carried it from here to the other television stations in Albuquerque, all of whom installed laminar flow modules in their tape areas on an experimental basis. At KOAT-TV we installed our first module in November, 1969, adding a second and third module in April, 1970 to complete the installation.

During the year immediately preceding the installation of the first laminar flow module, we operated our high-band machines for a total of 2,967 hours, returning ten heads for refurbishing with the average life of the heads being 290 hours. It should be noted however, that the average life of the first five of these heads was only 206 hours while the last five had an average life of 374 hours. Thus, it probably should be said that the average head life immediately preceding the installation of laminar flow was closer to this latter figure of 374 hours.

During the 14-month period following the installation of laminar flow, the three machines were operated a total of 4,172 hours. During this period we returned four

heads for refurbishing with an average life of 717 hours, representing an increase in average head life of approximately 91%. On a dollar and cents basis, we were able to realize a savings of approximately \$4,000 in head refurbishing costs during the first year of operation with the laminar flow modules.

Of these four heads returned, three were in use at the time of installation of the laminar flow modules. We have not yet been able to accumulate sufficient data to be able to predict an average life for those heads operated during their entire usable life in a clean air environment. Only one such head has been refurbished to date; it failed at 599 hours. Of the three heads in use at this time, one has logged 345 hours with an average 2.3 mils tip projection remaining, a second has 920 hours with 1.4 mils remaining, and the third has 251 hours with 2.1 mils remaining. Of these, based on our recent experience, we expect the first two to finally well exceed 1,000 hours of life, while the third will fall somewhat short of that figure.

This third head is installed on the VR-1200B and we have found this machine to have a higher head wear rate with a correspondingly shorter life than the other two machines. Smoke tests by Envirco engineers indicated that an air conditioning outlet was interfering with the laminar air flow. Although this has since been corrected we have not yet been able to detect an appropriate decrease in wear rate. This particular machine is the more elaborately equipped of the three and where possible it is used for all playback of network delays and syndicated programming. It is also used where possible for playback of material to be edited into second generation tapes. Conversely, the machine used whenever possible for network delay recording has to date demonstrated the highest head life figures.

Fig. 2 illustrates the head life obtained during the year preceding the installation of laminar flow and during the fourteen month period following. As can be seen, data was not accumulated rapidly enough to positively indicate any significant improvement following the installation of the second and third modules as compared to operation with just a single module. This can be partially explained by the fact that the laminar flow modules are recirculating devices which tend to clean the air in the entire area in which they are located.

At KOAT-TV video heads are considered to have failed when they will no longer record and play back a video test signal with a quality meeting our standards. This raises the question of how high are our standards. We have long regarded a tip projection of 1.0 mil to be a critical point⁽¹⁾ but the great majority of our heads fail before this point is reached and in most instances a head will be rejected before any serious degradation is seen in program material. An exception to this is a head that is retired because of increased dropout activity. Generally, this will be observed in day-to-day operation and the machine will be removed from service while the head is checked and possibly replaced. Like most stations we try to schedule maintenance down time so as not to interfere with normal operations, so we occasionally remove a head a few hours sooner than necessary.

Probably the most striking thing to be seen in Fig. 2 is the fact that prior to installing laminar flow, our maximum head life was 445 hours. Since the installation of laminar flow, all heads have exceeded this figure.

The video tape area at KOAT-TV is conventional, except possibly for the fact that the area is also used for telecine. The air conditioning system uses standard Fiberglas filters which are changed monthly. The floor is not carpeted, the vinyl tile being dusted daily and washed and waxed weekly.

Although faithfully followed, maintenance and operation procedures are not unusual. All maintenance and adjustment, other than routine tracking adjustments and the like, are performed by engineering personnel, while actual program operations are per-

Read life in hours

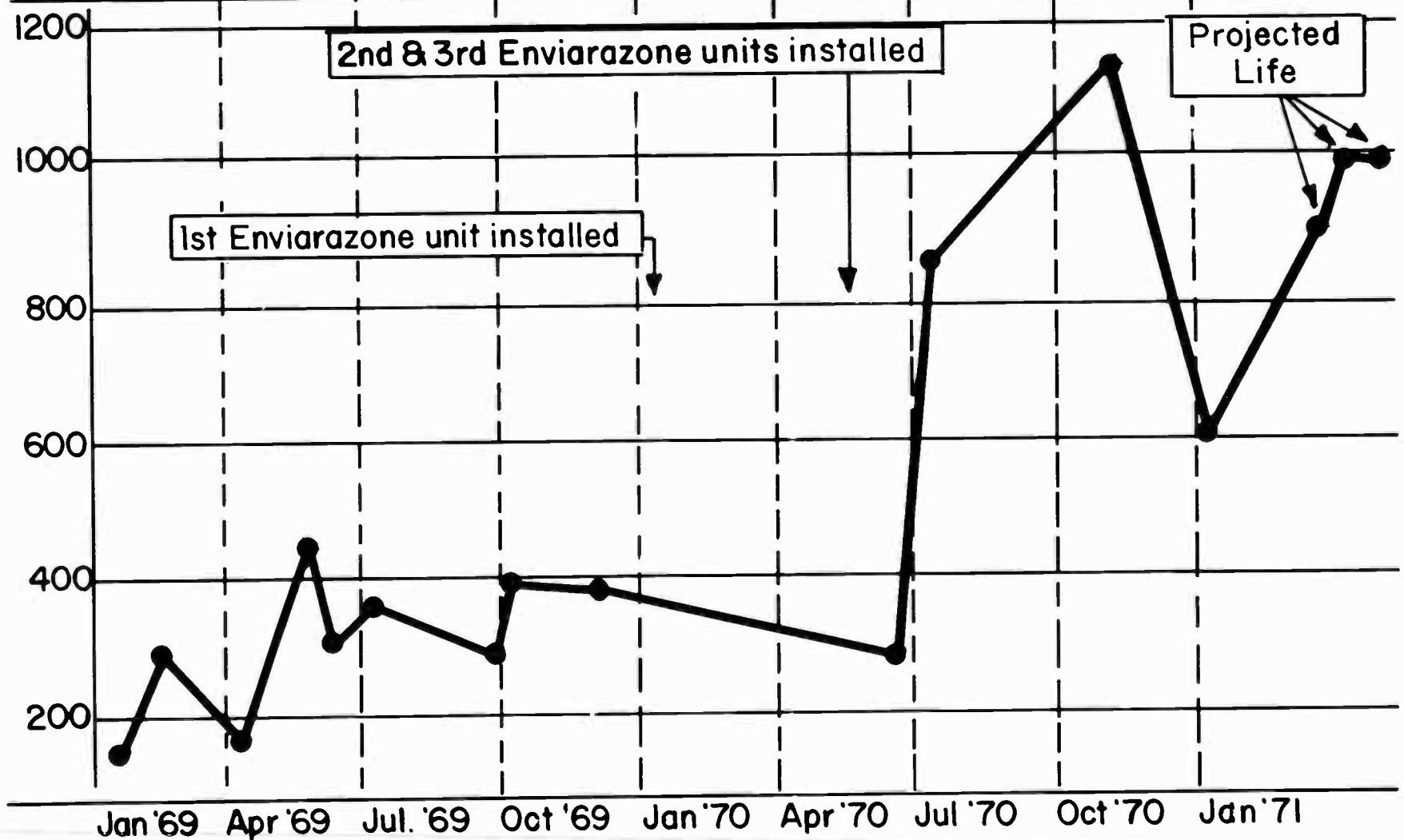

Fig. 2

formed by production personnel. Smoking and eating in the projection and tape area is not permitted, while mechanical tape splicing is forbidden except in the most dire emergencies. Routine maintenance consists of daily cleaning of the tape transports and thrice daily checking of tip penetration using a standard alignment tape. Minor intersync adjustments are made at this time, and whenever editing is to be done, using the front panel meter while complete intersync alignment is made as required. Record current optimizing is done on a daily basis during the early life of the head and is reduced to approximately 20-hour intervals as the head ages. Tip projection measurements are made at approximately 20-hour intervals. Cleaning of the entire machine, inside and out, is done on a weekly basis at which time the air filters are cleaned or replaced.

During our early experience with the 1200 series machines we noted the air filter in the head wheel cooling fan housing. We assumed that this filter provided the necessary cleaning of the air driven across the head for cooling purposes. Later, we realized that this was not so. The air used for head cooling purposes is drawn from the front of the machine, across the tape and the head, and down into the machine where it is exhausted. Thus, the air filter serves only to protect the cooling fan and fan motor. The laminar flow modules now provide a supply of ultra clean air for head cooling purposes and it is our belief that this is one of the major contributing factors to increased head wheel life.

Maintenance of the laminar flow modules is minimal. The Fiberglas pre-filters are changed monthly while we have not yet changed the HEPA filters. This will be called for when the flow velocity drops below 90 feet per minute. Envirco engineers have been measuring flow velocity for us and it appears that the life of the HEPA filters will be at least two years. In our case, the laminar flow modules are operating whenever power is supplied to the video tape machines, but in some cases it might be advantageous to operate them 24 hours per day.

Obviously there are many factors contributing to head wear, but at KOAT-TV we have found the laminar flow modules to be an extremely worthwhile investment, being one of our few investments that have literally paid for themselves. Not only has there been a significant savings in money but in time as well. Just as important, in my view, the reliability of the machines has been increased with a substantial reduction in the need for maintenance.

My appreciation is expressed to Mr. Lou Sanders and Mr. Claude Marsh of Envirco, Inc. for their assistance in the preparation of this paper and for their contribution of much of the material contained herein, and to the KOAT engineering staff for their diligence in gathering the data presented.

REFERENCES

1. King, John; Anderson, Charles E., TAPE, TIPS AND STANDARDS, BULLETIN FROM VIDEO ENGINEERING, Ampex Corporation, Issue 100, January 3, 1967.
2. VIDEO TALK, 3M Company, Volume 1, No. 2, 1968.
3. Federal Standard 209A, Clean Room and Clean Work Station Requirements, Controlled Environment, August 1966, U.S. GSA Publication.

VHF TV Remote Control Panel

Moderator:

Malcolm M. Burleson
Burleson Associates, Inc., Washington, D.C.

Panelists:

Richard J. Anderson
KTTV, Los Angeles, Calif.

Panelists:

Richard J. Anderson
KTTV, Los Angeles, Calif.

Sal Fulchino

Rust Corporation of America, Everett, Mass.

Thomas M. Gluyas

RCA, Camden, N.J.

Harold L. Kassens

Rules & Standards Division, FCC

William D. Kelly

WNEW-TV, New York, N.Y.

John A. Moseley

Moseley Associates, In., Goleta, Calif.

MODERATOR BURLESON: About two years ago, I suggested that VHF-TV remote control was imminent, so let's get ready fast, fellows. "Imminent" now has a new meaning for me, but it does mean that things always happen. This distinguished panel of experts has been involved in TV remote control for more than two years. In opening, I would like to have Mr. Kassens give us an introductory statement regarding the new rules.

MR. KASSENS: To begin with, a word of caution. I hope you don't all show up at the Commission Thursday morning and want an authorization. We are not quite prepared. There is going to be a little delay. There has been a great delay so far, and a little more, obviously you won't object to; but a few time factors I think you ought to consider here. Some of them are very important on your part. The only way you can get a remote control authorization after the rules become effective—and they become effective on April 30—is to file a Form 301-A. We have a 301-A, but it is only for AM and FM, and we are not modifying that form.

At this stage I can give you no guarantee as to when the new form is going to be available, since it has to go to the Bureau of Budget for approval, then printed. So I can't give you a time frame, but I would assume that probably my best guess would be some time in May before the form is available.

The other thing is that, as you probably well know by now, we are requiring the use of VIT signals in remote control. But we had a little difficulty trying to decide exactly which VIT signals, so we have a Further Notice out asking, in effect, these questions about what VIT signals we should use in remote control. And although we have said that the VIT signal part is not required for remote control for the time being until we tie it down, the initial comments are due on April 30, the reply comments on May 10.

We fully intend—we have the highest hopes—of making this a real quick one, in and out, so if anybody comes in and asks for an extension we are going to give him little time. I wouldn't guarantee that somebody couldn't justify an extension, but we intend to make this Further Notice just as rapidly as we can, primarily for your benefit, because you are going to have to buy this equipment and we want to let you know as soon as possible what equipment you are going to have to buy.

So, I would think you are talking in terms of maybe June or July at the earliest before you can really consider being in remote control as far as we are concerned.

You have another problem—your own practical problem. If you remember, in the Notice of Proposed Rule Making we had suggested a six-month so-called experimental period where you would put it in and use it for six months and then leave it on permanently and pull the engineer back to the remote control point. We took that out, based on the comments we received, and I think the reason is quite obvious. The general tenor of the comments was that you really don't need that since we are going to do this. We wouldn't dream of putting it in and walking away from it. This is obviously still true. You are not going to walk away until you are darned sure this thing is going to work like you want it to. So, that time frame is also built into this.

If you say that you don't know at this stage what you are going to have to buy, what you are going to have to do, and therefore you are going to have to wait for us. If you want to know what is in the form I would suggest you look in the new rules. It tells you exactly what you have to do. The rule is Section 73.677. This is the one that is attached to the Order, and you can get a fairly good impression of what the form will include if you look into this rule.

So, I think this is advance notice to you, and you can be thinking about these things. In my own mind I don't see why you can't start out now in your thinking and in your installation so that you will be in a position as soon as the form is available to fill it out and be getting some of this experience with your equipment.

MODERATOR BURLESON: May I ask you to elaborate on one point on the form. Could we expect a one-page form?

MR. KASSENS: Yes. We could easily make it that, and may very well by just saying in the form, "How do you answer these questions that are in the rule? Exhibit No. 1—Show us how you are going to do this. Exhibit No. 2—" and so on. You can make a very short form that way. The only problem is, if you don't have a copy of the rules you wouldn't know how to answer the questions. I wouldn't want to guarantee that it will be one page, but it will be a reasonably short form.

MODERATOR BURLESON: Tom Gluyas can speak as an equipment manufacturer's representative. Not only does he worry about the transmitter but also the monitoring.

MR. GLUYAS: I want to say a few words about transmitters for remote control and a few words about off-air monitoring. The key to remote control is transmitter stability and reliability. Any transmitter that is stable enough and reliable enough can be operated by remote control simply by turning it off and on remotely, and providing capability on the up-link to the transmitter to adjust video level and sync level.

A few of the newer transmitters have overall feedback from the rectified output to keep pedestal level constant, and this is a big help in long time stability.

Beyond this rudimentary approach, it is "dealer's choice" how far to go in being able to manually turn all the knobs and switches by remote control, or read all the voltages and currents remotely, or automating adjustments, all the way up to automatic waveform analysis and full computer control.

The nearly 100 UHF-TV systems now operated by remote control are all fairly simple systems in spite of the fact that almost all of them have no standby facilities. Very few have solid-state exciters for improved stability, and some have no way of adjusting sync except to jockey the power output to drive the klystron into more or less compression.

The tendency that I have observed among broadcasters planning VHF-TV remote control is a violent swing in the opposite direction to extremely complex manual operations or to more or less automatic level controls and automatic mode switching. Whether this is evolution toward a computer-controlled generation of transmitters, or whether the pendulum will swing back to some middle ground, I am not sure.

On the subject of off-air monitoring, I think the intent of the rules is clear, and that is that you should have as good provision from the remote control point for quality control of the radiated signal as you would have for operation at the transmitter site. I am also pretty sure that almost all of you are of the same opinion that there never has been a demodulator that was really quite good enough for assessing transmitter performance adequately, so I urge you to be very careful in selecting an off-air visual demodulator.

Just as in the case of the transmitter, demodulator long-term performance stability is important. Do not be taken in by a sales pitch that may be truthful enough in extolling the performance of certain parameters while saying nothing about others. One demodulator may use a circuit that eliminates quadrature distortion but leads to incorrect conclusion on differential phase; or the response may vary with signal level. Some demodulators are not even as good as home receivers in low-frequency envelope delay. Others cause unsymmetrical color sidebands giving color edge distortion.

You can probably get some good advice from your transmitter supplier, since he will have an interest in protecting the transmitter reputation and not having it unfairly criticized based on using a bad demodulator.

Bill Behrend of RCA presented a paper at the IEEE Broadcasting meeting in Wash-

ington last fall that went into some of the demodulator problems. It won't tell you which equipment to buy, but it will make you a demodulator expert so that you can shop better. We have some copies of this paper left, and anyone who wants one can see me or drop me a card at RCA in Camden and I will see that you receive a copy.

MODERATOR BURLESON: I believe it has to be emphasized here that all of the equipment elements in this system have to be important. Another very important area is the control and metering equipment itself. Sal will speak of that from a wired control standpoint, of which there are many, many problems.

MR. FULCHINO: As with anything, Y line operation has both advantages and disadvantages. This type of operation, for one, means that the remote control interconnecting link is dependent on a company outside of the station's control. Full duplex line transmission systems do have the advantage that the system is in operation when the transmitter is not in operation. Thus, if you are operating via a subchannel, you could have a problem if the transmitter is not on the air when you attempted to get information on the installation.

Another advantage of it, of course, is its simplicity. A full duplex line system is a system in which you can transmit both the remote control, the automatic logging, and the alarm information all simultaneously on a single, simple circuit.

Because of its advantages and disadvantages, it may be desirable to consider a method whereby you utilize such a circuit with automatic switching of the metering and control circuits to a secondary link if you should lose the primary interconnecting full duplex line. This results in normal operation over a single simple circuit without using a subchannel on your STL and on the aural part of your transmitter, but it gives you the backup of automatic switching and the usually reliable low-priced Telco. Telco does bring a problem or two.

Probably the most important step in going VHF-TV remote control or any remote control is in the planning stage. For engineers that have no experience in this type of operation, it is most important that they proceed carefully, and this is one place where the remote control manufacturer can help you a great deal. We can supply you with a lot of knowledge that we have obtained over the years. We can tell you what you should be concerned about, what can be done, how it can be done, and a lot of things you probably are really concerned about we can show you how they are really not to be worried about.

Controlling a VHF-TV installation is different from controlling any other installation. However, in many respects it is actually simpler, especially when you consider some of the complicated directional AM arrays that are remote control. So, for the addition of remote control equipment to existing facilities, it may be wise to look to the remote control manufacturer, because he is in a position where he has probably talked to a number of people who have the same transmitter and the same type of installation you have, and he is probably working very closely with the transmitter manufacturer. The planning stage is very important, because how you plan it is how you get along afterwards.

After the planning stage, and following the equipment purchase, you should allow sufficient time for proper installation. This is nothing new. You should do this with any new installation; but this is especially true here when you consider the fact that the installation is going to be unmanned. So, the faster you move, the quicker you may have problems. It is very wise to allow sufficient time for proper installation and for proper testing and to familiarize your personnel with the equipment and its installation. This is very, very important.

At the present time, there is available all the equipment necessary to comply with the remote control rules. It is possible to perform all the functions over a single full

duplex telephone line—remote control, automatic logging, and the status alarm. So, the equipment is available today.

There is also available equipment to operate more than one transmitter site from a single control system. Basically, a full duplex VHF-TV remote control line system has advantages and disadvantages. They should be weighed carefully, and probably you should utilize the simplicity of the circuit regardless of which you select, and have a good backup to it. I think you will find that the interconnecting link is the concern, and not the equipment.

MODERATOR BURLERSON: Now, from a radio control standpoint, John Moseley, of Moseley Associates, will give us the answer to those problems.

MR. MOSELEY: Sal has covered very nicely the point that remote control equipment, per se, is stable and can do the job for controlling your TV transmitter. This is based on 20 years of AM remote control. Sal made one reference to Telco, and I heard a few giggles. This is where I would like to address my remarks.

I think the rules are far-sighted in recognizing SCA techniques for recovering the metering information so that you can have a remote control operation. This removes any dependency the licensee may have on hard-wire facilities. A system would typically operate in the following manner:

The remote control tones or signals generated in the studio can be relayed to your transmitter site over a duplex channel on your TV STL. At this point there are two ways of doing this. One, you can add a second sound channel such as a 7.5 or 8.2 MHz if you are using 6.2 MHz for sound. In some older STL equipment, this is not possible, but in most cases, you do have a standby sound channel. These control tones can be carried over the microwave link to the control equipment at the transmitter site. This will provide full operation of the relays, whatever devices you are using to control the transmitter.

In some of the older cases (and we have had occasion to do this) we have multiplexed the duplex channel with a subcarrier. We have even put, for example, a 67 and a 26-kHz subcarrier on a 6.8 signal, which of course itself was multiplexed on the basic RF link. This does require modification by you as the user. So, we would recommend a separate sound channel as the most convenient way.

To return the metering information, the Commission has provided rules which will permit the use of an FM subcarrier operating in the range of 20 to 50 kHz at an injection level of 10%. This is more than adequate to do the job. In the studies which we have participated in with some of the other panelists, we have checked subcarrier frequencies all the way from 20 kHz to 100 kHz. In view of the 50-kHz upper limit, it would be our recommendation or suggestion to use a subcarrier frequency of approximately 39 kHz, 39 being chosen as 2 1/2 times the horizontal line rate, which on a spectrum basis should be fairly clean from modulation components. The information from the remote control equipment would be applied to a 39-kHz subcarrier generator located at the transmitter site. This would be multiplexed over the aural carrier and recovered at the studio.

Two things are of importance here. While the rules are silent in this regard, it should be very obvious to you that your TV aural monitor must have the capability of reading that injection, because you know in FM service the older monitors fell off rather rapidly at 20 kHz so the 67-kHz was not even visible on the meter. So, this will be one caution to those of you who have monitors, and again this can be done very easily with a scope on the output of your monitor.

The other point is injection of the subcarrier into the transmitter. Again the rules are silent here, but most transmitters are capable of being multiplexed, and here again I would refer you to your transmitter manufacturer, although we ourselves in some cases have information and capability of making suggestions about that.

One thing that is pointed out in the rules is that metering must be fail-safe. That is, within one hour of loss of metering you have to have automatic circuitry which will fail-safe the transmitter. In a radio remote system there is a little hooker here, and that would be considering as an example signoff at midnight, and one hour later the circuitry says, "Let's turn this thing off because I have no metering," so it sends a signal to the control heart and says, "Stop this thing." It is shut off, so it just sits there and says "stop." At 6 AM the man has to turn the transmitter on, but the circuitry won't let him, so the control equipment has a front panel override or cheater switch on it. This means you have to operate the switch. It has a time limit on it, giving you a certain amount of time to actuate the transmitter. Once you fire up the transmitter it has a signal, and your fail-safe indication is no longer present, and you are in operation. There are some other areas to this, and I am sure, as I have talked to Mr. Kassens, that if such conditions which I described to him arise you will know what to do with that cheater switch.

MODERATOR BURLESON: Thank you. I would like to publicly thank two engineers that I have worked with. Pioneer No. 1, Dick Anderson.

MR. ANDERSON: From what you have heard, there are obviously a number of considerations and things that the station engineering personnel and stations must be concerned about. Remote control of AM and FM transmitters has been in existence for some time. The requirements that have been added to VHF and UHF television remote control add a few extra concerns.

The most concerning one, I think, would be the off-the-air monitoring. There are several parts to off-the-air monitoring. One of them has been mentioned—that there is still some rule making to be done in the VIT signal area. This is the area which I would like to discuss, not to the point where I would make a recommendation but maybe where we could generate some discussion which might help us to understand what we will be expected to do, and maybe some thoughts as to the type of signal which would be the best to use.

There are many such generators and signals available, and each signal has its particular area of test and determination as to the quality of the system. I do think the key to this would be the selection of the simplest system that would give us a check of the parameters or the signal path that we most necessarily require as far as the rules are concerned. A test system that will give us the optimum picture, a good-quality picture, but at the same time not be so complicated that the cost is overly high. Additionally, it should be a signal that the average operator can understand and interpret. If he sees that a correction is necessary, he knows what corrective action is necessary at the time.

You might ask: How does this change from the present operation to remote control? The difference is that up to this point we haven't had to have VIT signals—and I don't think the operators that we have now necessarily may have been able to interpret the signals any better than the operators we may have at the remote control point.

I think there are two types of signals. One is for the day-to-day operation, and the other would be used during a period of maintenance. I think we have to be careful as to which we select for the day-to-day operation. No matter what signals the Commission selects, we have the problem of the detection system. So, it seems that regardless of what we do, we must be able to detect these signals so that what we recover at the remote location is identical to those which you have in the way of a monitoring facility at the transmitter, which is the requirement as far as the daily inspection and calibration or the weekly inspection and calibration are concerned. I don't know that we can settle anything here, but I would hope we could have discussion that will be meaningful in this area, where we can get the VIT signals that would be simple and yet adequately to assure daily quality operation.

MODERATOR BURLESON: Now I would like to call on Bill Kelly, from New York.

MR. KELLY: First, let me take you back four years, when we were handed this problem, and tell you how we did it. Let me tell you first the plan, basically, is two drivers, two finals, some reasonably complex antenna switching. We have two video lines and two video channels at the transmitter. We have two audio lines and two audio channels at the transmitter, so we have complete redundancy.

To control this we put in a system with 48 analog telemeter points. I think if I were doing this again, 29 analog telemeter points might be adequate. We put in 96 control relays, that is 48 ups and 48 downs. We have 30 autologging positions. That is more than adequate; 20 would probably do it. We had 24 alarms, and that is just adequate; and 16 status points, which is also just adequate. We operate on a land-line basis with two lines.

The interface—and there was a lot of interface to be done because we had the TT-4 RCA transmitters which were designed for remote control and the TT-5 amplifiers which were not. It took a lot of work on the TT-5s which were not designed for remote control and the TT-6s which were; as a matter of fact, it took us 6 months to do the job.

We had to install relay logic for such simple things as telling the man before he went out the door that everything was in a remote control position. Many other items were necessary, such as not sending alarms down-link on equipment which was not switched onto an on-air circuit.

At the control point we use master antenna RF amplifiers, and we had to do a lot of work on these. These RF amplifiers are not adequate for the new rules. The frequency modulation monitor we have is not adequate for the new rules. The picture and waveform monitors are about all that are adequate at the remote control point.

The demodulators that are available now may or may not be adequate, and that remains to be proved, and I think it must be proven to you before you buy them. We see new frequency modulation things available now, and new RF amplifiers, and I think you should be careful here also, and have them prove that they will meet the rules. Better read the rules four or five times and then ask questions.

Stability of the new transmitters is reputed to be greatly improved over old transmitters, and from what I can see, it is. However, there are a number of things that I think manufacturers can do to further improve their transmitters. Some of this has been done, but more needs to be done. Certainly if we are going to go to computer control, there are systems available now that can computer-control and can make adjustments through limits that are set in the computer program.

I don't think there is enough data available from the transmitters to allow the computer control that I would like to see. I would like to have computer control to the extent that it will watch trends in the transmitter, and when the maintenance crew comes in at night it will have typed out for them what they are to do that night, what circuits to look at. You look at the new transmitters and then you look at your maintenance men, and I think you will see the need for this. Stability is fine, but you still need the maintenance and you still need the adequate protection for public safety.

I think we can get all these things if the broadcasters insist that the manufacturers supply them. They have done a pretty good job to date but it won't get better unless we make it so. I feel very strongly that remote control gives us all the opportunity to really improve our operations, and I think we should see how good a job we can do, and not just how cheaply we can do it.

MODERATOR BURLESON: Please don't be bashful with your questions. They may not only be serious to you but to everyone who hears them.

MR. ANTHONY MORAN (WYES-TV), New Orleans, Louisiana): We share the same transmitter facility—that is, the same building—with another station with different call letters. Is it within the rules to control two different television transmitters through the same remote control link?

MR. KASSENS: Actually, as a practical matter it wouldn't be, because you are going to have to provide your own facilities. I assume you have separate studios. You are going to have to have off-the-air monitoring and off-the-air recording if you go that route. I don't think it would be practical.

MR. CHARLES UPTON (KRDO, Colorado Springs): I would like to go a little farther with the previous question. We operate an FM and a television transmitter in the same building, from the same studios, and I wonder how the Commission would feel about using the alternate link as a backup in case of failure if, say, the television FM aural transmitter were to go off. You have lost your telemetry information to tell you why it went off. What would be the Commission's feelings on using the FM link, to go over and read that television aural and try to find out what is the matter with it, or some backup using the two systems as an alternate backup?

MR. KASSENS: Here, again, I think it depends on exactly how you are going to accomplish the remote control for the television. If you are saying you have spare control circuits and you want to use these control circuits for your FM as well, I don't see a particular problem. The problem we have run into, just as an example: If you get in FM today using a subcarrier for telemetry and for some reason or other happen to have your AM and FM at the same location, you can't put your AM telemetry on the FM subcarrier. If you get a subcarrier for television, you are not going to be able to put other information on that subcarrier. Of course, you could have it as a backup and get a temporary authorization to use it, just for backup purposes.

MR. WILLIAM P. KUSACK (WFLD-TV, Chicago, Illinois): In the case of a microwave STL, for remote control if I interpret the rules correctly, you require a license to operate the receiving end of the microwave; isn't that correct? How would you handle this on a remote control condition, unattended transmitter?

MR. KASSENS: I am glad you mentioned that, because there was a little cutey I discovered since I have been here as far as STL is concerned. I don't see any particular problem with the operator rules, because you will have the operator at the STL transmitter, which satisfies the present rule on a one-hop system but, surprisingly, we missed something. On a two-hop system you have to have the operator at the receiving point, which is up at the transmitter, and I think that is something we are going to have to worry about.

VOICE: I noticed in the new ruling that you require a 60 db signal-to-noise if you have subcarrier for your remote control. Did you up it to 60 db if we use wire control, or just if we use subcarrier.

MR. KASSENS: No, this is subcarrier, but I would like to ask Mr. Moseley if he thinks we are practical.

MR. MOSELEY: Yes, but you are inconsistent.

VOICE: Some of the older transmitters have some trouble getting up to 60 db signal-to-noise. If I use subcarrier on my FM I will be required for 60 db signal-to-noise?

MR. KASSENS: That's right.

VOICE: If I use wire I will not be?

MR. KASSENS: That's right.

MR. MOSELEY: I would like to get a clarification on that. If a transmitter is type-accepted for 55 db SNR, and if it meets 55 db, your rules say when you put the sub-

carrier on it should not interfere by more than 60 db down. That is the way the rules read, as I see them. If you have a transmitter at 55 db and you are reading 55 db and you put the subcarrier on, and you cannot see any difference in that 55 db reading, then I can say it is 60 db, but prove it.

MR. KASSENS: Yes. Jack has brought up a point here about this 55 db figure. I think there is one other consideration in here that you have to worry about, and one of the reasons we latched onto this. When you measure, obviously you are going to be measuring in the vicinity of 55 db, and I don't think anybody is going to be too concerned about the 60 db figure; but your 55 db figure is for transmitter, and there is a little goodie in here that says that we are now measuring these things from the studio. In the past the performance measurements were measured for the transmitter itself. We are now including the STL or whatever circuit you use.

VOICE: Will frequency monitors and modulation monitors be required for the aural SCA?

MR. KASSENS: No. All we say is that you should be careful here. As has been pointed out previously, the responsibility is yours to make sure the injection is 10%. You had better check this monitor that you are using to make sure it is reading right, before you put too much reliance on that figure, because some of them may not work very well up in the 50-kHz region.

VOICE: My second question: Will a new TV proof be required in the new FCC form?

MR. KASSENS: Not at this stage. We are now working on proposed rules on TV proofs of performance, and I would hope by next year we will require TV proofs on a regular basis. As far as remote control is concerned, the answer is no.

VOICE: Referring to Paragraph 38 in the rules and in the Order just released, there is a notation in there that a carrier level meter would give an indication of the correct aural power level of the transmitter. We are considering a new monitor—a new aural modulation monitor—that does not have a carrier meter but has a light. Is the meter a requirement?

MR. KASSENS: No. The reasoning we used in paragraph 38 was that there would be certain information available at the remote control point which would at least provide some information that even though you have lost telemetry and can't read the meters any more, there is a reasonable assurance that you are operating properly, and so we mentioned the carrier level meter as a degree of indication of power, so that any type of indication like this would show. Obviously, there are several others you could use as an indication that your power is reasonably constant, until you can get up there and fix your telemetry circuits.

VOICE: In case of main transmitter failure, is this interpreted to include a second exciter?

MR. KASSENS: Yes. The way the rule reads is that you have to have equipment to operate at 20% power if you lose your main transmitter. We have problems defining what "main transmitter" means, but as we see it, you are going to have to have redundancy here as far as your exciter stages are concerned—your driver stages, this sort of thing—and your final amplifier stages. However, if you want to accomplish this by having a separate auxiliary transmitter, fine. If you have a transmitter which will automatically operate on half or quarter power in the case of a failure, that's fine. We don't go any farther into redundancy into power supplies or your power circuits themselves, but there does have to be RF redundancy, and you would have to have two exciters.

VOICE: One final question. After we file application, what length of time do you consider adequate for receiving a proof?

MR. KASSENS: Well, considering our rapid action, I really wouldn't want to answer that question. Obviously we have now created for ourselves administrative problems,

and if you consider that there are 100 UHF stations now operating remote control and 200 are not, and how many VHF stations are going to file we don't know—we are guessing probably 400 applications being filed. Without any additional manpower you can see we have developed a problem for ourselves.

VOICE: We have been remotely controlling our UHF Philadelphia station since 1965, and this Order seems to be taking a step backward for us as far as the 5-day inspection rule is concerned. Also, we have a little problem with the 20% rule, wherein we have a 100-KW transmitter, and it is pretty tough to come up with that standby with a 20% rule of that sort. Is there any relief in sight for the UHF broadcaster as to the 5-day inspection? There are many UHF broadcasters who are only inspecting once or twice a week because of remote transmitter locations.

MR. KASSENS: I would agree with you that this appears to be an additional burden, and obviously we don't want to put any more burden than we have to on UHF operators, but you have a year to solve it. I can only say that our experience with UHF remote control up to now has not been the best. I don't want to name names or numbers or anything else, but I would only say that the remote operation of UHF has left us with some problems we are now hopefully curing. My own personal belief is that this is going to be a good thing for UHF because it is going to improve the technical operation by these added requirements. As far as your 20% power thing is concerned, I just don't know how you can solve it.

VOICE: We have a year to do it in; is that what you are saying?

MR. KASSENS: That's right; we are giving a year. I wouldn't want to encourage any waivers, but certainly if any users at the end of a year have a problem, they are welcome to file a request for extension. But we are going to put the pressure on them to get in conformity. Admittedly, the power thing isn't that important in UHF, as far as what we are trying to accomplish. It is the monitoring—more precise monitoring of what is going on.

MODERATOR BURLESON: Is there any change in equipment that must be type approved, other than what is in the present rules, that being frequency modulation monitoring, under these new rules?

MR. KASSENS: Directly, no; indirectly, yes. Just so you understand, the Commission has not approved for television any off-the-air aural monitors or aural and visual frequency monitors. You may have seen some advertisements recently that the Commission has approved these off-the-air monitors. The Commission didn't, and has not approved any monitors for off-the-air operation.

This is a sticky point. We are not saying you can't take monitors and drive them with an off-the-air signal. We are saying that the FCC has not approved any. In other words, we are not in a position of approving the RF amplifiers which drive the monitors themselves.

MODERATOR BURLESON: But by the same token, you are indicating that some new units are permissible for use. It is simply that your authority does not necessarily extend or the rules do not require type approval of off-the-air monitoring? Would that be a way to put it?

MR. KASSENS: It doesn't approve the units you are using for off-the-air monitoring. It approves the monitor itself but not the off-the-air unit, and that is going to be your responsibility and your concern. It gets back to this problem we have been fighting with for a couple of years, If you will remember, we proposed rule making on RF amplifiers, and in effect this is the same thing. We are concerned (as you should be, too) with the bandwidth characteristics of these amplifiers that you drive the monitor with.

VOICE: I have a question for the entire panel: What is their opinion about the test signal which can be superimposed on the video information as a whole—on the normal media information during operation, and can this signal, being a sweep signal, be allowed to sweep the whole system during operation?

MODERATOR BURLESON: During the vertical interval?

VOICE: No; during normal operation. Not being a vertical interval signal, just superimposing it on a resistive basis to the normal video information, but on a basis that low that it would not be visible on a normal home receiver.

MODERATOR BURLESON: Then your primary question is, how do we react to the method of testing?

VOICE: Yes.

MR. GLUYAS: I think when similar things have been proposed before for other services, it has always required a separate petition to the FCC and a trial setup to explore how well this works or doesn't work.

MR. KASSENS: I think what the gentleman is referring to is that perhaps we don't need the test signals during the vertical interval but can pick them up during picture. This is something they may very well want to plow into the rule-making proceeding.

VOICE: That's correct, and it would be sweeping during normal operations without the signals.

MR. KASSENS: I wish you could do it for AM and FM as well. It would be very handy.

VOICE: I would like to make a comment and then ask a question. Regarding Mr. Kelly's concluding comments, I think these are very pertinent, and that was to the effect that this should be an opportunity for all of us to provide improved service. This obviously means that you must have more useful information, more on time, and that you are able to and will do something about it.

In the first instance you might be saying to yourself that since this remote control has in effect as its primary object the reduction of cost, perhaps that reduction of cost should at least be applied in part to improving your quality of transmission in one way or another, and one would hope that this is the case. But if the thrust is more in the direction of what Mr. Kelly is talking about, that you have more sophisticated information about your transmitter and that you are able to use that more sophisticated information to assure continuously that your transmission is better, I think this is really where the great opportunity rests. This is really what Mr. Stovall was talking about. He was introducing a new suggestion that perhaps is a little startling to us, and that was in effect to be able to insert on top of the video signal, during the entire period of the picture, test signals which are of such level and of such nature that two things could happen: One, it does not interfere; it is not observable on the home receiver. The other is that this signal can be extracted and give you useful information about it, in a very large number of parameters of your transmitter, as to whether or not it is in fact distorting or not distorting.

This is something we should direct our attention to. This is beyond the VIT signal. The question was, what is the concern about the specific information of the VIT signal? I don't understand why the concern, except such a signal shouldn't cause interference. If this area of the video signal—these lines—are set aside for useful information in determining what the transmitter is doing, or even asking it to be adjustable based on that, why is there a need for a standardization of the VIT signal?

MR. ANDERSON: I think the thing goes further than that. I would only say that there should be some minimum standard, than that which I am sure the Commission will require in order for them to be satisfied that what we are monitoring and what we are maintaining is a high quality picture.

Obviously, this could mean a difference as far as the numbers and the types of signals that could be used are concerned, by the various stations depending upon, let's say, the amount of money available, the type of people available, and so on. So, my only point was that I was somewhat directing my point to the FCC, in that whatever they said is the standard, it ought to be only the minimum, and not restrict the rest.

MODERATOR BURLESON: I have to break in here and thank Mr. Herman as a very dedicated operator for giving us the reminder that this is an opportunity to run better stations engineering-wise. Also, the questions are closed. There is a final statement-maker, the honorable FCC rule-maker.

MR. KASSENS: Very briefly—and I won't go into detail on these, but just to keep you out of trouble in case you have difficulty reading between the lines (you know we are experts at that, but some of you may not be)—we have a few little goodies in the Order which you shouldn't miss.

One, and a rather important one, that concerns us is that we have a requirement for calibrating the visual waveform monitor. Be careful about this, because this does not mean cranking up the gain on the RF amplifier which is driving this monitor. Just to make sure your 100% level is correct. It says "calibrate the monitor," which means in effect making sure that the monitor is reasonably linear. Perhaps this is one of the reasons we use multiburst and that sort of thing. Be careful of that one.

The second one: We do require at the remote control point the peak flasher. This is something that has not been provided in AM and FM. A lot of remote control equipment does not provide for remote reading of the peak flasher. In television we are requiring it, so make sure you have a properly calibrated peak flasher at the remote point.

The third one—and if I can just take a second because I know we are going to get into trouble with this: Let me read the rule on operators, because I think this is one of the biggest factors in this proceeding:

"The control point shall be under the immediate supervision and control of one or more operators meeting the requirements of Section 73.661 at all times when the station is operating by remote control. Such operators may perform other tasks which do not require absence from the remote control position and do not otherwise impair necessary supervision of the television transmitter."

You know what has happened in AM and FM, and this is one of the things that concerned the Commission last time around, and the one thing they said had to be tied down. We believe in the wording of the rule that we have tied it down. It doesn't mean this operator can go into the shop and repair equipment. It doesn't mean he can load film cameras, and that sort of thing, if it takes him away from this position of duty which we call the remote control position.

We don't get into this question of mirrors and that sort of thing. The man is coming down off the mountain, but he has got to be performing these duties at the remote control point. As I say, I think we may get into difficulty on that one, so be very careful of it.

Rapid Checkout of Audio & Video Transmission Performance in a Broadcast Plant

Hans Schmid
ABC, New York, N. Y.

In September 1970, ABC-NY put into operation its 100 X 60 routing switcher. The switcher was described in detail at the 1970 NAB Convention (TAB No. T170). Briefly, the switcher permits any of 100 sources, both audio and video, to be available at any of 60 destinations, by touch dialing a 3-digit code number. One of the 100 sources is a transmission test signal. In order to be used routinely, the test signal must be available at all times, it must be capable of checking all major transmission parameters and the measurements must be obtained in an effortless manner. Only then can the measurements be done routinely, measurements that usually are simply not made because of the complexity of equipment, set-up and procedure or lack of time.

To test the major transmission parameters, such as level, linear distortion and nonlinear distortion, it is obvious that the Routine Test Signal must contain a number



AUDIO ROUTINE TEST SIGNAL				
STEP	SIGNAL	LEVEL AT 150 Ω	USED FOR	
1	1 kHz		GAIN	
2	50 Hz			FREQ RESPONSE
3	100			
4	200			
5	500			
6	1 kHz			
7	2			
8	5			
9	10			
10	15			
11	1	8 dBm ± .2 dB		
12	NOISE	≥ 80 dB S/N RATIO	S/N RATIO	

TABLE 19-1.

STEP	SIGNAL	USED FOR
1	HALF-LINE PULSE & T STEP	GAIN, LINE-TIME WAVEFORM DIST
	T PULSE	SHORT-TIME WAVEFORM DIST
		T PULSE RESPONSE
	MOD 20T PULSE	REL CHROMA LEVEL & TIME
2	MOD STAIR STEP 10% APL	DIFF GAIN & PHASE
3	" " " 50% "	
4	" " " 90% "	
		REL BURST AMPL & PHASE

TABLE 2

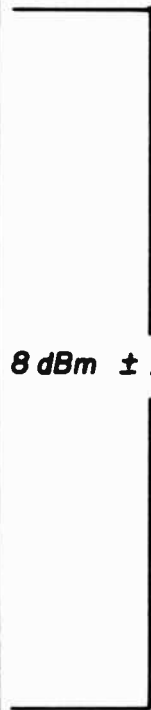
of steps or components, each geared to do a specific task. For such a composition of signals to be available at all times, the signal must be continuously cycling. A full cycle and its steps is shown in Tables 1 and 2. Table 1 shows the Audio Routine Test Signal; Table 2 shows the Video Routine Test Signal. Also shown in the tables are the transmission parameters to be measured by the individual components.

THE AUDIO ROUTINE TEST SIGNAL GENERATOR

The Audio Routine Test Signal Generator has been designed to our specifications by the ABPHOT Corporation of New York. The unit provides the signals as described in Table 1. Its main feature is the complete absence of operational controls and metering. It has two isolated outputs, the PGM output and the MON output. Both outputs are identical and are obtained by a resistive split from a common point. The isolation between both outputs is so that there is only a .1 db variation of level on the MON output when the PGM output is varied between open and short, thus preventing program line effects from falsifying the readings at the MON output. The MON output only is used to operationally measure the performance of the generator.

The signal frequencies of the generator are obtained from a Wien Bridge oscillator whose RC components are switched by reed relays. The timing for the switching is derived from a counter. The duration of each step is approximately one second except for step one (1 kHz, 8 dbm) which has a 4-second duration since this signal may have to be used to set the gain of the system under test. Thus the total time for a complete cycle as shown in Table 1 is approximately 15 seconds. These times had been established after some experimenting. From the experiments we learned that most observers preferred the shortest possible cycle (and thus short steps) because missing a step in the measurement was found to be less annoying than having to wait a long time for a cycle to be completed.

THE AUDIO ROUTINE TEST RECEIVER

The Audio Routine Test Signal Receiver has been designed at the ABC Engineering Lab. Fig. 1 shows a front panel view of the unit with its modular sub-units. The sub-units from left to right are:

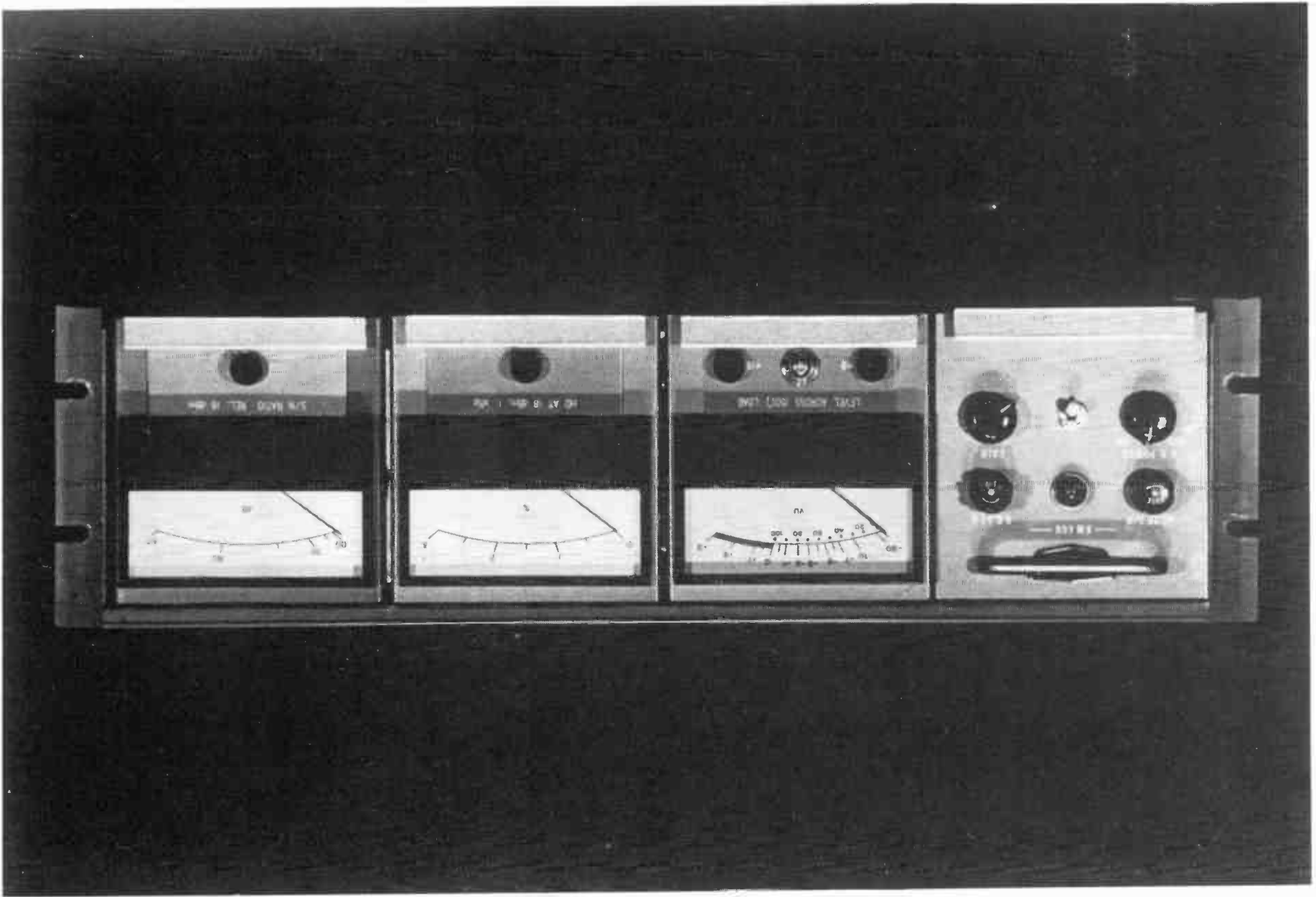
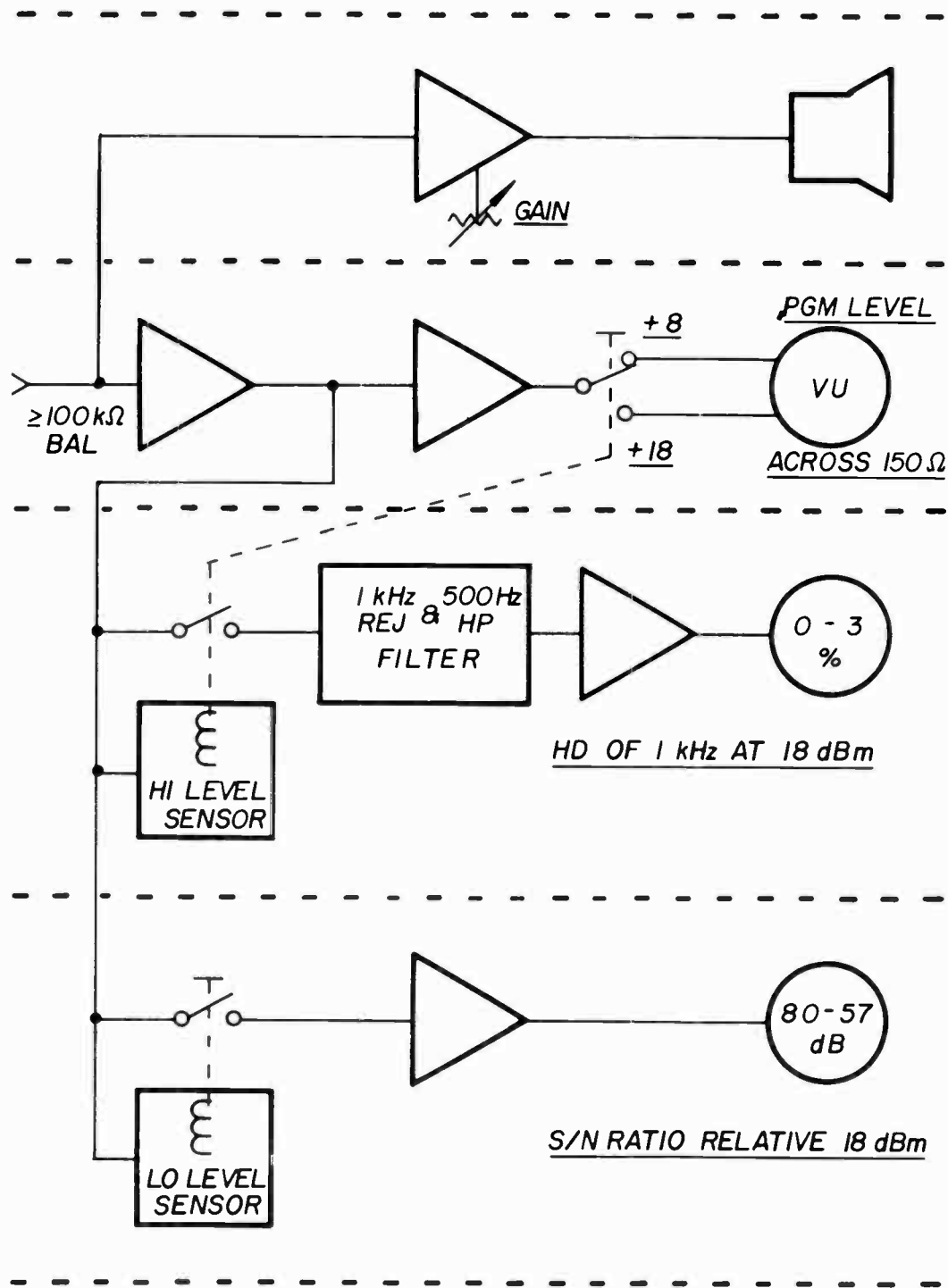

Fig. 1.



AUDIO ROUTINE TEST RECEIVER

Fig. 2

1. Monitor amplifier
2. Automatic VU meter
3. Automatic harmonic distortion meter
4. Automatic signal-to-noise ratio meter

The receiver works completely automatically, using only the information that is contained in the routine test signal itself. Fig. 2 shows a simplified block diagram. In 15 seconds an observer can check level, frequency response, harmonic distortion and SNR without touching the equipment.

Automatic VU Meter

This unit contains an amplifier which provides the proper source impedance for the VU meter ballistics and at the same time provides a very high input impedance which bridges across a 150-ohm load with a bridging effect of less than .05 db. The VU meter range is indicated by pilot lights which indicate either an 8 VU or 18 VU range. Normally, the unit is on the 8 VU range, but it can be switched to the 18 VU range by means of a momentary pushbutton or by a command from the harmonic distortion meter. It is obvious that steps one to ten of the routine test signal will be read on the 8 VU range. See Fig. 3.

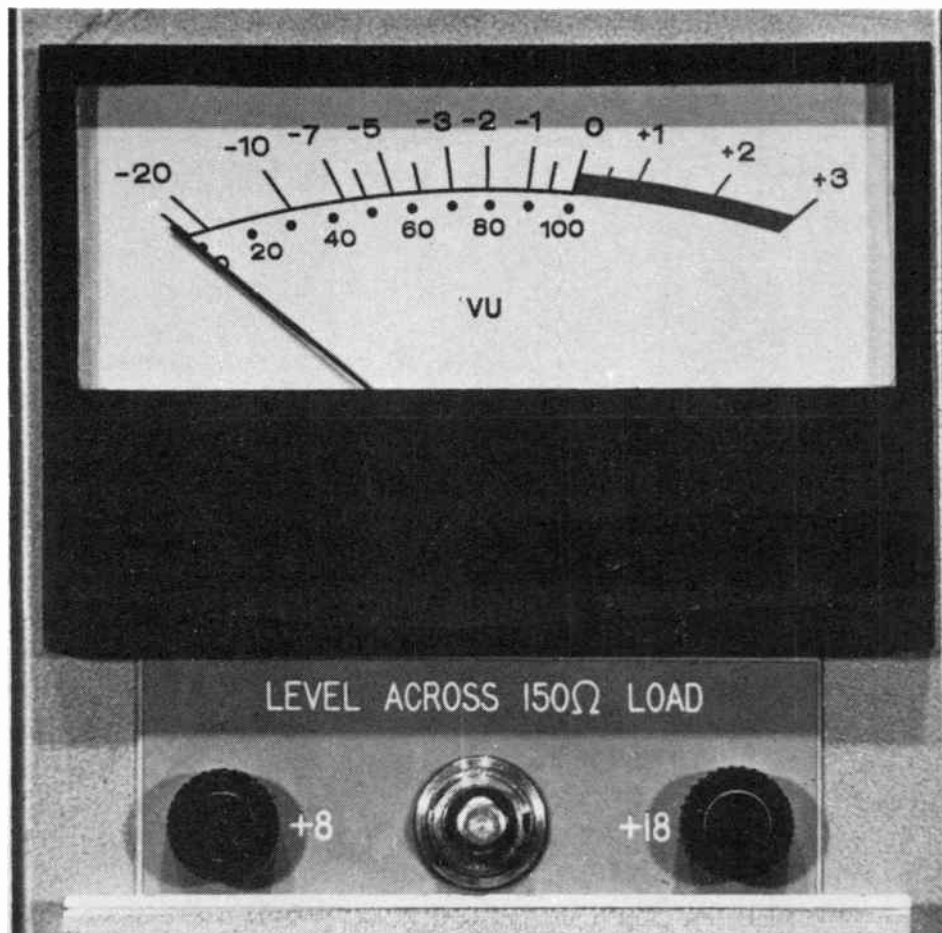

Fig. 3

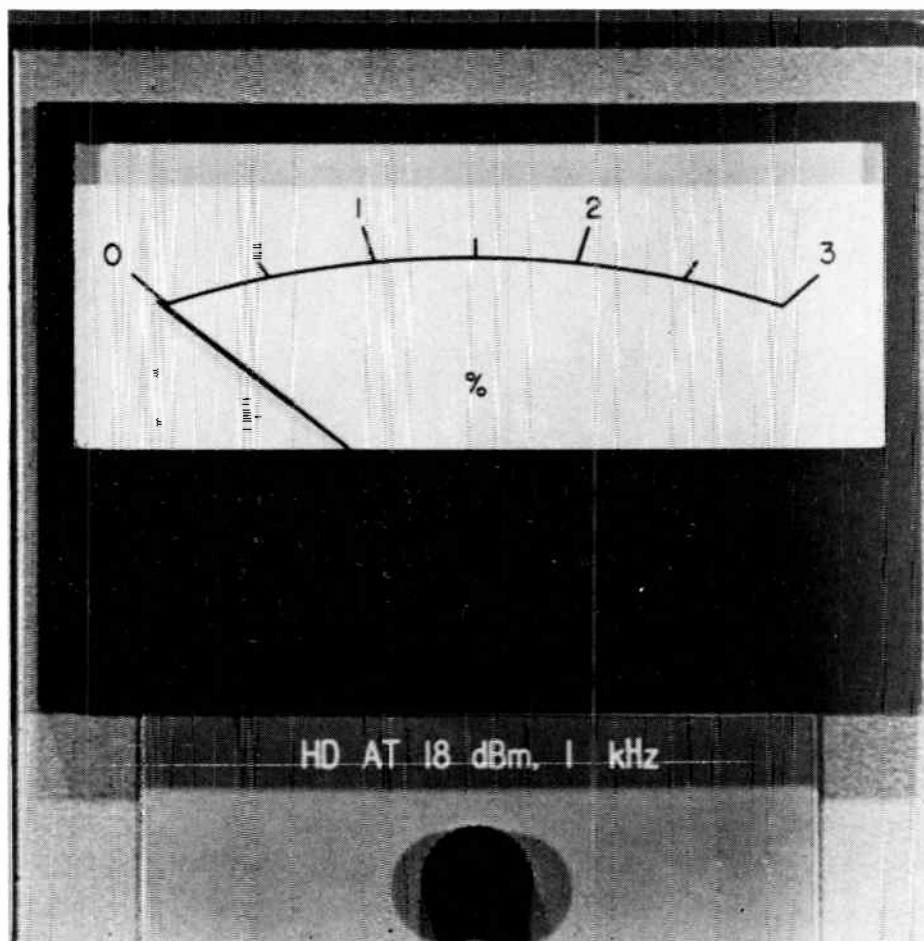

Fig. 4

Automatic Harmonic Distortion Meter

This unit derives its signal from a buffer amplifier in the VU meter unit. A sensor circuit senses the 19 dbm level of Step 11 of the routine test signal and actuates a relay that connects the meter circuit to the signal. A 1-kHz rejection filter, together with a highpass filter removes the fundamental and possible power supply hum. An amplifier with calibrated gain amplifies the harmonics of the 1-kHz signal for proper meter scale deflection. A pilot light indicates that the circuit is operative. A maintenance test switch in the unit is provided so that the calibration can be verified from time to time using the 8 dbm frequency response signal of steps two to ten. The 18 dbm sensor also actuates the 18 VU range switch in the VU meter unit, thus permitting the level to be ascertained. To keep the receiver simple, only 1 kHz was chosen for the measurement. This is sufficient to indicate any malfunction of a circuit that had initially been "acceptance-tested." See Fig. 4.

Automatic Signal-to-Noise Ratio Meter

This unit also derives its signal from the buffer amplifier in the VU meter unit. A sensor circuit senses a level of -30 dbm or less during Step 12 of the routine test signal and actuates a relay that connects the meter circuit to the signal. An amplifier with calibrated gain amplifies the noise signal for proper meter scale deflection. A

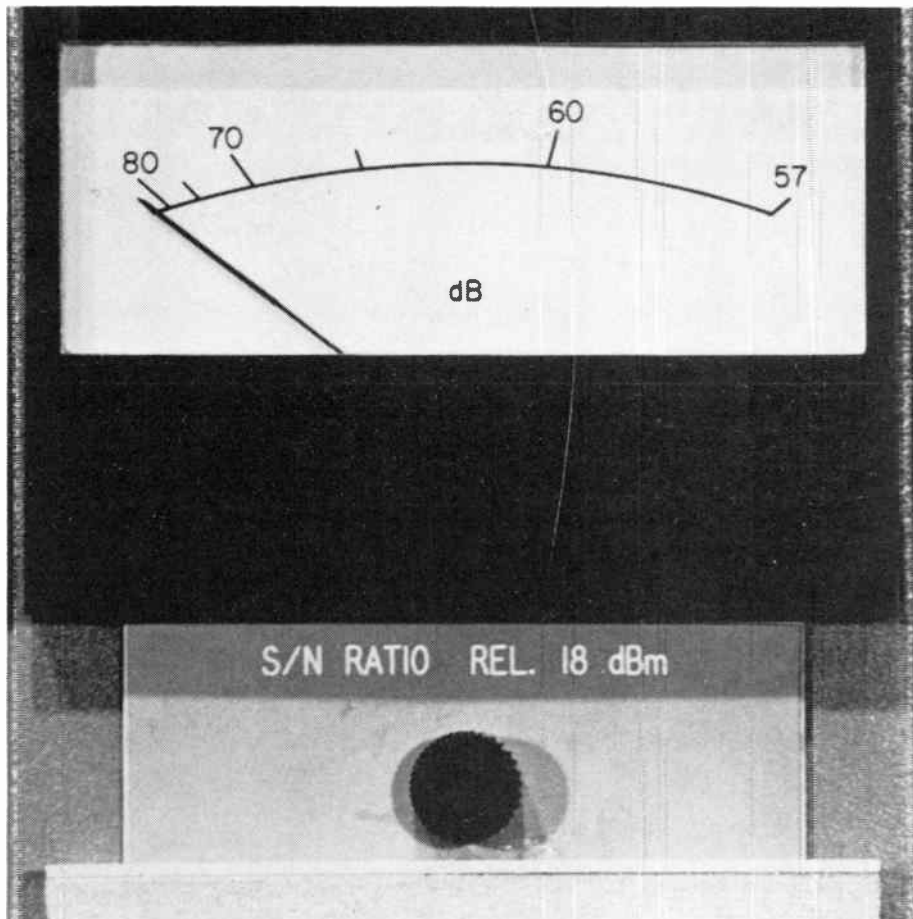

Fig. 5

pilot light indicates that the circuit is operative. A maintenance test switch in the unit is provided so that the gain calibration can be verified from time to time using the 8 dbm frequency response signal of steps two to ten. See Fig. 5.

Video Routine Test Signal Generator

This generator is a Richmond Hill STG 500 Video Test Signal Generator. As a standard feature, this generator provides for external selection of various signal outputs. In our case, a cycling timer selects the signals as shown in Table 2. The duration of each step is approximately two seconds, except for Step 1 which has a 4-second duration, since this signal may have to be used to set the gain of the system under test. Thus the total time for a complete cycle as shown in Table 2 is approximately ten seconds. These times have been chosen by the same considerations as described for the audio routine test signal generator.

THE VIDEO TOUTINE TEST RECEIVER

This receiver is simply an assembly of available equipment:

1. Picture monitor
2. Waveform monitor
3. Vectorscope

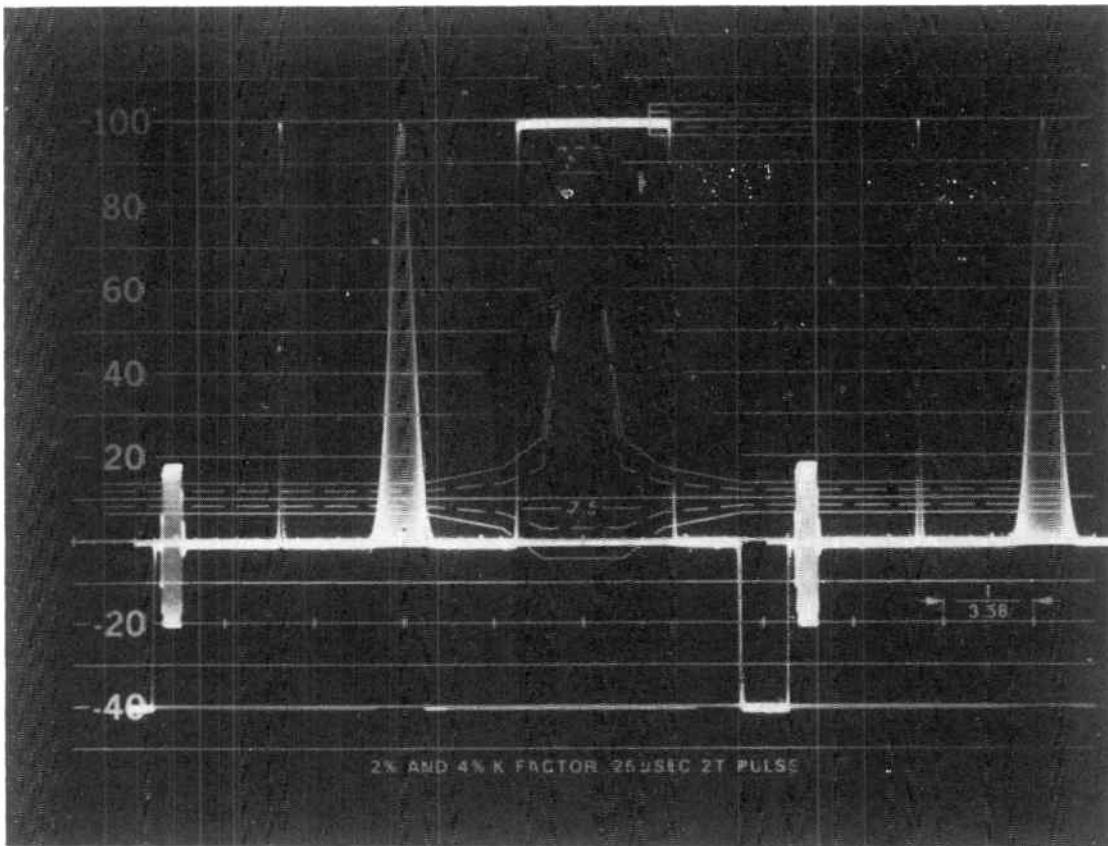

Fig. 6

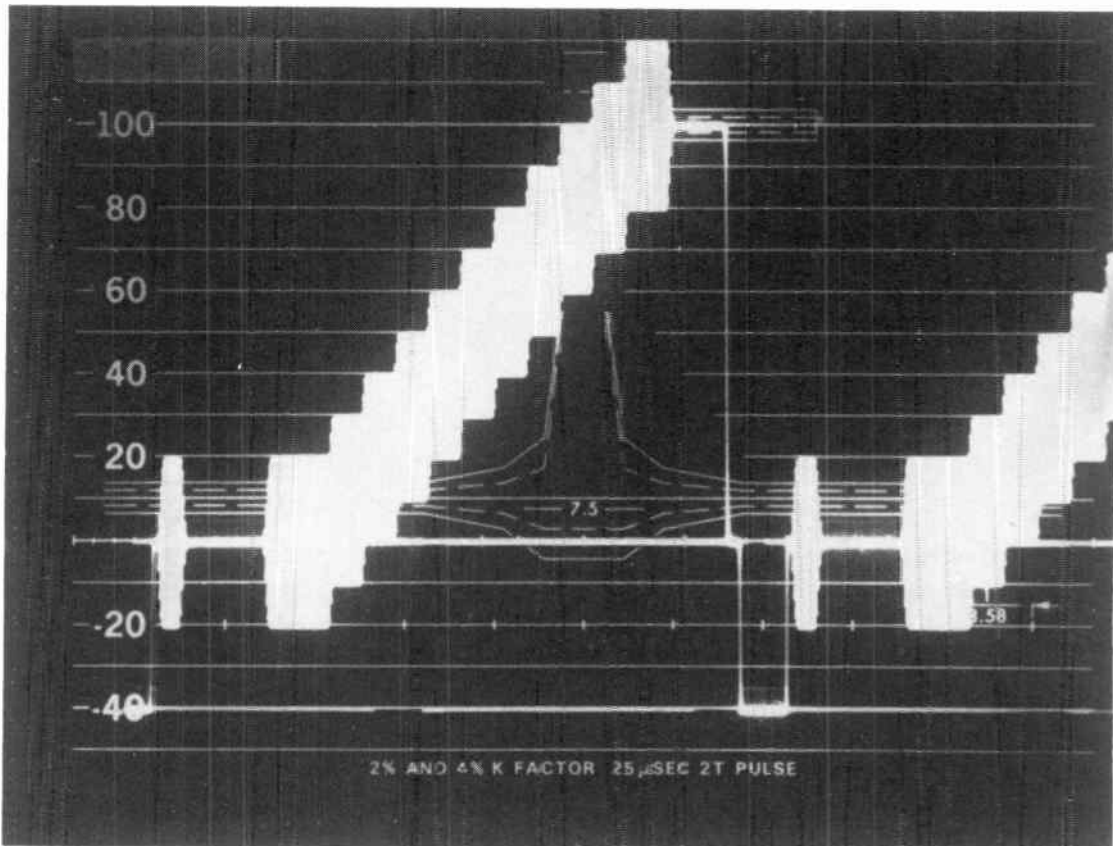

Fig. 7

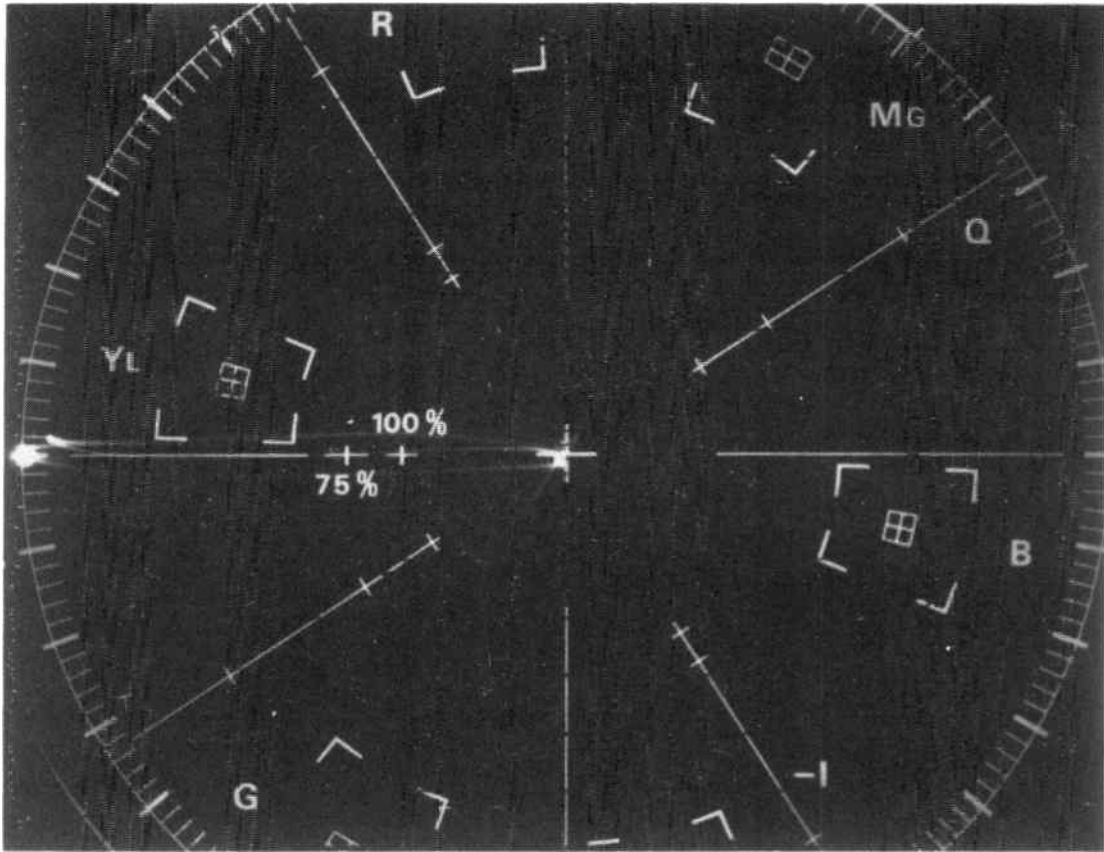

Fig. 8

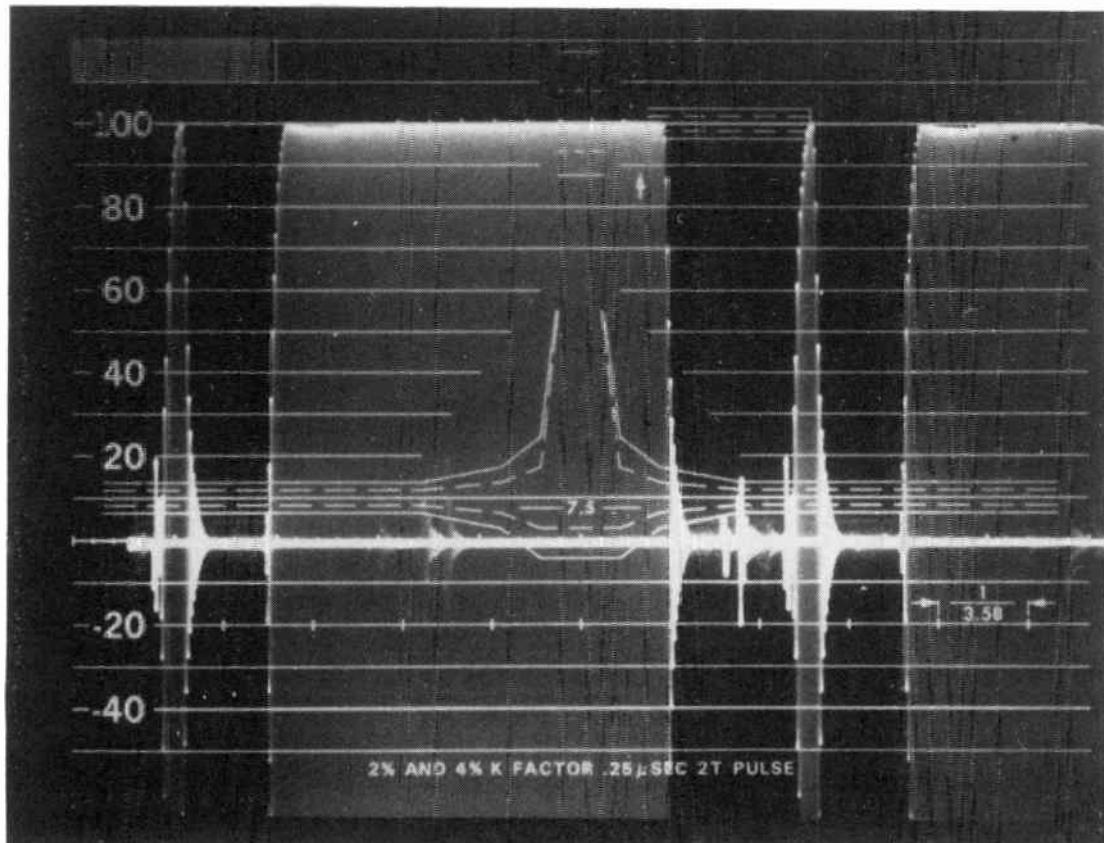

Fig. 9

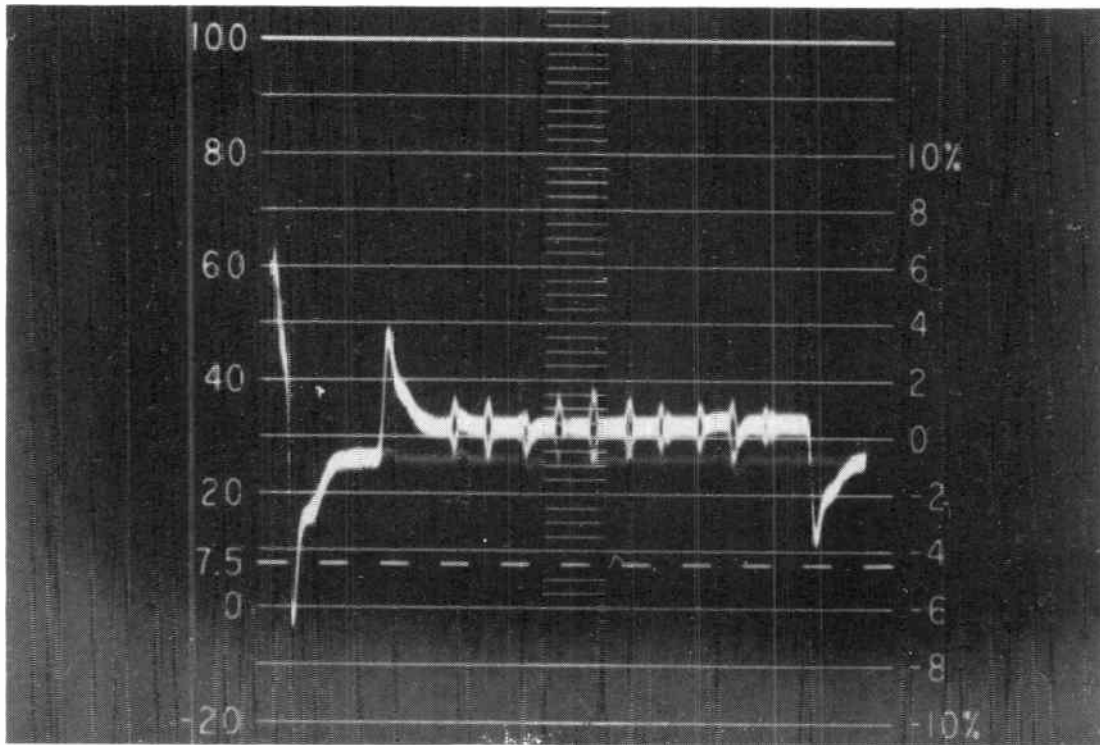

Fig. 10

At the present, unfortunately, this equipment cannot be externally programmed for different modes of measurements such as switching the vectorscope, for instance, from the "vector" mode to the "differential phase" mode. These modes must, therefore, be selected manually since the other alternative of a scope for each mode is, of course, prohibitive when considering cost and space requirements. For the time being, we require two cycles of the video routine test signal to cover the whole range of measurements and the scopes have to be switched manually to the proper mode. However, in the near future, there will be available a new test signal generator with which an automatic system, comparable to the audio system, becomes feasible.

The test signal steps listed in Table 2 and their application are shown in the following figures. Fig. 6 shows the signal of Step one and from left to right we see the T pulse, the MOD 20T pulse and the half-line pulse with a T-step rise and fall. Fig. 7 shows the signal of Step 3, the MOD stair-step signal at 50% APL; the sub-carrier modulation is 40 IRE for direct comparison with the color burst amplitude and phase as shown in Fig. 8, where we see a relative burst amplitude of -4% and a relative burst phase of plus 2° . Fig. 9 shows the differential gain display while the differential phase display is shown in Fig. 10, where we see less than $.1^{\circ}$ of differential phase. The "direct reading" feature of this display, with an approximate sensitivity of 1° per major division for small angles, has been obtained by modifying the Tektronix 520 vectorscope. This modification is necessary because the recommended "slide-back" technique for measuring differential phase is too time consuming for our purposes.

CONCLUSION

Both the audio and video routine test systems described above have been installed in ABC NY's Central Switching Control where they are performing successfully and have proven to be a very desirable operational tool. The fact that the signals are available so readily and that the tests hardly take any time has encouraged our operators to perform tests frequently, resulting in a high degree of confidence in our circuits. At present, operational procedures are being established. Already we have in some instances recorded the video and audio routine test signals on videotape leaders and our central switching operators make extensive loop checks. To use the system to their fullest capabilities, several generators and receivers will eventually be installed, thus permitting straightway measurements to and from studios. Also anticipated is the use of these systems in a computer controlled testing scheme.

The author is grateful to W. Bohlin and M. Lipow, both of the ABC Engineering Lab, for their assistance and contributions. The author also wishes to acknowledge the contribution of M. Decker, Chief Engineer of ABPHOT Corporation of New York.

REFERENCES

1. H. Schmid, "Measurement of Television Picture Impairments Caused by Linear Distortions," Journal, S.M.P.T.E., 77: 215-220, March 1968.
2. F. Davidoff, "Status Report on Video Standards, I.E.E.E. Video Transmission Subcommittee 2.1.4," I.E.E.E. Transaction on Broadcasting, June 1969.

New High-Impedance, Low-Distortion Interphone Amplifier

J. L. Hathaway
NBC, New York, N. Y.

An improved studio intercommunication system was described by Pierce Evans in the Journal of the SMPTE, October 1959, and the basic principles have been extensively employed by broadcasters over the intervening years. A two-wire line connected the various private line (PL) units and supplied DC operating power. Bridge rectifiers were used in each unit so that either polarity supply voltage on the bus could be accommodated while maintaining correct polarity at the earphone amplifier. There was a means of driving the line from a carbon microphone. Also, a resistance bridge was provided for cancellation of the microphone signal at the input of the companion earphone amplifier. Results were greatly improved over previous PL systems not endowed with an amplifier or suitable side-tone cancellation facilities.

It seemed desirable, a few years later, to also amplify the microphone output and so increase the "PL bus" level. This offered further improvement and has been widely used. However, with the passage of time, television intercommunication systems have expanded to the point where results still leave much to be desired. For example, large field pick-ups, such as the World Series or important football games, frequently entail more than 20 PL amplifiers (PLAMPS) loading down a communication bus. Each PLAMP exhibits 40 to 60 ohms at its terminals, depending on design, voltage, whether the microphone switch is "on" or "off," etc. The resulting bus load may thus be 2 ohms or less if we neglect the interconnection wiring. Specific bus wiring can also be a problem, where some lengths are very short and others may be more than 1000 feet of twisted 24 gauge! Further complicating the problem may be a very high acoustical noise which must be over-ridden by the PL equipment. This combination of adverse factors has sometimes led camera men into rather primitive communication just short of wig-wag, in order to rush information to or from central control.

Recently, the severity of the low-impedance loading has been somewhat reduced by connecting each PLAMP unit to the bus through a 1-to-10 ratio impedance step-up transformer. This helps materially with the high-resistance long-line problems, but part of the benefit is lost in the voltage step-down action of the transformer feeding the earphone amplifier. Nevertheless, it does give an overall improvement and our new units, for interchangeability reasons, work with such transformers. However, this alone is far from a solution to the main problems.

Last year, in a desperation move born of unbelievable troubles, we undertook development of an improved PLAMP. This new design has been found to possess several advantages over the known predecessors, including:

1. Terminal impedance increased by roughly six-to-one.
2. Undistorted output power from the microphone amplifier into a given impedance load increased many fold.
3. The new unit is highly stable and unaffected by reasonable changes of temperature or operating voltage.

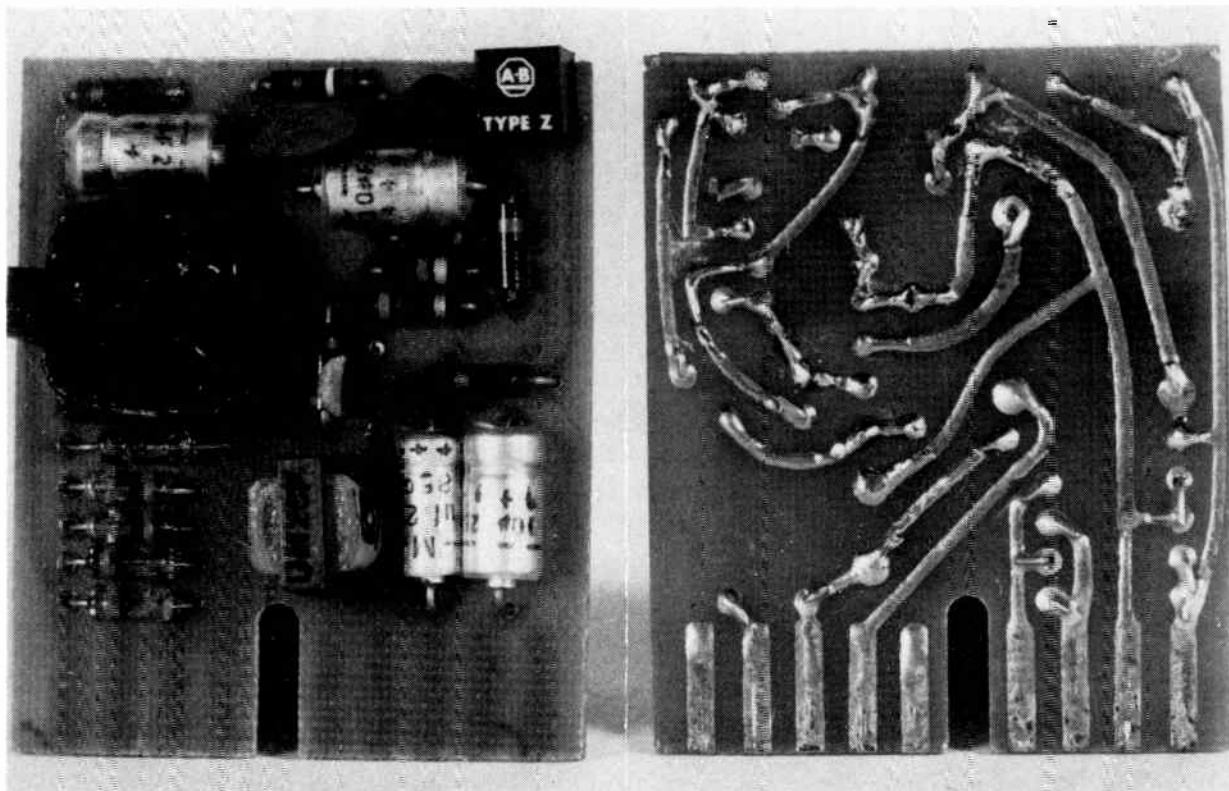

Fig. 1

4. Ordinary manufacture has produced units of almost duplicate characteristics. In order to raise the terminal impedance to appreciably above the 40- to 60-ohm range, consideration was given to the causes of such low impedance. First, numerous low-value resistors were in the circuit, effectively shunting the two-wire line. For example, the side-tone cancellation bridge circuit has been a serious offender, especially so when an adjustment of around 60 ohms are needed in one leg for proper cancellation. These bridge resistors and a number of others of relatively low ohmage have placed an upper limit on the maximum attainable impedance without including the several other causes of low impedance. One of the latter is a negative feedback component from the earphone amplifier which further reduces impedance, especially when gain is raised. Then there is a negative feedback impedance reduction from the microphone amplifier. When the microphone is "on," it shunts this amplifier's input and so prevents most of the feedback. However, when it is switched "off," the input biasing resistors create a feedback condition, appreciably reducing terminal impedance.

The newly developed high-impedance PLAMP is pictured in Fig. 1. This printed-circuit card measures 1 11/16 by 2 inches, including the connector fingers. It is interchangeable plug-in with one of the earlier models used extensively.

Fig. 2 is a schematic of the new PLAMP, including the remotely located headset, volume control, impedance step-up transformer, and a "house supply" DC voltage source. Circuit wise, the new unit is somewhat similar to the old, with a few main exceptions.

1. Instead of a low-resistance bridge for side-tone cancellation, an adjustable high-value resistor feeds an out-of-phase signal from the microphone amplifier to the input of the companion earphone amplifier.

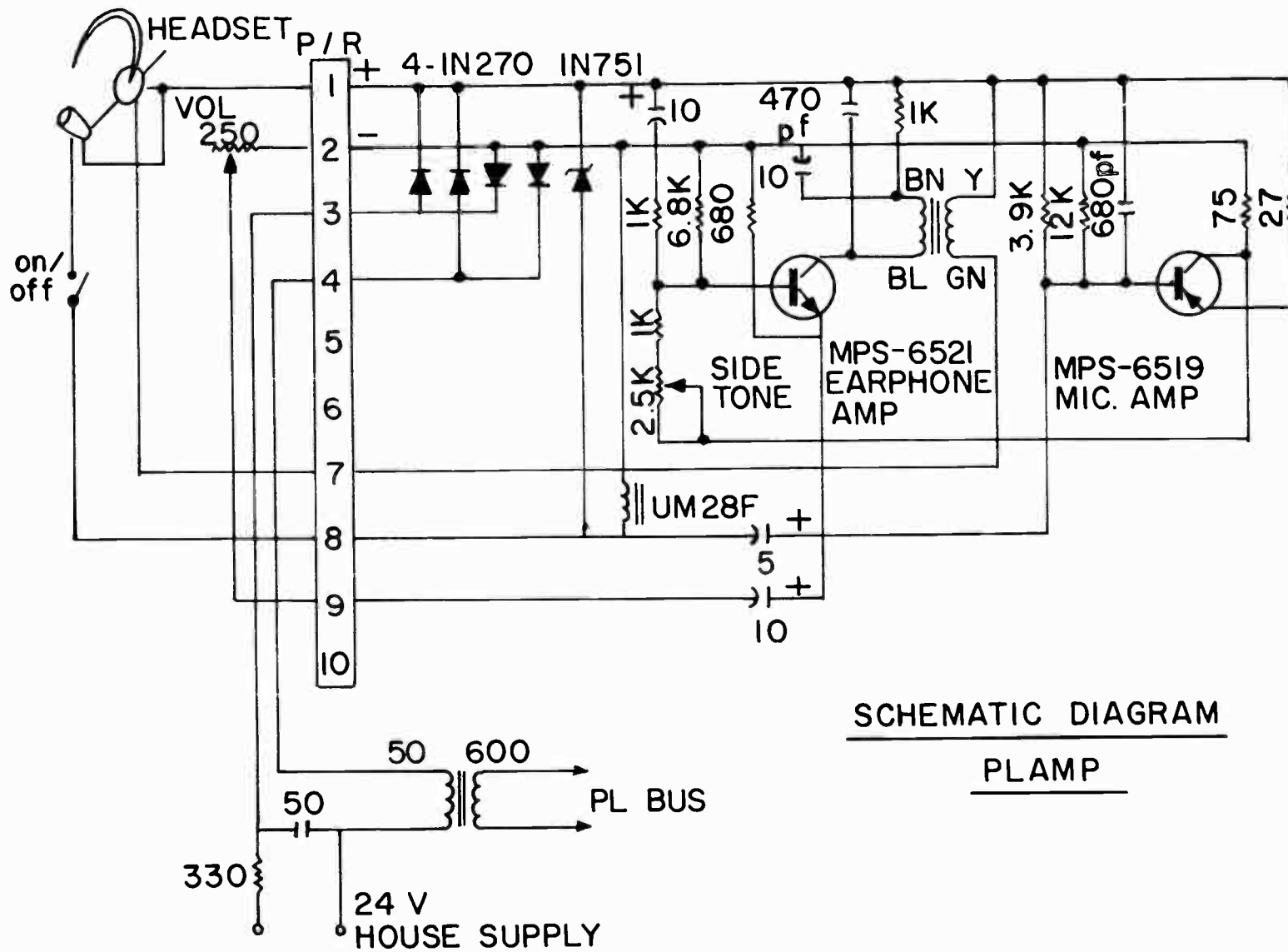

Fig. 2

COMPARISON OF NEW & OLD PLAMP

	<u>NEW</u>	<u>OLD #5</u>	<u>OLD #34</u>
A INPUT IMPEDANCE.	3800	530	760
B GAIN TO EARPHONE (VOLTAGE.)	2.1	2.1	2.3
C MAX. UNDISTORTED p/p V EARPHONE WITH LIMITER.	0.4	0.4	0.4
D MAX. MIC. AMP. p/p V OUTPUT (10% DIST.)	1.7	0.5	0.2
E MIC. AMP. VOLTAGE GAIN	0.5	2.0	1.6
F TOTAL CURRENT DRAIN	41mA	29mA	21mA

- notes:
1. Measured at 1 KHz.
 2. 8.5V dc into unit.
 3. Measurements at high Z side of 1 to 10 trans.
 4. 100 Ohm load across high Z side, tests D & E.

Fig. 3

2. A low-voltage zener diode is connected at the microphone circuit so that whenever the switch is thrown off, the zener conducts and so places an effective short circuit on the amplifier's input. This prevents negative feedback and its consequent reduction of impedance.

3. The polarity of the earphone transformer secondary produces a negative feedback component on the bus. However, the transformer primary is bypassed so as to give a compensating positive feedback. Thus, the overall feedback from this amplifier is negligible, regardless of volume control setting.

4. The transistors are silicon, each stabilized with emitter resistors and relatively low-value base resistors. The microphone amplifier is biased for optimum output rather than backed-off on collector current to avoid a runaway condition from heating, as was the case in the old unit.

An interesting but revolting situation arose during development of the new PLAMP. The preliminary model was tested extensively in the laboratory and found to outperform its predecessors. Then, it was tried in the field, on short and long cable lengths. Reports, without exception, were glowing; less distortion, more level, less loading, etc. Next, eight were constructed for a semi-operational test. These, in a studio, gave good results at certain locations but at others the earphone amplifier refused to work. After more lab tests, the trouble was found in the studio. Some of the earphones contained a little green bead connected across the terminals. We had assumed this to be a small capacitor, but it turned out to be a duodiode limiter. Its purpose seems to be to greatly reduce loud clicks. For simplicity, we had avoided the use of transformer coupling to the earphone, so the small DC collector current had caused the duodiode to short out the earphone. None of the first dozen or so headsets used in testing contained the limiter, but subsequent search in the studios turned up a great many that did. So, to avoid future confusion, we changed over to transformer coupling. Incidentally, if an earphone has a one-volt peak-to-peak sine-wave signal across it, and a limiter bead is then connected, the signal changes to 0.5v, almost a perfect square wave. In our service the distortion so created is of little consequence, however, because the signal is quite loud at the verge of limiting.

Operating characteristics for the new PLAMP and those of the latest known predecessor are charted in Fig. 3. For the new unit, only a single set of values is shown, since our measurements of 19 units gave insignificant differences. Two of the predecessors were selected to show the wide divergence between units, but it should be pointed out that these two do not represent the entire range encountered.

The first improvement in the new units is in the loading impedance, which has been raised about six to one. Then, the output power, as shown, has been raised 11 to 1 over the better of the old units and 72 to 1 over the other. It should also be noted that gain of the new microphone amplifier is appreciably less than that of the old (average about 11 db). In the new circuit the microphone feeds a higher impedance and also it has a higher DC current, by way of the choke, resulting in about 6 db higher output voltage. This means 5 db lower effective gain in the new unit, which is a definite advantage. The old ones have excessive gain and, as a result, low-level talk produces maximum output level. With them, when the user needs greater output he talks louder and about the only increase is in distortion. His voice be-

comes non-understandable. With the new unit, low-level speech does not approach full amplifier output, so if more signal is needed to cut through for some reason, such as high ambient acoustical noise, the user can speak much louder without loss of intelligibility.

Thirty of the new PLAMPS have now been in daily service with gratifying results. We have heard the comment that intercommunication is no longer the weak sister of television broadcasting.

Signal-Loss Detector Suitable for Audio & Video Systems

Sherman Atwood
NBC, New York, N. Y.

Most electronic equipment left running continuously seems to be subject to less frequent failures and is much easier to maintain in a state of readiness than equipment which is shut down on a daily basis. Very often, such equipment is functioning unattended at a remote location. Dependable monitoring of such unattended equipment is very desirable.

Unattended remote equipment supplying normal audio and video signals is monitored in Radio City by a sensing device which is set to detect a modest reduction of signal level and actuate an audible alarm. At this point both audio and video circuits can be checked by conventional means. If signals have departed appreciably from normal, further appropriate action can then be taken.

It was first proposed to automatically monitor, at Radio City, both the audio and video signals on our incoming lines from our facilities at Englewood Cliffs, New

DESIGN REQUIREMENTS

1. An input audio sine wave signal level from -30 to -70 dBm with a built-in sensitivity control.
2. An input impedance of 10,000 ohms or higher so that the device could bridge any circuit.
3. Either side of the input may be grounded but neither side must be.
4. A signal change of not more than 50% should activate a relay contact closure, the actual alarm being a separate device.
5. A power requirement of 115 volts ac.
6. The alarm relay should not chatter at the trigger point.
7. Repeatability should be within 10% but if the signal content changes this limitation does not apply.
8. If the above requirements can be met, it should also accept video signal and perform in a similar manner.
9. The cost should be below \$200.

Fig. 1

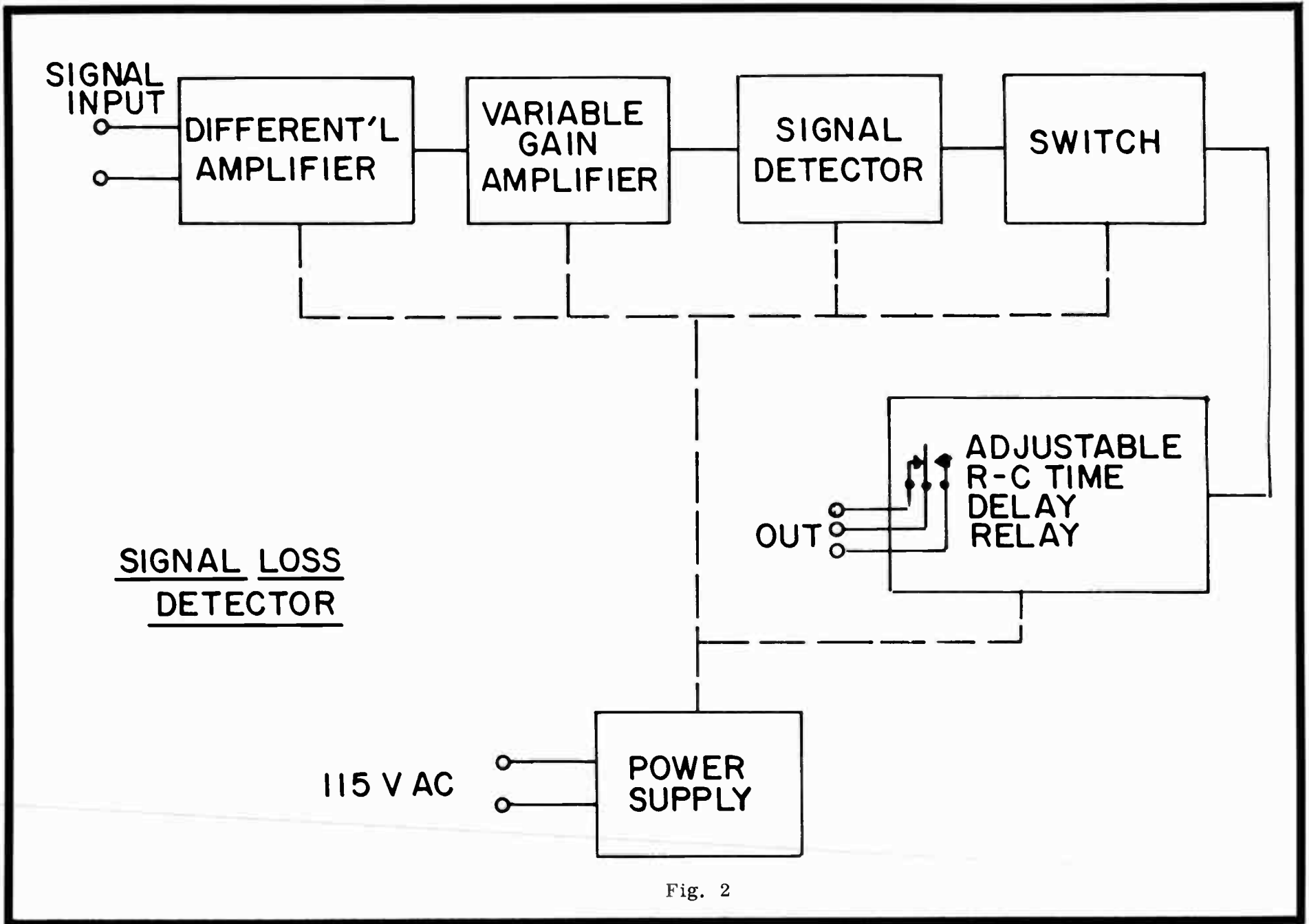

Fig. 2

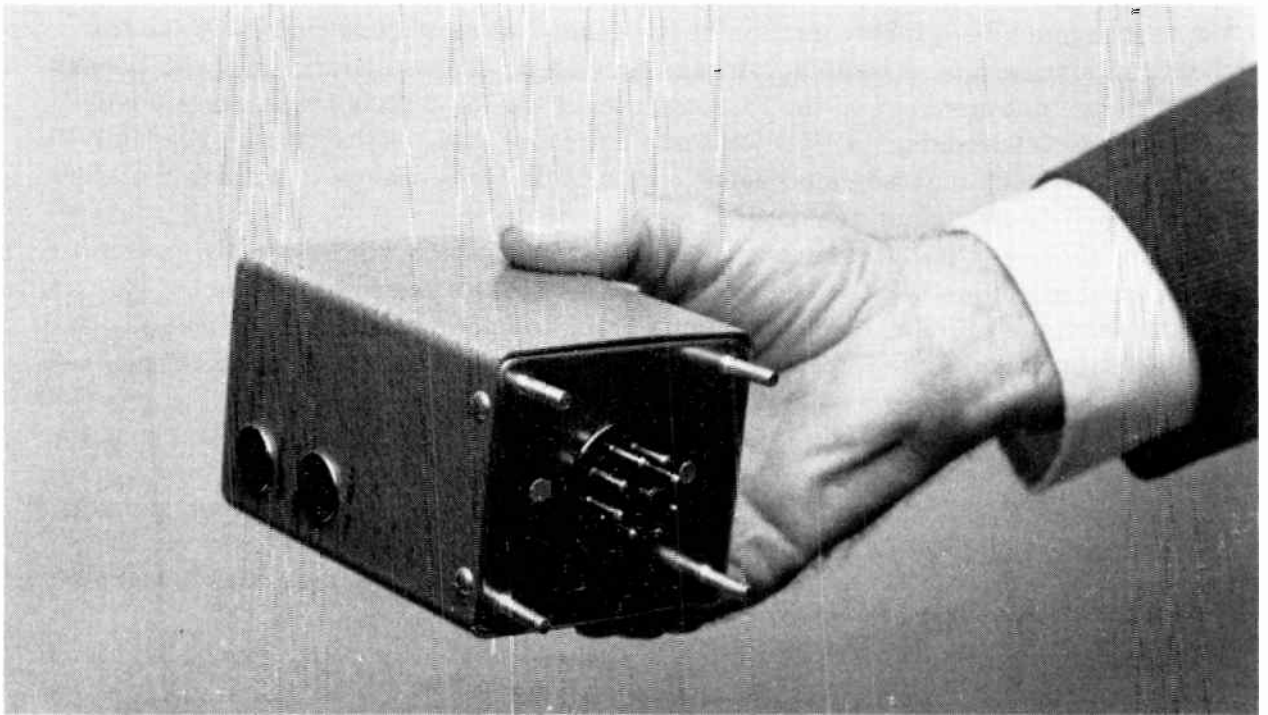

Fig. 3

Jersey. An alarm was to sound if there was a total signal failure. There are a number of sensing devices available for this purpose; however, it was decided that it would be much better from the standpoint of maintenance and spare parts, if the device would work on both audio and video signals. Almost any video signal has enough low-frequency component to make it practical to sense its presence at a frequency considerably below subcarrier frequency. It was also hoped that we would end up with a device which would sense a much smaller signal change than that represented by signal failure.

The requirements stated that the sensing device should operate within certain ranges (as may be seen in Fig. 1):

After a period of breadboard and test by an outside vendor under the direction of Mr. Robert Post of NBC's Development Group, a product was developed which proved to be even better than our most optimistic hopes. A block diagram of the unit is shown in Fig. 2.

The integrated circuit differential amplifier provides high common-mode rejection and, therefore, no hum problem, balanced or unbalanced high-impedance input, and low output impedance to drive the following stage. The integrated circuit variable gain amplifier provides adjustments for signal levels of from -30 to -70 dbm. The signal detector has a diode network and filter which assures the proper signal to operate the switch.

The switch is an integrated circuit operational amplifier connected as a differential switch. The switch has two inputs, one of which is referenced to the power supply and the other to the signal detector. Varying power supply voltages and spikes are cancelled out in one input and the output from the signal detector, then causes the other input to operate the adjustable RC time delay relay. The power supply is transformer isolated and provides the voltages required to operate the various components as shown.

The finished product is shown in Fig. 3. Connections are by means of the octal socket on the bottom, the two adjustments—threshold level and time delay—are under the removable buttons on the side, and four mounting studs are provided to secure the unit to a chassis.

The test signals used for evaluation of the sensor were, 1,000 Hz sine wave for audio, and standard composite color bars for video. Tests showed that with proper level of these test signals and the threshold level set for 2 db below normal level, there were no false alarms. Further tests indicated that sensitivity and repeatability appeared to be such that we could count on a half db level change to actuate the alarm. This assumes no change of signal content.

The sensitivity control is a screwdriver adjustment which minimizes the possibility of accidental misadjustment. There is one other screwdriver control which, in our case, is set for minimum. This is a time delay for actuating the alarm relay. The available built-in delay is 35 seconds, but it is not practical in our application to use this delay and leave the sensors energized all the time. There are many long periods of time when there are no signals and it is not desirable to be switching test signals in and out of the circuits.

The final assembly of our package is shown in Fig. 4 and consists of four sensing devices mounted on a 5 1/4-inch rack panel, together with an audible alarm, four pushbuttons to test each of the four sensors, necessary signals attenuators and an on-off switch.

A block diagram using one detector is shown in Fig. 5. The pad reduces the signal to an acceptable level, the test switch permits a quick test to determine that the detector is working, and the alarm alerts someone that a signal failure has occurred.

In order to accommodate the one-volt video signal, and the audio signal which was near the maximum input level limit of the sensors, resistive pads were devised to reduce the signals to acceptable levels. Sensitivity (or threshold) controls are now set at about the midpoint.

No provision was made to indicate which of the four circuits was in trouble when the alarm sounds. The alarm merely indicates a problem exists on the remote circuits. There are adequate conventional means of immediately determining the quality of both audio and video signals.

Normal procedures for use of this remote sensing device are relatively simple. An audio tone is generated and fed into the audio system where it eventually goes from our equipment to telephone company circuits and reappears at Radio City. Video signals are generated and inserted into the circuit at as early a point as possible so as to give maximum protection to the equipment. These signals then go via telephone company microwave to Radio City. At master control, the signals are fed into the sensing device which is activated only when the normal operating personnel are not in attendance at the remote location.

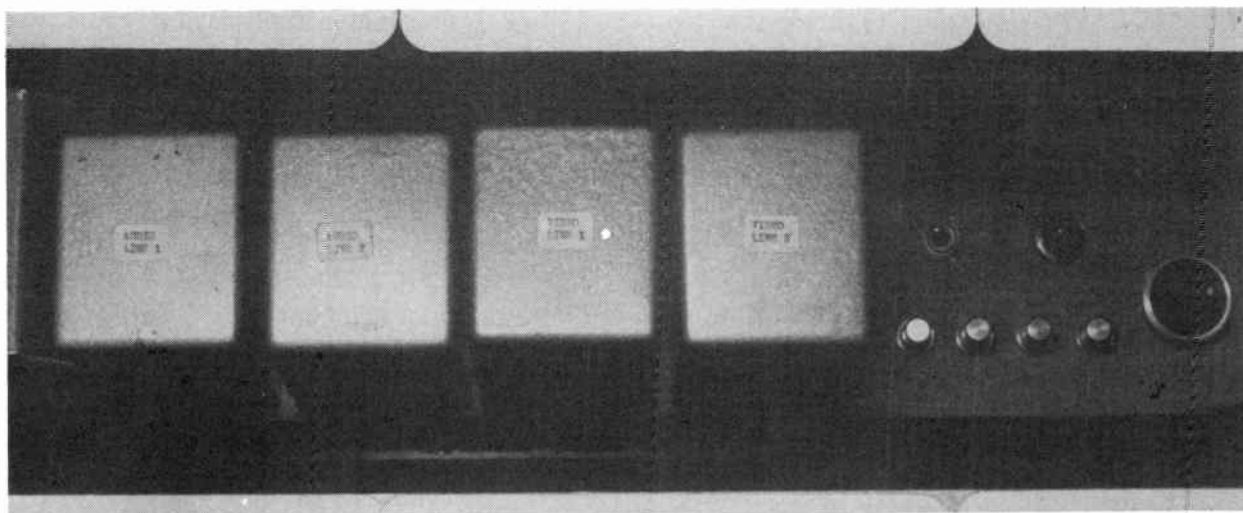

Fig. 4

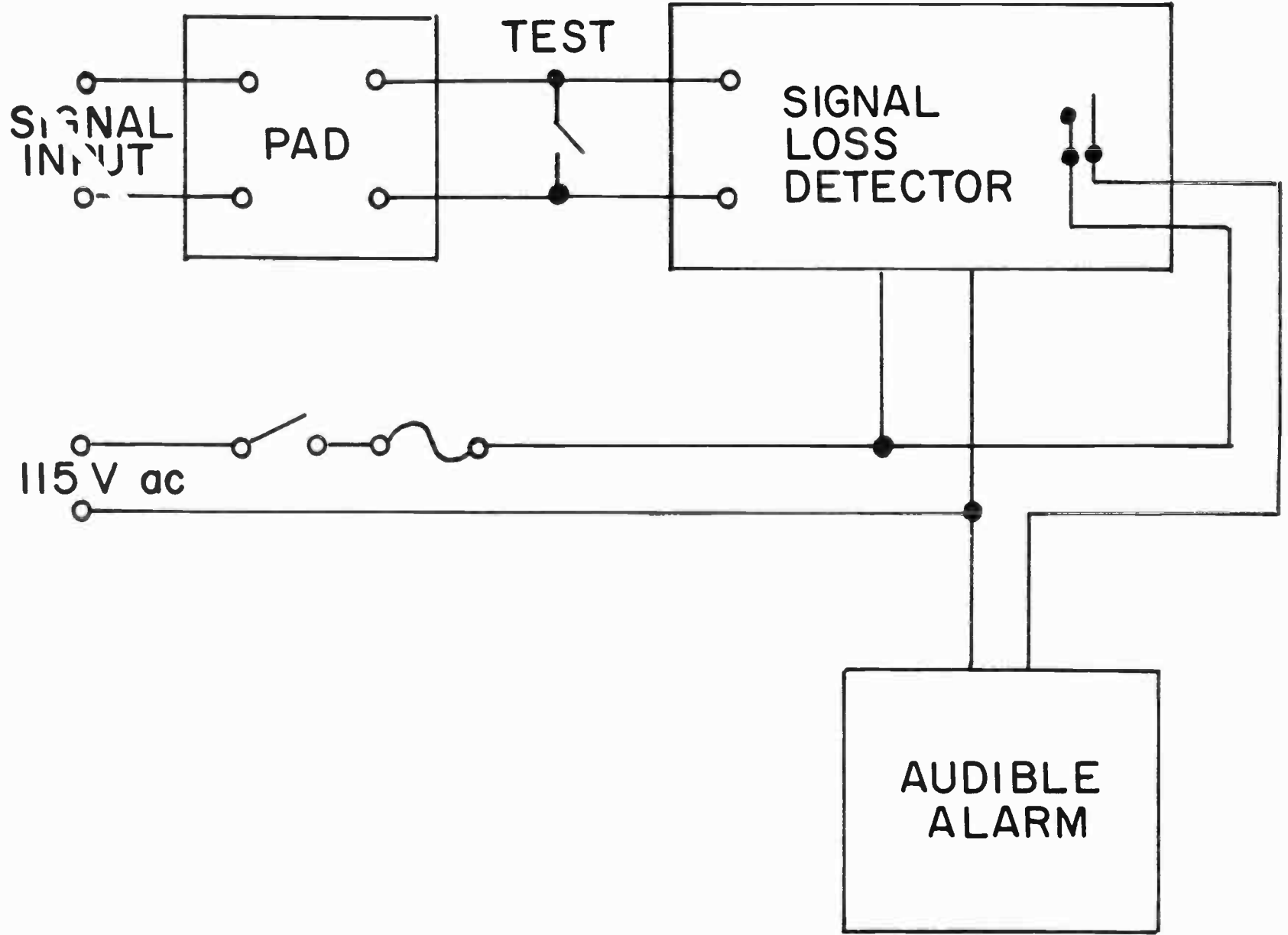

Fig. 5

At the close of business at the remote location, proper signals are transmitted on both audio and video lines and a telephone call is made to master control asking that the alarm be turned on and tested. After each circuit has been checked out, the remote crew is authorized to leave all equipment turned on and to close up for the night. In the morning when the regular crew arrives, a telephone call to master control is made and the alarm is shut off for the normal operating day.

In the event of an alarm being sounded during the unattended period of time, a written procedure of action is provided which will include an actual visit to the premises by a person or persons living nearby. Or as a last resort, someone from Radio City could always take a taxi and be there within approximately 30 minutes.

The signal loss detector, as discussed here, has more than met the original specifications and has made it possible for us to incorporate it into a system to maintain constant supervision over unattended remote equipment. This has provided economic benefits in the form of reduced time required by technical personnel to properly set up and maintain the remote equipment.

Role of the Cassette Videotape Recorder in Station Operation

C.E. Anderson

Ampex Corp., Redwood City, Calif.

High-speed duplication of video tapes is a reality, and the implications of this fact are so obvious as to hardly require comment. Couple this reality with the reality of a video-tape cassette recorder, and there exists a very powerful tool for the broadcaster. Even without embellishments, the video-tape cassette recorder offers obvious advantages. Tape damage through tape mishandling is minimized, storage and shipment of short segments is easier and cheaper, and threading is faster. Even cassettes loaded into a recorder manually one-by-one are preferred to reel-to-reel operation for short segments. However, given such a golden opportunity for embellishment, no knowledgeable person can resist adding features which, for a little extra effort, can increase dramatically the ability of the recorder to simplify station operation, allow greater operating flexibility, and to reduce operating errors.

The obvious first step is to combine two transports into a single assembly with the capability of feeding cassettes to either transport from a central store. 24 cassettes are stored in a central carousel to which each transport has access. Why 24 cassettes? Our market analysis showed 24 cassettes to be a reasonable number to allow several station breaks or programs to be accommodated without reloading, and 24 makes for a convenient carousel size.

With two transports and a means of feeding any one of 24 cassettes to either transport, continuous programming can be had. The cycle time to find a cassette, bring it to the transport, thread and cue the tape, and rewind it when through playing is under ten seconds if the system is designed properly; therefore, ten-second commercials or program segments may be programmed back-to-back.

Having made this possible, what next? The idea of an operator standing at the machine manually pushing buttons to load and unload cassettes and to start and stop the transport is not very attractive, so the next logical step is the addition of a memory which can be programmed to handle up to 40 events; in other words, a hard-wired, micro computer.

We tend to think of a computer as being a giant affair, such as an IBM 360, but we are finding many uses for smaller computers such as the Nova made by Data General. Even it, however, is too much for our basic needs here, and a few boards of hard-wired logic do nicely, and they can be easily programmed by means of a keyboard, if some liberal doses of engineering common sense are used to provide a relatively inexpensive display of what we have programmed.

I'd like now to take you with me and program a sequence on the ACR-25. At first the control panel seems distressingly complex, but a moment's study of it quickly discloses that the bulk of the controls are old friends carried over from reel-to-reel recorders, and they really have nothing to do with programming of the ACR-25. Most are, in fact, setup and maintenance controls. Let's run through them quickly just to put our curiosities at rest. Bear in mind that there are two transports involved, so there will be two sets of many controls.

The panel in the lower right is a maintenance panel normally covered by a door. On it are the setup controls associated with each transport: record levels, P. B. equalization, tip penetration (in manual mode), audio input switch, manual tracking (in manual mode), and audio setup adjustments as in the AVR-1. All very familiar!

The lower left panel is a secondary panel containing the standards switching, the editor control panel, audio and video input and output gain controls, and the chroma level, black level, burst level, and burst phase controls. As I said before, these are old friends with which we are familiar, and they pose no problems or unknowns.

So much for our old friends, but now what about the new controls? The most important are those which program the memory so that desired cassettes will be played in sequence at the proper time. These controls are associated with the programming sequence. Basic to understanding is the realization that the memory is arranged in a matrix of eight rows of five events each.

The register shows what is stored in any one of the eight rows, but normally it displays the row either in use, or if the ACR-25 is standing by, it displays the row about to be used. Any one of the other seven rows can be displayed by pushing one of the numbered buttons.

The numbers displayed in the register refer to the storage bin number in the carousel. It is exactly analogous to an Eastman Kodak carousel with which we are all familiar. The desired programs are called for by calling for the bin in which the cassettes are stored in the carousel. Unlike an ordinary slide projector, it is mandatory that we be able to call for them in a completely random fashion for the ultimate in programming flexibility.

Let's actually program several program sequences. The small display above the keyboard is a small intermediate store and register to help us keep track of things easily and to be sure we have things exactly right before loading the main memory. Working across it from left to right, the first digit is the row of the memory we are programming, the second digit is the space (1-5) in the row we are programming, and the final two digits are the cassette bin (0-24) we wish to play. To program Row 1 we clear the register and push "1" to indicate Row "1". Push "1" again to indicate the first position in the row, and then push the number (0-24) of the desired bin. In this case we've selected 17. When we are happy with what we've done so far, we push the ENTER button and No. 17 is loaded into Position 1 in Row 1 of the master memory.

If another segment is to immediately follow the previous one, the sequence just described is repeated, except the button sequence is now 2-18, the "1" indicating Row 1, remaining there until we have finished programming Row 1. The register now shows we are still in Row 1, second position in the row, and we wish to play Cassette 18. We can continue the procedure up to 40 events, and unless instructed otherwise, the ACR will happily play them all, once started. More likely we'll want to play three events and then stop and wait for a few minutes before playing another group. The ACR will play until stopped, so as we program the memory, we must also program the waits. This is easily done by punching a button most logically labeled STANDBY. When a WAIT command is encountered, the ACR-25 will wait until the PLAY button is pushed again or the unit is started by external command from either a remote PLAY button or a computer.

Absolute freedom from booby traps in programming a cassette recorder is mandatory if unacceptable restraints are not to be placed on the programming people. Aside from the obvious requirement that program segments be programmable in absolutely any sequence, last-minute changes must be easily accomplished, and this has been accommodated in two ways. If another cassette already in the carousel is to be played instead of one previously programmed into the memory, the memory can be easily changed.

The desired row is called into the display register by pushing the appropriate button and the keyboard is operated as before to program the memory. The row is entered

(in this case, 3), the sequence number (2), and the desired cassette number. The ENTER button is then pressed, and the new number replaces the old in the memory and display register.

If a new cassette is to replace an existing cassette in the carousel, the procedure is equally simple. The LOAD button is pushed and then one of six buttons on a small panel on the transport is pushed to bring four cassettes in front of the loading window. The unwanted cassette is removed and the new one inserted. Punching the LOAD RELEASE button places the ACR-25 back on line for operation.

To restate the obvious, absolute flexibility in programming the cassette recorder is mandatory; therefore, complete random access to any of the cassettes in the carousel is mandatory. This, as we have seen, is entirely possible and is available in the ACR-25. There are absolutely no programming restrictions.

Flexibility also requires that a cassette be physically removable and replaceable without worry about its positional relationship to other cassettes in the carousel. Again, because of random access, this is possible and is available in the ACR-25 as we have just seen. Using the equipment and techniques just described, it is obvious that an entire, complicated station break can be handled automatically by the ACR-25.

There is a lot of talk today about automation, but it is sometimes difficult to define exactly what automation really is. I think the ACR-25 is an excellent example of it. It is a small island of automation unto itself in which a 40-event series can be triggered by pushing one button once, or by having a computer (if the rest of the station is already automated) issue one command. If the existing computer is programmed to run an entire station and control each event "by the clock," that too is fine. The hard-wired micro computer built into the ACR-25 can be bypassed and the task of initiating each event taken over by the main computer.

If there is no main computer running the entire operation, think small and imagine what might be possible with a small Nova tied into two ACR-25s and one or two other pieces of equipment such as VRTs or telecine or a disc recorder upon which are stored slides. It's necessary to remind ourselves constantly that computers are not necessarily great monstrous things, but are small things you can tuck under an arm and that are easily tamed. You can indeed approach automation by taking small, manageable steps. The ACR-25 is an excellent first step that guarantees that the next step will be easy and will not be a false one.

Operational Experience with Video Tape Cartridges

Paul Weber
P. A. Dare
WDCA-TV, Washington, D.C.

TV station operations are influenced and often limited by the availability of various types of equipment. The introduction of the video cartridge recorder has influenced all departments concerned with TV operation—programming, traffic, production, and promotion. What I hope to do is to describe to you the far reaching affects the video cartridge recorder has had upon the entire station's staff since June of 1970. I would like to describe the operational trends that have developed as a result of this equipment being in service at WDCA in Washington, D.C. for the past six months or so.

WDCA is an independent UHF station operating in a top ten market. The number of commercials radiated in one day is approximately 280. The control room equipment at WDCA consists of three film chains, two video tape recorders, and two live studios. In late May of 1970, a prototype video cartridge recorder was installed at WDCA and the installation took approximately two weeks, which not only consisted of the installation, but also of the training of the technical personnel to operate and maintain the equipment during the period of the field test.

The selection of WDCA as a field test site was a logical choice for RCA to make, for WDCA is a medium-sized station in a large market. Traditionally, UHF-TV stations have a severe problem competing with VHF stations to gain desirable ratings. It was decided that the effect of the video cartridge machine would be best felt in a situation where operational economies are vital to station profitability. As with most UHF stations, WDCA does a high quantity of video tape material. We were having to make a spot reel to handle the evening tape load and soon would have needed additional personnel in addition to the spot reel.

At the conclusion of the installation and training session, we began the on-air use of the video cartridge machine with promotional material. As with any new format and any new piece of equipment, we were concerned with operator errors in handling the equipment, as well as with machine operation and interface with our own station equipment. We naturally wanted to find and solve these problems with non-commercial type material. Fortunately, machine problems were nil and operator problems were few. The most troublesome, oddly enough, was getting used to the fast lockup time with the video cart. Prior to the video cartridge machine, the standard reel-to-reel video tape machines had a lockup time of approximately 6 seconds. This gave us 3 to 4 seconds of good solid black before commercial content in which the operator had time to take the tape machine on the air. But now, with the video cartridge machine, you have a half- to three-quarters of a second of black prior to program material. The operators soon developed their own techniques and within a week a much smoother program switching operation evolved.

The next step was to put commercials on a cartridge. As each commercial appeared day by day on the log, we dubbed the commercial from reel-to-reel format to the cartridge format. Within a couple of days we had a library of some 200 commercials on cartridge format. We went directly from reel-to-reel format to cartridge format with no backup. The reliability of the cartridge didn't require such precautionary measures. Within a couple of weeks we had all our promos and reel-to-reel com-

mercials on cartridge format and we asked the Traffic Department to group the video tape spots within each break so that they would appear sequentially. This was to take advantage of the automatic switching of the cart machine, which has proven to be infinitely better than an operator. This led to the first trend, one of the operator grouping the commercials together within a break, even if the Traffic Department didn't.

The first department to take full advantage of the video cartridge machine was the Promotion Department. They could now place their promotions wherever they wanted to. They previously were limited by the number of video tape machines available in a break. Almost concurrently, we notified the Production Department that the video cartridge machine was in use and on the air, thus freeing our reel-to-reel time during the day for the Production Department's use. Previously, with our two reel-to-reel machines being scheduled for on-air playbacks, the Production Department could not produce any local productions. Now, we are able to do multi-tape productions, even during prime time with no problems.

Historically, if we could now turn the clock back six months, a number of clear patterns emerge that reflect the influence that the video cartridge machine has had upon our station's operation. In order to understand these changes in operator and maintenance attitudes, one must understand some of the operational parameters of the video cartridge machine we are field testing. The machine has a storage capability of 22 cartridges. These are loaded in numeric order, 1 through 22. One of the trends that evolved was that the day operators never loaded the machine to anywhere near its full extent and, in fact, the operator only loaded approximately one-half hour's worth of video cartridge commercials, whereas the night operator fully loaded the magazine to its capability. These operational trends were in no way dictated by the station in any way. It purely evolved through the use of the cart machine. For example, during the day, numerous changes have had to be accommodated quickly, whereas on the night shift, when almost everyone has gone home, changes to the log are minimal. In fact, we have a status quo condition dictated by the earlier prepared schedule.

Another trend that evolved was the daily maintenance routine, using the test cartridge supplied by the manufacturer. This maintaining routine has become part of the daily operational procedure and is the key to the success of the machine, eliminating many of the quadruplex errors that people have previously been accustomed to. Adjustments such as burst phase, control track phase, audio and video levels, centering the channel equalizer ranges, adjusting the chroma ratio, are all keyed to the test cartridge. Although the manufacturer had recommended approximately ten minutes as the time necessary to carry out the setup procedure, we have found that 15 to 20 minutes has been more desirable. (10 to 15 minutes of that 20 minutes is to carry out the adjustments recommended; the other 5 minutes being purely converted to physical inspection of the machine for any obvious discrepancies. In our opinion, this 5 minutes is an insurance policy against anything happening during the day that could have been avoided through just a few extra precautionary minutes of inspection.)

A further operational trend that is developing rather rapidly is one of transferring films to cartridges. A recent example could be quoted directly from an experience we have just had. A client asked if we obtained 600 plays out of one film print. As you all know, this is almost an impossibility. A number of alternatives were open to us. Ask the client for more prints. In our opinion, however, the logical step was to transfer that film to cartridge format. From an operational standpoint, dubbing it once to cartridge format is by far the easier than threading up that commercial 600 times. I might add that it is our experience also that the quality on video cartridge

playbacks is likely to be more consistent over a long play period than any type of film projection recently in use. This type of a trend of dubbing films to tape could even be taken to an extreme where agencies supply only one print of the film and expect the station to transfer it to the video cartridge format for ease of handling.

Another trend that we have noticed developing, although not as a direct influence on the video cartridge system, but nonetheless the situation being made easier by the existence of a cartridge machine, is the fact that some video tape commercials (in particular 30-second spots) that are used in piggyback combination are now being supplied as individual recordings on one spot reel. The station is expected to rearrange the 30-second spots in accordance with agency schedules. For example, four 30-second commercials may arrive on one spot reel that have to be rearranged in 4-1, 1-2, 3-2, 3-4, 4-2 combinations. By simply transferring these 30-second spots to individual cartridges, the operators can easily, with no increase in expense to the station, provide the agency with the piggyback combination it requires at will. Although I'm not primarily reporting on the effect the video cartridge might have on commercial distribution, it does appear during the recent Christmas advertising that agencies (in particular those associated with toys) were distributing piggyback commercials arranged in different orders that were constantly rearranged during the Christmas advertising period. A more logical way would have been for the agency to supply us with the 30-second spots in individual reels and let us transfer them to the video cartridge format and then rearrange the spots at will. This type of explanation sounds rather repetitive, but it should be considered as being a significant fact that TV station operators have to face in the very near future.

Recently, as most of you will well appreciate, the 30-second spot has become a national standard. Just one year ago, 64% of all the commercials aired were 60 seconds (in the national spots), 27% were 30 seconds. At the end of 1970, 50% of the spots aired were 60 seconds, with 47% of the spots aired being 30 seconds. The trend is obviously toward 30-second spots. To the station operator, this means an increased number of handling operations. Previously, to air a 60-second commercial, he perhaps had one threading operation. Now with the increase of 30-second spots, he has two threading operations (my real point being that more human intervention is required to air the same amount of commercial time. As far as WDCA is concerned, all I can say is that if we had to handle an increase of video tape commercial spots or film commercial spots with the existing equipment, we could not do it. With the video cartridge machine it is a very simple matter for us to handle these commercials with no increase in manpower or programming complexity. We leave the programming up to the machine switching system and we rely upon the operator to insert more cartridges into the magazine.

This almost sounds as if I'm here selling video cartridge machines for the manufacturers, but I'm simply pointing out some rather obvious observations that we have made after using the cartridge machine for six months and looking somewhat into the future when increased commercial handling will be a reality.

Earlier, I touched somewhat on some of the errors common to quadruplex recorders. At this point, I'd like to report upon some other experiences that we have had while field testing the video cartridge machine. We have had total interchange of all types of quadruplex recordings with any number of types of headwheels. We have proven that recordings and replays can be made with the consistency that can only really be believed through viewing the results that we have been able to achieve. To date, we've never had to touch the control track phase knob. This almost sounds like an exaggeration when compared to the number of times that you have to touch it on a reel-to-reel machine.

Setup of the servo, even through the change of headwheels and six months of on-air operation, we have yet to change the original servo control settings. To us, as users of the video cartridge machine, it's rather obvious that manufacturers have overcome any instability in electronic circuitry design and are now capable of building servo systems that do not require adjustment over very long periods of time, plus headwheels and FM systems that are totally interchangeable with one another and provide high quality performance over very long periods of time. One could also take a look at the logic system in the tape machine. It consists of approximately 1,000 integrated circuits, of which I can honestly say we have only had trouble with one (a poor contact with the plug-in socket of one of the integrated circuits). The manufacturer advises that he is not using these sockets in his production model of the machine.

Today at WDCA the video cartridge machine is considered as almost something that has been with us since television itself started. The transfer of reel-to-reel to cartridge format, the transfer of film to cartridge format, operators relying upon the cartridges switching are all taken as matter of fact. During the day, the Traffic Department comes in with new commercials we have received for that day. They're put on top of the cartridge machine in their reel-to-reel form. The next morning, after the equipment is warmed up and setup has been performed, the first job is to dub these onto cartridge format. There are usually three to four new items to be put on cartridge. The total time taken for this operation is the length of the material plus approximately a minute or two for reel-to-reel machine setup. We take considerable care in order to maintain the proper burst phase, saturation, etc. I might add, in transferring from film to cartridge, that this includes "painting" the commercials that have been sent to us incorrectly color balanced. We use the flesh-tone as the reference on film and color bars as the reference on video tape. We consider the extra time in painting or setting up the reel-to-reel machine in the dubbing process is well spent, as this insures a perfect playback of the cartridge each time. This exact time match, coupled with the precise cartridge switching, has gone a-long toward the improvement of our station's air quality. It has been a remarkable improvement, noticeable to the average viewer as well as to our competition.

The reliability has been well beyond our expectation. The overall presentation when replaying one cartridge to another has been a great improvement over manual activation of several reel-to-reel machines, the video switches from one deck to another are not apparent at all to a home viewer, except for the change in program content. The cost of operation is much less than that of a reel-to-reel machine, and tape life is in the order of 300 passes per cartridge and I believe that this is really not a limitation but simply we have not been able to put more passes on some of the two to three cartridges that we have in our library. We feel certain that when manufacturers begin to deliver, on a quantity basis, video cartridge machines, our experiences will be shared by many others in changing the general operational conditions that exist in television stations throughout the world today.

The First 220 KW UHF Television Transmitter

Howard G. McClure
Gates Radio Company, Quincy, Ill.

On March 16, 1971, WDCA-TV in Washington, D.C. began operating with the world's highest powered television transmitter, the BT-220U, developed by Gates Radio Company, a Division of Harris-Intertype Corporation. The 220-KW transmitter was installed by WDCA-TV to enable them to compete with their VHF competitors. WDCA-TV operates on Channel 20 and is an independent station with four VHF and two UHF competitors.

With the use of the higher powered TV transmitters which have been available, it has become generally accepted that a UHF station can compete commercially with its VHF counterparts. However, a much higher signal level is required in the primary coverage area. This may be accomplished by using a relatively low gain antenna with a shaped vertical pattern and a high power transmitter. With a 220-KW transmitter, a 5 megawatt ERP omnidirectional signal can be realized with an antenna gain of only 28 (14.47 db). (See Fig. 1.) This means that the city grade 80 dbu signal level will extend to the horizon and will not be subject to variation of signal strength due to the beam width and deflective characteristics of a large, high-gain antenna.

WDCA has an ERP of 4 megawatts and antenna height of 770 feet. Four megawatts was chosen because of the existing tower height and the FAA height restriction which limited them to an antenna gain of 22. Even with this limitation, the city grade signal of 80 dbu extends 37 miles and the horizon from the antenna height is 39 miles. The District of Columbia is covered with a signal strength of at least 110 dbu.

The basic building block of this new transmitter is the BT-55U (see Fig. 2), the first three cabinets on the left. The 55-KW transmitter is a modular design which lends itself to expansion. By adding two more cabinets, it becomes a 110-KW transmitter, and four more produces the full 220-KW output. All the cabinets used are standard BT-55U cabinets, except the 220-KW control cabinet.

There were many interesting design problems brought about by the new concepts and high power requirements of this transmitter. The first was how do you combine and handle such high power and still provide a high degree of reliability. Waveguide was the obvious answer to the high power RF problem as shown in Fig. 3, since even 9 3/16-inch coax is only rated by EIA RS-225 and RS-259, at 120 KW average power on Channel 14 and is not useful above Channel 34 due to moding. A 132-KW average power handling capability is required for the visual portion of the 220-KW transmitter, with an additional 22 KW after the aural is diplexed. WR-1800 waveguide is rated in excess of 400 megawatts at Channel 14 with a much lower insertion loss and is useful to Channel 43. WR-1500 could be used for channels above 43 and is also rated at greater than 300 megawatts.

One additional advantage is due to the large surface area and low loss of waveguide. There are fewer temperature problems and no need to pressurize frequency sensitivity components such as the diplexer and color notch cavities. The 3.58-MHz color notch cavities were placed in the diplexer to insure a matched load for the transmitter over a wide bandwidth while increasing the power handling capability of the color notch cavities. With the color notch in the diplexer, any power at 3.58-MHz will be reflected to the reject load.

HARRIS
INTERTYPE
CORPORATION

GATES

5 MEGAWATT E. R. P.

$\frac{220 \text{ kW}}{23.42 \text{ dB}}$

—

$\frac{81.2\%}{0.9 \text{ dB}}$

+

$\frac{28}{14.47 \text{ dB}}$

=

$\frac{5,000}{36.99 \text{ dB}}$

Fig. 1

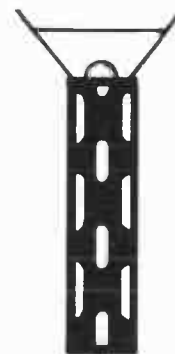
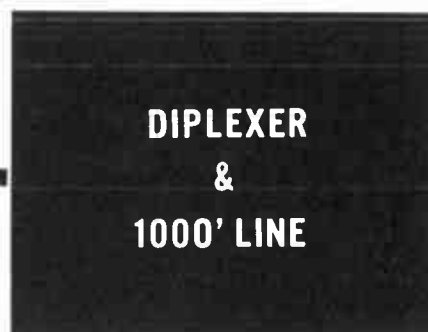

HARRIS
Communications

Fig. 2

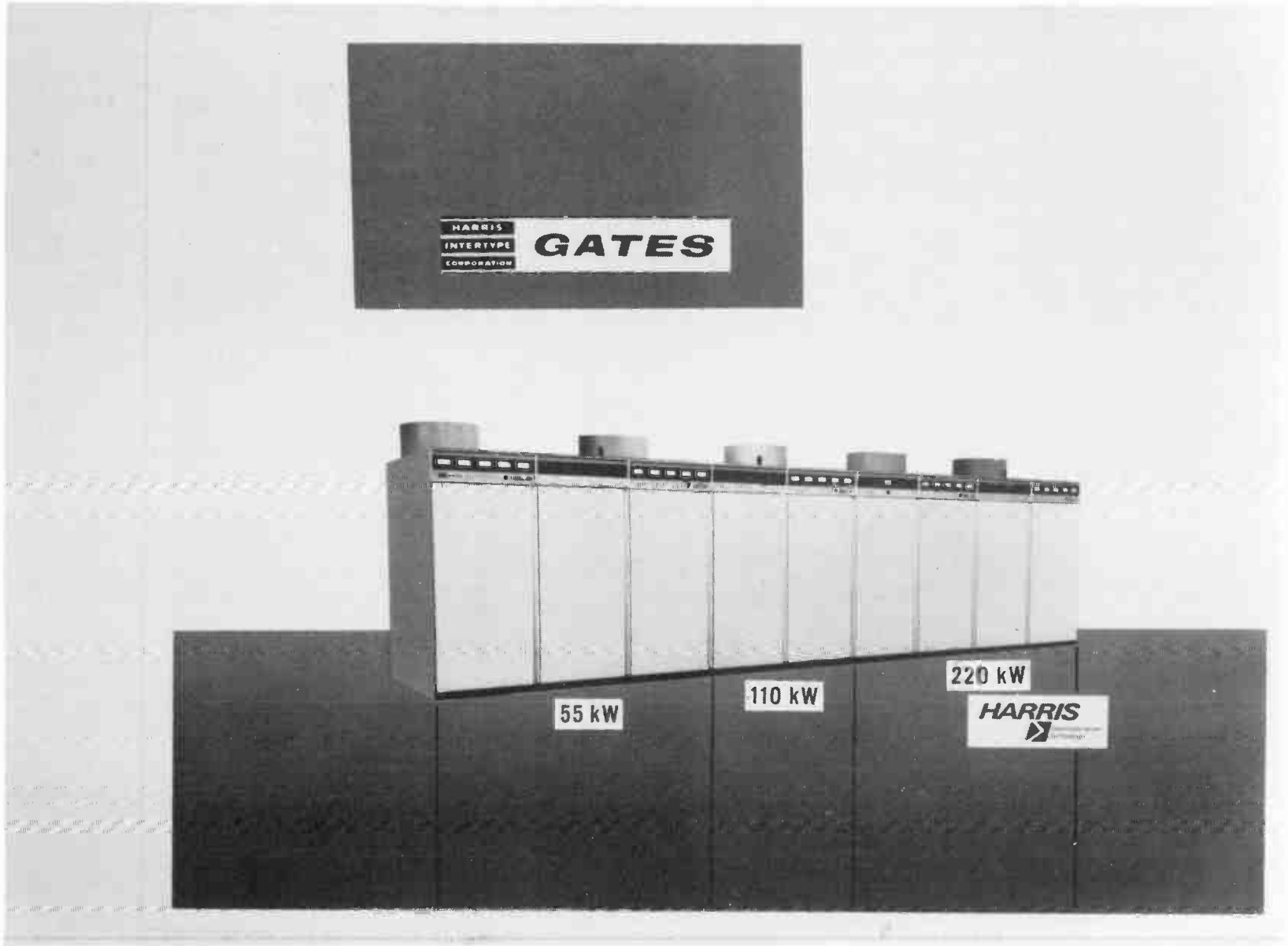

FREQUENCY (MH₂)

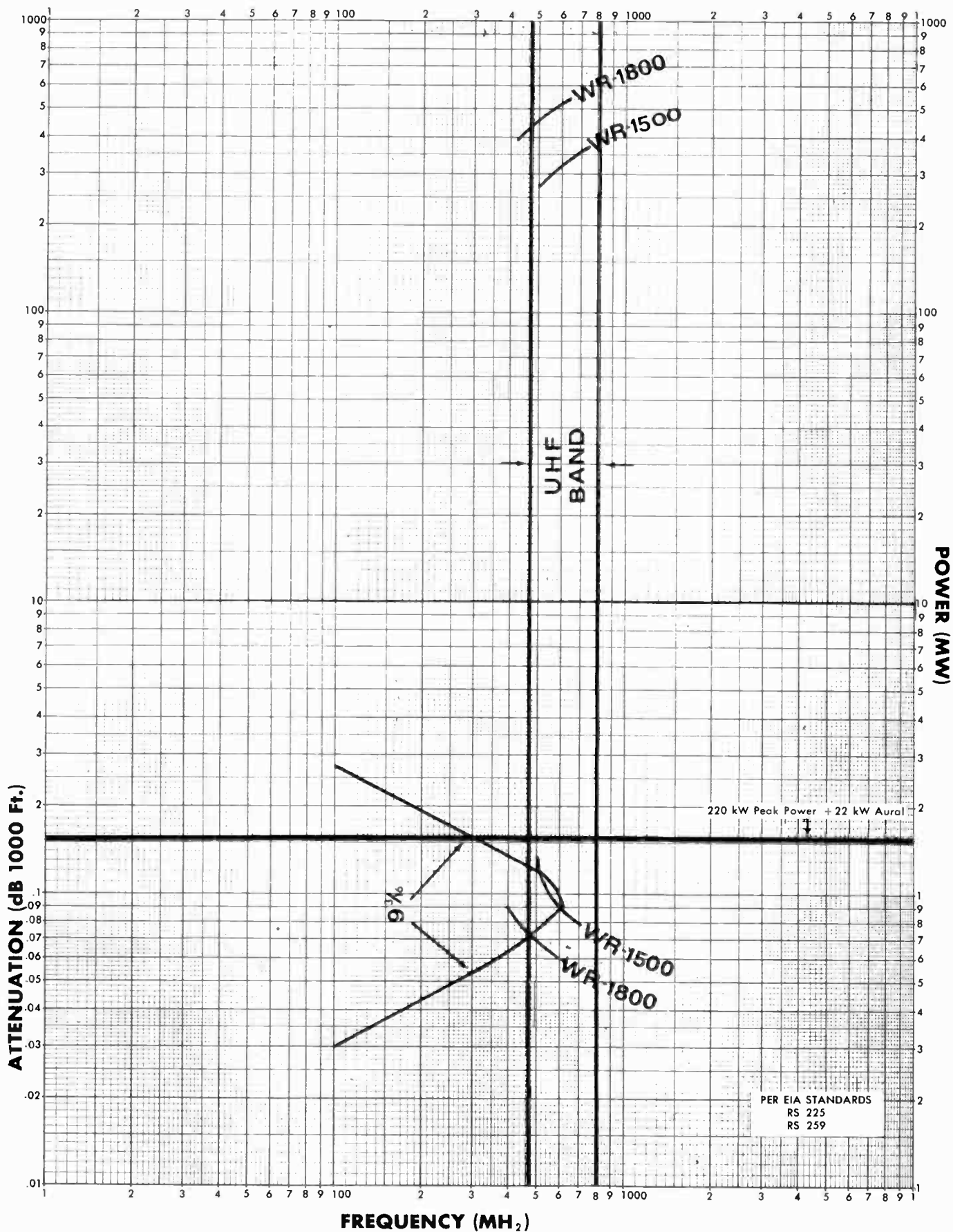

Fig. 3

BLOCK DIAGRAM BT-220U

HARRIS
INTERTYPE
CORPORATION

GATES

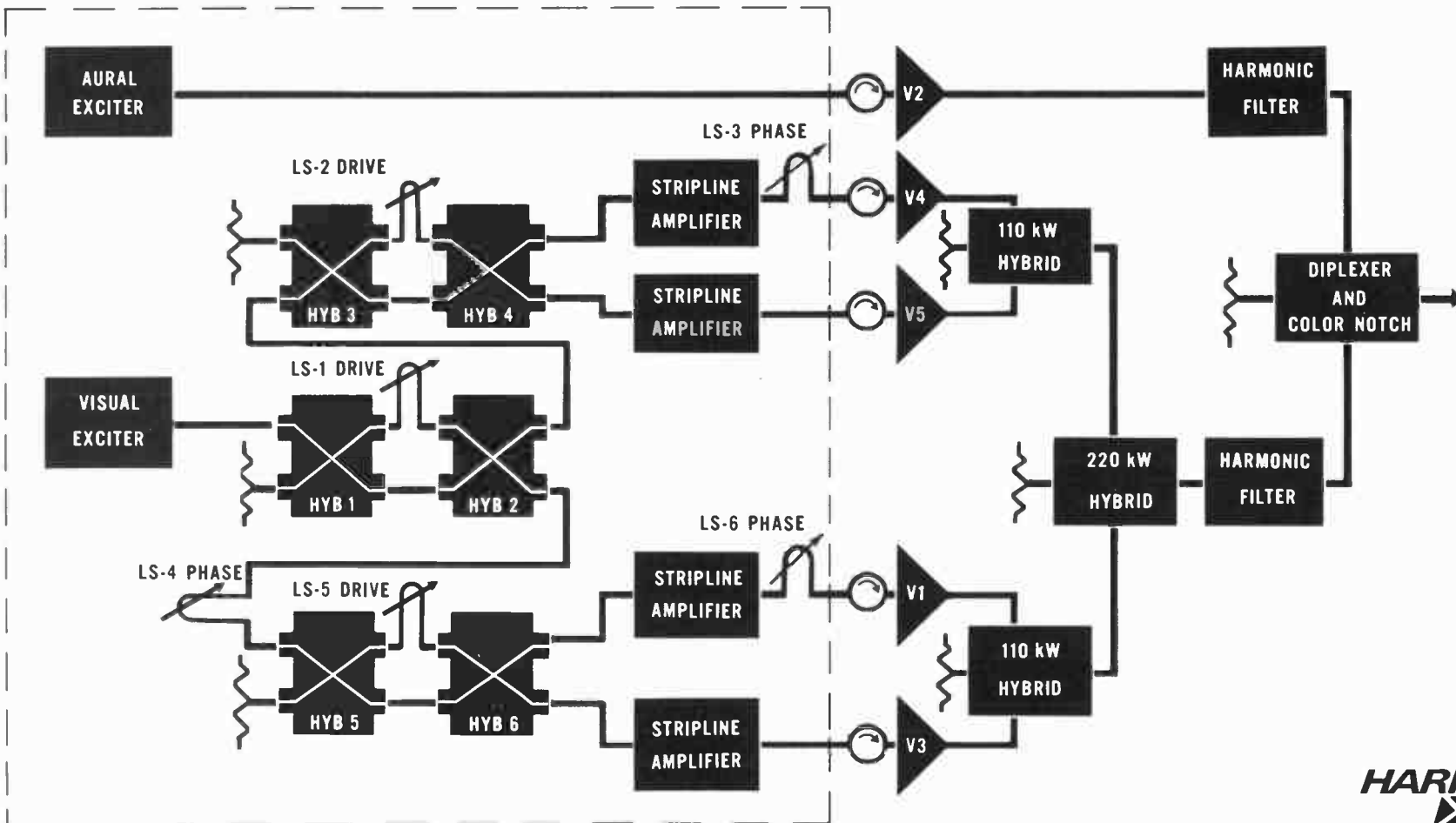

Fig. 4



HARRIS
Communication
Technology

In order to combine the outputs of the four visual klystrons, variable control of the drive signal to each klystron is necessary with regard to relative gain and phase. With this in mind, it was decided to combine the klystrons in pairs and sets of pairs. This approach requires only six controls to control the total combining operation. Other approaches require as many as 16 controls to accomplish the same objective.

The block diagram in Fig. 4 shows the system concept and signal flow. A standard UHF visual exciter is used to drive a pair of hybrids (HY-1, HY-2) with a line stretcher (LS-1) placed in one leg between them. LS-1 is used to adjust the ratio of power output delivered to the output ports of HY-2. This approach produces a lossless attenuator.

Output number one of HY-2 is connected directly to another pair of hybrids (HY-3, HY-4) with a line stretcher (LS-2) between them to provide gain balance for klystrons V4 and V5.

Output number two of HY-2 is connected to another line stretcher (LS-4) which is used to adjust the phase balance between the first and second pair of klystron amplifiers. LS-4 is connected to yet another pair of hybrids (HY-5, HY-6) with line stretcher LS-5 connected between them.

There are four solid-state stripline amplifiers, one connected to each output of HY-4 and HY-6. The stripline amplifiers are used to boost the power level to better than one watt which is the maximum drive power required by the VA 953 series 5-cavity klystron used in this transmitter. Line stretcher LS-3 is provided to adjust the phase balance of klystrons V4 and V5. The output of the first pair of klystrons (V4, V5) is combined in a waveguide hybrid combiner to produce 110 KW. LS-6 provides for phase balance of the second pair of klystrons. V1 and V3 are combined in a second 110-KW hybrid; then both 110-KW outputs are combined in a 220-KW hybrid. The 220-KW output is connected through a waveguide harmonic filter to a waveguide notch diplexer and color notch filter.

The combining procedure is to turn on amplifiers #4 and #5 and adjust line stretchers #2 and #3 for minimum reject power in the first 110-KW combiner. Turn amplifiers #4 and #5 off and #1 and #3 on. Adjust LS-5 and LS-6 for minimum reject power out of the second 110-KW combiner. Now turn on amplifiers #4 and #5 again and adjust LS-1 and LS-4 for minimum reject power from the 220-KW combiner. The system is now balanced and adjustments can be made while the full system is in operation without fear of damaging anything. The reject loads on the combiners are capable of handling 55-KW peak power for a short duration.

A standard aural exciter is used to drive a fifth klystron amplifier, which is identical to the visual klystrons and will deliver 22 KW of aural power. A coaxial harmonic filter is used in the aural line to the notch diplexer.

Four identical power supplies are used, each capable of powering one visual klystron and one aural klystron. These are the same power supplies that are used on the basic 55-KW transmitter. Four identical self-contained heat exchangers are used and they are also a basic part of the 55-KW transmitter.

The design features of the BT-220U are:

IF Modulation, for superior color performance.

All solid-state circuitry (including control logic).

Vapor-cooled, integral 5-cavity klystron.

Unattended operation (remote control).

BLOCK DIAGRAM UHF VISUAL EXCITER

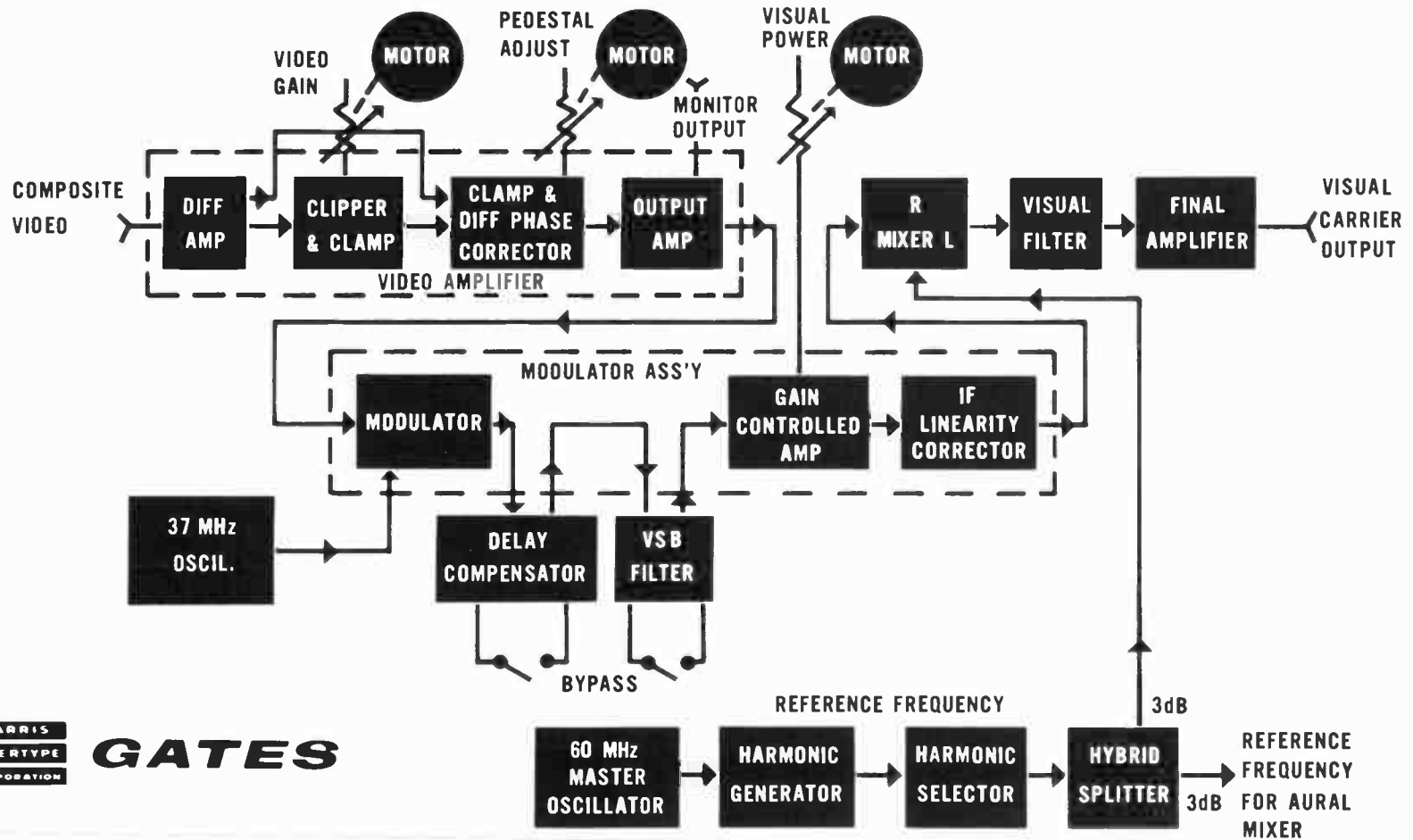

Fig. 5

HARRIS
INTERTYPE
CORPORATION

GATES

Self-contained heat exchangers.

Unitized power supplies.

Modular construction for ease of installation and flexibility.

The Gates IF Modulation Technique employed is shown in the block diagram of the visual exciter (Fig. 5). Video enters the video amplifier assembly through a loop-through input to a differential amplifier. This amplifier provides a differential input capability for common-mode rejection if desired. Input level protection is also provided. The video signal is then gain controlled, clamped twice, differential phase adjusted and distributed to a monitor output and the modulator input. The video amplifier is a unity gain amplifier—one volt in, one volt out. Both the video gain and the pedestal controls are motor driven to provide for remote control.

The modulator assembly contains the modulator, gain-controlled amplifier and the IF linearity corrector. The ring modulator accepts the proportionately temperature controlled, 37-MHz oscillator output and the video from the processor to produce a modulated double sideband IF carrier. The IF carrier is then processed in the active IF delay compensator which provides for delay throughout the IF bandpass. This is the best way to correct for both high- and low-frequency delay characteristics, since correction can be applied to both the upper and lower sidebands independently, which cannot be done with the traditional video system.

The IF signal then passes through the vestigial sideband filter where the bandpass is shaped to comply with the FCC requirements. The VSB filter not only shapes the lower sideband, but also shapes the upper sideband to eliminate the need for an equalized lowpass filter. Both the delay compensator and the VSB filter may be switched in or out of the circuit without affecting the signal level. An integrated circuit gain controlled amplifier provides for IF signal level control which ultimately becomes the visual power control.

The IF linearity corrector is another Gates innovation. By stretching the IF envelope after the VSB filter as shown in Fig. 6B, intermodulation products will be generated as in any nonlinear amplifier. These intermodulation products tend to re-create the lower sideband, as all station operators who use klystrons know. By purposely creating these intermod products while stretching the black and sync portion of the IF signal, a cancellation of the klystron intermod products will occur, restoring the sidebands to their original attenuation while providing the required differential gain control.

This simplified schematic in Fig. 6A illustrates the linearity corrector principle used. With CR1 and CR2 biased off, the signal is attenuated by the divider network of R1 and RL. As the signal level increases, CR1 and CR2 will turn on and effectively place R2 in parallel with R1, thereby increasing the signal across RL. The threshold where linearity correction begins is adjustable by the DC bias on CR1 and CR2. The slope of stretch is inversely proportional to R2. Thus, by providing three stages of control, a near perfect correction of the klystron and entire system can be achieved.

The master oscillator is housed in a proportional oven for maximum stability. A vernier control on the front panel allows precise frequency adjustment of both aural and visual carriers simultaneously due to the IF modulation principle. The signal from the master oscillator, approximately 60 MHz, is amplified to .5 W and fed to the harmonic generator.

The commonly used frequency multipliers and varactor multipliers have been replaced by a harmonic generator using a step recovery diode (SRD). A SRD is a two-



SIMPLIFIED SCHEMATIC OF IF LINEARITY CORRECTOR

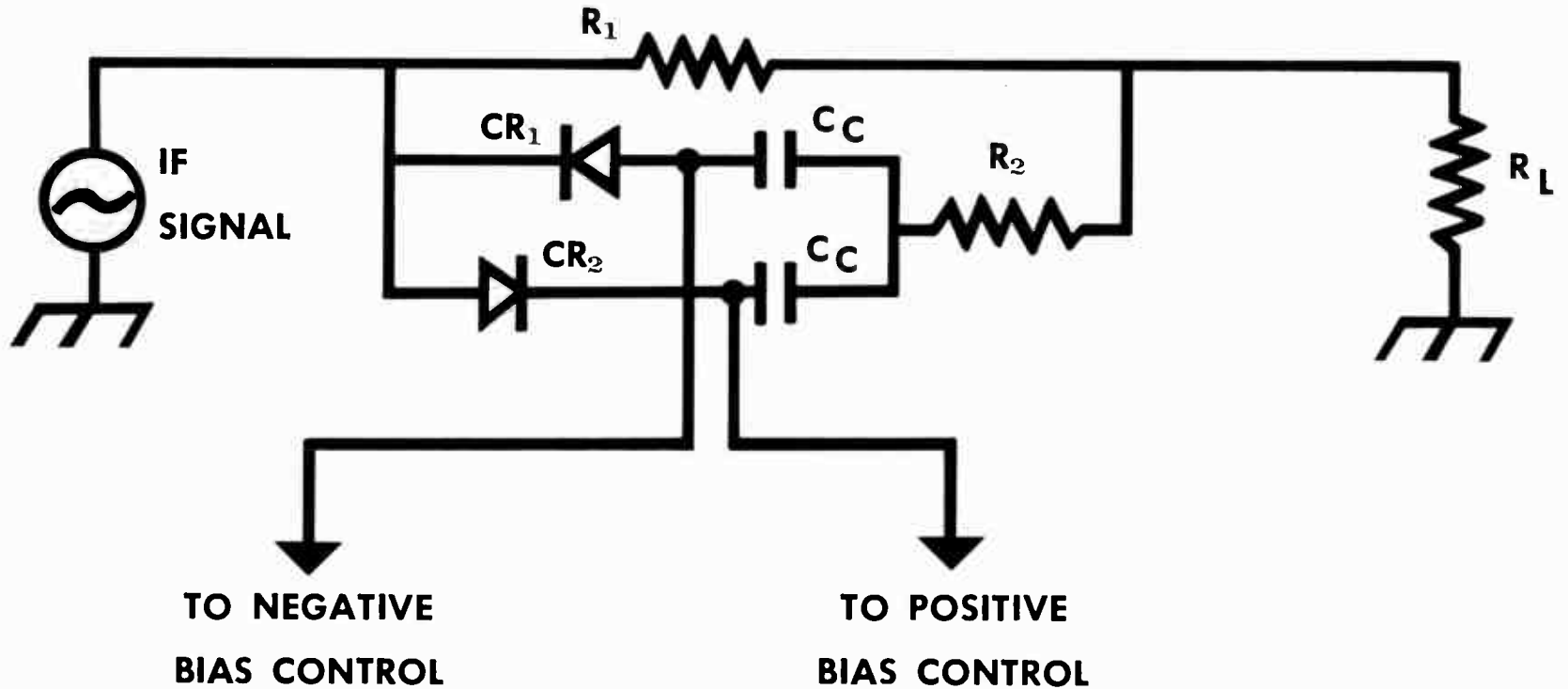

Fig. 6A.



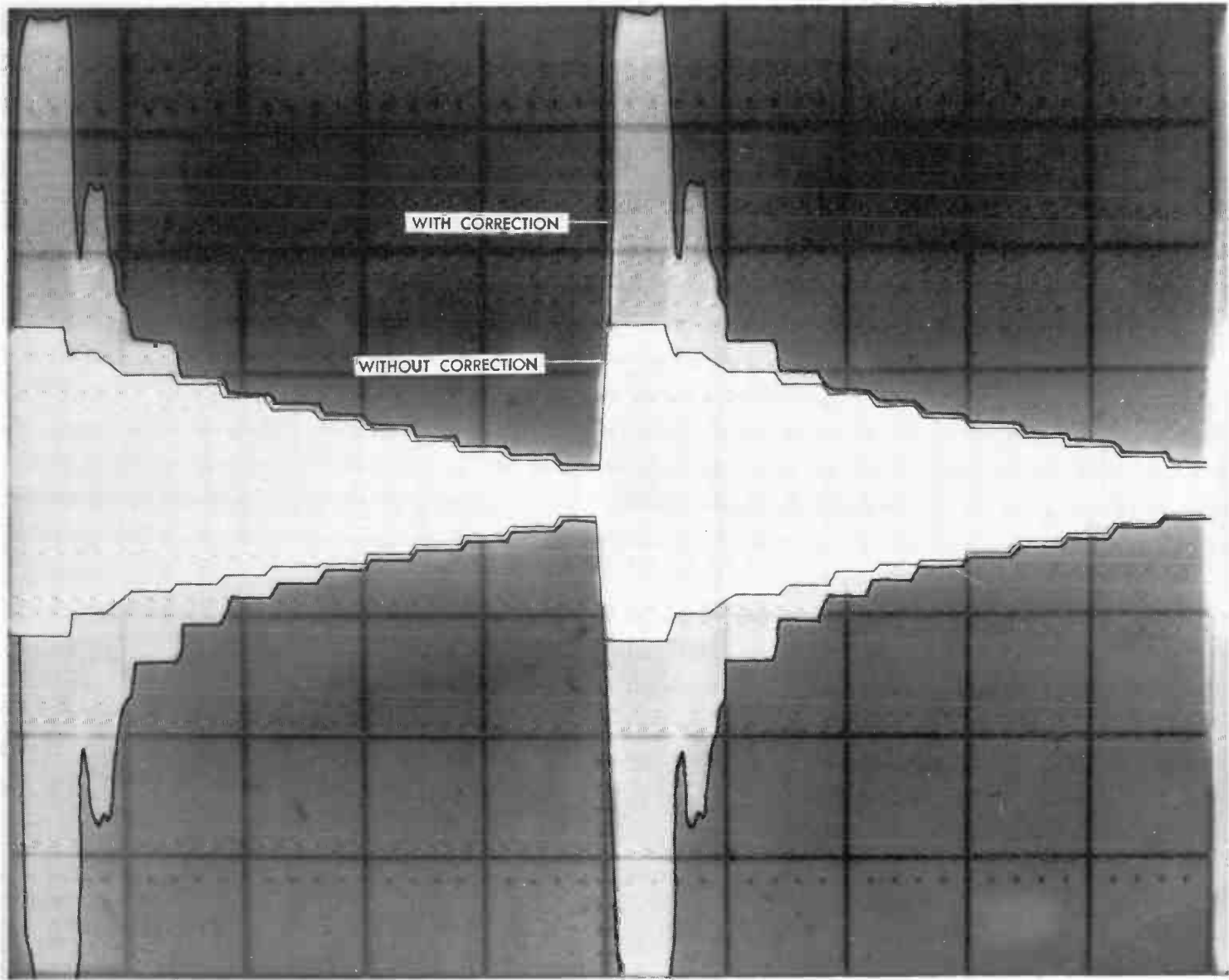

Fig. 6B.

SIMPLIFIED SCHEMATIC OF HARMONIC GENERATOR

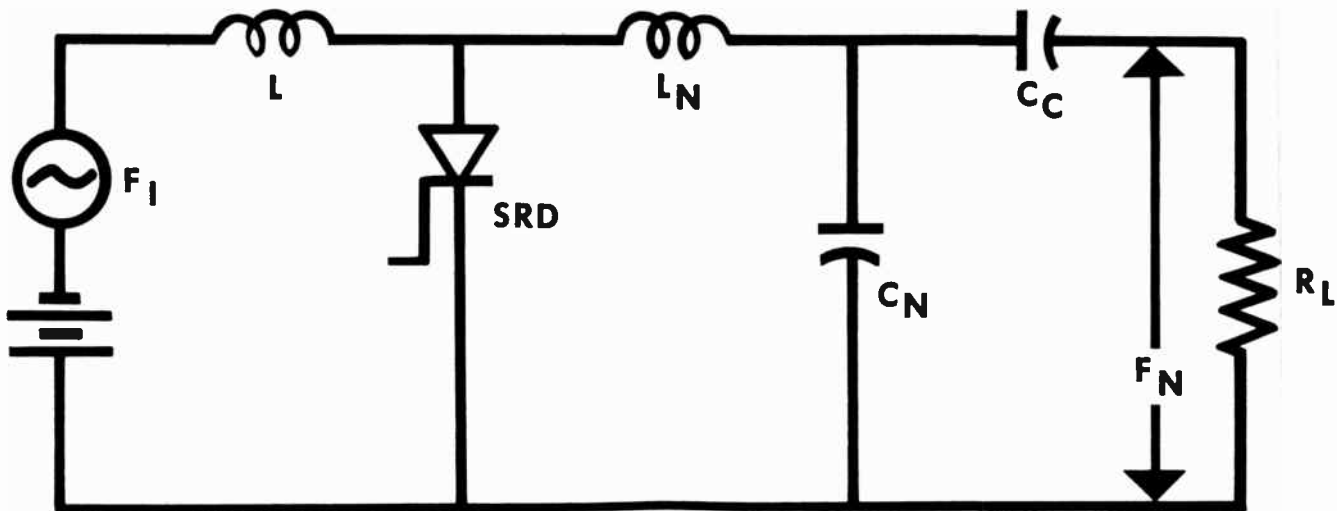

Fig. 7

HARRIS
 Continuous State
 Technology

state device. Its equivalent circuit in the on and off states are both capacitors but of different values. With the aid of L in Fig. 7, a high amplitude, narrow pulse is formed once each input cycle as the SRD snaps to the off state. This very fast pulse has Fourier components to several GHz. The output network L_N , C_N and R_L is a low Q resonant circuit covering the UHF band. The voltage impressed on R_L is the sum of harmonic products between 400 and 1000 MHz of nearly constant amplitude.

This method yields a very stable and predictable performance. No field tuning is required since there are no narrow tuned circuits as in the traditional multiplier schemes. A bandpass filter is used to select the desired harmonic, 9th through the 14th, of the oscillator frequency. The stability requirements of this filter are very loose, since adjacent harmonics are removed by approximately 60 MHz.

Following the harmonic filter, the reference frequency is split and used for both aural and visual up converters. Up conversion to the final frequency is accomplished with a double balanced mixer. A bandpass filter is used following the mixer to remove unwanted mixing products and is chosen for the desired channel but has a bandwidth of about 15 MHz.

The stripline amplifier provides 50 db gain and broad bandwidth to bring the power level to 1.5 watts. Microstrip technology is employed to control the stray capacitance and inductance. The result is a very broad bandwidth, typically 70-80 MHz at the -1.0 db points.

Tuning is accomplished by sliding an AC short along a microstrip inductor. At the desired tuning point, a chip capacitor is soldered into place. No further adjustment is needed in the field after once being tuned in the factory.

The aural exciter (Fig. 8) is equally simple. The balanced audio signal is amplified and pre-emphasized in the audio processor, then impressed across a varicap in the oscillator circuit. The modulated oscillator at 32.5 MHz is sampled, divided down to 15 kHz and compared in a phase detector to a reference oscillator which has also

AURAL EXCITER

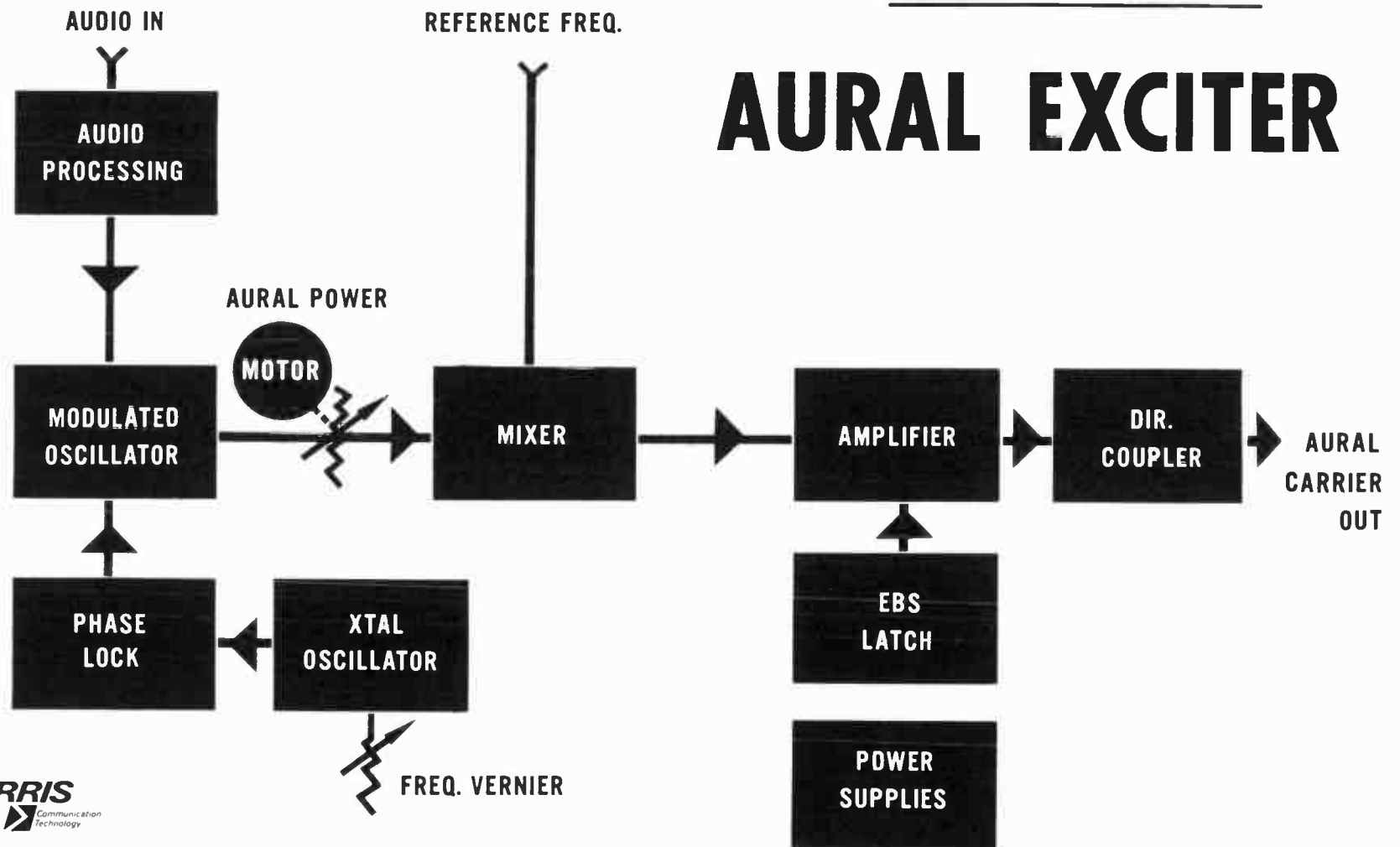

Fig. 8

DIODE OUTPUT - dB

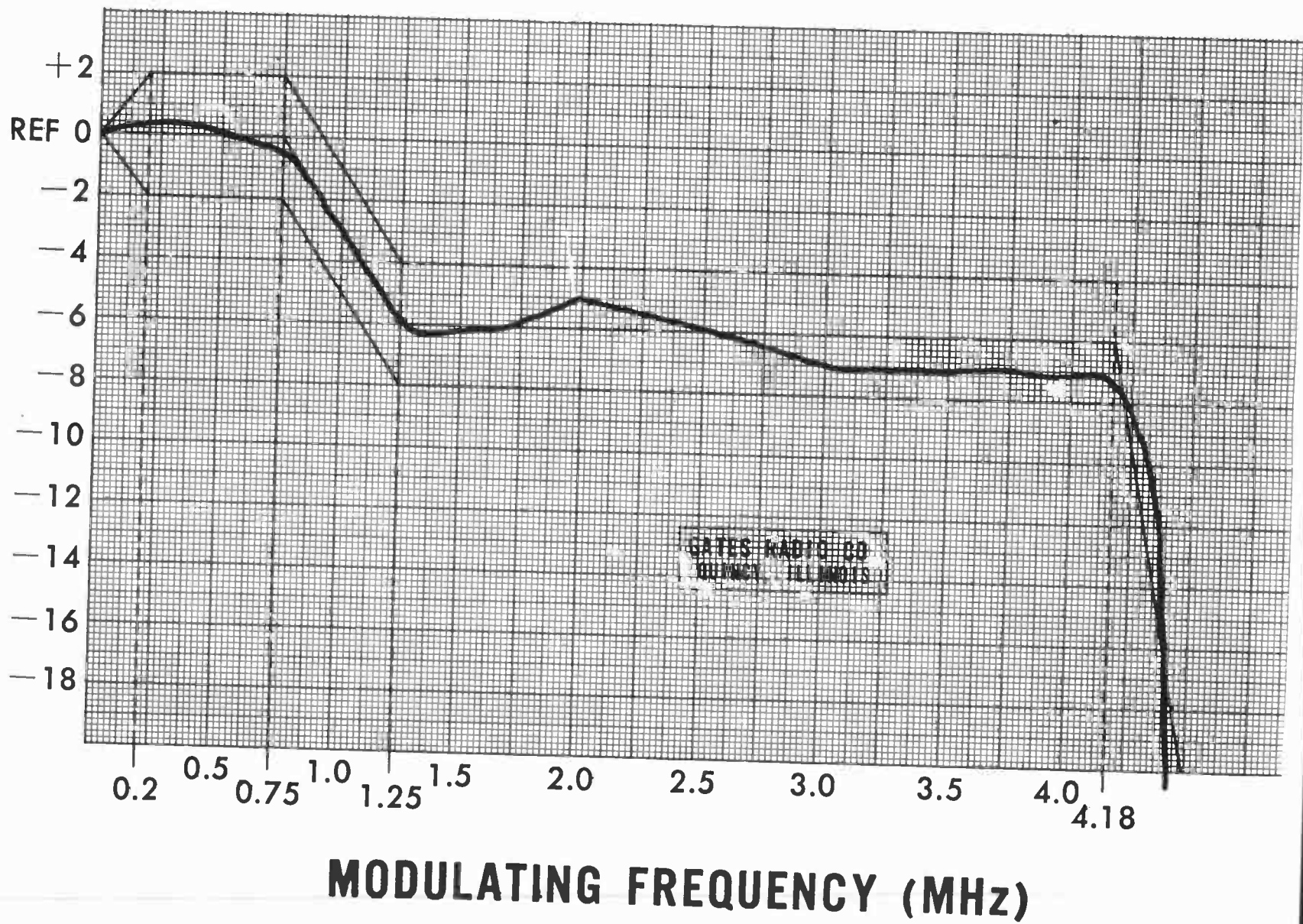

Fig. 9A.

MODULATING FREQUENCY (MHz)

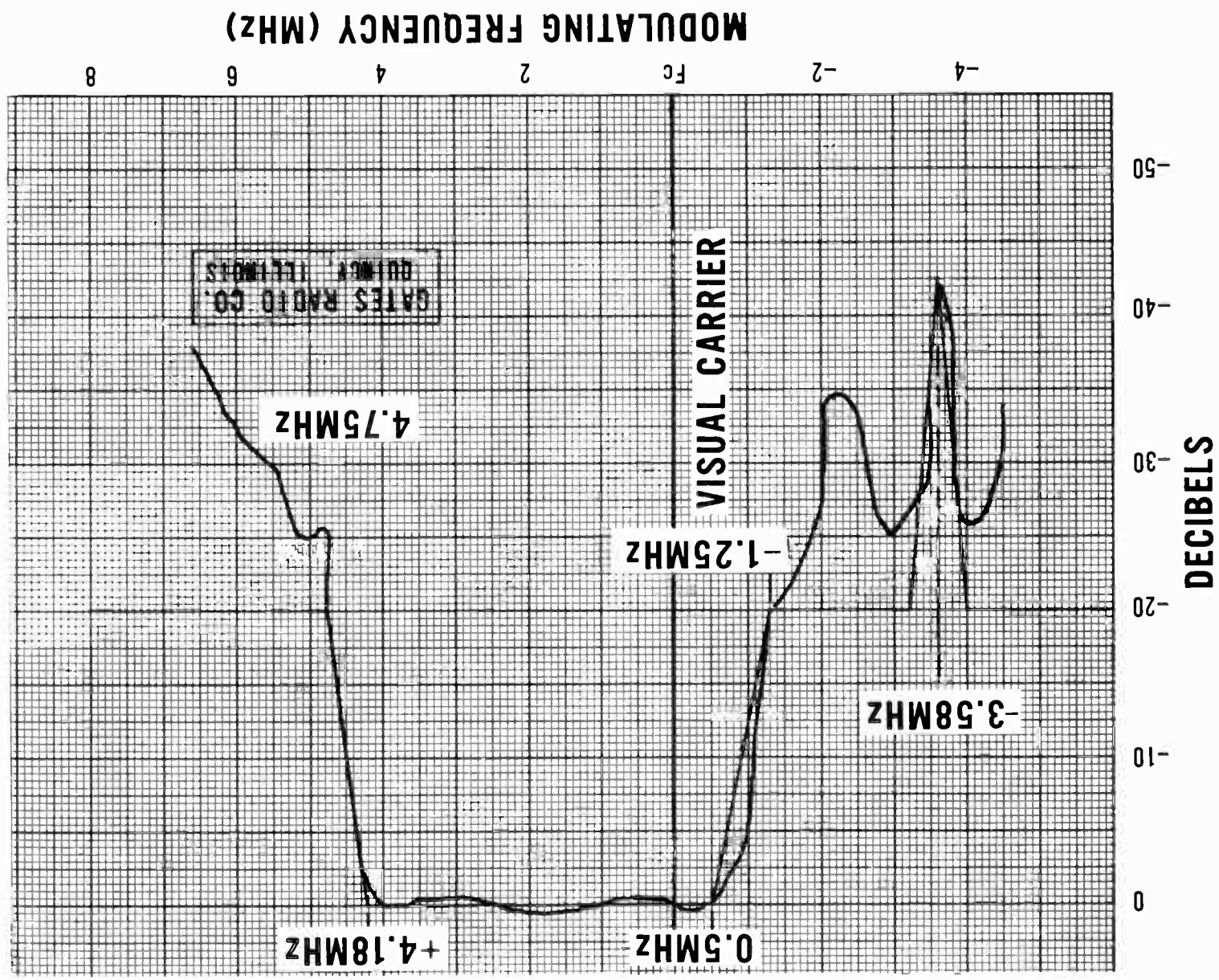

Fig. 9B.

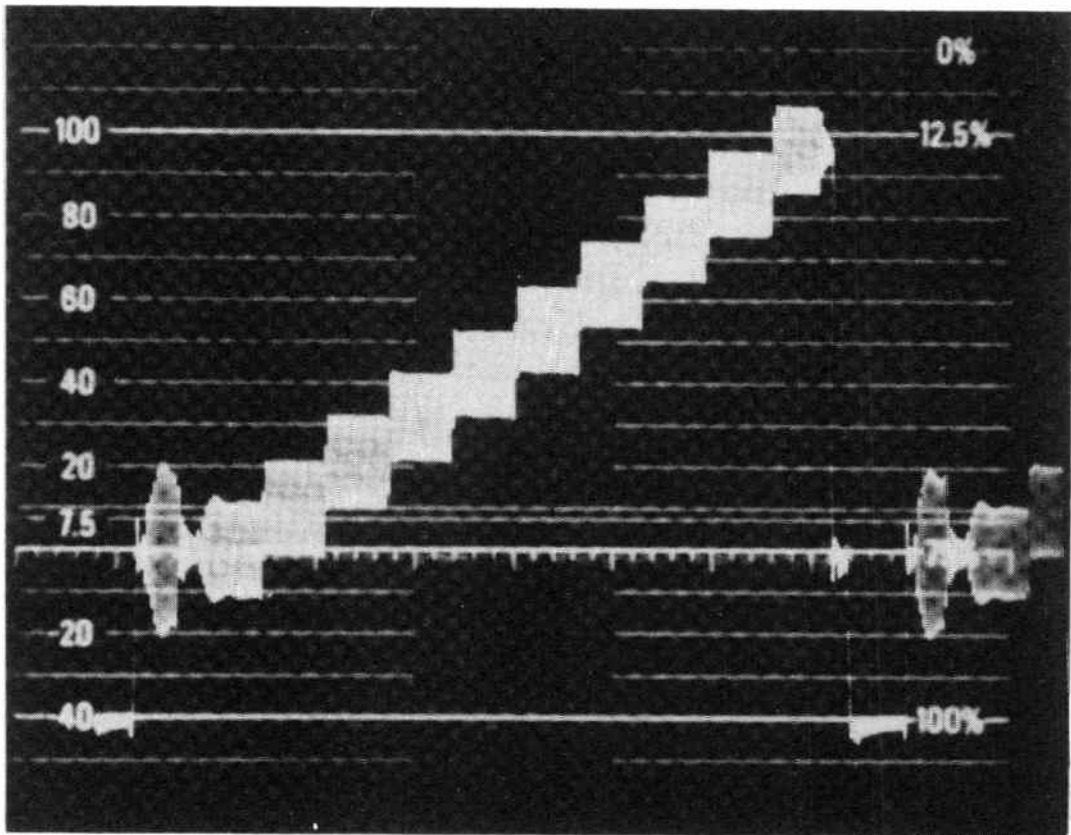

Fig. 9C.

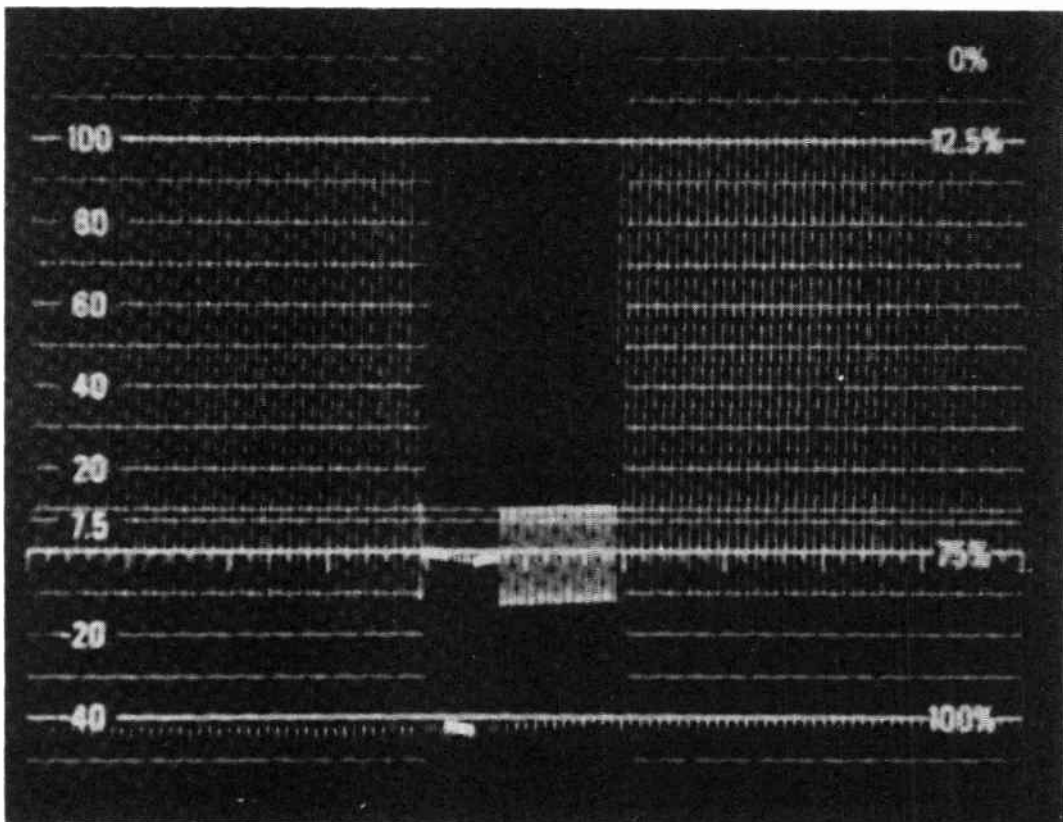

Fig. 9D.

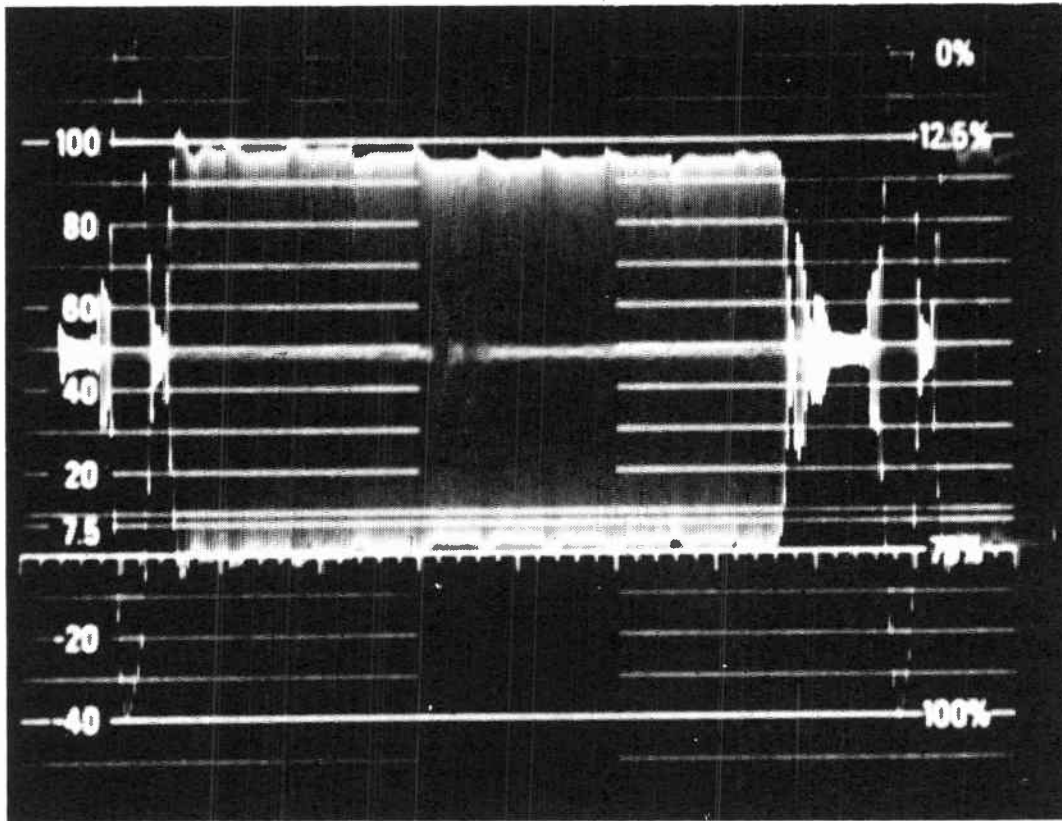

Fig. 9E.

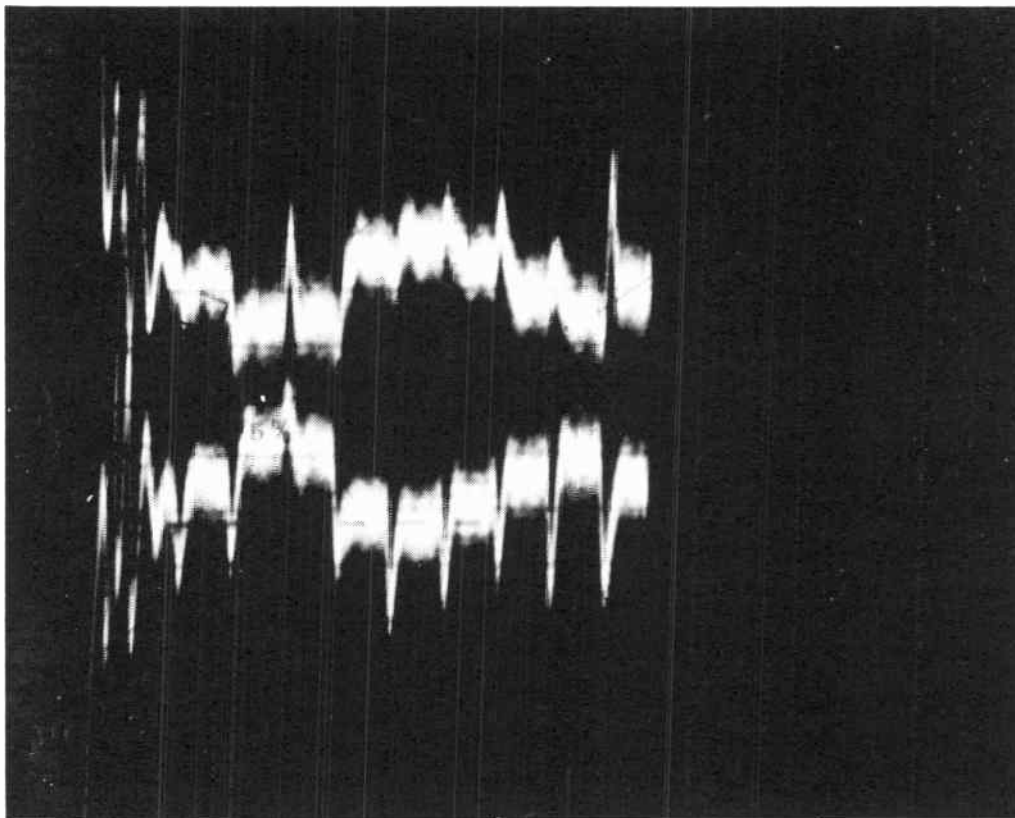

Fig. 24-9F.

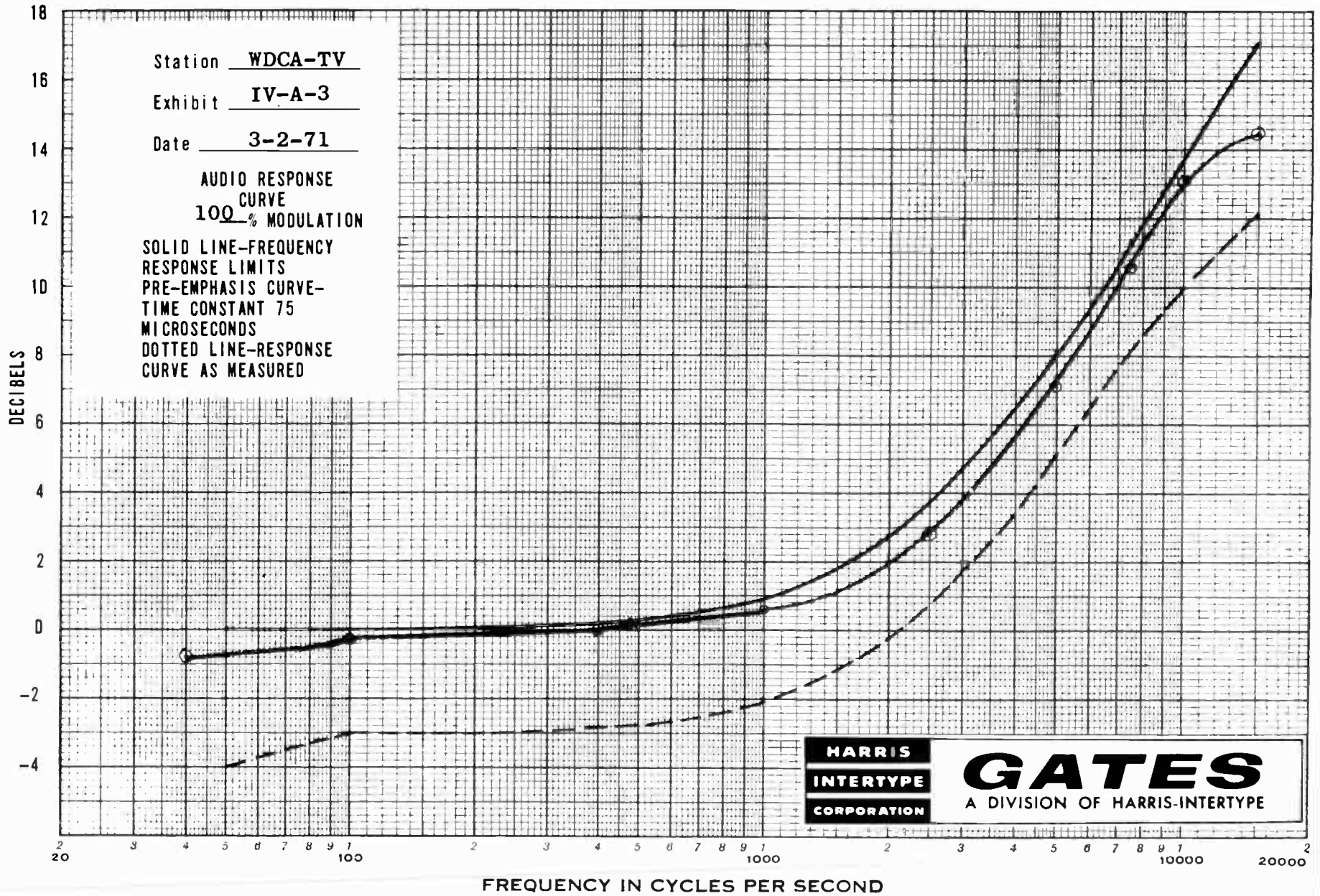

Fig. 10A.

STATION WDCA-TV

Exhibit No. IV-A-6

Date 3-2-71

DISTORTION IN PERCENT

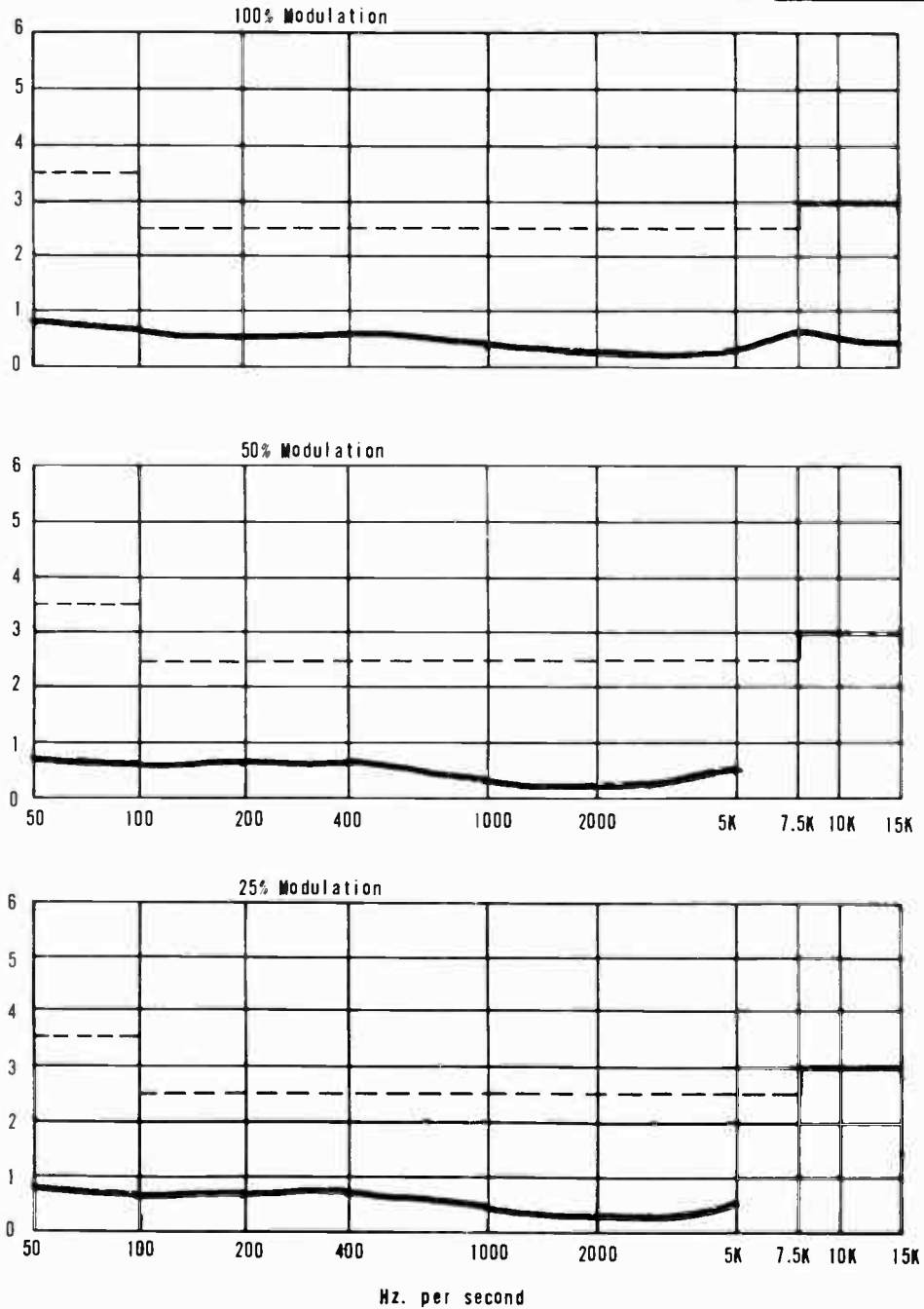

Hz. per second

19



Fig. 10B.

been divided down to 15 kHz to develop an error signal which is used to hold the modulated oscillator on frequency. The output of the modulated oscillator is up converted, using the reference signal from the visual exciter. An EBS latch circuit provides on-off control of the aural carrier. A similar stripline amplifier is used to provide the output power to drive the aural klystron amplifier.

The specifications of the BT-220U exceed all FCC, EIA and NAB recommendations and regulations. The proof of compliance with the published specifications is contained within the license application information submitted by WDCA-TV. This information was compiled by WDCA and Gates personnel cooperatively. Figs. 9A through 9F show some of the submitted information.

Fig. 9A is the diode demodulator response. Fig. 9B shows the amplitude versus frequency response measured with a Rohde & Schwarz videoscope. The lower side-band response is of particular interest. Notice the -0.5- and -0.75-MHz points. Minus 1.25 MHz and below are well below the -20 db specification.

The quality of the signal is quite plain to see in Figs. 9C and 9D, the horizontal and vertical sync intervals. Notice the sharp rise and fall of the sync pulse without excessive overshoots. The vertical interval is also very clean and the visual AM noise was measured at -57 db. Although the photos in Figs. 9E and 9F are hard to read that close, the differential gain is actually plus or minus 3.5% and the differential phase is plus or minus 2.25° as measured on the 520 vectorscope.

The aural information is equally impressive. Fig. 10A is the aural frequency response, which is smooth and well within tolerance, even at 25-kHz deviation. Fig. 10B shows that audio distortion is well under 1% at all modulation levels and only about 30% of the FCC limit. Audio signal-to-noise was measured at a respectable 64 db.

The result of this development is a transmitter that is only 6 feet high, 23.6 feet long and 5 feet 3 inches deep (Fig. 12). The five klystrons are all identical and can be changed by one man in 10 to 15 minutes. The four heat exchangers shown in the rear are identical. The system will operate with only three exchangers up to an ambient air temperature of 90°F.

The four power supplies (not shown) are identical and each rated at 24 KV DC at 11.5A DC. Each power supply is self-contained in a weather-tight housing and measures 62 inches wide, 66 inches long and 66 inches high. The transformer, rectifier stack, choke and filter capacitor are immersed in oil. A pair of 3-phase secondaries are connected 180° out of phase with each having its own full-wave rectifier. By connecting the two rectifier stacks in series, there will be 12 conducting periods; therefore, a 12-phase rectifier. This approach to a power supply yields a 720-Hz ripple frequency, 42 db down at the output of the rectifier stacks.

Fig. 11 shows the WDCA system, which also includes remote control, dual exciters with automatic changeover, aural emergency changeover to use klystron #3 as an aural amplifier and a waveguide switch with a dummy load. This system meets the FCC requirements for remote control and will continue to, even with the loss of two klystrons.

The waveguide switch is manually operated and will deliver the full transmitter power to either the antenna or the waveguide water load. The water load has a built-in calorimeter for making power measurements.

Klystron #3 in this installation will operate either as a 55-KW visual amplifier or as a 22-KW aural amplifier. This entire operation takes place by activating a single pushbutton which transfers both input and output switches of V3 and V2. This switching can be done from the remote control panel.

BLOCK DIAGRAM BT-220U

WDCA-TV

HARRIS
INTERTYPE
CORPORATION **GATES**

Fig. 11

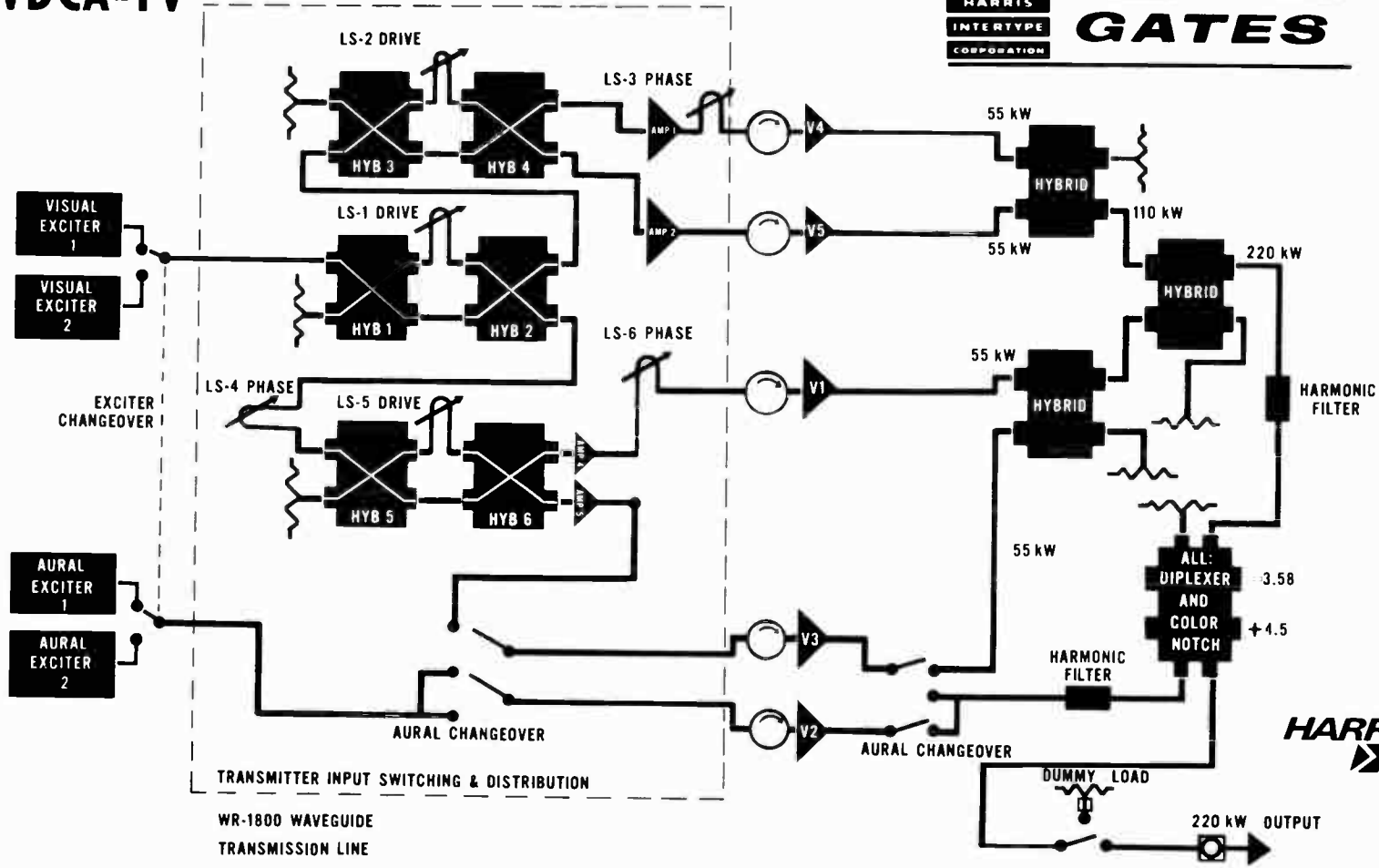

HARRIS
Communication
Technology

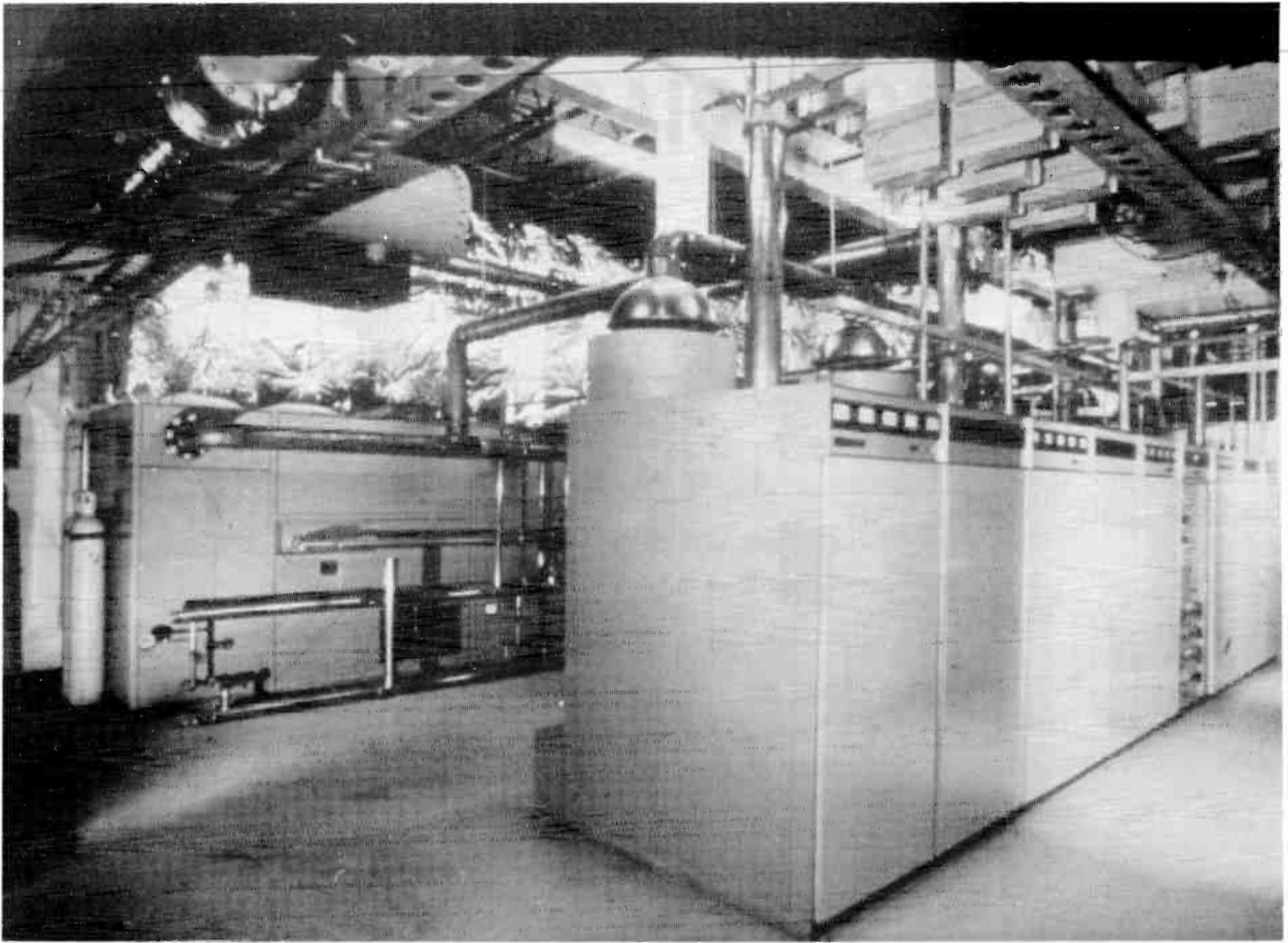

Fig. 12

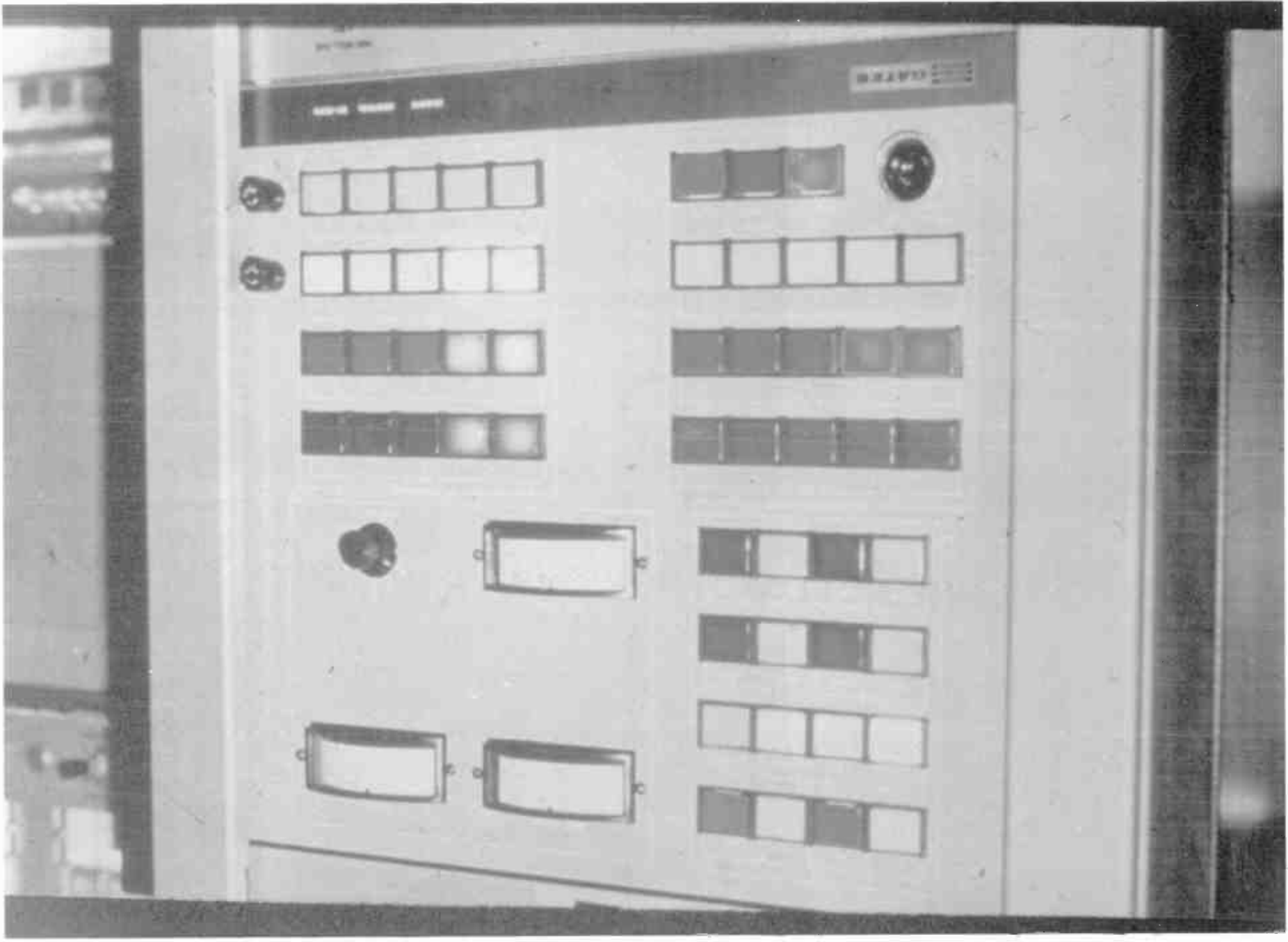

Fig. 13

Automatic exciter changeover will occur if the exciter output falls below a preset level. Manual changeover can be accomplished by selecting the desired exciter push-button on the transmitter or remote control panel. Complete transmitter control and phasing is accomplished from the same control panel. Each klystron can be turned on or off for testing independently without affecting the remainder of the transmitter from its own cabinet.

Remote control of the BT-220U (Fig. 13) is accomplished by a custom-built remote control panel which is located in WDCA's control room. Complete transmitter control and monitoring is provided.

This project started at last year's NAB Show and in less than one year, the impact of this remarkable development is already being realized in the Washington, D.C. area.

Computers & Automation – Are They in Your Future?

Walter B. Varnum
RCA, Camden, N.J.

To those of you who have followed the advances in technology during the past decade or so, it is obvious that new developments and breakthroughs are coming at an exponential rate. Had we been here only 50 years ago (that would have been in 1920), and predicted the existence and success of the broadcast industry, as we now know it, I doubt that any of us would have dreamed that our industry would have developed to where it is today! Yet only 30 years after the year 1920, we had nationwide television and, 5 years after that, we could receive TV in color. Now from our living rooms, we can see television from the surface of the moon—live and in glorious living color!

Everytime I fly across the country and look down at the Rocky Mountains, I can't help wondering how the early settlers ever jostled their wagons westward. And, it must have taken some very brave individuals to put railroads across parts of the United States. I say brave because the likelihood of obtaining a return on their investments must have been very questionable and unpredictable in those early days. Maybe that explains why only one golden spike was used when they built the Union Pacific! Many times we are prone not to make advances because the projected costs of such advances appear to outweigh any possible returns. But man is involved in a peculiar paradox; he is always working very hard to reduce his workload. Actually, he is working hard to increase productivity and profits without a corresponding increase in his own physical efforts.

The advent of the computer has relieved man of many routine, repetitive, complex, and time-consuming tasks. A computer can atomize data, facts, and instructions; store them, sort them, combine them, compare them, and operate on them to perform tasks which are burdens to man. Computers now route our long distance telephone calls, process and issue the checks in our banks, schedule our trains and planes, and make our weather forecasts. The glamorous computers which direct space vehicles during flight differ very little from the computers that control the billing, shipping, warehousing, and writing of checks in industry.

It is only logical to assume that computers will play important roles in operating our broadcast and television businesses in the future. If, today, we set an ultimate goal, we might envision a computer that controls all of the business operations of the station, all of the functions in your studio operations, and even turn on and turn off and maintain your transmitters.

We might envision a single switch that would start your station in the early morning, and another to turn off the station at the end of the broadcast day. These switches would cause the entire operation to perform in a manner similar to the way you now run it manually. I suppose that when we achieve that one-switch goal, some bright lad will come along and suggest that we control it from a time clock!

But, as it took a number of years and many developments from the time the Wright Brothers first flew their small home-made aircraft until regular jet service became an everyday mode of transportation, so it may also require a few steps before we achieve our ultimate goal as we have defined it. The technological elements are available today. With a little bit of time, and some money, and, most important—a desire—there is no reason why we cannot build a system that meets our goal.

Let us examine the possibilities; first, our studies indicate that we should concentrate on two separate areas of the broadcast business. These two areas are the technical operations and the business operations. Business operations encompass all of the functions performed in the front office and includes traffic, sales, accounting, and payroll operations. Technical operations should be divided into two parts: namely, studio control and transmitter control. But before we get into this thing too deeply, let's examine the business and technical portions separately.

The business operations of a radio or television station or a group of stations are not too unlike those of an insurance company or a bank. Computers are now in daily use controlling many of the routine and repetitive clerical-type functions of these and other businesses. A team of experts, knowledgeable of the business operations of the broadcast industry, can prepare computer programs that will enable a computer to perform almost all of the business operations. There are even now a handful of companies who are offering this service. Most broadcasters find that it has been quite difficult to teach an outsider—this is; a non-broadcast-trained computer programmer—all of the intricacies and subtleties of the broadcast system of priorities. Most computer people and broadcast people do not speak the same language. This, of course, can and must be overcome.

Suppose that we do overcome it. What would we then have? Your most important inventory item, time, can be controlled more carefully than ever before. Your salesmen and your agency will be able to address the computer from any part of the country to obtain instantly, for example, a listing of the availabilities at your station.

Even special requirements can be met such as a listing of availabilities on Mondays, Wednesdays, and Fridays between the hours of 1 and 5 PM that do not follow competitive soap announcements or programs. Think how this would help a time buyer in New York if he could obtain this information immediately and without placing a telephone call to you just before he is leaving for his martini lunch and you Westerners are just coming to work and looking for your first cup of coffee! Think also how convenient it would be for that same time buyer, by signaling a command to your computer, to place an order on your station when he found that you had availabilities meeting his needs.

Your traffic department could store tomorrow's, next week's or next month's program schedules either in complete or in skeleton form and have them available for instant recall for editing or for adding additional information on the schedules. All of the payroll data at your station would be in the computer and checks would be prepared in the correct amount and on time for distribution on each pay day. Sales commissions would be automatically computed and checks drawn.

Financial reports for any segment of the business could be made instantly available on a TV monitor or hard copy. This would include not only a current profit and loss statement, but might also show how much money was spent with Eastman Kodak for raw news film during the past three months or over any time period that you select. By means of commands or feedback from your technical operations, confirmation would be received and stored in the computer that commercial programs or spots were properly aired. The computer would then prepare billings for your customers, just like the telephone company computers prepare your monthly telephone bill.

Those of you who have been fortunate enough to attend modern business schools will be quick to recognize and elaborate on the potential possibilities of the computer in controlling the business operations of a radio or television station.

I sometimes think of a computer as being like a large hotel which, in some cases, might be as large as the Conrad Hilton. This computer might even be in Chicago, or

in Salt Lake, or Atlanta and be used by other broadcasters or businesses. You would be assigned a few "rooms" on one floor in this mythical hotel-type computer and other rooms and floors would be assigned to other customers. Absolute privacy would be maintained and since computers are quick "thinkers," you would be unaware that the other customers existed. Many customers could talk to or use the computer at the same time.

Within the confines of your "room assignments" would be a series of storage areas like safety-deposit boxes in a bank. The boxes would be allocated for use by the several departments or operating functions in your station. For example, all of the payroll information might be in one or two safety-deposit boxes accessible only to your chief accountant, controller, or other qualified persons. The traffic department might have one or several boxes; perhaps one for each day of the week. Availabilities would be accessible from another box and so on. Certain employees would have keys to the "doors" of some boxes in which they could add, remove, or change the data stored therein. Some personnel might be able to look through a window in the door of the box but would not be authorized or able to disturb any of the information stored there. It is only logical that a box or two be allocated to the engineering department for use in controlling the technical operations of the station.

The use of a modern computer can eliminate one of the daily headaches with which many stations are now confronted. It would eliminate the need for a printout of the daily schedule or program log. How many times has the next day's schedule been issued at 4 o'clock in the afternoon and, immediately afterward, a change has occurred that required sending the office girl all over the plant to make corrections on all copies? If the daily schedule can be posted in the computer and read out in all areas on television-type monitors, it only would be necessary for the traffic de-

102930	LUCKY STRIKE	CMCL	VT1371A	SCHMIDT
	RT CT PBC3 0020	FADE	UND FUL	CT2 STP
102950	MUELLER	CMCL	FXX1432	
	CT PAC2 0030			STP
103020	DOVE LIQUID	CMCL	T17438A	
	CT TVT1 0020			STP
103040	LOCAL NEWS	ENT		
	CT STD1 M			
103500	BERGMAN	CMCL		
	FF STD3 M		UND FUL	CT3
103530	EL PRODUCTO	CMCL	YF044	
	CT PBC2 0030			
103600	NEWS CONT			
	CT STD1 M			
104000	GEN FOODS	CMCL	YT0074B	
	FF TVT1 0030			
104030	UN COMM FUND	PSVC	FA0024A	
	FFPAC1 0010		OFF FUL	ANN STP
104040	NEWS CONT	ENT		
	CT STD1 M			
104420	CHEVY CHASE	CMCL	ZZF730N	
	CT PBC3 Q			
104500	NETWORK NEWS	ENT		
	SF NET M			

Fig. 1

partment to correct the data stored in the computer by means of typewriter type keyboard. Everyone, then, would receive the same changes, and at the same time. This would certainly reduce errors and misunderstandings that now occur when some of the printed copies go uncorrected.

Automating the technical facilities of a television studio plant are quite complex. We have the technology for doing it but we must establish certain basic ground rules for the operation. The program schedule must be interpreted and instructions added for each event in order that control of the video and audio switching and the starting and stopping of film projectors and tape recorders can be controlled automatically. The entering of this switching and control information can be performed in advance of on-air time since it too can be stored in the computer and read out on standard television monitors. The readout might look something like Fig. 1, where the top line, or on-air event, is shown as starting at 10:20:30; it is a Lucky Strike Commercial, on film number VT-1371A and Schmidt is the agency. (You can see that this photo was made back in the "good old days" of the cigarette commercial!) The second line in the illustration shows the technical control data and tells us that the spot starts on real time, we cut from the previous event to this one, we're using projector B and the color camera on film island number 3 and so on.

Television monitors in the offices, in master control, in your film and tape rooms would display the current on-air event and a series of upcoming events as shown here. When the on-air event is switched to the next, the top two lines will disappear and the succeeding events will move up, with a new event appearing at the bottom of the screen. By means of another monitor and keyboard, the memory can be searched for events beyond those shown on the on-air monitor to find the name of a program, or the identification number of the film for, say, a spot being shown at 4 o'clock this afternoon. Other search monitors in the film and tape libraries could be used to determine future requirements so that material can be drawn and sent to the film and tape machine rooms.

With such a memory-controlled system, it then is only a matter of properly loading the projectors and tape recorders so that, when they are called for, the correct material is aired. And with the advent of cartridge tape recorders, we can solve that loading problem. A video cartridge recorder like the TCR-100 can be preloaded for 22 multiple events and preprogrammed by means of its own internal computer for up to eight sequences.

And, who knows, we may some day have cartridge film projectors. Devices of this type will simplify station automation systems of the future and reduce the work load in the operating areas since the machines can be loaded considerably in advance of on-air time. We now have the technology for automatically performing all of the various types of transitions that your operators now do manually. These include fades, wipes, supers, special effects, etc.

Peripheral equipment will be available to type out the program log showing what was actually on-air. Although the technology is available, considerable development is yet required for equipment that will actually identify each piece of material that is placed on-air, and whether or not a slide was right side up, or whether the sound exciter lamp did not burn out in the middle of a film spot. One sometimes is tempted to ask whether, perhaps a \$75-a-week receptionist watching a television receiver in your lobby might not be the most accurate and economical way of performing this function. But, that is not automation and will not provide feedback to the computer for billing purposes.

For the transmitter plant, technology is close at hand to allow you to build a wall and padlock the gate around your plant. No one need be in attendance because pro-

vision will be made to continuously monitor the performance characteristics of the equipment and automatically make all necessary technical adjustments to assure high performance at all times. The adjustments will be typed out on hard copy in the form of a maintenance log so that during the monthly visits by your maintenance personnel, they will be able to analyze the data and predict or define possible weaknesses in some portions of the system. Control of video level, sync signals, and other levels (which are now adjusted by the transmitter operator) will be performed automatically. If spare transmitters and antennas are installed in your plant, the malfunction of one would cause the computer to select, on a priority basis, the proper combination of spare transmitter and-or antenna to maintain your on-air status.

The technology is here. We have the computers and we know how to automate our equipment and business operations. The only deterrent to going ahead is a matter of cost. Historically, it has been shown many times that if there is a need, we can have what we want. We put railroads across the continent that opened up the West. We now have passenger jets that are opening up world markets. And, we can have automated broadcast systems to give us better control of our business functions for increased profits and better control of our programming and technical operations for improved on-air performance.

FCC/Industry Technical Panel

FCC/Industry Panel

Moderator: Robert W. Flanders
The WFBM Stations

Panelists:

Albert H. Chismark
Broadcasting Div.
Meredith Corp.
Syracuse, N.Y.

Harold L. Kassens
Rules & Standards Div., FCC
Washington, D.C.

Lloyd R. Smith
FCC
Washington, D.C.

Neil M. Smith
Engineering Consultant
Washington, D.C.

Lee R. Wallenhaupt
WSJS-TV
Winston Salem, N.C.

MODERATOR FLANDERS: We already have a number of questions on hand, such as operator requirements, coding signals, VIR signals, directional systems, and so on. To start this discussion, I have a question for Lloyd Smith concerning the encoded signals and our responsibility. Do you think there is any chance for relief in this area?

MR. SMITH: As far as the encoded signals that Bob is referring to are concerned, recently we granted an extension of time for stations to continue to transmit coded identification signals for a period of 90 days in a manner somewhat relaxed from the requirements of our present rules. The relaxed standards permit the transmission of the coded identification material within the first and last ten microseconds of lines 20 through 25 and 258 through 262. I don't want to say too much about this now, because this is something that is still under consideration by the Commission.

I understand that International Digisonics, who filed the request for rule-making which was subsequently adopted, is supposed to file comments at the end of each 30-day period on just what progress they have made in keeping these coded signals within the required lines. I don't know just how many (if any) reports they have submitted to date. Perhaps Harold Kassens can bring us up to date on that.

MR. KASSENS: It is a real problem, as you all know; and as Lloyd pointed out, the extension is until April 22, and it is up to that date that Digisonics has to do something.

Theoretically, the system is a good one, I think we will all agree. In the beginning I think there was a lot of feeling on the part of broadcasters that they really didn't want to get involved in this, but I suspect that most of that feeling is gone. The problem is how do you make the system comply. You who have problems know exactly why those problems have developed. Let's hope they get satisfied.

Digisonics has until April 22 to come in and have the system working, and working right, or to propose further rules within which the system will work. They have submitted two reports. I think you can guess what is in those reports, because they tell the progress they have been making. I suspect a good many of you by now have received the new SMPTE tape which presumably goes into the problems. I guess we will just have to wait until April 22 to see what happens next.

I would like to point something out to you, though. Digisonics came in the last time and said, "We recognize there are a lot of badly coded commercials out in the field. We would like to get our hands on those commercials." So we, to be accommodating, put in our Public Notice the statement that we expect the stations to send these back since Digisonics said they would like to have them. I would hope that your file isn't full of lousy commercials by now.

MR. CHISMARK: Hal, I am wondering if you can enlarge on the Notice of Inquiry regarding FM interference with television Channel 6.

MR. KASSENS: If you are on Channel 6, I think you know what the problem is, particularly if you have non-commercial educational stations in the vicinity. If you are not on Channel 6, you are lucky, because it is a problem. The educators, of course, are trying to do a good job. They would like to start many new stations. HEW now has funds available for radio educational stations as well as television stations. The Channel 6 problem of adjacent-channel interference is quite serious, and the question is what to do about it.

We obviously want to have all the educational stations we can, yet we don't want this interference coming up because we get many complaints about interference going on today. One of the big problems, of course, is the adjacent-channel selectivity

of television receivers. Since our authority stops at the transmitting antenna, there is little we can do about these receivers.

The other problem is, unfortunately, that in FM we try to go to the highest spot, and in flat country like Chicago you can do it on the highest building, which means that the transmitter is right in town, where a good many people are located. We are thinking in terms of asking questions about receiver characteristics and also the possibility of establishing for FM a blanket rule to get the FM stations farther away from densely populated areas.

The Commission last week adopted a Notice of Inquiry, and if you have this type of problem I would suggest you might want to get a copy and read it. We have asked a lot of questions and we certainly would like to have some answers.

MR. NEIL SMITH: In 1965, the Commission proposed some new propagation curves for UHF and VHF TV. Also, about the same time there was a rule making proceeding that would amend the rules involving field strength measurements. There are rumors that the Commission is stirring around with this area, and also the rumor that there may be some changes in the specified field strengths of Grade A and Grade B. Can you enlighten us on this?

MR. KASSENS: As Neil says, this was proposed quite some time ago, and if you have ever looked at these curves which we identify as the R-6602 curves, you know there is a considerable difference with the ones that are in the rules. The problem we have run into recently is that more and more people are relying on the 6602 curves as being more up-to-date, and you will realize that was exactly what was done in the land mobile proceeding. In a good many CATV cases they are attempting to use the 6602 curves.

Obviously, the UHF operators don't think very kindly of these curves, since they will reduce the distance to the Grade A and Grade B contours, but nevertheless we are being at least forced into a position of recognizing more up-to-date information. We are working on these.

A corollary to that is the fact that receivers have improved since the Grade A and Grade B contours were established in the Sixth Report and Order back in 1952. They are considerably different. We are working on a proposed rule making now which will take these factors into consideration and possibly redefine the Grade B contour and consider again the 6602 curves.

MODERATOR FLANDERS: We will now open the floor for questions.

VOICE: The Commission is reviewing a lot of directional systems that are in operation around the country, including my own. I have had some additional data. A station located in the North seems to be susceptible to severe changes in ground conductivity, and field readings taken in February are different from those taken in August. I submitted data to one of the Commission engineers and stated that I wished I had taken my original readings in February when the readings were high. He said, "It's too bad you didn't." That didn't help me, because I am still committed to restrictions that were imposed during the summer. Does the Commission have any plans to accommodate seasonal changes?

MR. KASSENS: It would be nice if we could. The trouble is that you couldn't draw a dividing line and say here is one monitoring point and here is another. I don't know how we would really come to grips on a situation like that. It is true that if you run your proof in the winter you may have a little wider latitude in your monitoring points than you would in the summertime, but maybe the answer in your case is to

run another proof in the winter and we will relicense the station. I would rather suspect from your introductory remarks that you have submitted this information, and, based on whatever modifications you made, we can modify your license.

You have another problem, and you probably are aware of it. Just last week I saw the results of a study that one station made with their base meters under varying temperature conditions from roughly minus 20 to plus 30 degrees Centigrade. It was rather revealing. I frankly don't know where the report came from, but I would like to get my hands on a copy because it reveals another very serious problem. If we have problems with base meters, that may be a lot worse than the seasonal problems we have.

VOICE: They are not very reliable with the wide temperature changes. I wonder if, for example, the monitoring points were within tolerance, and the base ratios are not, whether or not this should be taken into consideration.

MR. KASSENS: It is a good point. You would have people arguing about lousy monitoring points, though, and the fact that we should just rely on phase monitor readings rather than the monitoring points; but you know about the directionals. These things are all indications, and I would say that if your monitoring points are in and your base currents are out, I would try to find out why the base currents are out before I did anything.

VOICE: You mentioned the base meters. That is why I brought this up, because the meters could be in error.

MR. KASSENS: It may be that we will end up with calibration curves for our standard meters.

VOICE: It seems to me the monitoring point would be the most important factor.

VOICE: Mr. Kassens, I am the gentleman who submitted the report on the study of base current meters. If anybody is interested, I will be glad to make copies of these reports available.

VOICE: I operate a 10-kilowatt two-tower DA. Upon installation of a new phase monitor, after 24 years on the old one, it was necessary to take data for submittal for modification of license. I assumed the station in August and I started to install a phase monitor in December.

In Long Island, we have a problem that the gentleman behind me discussed. I was finding it impossible to correlate the results of my three monitoring points with the base currents with the loop sample currents, so out of desperation I removed the base current meters, which are Weston's 743s, 15- and 20-ampere full-scale movements, and dispatched them to a certified calibration source in accordance with Weston's recommendations. I had the meters calibrated at 5° C intervals between minus 20 and plus 30 C, which is approximately the temperature I find in doghouses. These doghouses, needless to say, have no very good amount of protection.

As a rough idea, my reference tower is licensed at 8.1 amperes. Weston quotes the meter as 1% accurate at 77° F, which is 25° C. The true current of 8.1 amperes in the lab showed up as 8.8 amperes at -15° C, where I was taking my proof. That is an error of 10% on one meter. The other meter had an inverted discrepancy, so that the total uncertainty at the licensed current values between the two meters was over 18%.

Now, it is impossible under these conditions to demonstrate a base current ratio that is within 5%, so I submitted the calibration data along with my request for modi-

fication of the license, feeling that my monitoring points are correct, the common point current is correct, and on the new phase monitor with a sensitive discriminator, a sensitive linear detector, they show what they should show. However, the base current ratios appeared to be about as relevant as the time of day that I take the measurements.

I am considering initiating a petition to the Commission to request that base current ratios either be broadened to 15%, because there is nothing on the books, it is a question of interpretation, or that sample current on a type approved phase monitor be established as the license term instead of base current ratios, because I don't know how many station chiefs are in a position either technically or economically to submit their base current meters for a close temperature calibration for accuracy.

MODERATOR FLANDERS: That is a very interesting remark, and I am sure we have all experienced similar problems, and I am very grateful to you. Are there any other questions from the floor? I heard something about VIT buzz.

MR. WALLENHAUPT: I am certainly no authority on VIT buzz. I heard someone today talk about phase problems. We have had some problems with it ourselves. We had a problem with the VIT signal being higher than the field itself. We honored the VIT signal and let the video go where it was, and our competitor took the video up and forgot the VIT signal, and he received a citation for over-modulation. We were cited for under-modulation. It is a problem.

MR. CHISMAR: This subject came up at a meeting I attended where some people out in the central part of the country noticed that during the time the VIT signals were being transmitted, there was a buzz in the air. This is being investigated right now, and I mentioned it to Hal this morning because of the up-coming possible requirement of some type of a VIR signal to accompany the remote control authorization.

I don't know if any of you fellows have noticed this, but it has been necessary in some cases for us to eliminate the VIT signal, especially when those signals are being picked up by cable systems who reduce their aural and it becomes more pronounced.

VOICE: I would like to know what influenced the decision in this VHF remote control proceeding to have UHF stations go to a 5-day-per-week inspection of their facilities when it was not required previous to this point?

MODERATOR FLANDERS: I would like to defer that question until tomorrow, if you will, please.

VOICE: Where do we stand on positive peak modulation problems?

MR. KASSENS: One of the reasons that only Lloyd and I could come is that the third member is writing that right now. We have been delayed by a few things this past year. One of them, of course, was VHF and UHF remote control, but the comments were in in December, and I guess for us this is rather speedy action, to be working on it now. We want to get it out in the near future.

I can't give you any thoughts about how much or where, or that sort of thing, but if any of you have any spare time and are ever in Washington, drop by and read the comments in the document because they are very interesting, and they point up a lot of questions that I think we have sort of passed over, talking about this subject of modulation and different types of waveforms.

VOICE: If I may divert to International Digisonics again, I think Mr. Kassens said that on April 22 International Digisonics will present the results of their investiga-

tion. I am sure, as far as International Digisonics is concerned, it will probably be very favorable.

I am wondering, under the relaxed standards, how many broadcasters actually have checked each and every commercial to see how well you can relax the standards in the specifications. I think you would all be very much surprised about some of the coding, even in regard to the relaxed standards. I wonder if there is something that the broadcaster can do as a part of this investigation, because certainly any type of optical system that is put in, the burden, of course, will fall to the broadcaster from there on out. I am wondering if there is something the broadcaster can do, rather than just rely on the International Digisonics investigation.

MR. KASSENS: Certainly there is nothing to prevent you from telling the Commission about your experiences with these coded commercials, and let us know what your experience has been, because if nobody says anything we can almost take the attitude that there is no problem, and go from there. But if you have had experiences with this, and know what is going on, I think you would be well served to write us a letter and let us know.

MODERATOR FLANDERS: That is very good advice, too. Our congressmen said if they get five letters on a hot subject everybody is overwhelmed.

VOICE: One thing that seems right now to be an inconsistency in our current rulings in broadcast stations and radio relay broadcast stations is the ruling on automatic log-keeping for transmitters. Accordingly, in essence we can have an automatically kept log as long as there is an operator that can hear an alarm go off if something is out of tolerance. In the same breath, a third-class licensee under the present rules can do nothing but shut the station down if it is out of tolerance, that is, as far as frequency or something that he can't correct according to the ruling.

Why is it, then, that we cannot have unattended transmitter operation? Obviously, if the third-class licensee can't do anything but shut it down, an alarm could shut it down. We would like to be equally as effective. The chief engineer could be sitting at home and take 30 minutes to get there to do anything. The same if the buzzer was right in his house. Why not have it unattended, with a system similar to the Pocket-Page system where the thing buzzes in the engineer's pocket if the transmitter goes off?

MR. CHISMARK: I believe that, under the Communications Act of 1934, all broadcast transmitters must have a licensed person in charge. Am I right on that?

MR. KASSENS: Yes, but I think you can go a step farther. To what the gentleman said, I would say Amen. What we all ought to do is to get up in a body and go over to the basement of the Hilton and grab each transmitter manufacturer and have a good heart-to-heart talk with him. I think it would be stupid to say it couldn't be done. I think probably most of the people in this room could sit down and figure out a good way to do it. But you tell me why it hasn't been done. I don't understand it. The Commission would love to see such a thing, because we have already figured out the thousands and thousands of dollars of inspectors' time that we could save if we had a good automatic transmitter that would do what we want it to do. It's beyond me.

VOICE: I just want to say that if, in fact, this can be done we can do it, every logging system has an alarm system on it. Certainly we could tie this in with our remote pickup transmitters and broadcast an alarm to our staff, or under the present system it says nothing about the operator being away. We could remote-control it from his house, and he could sleep all night long. So, what good does it do to have

somebody at the station? We have a radio link between the two. Are you saying that if we do it the Commission would certainly accept it?

MR. KASSENS: I am sure they would, but let's not over-simplify this. You are getting into questions of what you do and how you do it. You have to consider the public interest question. You just can't connect the automatic logger to the transmitter. You have to go a step farther and decide exactly how you are going to maintain power levels, and whether or not the automatic logging system is adequate to keep you within the power. We would insist that this transmitter adhere strictly to the rules, which means obviously a very precise system, not ultra-precise but a certain degree of precision to make sure that if the power got up to, say, 5.1%, you are off the air.

We also would be concerned about how many times you went off the air. It is not a real simple case of connecting some wires from the automatic logger to the transmitter, but certainly a transmitter could be built which had good frequency control, good power regulation, and good modulation control so that you wouldn't have to worry about these things.

MR. NEIL SMITH: Isn't the old Collins automatic transmitter still pending before the Commission?

MR. KASSENS: Yes; this is the automatic FM transmitter.

MR. NEIL SMITH: It sounds like the Commission is not totally against the idea. Is there some possibility that a Notice of Proposed Rule Making will be issued on it?

MR. KASSENS: This was a Notice of Inquiry based on the Collins petition, but we have to react to the comments to a petition, and the comments were very sparse and not very helpful.

MR. NEIL SMITH: So you need more?

MR. KASSENS: Yes.

MR. CHISMARK: I might add that the NAB has an Automatic Transmitter Subcommittee working on this very project right now.

VOICE: In the present microwave regulations, if you have a single-hop STL link you are to have a licensed engineer at the studio. If you have a ten-hop system you only need a man at the transmitter. It would seem to me that this regulation should be relaxed. We have a competent transmitter operator, so one is not required at the studio. Have you gentlemen entertained any motions to this effect? The system is over two hops long and you don't have to have the man at the studio.

MR. LLOYD SMITH. The rule now requires that you have to have a licensed operator at the microwave transmitter. However, there are provisions for remote control and unattended operation of television auxiliary transmitters.

VOICE: In the microwave rules, you are required to have a licensed man at the studio. This seems rather foolish, because a ten-hop system and a dual system can run without a man at the original site or any of the other sites as long as you have a competent man at the TV transmitter who can tell if the thing goes out of tolerance. This is what the regulation reads at this time.

MR. LLOYD SMITH: Right. The present rules—which I readily admit are somewhat confusing in this regard—provide for the unattended operation of multiphop

intercity relay and STL stations and single-hop intercity relay stations only. Single-hop STL stations are not normally permitted to operate unattended. These things are all under consideration. There is a petition for proposed rule-making regarding Part 74 of the rules filed by NAB now before the Commission. It was very recently filed.

VOICE: Is there any possibility of waiving this particular requirement until such time as it can be made part of the rules?

MR. CHISMARK: I think you are misinterpreting the rule. It says the licensed operator has to be at the control point, which means you could remote control the microwave at the transmitter and let the transmitter operator be the control.

VOICE: Then would you say that a Bell Telephone system would be adequate to tell the fellow to shut down? Would this be an adequate control system?

MR. CHISMARK: Are you talking about a private STL?

VOICE: STL from a regular studio, a television transmitter where you have a man on duty at the studio who now has a competent engineer with a first-class ticket, and the man at the transmitter has a first-class ticket, and you would like to tell him to shut it off. If you have a Bell Telephone connection, where you can dial from the transmitter to the studio and ask him to shut it off, would this be considered adequate remote control?

MR. CHISMARK: Why not let him shut it off himself?

VOICE: The point is, we would like not to have a man with a license at the studio all the time, and this is required, if I understand the regulations correctly, when you have a single operator system. If you have a two-hop system that you use, if the man at the transmitter sees something wrong he can shut it down. In a 400 system it is impossible to get up to one of these stations, in some weather, within 10 or 15 hours, since most of the equipment is highly directional, very narrow bandwidth and space frequency-wise. It would seem to be very good and in the interest of everyone to delete the requirement for a single-hop system, especially if you contact him by telephone from the transmitter and ask him to shut the thing off if you did not receive a signal. If you didn't receive a signal you would immediately know the antenna had turned in some other direction or something else had happened, and it would be time for him to look into it and shut it down or check it.

VOICE: I believe there was a waiver granted on January 26 or something like that to that effect, for the station to operate a single hop STL with the transmitter operator having a telephone.

VOICE: Mention has been made of the interference problem with Channel 6. Is the Commission equally concerned about the second harmonic problem of FM stations falling on the high-band TV channels? We have a case in point. There are two local stations, and their second harmonic falls within our video pass band; and although they are not in violation of the rules as far as their second harmonic is concerned, the overload problem with the TV receivers in what you call the service area of these FM stations causes a lot of interference. I am sure it has come to the Commission's attention. I wonder if it gets the same priority as the Channel 6 problem.

MR. KASSENS: It certainly gets the same concern. I am not sure it gets the same priority. We will consider it in the Notice of Inquiry because, as you point out very well, the primary problem here is receiver characteristics. Certainly we are concerned about it. We get a great number of cases of that type of interference.

VOICE: This concerns AM directional operation. Some two or three years ago I remember a Notice of Proposed Rule Making regarding the remote measurement of phase being permissible, and then maybe relaxing the inspection every other day or even once a day. Can you refresh us on that?

MR. KASSENS: Yes. If you recall, we tied the relaxation of the daily visit into the question of the type approval phase monitors. We have had difficulty with phase monitors through the years, as you all know. We have had this under consideration, and actively have been working on it. In fact, we turned the problem of phase monitors over to our lab because if we have type approval they are the ones that are going to have to do it. If you have to check approved phase monitors, then our equipment has to be of a much higher order of magnitude than the manufactured phase monitor.

The lab is now prepared to go ahead and check these, and in fact they did get their hands on a new phase monitor to check it, and found out the phase readings varied with the amplitude of the sample signal. So, we do have some problems here. I would assume as soon as the lab is all set to go, and tells us exactly what they are equipped to do as far as measurement is concerned, we will finish that one. I suggest to you, though, that obviously this daily visit sort of thing is tied in now with the NAB petition on operators, which you may not want to talk about.

VOICE: Then you say it hinges on phase monitor approval?

MR. KASSENS: That's right; it hinges on the type approved phase monitor.

VOICE: Mr. Kassens, would you comment again on the apparent inconsistency in the rules concerning TV remote pickup as compared to television intercity multiple hop relays? As I understand it, television remote pickup would require an operator at each point, whereas the same equipment used in intercity or the other does not.

MR. LLOYD SMITH: I didn't hear the gentleman's question too well, but our rules do not provide for the unattended operation of TV pickup stations. Under certain conditions—for multi-hop, inner-city relay, STL stations—if you are operating unattended, an operator is required at the receiving end. In a multi-hop system, normally I would assume that the receiving end is at the transmitter location.

There is some question about the language of our rules. Many of you who deal with microwaves know Rex Wilson who normally handles broadcast auxiliary applications. For more specific details regarding the matter, I suggest that you contact him at our Washington office. At least some clarification of the language needs to come about. Again, this perhaps would come from our Rules and Standards Division. Does this answer your question?

VOICE: Not exactly. Would you entertain a petition for a waiver to operate multiple hop pickups with the licensed operator operating only at the receiving end?

MR. LLOYD SMITH: Well, we entertain all petitions. This is something that would have to be considered on a case-by-case basis. It depends on the circumstances.

VOICE: It is a problem for us personnel-wise. If we have a 3-hop remote pickup we have to have three licensed engineers.

MR. LLOYD SMITH: Yes, I understand.

MR. WALLENHAUPT: Since AM has a weekly inspection for calibration (it looks like maybe VHF television is going that way), do you see any relaxation for the calibrations for directional AM? Do you perceive a 5-day week or a 2-day week? I believe at one time they asked for once a day.

MR. KASSENS: We have a petition. We haven't been able to get to it, but it is for relaxation of the rules, and obviously we will react to it.

MODERATOR FLANDERS: I think everybody has been very patient, and I would like to applaud these people who have come from so far. The meeting is now adjourned.