

# MODULATORS FOR OSCILLATING

Feb. 3rd  
1934



15¢  
Per Copy

# RADIO

REG. U.S. PAT. OFF.

# WORLD

The First and Only National Radio Weekly  
619th Consecutive Issue—Twelfth Year

Calibrated  
of Tone Controls

Oscillating  
Crystals Explained

Battery T.R.F. Set

New 48 Specifications

## ALL-WAVE SWITCH SUPER

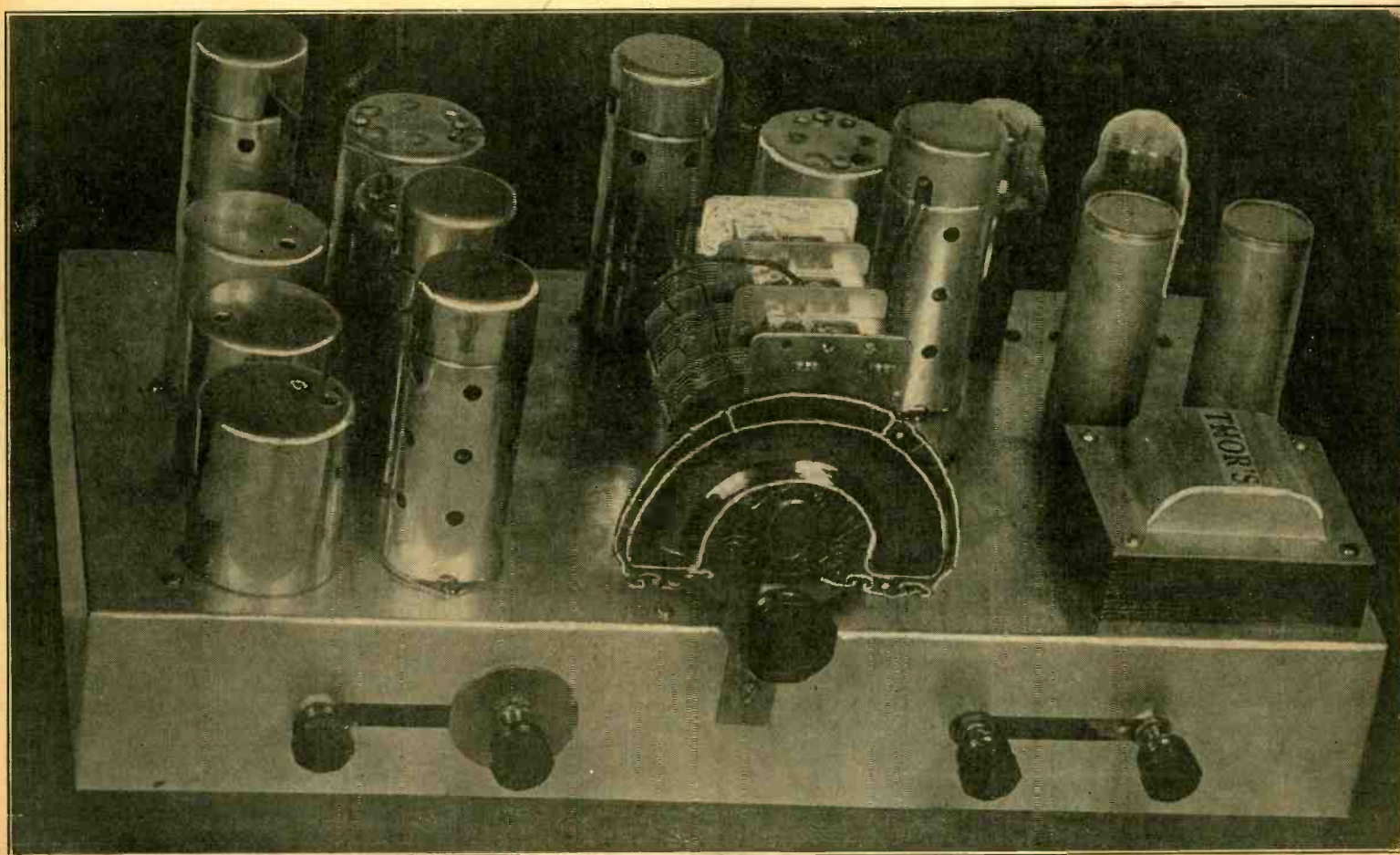

By using a special method of antenna input switching this 8-tube broadcast super becomes a 7-tube short-wave set. See pages 12 and 13.

# Reliable Radio Tips

Watch for  
This Special  
Page Weekly

## RELIABLE RADIO RUNS GIANT 1934 SALE!!

FOR A PRACTICAL GIFT SUGGESTS GIVING A  
RADIO—LET THE ENTIRE FAMILY ENJOY IT

### Reliable Treasure Chest Receiver



A Handsome Four-Tube "Treasure Chest" model receiver which is a splendid piece of furniture and a high quality midget receiver. The beautifully designed cabinet built by craftsmen will satisfy the most critical person. Tubes used: 1-57, 1-58, 1-80 and 1-47 power pentode. Uses a full sized dynamic speaker. Price **\$9.50**  
4 tubes .....\$1.45

### 4 and 5 Tube A.C. Midgets

A practical gift for the entire family. The most advanced features are embodied in these receivers. Quiet, smooth, distortionless reception.

Four-tube receiver uses 1-57, 1-58, 1-80, and 1-47 pentode; five-tube set uses 1-57, 1-58, 1-80, and 2-47's. Both models use a dynamic speaker especially designed for the output of the pentodes. The receivers are encased in a beautiful hand-rubbed walnut cabinet. Price, 4-tube A. C. receiver ..... **\$9.95**

4 tubes .....\$1.45  
Price, 5-tube A. C. receiver.....\$12.95  
5 tubes .....\$1.95

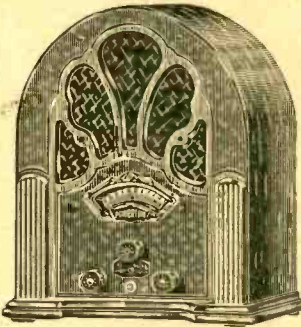

### Four Tube A.C. Short Wave Receiver

COMES MOUNTED INTO A BEAUTIFUL MODERNISTIC CABINET WITH BUILT-IN SPEAKER

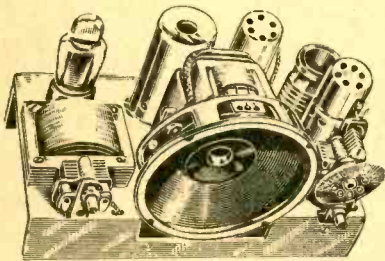

Looks like a midget broadcast receiver. Will tune in short wave stations from all parts of the world with ease. Uses four coils to cover the short wave bands from 15 to 200 meters. The built-in power supply is entirely free from hum or disturbing line noises. Uses an ultra-sensitive dynamic speaker to aid in tuning in the weaker signals. Kit of parts..... **\$17.50**

Wired and tested.....\$2.00 extra  
Kit of tubes.....\$2.50 extra  
Cabinet only .....\$1.50 extra



### Stromberg-Carlson Phonograph Pickup

Makes any radio a modern up-to-date phonograph radio combination. Instruction sheet furnished with the outfit makes it simple to install. Volume control mounted on the pickup enables one to control the volume, without adjusting any part of your receiver. Special Holiday price ..... **\$5.50**

### Powertone Sending Key

The most practical gift to one who has just become interested in amateur radio. Widely used as a code practice key. Well balanced and fully adjustable. Price.. **75c**

### For The Beginners Rocket Two-Tube Short-Wave Battery Receiver

Economical! Uses two 2-230 tubes, which assures long battery life. Tunes from 15-200 meters. Pulls in amateurs, police calls, etc. Kit of parts.

**\$5.50**

Wired..\$2.00 extra Tubes.....\$1.50  
Batteries .....\$2.25



### Powertone Two-Tube Battery Receiver

Enclosed in a handsome crystal finished metal cabinet. Can be built by any one. Beautiful full vision modernistic vernier dial aids in logging weaker stations. Will receive all types of short-wave signals, police, amateur, ship-to-shore, airplane, etc.



Kit of parts..... **\$7.95**  
Wired..\$2.00 extra Tubes.....\$1.95  
Batteries .....\$2.75

### A Power Pack That Converts Any Battery Operated Receiver Into an A.C. Receiver

Will convert any battery receiver to operate on a 110 volt A.C. line. All voltages terminate at binding posts on the chassis. Output; 2 1/2 volts at 10 amperes, 180 volts

tapped at 135, 90, and 45. Supplies clear hum-free power regardless of circuit sensitivity. Price including 280 rectifier tube. **\$5.95**

### EXTRA! SHORT-WAVE SETS

ACCLAIMED THE IDEAL GIFT FOR RADIO-MINDED FOLKS  
If you really want to please your radio-minded son, father, mother, brother, sister or friend this Christmas, give a short wave receiver. On this page are several very fine receivers for both the beginner and the more advanced short wave enthusiast, yet all at extremely low prices.

### For A.C. and D.C. Operation

Will work anywhere that 110 volt A.C. or D.C. is available. U. S. amateur reception is assured on loud-speaker by the use of a 48 power tube in the output.

With headphones the entire world is at your finger-tips. Chassis is completely encased in a beautiful crystal finished cabinet. Covers the short wave, band from 15-200 meters. Uses 1-78, 1-25Z5, and 1-43 tube. Price kit ..... **\$8.95**

Wired..\$2.00 extra Tubes.....\$3.25

### Beginners Twin Two-Tube Short-Wave Battery Receiver

A more advanced short-wave receiver for the beginner. Letters from builders verify foreign reception. Uses highest quality parts throughout. Complete with four plug-in coils to cover the entire short-wave band from 15 to 200 meters. Easy to build. Kit of parts..... **\$8.95**

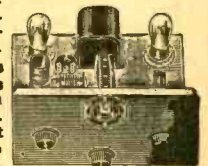

Wired..\$2.00 extra Tubes.....\$1.50  
Batteries .....\$2.50

### GIFTS FOR THE SERVICEMAN

Majestic 70 and 90 Condenser Blocks



Replacement condenser blocks for the Majestic 70 and 90 series receivers. Built to the exact specifications of the original. Absolutely guaranteed. Price .....\$1.35

4 and 8 mfd. Electrolytic Condensers

High quality electrolytic condensers. Can be used as a replacement in many receivers without fear of breakdown. Wet type—thus cannot be injured by slight overload or polarity. Inverted mounting.

4 mfd ..... 35c  
8 mfd ..... 40c

RESISTORS

Assortment of 50



An assortment of 50 R.M.A. color coded resistors. Composed of 1/8, 1/4 and 1 watt resistors. All popular sizes are included in the kit ranging from 100 ohms to 10 megohms.

FREE  
A beautiful bakelite case—a souvenir of the Chicago Century of Progress Exposition. Price ..... \$2.50

### Farrand Inductor Dynamic Speaker Chassis

Not to be confused with the various models now on the market and labeled Farrand Inductors. These models are genuine factory-built Inductors.

Two models are available, a 12" model and a 9" model. Mounting brackets are placed on both models. Price, 9" model.....\$3.95 Price, 12" model.....\$5.95



### A Handy Manual Published for SERVICEMEN AND SET DEALERS

Full of information, hookups, charts, trouble shooting hints, etc. Reg. \$1.00 **25c**

RELIABLE RADIO COMPANY, 143 West 45th Street, New York City

# The "THORAX" 7 Tube ALL-WAVE Super

The Globe-Trotter of the Air

Uses 1-55, 1-2A7, 3-58, 1-2A5, 1-80  
AS DESCRIBED IN THIS ISSUE

Kit of complete parts including DRILLED CHASSIS—ACCURATELY \$18.95  
DESIGNED—ALL PARTS TO BUILD and Dynamic Speaker . . . . .

MAIL ORDERS FILLED

## THOR'S BARGAIN BASEMENT

167 GREENWICH STREET

NEW YORK CITY

TRY-MO RADIO

### BARGAIN BASEMENT

Everything in radio, from a condenser to a Broadcasting Station.  
Headquarters for SERVICEMEN, EXPERIMENTERS and DEALERS at lowest prices in the city. Ask for Steve.  
Look for the NEON SIGN BARGAIN BASEMENT in window.  
Replacement parts, full line of Cones and repairs. Downtown Headquarters for Short Wave Sets and parts.

TRY-MO RADIO CO.

179 Greenwich St., Dept. R.W., New York  
WRITE FOR CATALOG

### SPECIAL SMALL POWER TRANSFORMER

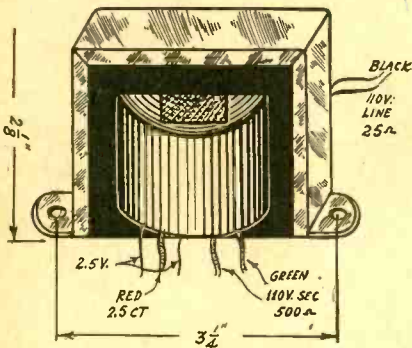

Filament-plate transformer, for oscillators, 1 or 2-tube sets, etc.  
Primary, 110 volts a-c.  
Secondary A, 2.5 volts, center-tapped; stands up to 3 amperes.  
Secondary B, 110 volts, not center-tapped.  
Excellent for test oscillators with a-c in plate.

Price, \$1.10

RADIO WORLD

145 West 45th Street New York, N. Y.

### SOLDERING IRON FREE!

Works on 110-120 volts AC or DC, power, 50 watts. A serviceable iron, with copper tip, 5 ft. cable and male plug. Send \$1.50 for 13 weeks' subscription for Radio World and get these free! Please state if you are renewing existing subscription.

RADIO WORLD

145 West 45th St. N. Y. City

### Subscribers! Important!

Note subscription expiration date on wrapper containing your copy of RADIO WORLD. If nearing expiration date, please send in renewal so that you will not miss any copies. Subscription Dept., RADIO WORLD, 145 W. 45th St., New York City.

"Be Prepared" FOR THE THRILL of YOUR LIFE

## Scout SHORT WAVE RECEIVER 15 to 550 Meters

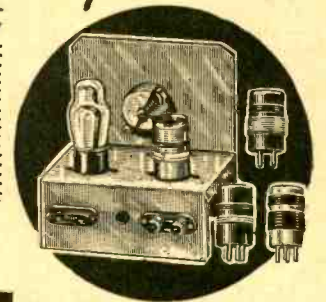

A RECEIVER that will cover the entire short-wave and broadcast band. Amazing the way it intercepts short-wave signals — police signals ship-to-shore signals, airplane conversations, amateurs, etc. An inexpensive way for beginners to master the code by practical experience.

Will out-perform many other one-tube broadcast receivers when used on the 200 to 500 meter band.

It is exceedingly easy to build. A clear diagram shows the layout of parts and hookup of receiver. All parts in the kit are of the highest quality, assuring perfect reception.

Smooth regeneration control does not vary when the different coils are changed. The 230 tube was selected because of its low current consumption on the "A" battery. Two dry cells will last indefinitely without necessitating replacement. One 45-volt "B" battery is required for plate voltage.

USING Hammarlund QUALITY PRODUCT

The kit includes a metal panel and base which gives the receiver a professional touch. The metal panel, used to eliminate hand capacity, is finished in a beautiful, modernistic black crystal.

Model SR-I-K kit of parts . . . . . \$3.95  
Model SR-I-W wired and tested

\$1.00 extra

Set of batteries . . . . . \$1.50  
Set of matched headphones . . . . . 95c

Send for NEW 1934 Catalog FREE

TRY-MO RADIO CO. 85 CORTLANDT ST., NEW YORK, N. Y.

Servicemen's Handy Manual only 25c FREE with kit sold.

### 175 KC TUNING UNIT FREE WITH SUBSCRIPTION

For use with 175 kc intermediate frequency. Unit includes four-gang condenser, three r-f coils, the proper oscillator inductance and 800-1,350 mmfd. padding condenser. Send \$12.00 for two-year subscription and order Cat. SUTU-175, which will be sent postpaid.

Radio World

145 West 45th Street New York City

"THE MODERN GASOLINE AUTOMOBILE," by Victor W. Page, M.S.A.E. New Revised and Up-to-date Edition. A whole library of information now complete in one large octavo volume of 1,146 (6 x 9) pages—1,000 engravings. Bound in flexible scarlet fabrikoid. Price \$5.00. Radio World, 145 W. 45th St., New York, N. Y.

### Quick-Action Classified Advertisements

7c a Word—\$1.00 Minimum

MODERN TUBE INDEX, all tubes, all the dope, all manufacturers, socket connections, everything. Most complete of all. Sheet 21 x 27 inches. Price 25c. RADIO WORLD, 145 West 45th Street, New York, N. Y.

"RADIO TROUBLE SHOOTING," E. R. Haan. 361 pages. 300 illustrations. \$3. RADIO WORLD, 145 W. 45th., N. Y. City.

RADIO WORLD AND RADIO NEWS. Both for one year, \$7.00. Foreign, \$8.50. Radio World, 145 W. 45th St., N. Y. City.

THE FORD MODEL—"A" Car and Model "AA" Truck—Construction, Operation and Repair—Revised New Edition. Ford Car authority. Victor W. Page. 708 pages, 318 illustrations. Price \$2.50. Radio World, 145 W. 45th St., New York.

TELEVISION MOTORS, Discs, Tubes, etc. Confidential prices on request. C. Denney, R. 2, Box 286, Norfolk, Virginia

"SERVICING SUPERHETERODYNES," by John F. Rider. A reliable aid to the service man or to organizations in tackling superhet service problems. 161 pages, canvas cover. Price \$1.00. Radio World 145 W. 45th St., New York, N. Y.

ROLAND BURKE HENNESSY  
Editor

HERMAN BERNARD  
Managing Editor

# RADIO WORLD

REG. U.S. PAT. OFF.

The First and Only National Radio Weekly  
TWELFTH YEAR

J. E. ANDERSON  
Technical Editor

J. MURRAY BARRON  
Advertising Manager

Vol. XXIV

FEBRUARY 3d, 1934

No. 21. Whole No. 619

Published Weekly by Hennessy Radio Publications Corporation, 145 West 45th Street, New York, N. Y.

Editorial and Executive Offices: 145 West 45th Street, New York

Telephone: BR-yant 9-0558

OFFICERS: Roland Burke  
Hennessy, President and  
Treasurer.  
M. B. Hennessy, Vice-Presi-  
dent.  
Herman Bernard, Secre-  
tary.

Entered as second-class matter March, 1922, at the Post Office at New York, N. Y., under Act of March 3, 1879. Title registered in U. S. Patent Office. Printed in the United States of America. We do not assume any responsibility for unsolicited manuscripts, photographs, drawings, etc., although we are careful with them.

Price, 15c per Copy; \$6.00  
per Year by mail. \$1.00 extra  
per year in foreign countries.  
Subscribers' change of ad-  
dress becomes effective two  
weeks after receipt of notice.

## MODULATORS OF R.F.

AS USED IN TEST OSCILLATORS,  
WITH A NEW BEAT METHOD THAT  
GIVES FREQUENCY INDICATION

By Herman Bernard

THE formal method of supplying modulation to an oscillator is to have a separate modulator tube and switch it on or off. Sometimes it is desired not to have the modulation, as when beating with standards, as the zero beat is then more readily established, or at least that low growl that passes for zero beat. It is difficult to get a real zero beat without precision apparatus.

The less expensive and quite serviceable test oscillators have the modulation directly in the oscillator tube, and for universal type oscillators a grid leak and condenser are used of suitably high values to insure grid blocking. This produces the modulation when the test oscillator is used on d.c. or batteries. When it is used on a.c. the line hum supplies the principal modulation and the other is not noticed in comparison.

### Self-Capacity Present

Where a separate modulator tube is used it is usually a triode, and may follow the popular tuned grid type. If no condenser is put across the grid winding there will be audio oscillation, nevertheless. Although no oscillation can be present without capacity, the self-capacity of the winding would be sufficient for the purpose.

The type of transformer for such work is best when it is worst. That is, the worst type for regular audio coupling is the best type for the audio oscillation transformer, because then the oscillation will be readier and the pitch will be high enough. A suitable transformer can be bought for about 50 cents, being of the small, uncased type used in universal midget broadcast receivers. The push-pull input transformer of this type is highly acceptable, as only half the winding will be a favorable selection for the secondary, the other half being left free. Hence the inductance is still lower, which is desirable, as the note will be higher in pitch, and more distinguishable for that reason.

If the push-pull transformer is used the Hartley circuit may be followed, for filament

or heater type tubes, and also the tuned grid type of circuit for audio oscillation may be applied to any tube. It will work well even on a 30-tube with only 7.5 volts on the plate, zero bias on the grid, in which case switch the tube at the filament.

### Avoiding Overload

One precaution is to avoid overloading the radio-frequency oscillator with the modulation voltage. Depending on the negative bias, if any, on the radio-frequency oscillator, the modulation voltage introduced should not exceed one volt less than the bias. A vacuum tube voltmeter will measure the oscillation amplitude, either rms or peak, depending on the hookup used.

Where grid leak and condenser are used in the radio-frequency oscillator there is negative bias, and the average value thereof may be ascertained by introducing negative and positive voltages from a small battery in the non-oscillating r-f grid circuit, to measure the plate current at various values of negative bias. This current may be taken at its steady values and then the r-f oscillator may be set going, the plate current noted at large capacity settings of the tuning condenser, and the amplitude of the oscillation voltage taken from the previous curve as the bias voltage as derived from the leak. Thus the oscillator tube itself is used as VTVM. Then when modulation is introduced at its fullest (even assuming there is a modulation attenuator) the difference between the new voltage, as determined from the plate current in the r-f oscillator, and the plate current without modulation, will give the effect of the modulation voltage, so reduce the modulation coupling until the plate current change does not exceed 20%. A closer method is given elsewhere in this article. The difference between the two factors may be maintained considerably below the voltage as disclosed by the unmodulated test, say, 50 per cent. below.

Without making any such test, the general condition of satisfaction may be reached by

reducing the coupling between modulator and oscillator even at maximum, so that when the r-f oscillator beats with any standard, such as a broadcasting station, there will be a distinctive zero beat at one position only, not a zero beat at one spot on the dial, and another beat close by. That is, as the dial is slowly turned, the pitch of the beat changes from a high audio frequency to a low one and finally to zero, and then, when one continues turning the dial in the same direction, the pitch rises again and passes to heights beyond audibility, without recurrence of drop to low audio frequencies and repetition of the rise, as if there were two stations with which one was beating in succession. This vice denotes over-modulation. Reduce the coupling until such trouble is avoided.

One way of reducing the coupling is to introduce a series resistor, another is to select some element of a tube that of itself produces small coupling, or both methods may be used, as in Fig. 2, which represents a universal a-c and d-c type oscillator with modulated-unmodulated service.

### Method of Introduction

The modulation is introduced into the 6A7 through Grid No. 2, formally the positive-voltage anode of the triode, but here the tube is used in a very special manner, with control grid of pentode (No. 4 grid) tied to triode grid (No. 1), the feedback winding being in the screen circuit. This screen is Grids Nos. 3 and 5 and is between the formal plate and the pentode control grid, as well as between the pentode control grid and Grid No. 2. Electron coupling is used both between modulator and oscillator and between oscillator and output.

From the foregoing it will be understood that the audio oscillation naturally will be large, and that the problem is to keep down the input to the radio-frequency oscillator when modulation is introduced. All the discussion so far dealt with the maximum amplitude of the a-f oscillator being left as it is encountered, but the input to the r-f oscil-

# VACUUM TUBE VOLTMETER

lator from the modulator being limited. That is, the amount of oscillation voltage taken off the modulator for supply to the r-f oscillator is kept down.

Besides that, an attenuator may be introduced, so that even the previously-limited amount of audio oscillation may be reduced practically to zero, and for this purpose a potentiometer of 500,000 ohms serves. The value is not greatly important, so long as it is not too low, otherwise audio oscillation would stop. Not less than 25,000 ohms should be used. Whatever value is selected, it will be found that the resistor increases the pitch a little.

## Compensating Condenser

A condenser is put across the modulation transformer's secondary so that the pitch of modulation, though lowered by that process, will not be changed in the process of tuning the r-f oscillator. If the condenser were omitted from the a-f secondary, then the tuning condenser would be effectively in the a-f circuit, to cause the pitch or frequency of the modulation note to change slightly as the tuning condenser capacity is altered. Therefore, the larger the fixed condenser across the modulation transformer secondary, the less this effect, and 0.01 mfd. will wipe it out completely and lower the frequency considerably, though 0.0024 mfd. is satisfactory.

A few words about the oscillator as a whole now, for the benefit of those who might want to build it. The fundamental frequencies are 135 to 380 kc. A frequency-calibrated dial is commercially obtainable, with proper coil and tuning condenser, so that one does not have to perform his own calibration, save to set the trimmer that is built into the tuning condenser, when beating the test oscillator with any broadcasting station, 1,400 to 1,500 kc.

## Harmonics Used, Too

Harmonics are depended on for intermediate frequencies not within the fundamental range, therefore the frequency-calibrated and direct-reading scale has the indicating points for 400, 450, 456 and 465 kc. The broadcast band is taken care of by the fourth harmonics, and there is a separate complete tier on the scale for this, 540 to 1,520 kc (135x4 to 380x4).

It is not possible to use the scale and coil with any other condenser, nor the scale and condenser with any other coil, as the scale calibration is an expression of the frequency change resulting from the specific capacity changes of that particular condenser in respect to rotor rotation.

The 6A7 connections, being unusual, will be repeated now. Looking at the diagram, the cathode is at left and goes to B minus. Next is the triode control grid (Grid No. 1), which is tied to the pentode control grid (No. 4). The triode Grid No. 2 is used for modulation coupling. There remain the screen (Grids 3 and 5) and the plate. The screen is in the feedback circuit and the connection is taken from a single socket spring, while the plate is used for electron output coupling. The output transformer may be a regular radio-frequency transformer used backwards (large winding in the plate circuit), or may be composed of two small unequal honeycombs, or a 10 mH. honeycomb inside a 20-microhenry solenoid.

## B Supply

The B choke is 30 henries and carries only a few milliamperes. The B filter condensers had better be paper di-electric, to avoid polarity troubles, or, if electrolytic, of the bipolar type, which for the same familiar physical size usually have half the ordinary capacity, because the condensers probably are in series.

If the device is to be put into a metal box, and the box grounded, there should be no conductive connection between the box (ground) and the oscillator proper, otherwise there is danger of shorting the line,

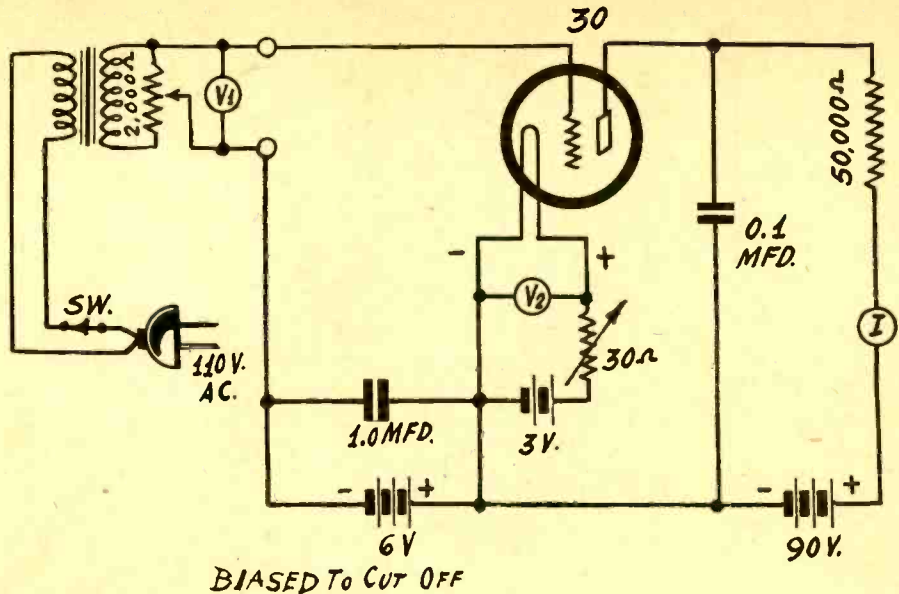

A vacuum tube voltmeter that measures a.c. is shown herewith. It may be used in any sine-wave measurement within range, including measurement of the modulation voltage directly in the modulator tube, r-f oscillation voltage and any other a.c.

A 30 tube has 6 volts negative bias and 90 volts on the plate. The current meter I in the plate circuit may be 0-5 ma, or, for better sensitivity, increase the plate resistor and use a 0-1 milliammeter.

The calibration may be made from the a-c line, using a step-down transformer, to yield about 10 or 15 volts, although only voltages about equal to the bias, or less, may be measured well. A potentiometer takes off as much or as little of this as desired for cali-

bration.  $V_1$ , if a peak voltmeter, yields a calibration in peak volts, the rms values being 0.707 of the peak. If  $V_1$  is an r-m-s voltmeter then the peak is determined by multiplying the rms by 1.41. The meter reading ( $V_1$ ) is the voltage effectively divided, or multiplied.

Steps of  $\frac{1}{2}$  volt may be used, or even 1 volt, by adjusting the potentiometer. The plate current readings are noted for each new input voltage condition. Then a curve is drawn, plotting input voltage against plate current. Whichever type of voltage is plotted thus, a new curve for the other type may be drawn on the basis of the computation just outlined.

which would result in blowing the built-in fuse. Hence B minus is not directly grounded, but is grounded through the 1.0 mfd. condenser.

The series resistor to reduce the line current for the tube heaters is specified as 50 watts, 300 ohms, but any who desire to use a 40-watt lamp may do so, as the resistance of such a lamp is just about right under the current conditions existing in this receiver.

## Neon Tube Audio Oscillator

Instead of a regular radio tube a gas-discharge tube may be used as audio oscillator. A simple solution is found in the neon lamp. This oscillates at audio frequencies, and at low radio frequencies, because of the difference between the striking and the extinguishing voltages. Most lamps of this type have a series resistor built in, which renders direct access to the lamp impossible, but a type is obtainable that does not have the resistor built in, so 10,000 to 50,000 ohms may be used, depending on the voltage, or about 25,000 ohms for a voltage of approximately 110 volts. The lamp strikes at about 70 volts d.c., regardless of the resistance value. It is necessary to put a condenser across only the lamp to produce audio oscillations. The condenser must not be large, for then the frequency will be too low, if the lamp oscillates at all, or the lamp may not even oscillate, because the condenser bypasses too much current. The higher the capacity, the lower the frequency, and a value may be selected that yields the desired note. Try 0.00025 mfd. across the lamp, with 25,000 ohms in series with the lamp, total applied voltage around 100 volts d.c.

## Variable Audio Frequencies

By using a variable condenser across the

lamp the frequency of the modulation may be altered without much change in the amplitude or intensity of the oscillation. A condenser of 0.0002 to 0.0005 mfd. maximum will serve the purpose. The frequency constancy is good enough to warrant calibration, although the frequency changes slightly with voltage, and for greater precision a voltmeter should be included, with a voltage-adjuster, to make the voltage the same any time the audio oscillator is used.

The neon tube audio oscillation may be connected to the r-f oscillator through a condenser, or in the instance of Fig. 1, from the high side of the lamp to Grid No. 2 of the 6A7.

The thermionic vacuum tube, the gas discharge tube and the mechanical oscillator exhaust the popular means of providing audio oscillation. While crystal oscillators could be used, they are not used much, as the crystals for such low frequencies are too expensive and yield only a single frequency.

## A New Suggestion

The next and final presentation will concern a method devised by the author for producing audio modulation by beating, and which yields either frequency steps or, with a large variable condenser, continuously variable frequencies, 0 to 5,000 cycles. The method for continuous frequency variation stiffly requires a variable condenser of 0.005 mfd. maximum to 0.0024 mfd. minimum, if the inductance is 50 millihenries. Since nobody will have such a condenser, the instance of step frequencies of 0, 1,000, 2,000, 3,000, 4,000 and 5,000 cycles will be considered.

Suppose you have a radio-frequency oscillator of any type. Suppose you set up another radio-frequency oscillator, harmonic type, this one generating 10 kc. It could be  
(Continued on next page)

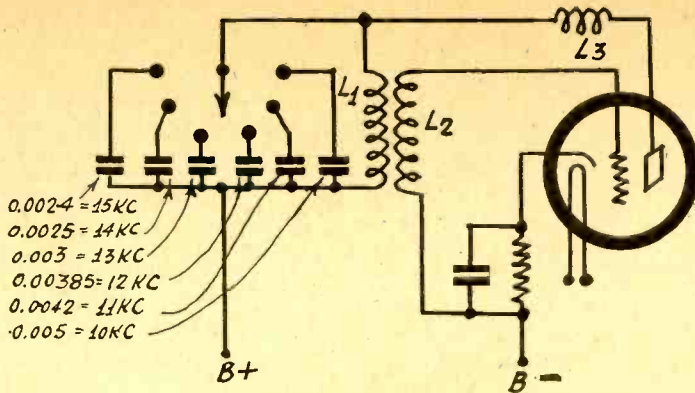

FIG. 1

A stabilized oscillator of the tuned plate type.  $L_3$  is the stabilizer, which works when no grid current flows.

(Continued from preceding page)  
accomplished with any usual feedback circuit, with tuned inductance of 50 millihenries and 0.005 mfd. capacity. Now if the low-frequency oscillator, being of the harmonic-generating type, is coupled to the variably-tuned r-f oscillator, zero beats can be established at all frequencies of the r-f oscillation separated by even tens of kilocycles. This and that side of zero beat there will be the usual higher audio frequencies, as the r-f oscillator dial is slowly turned, so that the exact spot of resonance is obtainable.

**The Six Steps**

As stated before, zero beat is more of a phrase than a fact of actual practice, and therefore the lowest growl results here, as before, and constitutes sufficient modulation for all purposes. The pitch is made as low as possible, and if zero frequency can be established, so much the better.

Now by increasing the frequency of the monitor oscillator in steps of 1,000 cycles (1 kc.), switching in smaller capacities, the pitch that was, say, zero, is raised 1,000 cycles at a time to 5,000 cycles, which is the limit imposed by circumstances as 6,000 cycles would cause a 4,000-cycle beat with the next channel if the r-f oscillator is beating with a broadcasting station and there is stray coupling between monitor and receiver bringing in the station.

**Anderson's Stabilization Plan**

The circuit shown uses a series non-inductively-related coil  $L_3$  equal to the other tuned coil  $L_1$  as a means of stabilizing the frequency. This particular method of stabilization is due to J. E. Anderson and depends for its success on the absence of grid current. Thus, the plate circuit is subjected to double tuning, first, the plate circuit parallel resonance, and, second, the plate circuit series resonance. The frequencies in the two circuits are the same.

Stability arises from the fact that the feedback is in phase with the oscillating current. That is, the current through  $L_3$  is in phase with the current through  $L_1$ . The condenser is in parallel with  $L_1$  and in series with  $L_3$ . There is a step-down transformation,  $L_1$  to  $L_2$ .

Since frequency instability may be defined as a phase shift, if there is zero phase shift, as here, the oscillator will be frequency-stable. Terminal voltage conditions will not change the frequency, neither will the oscillation amplitude wobble.

The inductance  $L_1$  is the 50-millihenry coil,  $L_2$ , inductively related to it may have half that inductance, while  $L_3$ , the stabilizing coil, has the same inductance as  $L_1$ . These coils are commercially obtainable.

**Accuracy Check**

There is still another use for the monitor, and the word monitor suggests, in a way,

what that use is. If the monitor oscillator is exactly 10 kc, and if the frequency is highly stable, the monitor may be used as a standard of frequency. Thus, if one has an oscillator with a frequency-calibrated dial, and there may be 0.05 or so per cent. difference between the frequency read and the frequency generated, the error may be eradicated by setting the r-f oscillator at that point that strikes zero beat with the 10 kc monitor, if the r-f oscillation is a multiple of 10 kc, as it virtually always is. And if the r-f is not a multiple of 10, then it is a multiple of 11, 12, 13, 14 or 15, or close enough, and almost the exact frequency therefore may be present as an harmonic at the r-f level.

**Examples Cited**

Let us take a few examples. First there is the broadcast band. Practically all stations occupy channels that are integral multiples of 10, so use 10 kc and strike zero beats. Those stations on frequencies not integral multiples of 10 have channels sending in 5. Take the Mexican stations in this category as examples:

- XEPN, Piedras Negras, Coahuila. 585 kc.
- XENT, Nuevo Laredo, Tamps.... 1,115 kc.
- XFC, Aguascalientes, Ags..... 805 kc.
- XETN, Matamoras, Tamps..... 845 kc.

The first of these frequencies, 585 kc, is the thirty-ninth multiple of 15, so use 15 kc and zero beat. The second, 1,115 kc, is not a whole-number multiple of any of the six fundamentals obtainable from the monitor, but the eightieth harmonic of 14 kc is 1,120 kc, so tune the r-f oscillator for a 5,000-cycle note 1,115 (1,120 minus 1,115 equals 5), or use the 111th or 112th harmonic of 10 kc for the 5,000-cycle note. The 805 kc frequency is not an integral multiple of any of the six, but the sixty-fifth harmonic of 13 kc may be used, to produce 806 kc, and

the r-f oscillator tuned to strike a note of 1,000 cycles. For 845 kc the sixtieth harmonic of 14 is used for zero beating.

**Another Use**

There is still an additional use for the monitor method. Readers are familiar with the beat oscillators in short-wave superheterodynes. Invariably the extra oscillator is worked at the intermediate level, a bit off the i-f frequency, to yield the note. This serves the intended purpose of giving response from immodulated continuous waves (code), and incidentally for assisting in station-finding generally, as turning on this oscillator causes an audible response every time a carried is tuned in.

Would it not be of some extra advantage if, besides this use as c-w receptor and station-finding, the monitor oscillator would give some frequency disclosure? For short waves, where the frequencies are spoken of in terms of megacycles, of course a 10 kc oscillator-monitor would not be of assistance, but by using small capacity the frequency could be greatly increased. Using the same coil system as before, all we need do to achieve 50 kc is use a capacity of 0.0002 mfd., and to strike 100 kc use 50 mmfd. Differences of 100 kc always are recognizable in short waves within the bands commonly yielding good reception, and for the lower-frequency bands 50 kc differences are useful.

There remains only an exposition of a ready method to use in determining whether the monitor is generating the desired frequencies.

**10 kc. Attained**

Take 10 kc. A selective t-r-f receiver is used. Two stations are kept in mind, separated in frequency channels by a known multiple of 10. Let us take WJZ, 760 kc, and WFAF, 660 kc. The difference is 100 kc. We set up the intended monitor at what we hope is 10 kc, and try to beat with WJZ. No luck. We make an adjustment, perhaps of a small parallel capacity across a fixed condenser, and we get the beat. We know there are ten channels 10 kc apart between the two, and counting the beat at no difference in channels, we thus look for eleven beats. The last one must strike with WFAF. Well, we're out of line. There are 12 beats. The frequency of the monitor is too low. Reduce the parallel capacity.

Now we get eleven heats plus. Plus what, we can't quite say, but more than 11. So we reduce the capacity until we get just eleven beats, the first with WJZ and the last with WFAF. We have been tuning the receiver to do this, and depending on responses from broadcasting stations 10 kc apart, even though the receiver alone would not yield a response as to stations between the two test frequencies. But the beat method improves the workable sensitivity mightily. Or, if need be, we could introduce modulation temporarily in the monitor. We

(Continued on next page)

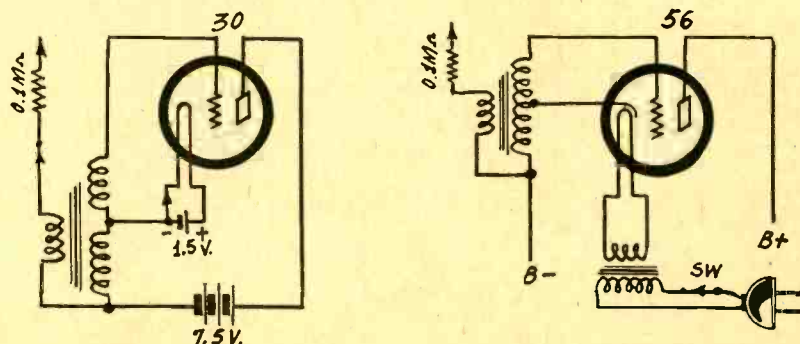

FIG. 3

The Hartley oscillator for audio frequencies. A small push-pull input audio transformer is used—preferably as bad as can be had—and applies to filament type tube (left) or heater type (right). If the heater tube is of the 6.3-volt type a storage battery could supply the heater voltage.

# HOW TONE CONTROLS OPERATE

IN ENGINEERING laboratories efforts are continually being made to improve quality of receivers. At least in one part of the laboratory. In another part, or in some other laboratory, efforts are being made to spoil it. Efforts in both directions are being successful. But what is the object of spoiling the quality? Well, thereby hangs a tale.

Devices for spoiling quality are spoken of euphemistically as tone controls. They are devices which enable the operator of a radio receiver to spoil the quality in any degree that pleases his fancy, or his own judgment of what constitutes good quality. The idea back of this is that what pleases one man may not please another. When a person is operating a radio receiver, he is not compelled to accept what the maestro thinks he ought to have in the way of music, but he can have, to a certain degree at least, what he wants. It is true he cannot subdue any given instrument in the orchestra, nor can he change the rhythm, nor can he give a humble musician in the orchestra a cross look when his contribution does not please him; but he can bring out the basses as a whole, or the treble. He can suppress all those noises which are present in a radio receiver when they interfere with the music. That is the object of tone controls—to enable the listener to get what he likes in this respect as well as the stations he wants.

## How They Work

Nearly all tone controls work on the principle that they reduce the strength of the signal of the notes, or range of notes, not wanted for the time being. They rarely build up what is most desired. Whether they do one thing or the other is of little consequence, for if the operation of the tone control reduces the volume of all the notes

in the signal, it is only necessary to give the volume control a touch, and the desired strength is back.

All tone controls take advantage of the difference between condensers and inductances. If a condenser is put in series with a line carrying the signal current, all the low frequencies will be suppressed more than the high frequencies. Very low frequencies will be stopped entirely; very high will hardly be stopped at all. The degree of suppression is inversely proportional to the frequency.

Now if an inductance is put in series with the line carrying the signal current, all the high frequencies will be suppressed and all the low will go through practically unchanged. The suppression is directly proportional to the frequency.

It is also possible to connect the devices across the line. Suppose a condenser is connected across the line where a certain signal voltage exists. The voltage will drop, and therefore the reproduction of the high frequencies will be decreased. The decrease is proportional to the frequency and also to the capacity. If a coil is connected in the same position across the line, the low frequencies will be reduced in strength and the highs will come through practically unchanged. The suppression of the low frequencies will be greater the smaller the inductance.

A coil in series with the line is practically equivalent to a capacity across the line, that is, both decrease the transmission of the higher frequencies. A condenser in series with the line is practically equivalent to a coil in shunt with the line. Both reduce the transmission of the low notes.

## Usual Practice

The usual practice is to put a condenser across the line to reduce the transmission of the high frequencies, for by tone control is usually meant the suppression of the higher frequencies in comparison with the lower. The tone could be controlled in this manner by varying the capacity of the condenser, but this is seldom done. The usual practice is to connect a variable resistor in series with the condenser and then vary the

resistance. This has the same effect as varying the capacity, for when the resistance in series with the condenser is high very little of the signal can be by-passed. But when the resistance is small the condenser by-passes the higher frequencies, the by-passing being greater the higher the frequency, the greater the capacity of the condenser, and the lower the resistance. Thus the resistor and capacity combination across the line provides a means for controlling the tone by cutting out more or less of the high frequencies.

Where the combination of resistor and condenser is put across the line does not make much difference. The effect is about the same in one place as in another. There is a difference, however, depending on the impedances involved. Suppose the combination tone control is put across the line at the grid, where there may be a high resistance grid leak or a high impedance secondary of a transformer. If the resistance in the tone control is lower than the grid leak or the impedance of the transformer, all notes will be reduced, not only the high. This, of course, is true wherever the tone control is placed, but it is not true in the same degree.

If a tone control consisting of a resistance and condenser in series is put across the line at the loudspeaker voice coil, it will have very little effect, because the impedances involved here are very much smaller than those in the grid circuit. It is for this reason that many different combinations are used for tone controls. When the combination is put in a grid circuit, the resistance in shunt with the condenser should be high, comparable with the grid leak resistance. If it is put across the line in the plate circuit of the power tubes, the resistance should be lower, for here the impedances are much lower. Even the condenser should be varied according to the impedance of the line where the tone control is connected. A resistance of half a megohm might be used in series with a condenser of 0.02 when the tone control is put in shunt with a grid leak of half megohm and a resistance of 25,000 ohms in series with a 0.1 mfd. condenser when the combination is put in shunt with the output of the power stage.

## MODULATORS OF R.F.

(Continued from preceding page)

might even have a modulating adjunct, and switch the modulation on and off, and even from r-f to oscillator to monitor oscillator, as desired.

Getting 11, 12, 13, 14 and 15 kc fundamentals is not so easy, only because the choice of frequency-standard stations is restricted. Here a frequency-calibrated dial on the t-r-f set, accurate beyond commercial practice, is helpful indeed. Anyway, we should get tenth-harmonic stations, 1,100, 1,200, 1,300, 1,400 and 1,500 kc, and count the beats between each of these points for each low-frequency sought, and some point on the set dial exactly at what we want. We could check 11 kc at 550 kc, 12 kc at 600 kc, 13 kc at 650 kc, 14 kc at 700 kc and 15 kc at 750 kc, these being fiftieth harmonics. Using broadcasting stations as standards, all the monitor fundamentals, 10, 11, 12, 13, 14, 15, 50 and 100 kc may be checked.

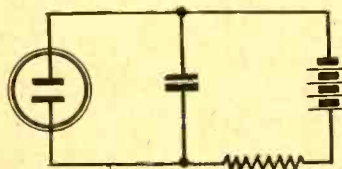

The neon tube audio oscillator at left. The type of tube without series resistor built in is needed, so the condenser can be put across the tube. At right, tube with built-in resistor has only one anode directly accessible.

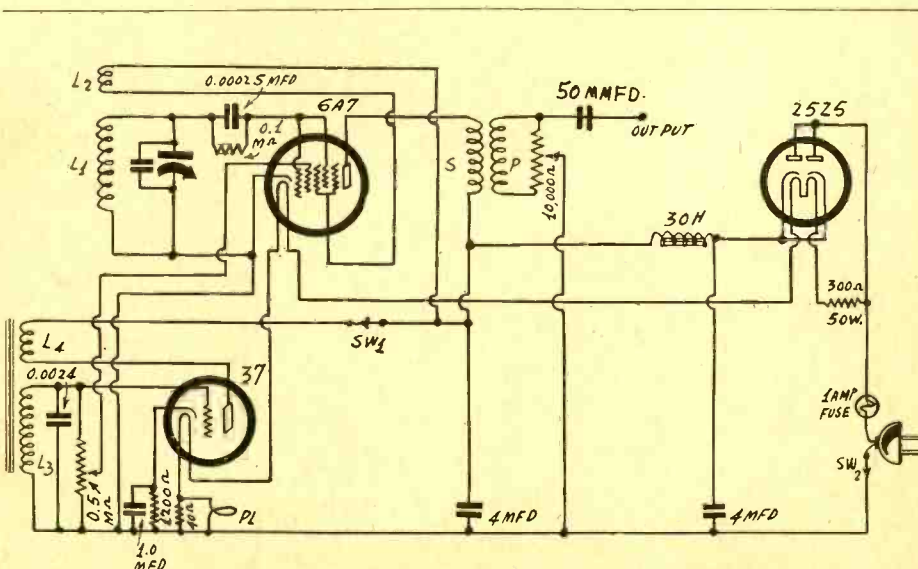

FIG. 2

A test oscillator, 135 to 380 kc, with separate modulator and a B supply for a.c., with rectifier floated on the line for d.c. Thus this is a "universal" type, but can not be worked economically on batteries.

# GREATEST ECONOMY

## FOR POWERING FILAMENTS OF BATTERY SETS IS ACHIEVED WITH USE OF STORAGE CELLS

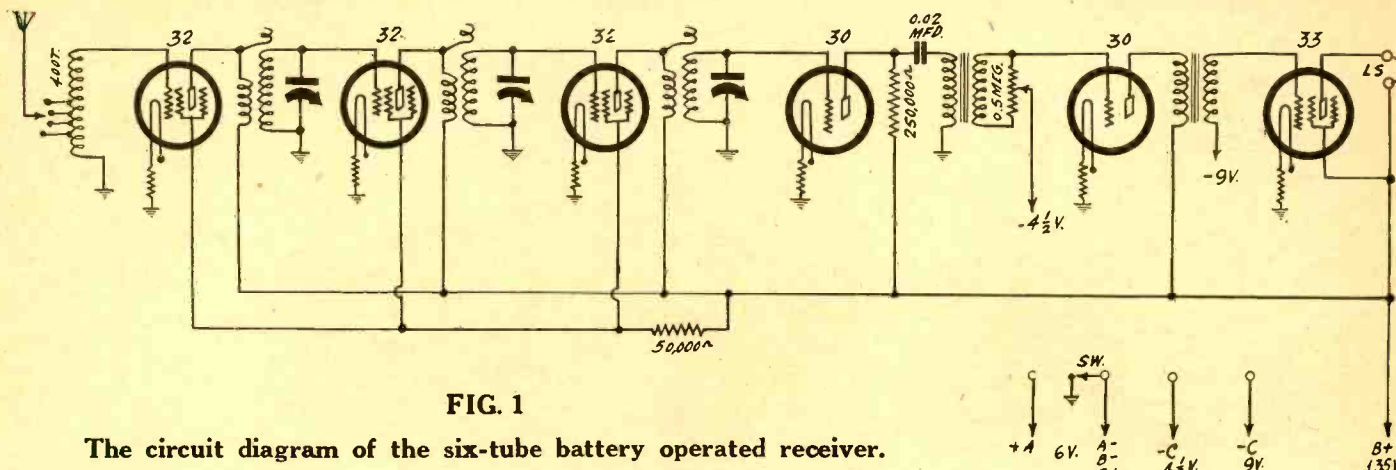

FIG. 1

The circuit diagram of the six-tube battery operated receiver.

THE most economical way of running a battery set, says W. Pelham, New Harmony, Ind., who has suggested the six-tube receiver shown in Fig. 1, is to employ a six-volt storage battery, and we agree with him. While the storage battery is a little inconvenient it is not expensive to run. A charge, which can be obtained at any automobile service station, will last a long time. Indeed, it is not the receiver that discharges it entirely, but rather the leakage over the top of the battery contributes heavily to the result. When a battery is used, it should be watched carefully, for if it is allowed to run down, it will become ruined to the extent that it will no longer take a charge.

Let us examine the circuit suggested by Mr. Pelham. In each filament circuit is a limiting resistor, and it is placed in the negative leg. Therefore the drop serves not only to limit the filament current but it also serves to provide the required grid bias. One resistor is used for each tube as a matter of safety. If a tube is pulled out of its socket, the currents in the remaining tubes will not change, but will remain at the proper value. This would not be the case if a common ballast were used, for then the current would increase in all the remaining tubes, and if several of the tubes were pulled out, those remaining might possibly burn out.

### Values of Resistors

Each of the first five tubes requires a filament current of 0.06 ampere and a terminal voltage of 2 volts. Since the mean voltage of the storage battery is 6 volts, approximately the ballast should be chosen so that the drop in it is 4 volts when the current is 0.06 ampere. Therefore the resistance should be  $4/0.06$ , or 67 ohms. Resistances of this value can easily be obtained, wirewound. It may be necessary to start with 75-ohm resistances and to cut down the wire until the resistance is just right, which should be done either with the aid of a voltmeter, adjusting until the filament voltage is 2 volts, or with an ammeter, adjusting until the current is 0.06 ampere. The adjustment should be made when the battery voltage is normal. Of course, the adjustment can also be done with the aid of an ohmmeter, when the resistance should be adjusted to 67 ohms.

The output tube takes the same filament voltage as the others but the current is 0.26 ampere. Therefore the bal-

last resistor for this tube should be  $4/0.26$ , or 15.4 ohms.

The bias provided for each tube by the ballast is 4 volts. This is slightly too much for the 32s, but not so much in excess that the tubes will not work well. It is not worth while to split the ballast resistance so that part of it is in the positive leg just to provide the nominal bias of 3 volts, which is ordinarily recommended for this tube. This is sufficient amplification in the radio frequency amplifier with a 4-volt bias.

### Audio Bias

The bias on the 30 detector is also four volts. This might be increased to advantage if grid bias detection is to be used. But to increase it, the grid would have to be returned to a point on the grid battery instead of to ground, as in the figure.

It would be necessary either to use a stopping condenser and grid leak or to put a large by-pass condenser (0.1 mfd.) between the coil and ground, and then run to coil to the bias.

As an amplifier with 135 volts in the plate circuit, the bias on the 30 should be 9 volts. If the grid return be made to a point 4.5 volts negative on the grid battery, the effective bias will be 8.5 volts, which is all right. The 33 takes a bias of 13.5 volts when the plate and screen voltages are 135 volts. If the grid return be made to a point 9 volts negative on the battery the effective bias is 13 volts, which is all right.

### The R-F Amplifier

The coupling between the antenna and the first tube is a little out of the ordinary. Between the grid and ground is a 400-turn choke coil, tapped at every fortieth turn for half the way from the ground end. By means of a switch the antenna can be connected to any one of these taps. Thus for any antenna and any frequency within the range of the tuner, an efficient coupling can be found, that is, a coupling that will nearly tune the antenna circuit. In addition to this partial tuning, there is a step-up ratio so that the voltage is increased. The switch also serves as a step volume control.

Following the first tube is a three-stage r-f amplifier with high gain coils. Selectivity is assured by having three tuners, all unaffected by the resistance in the antenna. High sensitivity is assured not only by the use of three high-gain coils but also by the use of three 32 screen grid tubes.

### The Audio Amplifier

In the plate circuit of the 30 detector we have a 250,000-ohm coupling resistor for feeding the plate. The primary of the audio transformer is coupled to the plate through a 0.02 mfd. condenser. Thus the d-c component of the plate current is kept out of the transformer primary and a high grade transformer can be used without danger of saturating the core. It would be desirable to increase the capacity of the stopping condenser to one microfarad if it is important to reproduce the low audio frequencies as well as the high. But if a good transformer is used, one that has a high primary inductance, the 0.02 mfd. condenser will allow good response on all the essential low notes.

The volume control is put in the grid  
(Continued on page 11)

## LIST OF PARTS

### Coils

- One 400-turn choke tapped every 40 turns for half the way.
- Three high gain, shielded coils for 350 mmfd. tuning condensers.
- Two interstage audio frequency transformers.

### Condensers

- One gang of three 350 mmfd. tuning condensers.
- One 0.02 mfd. fixed condenser.
- One 0.1 mfd. by-pass condenser (optional)

### Resistors

- Five 67-ohm, wirewound ballast resistors
- One 15.4-ohm, wirewound resistor.
- One 50,000-ohm resistor.
- One 250,000-ohm resistor.
- One half-megohm potentiometer.

### Other Requirements

- One four or five point switch for antenna coupler.
- One filament switch.
- One vernier dial.
- Five four-contact sockets.
- One five-contact socket.
- Three grid clips.
- One chassis.
- One magnetic or magnetic dynamic speaker with 7,000-ohm impedance.
- One six-volt storage battery.
- One 9-volt grid battery.
- One 135-volt plate battery.



# NEW RATING FOR 48

## MUTUAL CONDUCTANCE INCREASED ABOUT 25%, POWER OUTPUT UP AT 2 WATTS NOW

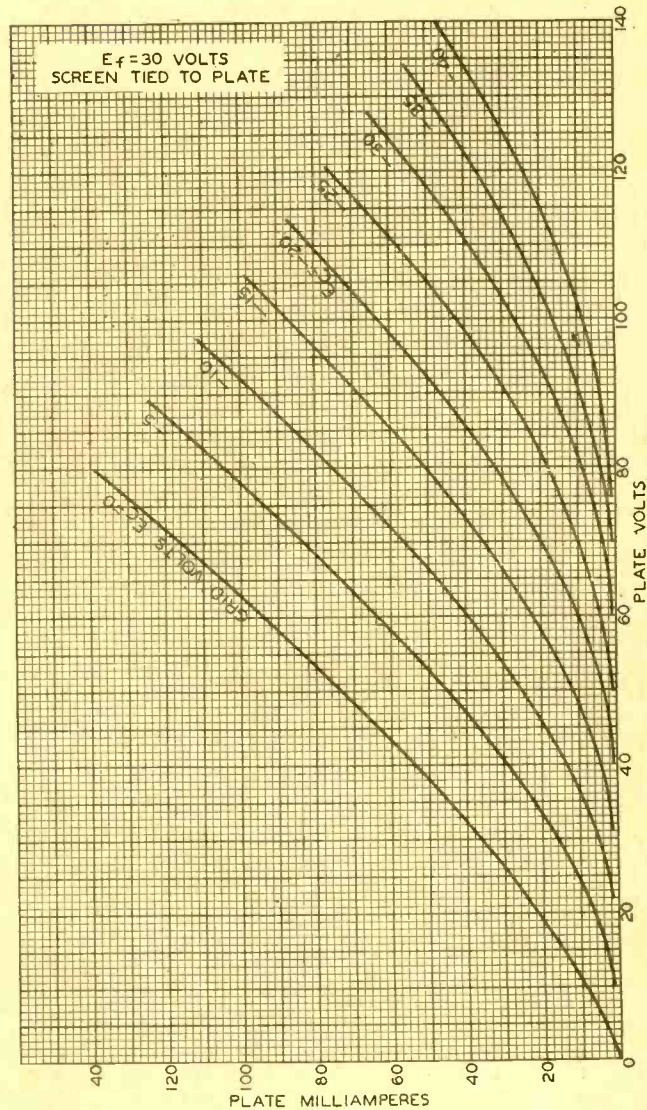
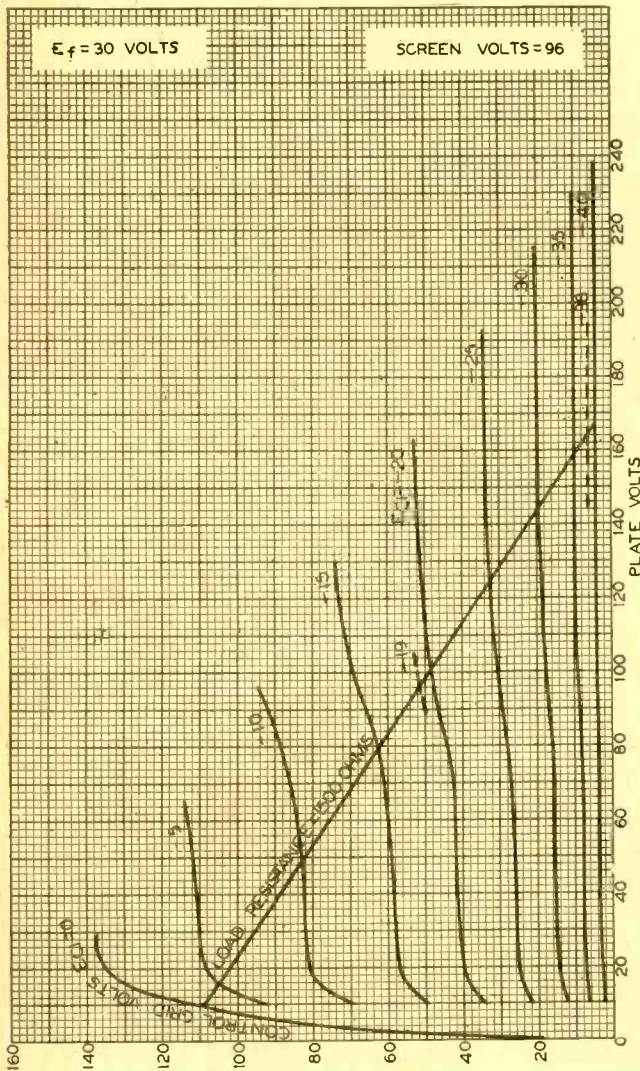

FIG. 1

FIG. 2

Average plate characteristics of push-pull 48's. At left the usual tetrode use is analyzed, at right the results of tying screen to plate are shown.

THE 48 is a tetrode designed for use as a power amplifier in receivers operated from d-c power lines. New ratings for this tube are given on the basis of control-grid-voltage values of -19 and -20 volts for plate-supply voltages of 96 and 125 volts, respectively. The characteristics for these conditions are:

Heater voltage....	30	30	volts
Heater current....	0.4	0.4	ampere
Plate voltage.....	96	125 max.	volts
Screen voltage.....	96	100 max.	volts
Control grid volt..	-19	-20	volts
Plate current.....	52	56	milliamperes
Screen current....	9	9.5	milliamperes
Mutual conduct....	3800	3900	micromhos
Power output.....	2.0	2.5	watts
Harmonic distort...	9.0	9.0	per cent
Load resistance...	1,500	1,500	ohms

From the above tabulation, it will be noted, in comparison with the former values, that the mutual conductance has been increased to 3,800 and 3,900 micromhos, that there has been a slight increase in plate cur-

rent, and that the power output has been increased to 2 watts. The new recommended value of load resistance is 1,500 ohms. Type 48's with the new ratings are interchangeable with those having the former ratings.

In addition to its use as a tetrode, the 48 offers advantages as a triode in push-pull circuits. Average plate characteristics as a tetrode are shown in Fig. 1, and as a triode (with the screen tied to the plate), in Fig. 2. The advantages of one type of operation over the other depend on requirements for power output and distortion. To illustrate this, values for each method of operation using two 48's in a push-pull Class A amplifier follow:

Operated	Plate Volts	Control Grid Volts	Power Output Watts	Maximum Distortion Per Cent
Triodes ..	125	-32.5	3	3
Tetrodes..	125	-20.0	5	9

When it is desired to use the maximum

available line-supply voltage on the plate of the 48, grid-bias voltage may be supplied by means of a C-bias battery. A battery for this purpose need be replaced only at very infrequent intervals. Its use makes available considerably larger audio output. When the use of a bias battery is not feasible, a self-bias or fixed-bias method may be utilized, say RCA Radiotron Co., Inc., and E. T. Cunningham, Inc.

The 48 has a high-emission cathode which can be used to supply more plate and screen current than is generally demanded of the tube as an amplifier. It therefore finds application for use with current-operated devices such as relays. The recommended maximum power which may be dissipated by the plate and screen for the tetrode connection is eight watts. This same value is also the recommended plate dissipation for the triode connection.

# TONE CONTROL VALUES

## LOSS IN DECIBELS FOR VARIOUS COMBINATIONS OF RESISTANCE AND CAPACITY IN SERIES AND PARALLEL RESONANT FILTERS

By M. N. Beitman

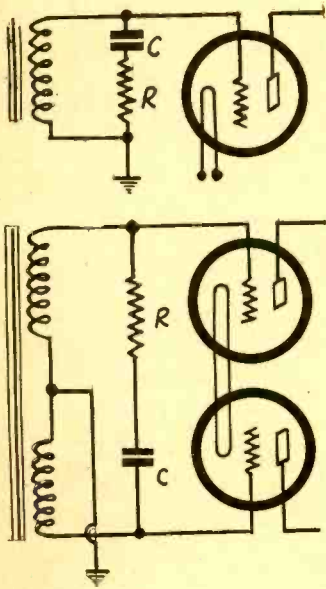

FIG. 1

A series-connected tone control circuit comprising C and R, put in parallel with the line, reduces the intensity of high audio frequencies particularly.

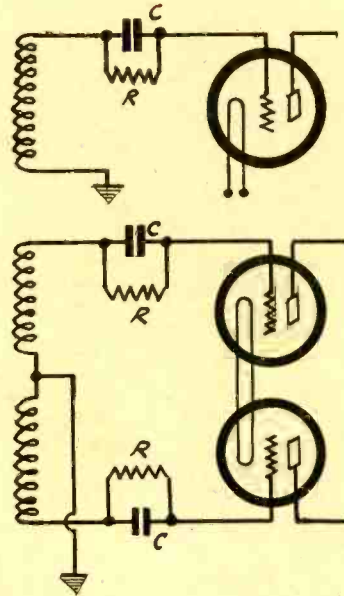

FIG. 2

The parallel resonance of C and R in these examples for single-sided and push-pull circuits reduces the low-frequency response.

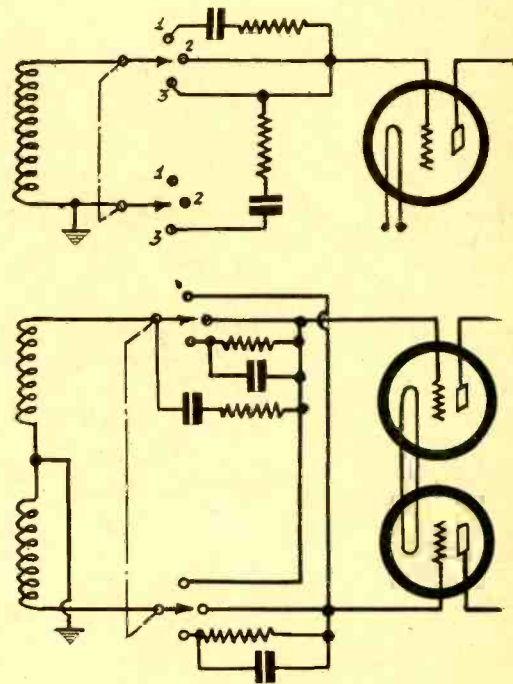

FIG. 3

If the tone control is a switching system such as this both the reduction of highs and lows is accomplished, with one position for total omission of tone control from circuit.

A TONE control is a device for reducing the signals of a certain group of frequencies and thereby bringing out the remaining frequencies. Judging by the present use of tone controls we may draw the conclusion that it is an excellent addition to a radio set. Individual taste and the type of program vary the demands for either the suppression of the high or bass notes. Also some sets, because of their poor design, will stress notes of a certain frequency, and a tone control may be useful here to overcome this difficulty. For the above reasons it becomes desirable to add a tone control to sets not already equipped with this feature.

The usual tone control in modern use has three positions corresponding to three different tone reproductions. One position is to attenuate (reduce) high frequencies, another to attenuate the low notes, and the third to give the set its natural reproduction.

### Stressing Bass Notes

If a high resistance and a condenser in series are shunted across the secondary of the transformer used as the input to the power tube or tubes, as in Fig. 1, high-frequency currents will be bypassed approximately in proportion to the frequency. This will, of course, bring out

the bass notes. The loss in decibels for any frequency  $f$  may be expressed by the formula below if we consider the standard of comparison the lowest audible frequency, 16 cycles.

$$DB = 5 \log \frac{(6.28 CR)^2 + 0.0039}{(6.28 CR)^2 + \frac{1}{f^2}}$$

where  $C$  = capacity in farads.  
 $R$  = resistance in ohms.  
 $f$  = audio frequency at which the loss is computed.

Making  $R$  large and  $C$  small will cause only the very high audio frequencies to be cut off or reduced, while the low and medium notes will appear unchanged in intensity. On the other hand, if  $R$  is made small and  $C$  is made large not only will the high notes be cut off but the medium frequencies will be reduced considerably. This will bring out the bass notes. A desirable medium should be found. Graph I, illustrating the loss in DB for a number of values of  $R$  and  $C$ , will make this clear. A good value to use is  $R = 150,000$  ohms,  $C = 0.01$  mfd.

### Bringing Out the High Notes

To bring out the higher frequencies a parallel resonant circuit is used, Fig. 2. The effects are just reversed from the

previous case. The formula representing the loss is:

$$DB = 10 \log \frac{31,400 RC + 1}{6.28 RCf + 1}$$

where the symbols are the same as before, and the standard of comparison is 5,000 cycles. Curves for a number of values of  $R$  and  $C$  are plotted in Graph II. This will illustrate the effect of the different values for the resistance and capacity. In this case also suitable values for  $R$  and  $C$  must be chosen. Suggested values are  $R = 250,000$  ohms and  $C = 0.001$  mfd. See Graph II for comparison.

### Volume Reduced a Bit

The tone control may be connected as shown in Fig. 3. A three-way double-pole switch may be used for control purposes in either single or push-pull power amplifiers.

In using this tone control one must remember that because of their design these filters will reduce the over-all volume somewhat and thereby will necessitate the readjustment of the volume control.

[The graphs referred to in this article will be found on the opposite page.]

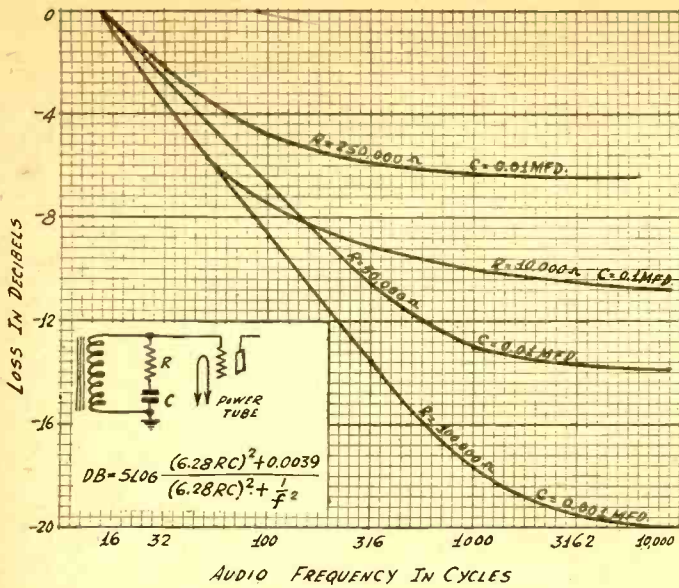

Graph I, at left, loss in decibels for various values of C and R in Fig. 1.

Graph II, above, plotting done for the type of control illustrated in Fig. 2.

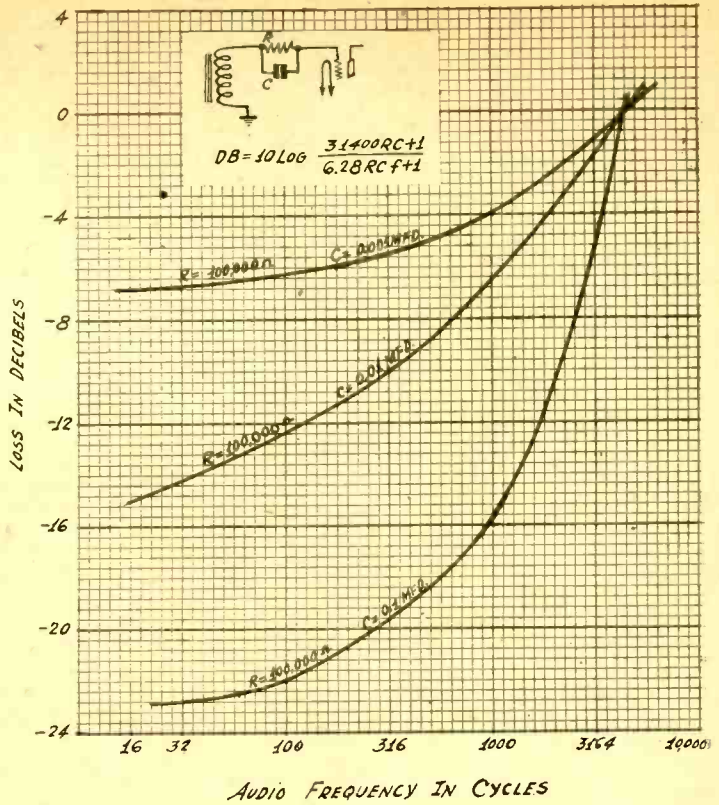

## High Gain Audio in Battery Set

(Continued from page 8)

circuit of the first audio tube. It takes the form of a half-megohm potentiometer across the secondary of the transformer, with the slider on the ground side. If this potentiometer is of the tapered type and the slow taper is put near the grid side, it is possible to reduce the volume to inaudibility.

### High Step-up

Another audio transformer is employed between the 30 and the 33 power tube. In view of the fact that we have two audio transformers, in each of which there is a comparatively high voltage step-up, and a power pentode output tube, the gain in the audio amplifier is very high. Yet it is easily controllable by means of the potentiometer.

The voltage applied to all the plates and to the screen of the power tube is 135 volts, supplied by batteries. This is high enough to insure an output power of 0.7

watt, assuming that the speaker used is such as to put a load of 7,000 ohms on the pentode. The voltage is also high enough to insure a high gain in the radio frequency amplifier and an output from the 30 amplifier to load up the 33 without itself overloading.

### By-pass Value

The voltage on the screen of the 32s is 67.5 volts, which is obtained from the 135-volt battery by a drop in a 50,000-ohm resistor. It would be desirable to by-pass the screens to ground with a condenser of not less than 0.1 mfd. capacity.

The filament supply voltage, of course, is six volts. The filament switch is placed in the negative leg of the battery, and the three batteries, A, B, and C, are connected so that the switch opens all of them at the same time.

A tone control may be connected in the plate circuit of the first audio tube if de-

sired. It may consist of a condenser of 0.03 mfd. capacity, approximately, and a variable resistor of 50,000 ohms, the two connected in series between the plate of the 30 and ground. The variable resistor should be on the ground side.

The total filament current required by this set is 0.56 ampere, nearly half of which is taken by the last tube. A six-volt, 100-ampere hour battery will deliver this current for about 200 hours, assuming that it does not stand idle most of the time so that the battery is discharged through leakage, and also assuming that it is fully charged at the beginning. Suppose that, on the average, it requires 100 hours of actual use of the set for the battery to run down. If the set is used four hours a day, it would take about a month for a charge to become spent. The cost of charging is around one dollar. A little would have to be added for plate and grid batteries, but even so the cost of operating such a set is low.

### Scanning of Sound Film

IN WHAT way does the quality of sound reproduced from a sound film depend on the width of the scanning slit as related to the length of the wave on the film? Does it require a narrower slit to reproduce the high frequencies, or vice versa? What happens when the width of the scanning line is equal to the wave length on the film, or half the wavelength?—W.L.S.

The narrower the film the more will the high frequencies be brought out. When the width of the slit, measured in the direction of the length of the film, is equal to half wavelength, there is no reproduction. This happens again when the slit is one wave, or any whole multiple of half a wave. The slit must be so narrow that the half wave length for the highest frequency sound to be reproduced is small compared with the width of the slit. The drop in intensity is rapid as the half wave is approached and it suffices to place the first cut off just above the highest frequency to be reproduced. The more rapidly the film moves, the longer will be

the wave for a given frequency. It is for this reason that films were speeded up when sound was placed on them. It is more practical to do it this way than to make the slit sufficiently narrow.

### Principle of Tone Controls

WHAT is the principle upon which tone controls work? Is the amplification of the notes not wanted reduced or is that on the wanted notes intensified. Is tone control an admission that the tone is not natural or is it a concession to those who think they know tone better than the engineers?—E. W. T.

Most tone controls work on the principle of reducing the amplification of the notes not wanted. In effect it is a detuning of these notes. Some work the other way, but they are hardly practical in an ordinary receiver. Tone controls are installed in receivers in which the quality is as nearly perfect as it can be made. They are used to enable the listener to select his own quality.

### Nussbaum Expands

The Nussbaum new unit known as Rockefeller Center Radio Shop in Rockefeller Center, New York City, opened its doors last week. Here is New York's radio store DeLuxe in appointments. As one enters from Sixth Avenue through a foyer, on each side of which are two well arranged display windows a feeling of rest and friendliness prevails. The style of tables, display counter and fitting are modified moderne in the darker shades, with pleasing lighting effects that are well placed, giving ample illumination, without the glaring beams, this with the rich deep nap rust colored carpets that reach from the main entrance to the extreme rear of the store, makes this newer radio saloon a place of real charm. An RCA Antennaless system has been installed which permits the operation of all units from the one aerial, without interference. Here unlike most radio stores, reception is a real treat, covering the entire broadcast band.



# THE SUPER WITH SWITCH

## AMPLIFIER IN EASY-TUNING SET THAT VOLUME CONTROL

M.

Thor Radio Company

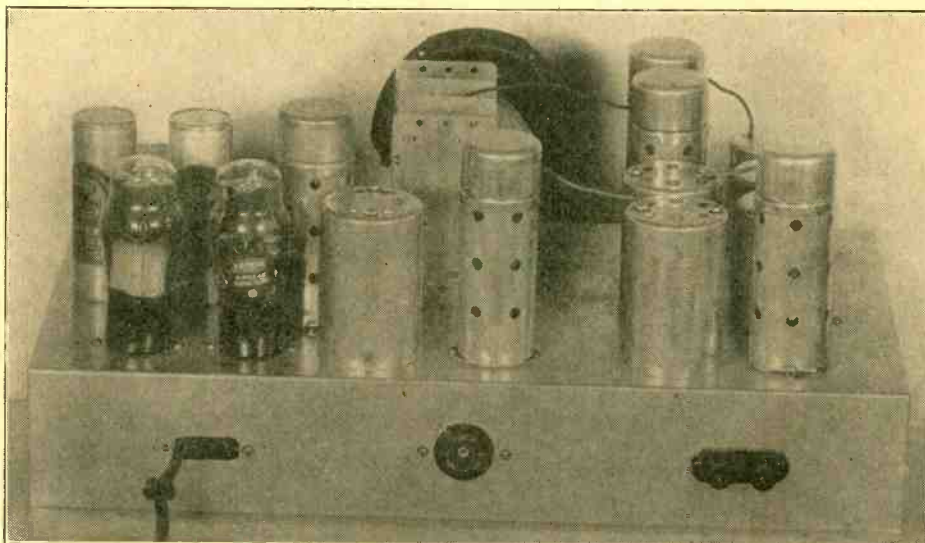

Rear view of the all-wave receiver.

and cathode circuits, by-passing each as the resistor is soldered in place. Now clean up the bottom of the chassis by wiring all leads from the i-f transformers to their respective locations.

We are now ready to mount the short-wave coils and switch. The switch is bolted to the front panel next to the 0.00014 midget variable condenser. The coils are mounted by bolting lugs to the chassis, the lugs bent up and soldered to the ground lugs on each end. The plate return leads are all wired together and run to B plus through a 20,000 ohm-one-watt resistor which is by-passed by a 0.25 mfd. 400-volt condenser.

The grid connection for the oscillator is the rear deck of the switch. The lead from one 0.00035 mfd. section of the variable condenser is connected to the single lug on this deck through a 0.00025 mfd. mica condenser which is shunted with a 0.00014 mfd. neutralizing type condenser.

This is the padding section and any deviation from the specified values will result in many squeals and bleeps that will be impossible to tune out.

### Unusual Aerial Circuit

The third deck of the switch is for the oscillator plate leads, the second for the detector grids and the first for the short-wave pre-selector. This pre-selector circuit is tuned with the 0.00014 mfd. midget.

The aerial circuit is rather unusual, so a word about it at this time may not be amiss. The connection to the broadcast antenna coil is made through a 0.0005 mica condenser. The short-wave connection is made by twisting a piece of hookup wire around the aerial lead, (usually three turns are sufficient) and connecting to the stator of the 0.00014 midget.

Now, if this is the last part of the wiring to be done, as was the case with the author, turn the set over and solder leads to all grid clips.

Put all tubes in their respective sockets, plug in the speaker and proceed with all adjustments. Use a good test oscillator and

peak the i-f transformers at 465 kc. Next tune in a broadcast station and align the r.f., detector and oscillator circuits at about 1,000 kc. When this is completed you should be able to get stations with proper selectivity all over the band. Closer tracking may be established by following the method outlined in last week's article on the new 8-tube Pathfinder by Robert Herzog.

### Short-Wave Bands

We are now ready to try the short-wave bands. Turn the switch one position to the left, assuming that you wired the coils, left to right, that is; low on the left and high on the right, you should now be able to get a few broadcast stations around 100 on the dial. Move down the band and you can receive police reports from all over the country and the 160-meter amateur phone stations. The next lower band is for the good "catches" at this time of year. The best foreign broadcasts come in on this band, and most with very good volume and clarity. The next and last band is one that will be found to give best results in the daylight hours. Use the midget variable condenser as a trimmer on all short-wave bands. Keep the tone control on the Bass position to minimize the background noise on shortwave.

If all instructions have been followed carefully, the builder will have a set he may well be proud of and one that will give world-wide reception.

### Whence the Name

The wiring diagram on this page gives particulars of constants, including revelation of the switching methods, and the path for the carrier from antenna to modulator due to mutual inductive coupling of coils. The front-cover illustration and the rear view on this page give all required data on layout of parts.

The receiver has been made ready after much experimenting at Thor's headquarters laboratory and is called the Thorax for that reason.

Demonstrations have been popular.

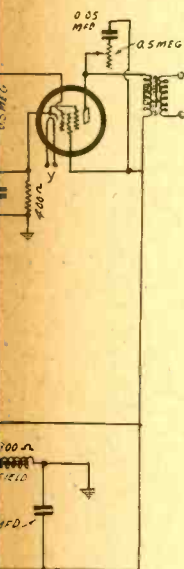

### tuning condenser of this switch input of the modulator.

Lead or positive leads from the 8 mfd. electrolytic condensers connect to this same terminal.

The next operation is to wire all screen

### PARTS

- Four 20,000-ohm, one-watt resistors.
- Two 600-ohm, one-watt resistors.
- Five 500,000-ohm, one-watt resistors.
- One 300-ohm, one-watt resistor.
- One 2,500-ohm, one-watt resistor.
- One 1,000-ohm, one-watt resistor.
- One 250,000-ohm, one-watt resistor.
- One 20,000-ohm, two-watt resistor.
- One 30,000-ohm, two-watt resistor.
- One 400-ohm, five-watt resistor.

### OTHER REQUIREMENTS

- One 2A5 socket.
- One 2A6 socket.
- One 2A7 socket.
- Three 58 sockets.
- One 80 socket.
- One speaker socket.
- Five tube shields.
- One extra shaft and bushing.
- One four deck, four position switch.
- One dial.
- One chassis (10" x 18").
- One line cord.
- Grid caps and hardware.
- One special bracket for mounting the volume control.

# PIEZO CRYSTALS

WHY QUARTZ OSCILLATES AND HOW THE CUT DETERMINES THE FREQUENCY—USE IN SUPERHETERODYNE INTERMEDIATES

*Percy Warren*

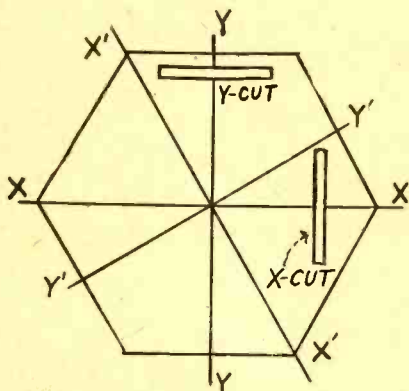

FIG. 1

This represents the cross section of a quartz crystal cut at right angles to the optic axis. The X- and Y-axes are indicated.

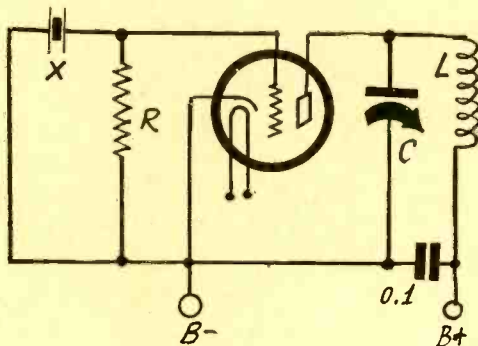

FIG. 2

A quartz controlled oscillator in which the crystal is placed in the grid circuit.

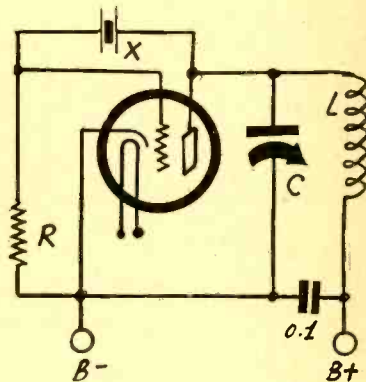

FIG. 3

A quartz crystal oscillator in which the crystal is connected between the grid and the plate.

EVERY radio transmitter that pretends to hold its frequency constant utilizes a quartz crystal as oscillator, stabilizer, or monitor. The quartz crystal is usually a little slab cut out of the rough measuring approximately one inch square, although it is often slightly longer on one direction than in the other. The thickness of the crystal depends on the frequency at which it is to work, for the oscillation used is that determined by the thickness dimension.

A quartz crystal in the rough is hexagonal in cross section. It may be six inches long, more or less. At the two ends it tapers off to points, the cross section remaining hexagonal. Of course, not all crystals are perfect as to shape. The line between the tips is called the optic axis, or the Z-axis when the application is to oscillators and resonators. The line through the Z-axis at right angles to the plate faces of the crystal is called the Y-axis and the line through the Z-axis and through the vertices of the hexagon, the X-axis. A cross section of a crystal is represented in Fig. 1, in which the X- and Y-axes are shown. The Z-axis is through the center of the figure at right angles to the paper.

## Crystal Cuts

A slab cut parallel to the Z-axis and at right angles to the Y-axis is called an X-cut, and a slab cut parallel to the Z-axis and at right angles to the Y-axis is called a Y-cut, or a 30-degree cut. The two typical cuts are shown in the figure. The plane of the X-cut crystal is parallel to the Y-axis as well as to the Z axis and the plane of the Y-cut crystal is parallel to the X- and Z-axes.

The term wave constant has been applied to the characteristic of a quartz plate which determines the wavelength of the generated wave as a function of the thickness of the plate. Thus an X-cut crystal has a wave constant varying between 103 and 107 meters per millimeter

thickness and a Y-cut crystal has a wave constant varying between 130 and 175 meters per millimeter thickness.

The cause of the variation is not so much differences in the quartz, for the characteristics of pure crystallized quartz are undoubtedly constant, as differences in the cuts. Perhaps one crystal is not cut exactly parallel with the Z-axis, and that would have a different wave constant from one cut true. Again, an X-cut, although it may be parallel with the Z-axis, may not be exactly at right angles to the X-axis. The same applies to the Y-cut. It may be off in the direction of the Z-axis as well as in the direction of the Y-axis. Since the wave constants of the X- and Y-cuts are different, it is to be expected that variations will occur as a result of inaccuracy of cutting. It is said that the accuracy of the cutting along the Z-axis for either the X- or the Y-cut should be such that the optic axis does not pass through both surfaces of the plate.

## Another Cause for Variation

Another cause for variation is that there are several modes in which a mechanical vibrator like a quartz plate can vibrate. It has at least three fundamental modes, corresponding to the three dimensions. If a plate is not cut true, there will be coupling between the various modes, and a plate might vibrate in a direction in which it could not be excited electrically without this coupling. Again, there may be certain relationships between the frequencies of the modes of vibration. For example, the natural frequency of the small dimension may be an exact multiple of the natural frequency of one of the other dimensions. When such is the case there would be coupling which would affect the frequency. Such possibilities are avoided by selecting the proper dimensions for the crystal. Since the wave constants are known approximately, it is possible to select dimensions such that the

natural frequencies are near each other, or near to the harmonics.

## Applications of Crystals

The usual applications of crystals is to the control of frequency of an oscillator. There are several circuits commonly used. Two of these are shown in Figs. 2 and 3. In Fig. 2 the crystal, X, is connected in the grid circuit and in Fig. 3 it is connected between the grid and the plate.

In either circuit the crystal and holder serve as a stopping condenser as well as resonator, for the crystal is placed between two metal plates. For that reason a grid leak is required. Its value is determined in the same way as it is in any other oscillator. The purpose of the electrical tuned circuit, LC, is to change the phase so that the crystal will oscillate at its natural frequency. It is not necessary that the LC circuit be exactly in tune with the crystal but it should be at least approximate.

Neither circuit will oscillate without the crystal, for without it there would be no feedback, at least there would not be enough. In the case of Fig. 2 the feedback takes place through the plate grid capacity. In the case of Fig. 3 the crystal itself feeds back.

## Reasons For Constancy

There are several reasons why the frequency of a crystal-controlled circuit is constant. First, the crystal has an extremely high selectivity. It will vibrate at its own natural frequency or not at all. Second, resistance cannot easily be reflected into the crystal "circuit" because of the high effective inductance and high capacity reactance. Because of the high selectivity and high reactances a given phase change in the external circuit can be compensated for in the crystal by an almost infinitesimal change in frequency. Thus if there is a change in the plate or grid resistance, or a detuning of the LC

circuit, the frequency need not shift much before the phase relations are restored. This is true for any selective resonator, but there is no other resonator that has as high selectivity as the quartz crystal.

There is no difficulty keeping the frequency of the oscillator controlled by a quartz crystal constant to one part in ten thousand in so far as changes in the operating voltages are concerned. A much closer control is possible. It has been reported that a crystal oscillator has been built that maintained its frequency constant to one part in one billion. Several have been built with a constancy of one part in 100 million.

If an oscillator of this type is to be held as constant as that, it is necessary to take extreme precautions in respect to temperature. The oscillator must be inclosed in a constant temperature chamber in which the temperature is maintained constant to within 0.01 degree centigrade. This requires, usually, that there are two thermostatic controls in tandem. First the crystal is placed in a constant temperature chamber and then that box in turn is inclosed in another. The temperature variations in the outer box might be held to 0.1 degree centigrade at a given temperature, and the temperature in the inner box to 0.01 degree centigrade.

### The Thermostats

For controlling the temperature in either chamber a thermostat is employed, not in the chamber where the temperature is to be controlled, but immediately outside. The reason it cannot be placed in the constant temperature chamber is that if it were there the temperature could not be maintained constant if the thermostat were to operate, for it would necessarily have to change by the amount determined by the sensitivity of the thermostat. This is obvious. Suppose we have thermostatic control in an ordinary living room, and the thermostat has a sensitivity such that the temperature must fall 5 degrees before the thermostat will operate. The temperature range in the house will then be at least 5 degrees, and it may easily be 10 degrees. If the thermostat were outside the room, in a room surrounding the other, the variation in the inner room would be an extremely small fraction of the range of the thermostat.

### Use of Crystal Tuners

Quartz and other piezo-electric crystals can be used in place of tuned circuits in a receiver when a very high selectivity is required. The first application of this was the Stenode radiostat. The device utilized a quartz crystal as one of the intermediate selectors in a superheterodyne. It was, however, too selective for this purpose, and for that reason it was necessary to introduce tone correction in the audio amplifier to compensate for the reduction of the side frequencies in the transmitted band. A provision was also introduced whereby the selectivity could be varied. This consisted of a variable condenser by means of which the signal could be by-passed the crystal more or less.

While the quartz crystal was too selective for broadcast reception, it is not too selective for the reception of code signals. Therefore in many of the best and latest short wave superheterodynes are equipped with a crystal selector. Provision is always made for cutting out the crystal selector when broadcast signals are to be received. The selectivity of a crystal selector is enormously high. It is, for example, to transmit a band of only 50 cycles at 450 kc and to suppress all others. This represents a selectivity at least 100 times greater than that obtainable with coils and condensers. Much of the noise that is ordinarily present in a radio re-

ceiver is cut out by this means, for the noise consists mostly of high frequencies.

### Beating Oscillator

When a crystal is used for code reception, it is tuned to the intermediate frequency. Then there is a beating oscillator operating at a slightly different frequency, say 500 cycles higher or lower than the frequency of the crystal. The crystal lets by a band of frequencies about 50 cycles wide about the intermediate frequency, which may be 450 kc. What gets through beats with the beating oscillator output and results in a tone of 500 cycles, and this is a practically pure tone.

### Rochelle Salt Crystals

Rochelle salt crystals exhibit very strong piezo properties, but the properties are different from those exhibited by quartz. When a piece of quartz is cut so that the slab is at right angles to the X-axis, the vibration is in the direction of the X-axis when the electric force is applied along the same axis. When an electric force is applied to a Rochelle salt crystal it is subjected to a twist, or as it is called, a sheer. Also, when a rod or plate of Rochelle salt is twisted, electric potentials appear. In other words, the effects are reciprocal, or reversible. It is this property of the Rochelle salt crystal which makes it suitable for either microphones or loudspeakers. Perhaps it is a little too optimistic to say suitable for both, because it has not been applied to any great extent except to loudspeakers.

In the latest application to loudspeakers, two strips of Rochelle salt were cemented together, the two strips being placed so that the electric force would lengthen one and at the same time shorten the other. This would make the end vibrate back and forth at right angles to the long dimension. The tip of the cone speaker was attached to this movable end, and of course, the cone moved with the crystal.

In this application the same principle is used as in the thermostat, in which two metals of different coefficients of expansion are mounted together. As the temperature changes, one metal strip lengthens more than the other, and consequently the free end of the two will move transversely. As the temperature falls below a certain fixed value, the one that had lengthened more, will now shorten the most, and consequently the free end will move in the opposite direction.

There is this difference between the crystal pair and the thermostat: in the thermostat there is only a differential effect, while in the crystal pair the effects are additive, that is, one actually shortens while the other lengthens. For this reason, the movement of the free end of the crystal at right angles to its length is very considerable.

### Rochelle Salt Crystals in Tuners

Rochelle salt crystals can be used in tuners in the same way as quartz crystals. There are several reasons why they are not so used to any great extent. First, they are relatively frail, and are easily spoiled by moisture and mechanical vibration. Second, they are not nearly as selective as quartz crystals. Third, they are subject to greater temperature variations. Still, if they are suitable for loudspeakers, they should be suitable for coupling transformers, for as such they would not be subjected to nearly as strong vibrations as in the speaker. The lower selectivity would in many instances be advantageous, for it would be much higher than that of coil and condenser tuners. No doubt, they will so be applied in the near future.

Quartz crystals cannot be made, where-

as Rochelle salt crystals can be grown in the laboratory to any size, almost. They are produced from supersaturated solutions of Rochelle salt, small seed crystals being dropped into the solution. Thus Rochelle salt crystals are more easily obtainable. Moreover, they are more easily worked, for they are comparatively soft, while quartz is very hard.

### Other Applications

Other applications have been found for the Rochelle salt vibrator. In one case it is used as a light valve. A tiny mirror is attached to the end that vibrates the more and a beam of light is allowed to fall on the mirror. As the crystal vibrates, the beam of light is caused to vibrate also, sweeping through a certain angle, depending on the angular displacement of the crystal. Another way is to employ the crystal so that the vibration actually cuts off a beam of light once for every excursion of the crystal. Since it is easily possible to make the crystal vibrate at a rate of 100,000 times a second, the beam of light would be interrupted at the same high rate.

### Crystal as Potential Generator

If an electrostatic voltmeter is connected between the two electrodes of a Rochelle salt crystal and the crystal is then twisted, it is possible to get as high a reading as 300 volts. The crystal, therefore, is a means for producing a potential difference. This effect can be applied to many uses. It was suggested that it might be used as a microphone. It could also be used to amplify the effect of minute twisting forces. For example, suppose one end of the crystal is twisted by a small force and it is desired to measure that force. If the potential difference resulting from the twisting is impressed on a vacuum tube the effect could be amplified manifold. It would be simple to get a relation between the output of the amplifier and the torque applied to the crystal.

In the same manner the crystal can be used as a transformer. Suppose it be provided with four electrodes, two at each end. An alternating voltage having a frequency equal to that of the crystal is applied across one pair, and this voltage is derived from the plate circuit of a tube. The other two electrodes are then connected in the grid circuit of the following tube. The effect will be transferred from one tube to the other, but only at the natural frequency of the crystal.

\* \* \*

### Properties of Fused Quartz

DOES fused quartz behave in the same manner as crystallized quartz? In other words, can it be used in piezo electric oscillators? If not, what are the main advantages of fused quartz?—W.H.C.

Fused quartz does not exhibit any piezo electric properties and therefore it cannot be used as oscillators of this type. It is possible, however, to use such quartz in oscillators in the same way as any other mechanical resonator can be used. If a tiny piece of crystallized quartz is cemented to a fused quartz rod or plate the piezo property of the small piece will set the other into vibration, and the rate will be determined by the fused quartz. Tuning forks have been made of fused quartz and they have been maintained in oscillation in the same way as steel folks. The main virtue of fused quartz is that it has an extremely low temperature coefficient of expansion. This makes it useful as spacers in accurate condensers where expansion must be minimized, as well as to many other similar applications. Clear fused glass is also useful in ultra-violet lamps, for it passes the super visible light waves.

# Radio University

**A QUESTION and Answer Department. Only questions from Radio University members are answered. Such membership is obtained by sending subscription order direct to RADIO WORLD for one year (62 issues) at \$6 without any other premium.**

**RADIO WORLD, 145 WEST 45th STREET, NEW YORK, N. Y.**

## 8-Tube Broadcast Super

I WOULD LIKE to build a broadcast set of the following type: 58 r-f, 58 modulator, 56 oscillator, 58 i-f amplifier, if you think one stage is enough, 55 detector and 2A5 output in push-pull.—D. M. S.

Such a set may be built according to the diagram given herewith. The values are given, except for the tuning coils, and these would be such as to fit the condenser to be used, and the oscillator to match the intermediate frequency. Such coils are obtainable in standard kits. The padding condenser C2 for 175 kc may be 850 to 1,350 mmfd. and for 465 kc may be 350-450 mmfd.

\* \* \*

## Output Less than Expected

THE OUTPUT of a public address amplifier utilizing two 2A3 tubes in push-pull in the output stage is supposed to be seven watts. I have built one of them but I cannot get more than about one watt out of it. What do you suppose is the trouble?—G. H. L.

In the first place, if you put nothing into the grid of the first tube you don't get anything out. Your trouble may be that you do not put enough into the amplifier to give you seven watts output. Perhaps this is because the microphone or phonograph pickup is not sensitive enough, or that the amplification in the circuit is not sufficient to load up the power tubes to give the maximum power. Again, it may be that your output transformer and speaker do not fit the tubes. Still another possibility is that you are not powering the tubes sufficiently. Have you measured the voltages on the elements of the tubes to make sure that they are what they should be to give you the

expected power? Finally, how do you measure the output power, with the proper kind of output meter or with the ear? Chances are that you are not putting enough into the grid of the first tube to swing the grids of the 2A3 tubes.

\* \* \*

## Modulation Capability

WHAT IS the difference between modulation capability and the percentage of modulation?—B. D.

Modulation capability is the highest percentage modulation that may be used in a particular receiver without exceeding a certain specified distortion. Percentage modulation is the actual modulation used, which may vary from zero to the modulation capability. It is seldom that a transmitter is operated to its full capability, if it is used for broadcasting, at least. The latest transmitters have a modulation capability of 100 per cent. This means that the amplitude of the carrier may be permitted to vary between zero and twice the mean value.

\* \* \*

## A Saturated Vacuum Tube

WHAT is meant by a saturated vacuum tube? Does it have anything to do with the plate current cut-off? Is it possible to saturate any tube, diode, triode, tetrode, and so on?—F. W. T.

By saturation is meant that all the electrons emitted by the cathode reach the plate. This cathode may be the actual cathode from which the electrons come or it may mean a virtual cathode established somewhere between the actual cathode and the plate. It is possible to saturate any tube for obviously there is a limited number of electrons emitted. If the plate voltage is high enough to attract all of them, the tube is saturated. Saturation current depends on the cathode tem-

perature only, but whether or not saturation current is obtained depends on the plate voltage as well as on other voltages entering the question. A diode can be saturated, but the saturation point is not very definite. A triode can be saturated easily, provided that the grid bias is not too high. A pentode is very easily saturated for given voltages on the grid, the screen, and suppressor. That this is the case can be seen from a family of plate voltage, plate current curves. They quickly flatten out so that there is no change in the plate current as the plate voltage is changed. Such a tube is normally operated under saturation conditions, but the saturation varies with the grid bias. A triode could not be operated under saturation conditions for the only way the plate current could be varied in such a case would be to vary the emission, and that cannot be done with sufficient rapidity. It should be observed that a photo-electric cell is also operated under saturation conditions, but in this case the emission can be varied at any speed desired, which is done by varying the light.

\* \* \*

## Gaseous Discharge Tubes

ARE there any other discharge tubes besides the neon tube that can be used as oscillator? Or are there any neon tubes in which the voltage of break-down can be varied. I am looking for an oscillator in which the intensity of the oscillation can be controlled, and I prefer one of the discharge type.—W. R. L.

There is the new 885 gaseous discharge tube that has been made available to the experimenter recently. The voltage at which the tube breaks down can be controlled by means of a grid. The bias controls the plate voltage at which the breakdown occurs. There is no neon tube that can be used in this manner. The 885 has been made especially for sweep oscillator in cathode ray circuits, but it has many other applications. As an illustration, it can be made to discharge periodically by means of a slow change in the grid bias. If the voltage on the plate is not high enough for discharge at a given bias, the bias can be changed. If there is a large condenser in the grid circuit which is charged very slowly in such a direction that the grid becomes more and more positive, a time will come when the bias is just enough to discharge the tube. If this action also discharges the condenser in the grid circuit, the arrangement is restored for another cycle to begin. The charge of the condenser in the grid circuit can be made to build up

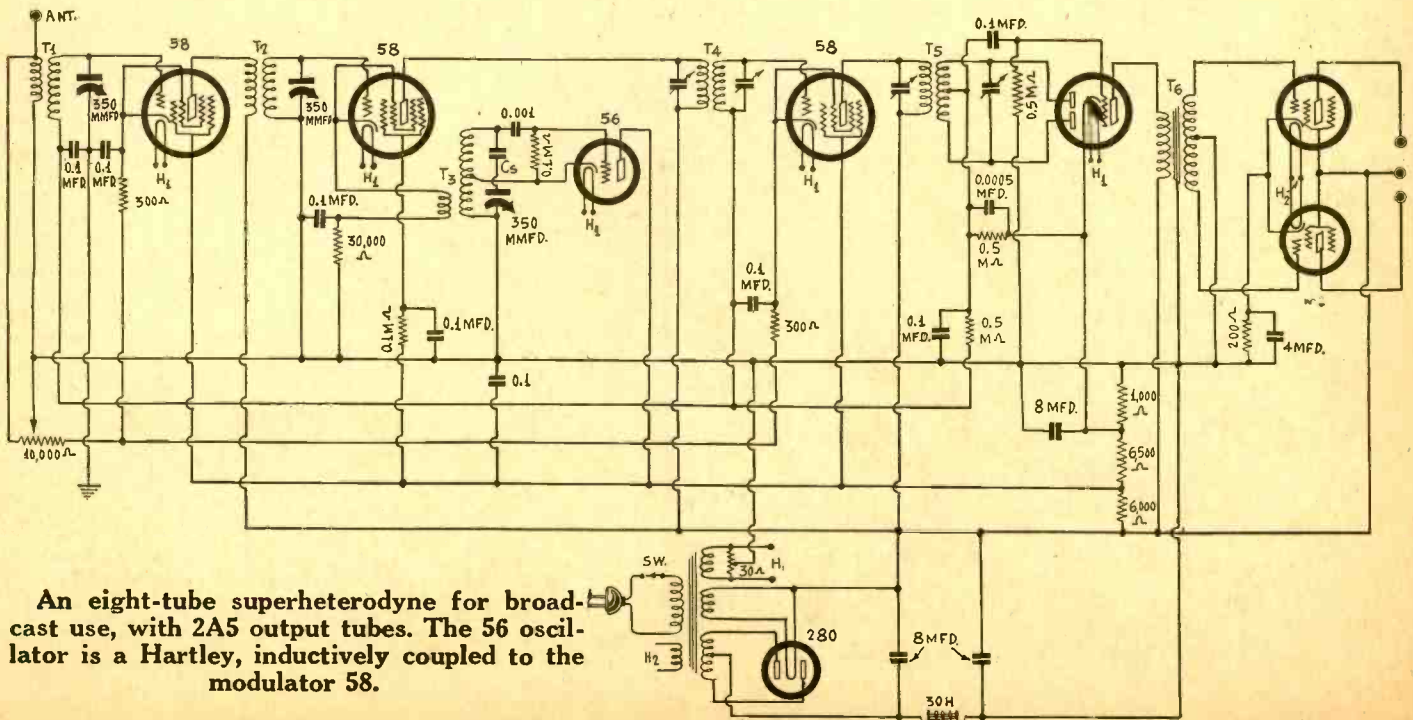

An eight-tube superheterodyne for broadcast use, with 2A5 output tubes. The 56 oscillator is a Hartley, inductively coupled to the modulator 58.



very slowly. Suppose, for example, that the bias required to discharge the tube is 15 volts on the grid and that the grid condenser has a capacity of 10 microfarads. If the battery across the grid condenser has a value of 16.5 volts there is sufficient voltage to charge the condenser to 15 volts. Let there be a 1,000,000-ohm resistor in series with the battery. Then it will take 24 seconds for the voltage to rise enough to cause discharge. This period could be made much longer by increasing the resistance, the voltage, and the capacity. If  $R=10$  megohms,  $C=100$  mfd., and  $V=30$ , the charging voltage being 31.5 volts, the time would be 50 minutes. The tube thus can be used as audio oscillator for modulation purposes.

**Diode Detection**

GIVE ME, please, the polarities both a-c and d-c for a diode rectifier comprised of a triode tube, and also show how the push-pull relationship may be produced.—H. R. D.

The a-c voltage signs are imprinted in the squares on the diagram at left on this page, and the d-c voltage signs are at the extremes of the load resistor. When the anode (erstwhile grid) is positive, and only then, does rectification take place. The "positive" here meant is the a-c voltage value. Then of course the other end of the input coil is at zero, assuming maximum positive voltage at top. The plate and cathode are tied together to constitute the functioning cathode. When the anode is positive direct current will pass from cathode to the anode through the tuned coil, if there is a direct-current path, as there is. Since this is a half-wave rectifier, no rectification takes place during half the cycle, for that is the negative half, and the requirement of a positive a-c voltage on the anode is then not fulfilled, of course. Another way of stating the situation is that the tube has one-way conductivity. At right is the diagram of a similar circuit, but the center of the resistor is grounded. So in respect to subsequent push-pull tubes, connected to this circuit through usual stopping condensers and leaks, the midpoint is zero while for one tube the grid is made negative and at the same instant for the other tube it is made positive. The voltages are equal, since the drop in the resistor has been halved. The signs are opposite. Equal and opposite voltages existing, it is permissible to call this a push-pull circuit.

**Form Factor**

IF a pure a-c wave is impressed on a rectifier having a linear characteristic and then the rectified current is measured with a

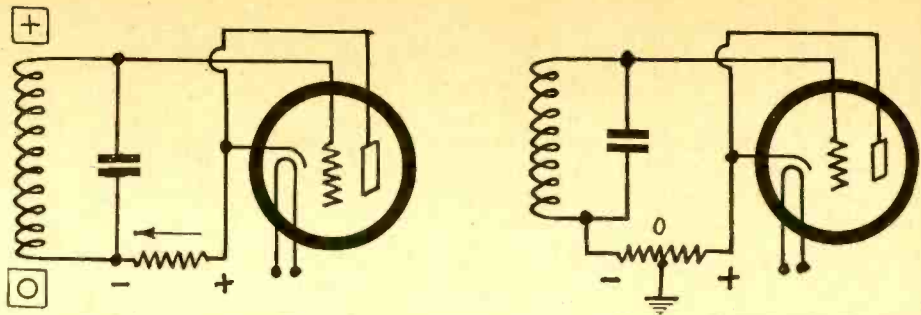

The a-c polarities are shown in squares at left, the d-c polarities across the load resistor. If a push-pull circuit is to be fed, the voltage division may be as shown at right.

d-c milliammeter, is the reading proportional to the root mean square or to the mean of the current? What relation does the measured current bear to the root mean square if it does not measure that current?—W. J. S.

The meter would measure the average current over a cycle. The root mean square is 0.707 of the peak value. The average current is only 0.636 of the peak. The ratio of these two is 1.111 and is called the form factor. To get the root mean square value of the current measured in this manner you would have to multiply the reading by the form factor. If the a-c wave is not a pure sinusoid, the form factor is different. The ratio depends on the form of the a-c wave and it is for that reason that the name form factor has been given.

**Production of Short Waves**

WHAT is the simplest oscillator for the production of ultra-short waves and about how short waves can be produced?—W. N. L.

The simplest oscillator for the production of any wave is the dynatron, and that is often used for the production of ultra-short waves. The tuner takes the form of Lecher wires, two parallel conductors, one connected to the anode and the other to the cathode. The frequency is mainly determined by the length of the line. The capacity between the plate and the cathode also affects the frequency. It has the effect of lengthening the wires, that is, lowering the frequency. When the frequency becomes extremely high, it is also affected by time of transit of the electrons between the cathode and the plate. Thus tuning is often done by varying the voltages on the elements. The variation in the frequency by that means is not all due to changes in speed of the electrons, for the frequency also depends on the plate resist-

ance, and this varies much with applied voltages. For parallel conductors metal rods are usually employed.

**Layout of Short Wave Set**

I HAVE a large drum dial which I should like to use in a short wave set comprising one tuning condenser, one regeneration control condenser, plug-in coils, and two tubes. I wish to arrange it so that the panel appears symmetrical. Will you kindly show how to lay out the parts on the chassis and how to arrange the panel?—F. W. A.

At the bottom of this page you will find such a layout, which is a reproduction of a photograph of such a set. The tuning control is at the right, the dial in the middle, and the regeneration control at the left. On the sub panel the plug-in coil is next to the condenser that tunes it and directly behind that is the tube. At right and rear is an audio tube.

**Electron Circuits**

IN the iconoscope the tiny condensers on the sensitive plate are charged by light falling on them and discharged by the electron beam. It is said that electricity flows only in closed circuits. Where is the circuit in this case? The electrons seem to come from one direction and then go back the same way.—L. C. H.

The electrons that leave the sensitive surface under the influence of the light go to one of the anodes in the tube and thence back to the cathode from which the electron beam comes. There are two space pads to the circuit in which the electrons involved move. Aside from that there is no difference between this and any other arrangement. An analogy might help to understand the action. Suppose there is a tank of water at (Continued on next page)

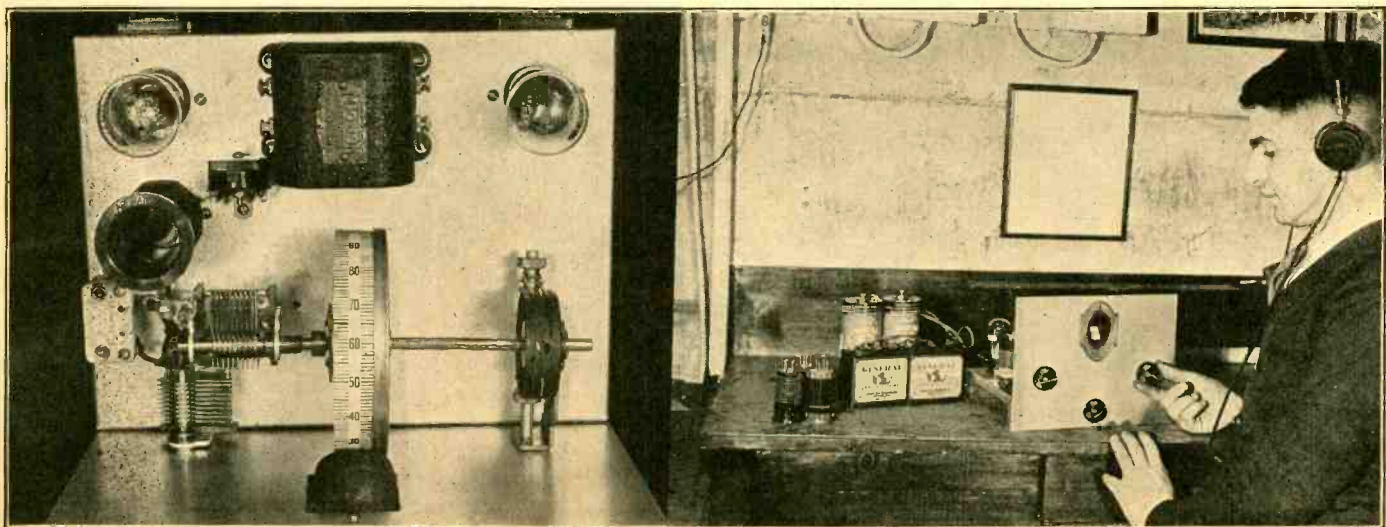

The layout of a simple short wave, battery operated receiver in which the tuning is done with a large drum dial and the regeneration is controlled with a condenser. At right the set is being operated by the designer.

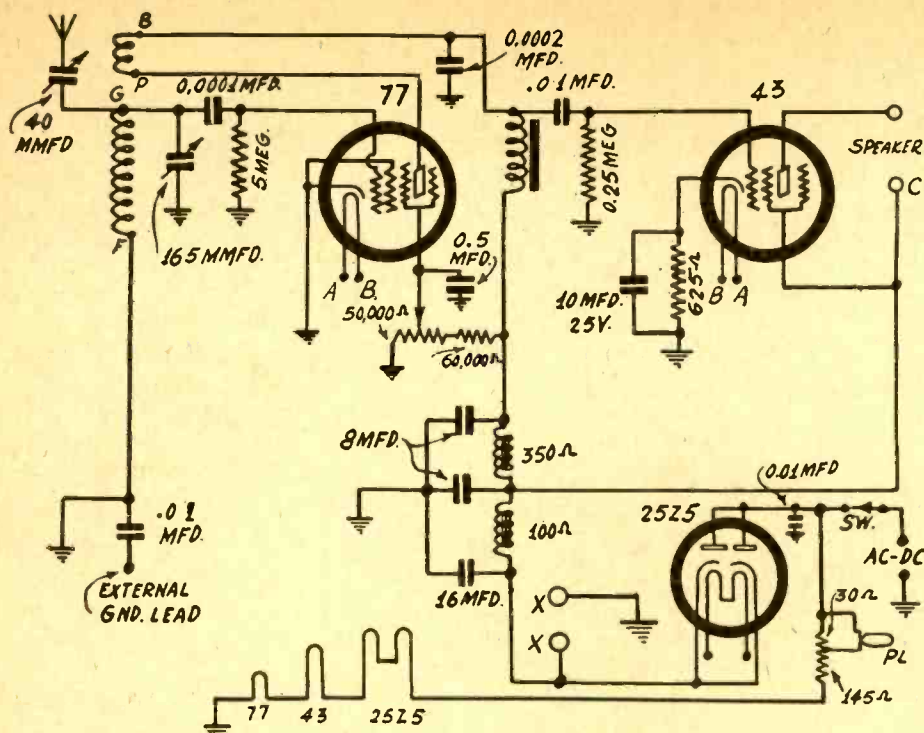

BATTERY HARNESS  
COLOR CODE

- A = BLACK
- B = YELLOW
- C = RED

X-X 4000Ω DYNAMIC FIELD

Here is a short-wave a-c and d-c set, or universal type, with a regenerative detector, an output tube and a rectifier. With even such a simple circuit as this good results are obtainable.

(Continued from page 17)

a high altitude. This represents the capacity of one of the tiny condensers. Let there be a leak in the tank, from which the water drips into a basin below, and this leak might be controlled by light or any other device. The leakage represents the charging of the tank. Now let there be a pump throwing a stream of water into the tank, representing the electron beam. It takes the water from the basin, representing the cathode, into the tank. This discharges it. It does not take much imagination to think of leakage as a charge and addition of water as a discharge. The charge in the tank can be the difference in level between the top of the tank and the actual water level. The point is that there is a circuit in which the water travels, it is

thrown up by the pump and leaks back into the basin from which the pump takes it.

**Effect of Tube Capacities**

IN the January 20th, 1934, issue you gave formulas for the effective capacity of a tube in terms of the capacities between the elements. Are these formulas applicable to oscillators as well as to amplifiers? In other words, if we have a tuned grid oscillator working at a high frequency, should the effective input capacity as given be added to the capacity of the condenser?—W. H. C.

It is not quite so simple as that in an oscillator, but if this capacity is added, a much closer approximation is obtained. If the oscillator tube is a 56, the effective capacity would be 4.5 mmfd. This would not

lower the frequency much when the capacity of the tuning condenser is 100 mmfd., for example. As the plate coil practically shorts the plate capacity, the actual effective capacity would be less. Indeed, it would be closer to the capacity of the grid-cathode elements alone, which is 3.2 for this tube. Either value is small and need not be allowed for in designing an oscillator. But when the tube is used as an amplifier in a resistance-coupled circuit, it is necessary to consider the effective capacity.

**Short-Wave Universal**

REQUEST is hereby made for a three-tube short-wave set of the universal type, where one tube is a regenerative detector, another is the output tube, and the third is the rectifier. It is desired to listen to local and semi-distant stations, and on occasion to try for foreign broadcasts.—E. H. W.

The diagram of such a receiver is printed on this page. The regenerative detector is the 77, with fixed tickler, regeneration being controlled by adjusting the screen voltage through manipulation of the potentiometer. For the purposes that you state this will make a satisfactory outfit, using plug-in coils. Standard coils may be used and will provide plenty of overlap even if the tuning condenser is 140 mmfd., instead of 165 mmfd.

**Crystal Tuners in Receivers**

RECENTLY short-wave receivers in which crystal tuners are used have been put on the market. What is the purpose of the crystal? Does it eliminate interference or does it make the set more selective?—N. J. W.

The crystals are used mainly for code reception when a very high selectivity is required. Quartz crystals are extremely selective. They will completely cut out signals differing by about 50 cycles from the frequency to which the crystal is tuned. They are practical as tuners in the intermediate frequency level of a superheterodyne where tuning is done by varying the frequency. They are too selective for broadcast reception, and for that reason there is usually a means for cutting the crystal out when it is not needed.

**Photo Electric Emission**

IS THERE any relationship between photo electron emission and thermionic emission? Just how are they two related, if there is a connection?—G. J. L.

If you ask one who has worked with both a good deal, he will say that it is difficult to tell where one leaves off and the other starts. It takes energy to release electrons. In one case this energy is supplied by light, in the other by heat.

**Measuring R-F Resistance**

PLEASE suggest a way of measuring the radio frequency resistance of a tuned circuit. I have a 115-milliamperere thermogalvanometer, if that can be used.—B. H.

If you have a calibrated oscillator you can use this and the thermo-galvanometer. Connect the meter in series with the tuned circuit and couple the coil loosely to the output of the oscillator, inductively. Note the frequency at which the current is maximum. Then detune until the deflection is just one half of maximum. Note the new frequency. If the frequency change is small and is equal to  $f$ , then the radio frequency resistance is  $R=4\pi fL$ , where  $L$  is the inductance of the coil in henries. Suppose the inductance is 250 microhenries and it takes 1,000 cycles to detune the circuit to bring about one half deflection, then the radio frequency resistance is 3.1416 ohms. The Q-factor of the coil would be 0.5F, where F is the number of kilocycles at resonance. Thus if the measurement were made at 1,000 kc, Q would equal 500. Such a high factor is not likely to be found in a radio frequency coil.

**Two for the price of One**

Get, EXTRA, one-year subscription for any One of these magazines:

- POPULAR SCIENCE MONTHLY.
- RADIO-CRAFT (monthly, 12 issues).
- RADIO INDEX (monthly, 12 issues), stations, programs, etc.
- RADIO (monthly, 12 issues; for Amateurs and short-wave experimenters).
- EVERYDAY SCIENCE AND MECHANICS (monthly).
- RADIO LOG AND LORE. Bi-monthly; 5 issues. Full station lists, cross indexed, etc.
- AMERICAN BOY—YOUTH'S COMPANION (monthly, 12 issues; popular magazine).
- BOYS' LIFE (monthly, 12 issues; popular magazine).
- OPEN ROAD FOR BOYS (monthly, 12 issues).

Select any one of these magazines and get it free for an entire year by sending in a year's subscription for RADIO WORLD at the regular price, \$6.00. Cash in now on this opportunity to get RADIO WORLD WEEKLY, 52 weeks at the standard price for such subscription, plus a full year's subscription for any ONE of the other enumerated magazines FREE. Put a cross in the square next to the magazine of your choice, in the above list, fill out the coupon below, and mail \$6 check, money order or stamps to RADIO WORLD, 145 West 45th Street, New York, N. Y. (Add \$1.50, making \$7.50 in all, for extra foreign or Canadian postage for both publications.)

Your Name.....  
 Your Street Address.....  
 City..... State.....

**DOUBLE VALUE!**

- If renewing an existing or expiring subscription for RADIO WORLD, please put a cross in square at beginning of this sentence.
- If renewing an existing or expiring subscription for other magazines, please put a cross in square at the beginning of this sentence.

RADIO WORLD, 145 West 45th Street, New York. (Just East of Broadway)

# The SWEEP OSCILLATOR

## Used with Iconoscope for Television and Other Purposes

By J. E. Anderson

IN THE article last week on the iconoscope we mentioned a sweep oscillator in which the voltage across the condenser increased linearly in respect to time. Such an oscillator is essential for television scanning, both at the transmitter and at the receiver, and it is desirable in most cases of application of the cathode ray oscillograph. The oscillator is shown in Fig. 1.

The principle of the oscillator does not differ from that of the neon tube oscillator except in detail. First, we have a gaseous discharge tube, the 885 in this instance. Then we have a condenser to be charged. In this instance there is provision for three condensers of different capacity. Finally we must have a source of d-c potential applied so as to charge the condenser at a definite rate. The charging potential in this instance is applied at the terminals marked D.C.

### Rate of Charging

The rate of charging the condenser is determined by the resistance in series with it and the source of potential. In the present case the resistance is the internal plate resistance of the 34 pentode shown directly above the 885 circuit.

In order to have a linear rate of charge, the current into the condenser must be constant as long as it is flowing. If a fixed resistance is connected in series with the condenser and the source of potential, the current will not be constant, but will vary according to the charge on the condenser. If the current must pass through the 34, and if this tube is adjusted so that it is saturated, the current will be constant, for it cannot exceed the saturation current of the tube.

It can, of course, become zero, which occurs when the condenser is charged up to the potential of the source. Just before that the current will be so small that the tube is no longer saturated, and then the voltage across the condenser will not rise linearly. It is comparatively simple to make adjustments so that the condenser will discharge before the current has ceased to be constant. Then as long as it is flowing it will be constant, and the voltage across the condenser will rise uniformly with time.

### Wide Adjustment

The saturation current of the 34 is not limited to any particular value, for it can be varied by varying the screen and grid voltages in relation to the applied plate voltage, or it can be varied by means of the filament voltage. Thus it is possible to adjust the constant current to almost any desired value, and thus to vary the time it takes the condenser to charge up to the value at which the discharge will occur. Another means of varying the time is to vary the condenser to be charged. The larger this condenser is the longer the time, for a given charging current, before the discharge voltage has been reached.

The discharging voltage can also be varied, and this is done by varying the grid bias on the 885. The higher the bias,

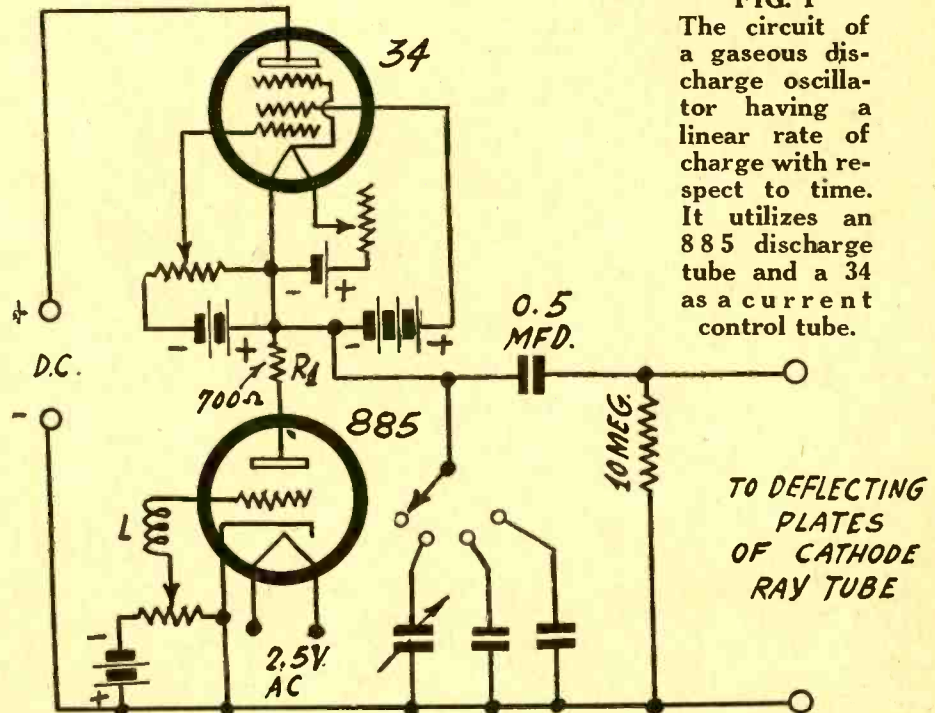

FIG. 1  
The circuit of a gaseous discharge oscillator having a linear rate of charge with respect to time. It utilizes an 885 discharge tube and a 34 as a current control tube.

the higher the discharge voltage. The discharge voltage rises linearly as the bias increases, the relation for the 885 being about 10 volts on the plate for one volt on the grid. That is, the discharge would occur at 300 volts if the bias were 30 volts.

The fact that the discharge voltage rises with the bias is made use of to synchronize in television and in other applications. If the voltage across the condenser rises linearly up to a certain value, just short of the discharge value, and then if there is a pulse in the signal making the bias less, the discharge occurs at the instant that pulse comes along.

### Applications

The use of the sweep oscillator, of course, is not limited to the iconoscope and the kinoscope. It has a wide field of application, as wide as the field of the cathode ray oscillograph. We might, for example, want to take a response curve of an audio amplifier. Suppose, then, that we have a beat oscillator controlled by a slowly rotating condenser. That is, as the condenser is turned the audio frequency varies from zero to 10,000 cycles. We want the response drawn on the screen on a linear time axis. If then the linear sweep oscillator moves the cathode ray horizontally from one extreme to the other while the condenser makes one revolution, the curve will be delineated as desired. It does not matter if the deflection voltage continues to increase as the condenser returns to the zero beat position, just so the deflection voltage repeats at the same rate as the audio frequency range.

Another application is to the taking

of resonance curves. The sweep oscillator controls the horizontal movement of the beam and the response of the tuned circuit controls the other deflection. The tuning condenser is rotated so that the frequency supplied to the tuned circuit varies through resonance periodically, the sweep oscillator is adjusted so that it repeats at the same rate. Timing can be done either by controlling the frequency of the sweep oscillator or by the turning of the tuning condenser.

### Taking Characteristic Curves on Tubes

Even characteristic curves of tubes can be taken with the oscillograph and the sweep oscillator. But in this case it is not important to have a linear time base. The base in this case is a voltage.

Wave forms can easily be taken with the sweep oscillator and a cathode ray tube. In this case a linear time base is important, for the wave is drawn as a function of time. If the wave is recurrent, the sweep oscillator should be adjusted so that it repeats at the proper rate, so that the same trace will be made on the screen every time. Close timing is necessary if the curve appearing on the screen is to stand still. If the wave is to be photographed this is essential; for if the pattern moved around, the photograph would only be a blur. When the wave is not recurrent, it is still possible to photograph it, even though the curve may be traced so rapidly that it could not be seen. A linear time base, such as the one provided by the oscillator in Fig. 1, is desirable in such cases if the trace on the screen is to represent truly the wave form of the phenomenon under observation.

# The Review

## Questions and Answers Based on Articles Printed in Last Week's Issue

### Questions

1. State whether the present problem of frequency stability in oscillators concerns the fixed-frequency oscillator or the variably-tuned frequency oscillator, and why.
2. State the requirement for frequency-stabilization of an oscillator.
3. State four influences that cause frequency change in an oscillator that is not stabilized against frequency shift and drift.
4. In the process of tuning an oscillator, since the capacity will be varied from maximum to minimum, state in what capacity region the frequency is more stable, independent of special stabilization, and give the reason.
5. Which is the predominating effect in putting a test oscillator in a metal cabinet, the reduction in the inductance due to the shielding effect, or the increase in capacity due to the shielding effect?
6. State what the Iconoscope is, who devised it, and give a brief idea of the method of operation.
7. What is the effect of using a small capacity for tuning, in respect to the necessity for series padding condensers in gang-tuned circuits, and why.
8. Name the two new medium-performance oscillograph tubes. State three considerations affecting choice.
9. Define percentage modulation as a formula.
10. If a short-wave regenerative set is unstable because regenerating too readily, state a remedy.
11. Can straight-frequency line condensers be used in a superheterodyne without padding?
12. Which is better as output tube, the 2A3 or the 50?

### Answers

1. The present problem in frequency-stabilization of oscillators concerns variably-tuned circuits, as the use of a crystal in a fixed-frequency oscillator solved that problem.
2. The requirement for frequency stabilization of an oscillator is that the circuit, loads and d-c voltages shall be so selected that the behavior of the tube itself is made to be that of a pure resistance.
3. Four influences that cause instability in an oscillator are: (a), alteration of terminal voltages, due to age and use of batteries or inconstancy of output of B supplies; (b), changes in room temperature, which affect both capacity and inductance; (c), moisture, which particularly affects inductance and (d) lack of mechanical rigidity.
4. In an oscillator the region in which the larger part of the tuning condenser is in circuit is the more stable, because the relatively high capacity has a bypassing effect on the harmonics in the circuit. Reduction of harmonics improves stability because harmonics draw power from the oscillator.
5. The predominating effect is the increase in capacity due to the shielding effect, and not the inductance drop, as the cabinet parameters are outside the strong portion of the electromagnetic field.
6. The Iconoscope is a pickup system for television that uses an oscillograph tube, hence has no moving parts. It was devised by Vladimir Zworykin. The image is picked up by a camera and is cast upon the screen of the pickup scanning tube, which screen instead of being

fluorescent, as at the receiving end, is photo-electric. The photo-electric surface is made up of a mosaic of minute photo cells. The light from the lens charges the cells and the electron beam from the cathode of the tube discharges them. Light pulses are thus converted into current pulses suitable for transmission as modulation of a high-frequency carrier.

7. Use of a small tuning capacity enables padding to be done by parallel trimmers and dispenses with the necessity for series padding. This is true because of the reduction in the frequency span, or capacity ratio, maximum to minimum.

8. The two medium-performance oscillograph tubes are the 905 and 906. The 905 is larger, requires twice the voltage, but provides a larger screen for viewing. Three considerations affecting choice are: (a), size of trace desired; (b), whether photographic reproduction is required and (c), cost.

9. Percentage modulation may be defined in formula form as  $a/A \times 100$ , where  $a$  is the maximum increase in carrier amplitude produced by the modulating

voltage, and  $A$  is the amplitude of the unmodulated carrier envelope. Percentage modulation may be measured directly by use of cathode ray tube, by the way.

10. Remove tickler turns.

11. If the inductances in the two circuits are the same and if one condenser is offset with respect to the other by the proper amount, that is, the rotor of one is turned on the shaft by a certain angle in respect to the other rotor, then the frequency difference will be constant by an amount depending on the relative displacement of the two rotors. But this arrangement narrows the band that can be covered, and this will be larger the larger the displacement of the rotors. If the condensers turn 180 degrees and it is necessary to displace one rotor by 60 degrees with respect to the other, the net possible rotation is only 120 degrees. This arrangement will work much better on very high frequencies than on low, for then the displacement is small, assuming that the intermediate frequency is low compared with the signal frequency. If the tuning condenser originally had a range of 270 degrees, it would still be possible to have a 180-degree variation on the dial.

12. Of all the tubes put out so far the 2A3 is the best for power-handling ability. The 50 is not so good because it cannot put out so much undistorted power and it requires much higher plate voltage. A very good power tube is the 48, which operates on comparatively low plate voltage, but takes a heavy plate current.

## MEASURING INDUCTANCE AND DISTRIBUTED CAPACITY BY SIMPLE FORMULAS

The problem of measuring inductance and distributed capacity of coils and circuits in which the coils are connected often comes up in the radio laboratory. This problem can be solved easily if a calibrated condenser is available. The solution is based on the fact that the distributed capacity will result in different effective, or apparent, inductance when the coil is tuned to two different frequencies. Let two frequencies,  $F_1$  and  $F_2$ , be available, and they should not be nearly alike, for the more they differ the more accurate will be the determination of the inductance and distributed capacity. Let  $C_0$  be the distributed capacity and let  $C_1$  and  $C_2$  be the capacities of the variable condenser corresponding to the frequencies  $F_1$  and  $F_2$ .

### Frequency Formula

The frequency formula applied to the two cases gives:

$$F_1^2 = 0.02533/L (C_1 + C_0)$$

$$F_2^2 = 0.02533/L (C_2 + C_0)$$

Eliminating  $C_0$  gives:

$$L (C_1 - C_2) = 0.02533 / (1/F_1^2 - 1/F_2^2)$$

from which the inductance can be computed in terms of known quantities. The two capacities are known by observation and the two frequencies by selection.

### Substitution Method

Once the inductance has been obtained, it can be substituted in either of the two formulas above for determining the distributed capacity. Or it can be determined from both and, if they differ, the average value can be taken as the distributed capacity. The distributed capacity can also be determined directly by the formula

$$C_0 = (C_2 F_2^2 - C_1 F_1^2) / (F_1^2 - F_2^2)$$

In all these formulas capacities are measured in farads, inductances in henries, and frequencies in cycles per second.

### Second Harmonic

If one frequency is exactly twice the other, the formula for the distributed capacity becomes  $C_0 = (C_1 - 4C_2)/3$  and it is not even necessary to know the frequency. This is always available when a laboratory oscillator is handy, or when two stations having a 2-to-1 relationship can be tuned in. The formula for the inductance, where  $F$  is the fundamental, becomes in this case

$$L = 0.019 / (C_1 - C_2) F^2$$

in which  $F$  is the fundamental frequency,  $C_1$  the corresponding capacity, and  $C_2$  is the capacity required to tune the circuit to the second harmonic, or twice the fundamental.

### Frequency Unknown

It will be noted that when the fundamental and its harmonic are used, the distributed capacity can be determined without knowing what the frequency of the fundamental is, but it is necessary to know that the two frequencies employed bear the 2-to-1 relation. This is easy to determine even though the oscillator used is not accurate. Therefore, if the distributed capacity is determined first in this manner, the inductance can be determined by tuning in a known frequency, and then determining the inductance from the first formula above, inserting therein the known frequency, the corresponding measured capacity, and the distributed capacity just determined.

# Station Sparks

## By Alice Remsen

### CBS Makes a New Theatre Deal

A late development in radio is the leasing of a Broadway theatre by the Columbia Broadcasting System for broadcasting its programs. The Hudson Theatre, designed by J. B. McElpatrick, and long owned by Henry B. Harris, the father of William Harris, is the house selected. Its name will be changed to the CBS Radio Playhouse and it will be opened when alterations and technical adaptations have been completed, probably during the first week in February. Admission to all broadcasts from the Radio Playhouse will be by ticket and with no admission charge.

The theatre managers are kicking at that and you can't blame them in a way. Radio in the home kept many folk away from the drama, and now free admission to broadcasts will keep thousands more away; but then, Columbia is competing against Radio City, and so they say "All's fair in love and war." William S. Paley, president of CBS, explained two of the principal reasons for this expansion—recognition of the growing participation of the stage in some of the finest radio entertainment, and of the growing eagerness on the part of the public to witness broadcasting operations with their rapid and interesting technical developments. . . .

### KOSTELANETZ TRIES SOPHISTICATION

Andre Kostelanetz has introduced a new type of radio music known as "Harmonic Sophistication" during his Buick programs on Mondays and Thursdays at 9:15 p.m. EST. over WABC, emphasizing smartness in music, by injecting a certain youthfulness and hopeful lift into his orchestrations. Through the flexibility of instrumental and vocal groups available to him, Mr. Kostelanetz is enabled to give well-known numbers colorful scoring, thus creating an impression of new melodies; a very interesting and entertaining program. . . . A new series of radio programs, sponsored by Oldsmobile and featuring Ruth Etting and Johnny Green's Orchestra, will be heard over WABC commencing February 13th; Tuesdays and Fridays at 9:15 p.m. EST. This will be Ruth's first Eastern appearance since her return from the West Coast, where she has been engaged for the past six months in picture and radio work. Johnny Green, noted young composer, arranger, conductor, made his debut as a Columbia star last Fall; if you remember, his very distinctive programs won him a large audience and great acclaim, but his radio activity was cut short when he sailed for England to supervise the scoring for the new British musical comedy, "Mr. Whittington," starring Jack Buchanan. . . . David Ross celebrated his sixth year as a CBS announcer recently, coming to this distinction by devious paths; Dave was born in New York City in 1895; educated at Rutgers, the College of the City of New York and the New York University; he was secretary to a Russian baroness, a reviewer of books and plays, and a literary editor before he turned to radio as a dramatic reader, from thence to announcing and the Diction Medal of the American Academy of Arts and Letters. His Poet's Gold Program is one of the most popular of that type on the air. Just recently he brought out a book of poetry, which is rapidly becoming one of the best sellers. He is married and has two children. . . . Young Dick Powel, film star, has been signed as a singing master of ceremonies on the Old Gold program, which opens Wednesday, February 7th, at 10:00 p.m., EST. over WABC and a nationwide hook-up. He should be okay, as this was his line of work before he made such a hit in the singing musical pictures. . . .

### JUST IN CASE YOU DO!

In case you would like to know: Connie Boswell is five feet tall, weighs 105 pounds, has black hair and brown eyes; Martha Boswell is five feet, three inches tall, weighs 115 pounds, has dark brown hair and eyes; Vet Boswell is five feet three and a half inches tall, has black hair and dark brown eyes; Norman Brokenshire weighs 204 pounds, is six feet, one half inch tall, has black hair and blue eyes; Howard Barlow stands five

feet, nine inches, weighs only 125 pounds and has blonde hair and blue eyes; Mildred Bailey is five feet, two inches tall, weighs plenty and has black hair and hazel eyes; Bing Crosby stands five feet, nine inches, weighs 165 pounds, has brown hair and blue eyes; Boake Carter weighs 137 pounds, is five feet, eight inches tall, has brown hair and dark brown eyes; Phil Cook tips the scales at an even 200 pounds, is six feet tall, has blue-gray eyes and lovely silver hair; Morton Downey is five feet, ten inches tall, weighs 172 pounds, has light brown hair and blue eyes. . . . I could go on forever—but guess you've heard enough! . . .

### DICK, WHERE ARE YOU?

When Fred Waring and His Pennsylvanians inaugurate their bi-weekly broadcasts for Ford on February 4th, they will also celebrate their first anniversary as a regular air feature. . . . If a gent named Dick, who used to be galley boy on the S. S. Carmania when it was a troop transport in the war days, is anywhere in the vicinity of New York, Albert Spalding would like to see him. In fact, he'd like to take him to dinner; figures he owes him one. The famous American violinist was among the several thousand passengers aboard the Carmania on one of its grim voyages across the Atlantic in 1917 and Dick used to feed him at private "banquets" in the galley. These "banquets" were a whole lot better than the ship's mess, even though Spalding had to hide under the table whenever the Officer of the Day came by. He hasn't forgotten these treats, and when he was interviewed recently by Bob Taplinger on the "Meet the Artist" program, he broadcast a general call for Dick to come around and be his guest some night. The only result so far has been a phone call from a Scotch hobo who said his name wasn't Dick, but he'd be glad to come to dinner, if he could have two helpings of everything. . . . Ethel Waters, the colored songstress, loves to eat bread and gravy. . . . Gertrude Niesen never wears stockings with formal attire. . . . Arturo Toscanini was a studio guest of Alexander Woollcott during one of the latter's recent broadcasts. . . . Columbia's genial maestro, George Hall, is a very superstitious man, but it usually works out backwards, for thirteen is his lucky number. . . . Very glad to hear Jimmy Kemper back on the air again after his siege of the "flu." . . .

### AN AERIAL LEAGUE OF NATIONS

The National Broadcasting Company has a regular League of Nations on its musical programs every day; Spain and Latin America are represented by Xavier Cugat and Enrico Madriguera; Carlos Gardel, Argentine baritone and Hugo Mariani, a native of Uruguay; Russia is represented by Tamara, Alexander Kirilloff and Basile Kibalchich; Ireland has two "bhoys"—John McCormack

### A THOUGHT FOR THE WEEK

**SENATOR ROBINSON**, of Indiana, declared recently in the Senate that the radio facilities of this country are controlled by the Roosevelt administration, and are practically monopolized for administration propaganda.

*That's a broadly incorrect statement when we consider that many critics of Roosevelt and his policies have had their days and nights over the air. Senator Robinson also gave the impression that the networks are under the control of the administration and that the Federal Radio Commission should do something about it. That probably caused some surprise among broadcasting executives, who would like nothing better than to have President Roosevelt dominate the air channels every day in the week and select his own hours for this domination.*

*Somebody has been spoofing the clever but sometimes mistaken Senator from Indiana!*

and Joe White; Japan has the honor of opening the BC-WJZ network each week-day morning in the person of Yoichi Hiraoka, Japanese xylophonist; Scandinavia has Madame Sylvia, health expert, and Van Lindht, Swedish disease; Canada brings Gloria LaVey; Italy, Mario Cozzi; Germany, Heime and His Grenadiers and the Bavarian peasant band, and England "Yours Truly" and Ivy Scott. . . . There is a change in the Station WLS Barn Dance network schedule. It is now heard on the basic blue network at 9:30 CTS, Saturdays. . . . Those Three Dukes, heard over WHOM, New York on Sundays at 10:00 p.m. EST, are: Duke No. 1—Ray Collins; Duke No. 2—Frank Martino; Duke No. 3—Ralph Monaco. The boys sound a great deal like the Mills Brothers, despite two major differences—there are only three of them and they are not colored. . . . It is Peter Van Steeden's music which is heard on the Baron Munchausen programs. \* \* \*

The Revelers have gone in strong for bowling this Winter. . . . Teddy Bergman is the husband of Finette Walker of the Washington Opera Company. . . . Ethel Waters made her professional debut in a Philadelphia rathskellar.

## Newspaper Publishers, Hesitating on News Pact, Urged to Sign

A ten-point proposal for the establishment of friendly relations between newspaper publishers and broadcasters in the matter of broadcasting news has been recommended to the publishers for ratification by E. H. Harris, of The Richmond (Ind.) Palladium-Item, chairman, and James G. Stahlman of The Nashville Banner, vice-chairman, of the publishers national radio committee, according to the Associated Press.

"While the proposal which is offered for the ratification of the interested groups may not meet with the approval of all participants, it does offer the best remedy," said the signed statement.

"A number of newspaper-owned radio stations," the statement continues, "graciously have agreed to submit to the restrictions for the broadcasting of news in order that they may cooperate with the newspaper group. Many of them have already agreed to submerge their interest in radio broadcasting stations to the end that a working agreement mutually beneficial may be consummated."

The committee is of the opinion, according to the statement, that newspaper-owned stations should come under the same regulations as the chain and other independent broadcast stations, as in this way the publishers could present a united front.

### Two New Tubes Due, Both of 6.3-Volt Type; Resemble 57 and 58

Two new tubes will be marketed soon, both 6.3-volt heater types. One will be the 6C6, the equivalent of the 2.5-volt 57, the other the 6D6, the equivalent of the 2.5-volt 58.

The 6C6 will bring to auto sets and universal sets the sensitivity advantage of the pentode detector, while the 6D6 will give the advantage of more remote cutoff than now obtainable from the 6.3-volt series, for r-f and i-f amplification, particularly with a.v.c.

The tubes will list at \$1.25 each.

### RCA's Shareholders Now Number 287,813

Shareholders of the Radio Corporation of America numbered 287,813 on December 30th, 1933, a gain of 180,731 in a year, and indicates that most shareholders who received stock through the distribution made by the General Electric Company and the Westinghouse Electric & Manufacturing Company have retained that stock. The number of shareholders after this distribution was approximately 294,000.

The Radio Corporation of America is now one of the most widely owned corporations in the country.

### RMA Backs Public Show for Chicago, Not for N. Y. C.

A change in its policy relating to public radio shows was made by the RMA Board of Directors. While the RMA will continue its plan to promote a public radio and electrical show in Chicago next fall, the Association decided to take no action relating to a similar show in New York until 1935 at least. The Board decided not to sponsor or have any official connection as an association with the electrical and radio show being planned in New York next September under private management, but to leave RMA members free as to their action on exhibiting in the New York show. The RMA is not opposing the show planned in Madison Square Garden in September, but is withholding any RMA connection therewith. In Chicago next fall it is proposed that a public radio and electrical show be held under RMA sponsorship and auspices. Plans are proceeding for promotion of the Chicago show, in the early fall.

## SUBSCRIBE NOW!

RADIO WORLD, 145 West 45th St., New York City. Enclosed please find my remittance for subscription for RADIO WORLD, one copy each week for specified period.

- \$10.00 for two years, 104 issues.
- \$6 for one year, 52 issues.
- \$3 for six months, 26 issues.
- \$1.50 for three months, 13 issues.  
\$1.00 extra per year for foreign postage.
- This is a renewal of an existing mail subscription (Check off if true)

Your name .....

Address .....

City .....

## TRADIOGRAMS

By J. Murray Barron

Just why it usually takes a considerable time for new ideas to take hold, even though they are eventually adopted, is often very difficult to explain. For the past few years the modernistic has made its showing in this country, not only in architecture, but in house and office furniture, and later in radio cabinets, tables and etc., and yet it was not fully accepted. Along these lines, Majestic, Wurlitzer, Philco, Emerson and others have made their bow in radio sets, cabinets and consoles. One of the latest displays along these lines with very distinctive characteristics may be seen at the Rockefeller Radio Shop, RCA Building, Sixth Avenue and Forty-ninth Street, N. Y. City.

Cornelius C. Weed, formerly of the radio and publicity departments of the New York offices of Lord and Thomas, advertising agency, has joined the sales force of WBNX, as announced by W. C. Alcorn, vice-president and general manager. Mr. Weeds' brother, Joseph J., is also in radio, being the New York representative for the New England Network.

The many friends of Alan Mannion will be glad to learn that his new location will be at 135 Liberty Street, New York City, The Mannion Laboratories. Alan needs no introduction to the experimenter, and his work in superheterodynes is very well known among those who so often get into a jam. Open house will be held the coming week.

The Muter Co., 1255 South Michigan Ave., Chicago, Ill., has a new replacement catalog for the servicemen and others using these parts.

While repairs and the like do not to any great extent interest the experimenter, as he naturally does his own, still there are neighbors and friends who have such work to be done, and in the interest of radio one should warn them of the "gyp" fifty-cent repair men, who never do a job at the house, no matter how simple, and insist on taking the set to the shop, which in most cases is to cover up a heavy charge, which would never be paid if the work were done in the home.

Michael Krantz, of Thor Radio Company, who has always had a keen personal appreciation of meters, bought out all the meters of the Majestic radio set makers and is said to have put \$25,000 into the purchase. The result is he has been besieged by consumers, dealers and even laboratories for meters of all precision types, and has been most obliging in accommodating his friends and admirers at almost nominal prices, considering the merit of the instruments.

## Corporate Activities

### CORPORATION REPORTS

Howe Sound Company—Net profit for the year 1933, after depreciation, taxes and other charges, but before depletion, as compiled from quarterly reports, \$827,449, equal to \$1.74 a share on 473,791 \$5 par capital shares, compared with net loss in 1932 after same allowances, of \$7,697. For the quarter ended December 31, 1933, the net profit before depletion was \$450,158 or 95 cents a share on capital stock, against \$356,976, or 75 cents a share, in the preceding quarter, and a net loss of \$10,663 in final quarter of 1932. A profit of \$68,903 on metals sold from inventory, Dec. 31, 1932, is included in results from the fourth quarter of 1933.

### BANKRUPTCY PROCEEDINGS

Criterion Magazine Publishing Co., Inc., of 51 East 42nd St., New York, N. Y., publishers of Screen Humor and Radio Play; by Phelps Publishing Co., Inc., for \$4,813; Raymond A. Burley, for \$500, and Robert Weiner, for \$1,500.

## Counter Meter Display Developed by Triplett

The Triplett Electrical Instrument Company, of Bluffton, Ohio, has developed a new type of counter display that holds 20 Triplett instruments, in different sizes and ranges.

This new way of merchandising instruments represents a distinct departure from accepted methods of selling this type of equipment. It takes instruments off the shelves where they are out of sight and puts them on the counter where customers can see them.

Printed in two colors, and given free with an assortment of instruments, this new Triplett display card is arousing widespread interest and enthusiasm. Jobbers and dealers regard it as a helpful "silent salesman" and say that it has resulted in their making many extra sales. It forcefully reminds customers that the dealer stocks the meters they are interested in.

## Dual Pointer Type Airplane Dials Out

Airplane dials of the dual-pointer type are appearing on the market. These are gear-driven devices, with a flat glass-enclosed scale and pointer to diametrically opposite points of the periphery.

These dials are particularly useful for short-wave and all-wave receivers, as the registration of the scales is not crowded when both upper and lower semi-circles are used.

## Literature Wanted

Readers desiring radio literature from manufacturers and jobbers should send a request for publication of their name and address. Address Literature Editor, RADIO WORLD, 145 West 45th Street, New York, N. Y.

- Max Wolf, 98 Cannon St., New York, N. Y.
- Frederick Lige, 70 S. Howell, Hillsdale, Mich.
- Geo. Beyer, 105 Elm Ave., Kirkwood, Mo.
- Mrs. Henry Carroll, 250 Westfield Ave., Elizabeth, N. J.
- Ralph Phillips, 307 E. 4th St., Quanah, Tex.
- Reliance Electric Co., 1 E. South St., Union, So. Car.
- Phillip Newport, 537 East Sherman St., Marion, Indiana.
- Norman E. Tibbitts, 582 E. Mansfield Ave., Pontiac, Mich.
- Charles E. Ebberts, R.D., Halethorpe, Maryland.
- Anthony Narvarra, 230 - 4th St., Monessen, Penna.
- J. E. Boettcher, 518 Wingra St., Madison, Wis.
- H. L. Case, Case Drug Store, Third and Hummel Ave., Lemoync, Penna.
- W. A. Taylor, 106 Montrose Drive, South Charleston, W. Va.
- Floyd E. Cates, 629 S. E. 2nd St., Minneapolis, Minn.
- Jesse M. Bremer, P. O. Box No. 71, Brunswick, Ga.
- Curtis Rentfro, 1509 E. Wilson Ave., Glendale, Calif.
- C. F. Bell, Jr., P. O. Box 252, Altadena, Calif.
- E. F. McNutt, 18 Pasadena Ave., Youngstown, Ohio.
- T. Pawlikowski, Box 64, Fairfield, Conn.
- Wm. D. Hewartson, 139 - 21st Ave., Richmond Dist., San Francisco, Calif.
- Burton W. Mach, 517 Pine St., LaCrosse, Wisc.
- H. L. Adler, c/o Valley Electrical Supply Co., Fresno, Calif.
- R. W. Ide, 1025 South 6th St., Springfield, Ill.
- W. H. Broderick, DeSoto Box 227, Memphis, Tenn.
- Du Charne Boillotat, 5105 Hillsboro Ave., Detroit, Mich.
- H. W. Birchfield, The Birchfield Radio Shop, 2535 Auburn Ave., Toledo, Ohio.
- M. J. Markley, 1-119 General Motors Bldg., Detroit, Mich.
- Emil Bratz, Billiard Hall, Fort Benton, Mont.
- John Natorski, Danielson Inn, Danielson, Conn.
- C. L. Moyer, Eldorado, Penna.
- A. E. Mayo, Gen. Del., Souris, Man., Canada
- Edmund J. Ryan, Franklin Park, Mass.
- A. P. Seidel, 2218 Pasadena Ave., Los Angeles, Calif.
- F. R. Savage, Trono, Calif.
- E. H. Seiler, 1504 S. Oakland Ave., Green Bay, Wisc.
- John Krisanda, 114 Mt. Pleasant Ave., Mamaronck, N. Y.
- R. S. Marsano, 255 W. 17th St., Beach, Arlington, N. J.

# As a GIFT

with a Subscription Order—

**A Test Oscillator  
Accurate to 1%!**

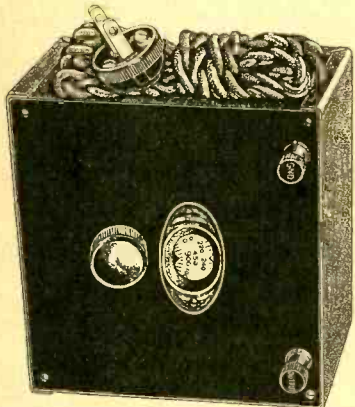

**T**HE new model 30-N Test Oscillator produced by Herman Bernard has been improved by custom-making each coil to an inductance accuracy of 0.01 per cent (one part in 10,000), and using a non-warping etched metal scale, so that the guaranteed frequency accuracy is better than 1%. Bernard Test Oscillators are the only low-priced ones that carry any accuracy guarantee.

The features of the Model 30-N oscillator are:

- (1)—Works on a.c. (any frequency), d.c. or B batteries, 90-120 volts, requiring no separate excitation of filament, hence is universal. Models for 180-240-volt use obtainable.
- (2)—Has frequency calibrated dial for lining up intermediates and broadcasts, 135 to 1,500 kc.
- (3)—Contained in black crinkle finish metal cabinet, with Formica top panel having copper foil backing.
- (4)—Constantly modulated in any and all uses.
- (5)—Oscillator Proper is isolated from cabinet, output is isolated from both oscillator and cabinet, and line is fused. Illustration above is one-third actual size, 5 x 5 x 3 inches. Weight only 3 lbs.
- (6)—Oscillator ready for use when received.
- (7)—Guaranteed frequency accuracy under all conditions, 1%. Calibration not disturbed by tube replacement.

The Model 30-N will be sent prepaid in United States or Canada, with tube inserted in socket, and direction booklet enclosed, on receipt of \$12.00 for a 2-year subscription for Radio World (104 issues, one each week, at regular rate), plus \$1.00 for the specially accurate calibration, total \$13.00. For 180-240-volt use, Model 30-ND, \$12.00 for subscription, plus \$2.00 extra for Precision and for special voltage, total \$14.00.

## RADIO WORLD

145 West 45th St., New York, N. Y.

## Vest Pocket Size Flashlight for Radio Repair Work— FREE

Great for getting right down into your set!

Obtain one free with 3 months' subscription for Radio World at the regular rate of \$1.50. Send postpaid.

Sub. Dept.

**RADIO WORLD**

145 West 45th Street New York, N. Y.

## 115 DIAGRAMS FREE

115 Circuit Diagrams of Commercial Receivers and Power supplies supplementing the diagrams in John F. Rider's "Trouble Shooter's Manual." These schematic diagrams of factory-made receivers, giving the manufacturer's name and model number on each diagram, include the MOST IMPORTANT SCREEN GRID BEHAVIORS.

The 115 diagrams, each in black and white, on sheets 5 1/2 x 11 inches, punched with three standard holes for loose-leaf binding, constitute a supplement that must be obtained by all possessors of "Trouble Shooter's Manual" to make the manual complete.

Circuits include Bosch 54 D. C. screen grid; Balkite Model F; Crosley 30, 31, 33 screen grid; Eveready series 50 screen grid; Eria 324 A.C. screen grid; Peerless Electrostatic series; Philco 76 screen grid.

Subscribe for Radio World for 8 months at the regular subscription rate of \$1.50, and have these diagrams delivered to you FREE!

Present subscribers may take advantage of this offer. Please put a cross here  to expedite extending your expiration date.

Radio World, 145 West 45th St., New York, N. Y.

## NEW PRICES TROUBLE SHOOTER'S MANUAL, Nos. I, II and III

Having assembled 2,000 diagrams of commercial receivers, power amplifiers, converters, etc., in 1,200 pages of Volume No. 1 of his Perpetual Trouble Shooter's Manual, John F. Rider, noted radio engineer, has prepared Volume No. 2 on an even more detailed scale, covering all the latest receivers. Volume No. 2 does not duplicate diagrams in Volume No. 1, but contains only new, additional diagrams, and a new all-inclusive information on the circuits covered.

Volume No. 3 (Recently issued). Order Cat. RM .....\$7.50  
 Volume No. 2—Perpetual Trouble Shooter's Manual, by John F. Rider, Shipping weight 6 lbs. Order Cat. RM-VT @ .....\$6.50  
 Volume No. 1 (8 lbs.). Order Cat. RM-VO @ .....\$7.50  
 Rider's Trouble Shooter's Manual, No. IV. Brand new, up to 1934.....\$7.50

We pay postage in United States on receipt of purchase price with order. Canadian, Mexican and other foreign remittances must be in funds payable in New York.

### RADIO WORLD

145 West 45th Street New York City

**BOTH FOR ONE FULL YEAR**

## RADIO WORLD and "RADIO NEWS"

# \$7.00

Canadian and Foreign, \$1.50 extra.

You can obtain the two leading radio technical magazines that cater to experimenters, service men and students, the first national radio weekly and the leading monthly for one year each, at a saving of \$1.50. The regular mail subscription rate for Radio World for one year, a new and fascinating copy each week for 52 weeks is \$6.00. Send in \$1.00 extra, get "Radio News" also for a year—a new issue each month for twelve months. Total 64 issues for \$7.00.

RADIO WORLD, 145 West 45th Street, New York, N. Y.

## Selected Quality Tubes FREE With Subscriptions for Radio World

Here is your opportunity to subscribe for RADIO WORLD and get just the tube or tubes you want, made by a very large, reliable, licensed tube manufacturer; picked tubes you'll appreciate. On this offer you have five days after receipt to put the tube to any logical test, and if not entirely satisfied with its performance, return it for replacement.

For an 8-week subscription (8 issues, one each week), at the regular price, \$1.00, you may select any one of the following tubes as free premium, or more at the same rate (\$2, 16-weeks subscription for two tubes, etc.), from this particular list: 01A, 01AA, IV, 12Z3, 112A, 24A, 26, 27, 30, 31, 35, 36, 37, 38, 39, 45, 47, 51, 56, 71A, 80, 82, 199X.

With a 13-week subscription (13 issues), at the regular price, \$1.50, any one of the following tubes, or more at the same rate, from this particular list (two for a 26-week \$3.00 subscription, three for 39-week \$4.50 subscription, four for 52-week, yearly \$6.00 subscription, etc.): 1A6, 5Z3, 2A5, 2A6, 2A7, 2B7, 6A4, 6A7, 6B7, 6F7, 25Z5, 22, 32, 33, 34, 41, 42, 44, 46, 49, 53, 55, 57, 58, 59, 67, 75, 77, 78, 83, 83V, 84, (6Z4), 85, 89, 199V, 483, 485.

RADIO WORLD, 145 West 45th Street, New York, N. Y.

## Power Transformer for a BIG SET

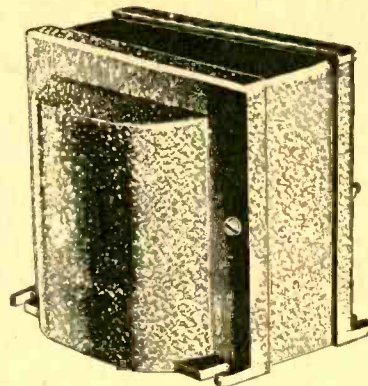

**I**NSTEAD of using undersized, overheating, inefficient power transformers for a big set, why not use a cooling, efficient transformer and pay the little extra? The Reliable transformer, Model 104-SP, will work an 18-tube set. Provides for C bias supply through 25Z5 rectifier, for quality Class C or Class A.

Primary = 115 v., 60 cycles  
 Secondary X = 14 amp., 2 1/2 v., ct.  
 Secondary Y = 6 amp., 2 1/2 v., ct.  
 Secondary R = 5 v., ct.  
 Secondary HV = 400-0-400 v., 200 ma.  
 Secondary Z = 25 v., 0.6 ma.  
 Lug terminals at bottom  
 Price, \$3.95  
 Shipping weight, 13 lbs.  
 Immediate Delivery

**RELIABLE RADIO CO.**  
 145 W. 45th St., New York, N. Y.

For a \$4.00 subscription, 34 weeks (34 issues), one No. 10 tube or one No. 50 tube may be obtained.

You may select any assortment of tubes desired and send in a subscription amount for the total required under the above classifications.

RADIO WORLD, 145 West 45th Street, New York, N. Y.

**T**HE ONLY BOOK OF ITS KIND IN THE WORLD. The Inductance Authority" entirely dispenses with any and all computation for the construction of solenoid coils for tuning with variable or fixed condensers of any capacity, suffering from ultra frequencies to the borderline of audio frequencies. All one has to do is to read the charts. Accuracy to 1 per cent may be attained. It is the first time that any system dispensing with computation has achieved such very high accuracy and at the same time covered such a wide band of frequencies.

A condensed chart in the book itself gives the relationship between frequency, capacity and inductance, which is a much larger chart, issued as a supplement with the book, at no extra charge, gives the same information, although covering a wider range, and the "curves" are straight lines. The condensed chart is in the book so that when one has the book with him away from home or laboratory he still has sufficient information for everyday work, while the supplement, 18 x 20 inches, is preferable for the most exacting demands of accuracy and wide frequency coverage.

From the tri-relationship chart (either one), the required inductance value is read, since frequency and capacity are known by the consultant. The size and insulation of wire, as well as the diameter of the tubing on which the coil is to be wound, are selected by the user, and by referring to particular charts for such wiring the number of turns of a particular diameter for the required inductance is ascertained.

There are thirty-eight charts, of which thirty-six cover the numbers of turns and inductive results for the various wire sizes used in commercial practice (Nos. 14 to 32), as well as the different types of covering (single silk, double silk, single cotton, double cotton and enamel) and diameters of 1/8, 1/16, 1/32, 1/64, 1/128, 1/256, 1/512, 1/1024, 1/2048, 1/4096, 1/8192, 1/16384, 1/32768, 1/65536, 1/131072, 1/262144, 1/524288, 1/1048576, 1/2097152, 1/4194304, 1/8388608, 1/16777216, 1/33554432, 1/67108864, 1/134217728, 1/268435456, 1/536870912, 1/1073741824, 1/2147483648, 1/4294967296, 1/8589934592, 1/17179869184, 1/34359738368, 1/68719476736, 1/137438953472, 1/274877906944, 1/549755813888, 1/1099511627776, 1/2199023255552, 1/4398046511104, 1/8796093022208, 1/17592186044416, 1/35184372088832, 1/70368744177664, 1/140737488355328, 1/281474976710656, 1/562949953421312, 1/1125899906842624, 1/2251799813685248, 1/4503599627370496, 1/9007199254740992, 1/18014398509481984, 1/36028797018963968, 1/72057594037927936, 1/144115188075855872, 1/288230376151711744, 1/576460752303423488, 1/1152921504606846976, 1/2305843009213693952, 1/4611686018427387904, 1/9223372036854775808, 1/18446744073709551616, 1/36893488147419103232, 1/73786976294838206464, 1/147573952589676412928, 1/295147905179352825856, 1/590295810358705651712, 1/1180591620717411303424, 1/2361183241434822606848, 1/4722366482869645213696, 1/9444732965739290427392, 1/18889465931478580854784, 1/37778931862957161709568, 1/75557863725914323419136, 1/151115727451828646838272, 1/302231454903657293676544, 1/604462909807314587353088, 1/1208925819614629174706176, 1/2417851639229258349412352, 1/4835703278458516698824704, 1/9671406556917033397649408, 1/19342813113834066795298816, 1/38685626227668133590597632, 1/77371252455336267181195264, 1/154742504910672534362390528, 1/309485009821345068724781056, 1/618970019642690137449562112, 1/1237940039285380274899244224, 1/2475880078570760549798488448, 1/4951760157141521099596976896, 1/9903520314283042199193953792, 1/19807040628566084398387907584, 1/39614081257132168796775815168, 1/79228162514264337593551630336, 1/158456325028528675187103260672, 1/316912650057057350374206521344, 1/633825300114114700748413042688, 1/1267650600228229401496826085376, 1/2535301200456458802993652170752, 1/5070602400912917605987304341504, 1/10141204801825835211974608683008, 1/20282409603651670423949217366016, 1/40564819207303340847898434732032, 1/81129638414606681695796869464064, 1/162259276829213363391593789328128, 1/324518553658426726783187578656256, 1/649037107316853453566375157312512, 1/1298074214633707107132750314630224, 1/2596148429267414214265500629260448, 1/5192296858534828428531001258520896, 1/1038459371706965685706200251704192, 1/2076918743413931371412400503408384, 1/4153837486827862742824801006816768, 1/8307674973655725485649602013633536, 1/16615349947311450971299240272667072, 1/33230699894622901942598480545334144, 1/66461399789245803885196961090668288, 1/132922799578491607770393922181336576, 1/265845599156983215540787844362673152, 1/531691198313966431081575688725346304, 1/1063382396627932862163151377450692608, 1/2126764793255865724326302754901385216, 1/4253529586511731448652605509802770432, 1/8507059173023462897305211019605540864, 1/17014118346046925794610422039211081728, 1/34028236692093851589220844078422163552, 1/68056473384187703178441688156844327104, 1/1361129467683754063568833763136886542144, 1/272225893536750812713766752627377308288, 1/544451787073501625427533505254754616576, 1/1088903574147003250855067010509509233152, 1/2177807148294006501710134021019018462304, 1/435561429658801300342026804203803692448, 1/871122859317602600684053608407607388928, 1/174224571863520520136810721681521577776, 1/348449143727041040273621443363043155552, 1/696898287454082080547242886726066311104, 1/139379657490816416109448573445213222208, 1/278759314981632832218897146890426444416, 1/557518629963265664437794293780852888832, 1/1115037259926531328875588587561705777664, 1/2230074519853062657751177175123411555328, 1/44601490397061253155023543502468231110656, 1/89202980794122506310047087004936462221312, 1/178405961588245012620094174009872924442624, 1/35681192317649002524018834801974584888448, 1/7136238463529800504803766960394916977896, 1/14272476927059601009607533920789833955792, 1/28544953854119202019215067841579667911584, 1/5708990770823840403843013568315933582368, 1/114179815416476808076860271366306671645376, 1/22835963083295361615372054273261334329072, 1/45671926166590723230744108546522668578144, 1/91343852333181446461488217093045337156288, 1/182687704666362892922976434160090674312576, 1/365375409332725785845952868320181348625536, 1/730750818665451571691905736640362697251104, 1/1461501637330903143383811473280725394502208, 1/292300327466180628676762294656145078900448, 1/584600654932361257353524589312290157800896, 1/1169201309864722514707049178624580315601792, 1/2338402619729445029414098357249160631223536, 1/467680523945889005882819671449824126244704, 1/935361047891778011765639342899648252489408, 1/1870722095783556023531278685799296504978816, 1/3741444191567112047062557371598593009957632, 1/748288838313422409412511474319718601915456, 1/149657767662684481882502294863837220383104, 1/29931553532536896376500458972767444076208, 1/59863107065073792753000917945534888152416, 1/11972621413014758550600183889106977304832, 1/23945242826029517101200367778213754609664, 1/47890485652059034202400735556427509219328, 1/95780971304118068404801471112855018438656, 1/19156194260823613680960294222570036867712, 1/38312388521647227361920588445140073735424, 1/7662477704329445472384117689028014647088, 1/15324955408658890944768235778056029294176, 1/30649910817317781889536471556112058588352, 1/61299821634635563779072943112224117176704, 1/12259964326927112755814588622444834354128, 1/24519928653854225511629177244889668708256, 1/49039857307708451023258354489779337416512, 1/98079714615416902046516708979558674833024, 1/19615942922883380409303341955911736966608, 1/39231885845766760818606683911823473933216, 1/78463771691533521637213367823646947866432, 1/15692754338306704327442673564729389572864, 1/31385508676613408654885347129458779145528, 1/627710173532268173097706942589175582811056, 1/1255420346064536346195413851782351165622112, 1/2510840692129072692390827703564702331244224, 1/502168138425814538478165540712940466248848, 1/100433627685162907695633108142588093249776, 1/200867255370325815391266216285176186499552, 1/401734510740651630782532432570352372999104, 1/803469021481303261565064865140704745998208, 1/1606938042962606523130129730281409491996416, 1/32138760859252130462602594605628189839328, 1/64277521718504260925205189211256379678656, 1/128555043437008521850410378422512759357312, 1/257110086874017043700820756845025518714624, 1/51422017374803408740164151369005103429248, 1/102844034749606817480328302738010206858496, 1/205688069499213634960656605476020413716992, 1/411376138998427269921313210952040827433984, 1/822752277996854539842626421904081648677888, 1/1645504555993709079685252843808163377356736, 1/3291009111987418159370505687616326754713536, 1/6582018223974836318741011375232653509427072, 1/131640364479496726374820227504653070188544, 1/263280728958993452749640455009306140377088, 1/526561457917986905499280910018612280751776, 1/1053122915835973810998561820037224561503552, 1/210624583167194762199712364007444912300704, 1/421249166334389524399424728014889824601408, 1/842498332668779048798849456029779649202816, 1/1684996645337558097597698912095559298405632, 1/3369993290675116195195397824191118596811264, 1/6739986581350232390390795648382237193622528, 1/1347997316270046478078159129676447438724512, 1/2695994632540092956156318259352894877448224, 1/5391989265080185912312636518705789754896448, 1/1078397853016037182462527303741157950978896, 1/2156795706032074364925054607482315901957792, 1/4313591412064148729850109214964631803915584, 1/8627182824128297459700218429929263607831168, 1/17254365648256594919400436599858267215662336, 1/34508731296513189838800873199716534431324704, 1/6901746259302637967760174639943306886

# Recommending - - -

# NEW 1934 DIAMOND of the AIR

## A-C OPERATED SHORT-WAVE RECEIVERS

### 12,500-Mile Reception

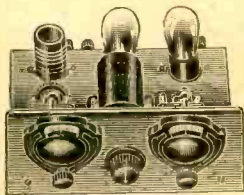

2-TUBE

Introducing the latest in short-wave receivers. The "Diamond of the Air" 2- and 3-tube battery receivers for many months have been acclaimed by owners to be the most remarkable short-wave receivers in their class. Now, for the first time, Reliable Radio Company introduces the 1934 A-C SHORT-WAVE "DIAMOND"—incorporating all the features of the battery-operated sets plus the convenience of a-c operation. The receivers have to be powered additionally and the power pack quotations will be found on this page.

#### IMPROVED RECEPTIVE QUALITIES

All 1934 features have been incorporated in the new "Diamond of the Air" a-c short-wave receiver and, besides, the popular battery-operated models have been improved in a new 1934 design. The lowest in price, yet these sets will log stations from all parts of the world regularly.

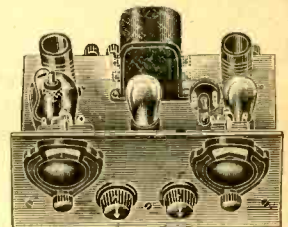

3-TUBE

#### The A-C "Diamond of the Air" Receivers

The a-c receivers have been developed for those who have the benefit of electric service. They use the latest type triode-grid tubes, resulting in more selective and sensitive reception.

The 2-tube model employs a 57 tube, resistance coupled to a 56 type output tube. For those desiring to use this receiver on batteries, simply replace the 57 tube with a 77 and the 56 tube with a 37, for heater excitation from a 6-volt storage battery and use B batteries for plates. Loudspeaker reception on all local and many distant stations.

The 3-tube a-c receiver uses a 58 as an r-f amplifier, followed by a 57 detector and a 56 as an output tube. This receiver can be used on batteries by using 77, 78 and 37 tubes as detailed above. Capable of logging stations from all parts of the world.

#### Employs the Highest-Grade Materials

A receiver is only as good as the parts used in its construction. Only the finest parts are included. Hammarlund condensers, representing the finest, are used. The metal panel eliminates body capacity.

#### DIAMOND OF THE AIR

##### Battery-Operated Short-Wave Receivers

The battery-operated receivers employ the 2-volt low-current tubes, saving considerable expense to those living in districts where no a-c is available.

The two-tube model uses two 30 tubes. Especially designed for headphone reception, although loudspeaker reception may be obtained at ordinary room volume.

The 3-tube two-volt model employs one 34 and two 30 tubes. It will receive short-wave stations from all parts of the globe on a loudspeaker.

#### Electric Models

- Cat. No. 5025-D. Two-tube A-C kit, with blueprint. Shipping weight, 5 lbs. .... \$8.45
- Cat. No. 5026-D. Above, wired and tested. Shipping weight, 5 lbs. .... 9.45
- Cat. No. 5027-D. Complete set of tubes for above, either one 57 and one 56 for a-c operation or one 77 and one 37 for battery operation. Specify which. Shipping weight, 2 lbs. .... 1.45
- Cat. No. 5028-D. Three-tube a-c kit, with blueprint. Shipping weight, 7 lbs. .... 11.45

- Cat. No. 5029-D. Above, wired and tested. Shipping weight, 7 lbs. .... \$13.45
- Cat. No. 5030-D. Complete set of tubes, either one 58, one 57 and one 56 for a-c operation or one 78, one 77 and one 37 for battery operation. Specify which ..... 2.45

#### Two-Volt Battery Models

- Cat. 5019-D. Two-tube kit, with blueprint, less accessories listed below. Shipping weight, 5 lbs. .... \$7.75
- Cat. No. 5020-D. Above, wired and tested, less accessories listed below. Shipping weight, 5 lbs. .... 8.75
- Cat. No. 5021-D. Complete accessories including two 30 tubes, one set of standard headphones, two No. 6 dry cells, two standard 45-volt B batteries. Shipping weight, 22 lbs. .... 4.50
- Cat. No. 5022-D. Three-tube kit, with blueprint, less accessories listed below. Shipping weight, 7 lbs. .... 9.95
- Cat. No. 5023-D. Above, wired and tested, less accessories listed below. Shipping weight, 7 lbs. .... 10.95
- Cat. No. 5024-D. Complete accessories, including two 30 tubes and one 34 tube, one set of standard headphones, two No. 6 dry cells, three standard 45-volt B batteries, one 6-inch magnetic speaker. Shipping weight, 32 lbs. .... 8.95

### DIAMOND of the AIR SHORT-WAVE POWER PACK



Supplies clear hum-free power regardless of circuit sensitivity. Especially designed for use with the "Diamond of the Air" Short-Wave receivers, but can be used on any short-wave battery-operated receiver for B supply.

Contains a brute-force filter, employing two heavy-duty 30-henry chokes, specially-designed power transformer, and three electrolytic condensers. These factors assure pure d.c.

Will deliver 180 volts. Supply your own taps, 135, 90 and 45 volts. Supplies 2 1/4 volts at 10 amperes for filament drain. All taps terminate at binding posts on the side of the pack. Employs an 80 rectifier. Will stand up to 75 ma. drain for B current.

All parts are mounted on a sturdy metal base finished in silver.

Cat. DAPP. Price, including 80 tube ..... \$5.95

Shipping Weight, 20 Lbs.

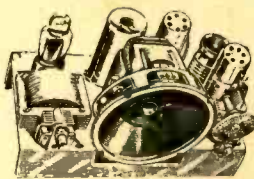

### Four-Tube A-C Short-Wave Receiver with Built-In Speaker

Will tune in short-wave stations from all parts of the world with ease. Uses four plug-in coils to cover the entire short-wave band from 15 to 200 meters. The built-in power supply is entirely free from hum or disturbing line noises. Uses an ultra-sensitive dynamic speaker which aids in tuning in the weaker signals.

- Cat. 4TK. Kit of Parts, less cabinet, less tubes ..... \$17.50
- Cat. 4TW. Above, completely wired and tested ..... \$19.50
- Cat. 4TCB. Cabinet only ..... \$1.50 extra
- Cat. 4TTU. Complete set of licensed tubes ..... \$2.50 extra

### Reliable Radio Company

145 West 45th Street  
NEW YORK CITY



#### For A-C and D-C Operation

Will work anywhere that 110 volt A-C or D-C is available. U. S. amateur reception is assured on loudspeaker by the use of a 43 power tube in the output.

With headphones the entire world is at your finger-tips. Chassis is completely encased in a beautiful crystal finished cabinet. Covers the short wave, band from 15-200 meters. Uses one 78, one 25Z5 and one 43 tube.

Price Kit ..... \$8.95  
Wired ..... \$2.00 extra. Tubes ..... \$3.25

### FREE HANDY SERVICEMEN'S MANUAL

WITH EACH PURCHASE OF A SHORT-WAVE RECEIVER



ALL SHIPMENTS MADE EXPRESS COLLECT UNLESS OTHERWISE DIRECTED BY PURCHASER