

# FUN WITH RADIO

Gilbert Davey

Edited by Jack Cox



GILBERT DAVEY

Edited by Jack Cox

# FUN WITH RADIO

6th Edition (completely revised)

KAYE & WARD · LONDON  
in association with Methuen of Australia  
and Hicks Smith, New Zealand

Every effort has been made by the Author to ensure that proper application of the advice and information given will produce satisfactory and pleasing results. But no responsibility can be accepted by the Author, Editor or Publishers for damage, loss or injury resulting from the application of the information and guidance given in this book.

First published by  
Edmund Ward (Publishers) Ltd  
1957  
Revised Editions, 1959, 1961, 1965  
Completely Revised Editions, 1969, 1978  
published by Kaye & Ward Limited  
21 New Street, London EC2M4NT

Copyright © 1969 Kaye & Ward Ltd

All Rights Reserved. No part of this publication may be reproduced, stored in a retrieval system, or transmitted in any form or by any means, electronic, mechanical, photocopying, recording or otherwise, without the prior permission of the copyright owner.

ISBN 0 7182 1315 7

Set in VIP Palatino by Bishopsgate Press Ltd, London  
Printed in Great Britain by Cox & Wyman Ltd  
London, Fakenham and Reading

# Contents

Foreword	7
1. Introduction to Radio Set Building	9
2. Tuning Coils	14
3. Crystal Sets	18
4. A Beginner's One-Valve Receiver	25
5. A Simple Transistor Receiver	29
6. Reflex Pocket Transistor Receivers	33
7. A Transistor Amplifier	37
8. A Stereo Amplifier	39
9. Mains H.T. Units for A.C. Mains	42
10. A VHF F.M. Receiver	46
11. Amplifiers, Record-Players and High Fidelity	49
12. A Simple High-Fidelity Valve Amplifier	53
13. Kit-Sets, Kits and Other Designs	57
Appendix	59

The first part of the report  
 deals with the general  
 situation of the country  
 and the progress of  
 the various branches  
 of the service.  
 It is followed by a  
 detailed account of  
 the operations of  
 the different  
 departments.  
 The report concludes  
 with a summary of  
 the results of the  
 year and a  
 statement of the  
 resources available  
 for the following  
 year.

# Foreword

This is a practical handbook written in simple language for the practical boy whose hobby is amateur radio construction, and leading on to four further titles in the same series by Gilbert Davey – *Fun with Short Wave Radio*, *Fun with Electronics*, *Fun with Transistors* and *Fun with Hi-Fi*.

It was written originally in 1957 for readers of *Boy's Own Paper* and based on monthly features and special eight-page pull-out supplements, all written and produced by Gilbert Davey. I edited this famous periodical, founded in 1879, for more than 21 years, and still edit the *Boy's Own Annual*, which I revived in 1959 after a 20-year lapse, and with which the magazine was merged in 1967. Throughout my 31 years' association with the *Boy's Own* projects of all kinds Gilbert Davey has remained the Amateur Radio contributor.

Today the hobby has spread in many directions and boys no longer have the field to themselves! Indeed, there are almost as many girl enthusiasts as boys and this book is intended as much for them as anyone else; in addition the book can be read and used by any radio enthusiast of any age, and will also appeal to many readers living overseas.

Radio is a leading interest in the modern Scout programme of training, and one of the outstanding features of the remarkable World Scout Jamboree held at Lillehammer in Norway in the summer of 1975 was the emphasis on modern technology and electronics. Scouts who were fortunate enough to be selected to represent their countries were linked by means of the Jamboree radio and television stations with their brother Scouts in all parts of the world in a vast 'join-in' Jamboree network linking boys everywhere. This shows the scope and potential of modern radio as a hobby.

Home radio construction has proved itself as a popular hobby that never fails to interest intelligent boys and girls with a practical, scientific and technical bent. Gilbert Davey has managed to retain the enthusiasm and lively interest of the amateur probably because at no time in his life has he ever been professionally connected with radio. It has always been a hobby with him and for that reason he has retained the outlook of the amateur who raises his standards to high levels and keeps up-to-date, interested in all aspects of his hobby for its own sake and helping boys and girls to get the utmost out of it.

Gilbert Davey's object has always been to interest more and more boys, and now girls as well, in his own hobby and to encourage them to get as much fun out of their own home-made sets as he has done. As an editor, and broadcaster on home and overseas radio programmes, I have always found it fun to work with Gilbert Davey, knowing that his enthusiasm would never fail to rub off on me as it has done for so many other people; many a boy's hobby has in fact become father's hobby also, and I am sure this new edition of *Fun with Radio* will win many new friends for the author.

For the technically minded, and those studying electronics, the following are a selection of symbols and abbreviations used in this science:

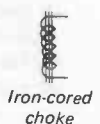
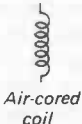
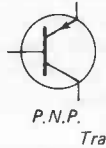
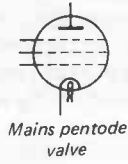
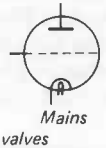
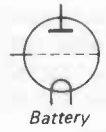
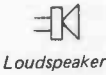
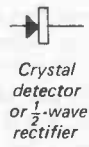
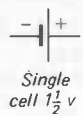
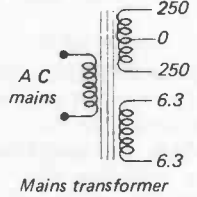
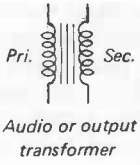
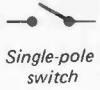
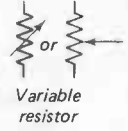
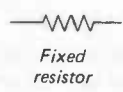
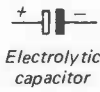

Wavelength	= $\lambda$	metre	= m	Prefixes for Abbreviations
Frequency	= f	frequency		
Voltage	= E	unit (c/s)	= Hz	
Current	= I	volt	= V	
Power	= P	ampere	= A	
Inductance	= L	watt	= W	
Resistance	= R	henry	= H	
Impedance	= Z	ohm	= $\Omega$	
Capacitance	= C	farad	= F	

One million millionth = micromicro =  $\mu\mu$   
usually known as pico = p =  $(\times 10^{-12})$   
One millionth = micro =  $\mu$  =  $(\times 10^{-6})$   
One thousandth = milli = m =  $(\times 10^{-3})$   
One thousand times = kilo = k =  $(\times 10^3)$   
One million times = mega = M =  $(\times 10^6)$

Examples: megohm = M $\Omega$ ; microfarad (mfd.) =  $\mu$ F; milliamp = mA

The International Code is as follows:

(i) resistors

- 6  $\Omega$  8 = 6.8 $\Omega$
- 6K8 = 6.8K
- 6M8 = 6.8M

(ii) Capacitors

- 5p6 = 5.6pF
- 5n6 = 5,600pF = 0.0056 $\mu$ F
- 560n = 560,000pF = 0.56 $\mu$ F
- 5 $\mu$ .6 = 5.6 $\mu$ F

# Introduction to Radio Set Building

This is not a text book. It is a book of sound, modern, practical radio designs, all of which work well. You must not copy a design slavishly, though; you need to find out why and how it works, and then you can experiment later on.

FUN WITH RADIO was first published in 1957 and, I am glad to say, has enjoyed success all over the world. It began as a reprint of designs first published in *Boy's Own Paper* which proved so popular that they were in constant demand by that paper's readers. *BOP*, alas, is no longer published as a magazine but in its long life of 88 years it was so much a part of the British way of life that I should like to record how proud I am to have been associated with it, and with Jack Cox who was its Editor for 21 years, and still edits the *Boy's Own Annual*, which he re-started in 1959.

The designs in the first edition had been in *BOP* during the eleven previous years so that you will see that they had their origins in the years immediately after World War II. They utilised valves and components which were then available, many of them 'war surplus' types.

In subsequent editions much that was obsolete was replaced by modern ideas although some reviewers did not seem to appreciate that the book is addressed to boys who are beginners in the hobby and who often obtained obsolete parts from relatives and friends or bought them in the 'surplus' stores. Such components are now very out-of-date by modern standards.

So maybe we are a bit old-fashioned! But that is how so many of us do start, with an old radio set or an old design which is a little simpler than a modern one. I can promise you, however, that, apart from the theoretical diagram of the crystal set, there is nothing now left in this book which was in the first edition! Those old designs of ten to twenty years ago are gone and in their place we have transistors, ready-assembled 'modules' and kits of parts for home assembly. I hope you find something of real interest to you.

As most of my readers will know, electronics during the past fifty years has become one of the important features in modern life, industrially, commercially and in the entertainment world. There is no doubt that the periodicals which cater for interested amateurs have done an enormous amount in assisting this advancement by informing them of developments, providing ideas for experi-



ment and generally fostering the curiosity which every good radio amateur has about matters concerning his hobby. I like to think that the Editor and I have helped also by providing for the young beginner advice and encouragement in the radio hobby through our many articles and supplements, and our radio books in the Kaye & Ward series. The interest of readers all over the world has been a great encouragement to us and we are grateful to the many thousands who have expressed pleasure in the books and have made necessary a new 6th Revised Edition of *Fun with Radio*.

Broadcasting officially started in Britain on 14 November 1922 when the British Broadcasting Company, forerunner of the present Corporation, opened its London transmitter, '2LO'. On the following day its Birmingham and Manchester stations opened.

At that time there was virtually no supply of ready-made components available and almost everyone used a home-built set, usually of the crystal variety. In the first year the number of licence-holders reached about 200,000 and it was almost 1925 before the million figure was attained. How many 'unlicensed' listeners there were could not be computed! Only TV needs a licence today. Radio is free.

My interest in the hobby started in 1927 when I was a boy. As a result of moving to a new house outside London, my father asked a friend to build us a three-valve set. This was run from batteries and was of the type known as a detector and two LF. The latter were transformer-coupled and we had a loud-speaker with an enormous horn curled over the top. The builder of this receiver, seeing my interest, gave me a number of spare components and some old periodicals. I began to experiment!

It was fun in those days to try a new circuit, perhaps to invent something different. We wound our own coils, made a lot of our own component parts, and if a new set worked at the first try-out we were astonished. We had a lot of fun from radio experiments then, and it is the purpose of this book to assist you, perhaps a newcomer to radio, to obtain the same fun with your radio now as we did with much cruder apparatus in the past.

Electronics is a new, modern industry, which has rapidly assumed a position of importance in the industrial life of the world. Its development is suffering constantly from a shortage of personnel. Apart, therefore, from interest in radio as a hobby, it may be the passport to a career in electronics in industry, in Government research, in the Services or the Merchant Navy.

This book does not set out to be a textbook teaching theory. It is a book of sound, modern practical designs, all of which work. In the building and operating of them the beginner will learn much. No great attempt has been made to explain theory, and an assumption has been made that some theoretical knowledge if possessed or is being acquired in your own reading. There is not the least need for such knowledge, however, as most designs in this book can be built up from the diagrams supplied with each chapter.

In radio you usually find you are not content merely to copy a design slavishly; you want to know *why* and *how* it works, and to experiment with different components and loud-speakers and values of resistors and so on. There the 'fun' with radio comes in.

My designs have been made on a progressive basis so that the first set is the simplest crystal receiver which anyone could build. The next set is a little more complicated and so they progress. None of them is hard to build. If you feel like building one, go ahead and have a shot at it; if it does not work first time check it over and try again. It is easy to make a wiring mistake and just as easy to rectify it.

I hope your interest is such that you really want to get ahead with this satisfying hobby. It is most desirable that you should learn the theoretical symbols, the shorthand of radio. Those which you are likely to come across most often are shown in Fig. 1. A knowledge of these will help you to understand and assess a circuit, and to check wiring and trace faults. With a fair knowledge of these, you must next read up some theory. Your local library will have some suitable books. Make sure you obtain an up-to-date one.

There are, too, useful correspondence courses, and also evening classes at the local technical colleges and institutes in many parts of Britain. I also suggest that you buy a good radio periodical.

Solid State are two words now much in vogue when considering radio and electronic equipment. They refer to items which are manufactured from selenicum or silicon such as diodes and transistors and mean that the equipment called solid state does not use any valves in its operation. Valves require to have their heaters fed with current and also need high voltages. They have limited (though these days longer) lives and equipment using valves runs very hot. Solid state equipment needs moderate operating voltages, runs cool and should be very reliable. The modern tendency is for the production of integrated circuits where all requisite transistors and other components are compressed by a manufacturing process into one small, compact unit.

So in this revision of *Fun With Radio* we are going 'solid state' and with two exceptions we shall ignore valves altogether. The exceptions are included because, as mentioned earlier, our readers like to experiment with old components they have been given and no radio book would be complete without making it clear that such things as valves still exist.

Beware of old capacitors or resistors and if in doubt about any part, avoid it. It is unlikely that you will find a radio-components shop in your district, as these days they are rather rare and most sales are done by mail order. One of the radio periodicals may be consulted; reliable firms specializing in sales by post advertise regularly. For the top-class components such as I have used, firms like Home Radio (address in Appendix) provide valuable assistance, though any of the advertisers in periodicals such as *Practical Wireless*, *Radio Constructor* or *Wireless World* will be as helpful as they can.

Readers are well aware of the improved quality of reception which is obtainable from frequency-modulated transmissions (FM) and these are broadcast on very high frequency (VHF). Consequently, because of the difference in the type of transmission (those to which we are accustomed on the medium and long waves being amplitude-modulated), and of the lower wavebands used, a special receiver is necessary. Such a receiver is described in Chapter 10.

Another subject that often crops up in my correspondence is transmitting. The position here is that nobody is allowed to operate a transmitter until he has

attained the age of fourteen years and has passed the GPO examination and been allotted a licence to transmit. The examination is a theoretical one at about the City and Guilds standard and there is a Morse Code test in sending and receiving the code at not less than twelve words per minute. So you see that you require a good knowledge of radio, and the best way to obtain it is to study textbooks, experiment and build radio receivers.

Before you start to build, here is some advice on tools. You need two screwdrivers – one of normal type and one very small for the grub-screws of knobs – a pair of pliers with wire cutters at the side, and an electric soldering iron. If you are going to buy a soldering iron, get one of the special types for radio work. Extra refinements which are of great help, but not strictly necessary, are: a 'Bib' wire stripper and cutter, a hack-saw, a drill, a keyhole saw, files, and a gadget for cutting holes in metal. If you have not got any of these available at home, do not bother to buy them specially. Carry on with the bare essentials and see how you manage. If you find you want some additional tool, then buy it as you require it.

Soldering is done with solder which has its flux built into it and I usually obtain Ersin Multicore. Soldering is simple. Apply the hot iron and the solder together to the joint to be soldered, let the solder run, take away the iron and solder, blow on the joint to cool it and it should be perfect. Beware of dry joints which look good but are not. A quick tug will usually reveal one. In soldering cleanliness is essential. It is a good idea to keep a piece of fine sandpaper handy to clean up joints to be soldered. For connecting-up I prefer tinned copper wire, about 24 s.w.g. gauge, with insulating sleeving to slip over it. Insulated connecting wire may also be purchased. For connections to the mains, the usual type of PVC twin flex is used and this is also used, in single flex, for connections to batteries in sets which use them. Antex Ltd supply a special kit called Antex Precision Soldering Kit which has an iron with several bits, solder and a special base to carry all this together with a heat sink for use when soldering transistors.

Both the Editor and I wish you lots of fun with radio, both in building and experimenting with receivers, and in using the completed set. If you have any special queries we will be glad to answer them if you write us c/o the publishers and enclose a stamped, addressed envelope. Please write only one query on each sheet with a space below for reply. It is essential that you enclose a stamped, addressed envelope or, if outside the U.K., an International reply coupon.

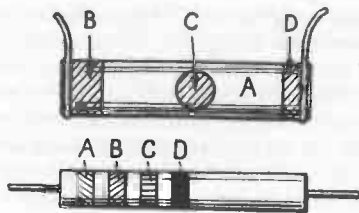

Figure 2

## Resistor Colour Code

Colour	Figure
Black	0
Brown	1
Red	2
Orange	3
Yellow	4
Green	5
Blue	6
Purple	7
Grey	8
White	9

Read in the following manner:

- A or body - first significant figure
- B or end - second significant figure
- C or spot - indicates the number of noughts following the figures
- D or other end - indicates tolerance of the resistor

Gold  $\pm 5\%$   
Silver  $\pm 10\%$   
Unmarked  $\pm 20\%$

e.g. A = yellow  
B = purple  
C = orange  
D = silver

= 47,000 ohms at 10% tolerance

## Tuning Coils

Tuning coils are necessary for reception on medium and long waves, and they are regrettably in very short supply now. So we show readers how to obtain some of them, and how to make others. Winding the aerial coil must be done carefully for the best results.

Our chief interest in this title is building radio receivers to operate on medium and long waves or, in modern terms, between 525-1605 kiloHertz and 160-225 kiloHertz (KHz). Short wave reception is especially considered in a companion book *Fun with Short Wave Radio*.

For reception on those wavebands it is necessary to have coils and these are in very short supply now. Manufacturers are concentrating on VHF reception but in any event components for home construction are at a minimum. Consequently I have decided to devote this first constructional chapter to coils and how to obtain or make them.

Most of the designs we have described in previous editions of this book have used the REPANCO coil DRR2. This is a simple coil for medium and long waves with a 'reaction' winding and is highly suitable for our requirements. Messrs. Repanco Ltd. tell me they are still making it and it is obtainable through Home Radio (Comp.) Ltd (address in Appendix). Older forms of this coil had the connections colour-coded and you will see that these colours are used in some of the designs illustrated. Latterly, however, the colours have been changed for numbered coding and if your coil has numbers here are the equivalent colours for each number:

1. Green
2. Yellow
3. Blue
4. Black
5. Mauve
6. Red

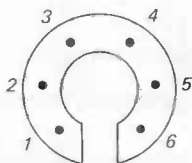

Top view DRR2 coil

Figure 3 Repanco DRR2 Coil

This coil is very versatile and can be used in crystal-set and valve-set designs (as you will note in later chapters). Unfortunately it has specialised winding techniques and cannot be home-made.

For use in a crystal set or a pocket transistor receiver it is quite easy to construct a ferrite rod-type of aerial which is in itself a coil but due to the ferrite rod upon which it is wound will also act as a self-contained aerial. The coil is illustrated in Fig. 4 and here are the winding instructions:

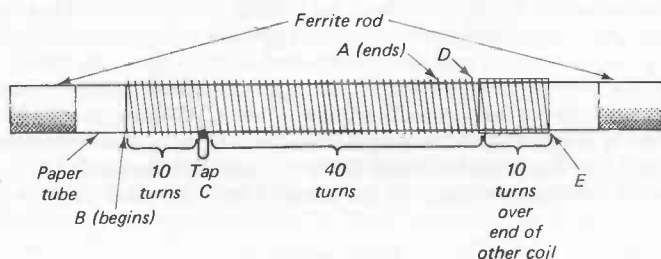

**Figure 4 Ferrite-rod Aerial Coil**

*Components required:* Ferrite rod, 28 d.c.c. wire, cartridge paper

#### *Winding the Aerial Coil*

This coil is simple to make. It tunes medium waves only, the addition of long waves is a little too complicated to include at this stage.

Take the ferrite rod and cut a small piece of thickish paper or thin card about three inches long, just enough to wrap round the rod with a small overlap for fixing.

Wrap it round tightly enough to allow it to slide fairly firmly along the rod. The join may then be sealed with a small strip of cellulose tape.

The wire used for the coil is 28-gauge double-cotton-covered (d.c.c.) and very little is required. It is rather a thick wire but this makes it easier to use and gives an efficient coil.

The ends of the wire must be anchored; to do this, I like to make two small holes in the end of the tube.

Slide it off the rod and pierce two holes in the tube about  $\frac{1}{4}$  in. from one end and about  $\frac{1}{4}$  in. apart. Thread the wire through the two holes leaving about three inches spare for connecting.

Take care *not* to flatten the tube while doing this; now slip the tube back on to the ferrite rod. Begin winding by putting on ten turns of wire neatly side by side pulling them fairly taut . . . but not so as to distort the tube or to stop it sliding along the rod when the coil is wound.

Having put on ten turns, hold them steady with your thumb. Now make a loop in the wire and twist it so that you can continue winding but have the loop sticking up as a connecting point.

Continue to wind on another forty turns so that you have fifty turns in all with a tap at the tenth turn.

The figure fifty is not vital so don't worry if you miscount and have one or two more or less. Hold the fiftieth turn carefully with your thumb and cut the wire so as to leave about three inches spare.

Slip the end of the tube off the ferrite rod sufficiently to allow you to make two more holes with your darning-needle close to the end of the winding. Thread the spare end through these holes and pull gently but tightly so as to fix the winding.

The second small winding must now be wound *over* the first. This is done by taking a small piece of cartridge paper and wrapping it tightly round the outside of the winding you have just put on and by sealing its edge with cellulose tape. Somewhere about the centre will be correct, just after the tapping point.

Now wind on seven turns of the 28 d.c.c. wire and you can hold them in position with a few thin, short strips of cellulose tape. The direction of the winding should be the same as that of the larger winding beneath it.

Here is a note of the positions of the letters I have allotted to the coil on the diagram:

'A' is the END of the fifty-turn winding, the fiftieth turn;

'B' is the beginning of that winding; 'C' is the tap, i.e., the tenth turn.

'D' is the beginning of the smaller winding on top (nearest to 'C'); 'E' is the end of the smaller winding (nearest to 'A').

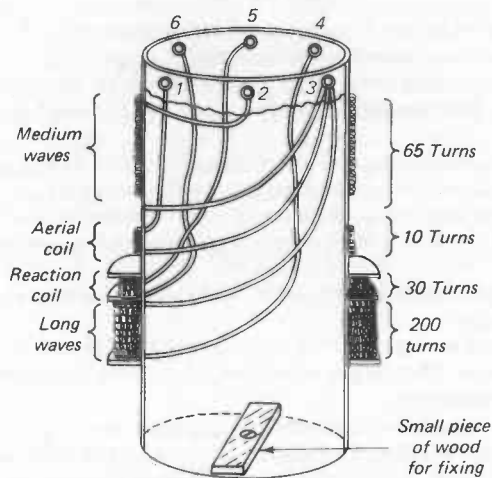

Figure 5 Medium and Long-wave Coil

Components required:

DCC wire, small terminals and former (see text)

If you have difficulty in obtaining satisfactory feed-back when operating C.2, you can try the effect of reversing the connections to 'D' and 'E'.

The third coil is quite large but is consequently easy to make and very versatile in its uses for simple receivers. It is illustrated in Fig. 5 and here are the winding instructions for this coil:

You need a 4 in. long piece of tube 2 in. in diameter. This can be postal tube made of cardboard or paxolin tubing (obtainable at Home Radio). You will also want some odd pieces of cardboard to make rings like those in the illustration. They have an internal diameter of 2 in. to slide on the tube and are about  $\frac{3}{4}$  in. wide. Stick them on the tubing in about the positions shown. If you use a cardboard tube it is advisable to varnish the whole thing inside and out with shellac varnish or a clear polyurethane varnish. Let it dry in the sun until hard (or in a very low oven!). The paxolin tube will not need varnishing. Fix six small terminals or 6 B.A. nuts and bolts round the top of the tube as shown. The wire used is 28 d.c.c. (double cotton covered). The medium wave winding is 65 turns and the ends of the winding are taken through a small hole in the tubing (made by a darning needle) to terminals 2 and 3. Then wind the aerial coil 10 turns in same direction and connect to 1 and again 3. Reaction coil of 30 turns is wound quite haphazardly in the first slot (again in the same direction) and connected to 5 and 6. Finally in the same direction wind 200 turns in the larger slot and connect to 3 and 4. Make sure the windings keep nice and taut. If they seem to be a bit loose because the holes are a little large you can always fix them tightly in the holes with a small piece of matchstick.

Thus we have completed a very useful, efficient, and quite old-fashioned coil but you can have fun using it in many designs. With this coil an aerial and earth are necessary but within range of a station quite a simple aerial will suffice. Like the much smaller DRR2 it is designed to cover medium and long wavebands and has two tuned windings and a reaction coil.

We now proceed to some practical designs in which we use some of the coils just described.



## Crystal Sets

Crystal sets are simple to build and cheap! With six feet of aerial this set will pick up the BBC programmes at good strength; with fifty feet of aerial the volume is really loud. Build the set with care, remembering that reception depends entirely upon aerial and earth.

These crystal set designs are chosen as the first in our constructional series because of their simplicity and cheapness. The most popular receiver for years was the 'crystal set', the theoretical design of which was precisely the same, in effect, as that shown in Fig. 7, our first design. Those old crystal sets, however, used large coils of thick wire and detectors consisting of a piece of crystalline substance 'tickled' by a small cat's whisker, which was only a piece of thin wire wound up into a small spring. Today we use a miniature coil and a germanium diode detector.

Germanium is one of the modern metals which have been developed for industrial purposes in recent years. A small flake of it is sealed into a tiny glass tube, with its cat's-whisker contact cemented permanently into place (Fig. 6).

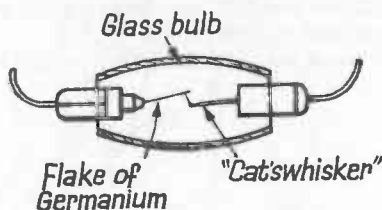

Figure 6 The Germanium Diode Detector

A crystal set has no power to amplify the signals which it receives via the aerial and the crystal detector merely converts the radio signals into currents capable of actuating the diaphragms of our headphones and producing sounds thereby.

It follows, therefore, that the strength of the sound we receive in the headphones depends on the size of the aerial we have – a larger aerial picking up 'bigger' signals – and the efficiency of the detector in converting them ('rectifying' them is the proper term) into 'sound' signals.

The germanium diode is much better as a detector in every way than the old

crystal detector and is completely stable in use. The modern crystal set, therefore, must not be confused with that of **fifty** years ago; it is best to discard the term 'crystal set' really in favour of 'germanium diode receiver'. The receiver in the Fig. 7 circuit is small and compact and very simple to make. With a good aerial it will give an extremely loud headphone signal from two or, possibly, three stations. It is essential to have a good aerial with a crystal set, and a good earth as well if this is possible. In North London, I could receive both the BBC Radio 2 (Light) and Radio 4 (Home) services with about 6 feet of wire. With 50 feet of aerial in the loft I could obtain Radio 1, 2, 3 and 4, with Radio 2 and 4 at extremely loud volume. The trouble then is that it is difficult to separate Radio 2 from Radio 4, and each programme has a slight background of the other.

From this you see that on medium and long waves *small aeriels mean good selectivity (i.e. power to separate stations) but small signals*, whereas large aeriels give *large signals but poor station separation*. If you live in a country district a long way

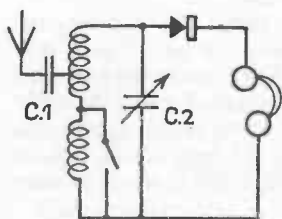

Figure 7 Crystal Set Theoretical Diagram

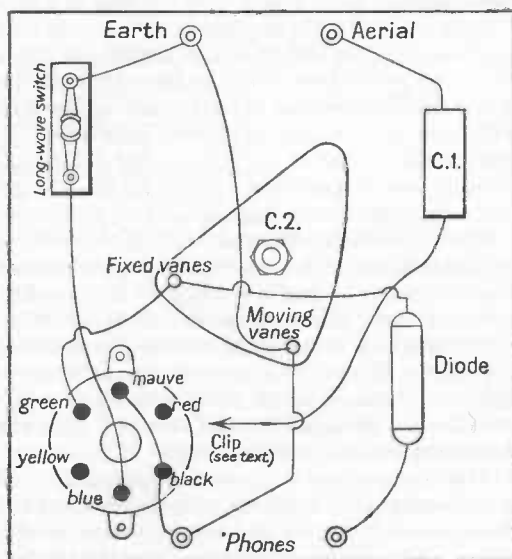

Figure 8 Crystal set Wiring Diagram

**Components required:**

- 0005 mfd. solid dielectric variable capacitor (C.2)
- On-off switch
- DRR2 coil (Repanco)
- 0002-mfd. fixed capacitor (C.1)
- Germanium diode (Osram GEX 35 or Mullard OA 81)
- 4 terminals or 2 double mounts
- Crocodile clip
- Wood, wire, etc.
- Tuning knob

from a BBC transmitter, and can erect a large aerial in the open air, you will probably get good results from the simple receiver; but if you live under twenty miles from a station for best results you need a more selective set.

Firstly, then, to build the set shown theoretically in Fig. 7 with a wiring diagram in Fig. 8, you need a piece of three-ply wood about 2½ inches square. If you have a particular box or cabinet to build the set into, and this requires a slightly larger size, it does not matter at all. You must drill holes for those components which are mounted on the panel; and these are the tuning capacitor in the centre, above and below it the 'A/E' and 'phones' terminals or terminal mounts. If you use the latter, the terminals affixed to them must protrude through holes to the other side, but terminals will automatically pass their shanks through the panel. The particular coil specified has a long-wave section and this requires an 'on-off' switch to short-circuit the long-wave section of the coil when medium waves only are required. As some of the holes may be a little larger than the drill you have available, an easy way to make them is to drill them out as large as possible and then 'reamer' them to size with the tang of a file or other tool.

After mounting those parts which require fixing to the panel, the soldering-up can be started; it will be found that remaining small items can be soldered into place and held into position by the wiring. Earlier remarks on soldering and wire to use may be referred to here, particularly the importance of clean joints made with a hot iron. Avoid 'dry joints' which look good but can be pulled apart quite easily and beware of applying a hot soldering iron for too long to the tags of components. In particular, do not let the iron get too near to the diode or remain too long on its connecting wires.

When soldering to the coil, be careful that the heat of the iron does not unsolder the wires already connected to the tags. Once the wiring has been completed and checked over, the headphones may be joined to the appropriate terminals, with aerial and earth also connected to their correct points.

Headphones must be of the 'high-resistance' type, i.e. 2000 or 4000 ohms impedance. If you have a pair of headphones which are low-resistance type, or yours are marked LR or 120 ohms, you can use them by interposing a special transformer (obtainable quite cheaply) between the set and the phones. Most dealers have these transformers.

After connecting the external apparatus, make sure the switch indicates the waveband required, that is, points *short-circuited*, cutting out the long waveband, if you want to receive on medium waves, and *open* if you want the whole coil in circuit for long-wave reception. Turn the knob slowly and you should pick up the stations available. A push-pull switch may not be available but any small on-off switch will do.

The coil specified is a Repanco DRR 2 and is really a coil with a reaction winding which is normally used in a one-valve or two-valve receiver. I have specified it for the crystal set because, in accordance with our promise of progressive set-building, it can be used for the receiver described in Chapter 4. In the design as given, using the DRR 2 coil, the 'reaction' winding is wired up so that it may be used as an aperiodic aerial winding which will give you a variation in selectivity. For this reason the lead from the aerial (through C.1) terminates in a crocodile clip.

This may be attached either to 'yellow' on the coil or 'red', in order to give the best position for the aerial in use. Try also fixing the diode to 'yellow' instead of to 'fixed vanes'.

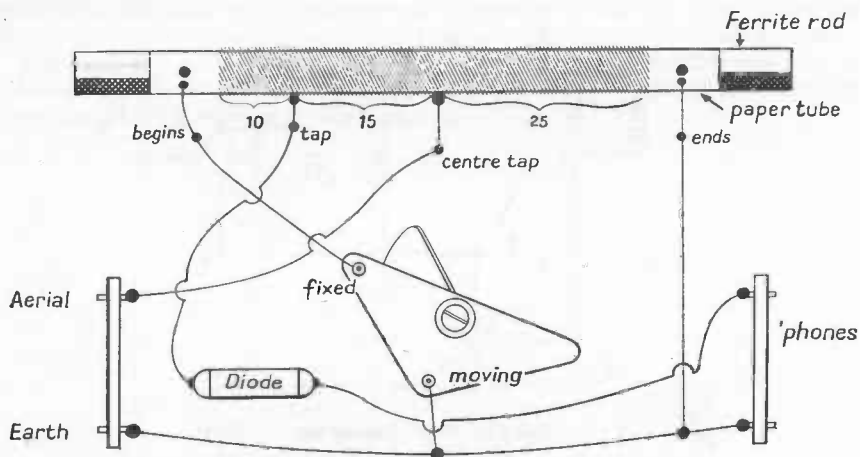
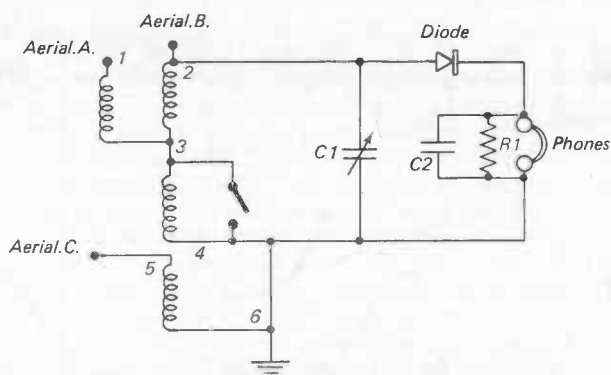

Figure 9 Crystal Set Wiring Diagram (home-made coil)

The second crystal receiver is very cheap and simple to make and uses the *BOP* coil which I first made up for use in two transistor receivers described in *Boy's Own Paper* in 1963. It is very easily wound on a ferrite rod which is 4 inches long and  $\frac{1}{4}$  inch in diameter. At the end of this chapter I repeat the instructions which we gave in *BOP* for winding it. The receiver in Fig. 9 can be put together easily in any handy box and will tune medium waves only, so that if you must get your Light programme on long waves, you would do better to make the design in Fig. 8. Components for this ferrite-rod coil design should be the same as those listed below Fig. 8 except for the coil, of course, which will not be required, nor will the on-off wavechange switch or the crocodile clip. The .0002 mfd. condenser (capacitor) will help selectivity if it is wired between the aerial terminal and centre-tap on coil. By the way, use two thicknesses of good writing paper or very thin card for making the coil. The wire should not be too close to the ferrite rod itself. You can experiment with this coil quite a lot, if you wish, by putting different windings on it. Readers have told me they have even been using it for short-wave reception in a transistor receiver by using fewer turns and adding a reaction winding. For this crystal receiver, it might be found better to use a tuning condenser of only 200 pf (i.e. .0002 mfd.) instead of the .0005 mfd. one specified.

If you build these crystal sets, remember that reception is *entirely* dependent upon the aerial and earth in use. If these are poor, good signals cannot be expected. *Poor signals cannot be amplified or adjusted to make them louder.* A crystal set connected to an amplifier such as the 'small high fidelity' described later makes a very satisfactory arrangement for local station reception. For 'reaching out' and

for louder signals a valve detector is required. Do not take your crystal set to pieces unless you have no alternative. The next design shown in Fig. 10 uses the large home-made coil of Fig. 4.



**Figure 10 Diode 'Crystal Set'**

*Components required:*

- Coil: see text (home made type)
- C.1. .0005 mfd variable capacitor
- C.2. .001 mfd fixed capacitor
- Diode: any suitable of good quality
- R.1.: 1000 ohm resistor
- Phones, wire, wood, etc.

The crystal set shown in Fig. 10 is very simple to make. Fix your coil on a small piece of wood in the manner shown. On one side of that piece of wood fix a small panel on which are mounted the tuning capacitor and two small terminals or a socket strip for phones. Also required will be a small on-off switch for wavechanging. Connect 2 on the coil to one side of diode and fixed plates on the tuning capacitor. Other side of diode to phones. Other side of phones to 4 on coil and 4 on coil also goes to one side of on-off switch plus 6 on coil and moving plates on capacitor. Other side of on-off switch to 3 on coil. Across the phones terminals connect a .001 mfd. capacitor and if you are using a crystal earpiece you will also need a 1k $\Omega$  resistor there. For ordinary headphones (high-resistance) no resistor is needed. The aerial can be attached to a 'crocodile' clip and tried for best results on 1, 2 or 5 on coil. Earth can be clipped to 4 or 6, or you can add two more terminals to the panel for A & E. Your set should now work well and, having fixed a small knob to the shaft of the capacitor, you can tune in the available stations.

Figures 11 and 12 are rather special crystal set designs and I am indebted to Messrs Repanco Ltd, whose copyright designs they are, for allowing me to use them here. The coil featured is the DRR2 which they make and the first circuit is for a headphone crystal receiver which uses 2 diodes and 1½ volt cell. It is rather

specialised so I have only given the theoretical diagram and any interested reader will no doubt be able to make it up from that. The other circuit is a 'bandpass' design using two coils and a twin-gang .0005 capacitor for much higher selectivity. It is designed to feed an amplifier such as that in Figure 20. It could also be used as the front-end of Figure 15, the signal being fed into C2 of that diagram.

These crystal receivers can give very good results at little cost and can be interesting and instructive to make. We hope you enjoy them and pass now to a more complicated receiver which uses a valve.

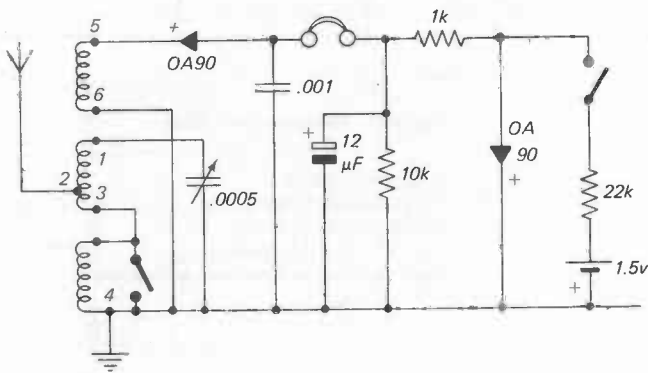

**Figure 11 Self-biasing Crystal Receiver**

*Components required:*

- Repanco DRR2 coil
- .0005 mfd. variable capacitor
- 2 Diodes OA90 or similar
- .001 mfd. fixed capacitor
- 12 mfd. 10v. wkg. electrolytic capacitor
- 1 × 1KΩ resistor; 1 × 10KΩ resistor; 1 × 22KΩ resistor
- 1.5v battery, wire, connectors, phones, etc.

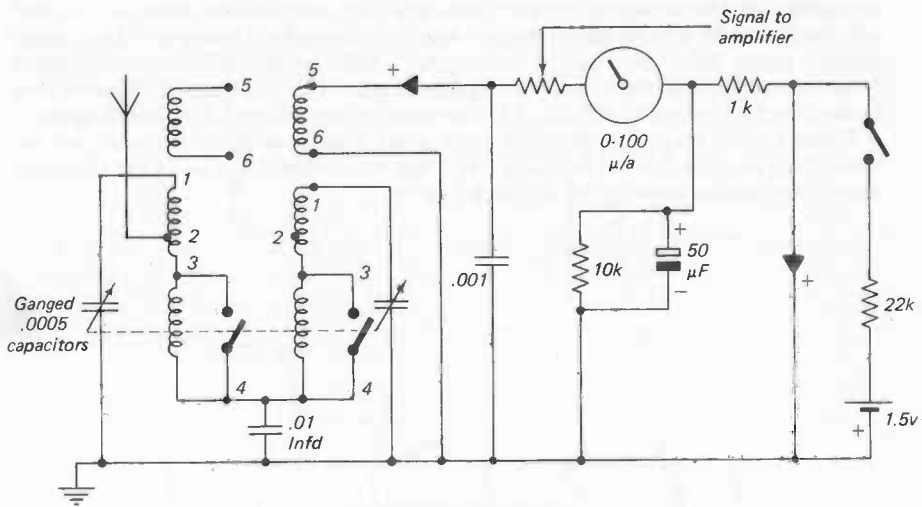

**Figure 12 Bandpass feeder Unit**

Components required:  
 2 Repanco DRR2 coils  
 2 Diodes, OA90 or similar  
 .0005 mfd. ganged capacitor  
 fixed capacitors, resistors, etc. as diagram





receiver which will give you good practice in set building and operating. It is a logical follow-on from your crystal receiver. You can either pull that to pieces and use most of the parts to build this one-valver, or you can purchase a completely new set of components. The latter is the better idea, as it is practicable to have a crystal set on hand constantly (it is particularly useful for testing amplifiers).

The one-valve set is built as a 'hook-up', that is to say, it is just laid out on a panel and baseboard and wired-up without a great deal of attention to super-efficiency, or to building it into a cabinet. You can take these liberties with a small set of this kind for medium waves, but do not try to do it on short waves or with a more complicated set, as trouble will result.

You need a small, shallow chassis, 4 or 5 inches square, and I suggest you make a kind of box out of some odd bits of wood. Take two fairly thick pieces of wood, say five-ply or similar, about 5 inches long by 1½ inches wide, and two more pieces of the same size, but of thinner wood such as three-ply. Now, with a few ½-inch panel pins, join the ends together so that the four sides form a kind of box without top or bottom. Then obtain a piece of three-ply or other thin wood, 5 inches square, and fix that on to form the top of the chassis. It will overlap at one end, but this does not matter.

For a more complicated set, such as a short-wave set, it is necessary to cover the chassis with metal foil, or to buy or make it of metal. Two more strips of thin wood are required for mounting the capacitors, say two pieces 6 inches by 2 inches, and these can be screwed at one end to one of the thicker sides. If you prefer to use a complete panel here, say 6 inches by 5 inches, there is no objection. Each of these pieces requires suitable holes in it at about 1½ inches above the top of the chassis, to accommodate in one case the .0005-mfd. variable capacitor, and in the other the one of .0001 mfd.

The chassis needs a hole near the back for the small valveholder. If you use the solid dielectric capacitor from, or similar to that in, the crystal receiver, you will see that it is quite compact. You can put your valveholder somewhere in the centre of the chassis. With a .0005-mfd. air-dielectric type, however, you need more room and have to put the valveholder more to the rear.

The diagram makes it clear how the chassis is constructed and also how the set is wired up. *Be very careful over the wiring-up as an error can put the high-tension voltage on the valve filament, destroying it completely.* After wiring-up it is a good idea, before inserting the valve, to connect up both HT and LT batteries and to place a 3-volt flashlamp bulb across the LT tags on the valveholder. If it lights up all is well. If it fails to do so or 'blows', a careful check is needed.

You can obtain a special battery which incorporates LT of 1½ volts and HT in one unit. If you use this you need the special plug which goes with it, but I think you will find it an expensive way of buying batteries. For general experimental work, buy a fairly good-sized 1½-volt dry cell and a standard-size HT battery of say 45 volts. For headphone work this should be an adequate voltage and furthermore it is a perfectly safe voltage for you to use. The wiring checked, the valve can be inserted and aerial, earth and phones connected up. A large aerial is not really necessary - try out whatever you have available, or 20 feet of wire round the picture rail or thrown from an upstairs window.

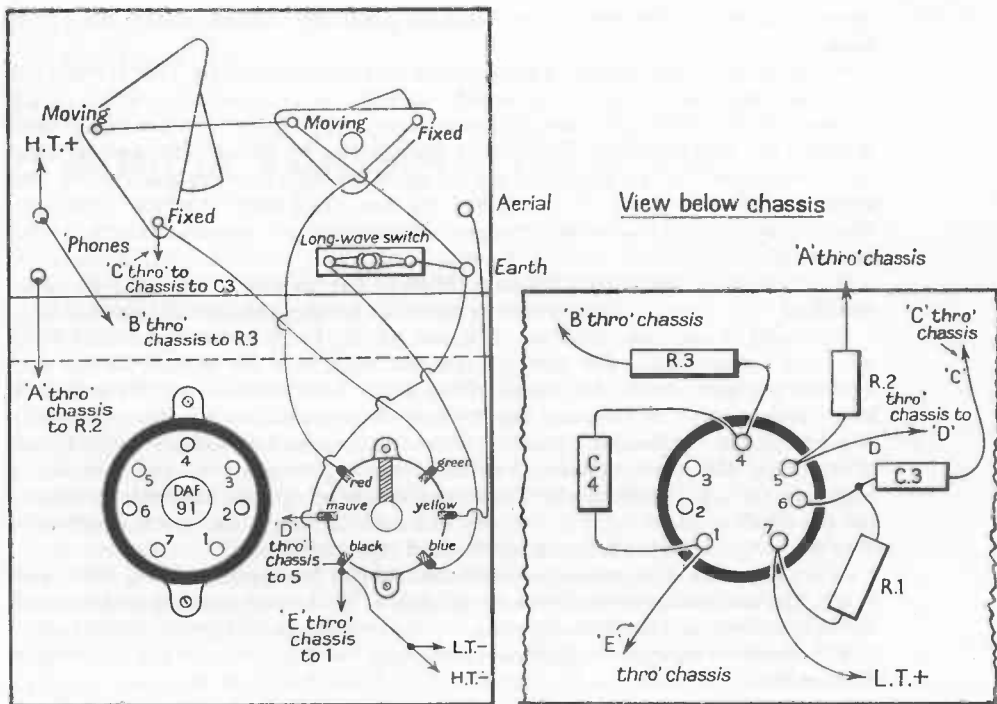

Figure 14 View below chassis

Do not worry if you cannot make an earth; the set should work without it. For economy's sake there is no switch on this hook-up. When you connect up the 1½ volts and the HT the set is 'on'. *Do not forget to disconnect the LT each time you finish listening, or you will run down the batteries very quickly.*

The two variable capacitors should be fully open, which normally means turned fully to the left. Try gently increasing the capacity (i.e. enmeshing the vanes) of the reaction capacitor (the smaller one of .0001 mfd.) by turning the knob to the right. The noise in the phones builds up until a 'howl' is heard. That means the receiver is oscillating; it must never be left or used in that condition as it interferes with the reception of other listeners and is an infringement of the PMG's licence conditions.

If the receiver fails to oscillate at any point even with the reaction capacitor fully enmeshed, there is a wiring fault somewhere and this must be checked over. It could be a 'dry' soldered joint or wiring which is too long and rambling, or even insufficient HT voltage. It is essential for correct operation of the receiver that

smooth reaction is obtained which builds up gradually to an oscillation howl at its peak.

If you can now read theoretical diagrams, you will see from Fig. 13 that there are three windings on the coil, one an aerial winding, the next the grid winding which is tuned by the .0005-mfd. capacitor to the frequency of the required station, and thirdly a reaction winding. This last is connected to the anode but coupled to the grid winding so that energy from the anode is fed back into the grid circuit. The amount of the feedback is controlled by the .0001-mfd. reaction capacitor. Reaction secures an enormous increase in amplification – a great advantage over the crystal detector.

You can use a DF 91 (or IT4) or a DF 96 (1 F1) instead of the DAF 91 valve specified, if you wish, but take care to make the correct joins to the valveholders.

Reverting to our one-valve set, reaction having been tested and found to be working satisfactorily, the tuning capacitor may now be moved slowly and stations brought in. As the vanes of the tuner become more enmeshed, so it becomes necessary to increase the capacity of the reaction capacitor. Normally you search for stations by operating the tuning capacitor with the right hand, maintaining the reaction control in the correct position with the left. For a beginner, it is a good idea to disconnect the aerial and operate the controls so as to get the 'feel' of them, and to be able to maintain the set in its most sensitive condition, which is just before it 'spills over' into oscillation.

This one-valve design is a very suitable subject for experimenting with, and much fun with radio arises from experiments. In this set another make of coil could be substituted for that originally used, any difference in results being noted.

The specified valves are obtainable from RST Valve Mail Order Co. (address in Appendix).

## A Simple Transistor Receiver

Transistors are a modern scientific wonder and have revolutionized amateur radio. The receiver described can be a pocket set using a crystal type earpiece, or you can build it in a large box with a loud-speaker added.

The first edition of this book ended with a chapter about short waves and short-wave receivers. When the publishers decided the book should be completely revised, that chapter had become obsolete because the valves and coils mentioned in it had gone out of production and, in any event, we had by then produced our book, *Fun with Short Wave Radio*. Our fourth title in the series, *Fun with Transistors*, has been published, but we are not deleting from this book the chapter headed as above as we hope it will serve as an introduction to transistors. These are now so important, and will also make you want to continue to learn more about, and experiment with them, by reading *Fun with Transistors*.

If your dictionary or encyclopaedia is more than, say, five years old, it is doubtful if the word 'transistor' appears in it, for the component to which it is applied was not invented until 1948. Briefly, it is what is known as a semi-conductor and was developed from that other semi-conductor, the germanium diode, such as was used in the crystal-set designs in Chapter 3. At the end of that chapter we said that the diode detector cannot amplify poor signals, and nor can it still; but it has been discovered that by the addition of a third contact to the 'crystal', it acquires the power to amplify.

When you consider that a dozen normal-sized transistors can easily be contained in an ordinary thimble, you can imagine the great advantage their use could be in such items of equipment as electronic computers, TV cameras, aircraft radios etc., and in home radio and TV sets. Some transistors have been developed which are no larger than a pin-head. In all these applications many valves had been used; and although modern valves are small, the even smaller size and absence of heat dissipation and heavy power requirements of the transistor make it invaluable. Transistors are still not yet as useful as the valve in some industrial applications, but have now superseded valves at least in modern radio receivers, television and 'gram' equipment.

The simple receiver described here consists of a diode 'crystal' detector feeding into an amplifier using two transistors. If more volume is desired, three transistors could be used but, in view of the simplicity of the design, selectivity is limited by that given by the coil used.

A large aerial may mean some overlap of the stations received. The layout of the

set is very easy and I have made no attempt to suggest how you should do this. You can build the whole receiver into a fairly large box with the loud-speaker included, or you can make a small pocket set incorporating a 'deaf-aid' type earpiece. Incidentally, either low- or high-resistance headphones work quite well with transistors. In the same way, you can use a normal output transformer for feeding the loud-speaker, or a transistor output transformer, or can buy a special loud-speaker wound with a few hundred ohms impedance for use with transistors.

The easiest way of making up the set is to use one or two tag-boards, obtainable

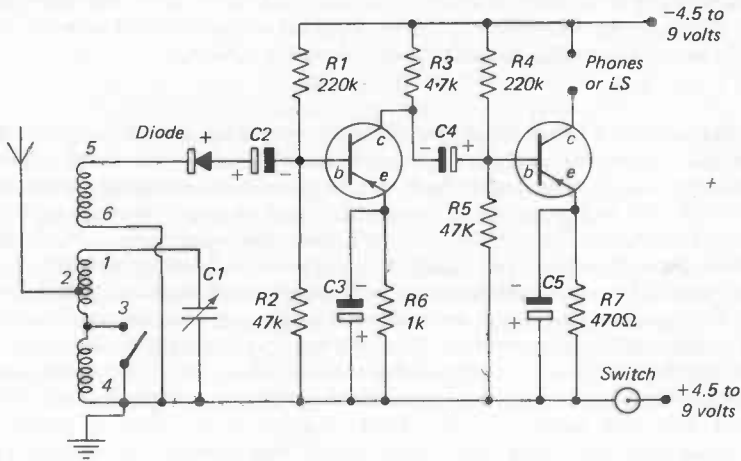

Figure 15 Two-Transistors plus Diode Receiver

*Components required:*

Repanco DRR2 Coil

C.1. .0005 mfd. (500 pf) variable capacitor (air or solid)

C.2. } 2 mfd. fixed electrolytic capacitors  
 C.4. } { working voltage  
 C.3. } need not exceed  
 C.5. } 8 mfd. fixed electrolytic capacitors  
 15 volts

R.1. } 220,000-ohm ¼-watt resistors

R.4. }

R.2. } 47,000-ohm ¼-watt resistors.

R.5. }

R.3. 4,700-ohm ¼-watt resistor

R.6. 1,000-ohm ¼-watt resistor

R.7. 470-ohm ¼-watt resistor

OA91 Diode

Two transistors: audio type such as OC 71 (Mullard)

Battery 4.5 to 9 volts (see text) Ever-Ready

Small switch, aerial, earth, phones, sockets, tagboards, knob

Suitable cabinet; also phones or LS (see text)

for a few pence from most component dealers. It is essential to make good soldered joints and when soldering the wires of the transistors a 'heat-shunt' must be used. This is to prevent the heat from the soldering iron from running up the wire lead into the transistor and destroying it. This is very important and the best way of doing it is to grip with a pair of pliers (or get somebody else to do it) the lead of the transistor at a point between the soldering iron and the transistor. Any heat from the soldering iron will run up the lead, but will be dissipated by the pliers and so will not enter and damage the transistor. Wrong 'polarity' connection of the battery can also destroy the transistor - that means, do not reverse your plus and minus connections of the battery at any time. You will see that the circuit diagram of the transistor set has the battery connections reversed when compared with what you expect as regards a valve set. The HT negative line is at the top of the diagram, and at the bottom, which is, as usual, the earth line, the HT positive is connected. Our set needs between 4½ and 9 volts and you can use either a flashlamp battery or the special PP4 transistor 9-volt battery, which is very small and made by Ever-Ready specially for transistor receivers. There is no need to use what are called 'miniaturized' components for this receiver unless you are attempting something extra small; normal battery-set types will be adequate and are cheaper than the tiny types.

Purchasing transistor components has been discussed in Chapter 1 and addresses are given in the Appendix of firms supplying them and literature to assist you in further experiments with these fascinating little items. Prices of very

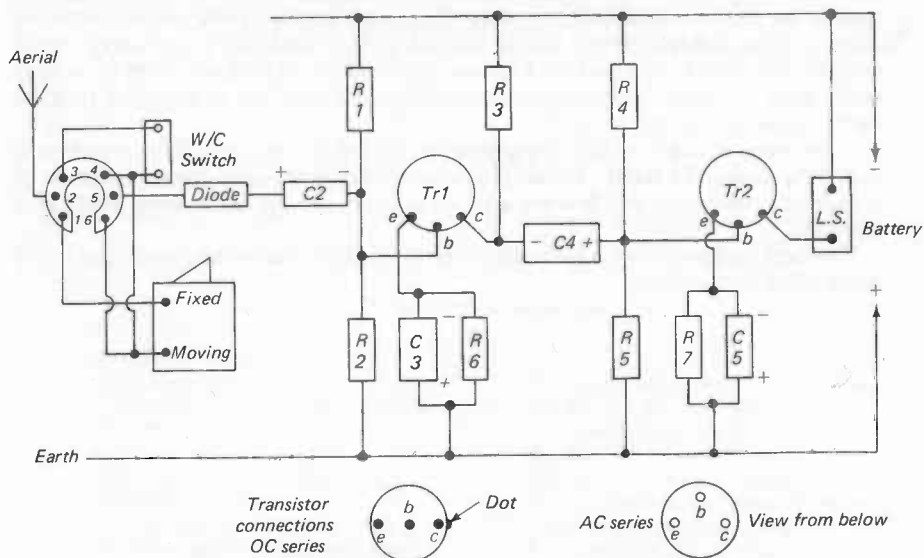

Figure 16 Wiring diagram for Figure 15 circuit

reliable types are lower now than in earlier days and there is no doubt a very wide field open for a great deal of experimental fun to be obtained from them. In this connection there are two further points I should mention. Firstly, do not bend the connection leads of the transistor too near to its seal – not less than  $\frac{1}{16}$  inch is a good rule to follow. Secondly, if you want to try three transistors in the set described here, try repeating the first stage after the diode detector. That is to say, make all component values the same as those surrounding Tr. 1. The volume then may justify the use of a larger output transistor such as the OC72.

Transistors which, in 1978 will be 30 years old are the hand-maidens of the electronic age which seems to rule our lives today. Their use in radio and television is probably quite a minor one to their rôles in such modern items as computers, jet-aircraft, space-craft and missiles. The receiver just described is a very simple application of the transistor and, as already mentioned, more complicated designs are described in *Fun with Transistors*. The superhet receiver shown in that book as a kit is probably no longer available but there are many similar home-constructor kits available as are mentioned in Chapter 13. If you are interested in short-wave receivers there is a transistor design for one in our title *Fun with Short Wave Radio*. There is also a simple design in the RSGB handbook *Amateur Radio*.

I believe it is correct to say that today only solid-state radio receivers are produced commercially, which means that they use transistors and diodes, not valves. The transistor receiver also is being mains-operated these days and the ever-recurring cost of renewing batteries is avoided for the receiver, which is mainly used for home listening rather than as a portable. They are also built, of course, on a printed circuit board instead of the old-style large heavy metal chassis. For home construction I favour the modern modular system by which ready-built 'modules' are purchased and connected together, as required, to build up the desired system.

Even more modern is the integrated circuit, or IC as it is called, which is a complete circuit in itself. These are manufactured in one piece inclusive of transistors, resistors, condensers and so on and can be made very small and compact.

Our next design is also a transistor receiver but of a different circuit and it is a more sensitive receiver.

# Reflex Pocket Transistor Receivers

The fun in building these receivers comes from many experiments with different types of transistors. Remember, all transistors are sensitive to heat, so you will need a 'heat shunt' between the soldering iron and body of the transistor. Remember too, that neither the panel nor the cabinet may be metal; you must use hardboard or plastic, with a wooden cabinet.

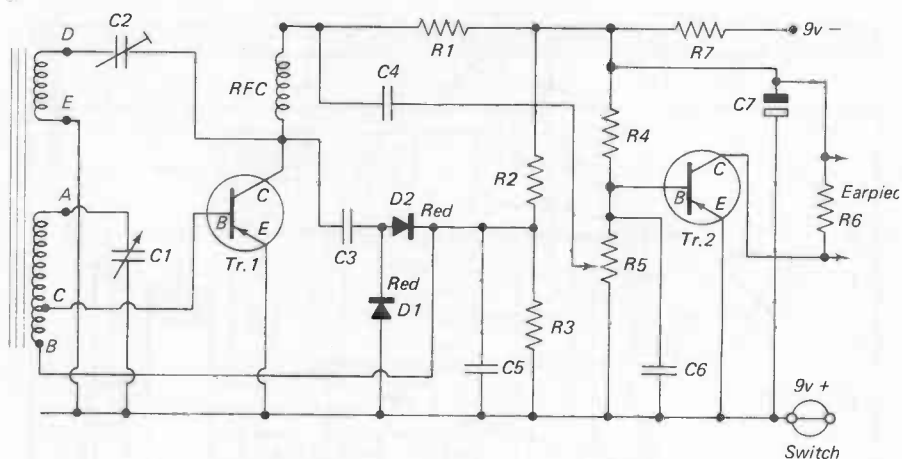

Figure 17 Reflex transistor receiver

*Components required:*

Coil - home-made see Fig. 4.

C.1. tuning variable capacitor .0005 mfd.

C.2. trimmer (pre-set)

C.3. Fixed capacitor 200 pF.

C.4. Fixed capacitor 0.1 mfd.

C.5. Fixed capacitor 0.01 mfd.

C.6. Fixed capacitor 0.01 mfd.

C.7. Fixed capacitor electrolytic 25 mfd.

D.1. and D.2. Diodes such as OA91

Tr. 1. Transistor such as OC44

Tr.2. Transistor such as OC71

RFC. Radio frequency choke med. wave

R.1. Resistor (fixed) 3.9 K/ohms

R.2. Resistor (fixed) 100 K/ohms

R.3. Resistor (fixed) 5.6 K/ohms

R.4. Resistor (fixed) 220 K/ohms

R.5. Miniature variable resistor 5 K/ohms

R.6. Resistor (fixed) 4.7 K/ohms

R.7. Resistor (fixed) 1 K/ohms

Battery connector for PP3 battery

Wire, case, phones, etc.



One of the earliest designs for a pocket transistor receiver is shown in Figure 17 and is what might be called the classic design for such a set. It employs two diodes, two transistors and a home-made ferrite aerial coil. The output is to a small crystal earpiece and the size can be quite small enough to fit in the pocket. It employs PNP transistors and almost any type may be used in it. The pleasure of building a receiver like this comes from experimenting with different types of transistors.

In the original design I used the OC44 for Tr 1 and OC71 for Tr 2 but you could try an AF 117 and an AC 127 or, indeed, any similar transistors in other makes, those mentioned being Mullard. The diodes can be OA 81 or OA 91. If you are going to try different transistors it is a good idea to use two transistor holders instead of soldering the transistors themselves into the circuit and you can then plug in any types you wish to try out.

Do not forget that transistors are sensitive to heat and if you are soldering direct to their 'legs' you need a heat shunt between the soldering iron and the body of

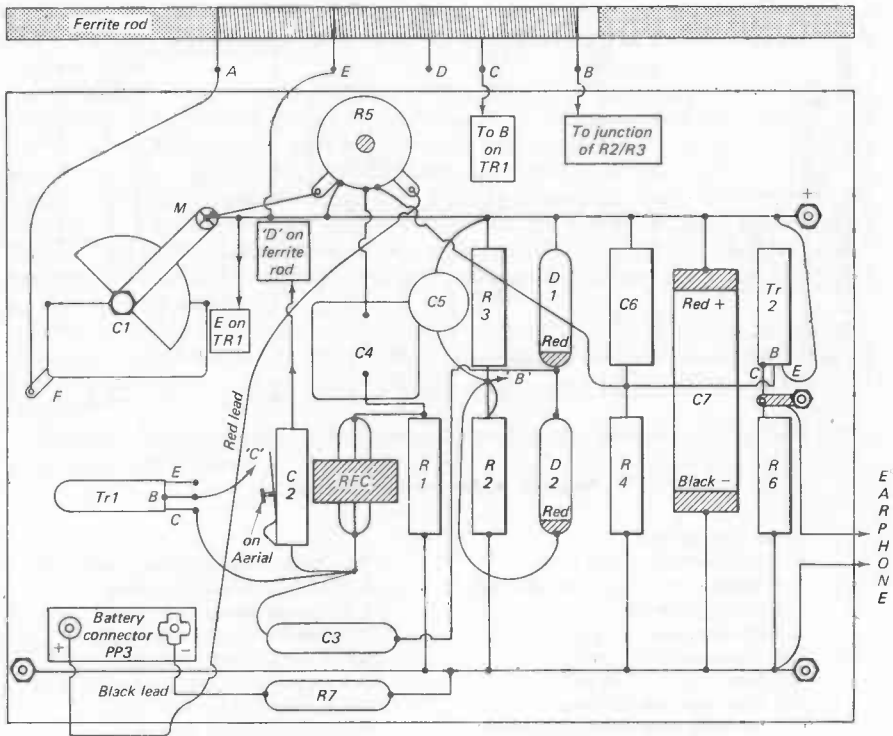

Figure 18 Wiring diagram for Figure 17 circuit

the transistor. A good one is supplied with the Antex soldering kit or you can buy it separately from Home Radio. Figure 18 gives the wiring diagram of the receiver and you will find coil making details in Chapter 2. The set can be built on a piece of hardboard or plastic of any suitable size and you can build a small wooden cabinet round it. Of course, you may already have a suitable box handy so can adapt the size to fit into that but *neither panel nor cabinet may be metal*.

This receiver uses reaction which is controlled by C2 and once set this small capacitor is left alone. To set it, slacken off the screw so that the plates open and tune in a station at the lower end of the waveband such as Radio 1 on 247 metres or Luxemburg right at the bottom of the band if you can receive it. Now tighten up the screw of C2 and the volume should begin to increase until the set 'spills over' into oscillation. Slacken off very slightly so as you have a good clear signal and

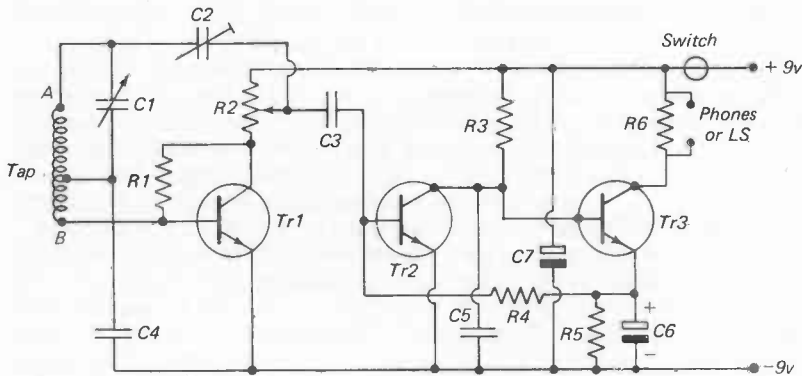

Figure 19 Transistor receiver for NPN transistors

*Components required:*

- Coil: home-made see figure 3
- C.1. Tuning capacitor ·0005 mfd.
- C.2. Miniature trimmer capacitor
- C.3. ·02 mfd. capacitor
- C.4. 0·10 mfd. capacitor
- C.5. 0·01 mfd. capacitor
- C.6. 200 mfd. electrolytic capacitor } 15 volt
- C.7. 200 mfd. electrolytic capacitor } wkg
- R.1. Fixed resistor 100 K/ohms
- R.2. Miniature variable resistor 5 K/ohms
- R.3. } Fixed resistor 100 K/ohms
- R.4. }
- R.5. 56 ohms or to suit transistor used
- Transistors: BC108 BC109 or similar
- R.6. 3·3 K/ohms fixed resistor
- Phones, wire, etc.

that's it! It is a rather delicate process and needs to be done carefully for the best results.

The receiver just described is, as I have said, the classic circuit of its type for PNP transistors (which are made of germanium). The latest transistors in use are made of silicon and are NPN types. I have given you the classic design for a pocket receiver using them in Figure 19. This would use Mullard transistors type BC 108 or BC 109 or similar and is a very good circuit for experimenting. It can be built to a similar layout to that shown in Figure 18 and is operated in the same way. In this circuit C2 needs to be as small as possible and is set in the same manner as for the other receiver. Take care to note that whereas in Figure 17 the positive line is at the bottom of the diagram, it is the negative line at the foot in Fig. 19. The NPN transistor takes its voltage the other way round from the PNP types.

## A Transistor Amplifier

Here's a classic design to give very good results, with a simple amplifier. Use it for playing records or feeding from a crystal set. Several simple, useful designs are easily made using the Denco coils and components.

This is another classic design which has become standard for a simple amplifier, giving good results; it is particularly useful for playing records or for feeding from a crystal set. It comes from one of the maxi-G Technical Bulletins which are issued by Denco (Clacton) Ltd (address in Appendix). Denco have been supplying coils and components for the home-constructor for as long as I can remember and their technical bulletins are packed with simple, useful designs. I commend them to readers and suggest that they write to Denco enclosing a stamped addressed envelope for the latest details and cost of publications.

I am grateful to Denco for allowing me to reproduce Figure 20 here. There is little I can add to assist you in making up the amplifier, the easiest method being to use a tag-board or group-board (Home Radio). On one side you run a bare wire from one end of the board to the other, this being the earthed positive line and many of the items are anchored to this. The other tags may be used as anchor points for the other items.

It is important to use the correct resistance for the loudspeaker which is given as 8 ohms. Do not use one of lower resistance as you can damage the output transistors. You will find that the resistance of the loudspeaker is an important factor in modern transistor designs where the loudspeaker is actually part of the circuit and not isolated by a transformer as in a valve design.

The  $130\Omega$  resistor shown as R7 should, if possible, be the correct negative temperature coefficient thermistor in the interest of temperature stabilisation. Mullard make one, the VA1040. To set up the amplifier the  $200\Omega$  variable resistor R8 should be set to mid-point, then with no signal and a 9v supply, a meter should be inserted in the collector lead of the AC 127 output transistor (the bottom right in the diagram) and the current adjusted to  $5\text{mA}$ . If you have no meter or cannot borrow one just try adjusting R8 for the best results.

This amplifier gives what is known as a 'mono' output and for 'stereo' a double (or two) amplifier is needed plus two loudspeakers. Our next design deals with such an outfit.

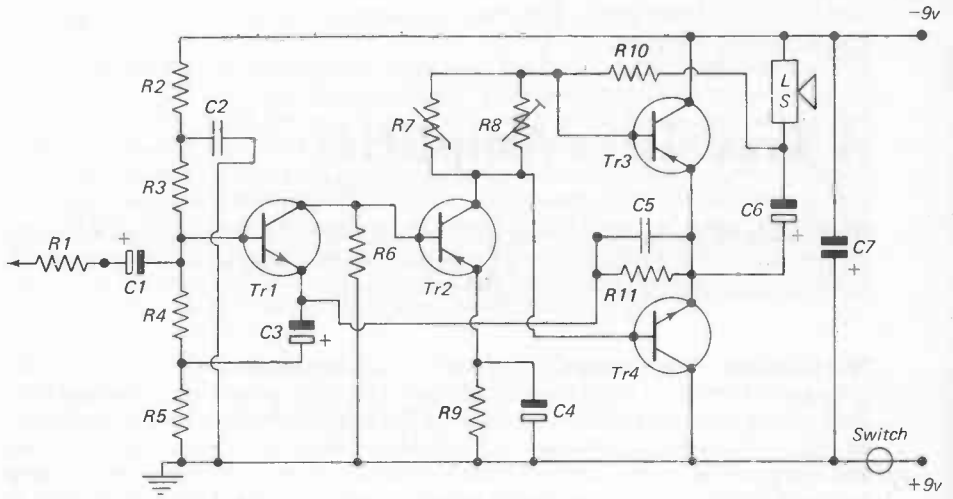

Figure 20 Transistor amplifier

*Components required:*

- R.1. Fixed Resistor 5.6 K/ohms
- R.2. Fixed resistor 2.2 K/ohms
- R.3. Fixed resistor 15 K/ohms
- R.4. Fixed resistor 15 K/ohms
- R.5. Fixed resistor 5.6 ohms
- R.6. Fixed resistor 1.5 K/ohms
- R.9 Fixed resistor 39 ohms
- R.10. Fixed resistor 510 ohms
- R.11. Fixed resistor 2.2 K/ohms
- R.7. 130Ω negative temperature coefficient thermistor VA1040NTC
- R.8. 200Ω pre-set resistor
- C.1. 2 mfd. fixed electrolytic capacitor 15v. wkg.
- C.2. 125 mfd. fixed electrolytic capacitor 15v wkg.
- C.3. 400 mfd. fixed electrolytic capacitor 15v. wkg.
- C.4. 320 mfd. fixed electrolytic capacitor 15v. wkg.
- C.5. .0047 mfd. fixed capacitor
- C.6. 320 mfd. fixed electrolytic capacitor 15v. wkg.
- C.7. 640 mfd. fixed electrolytic capacitor 15v. wkg.
- Tr.1. AC127 Tr.2. AC128 Tr. 3. AC128 Tr. 4. AC127 (Tr. 3 and 4 matched pair)
- L.5. 8 ohms only. On-off switch, 9v. battery, wire, etc.

## A Stereo Amplifier

Although we can use two independent amplifiers, a double amplifier can easily and successfully be compressed into a small unit, thanks to the modern integrated circuit. First-class stereo results with very low distortion make this design outstanding.

There is little need to explain what is meant by 'stereo', I am sure, as readers will be aware of stereo discs (or records) and also many of the radio programmes today are in stereo. Briefly, the signal is split into left and right components so that sound on the left of the studio is heard to the left of the receiving room, and that on the right to the right of the hearer. This means we need an amplifier for the left-hand sound components and another for the right-hand, plus a loudspeaker for each amplifier.

Although we can use two independent amplifiers, thanks to the modern integrated circuit, a double amplifier can be easily and successfully compressed into a small unit. Such is the Sinclair IC 20 which gives first-class stereo results with very low distortion and which is the subject of the present design. Details are given in Figure 21 and (c) of that figure shows the basic layout of the printed circuit board which incorporates the two IC's and is ready connected up for use. The requirement by way of 'high tension' voltage is 24 volts only so the apparatus is quite safe and runs quite cool. The Sinclair mains unit is shown at (d) but there is no objection to another make (or your own home-built one) being used.

A tone control stage is very desirable and this is at (a) and shows one side of the stereo link only. It needs to be repeated for the other side but the volume and balance controls given at (b) are incorporated for both left and right sides. The purpose of a balance control is to ensure that the same level of sound comes out of each side as it is somewhat frustrating if the left-hand speaker is very loud whilst the right-hand can hardly be heard. All kinds of reasons may account for incorrect balance so that controls to level out the sound are necessary.

With the IC 20 comes a most comprehensive booklet explaining the design, the layout and other details to assist in putting together the amplifier so I do not propose to discuss this further; if you obtain the kit a comprehensive booklet comes with it and as the details are peculiar to the IC 20 there would be little purpose in reproducing for them readers who do not have the kit.

I have seen IC 20 amplifier kits offered for sale at advantageous prices by many mail-order houses advertising in the radio journals so I suggest you consult one of them. However, if you do have difficulty, there are many similar (and

reasonably-priced) items on the market and advertised in the same journals. One such advertiser is BI-PRE-PAK Ltd (address in Appendix) who make STIRLING SOUND products, one of which is featured in Chapter 10.

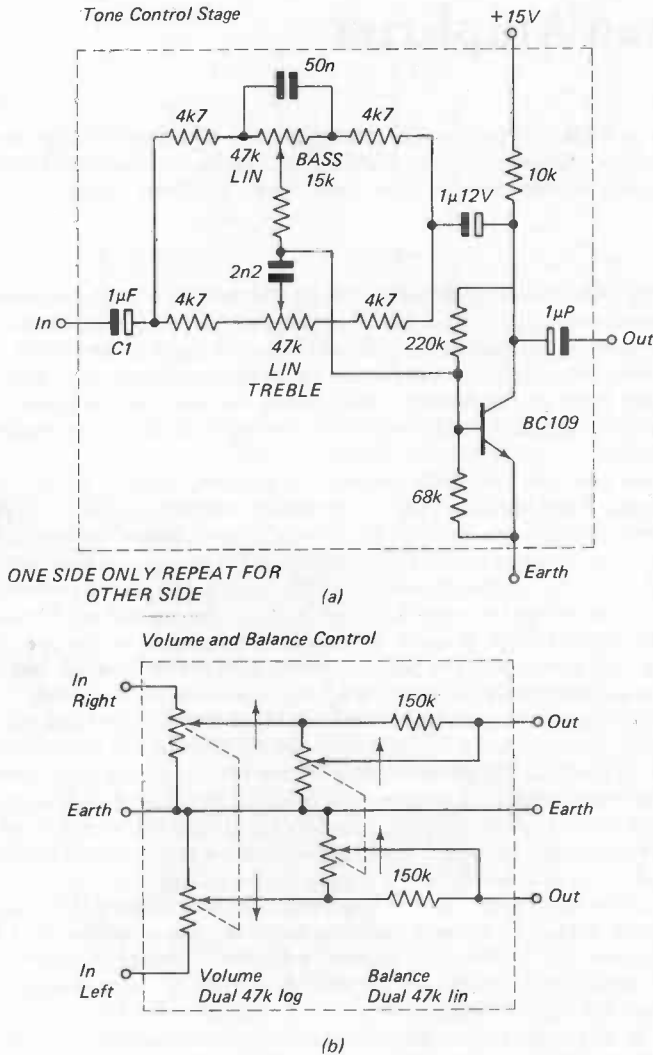

**Figure 21** Sinclair IC20 stereo amplifier (Production ceased but many still available)

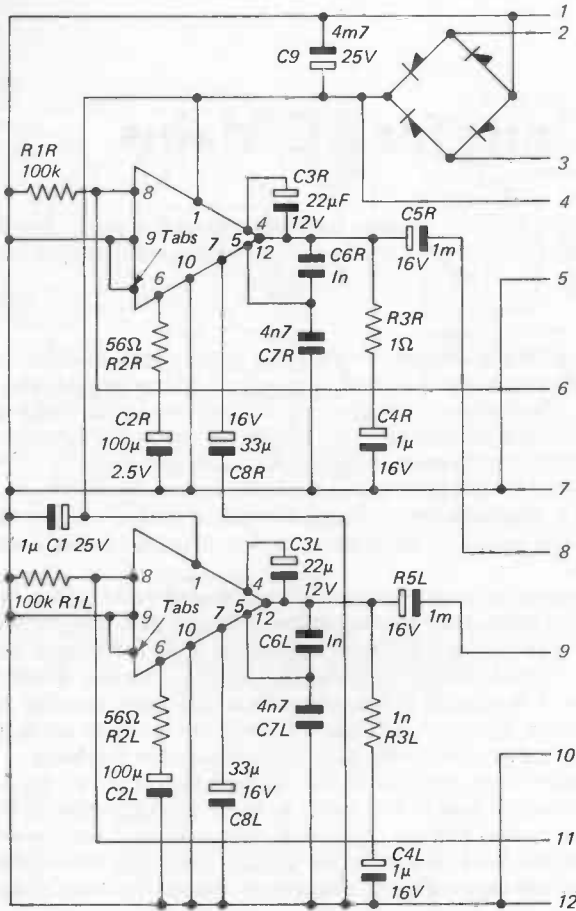

**PCB Layout & Connections**

- 1 DC power-VE (earth)
- 2 } AC power input (18V max)
- 3 }
- 4 DC power + VE
- 5 signal earth
- 6 signal input right
- 7 output earth
- 8 output right
- 9 output left
- 10 alternative output earth
- 11 signal input left
- 12 alternative signal earth

**STEREO AMPLIFIER (SINCLAIR IC 20)**

(c)

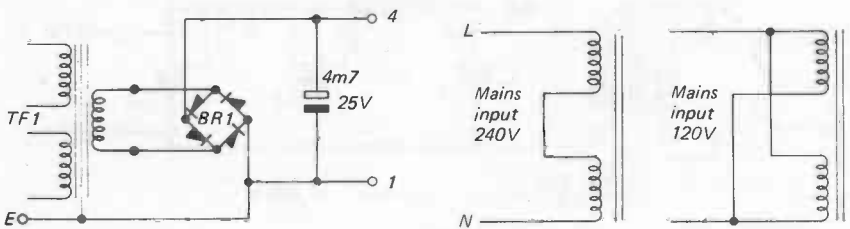

(d)



## Mains HT Units for AC Mains

Now you can supply High Tension Voltage for some of your battery sets by building a Mains HT Unit. Components are few in number and cheap to buy. Running costs are very low. Go to it!

This unit is designed to supply high-tension voltage for battery sets, such as the 1-valve already described, which are designed to run from batteries and which use battery-type valves. This means that the dry battery which is used for supplying the filament heating must still be used, but this is not a very expensive item and occasional replacement of a battery costs but a shilling or so.

The advantages of a mains HT unit (and it is only for AC mains, by the way) are the continuous supply of a relatively high voltage compared with a battery: the fact that the voltage does not gradually deteriorate as does that of a battery: and the very low running cost.

Components are few and quite cheap. First of all is a transformer which has three windings, the primary tapped for varying mains voltages between 200 and 250 and two secondaries, one giving 120 volts at a current of 40 milliamps, and another which is a centre-tapped 10-volt winding (at 1 amp.). This last winding we disregard in our present design. It is for use with a half-wave rectifier for trickle-charging accumulators, but as it requires a couple of meters to set it up properly, it is felt it is outside the scope of the designs presented in this book.

The primary is connected so that one side of the mains is connected to the 'O' end of the winding and the other side of the mains to the correct tapping on the winding, according to the mains voltage. You will note a switch for 'on-off' purposes is interposed in one lead. If the mains voltage does not correspond exactly with one of the marked tapings, the connection should be made to that

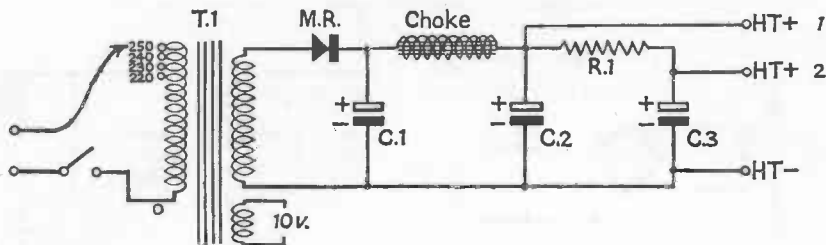

Figure 22 Mains HT Unit. Theoretical Circuit

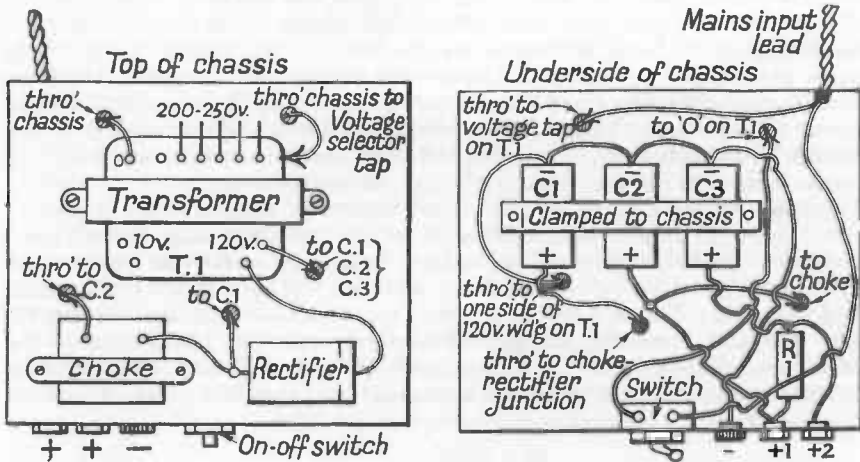

Figure 23 Wiring Diagram

*Components required:*

- T: unit transformer, 120 volts 40 m/a (RSC (M/Cr) Ltd, Leeds)
- Metal rectifier, 125 volts 40 m/a (Brimar SB2 or any suitable type)
- Small smoothing choke, 10 henry 60 m/a (RSC (M/Cr) Ltd, Leeds, as above)
- 3 capacitors, 8 mfd. electrolytic, each 200- or 250-volt wkg
- Resistor: 2500 ohms, 1-watt type
- 1 black, 2 red sockets, wire, chassis, etc.

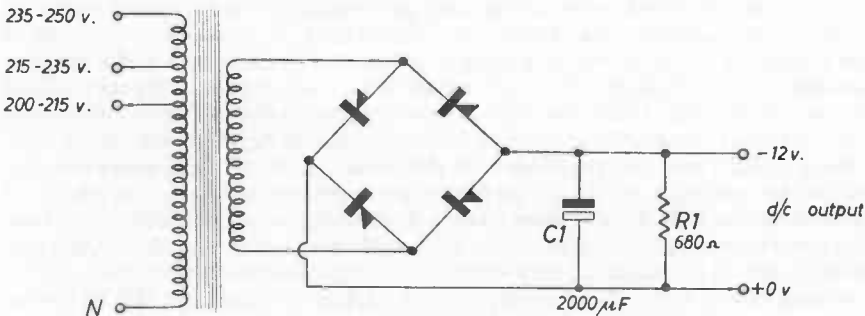

Figure 24 Newmarket Transistors Ltd Circuit

12 v. DC power supply - PC 106

which is marked for a voltage immediately higher. For instance, if the mains are 240 volts and the tappings are 210, 230 and 250, connect the mains input to 0 and 250. If you do not know the mains voltage, it will be marked on the electricity meter, or the local Electricity Board showroom will tell you. If you like, a fuse can be connected in the input lead for extra safety, and a suitable holder for a 1-amp. fuse is on the market. I have not specified this, for the sake of simplicity and cheapness, but a fuse may be incorporated in any of the mains set designs: a 1-amp. fuse in the smaller sets and a 2-amp. one for the larger.

Having wired up the primary side of the transformer, connect up the secondary which gives 120 volts at 40 milliamps. To rectify this alternating current, use a selenium rectifier; this acts on a half-wave principle. As a reservoir capacitor use an 8-mfd. electrolytic type; smoothing is carried out by a choke and another 8-mfd. capacitor. It is unlikely that a battery set will take 40 milliamps. even at 135 volts, and as a result the voltage will rise above the 120 volts output of the transformer. Consequently I include a 'tapping' which is obtained by passing the current through a 2500 ohms resistor bypassed by another 8-mfd. capacitor. If the set takes a total of 10 milliamps, the voltage drop will be

$$\frac{10 \times 25000}{1000} = 25 \text{ volts}$$

and this should be sufficient to avoid too high a voltage on the valves. The capacitors, incidentally, can be of 200- or 250-volt-working voltage ratings (higher, if you have such available, but you should not use lower-rated ones).

The components are mounted on a small chassis which you can make of wood if you do not want to buy and work on a metal one. It is much better to use a chassis, as so many of the components can be mounted under it safely out of harm's way. The rectifier must be mounted on top, as it must have sufficient ventilation, but in view of the low rating we are using, it should run cool. Because of the HT on this rectifier, I made a cover to prevent hands from brushing against it when the HT unit is in use. A simple cover made from perforated zinc or expanded metal, as used for loud-speaker frets, is adequate. One of the bolts connecting the cover to the chassis, if this is of wood, should be connected to earth so that the cover is automatically earthed by it. It would rather defeat the purpose of the cover if this should accidentally touch the high tension line and become 'live'! The output from the unit is connected to three sockets only; one for negative, which can have a black 'collar', and two positives with red 'collars'. One of the positive outputs will be the maximum voltage direct from the smoothing choke, and the other will be through the 2500 ohms resistor already discussed. For normal battery sets I use this latter tapping point and avoid too high an HT voltage on the valves. Only one output point is given, as it is modern practice to provide the intermediate points for those valves, other than the output (which takes the maximum HT) by means of resistors incorporated in the set itself. These are linked to bypass capacitors of suitable size and give each valve its appropriate voltage, plus stability and extra smoothing.

The components to make up these units may no longer be available as there is not a great demand for mains supplies of this type now. RSC Hi-fi Centres Ltd,

however, did supply a kit (type BMI) which will give both 1.5 volts for the filaments and 90 volts HT and this may still be available.

If you are interested in running a transistor receiver from the mains there are several methods available. Again consult the RSC advert.

Should you prefer to make up your own, a similar circuit to Fig. 24 can be made up using International Rectifier silicon rectifiers in a bridge circuit and a suitable transformer could be obtained from RSC. You may find a bell transformer or model-operating transformer around the house which would be suitable here.

If you cannot obtain the transformer for the Figure 23 design Radio Spares supply a 125 volt one (Home Radio) which will do just as well.

There are also a number of ready-built modules on the market similar to the Figure 24 design such as Sinclair, Stirling Sound (Bi-Pre-Pak Ltd) and others for which see the adverts.

Incidentally, the iron core of the mains transformer should be connected to H.T. - on the Figure 22 design and this should also be earthed to the earth pin of the mains plug. **Make sure you connect the wires to the mains plug correctly.**

## A VHF F.M. Receiver

This is a simple mains receiver which can be made very cheaply, even at today's prices; it will give real Hi-Fi results for 'mono' reception. The receiver is built on a small metal chassis – use a piece of aluminium sheet or part of an old TV set chassis. This excellent receiver does need a good-quality loudspeaker for the best results so do not skimp on that item.

This design is an extension of the integrated circuit technique in that IC's are built onto printed circuit boards with requisite components to make up complete modules. These only need connecting together to provide receivers already aligned and adjusted, which avoids the need for meters and complicated equipment.

There is no doubt that in these days of crowded wavebands the most satisfactory method of reception is by means of VHF (very high frequency) transmissions. The BBC and local radio stations now cover Britain on these bands and FM (frequency modulation) is used instead of AM (amplitude modulation) which is used on the medium and long wavebands. Stereo reception is also possible where this is available but this is not the case in East Anglia where I now live.

Stereo programmes can, of course, be received 'mono' and are received in this way on those portable battery receivers which receive VHF. This is a simple mains receiver which can be made very cheaply and which will give real hi-fi results for 'mono' reception. It is built up of modules and can, if desired, be extended to provide stereo reception by the addition of extra units. Such adds to the cost because an additional amplifier is needed and an extra loud-speaker to go with it. Generally the output from the mains unit is inadequate so a larger one is needed. The stereo decoder is also needed and sometimes an additional pre-amplifier. A tone control unit is a valuable addition. However, all these items are for the future; for construction of our present receiver we need four modules. These are made by STIRLING SOUND and supplied by BI-PRE-PACK Ltd, their associated company (address in Appendix), and are:

1. Tuner unit (reference SS201)
2. IF amplifier unit (reference SS202)
3. Audio amplifier unit (reference SS110)
4. Mains H.T. unit (reference SS324)

In addition you will need a volume control combined with on-off switch which will be a 4.7 K ohms potentiometer plus a co-ax socket or 2 terminals and 2 more terminals or a phone socket for the loudspeaker output. In addition you will need

a loudspeaker (either already made up in a cabinet or in chassis form for building in your own home-made cabinet). This should be a 4 ohm unit but 3 ohm will do if you already have one.

The receiver is built on a small metal chassis and this may be made up from a piece of aluminium sheet or cut from an old chassis. I used a piece of an old TV set chassis and built inside it, using it upside-down like a tray. The amplifier has to be bolted to the chassis by means of the black metal bracket and this enables the chassis to act as a heat-sink avoiding overheating of the power output transistors. This unit and two of the others are built on printed circuit boards so you must take care to avoid short-circuits of the undersides. If you wish to bolt them to the chassis spacers about  $\frac{1}{2}$ in long should be used on the screws between the chassis and the circuit board. The tuner unit has to be mounted so that the spindle can project through the cabinet for a knob to be fixed on it. It will be noted that three small screw holes are grouped round the spindle and these each take a 6 b. a. bolt.

The method of fixing, therefore, is either to drill corresponding holes for spindle and screw holes in one side of your chassis-tray or to make a small panel of wood or paxolin and drill similar holes in it. This panel will then have to be fixed to the chassis. *Note that the fixing bolts in the variable capacitor must not protrude through into the body of the capacitor. If they do they are liable to impede the movement of the vanes.*

Figure 25 gives an idea of the layout but the modules each have full details supplied with them. Note that only one earth connection must be made to the chassis as otherwise hum can be induced into the circuit. It is to this one spot that

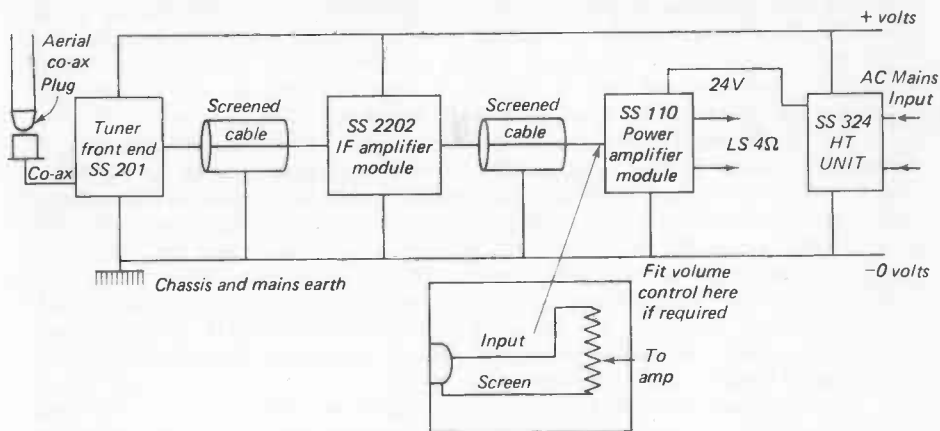

Figure 25 A modem VHF receiver

*Components required:*

Modules by Stirling Sound (sold by BI-PRE-PAK)

SS201, SS2202, SS110, SS324

Co-axial cable, plug and socket, volume control, chassis

the screening covers of the connecting cables must be connected, also connect the earth pin of the mains plug to it so as to 'tie down' the chassis to earth.

*May I repeat; be certain you make correct connections to the mains plug, and when you have built the receiver enclose it in a cabinet for safety's sake.*

The operating voltage is quite safe at 24 volts but the mains are exposed on the input side of the transformer and it is essential that you give the instrument proper and adequate protection.

This is an excellent and economical receiver to buy and operate but do use a good-quality loudspeaker with it for first-class results.

## Amplifiers, Record-Players and High Fidelity

This chapter is a brief survey of a vast field in modern radio and electronics, but is both informative and comprehensive. The enthusiast can experiment with layouts to suit his own purpose but Gilbert Davey reminds readers that radio and records are for listening to – not for testing amplifiers!

The heading of this chapter is, I must admit, a somewhat absurd one, because it could easily form the title of a book! There is so much that could be said about the equipment mentioned, but nevertheless I am going to try and touch briefly on each of the items and leave you to delve deeper into the subject with your own experimenting. I am going to say something about the reproducer first of all, the actual instrument which is the means of allowing you to hear the speech or music being passed into it as alternating currents. It follows naturally that a poor loudspeaker cannot improve on what is fed into it and, therefore, it must be the best you can afford. It will, without doubt, be a moving-coil loud-speaker as, regrettably, the electrostatic type, although a fine loud-speaker, is more expensive than most of us can afford. However, there are some very good m/coil types available at reasonable prices and I will tell you about three which I use.

Firstly, for general listening I have a Wharfedale 10-inch, bronze FSB unit which has foam surround, bass resonance around 30 cycles; it is an outstanding unit which can easily have a 'tweeter' unit added for better top-note reproduction. This particular unit is no longer available, but Wharfedale still make speakers of top quality which can be well recommended. For general experimental work (because it has an arrangement allowing the speech-coil impedance to be altered) I use a Whiteley 'WB' Stentorian 10-inch type, HF 1012. This is a first-class unit. The same manufacturers have a model with a more powerful magnet, known as the HF 1016, and I have one of these mounted in a large open cabinet for general high-fidelity work. There are today some very sound speakers made in the 8-inch size range, these being especially in demand now because of the smaller rooms of modern houses and flats. Chassis type speakers are difficult to obtain these days but Home Radio have some in their catalogue. A good hi-fi cabinet is shown in Fig. 26.

To feed the loud-speaker an amplifier is needed and a number of kits are available for sale in the advertisement pages of the radio periodicals. I have two main amplifiers which are not included in the many experimental ones I make up and both of them are Mullard designs from the book published by them entitled



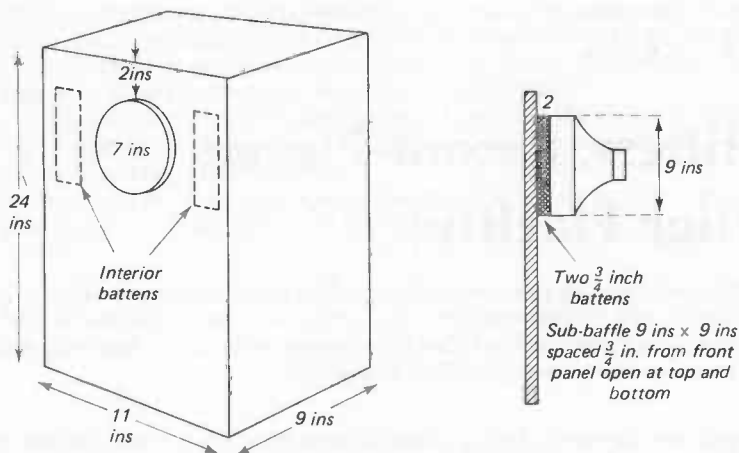

Figure 26 A Hi-Fi speaker cabinet

*Components required:*

Block-board to sizes shown, 'Contact' to cover cabinet which is fully enclosed, 8 in. loudspeaker such as Rank-Wharfedale.

*Circuits for Audio Amplifiers.* These are the ten-watt amplifier and the three-watt amplifier, both of which are high-fidelity designs, and are valve operated. We give details of them in *Fun with Hi-Fi*.

Another item which is desirable with a high-fidelity amplifier of the ten-watt type is a pre-amplifier and there are two designs in the book mentioned. The three-watt design is a very sensitive amplifier, however, and I find gives full output from the most insensitive gramophone pick-up.

You may spend a lifetime of experiment with amplifiers and high-fidelity reproduction, as I have done myself. I think the important point to remember, however, is that the primary reason for having the equipment is to listen to music, speech, plays, etc., and not to spend one's time worrying about the quality of the reproduction. It is an excellent idea to determine to make one good amplifier, one good radio feeder unit to be used with one good loud-speaker and record-player and then *to leave them alone!* Experiment then as much as you like with all sorts of other pieces of equipment, but keep the one set-up, the best you can possibly afford, for listening.

The next item to discuss in the reproduction chain is the radio feeder unit and for serious listening this can only be an FM unit, working on VHF and receiving the three BBC stations.

I am not going to say a great deal about units for the broadcast band, as I have mentioned such an arrangement elsewhere. Personally I would not bother with such a feeder when I can have an FM type, but I know my younger readers like the music from Radio Luxembourg which broadcasts on 208 metres and, of course,

requires a tuner for the medium waveband. Also overseas readers may very well not have VHF broadcasting and must receive on the medium or short waves. For all such cases a tuner unit can be built, using a superhet circuit built round coils by Repanco or Weymouth. I know that Messrs Repanco publish a leaflet showing how to do this and no doubt you can obtain similar details from Weymouth for their coils. Write direct to either of them (addresses are included in the Appendix).

Finally, we must consider the record-player, as every young person today is anxious to play records. These, as you will know, are plastic and made normally in two speeds of 45 revolutions per minute or  $33\frac{1}{3}$  r.p.m. The first type are the single or extended-play recordings of 7 inches diameter and the slower ones are the larger 12-inch 'long-players' or 'LPs'. There are also available some even slower LPs which revolve at  $16\frac{2}{3}$  r.p.m. and, of course, most people still have a supply of the old and obsolete shellac discs which were 10 inches or 12 inches in diameter and revolved at 78 r.p.m. Because of this, it is customary for the pick-up to be fitted with interchangeable heads, or a fixed head which incorporates a turn-over cartridge. This usually takes the form of a crystal cartridge one side of which plays the microgroove type of disc used for LPs and 45's while the other, by means of a turn-over device, can play 78's.

The reason for having the two types is that the microgroove requires a stylus tip of something less than 0.001 inch and the 78 record's stylus must measure about 0.002 inch to 0.0025 inch. Damage would be done to either type of record by the use of the wrong size stylus. Messrs Cosmochord Ltd publish an extremely useful leaflet on styli. The latter usually have sapphire tips for both LP and 78 sides and such tips should not be used for a total playing time of more than 25-30 hours. Sapphire styli are relatively cheap, but it is more economical to purchase a diamond-tipped stylus which can be used for 500 to 600 hours at only three or four times the cost of the sapphire.

One of the features of replacing the stylus which I once found irritating was that I had to replace the LP stylus when it wore down, while the 78 stylus on its other side was quite unworn. Messrs Cosmochord helped me here, however, as they supply, at very reasonable cost, a stylus which has a diamond for LP's and 45's but, on the other side for 78's, a sapphire stylus. This is an excellent idea, because I have the advantage of a diamond for the side which receives all the wear, yet am able to use the 78 side occasionally if necessary.

The next item to consider is the record-playing unit, the actual motor and turntable which carries the discs and rotates them, allowing the pick-up to traverse the grooves impressed upon them and to convey the currents so created into the amplifier for amplification. This item, like the pick-up which very often forms part of it, must be bought as a ready-made unit and is generally mounted in some form of cabinet. In choosing a record-playing unit it is probably true to say, as one can of so many things, that the more one pays, the better the unit one obtains. It is normal to choose a unit with four speeds, viz. 78, 45,  $33\frac{1}{3}$  or  $16\frac{2}{3}$  revolutions per minute, and most purchasers these days require a record-changing type, so that a number of sides can be played automatically.

The most expensive transcription-type playing units do not normally incorporate record-changing facilities, but their prices are probably outside the range of

those which most of my readers will want to pay. My own two units are in differing price ranges but very satisfactory in every way, being of somewhat different types. In the normal record-playing equipment fitted in the living-room, I have the BSR McDonald MP 60 record-playing unit which is fitted with the CosmoChord 'AcoStereo' 94 cartridge. This unit is most reliable.

For general experimental work and for taking out and about for small public address use, I have a Garrard Laboratory series Auto Turntable type A, which has the Garrard GC 8 plug-in pick-up head. This unit has quite a number of special refinements but is no longer available.

I hope this chapter has helped you on the question of high-fidelity, but as I said at the beginning, it only scratches the surface of the subject. There are so many books you can read, including a series of interesting and helpful ones by Mr G. A. Briggs of Messrs Rank-Wharfedale Ltd who also publish them. If you are going to construct an amplifier, do not overlook the Mullard book mentioned earlier or our *Fun with Hi-Fi* (Kaye & Ward Ltd.) Above all, remember that radio and records are for listening to – and not merely for testing amplifiers! I have not mentioned the specialized subject of tape-recorders, for they would require a book to themselves. Our next chapter still deals with amplifiers and is a practical design for simple hi-fi and the modern equivalent of one which has been very popular with all readers for several years now.

# A Simple High-Fidelity Valve Amplifier

An amplifier is a standard piece of equipment for the home constructor. The Davey Amplifier is a high-fidelity job which can be built at very reasonable cost. The design is straightforward and absolutely safe in every way.

Apart from its obvious use for reproduction of gramophone records with the aid of a pick-up, an amplifier is a standard piece of equipment to which a detector stage or radio-frequency amplifier and detector may be attached to form a complete radio set. Radio fans will have noticed that the low-frequency amplifying sections of radio sets are nearly always the same – so one might have this section as a 'constant' and then add on other stages.

Since broadcasting began the aim of radio set designers and constructors has been to obtain fidelity of reproduction. At one time to do this required lots of HT volts, many big valves and possibly two or three loud-speakers. Today, however loud-speakers are extraordinarily good and valves have improved so much that high volume and fidelity are obtained more easily.

Modern amplifiers have been developed round 'negative feedback'. Briefly, part of the amplifier's output signal is fed back into it again 'in opposite phase' and this has the effect of reducing harmonic distortion, increasing efficiency of the output stage and straightening out the response curve. It is impossible to say more in the space I have available, but I would strongly advise those readers who are interested in the theory to read it up in a sound textbook.

In this amplifier I have decided to use negative feedback and the result is a high-fidelity, economical piece of apparatus which can be built at reasonable cost. The design is perfectly straightforward and safe, as all wiring is below the chassis.

Three valves in all are used. One, of course, is the rectifier for the HT voltage and the other two are the LF amplifier and output pentode. This design is basically that of Fig. 27 with the addition of NFB (negative feed-back). The difference is that the amplifier in that figure will give a large output but with some 10% harmonic distortion. NFB reduces volume but improves fidelity and the Fig. 28 design will probably have only 1% harmonic distortion.

If you look at the theoretical diagram, you will see that a resistance network is inserted in the cathode circuit of V.1., and that a tapping is taken from it to one side of the low-resistance winding of the output transformer (that is, the winding to which the speech coil is connected), while the other side of that winding is

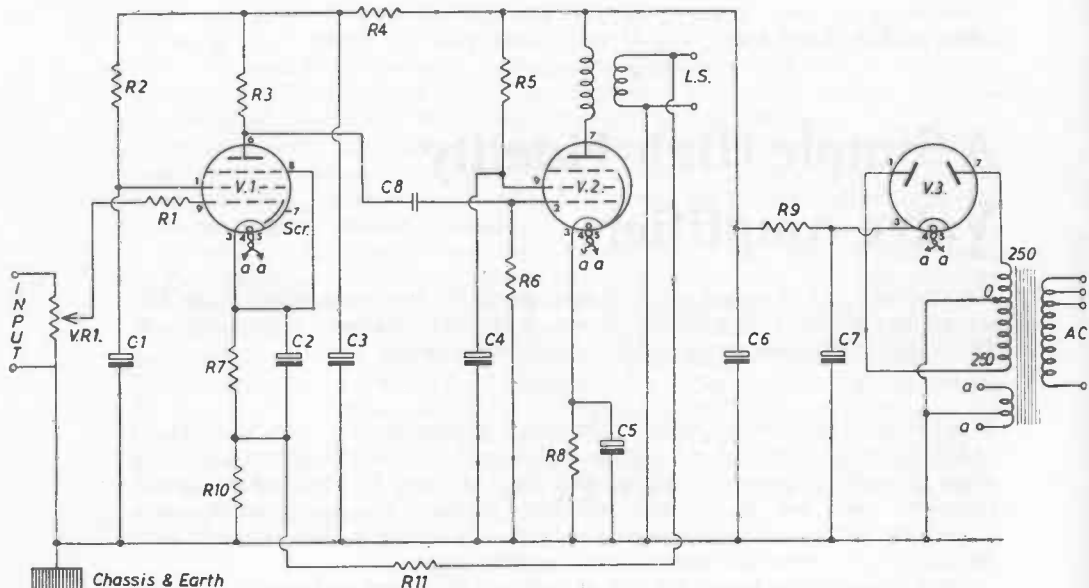

Figure 27 A simple fidelity amplifier

Capacitors: values in  $\mu\text{F}$ : C1: 0.1.300 v. wkg.: C2:  $25 \times 25\text{v}$ . wkg: C3:  $8 \times 350\text{v}$ . wkg: C4:  $8 \times 350\text{v}$ . wkg: C5:  $25 \times 25\text{v}$ . wkg: C6/7:  $32 \times 32$  (double)  $350\text{v}$ . wkg: C8: 0.1,  $350\text{v}$ . wkg.

Resistors: All except as stated  $\frac{1}{2}$  watt 10% tolerance: R1:  $47\text{K}\Omega$ : R2:  $1\text{M}\Omega$ : R3:  $220\text{K}\Omega$ : R4:  $47\text{K}\Omega$ : R5:  $2.2\text{K}\Omega$ : R6:  $470\text{K}\Omega$ : R7:  $2.2\text{K}\Omega$ : R8:  $150\Omega$  (2 watt): R9:  $470\Omega$  (2 watt): R10:  $47\Omega$ : R11:  $4.7\text{K}\Omega$ : VR1:  $500\text{K}\Omega$  with switch.

3  $\times$  B9A valveholders: mains transformer 250-0-250v. 6.3v. Output transformer

Valves. V.1 = EF86: V.2. = EL84: V.3. = EZ80

taken to earth. This is effected by a flex lead which is taken direct to the output transformer. If your output transformer is separate from the loud-speaker, you can mount it on the chassis and take your lead direct to it.

If it is mounted on the loud-speaker itself you will have to have a fairly long lead which you can connect to it. The best way would be to fix a crocodile clip to each free end of the flex and you can easily clip one on each side of the low-resistance winding. If you do this the first time and get a loud howl, it is because you are obtaining 'positive' instead of 'negative' feedback due to the leads being connected the wrong way round on the transformer. Change them over and all should be well.

The chassis size is 11 inches by  $7\frac{1}{2}$  inches, but it may be either slightly smaller or larger than this size. This chassis will need to be cut out in the appropriate places for the three valveholders and the mains transformer. The electrolytic condenser

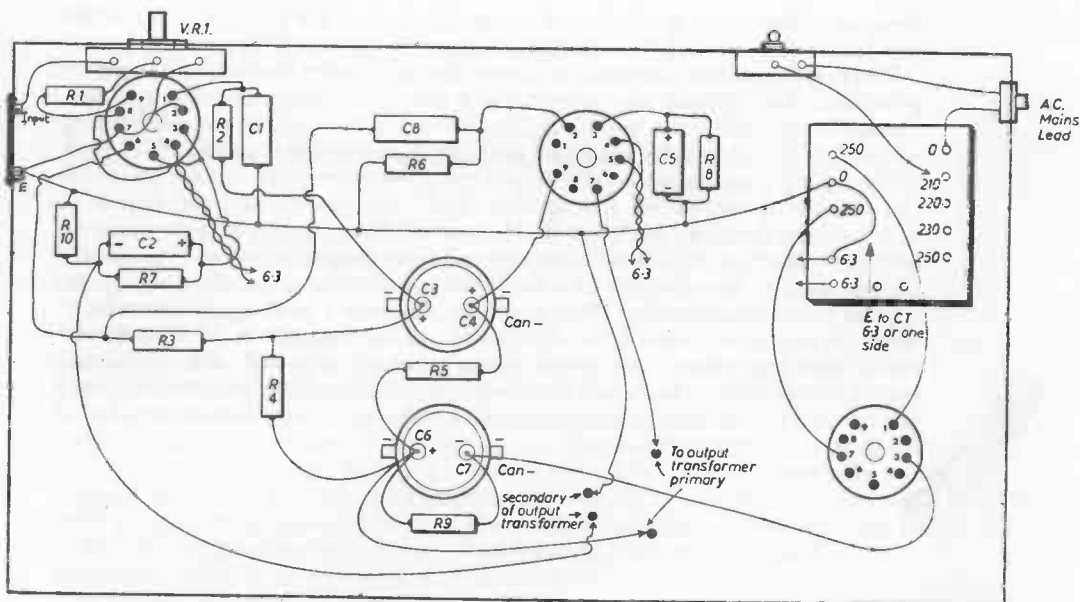

Figure 28 Wiring diagram of fidelity amplifier

will also require a fairly large hole. I have used one can-type electrolytic which requires such a hole and one double-type condenser which is bolted to the chassis.

The type of electrolytic is not important. It is probable that the kind you buy will not require mounting on top of the chassis, in which case you will mount them below it with clips. Use single or double types.

All the electrolytics may be of the can type if you wish, and if you use these you must drill two more holes for them just in front of the OP valve. Do not forget the holes which require to be drilled in the front of the chassis for the on-off switch and the volume control. At the sides you have to cut out small spaces for the socket panels and you will need two holes in suitable positions for the feedback flex to the loud-speaker and for the mains lead. The whole for the latter should have a small rubber 'grommet', to avoid chafing the flex.

All the components having been mounted, the wiring may now be easily and quickly carried out - general hints for doing this have been given elsewhere. It is a good idea to carry a bare piece of thick wire the length of the chassis from the earth terminal to the connecting bolt on the LS socket panel. This forms a very useful point to which most of the earth return connections may conveniently be made.

Take particular care with the connections to the EL 84 valve. The resistor used for auto-bias has the value of 150 ohms, and the grid of the valve is joined to the

junction of the coupling condenser and grid leak (C.8./R.6.). The R.6. end of the grid leak is connected to the adjacent earth wire.

Where shielded wires are used such as to the terminal on the volume control it is possible to buy special wire which has a thin inner wire insulated and then covered with a bare wire shielding. The thinner wire is, of course, used for the connection and the shielding turned back and connected to chassis.

The wiring diagram shows the output transformer mounted on the top of the chassis, but it can be on the speaker itself. this, as already mentioned, is unimportant; if you are buying both, I recommend buying a separate transformer and mounting it on the chassis. Buy as good a one as you can afford. I have used Elstone output transformers in my amplifiers. They are first-class. The same applies to the loud-speaker. This amplifier deserves a really good reproducer; these are expensive, but it is worthwhile to pay for one such as the Wharfedale. Firms sell ready-made up units in quite small size but with full-range high-fidelity. Rank-Wharfedale have recently introduced the Wharfedale Unit 3 speaker kit which gives a complete kit to build your own fidelity speaker of compact size in your own cabinet.

## Kit-Sets, Kits and Other Designs

Kit-sets are extremely popular and incorporate a printed circuit board on which components are mounted in their exact positions.

Radio as a hobby has always produced 'kits' for those who are a little doubtful of their ability to assemble and construct their own receiver. In 1927 there were the famous Cossor 'Melody Maker' and the equally well-known Mullard 'Master Three', which were complete sets of parts to build radio sets sponsored by the valve-makers mentioned. Today it is not so easy to purchase components and designs are more exacting, and require the placing of components and the wiring-up to be more precise than the less efficient receivers of previous years.

Kit-sets are therefore very popular and generally incorporate a printed circuit board on which the components are mounted, thus ensuring the exact position and correct connections. Even less need be done by the constructor who purchases ready-made 'modules', and we have seen circuits of these in Chapter 10. A few years ago the alignment and adjustment of such a receiver would be beyond the capabilities of all but an expert, but now modular construction is available for most designs.

One of the best-known suppliers of kits are Heath (Gloucester) Ltd whose 'Heath-kits' enable all types of radio and amplifier equipment to be built as well as instruments, meters, power supplies and so on. Home Radio feature these as well as many other kits, including those by Radionic which are used extensively in educational establishments. If you are interested in building a transistor radio, Radio Exchange Co. Ltd of Bedford have featured quite a number for some years at very reasonable prices ranging from £4 to £40. They deal by mail order and their address is in the Appendix.

Sinclair Radionics Ltd have a number of kits available, and they have many other electronic devices you may like to make.

Bi-Pre-Pak Ltd. have a large selection of kits and other items for home construction. Write enclosing postage for their catalogue, or send an International Reply Coupon if overseas.

### Personal Service

I should like to conclude by reminding you of one or two matters, the first being that I shall be glad to help you with any difficulties you may encounter **but only in connection with the designs in this book.** Write to me c/o the Publishers, and



please enclose a stamped, addressed, foolscap envelope or International or Commonwealth Reply Coupon. It is regretted that no reply can be given without the S.A.E. in the U.K. or I.R.C. outside it. Remember, however, that difficulties over coils, valves, components and the like should go direct to the suppliers or manufacturers whose addresses will be found in the Appendix which follows.

Thirdly, it is important to realize that components for home construction are usually difficult to purchase locally. It is customary to obtain them by mail order from one of the suppliers who advertise in the technical journals (or who are mentioned in the Appendix). Lastly do not overlook the other radio books in this series which are listed on the outer cover. The Editor and I hope you have enjoyed this book and will also enjoy the other titles in the series.

# Appendix

## Books and Periodicals

*Practical Wireless* (monthly, IPC Magazines)

*Radio Constructor* (monthly, Data Publications)

*Wireless World* (monthly, Iiffe)

*Principles of Transistors* J.A. Reddilough, S.W. Amos (Newnes-Butterworths)

*Beginners' Guide to Transistors* J.A. Reddilough (Newnes-Butterworths)

*Boy's Own Annual* (published on Sept. 1 of each year by Purnell Books, Purnell & Sons Ltd., Berkshire House, Maidenhead, Berkshire SL6 1NF)

*The Scout's Pathfinder Annual* (also published on Sept. 1 of each year by Purnell Books, with radio features of special interest to Scouts)

## Manufacturers and Suppliers

Bi-Pre-Pak Ltd., 222-224 West Road, Westcliff-on-Sea, Essex, SS0 9DE

BSR Ltd, Monarch Works, Parke Lane, Cradely Heath, Warley,  
West Midlands

Cosmochord Ltd (ACOS)., Eleanor Cross Road, Waltham Cross, Herts.

Denco (Clacton) Ltd., 355/7/9 Old Road, Clacton-on-Sea, Essex.

Ersin Multicore Solder Ltd., Multicore Works, Hemel Hempstead, Herts.

Heath (Gloucester) Ltd., Gloucester, GL2 6EE

Home Radio (Components) Ltd., 187 London Road, Mitcham, Surrey

Mullard Ltd., Mullard House, Torrington Place, London, WC1

Radio Exchange Ltd., 61A High Street, Bedford, Beds. MK40 1SA

Rank-Wharfedale Ltd., Idle, Bradford, Yorkshire

Repanco Ltd., 203-269 Foleshill Road, Coventry, Warwickshire

RSC (Hi-Fi Centres) Ltd., 102-106 Henconner Lane, Bramley, Leeds 13

RST Valve Mail Order Company, Climax House, Fallsbrook Road, Streatham,  
London SW16 6ED

Sinclair Radionics Ltd., London Road, St. Ives, Cambs. FE17 4HJ

Weymouth Radio Mfg. Co. Ltd., Regent Factory, School Street, Weymouth,  
Dorset

Faint, illegible text at the top of the page, possibly a header or introductory paragraph.

Second block of faint, illegible text, appearing to be a continuation of the document's content.

Third block of faint, illegible text, occupying the lower middle portion of the page.

Final block of faint, illegible text at the bottom of the page, possibly a conclusion or footer.



Gilbert Davey has written for radio journals, radio and television since 1933. His book *Fun with Radio* has been in continuous publication for twenty years, which speaks for its popularity in meeting the needs of amateur radio enthusiasts. This new edition has been so completely revised that now little remains from the 1957 edition. The book still aims at the amateur who starts with very little knowledge of radio-set building and operating but by Chapter 12 has enough confidence and experience to think in terms of a simple high-fidelity valve amplifier.

Other titles by Gilbert Davey with Jack Cox as Editor are: *Fun with Short Wave Radio*, *Fun with Electronics*, *Fun with Transistors* and *Fun with Hi-Fi*.