

RADIO FANS READ
**THE BUFFALO
EVENING NEWS**

Every Day, Because They Know
ITS RADIO COLUMN
*Is Informative, Accurate, Always
Up to the Minute*

~~~~~  
**SEND IN YOUR QUESTIONS**

Have Them Answered,  
Promptly, by a Real Ex-  
pert, a Man Who Has  
Been Working with  
Radio and Wireless  
Since They Were Born.

THE BUFFALO EVENING NEWS  
**Radio Guide**  
*for Beginners*

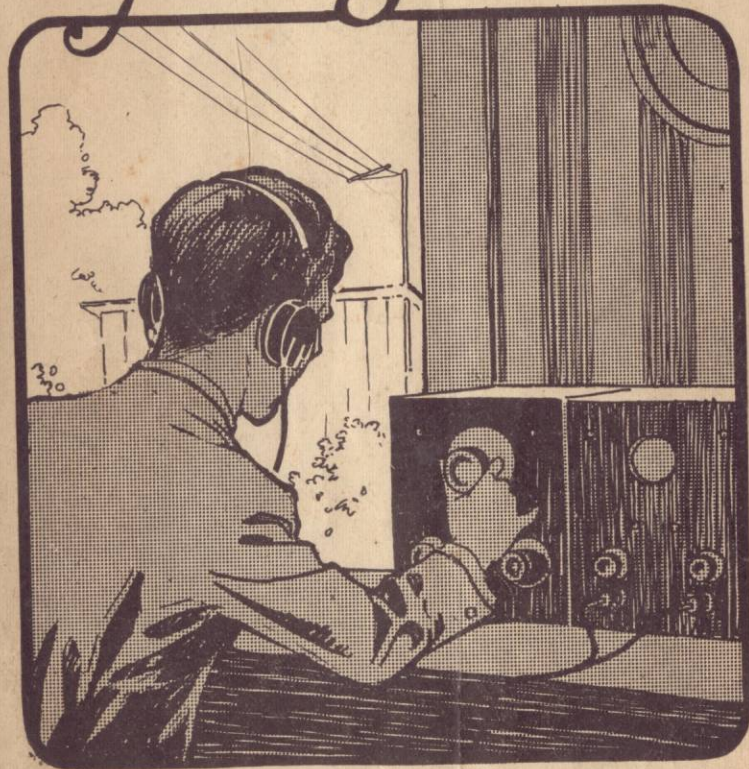

By **RAYMOND FRANCIS YATES**

A book for those who wish to build and operate  
radiophone receiving instruments. Illustrated with  
diagrams and drawings.

**10 cents**

## Preface.

The miracle of radio has brought with it a demand for information. The beginner is in a quandary. He cannot find a book that will meet his needs, and the clerks in the radio shops are too busy to answer questions. When they do answer, the information given is not always reliable. Then, too, many persons like to be spared the embarrassment of asking ridiculous questions.

In preparing this little book the author has been guided entirely by the requests that have reached his desk from the thousands of radio readers. This position has helped him to understand just what a book such as this should carry between its covers.

Any suggestions regarding the improvement of future editions will be appreciated.

**Raymond F. Yates**

# Waves in the Ether—How They Are Set Up and Detected

## PART I.

"What is this stuff they call ether?" asks the man who would know something about wireless. Indeed, an understanding of the art centers about this mysterious medium.

Ether is about as close to pure nothingness as anything that can be imagined. We might look upon it as the fourth state of matter. We have solids, liquids, gases and ether. Let us say that ether is about as far from a gas as a gas is from a liquid. It is highly attenuated and all-pervading. It penetrates even the most solid substances; the whole world is saturated with it. When we walk through air we displace it, but not so with ether. The ether simply pours through our bodies with less resistance than water meets in passing through a sieve. Ether is the "unsmellable," the "unseeable," the "unweighable" and the "unfeeleable."

Sound is carried on the air. When a gun explodes or a frog croaks the air is set to vibrating and sound waves travel out from the point of the disturbance at the rate of about 1,190 feet a second. Unlike ether, air is a very tangible medium. When the wind blows we can feel it.

### Sparks Create Waves

In many respects ether behaves like air. We cannot disturb it by sounds, but we can disturb it by other means. An electric spark will create ripples or waves in this great mass of ether.

When we were children we would throw stones into a puddle of water and watch the ripples spread. The same process takes place in the ether. An electric spark creates an ethereal "splash," and waves spread out in all directions.

In the early days of radio, sparks were used entirely to set up ether waves, but nowadays they can be created by the silent vacuum tube or alternator.

Radio transmitting stations are simply provided with instruments to "kick up" a fuss in this vast medium we call ether. When the instruments are in operation the ether about the station "shivers" and waves spread out, traveling at a speed that would make greased lightning appear slow. A speed of no less than 183,000 miles a second is reached. This would allow the waves to sweep around the world in the twinkling of an eye.

### Waves Vary in Length

Every sound wave in the air has a definite length. Every wave in the ocean has a definite length, and every ether wave has a definite length. The length of a water wave is the distance between the peaks or highest points of two successive waves. It may be from ten to 300 feet long. Ether waves vary in size within certain limits. Some may be a few feet in length, while others may be five or six miles in length. Technicians use the meter to measure the length of waves. The meter is equivalent to 39.37 inches. A wave length of 200 meters would be 200 times 39.37 inches, or 656.16 feet.

Upon what does the length of these waves depend? It depends entirely upon the rate at which the current in the circuit at the transmitting station is "vibrating" or oscillating. If it is oscillating at an

extremely rapid rate, short waves will be produced in the ether. If it is oscillating at a low rate long waves will be produced.

If two piano wires tuning to the same length are placed in the same room, both of them will vibrate if only one is struck. The first wire vibrates and sets up sound waves of a definite length. The other wire is in tune with these particular waves because it is of the same length as the wire that produced them, and therefore it will vibrate in sympathy.

This will help us to understand how radio waves are detected. The receiving station must be in "electric" tune with the transmitting station. The electrical condition that prevails at the receiving station must be "just so" before that station will respond to the waves of the distant transmitter. The receptivity of the receiving station is controlled by such instruments as tuning coils and variable condensers.

If the instruments at the receiving station are not tuned to the proper point, the wave from the transmitting station will pass it by. If the instruments are adjusted to meet it, it will strike the aerial and become entrapped. When an electric or wireless wave is induced into receiving instruments, it is converted back into an electric current. This current will vibrate in unison with the current at the transmitting station.

Part of the instruments at the receiving station are used to tune the outfit, and part are used to convert the electric currents into audible sounds. A detector is used to rectify the currents, and the phones are used to make them audible.

"What would happen if two waves came along that were of the same length?" asks the inquisitive person. We would then have what is known as interference. The speech or signals produced by the one station would be superimposed upon those of the other, and nothing but confusion would result. It would be impossible to tune one of the stations out without eliminating the other. This is, of course, assuming that both waves are of exactly the same length.

Before leaving this subject it might be well to come back to the matter of wave length for a moment. So many beginners make the mistake of believing that the distance a wave travels will depend upon its length. Wave length has nothing to do with distance. If sufficient power is used a wave 200 meters long can travel just as far as one ten times that length. It has been found, however, that the longer wave lengths are best suited for long-distance transmission.

The reader will understand that the distance that can be covered by a sending station will depend upon the sensitivity of the instruments used at the receiving end. When only a crystal detector is used a transmitter may be able to send only twenty-five or thirty miles, as far as that particular type of receiver is concerned. On the other hand, the very same station may be able to cover a distance of 1,000 miles when vacuum tubes are employed.

As Editor of the Radio Page of The New York Evening Mail, the writer has been called upon again and again to answer the question, "How far can my outfit receive?" There is only one answer to this question. It all depends upon the power of the transmitter sending the signals or broadcasting the music.

## How to Make A Simple Receiving Set

"How does the detector 'detect'?" asks the man who is about to build a radio receiver. To understand this we must first understand the limitations of the human ear. Nature so designed our "detectors" that we cannot hear sounds that vibrate with a frequency above 10,000 a second even though they are under our very noses.

Now, radio currents "vibrate" at a point far beyond the range of human hearing. The problem is to cut this rate of "vibration" down to a point where our ear will respond. That is the function of a crystal detector.

Radio currents dash back and forth in a circuit many thousand times a second. They alternate, going first in one direction and then in the opposite direction. The little piece of crystal that we place in a detector has the peculiar property of allowing a current to pass freely in one direction, but not allowing it to turn about and pass in the opposite direction. It acts as a sort of one-way door.

If an alternating current is allowed to pass through the crystal, half of it will be cut off. This will have the effect of cutting the frequency of the current in half—we cut its rate of "vibration" in half, bringing it from the range of inaudibility into the range of audibility. The resulting current, if allowed to pass into an ordinary telephone receiver, affects it in such a way that they produce sound. So much for "how it works."

Now for the construction. A simple wooden base will do. We do not need to be fussy about this. However, the wood used should be perfectly dry. The holes necessary for the binding posts, crystal holder and wire holder should be drilled in the base. A hot nail is a good substitute for a hand drill.

The cup-shaped crystal holder can be one of many things. Take care the housekeeper doesn't miss the top off the salt shaker. The end of an old cartridge fuse will do nicely also. Be sure that the "inside of the cup" is clean. Drill a small hole through the side of it and tap it for an eight-thirty-two screw.

If the necessary tools are not at hand, the little repair shop around the corner will do the job for a few cents. Also drill a hole in the bottom of the cup so that it can be fastened to the wooden base.

Next make the "cat-whisker." A small piece of brass spring wire coiled around the end of a lead pencil will do. One end of this is held under a screw which may be taken from an old dry battery.

After the binding posts are placed on the base, the job is completed with the exception of the connections. The little cup holding the crystal is connected to one of the binding posts. The coiled spring wire is connected to the other binding post.

Now a word about crystals. This is a galena detector. That means that we shall have to go to a radio shop and buy a supply of small galena crystals. A small piece is placed in the cup and held there tightly with the screw. This insures a good electrical contact.

When the detector is used in connection with the instruments that will be described later in this booklet it will be necessary to adjust it to a point of maximum sensitivity. To do this we must "fish" around on the surface of the crystal with the free end of the little brass wire. Some spots are sensitive and some are not. Just as soon as we touch

a sensitive spot an improvement in the strength of the received signals will be noticed.

The crystals "wear" out in time and must be replaced.

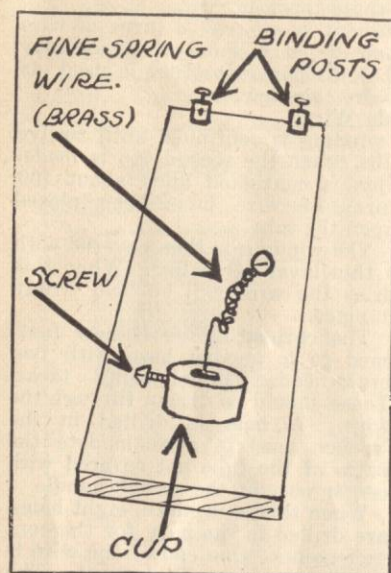

A Home-made Detector

to receive signals from a station with a wave length of 300 meters. The amount of wire needed will depend upon the size of the aerial.

### Making a Tuning Coil

From this we will learn that it is necessary to have some means of adjusting the amount of wire in our receiving set so that various stations with different wave lengths can be tuned in. This is done with a tuning coil. The tuning coil allows us to add or subtract wire from our aerial system.

To make a tuning coil suitable for reception from the big broadcasting stations, only a few inexpensive materials are necessary. We can buy them in any radio or electric shop.

First we must have a cardboard tube on which to wind the wire. This should be about three inches in diameter and about eight inches long. About four ounces of No. 26 cotton covered wire will be needed, together with a switch handle and eight contact points.

The switch handle and contact points could be made at home, but they are so cheap that it is advisable to buy them and save trouble.

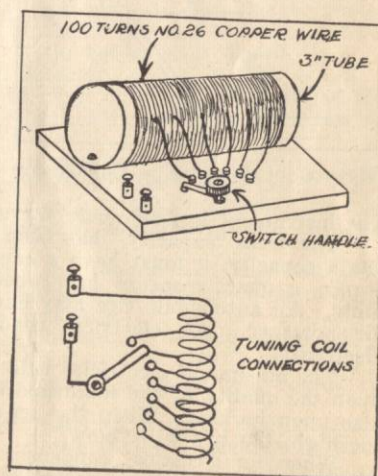

The finished tuning coil and the method used in connecting the taps to the contact points.

Before starting to wind the tuning coil, the diagram of connections should be studied with care, since this will prevent later mistakes. Two small holes are punched in one end of the cardboard tube with a hatp.n. One end of the wire is threaded into these to anchor it.

The winding is then started. At about every twelve turns of wire a "tap" is taken off. To take this tap off, it will only be necessary to make a loop in the wire. A small O. K. paper fastener is used, as illustrated in the sketch. to hold the wire together.

#### Shellac Holds Wire

After the first loop is made the winding is continued until twelve more turns have been made on the tube, when the second tap is made. This is continued until about 100 turns of wire have been placed upon the tube.

The winding is then covered with a thin layer of shellac. When this dries the wire will be held firmly in place.

The cardboard tube is now fastened to a wooden base with two brass-headed upholstering tacks. These should be driven through the wire. A hole is drilled in the wooden base, to accommodate the parts of the tube not covered with center post of the switch handle.

When this is in place, eight holes are drilled in the base for the contact points. One end of the wire is connected to the first point. The connection is made by simply scraping the insulation off the wire and placing it under the contact point. After the nut of the contact point is tightened, a very good connection will be established.

Each loop of wire is treated in a like manner. When all of these connections have been made, the two binding posts are placed on one side of the board. Connections are made with these posts as shown.

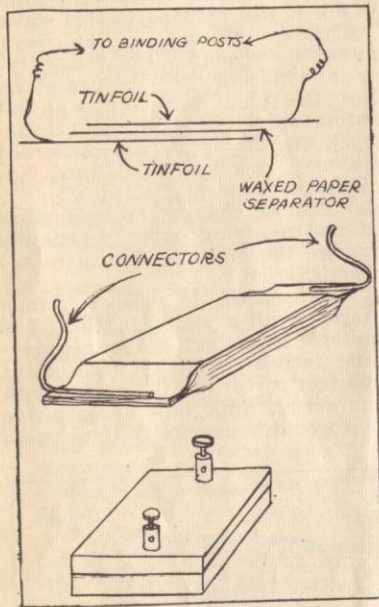

Method of Making a Condenser

The instrument is now ready for use.

The term "capacity" has been mentioned before. When anything has a capacity, it must have a capacity for doing something. For instance, a quart measure has capacity of two pints—it will hold two pints. An automobile tire may have a capacity of 60 or 80 pounds of air pressure. An electrical condenser has a capacity for storing electricity.

The amount of electricity held by a condenser will depend not only upon the quality of the materials that are used in its construction but also upon its size. When the pressure in an automobile tire becomes too high, the tire will "blow."

When an electrical condenser becomes full, it will "blow" (discharge). Condensers connected in the circuit of a radio receiving or transmitting outfit will effect changes in the wave length. In receiving outfits, some of the condensers used are made with a variable capacity so that they may be used for tuning.

In the case of a simple outfit, a small fixed condenser is placed across the telephone receivers, but not with the object of changing the period of the circuit.

A little fixed condenser for this purpose can be assembled with a

few simple materials that are usually found about any household. A few square inches of tinfoil, some waxed paper and a small cardboard, or wooden box will be needed.

Ten oblong pieces of tinfoil are first cut. These should measure  $1\frac{1}{2}$  inches wide by 3 inches long. Next, ten pieces of waxed paper measure 3 by 2 inches are cut.

The waxed paper is given a bath in warm paraffin. A piece of the waxed paper is then laid on the table and piece of tinfoil is laid on top of it. One end of the tinfoil is allowed to lap over the end of the paper for a distance of about one-half inch.

Now another piece of the waxed paper is laid over the piece of tinfoil. The second piece of tinfoil is then laid over the second piece of waxed paper, but in this case it is allowed to overlap at the opposite side.

This building up process is continued until the tinfoil and the supply of paper is exhausted. The method of assembling will be understood by referring to the diagrams.

When the assembling is finished we should have the ten pieces of tinfoil separated from each other by waxed paper. The ends of five of the tinfoil sheets should be protruding from each side.

These ends are folded over and a piece of copper wire attached to them. Before this, however, it is advisable to clamp the condenser between two boards and put it in a warm place. This will cause the wax on the paper to melt and a solid form will result.

With this done the condenser should be placed in a small cardboard or wooden box. Connections are made to two binding posts and the box is poured full of hot paraffin before it is closed.

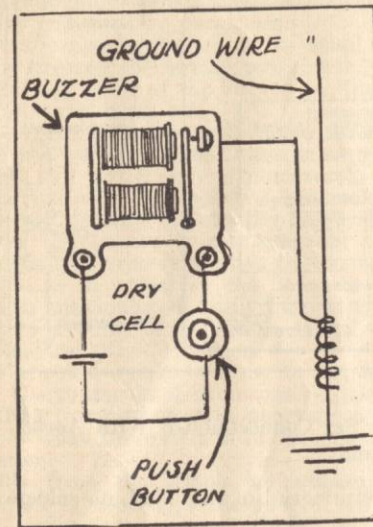

How an ordinary buzzer is connected to test the detector

The construction of a crystal detector, a tuning coil and a fixed condenser has been described. We shall now see how it is possible to connect these instruments up for service in receiving from the broadcasting stations.

It will be necessary to buy a set of telephone receivers for use with such an outfit. It is the telephone receiver that transforms the delicate electrical impulses into audible sounds. It is impossible to make a telephone receiver without elaborate equipment and considerable experience.

The writer wishes to impress the reader with the fact that the efficiency with which a wireless receiving station functions will depend largely upon the quality of the receivers.

Before connecting up the instruments, a simple aerial should be erected. A single strand of No. 14 copper-clad wire 75 or 100 feet long is used. A small cleat insulator is attached to each end of the aerial wire to insulate it properly.

If these insulators are not used, part of the weak currents traveling along the aerial wire will have an opportunity to leak away, and only a relatively small percentage of their strength will pass into the receiving instruments. It is therefore well to keep in mind the importance of good aerial insulation.

The aerial is raised by means of a pulley and rope placed at each

end. This allows it to be taken down for repairs. One end of the aerial wire is strung through the insulator and twisted about itself several times. The free end is then attached to the center of what is known

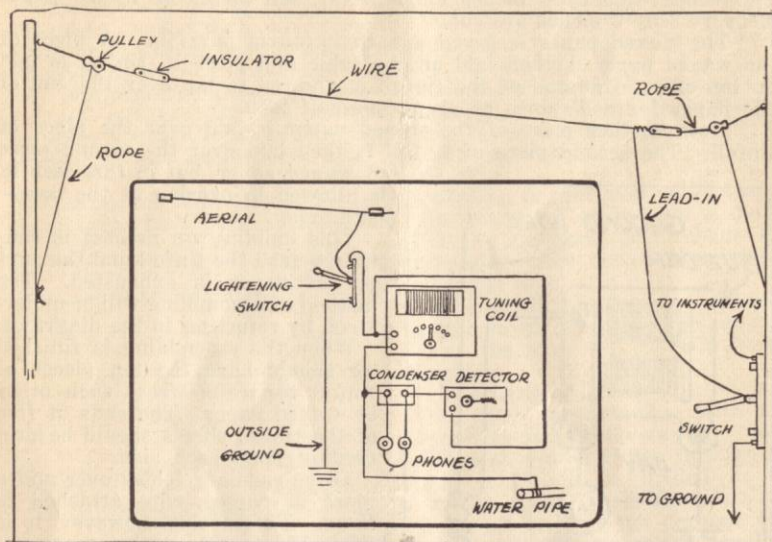

Diagram Showing Home-made Radio Set Connected Up With Aerial and Ground

as a lightning switch. With a single wire aerial of this kind, no soldering is necessary.

Another wire connects one post of the tuning coil to the lightning switch and the other side of the switch is connected directly to the ground. When the outfit is not in use, the blade of the lightning switch is thrown down so that the aerial will be connected with the ground.

It will then act in the capacity of a lightning rod, and if it attracts any heavy charges of static electricity they will be immediately led away to the ground.

If the pole of the lightning switch is thrown upward, it will connect the receiving instruments to the aerial and the outfit will be ready for use.

#### Clean Connections

The various instruments may be connected with ordinary lamp cord. Great care should be taken to see that the wire is scraped clean before it is inserted in the binding posts. The binding posts should also be screwed down tightly to insure a good connection.

After a small piece of galena is placed in the cup of the detector, the outfit will be ready for use. The little brass wire or cat whisker of the detector is placed in contact with the galena crystal. The tuning coil is then adjusted until the music is received.

The first adjustment of the detector may not bring results, and it may be necessary to make several more adjustments before a good sensitive spot on the crystal will be found.

If a little testing buzzer is used, the detector can be brought to a

sensitive adjustment without the trouble of relying upon outside signals.

After the receiving outfit is installed, we must learn how to operate it properly. Contrary to the general opinion, it is not simply a matter of adjusting a knob or two.

The writer does not want to discourage the novice by filling him with too much awe of a simple receiving outfit, but he does wish to warn him that there are some simple facts which he must learn.

We must first learn to adjust the detector. It is not necessary to rely upon incoming signals. We can install a simple little buzzer set. With this we can produce our own signals and bring the detector to a point of maximum sensitivity. A doorbell buzzer, push button, and a single dry cell must be purchased.

These are connected up in the usual fashion so that when the push button is pressed the buzzer will "buzz." A single wire is attached to the contacting point of the buzzer, as illustrated, and run to the ground wire of the receiving set.

It will not be necessary to make a metallic contact with the ground wire. If the wire from the buzzer is simply wrapped around the ground wire, this will be all that is necessary. If a metallic contact is made to the ground wire, too heavy a current will flow through the detector and this will destroy the sensitive crystals.

After the buzzer is connected as shown, a sound will be heard in the telephone receivers when the buzzer is in operation. This sound will guide us in adjusting the detector. The adjusting handle of the detector is manipulated until the sound in the telephone receivers is brought to a point of maximum loudness. The detector will then be in its most sensitive condition.

We are now ready to tune for signals or music. This is done by turning the tuning knob from one position to another. A certain position will be found where the incoming signals will be loudest. We will then know that the outfit is in "resonance" with the distant transmitting station.

Aside from the simple adjustments mentioned above, no other preparation is needed in the case of an inexpensive crystal receiving outfit.

## Simple Crystal Receiving Set With Fine Adjustment

The single control crystal detector receiver is the logical set for the beginner. It combines ease of construction with simplicity of operation, and may therefore be easily made and operated by the beginner.

In order to construct a receiver which will meet all the needs of the broadcast listener the following material will be necessary:

1. A piece of well-seasoned wood 4x5x $\frac{1}{4}$  inches for the panel.
2. Another piece of wood 4x5x $\frac{7}{8}$  inches for the bases.
3. A cardboard tube 3 inches in diameter and 4 inches long.
4. A quarter of a pound of No. 22 S. C. C. Magnet wire.
5. A crystal detector.
6. A telephone receiver.
7. Ten contact points.
8. Two switch knobs.
9. Four binding posts.
10. Antenna equipment.

The tube which is to receive the winding is first shellacked and left to dry or baked in an oven. This will insure a stiff, moisture-proof tube, which will not be affected by the weather conditions.

### Winding the Wire

The sixty turns of No. 22 single cotton-covered wire are evenly wound in one layer on the prepared tube. A hole punched through the cardboard three-fourths of an inch from one of the edges will furnish a starting point for the winding. Ten turns are first wound and then a "tap" is taken; that is, a loop about three inches long is made, the wire is scraped clean of insulation and a knot is tied or twisted in the loop.

This method holds the wire securely at the tapping point, and the winding may be continued. "Taps" are thus taken every tenth turn for fifty turns of wire. Then the operation is repeated every two turns for the last ten turns, making in all five taps of ten-turn units each, and five taps of two-turn units each, totaling in all ten taps for sixty turns of wire.

For those who are handy with soldering irons a neater and better job can be done by soldering short lengths of wire to bared sections of the winding and soldering these to the contact points. This method of tapping the coil will enable the operator to tune in a station down to the nearest double turn.

Any combination may be made by turning either the "tens," or the "unit" turn switches. A light coat of shellac on the winding will hold it in place and prevent loosening.

The panel carries the controls for tuning, the detector and also the terminal connections. The two knobholes are laid out with the contact point holes in a well-balanced layout. The detector is placed below both knobs, and the binding posts are conveniently located at the right and lefthand sides of the panel.

The loops from the taps are either fastened with nuts on the shank of the contact points or soldered directly to them. The "tens" taps are fastened on the left knob switch section, and contact points, beginning with tap No. 1 and Nos. 2, 3, 4 and 5 in sequence, so that a clock-wise rotation of the switch will increase the number of turns of wire in use.

The same procedure is followed for the unit turns. The left knob switch is connected with the binding post going to the aerial, and the

knob to the right is fastened to the detector. Follow the wiring diagram to complete the wiring of the panel.

### Simple Detector

The crystal detector may be bought or can easily be made from odds and ends. The type described consists of a crystal holder, which is essentially a testing clip which grips the galena crystal and holds it rigidly in position. The "catwhisker," whose purpose it is to "search" the surface of the crystal for a sensitive spot, is made of a small length of fine springy copper or phosphor bronze wire.

The wire is fastened on to the end of a rod fitted with a small insulating knob. The catwhisker is controlled by this knob. The rod

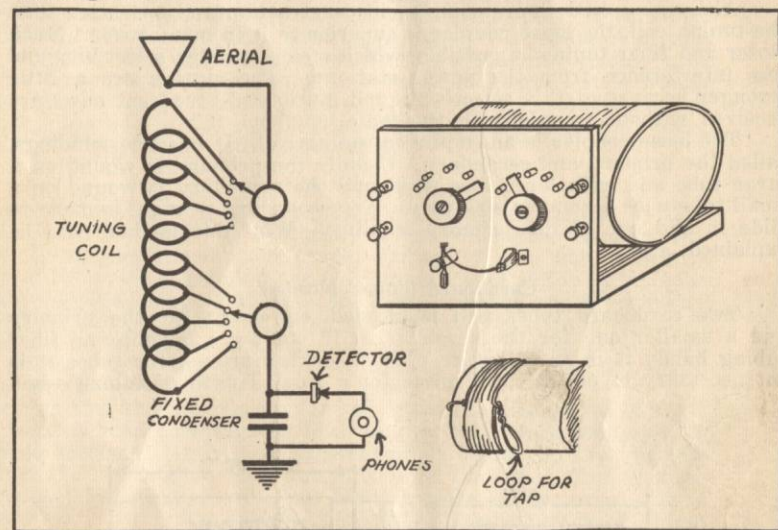

DIAGRAM OF COMPLETE RECEIVING SET THAT CAN BE MADE EASILY AT HOME

is passed through the hole of a binding post and the set screw serves the purpose of locking it in position. This detector is simply made and easily adjusted.

The condenser may be any type of stopping condenser. The fixed condenser described in an early issue of *The Evening Mail* will prove serviceable in this part of the circuit.

A single 1,000-ohm receiver may be connected to the right-hand binding posts. A double set is desirable, of course, although signals may be brought in even with a 75-ohm receiver.

Receivers of higher resistance should be used for better results.

After all connections have been made and the wiring carefully gone over to insure against breaks in the circuit, it is connected with the antenna and ground system as shown. The telephone receivers are connected to their respective posts, and the detector is set.

When signals are heard, first adjust the "tens" knob switch until the signals have been brought in to maximum strength. Then the "unit" knob switch is regulated until the best response is obtained from the whole receiver.

The "tens" switch knob is used for coarse adjustment, while the right knob is used for fine tuning. This is a little refinement which will permit closer tuning and louder signals.

With an antenna of from 50 to 100 feet the builder should experience no difficulty in receiving broadcast concerts with this little crystal receiver.

PART IV.

## Construction of Loose Coupler More Complex, but Superior to Tuning Coil

Although a little more complex in construction and operation than the tuning coil, the loose coupler is superior to it in many ways. Much closer and finer tuning is possible, which means greater selectivity and less interference from the power stations. The signals are a little stronger because of this selectivity, and music and broadcast news are received without trouble with the loose coupler.

The loose coupler is an improved tuning coil. It has two windings, called the primary and secondary. Usually the primary is wound on a large tube and with large size wire, and the secondary is wound on a small tube with a smaller size wire. The secondary winding is made to slide in and out of the primary winding. Why this is done will be explained later.

### Cardboard Tubes Needed

Two cardboard tubes will be needed, one large for the primary and a smaller one for the secondary. If you have bakelite or fiber tubing handy it is much better. When looking around for tubes it is not necessary to pay a fancy price for a small length of tubing when

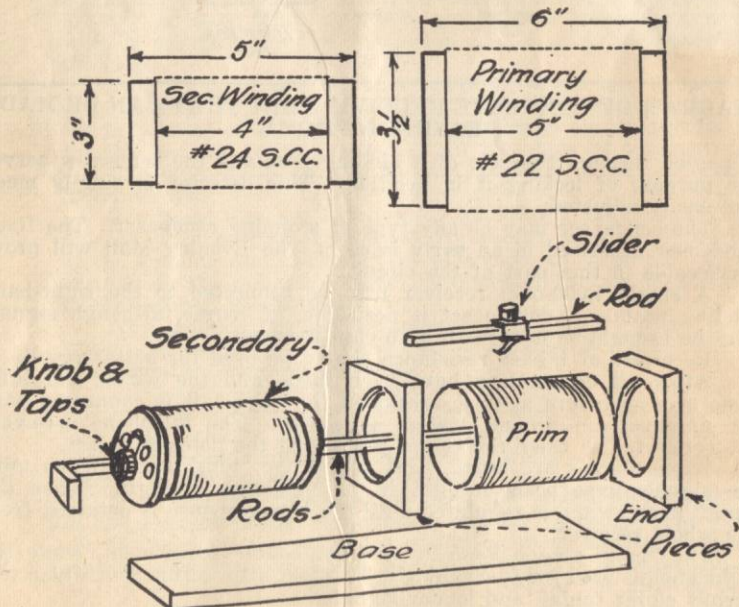

Diagram of loose coupler assembly, showing primary and secondary windings.

there are so many pieces around you. For instance, a very good primary tube can be made from the cardboard box in which oats are sold.

This will provide a tube about four inches in diameter and about eight inches long. A tube which will fit inside of it with a clearance of from one-fourth to one-half inch will be just the thing for the secondary. The dimensions shown in the drawing need not be followed closely as long as the proportions are preserved. If you have a tube a little larger or smaller it will be as good.

The primary tube is about six inches long. It is wound evenly with one layer of single cotton covered wire for five inches. Bare wire, enameled or silk covered wire may be used, although special provisions must be taken to insulate each adjacent turn of the bare wire winding. There will be a half-inch margin on each end of the tube. A thin coat of shellac will serve to hold the winding in place. Use white or orange shellac, thinned down with wood alcohol. The secondary winding consists of a tapped winding of about four inches in length. It is wound with insulated wire, between No. 24 and No. 26, and is tapped every half inch. The end of the winding is brought to a tap, so that there will be eight taps for the four-inch winding.

### How to "Tap"

The method of taking taps has been previously explained in other articles. Taps are taken in a slightly different manner on this coil. Instead of bringing the tap out on the surface of the tube, a hole is punched at the point of tapping and the loop is forced inside of the tube and drawn out for about six inches. The loop is twisted and the winding continued for another half inch, when the tapping operation is repeated.

The reason for this is that the secondary winding must slide inside of the primary tube, and outside taps, besides being unsightly, would rub against the inside of the primary tube.

There is also another reason; the end of the secondary tube is fitted with a wooden head carrying the knob and switch points connected to the tapped sections. It is more convenient to bring the taps to this head from the inside than from the outside of the tube. Two flexible wires connect the winding with two binding posts on the base. There are two brass rods for the tube to slide on. The primary is of course suitably mounted on end pieces and provided with a rod and slider. Two rods and sliders can be used, although there is not much advantage in that.

### Wind One Way

In the winding of these two coils there is one thing which must be carefully watched, and that is that the two coils must be wound in the same direction. That is, it should be as though the wire were wound on one tube, which was cut in two later on. This is important, because otherwise the fields of each winding would oppose each other, and the efficacy of the apparatus would be considerably decreased.

Another point of caution: the end of the secondary winding to be nearest the primary should be connected to the flexible conductor going to the binding post, while the other end farthest away from the primary is connected to a contact point.

The receiving transformer used in the receiving circuit is commonly called a "loose coupler." A better name for it is "inductive tuner." It is composed of "primary" and "secondary" windings, the values of which determine the wave length to which the set will respond. The loose coupler herein described will easily tune to wave lengths of 1,500 or 2,000 meters, provided it is connected to an aerial system with a length of about 100 feet.

### Primary Winding

The primary winding is provided with a rod and slider arrangement so that more or less turns may be included, while the secondary is "tapped," the taps leading to the end piece, where connections are



made to a multipoint switch, so that by turning the switch more or less turns may be included in the circuit. The two coils are so placed that the secondary may be slid in and out of the primary in order to vary the "coupling."

The general arrangement is to have the primary coil fixed, with the secondary so placed as to slide easily on guide rods. This is shown in the diagram. The secondary is entirely separate from the primary, and there are no connections from one coil to the other. Connections from the secondary coil to the binding posts on the base are made through a flexible lead from the end piece. The secondary can be slid in and out. This is a better plan than using the two slider rods on

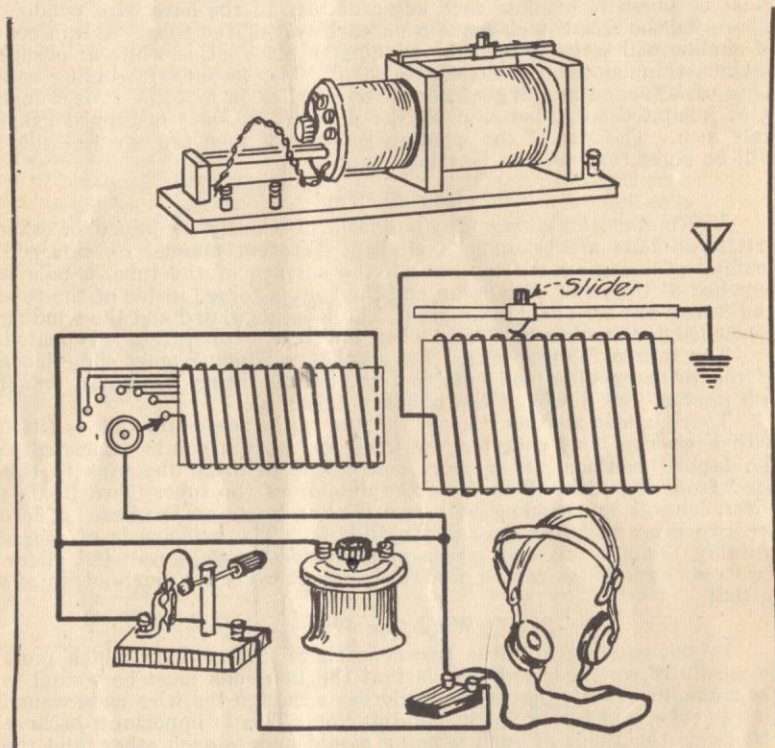

Sketch shows finished loose coupler and how it is connected with the rest of the instrument.

which the secondary slides, to make a sliding contact with the outside circuit. The flexible lead is loud enough to allow the secondary coil to go all the way into the primary. If desired, the primary winding may be tapped with the "units" and "tens" method previously described, and switch knobs and contact points may be used instead of the slider. It will look better, but will not be more efficient than the slider arrangement.

#### How It is Used

The loose coupler acts as a filter, which lets pass the signals that are tuned in and desired by the operator, while the undesired signals are rejected. This is true to a certain point, for it is not always that a very pure wave comes from the transmitting station. If the transmitting station is very near the receiving station, it will also be hard

to tune it out. Thus it will be seen that the loose coupler has its limitations, but is much better than the tuning coil. It is said to be more "selective," that is, one can "select" the station he wants to hear among others that are transmitting at the same time, and the unwanted stations can be tuned out more effectively.

It is very easy to receive with a loose coupler. We must know how to use it for best results, however. Otherwise it will prove troublesome and the old tuning coil set will be called back on the job. The coupler must be properly connected up with the rest of the instruments. The secondary winding is placed all the way in the primary, and the slider of the primary is moved back and forth until a signal or the desired signals are heard. Then the switch on the end of the secondary is moved to the contact point which will give the greatest signal strength.

#### Tuning Process

The variable condenser, connected across the secondary winding, may be turned until the signals are made just a bit louder. Next the secondary coil is moved out of the primary until the signals are loud and clear. Adjust the variable condenser and the secondary, that is, retune, and try to bring in the signals still a bit louder. The signals received will be found louder than any similar signals received with a tuning coil set, and the freedom from interference from other stations will be much greater. The reason for this is that the loose coupler can be set for a particular wave length, while the tuning coil, because of its construction, may respond to several waves at once.

## Vacuum Tube Set Can Easily Be Made by Any Amateur

The regenerative or feed-back receiver presents many points of superiority over the crystal type of receiver. It is more selective, more sensitive and provides for considerable amplification of signals through the phenomenon of regeneration.

Although it requires greater skill on the part of the builder to construct, and is more complex in operation than the crystal receiver, the results obtainable warrant the extra trouble and expenditure of money.

Because of the fact that there are broadcasting stations on long as well as short waves, a receiver which will respond to a range of wave lengths between 200 and 1,600 meters proves interesting as well

as useful. There is a certain pleasure in being able to shift from one wave length to another and intercept signals from various stations at will.

Instead of standing idly by during the intermissions of the 360 meter broadcast, the operator can tune in another broadcasting station and listen to its concert. A greater variety of concerts is available at the touch of the tuning knobs. One is no longer compelled to stay on the 360 meter wave.

### How It Is Made

This receiver is easy to construct and operate. Besides the necessary tube controls, there are but three others: the antenna series condenser, the tickler coupling and the inductance switch. The circuit is the familiar plate feed-back circuit, used extensively by the navy.

It is more efficient, and certainly more flexible than the variometer type of regenerative receiver. It is simpler in operation and construction.

The antenna tuning inductance is wound on a cardboard, fiber or bakelite tube  $3\frac{1}{2}$  inches in diameter and 8 inches long. Only 6 inches of the tube is wound with one even layer of No. 22 single cotton-covered wire.

The winding is tapped as follows: At the 20th, 30th, 40th, 60th, 85th, 120th, 160th and 204th turns. The first 60 turns will provide ample tuning facilities for waves up to 600 meters. The winding is given a coat of thin shellac to keep it in place.

The two inches of the tube left unwound will be used for the tickler coupling winding. This winding is a continuation of the main inductance, and consists of 40 turns of No. 22 S. C. C. wire, wound in two

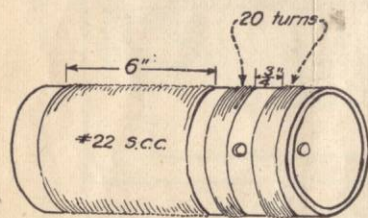

MAIN INDUCTANCE

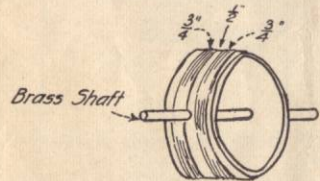

TICKLER COIL

sections of 20 turns each, with a separation of three-quarters of an inch between sections. This space will serve for the tickler shaft bearing.

The tickler consists of a tube  $2\frac{3}{4}$  inches in diameter and  $1\frac{1}{2}$  inches long. It is fitted with a brass rod, which serves as a shaft for it to rotate on when placed inside the main inductance coil.

The winding consists of two sections, with a separation of the sections being about three-quarters of an inch wide. This tickler winding is coupled to the winding just described, and serves to "feed-back" the energy from the plate circuit into the grid circuit.

The next piece of apparatus required is a variable condenser, which may be of standard make, and with a capacity of .001 mfd. It is placed in the antenna circuit and is valuable for fine tuning not possible with the inductance taps alone.

The whole tuning outfit may be neatly mounted on a bakelite or hard rubber panel 12x5 inches. The antenna condenser control may be located on the left, with the tickler control placed on the right of the panel. Between these two controls may be placed the antenna inductance tuning switch. A well-balanced panel will result.

The only other apparatus needed for the operation of the receiver is the usual tube equipment.

The vacuum tube base may be of any standard make. It will be found cheaper to buy this equipment than to make it. The four springs which make contact with the prongs of the tube are marked "G," for Grid; "P," for Plate; "F" or "Fil"—for the negative connection of the filament, and "F+" for the positive connection. The connections to those terminals are made as shown in the diagram.

The grid condenser has a capacity of .00025 Mfd., and the grid leak value is approximately 1 megohm, this value varying with the characteristics of the tube. A block 22-volt battery will supply the

plate voltage, and a 6-volt battery, preferably a 6 volt 40-to-60-ampere-hour storage battery, will provide the current for the filament of the vacuum tube.

A rheostat of about  $1\frac{1}{2}$  amperes capacity will serve to regulate the filament current to the correct operating value.

The set is carefully connected, as shown in the diagram of connections. Every joint should be soldered if possible, for leaky and microphonic contacts will interfere considerably with the efficient operation of the circuit. The vacuum tube is lighted by turning the rheostat slowly.

If the set has been properly wired, and if the tickler coupling is at maximum, a beating note will be heard in the telephone receivers. The set is then said to be "oscillating." If any difficulty is experienced in making the set oscillate, the tickler connections should be reversed. The beating note will then be heard.

Just how the regenerative effect is obtained will be seen from the following: The very small impulse intercepted by the antenna when applied to the grid of the detector tube releases a greater amount of energy in the plate circuit. That is, the tube acts as a relay or valve, which releases a certain amount of energy from the local "B" battery, and this energy actuates the telephone receivers.

Now, if part of this energy is fed back into the grid circuit again, it follows that the energy operating the valve will be increased that

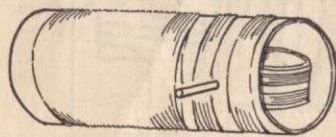

INDUCTANCE ASSEMBLY

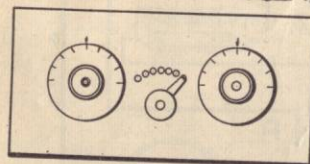

PANEL LAYOUT

much and that a greater amount of energy will be allowed to flow into the telephone receivers.

This regenerative process cannot be repeated indefinitely, for there are losses which must be compensated. These losses in the grid circuit are made up by the plate circuit and are supplied through the "tickler coil." This effect of feeding back the energy results in amplified signals. Amplification of about 100 times may be secured with a well-built regenerative receiver.

A little practice will enable the operator to tune in the signals on this regenerative set. First set the tickler coil about half way on the scale. Then vary the induction switch and the variable condenser until the loudest response is obtained in the receivers. A readjustment of the tickler coil at this time will bring the signals very clearly.

A point will be reached where the signals will become "mushy." The best point is just before this effect is noticeable. Signals which cannot be heard with the plain tuner will be audible as soon as the tickler coil is adjusted to the correct position.

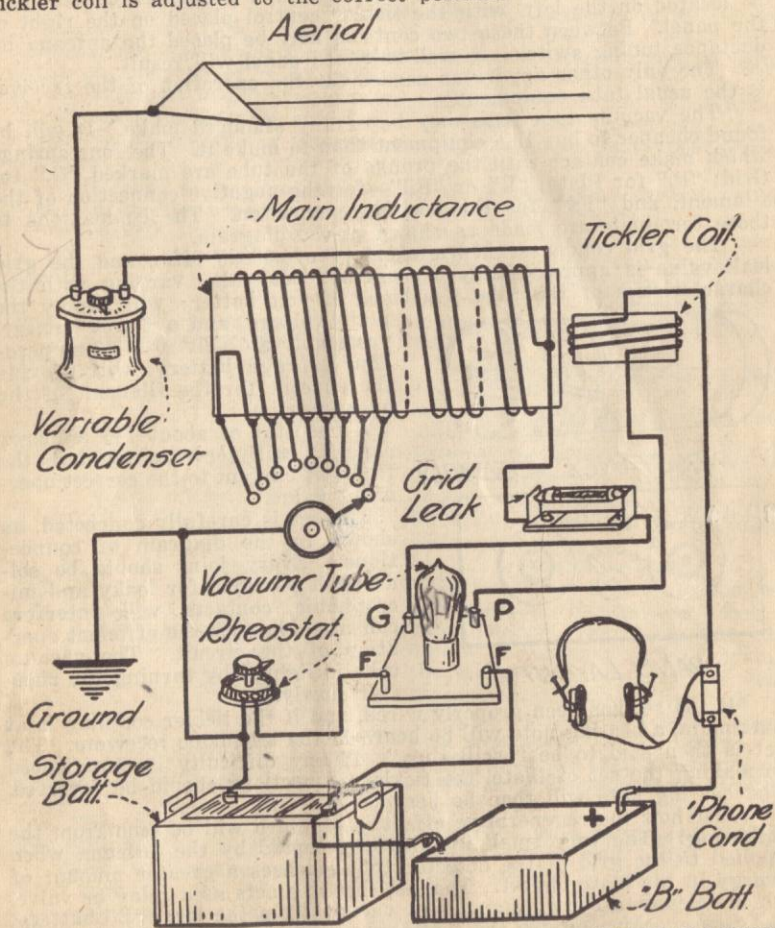

DIAGRAM OF CONNECTIONS FOR REGENERATIVE VACUUM TUBE SET

## How and Why of Vacuum Tubes

It has been said that the vacuum tube is to radio what the lever is to mechanics. This is a rather sweeping statement, but for the present, at least, it is quite true.

Those who start studying radio do not get far before they bump into the vacuum tube. It is an innocent looking little thing, quite simple in appearance, too. But simplicity in appearance and simplicity in operation do not always travel hand in hand.

The vacuum tube is a puzzle simply because we cannot see what is happening inside the thing. When a tube is in operation we see nothing but a hot filament. There is no noise and nothing moves—that is, nothing that we can see moves. Yet the proverbial beehive is slow when compared to the things that happen in a vacuum tube.

Before we can hope to understand the operation of the vacuum tube, we must digest a few fundamental electrical facts. Back in the physics class at high school we learned something about the terms positive and negative. We were told that electrical current always flowed from the positive to the negative pole of a battery, just as water always flows from a higher to a lower level. We might think of negative as being the lower level.

If our memory is healthy, we probably remember something about positive and negative charges. If two bodies had a negative charge on their surface, they would repel each other when they were brought together. If one had a negative and the other a positive charge, they would attract each other when they were brought together. From this we deduce the following:

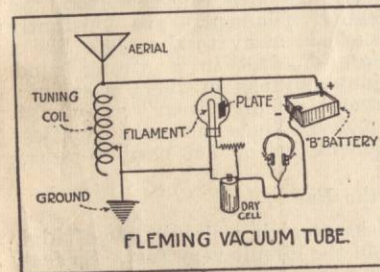

How the Fleming vacuum tube was connected in a simple receiving circuit.

Like charges of electricity repel each other and unlike charges attract each other. We are now ready to dive into the subject of vacuum tube operation.

### Scientists Wiser Now

When Edison was quite a young man, he found that the space about a heated wire was a one-way conductor of electricity. Under ordinary conditions such a space would not conduct a current. Try as he would, Edison could not make current travel in both directions

across the space. But what has this to do with vacuum tubes? Scientists are wiser now than they were in Edison's day. They can account for this one-way conductivity across a heated space about a filament or wire. If our eyes were powerful enough, we would see tiny particles being shot off the heated wire at a prodigious speed. These ultramicroscopic cannon balls are called electrons. The electron is the smallest thing in the world. Atoms and molecules are giants in comparison. Many of us will be surprised to learn that the electron is pure electricity. Scientists say that it is a "unit of negative electricity."

